

PERIODIC HARMONIC FUNCTIONS ON LATTICES AND POINTS COUNT IN POSITIVE CHARACTERISTIC

MIKHAIL ZAIDENBERG

ABSTRACT. This survey addresses pluri-periodic harmonic functions on lattices with values in a positive characteristic field. We mention, as a motivation, the game “Lights Out” following the work of Sutner [Su], Goldwasser-Klostermeyer-Ware [GKW], Barua-Ramakrishnan-Sarkar [BR, SB], Hunzikel-Machiavello-Park [HMP] e.a.; see also [Za₁, Za₂] for a more detailed account. Our approach explores harmonic analysis and algebraic geometry over a positive characteristic field. The Fourier transform allows us to interpret pluri-periods of harmonic functions on lattices as torsion multi-orders of points on the corresponding affine algebraic variety.

1. INTRODUCTION

We consider the Cayley graph Γ of a free abelian group (i.e., a lattice) and harmonic functions on Γ with values in a field K of positive characteristic. We are interested in determining all pluri-periods of such functions. In the characteristic 2 case, this question arises naturally in relation with the game “Lights Out” on a rectangular or a toric board, or otherwise in studies on the dynamics of linear cellular automata on a lattice Λ . We present two possible reductions of this problem. The first one, developed by Sutner [Su], Goldwasser-Klostermeyer-Ware [GKW], Barua-Ramakrishnan-Sarkar [BR, SB], Hunzikel-Machiavello-Park [HMP] e.a. deals with the Chebyshev-Dickson polynomials and their generalizations. The second one leads to points count on a certain affine algebraic variety Σ over the algebraic closure of K . The points on Σ correspond to harmonic characters on Λ . We express the pluri-periods of harmonic functions on Λ , or, which is the same, the sizes of the toric boards obstructed for the “Lights Out” game, as torsion multi-orders of the corresponding points on Σ .

It is our pleasure to thank Don Zagier for useful suggestions.

1991 Mathematics Subject Classification: 11B39, 11T06, 11T99, 31C05, 37B15, 43A99.

Key words: cellular automaton, Chebyshev-Dickson polynomial, convolution operator, lattice, finite field, discrete Fourier transform, discrete harmonic function, pluri-periodic function.

Acknowledgements: This survey is based on 2 author’s preprints at the Max-Planck-Institute of Mathematics (Bonn), and on a talk on the meeting “Analysis on Graphs and Fractals”, the Cardiff University, 29 May-2 June 2007 (a satellite meeting of the programme “Analysis on Graphs and its Applications” at the Isaac Newton Institute from 8 January to 29 June 2007). The author thanks all these institutions for a generous support.

1.1. **The game “Lights Out”.** The “Lights Out” is a solitary game on a rectangular $m \times n$ board. Initially the board is filled in with 0’s (“black”) and 1’s (“white”). The rule of the game consists in the following: *A click in a cell changes the state to the opposite in this cell and in all its horizontal and vertical neighbors.* The goal of the game is: *to reach finally the “all white” pattern.*

As an example, let us consider a 3×3 board. Starting with an initial pattern as shown below and performing a sequence of clicks in the cells indicated over arrows, we obtain:

$$\begin{array}{ccccc}
 \begin{pmatrix} 0 & 0 & 0 \\ 1 & 1 & 0 \\ 0 & 0 & 1 \end{pmatrix} & \xrightarrow{\sim\sim\sim}^{(1,3)} & \begin{pmatrix} 0 & 1 & 1 \\ 1 & 1 & 1 \\ 0 & 0 & 1 \end{pmatrix} & \xrightarrow{\sim\sim\sim}^{(1,2)} & \begin{pmatrix} 1 & 0 & 0 \\ 1 & 0 & 1 \\ 0 & 0 & 1 \end{pmatrix} \\
 & & & & \\
 \xrightarrow{\sim\sim\sim\sim\sim}^{(2,1),(2,3)} & \begin{pmatrix} 0 & 0 & 1 \\ 0 & 0 & 0 \\ 1 & 0 & 0 \end{pmatrix} & \xrightarrow{\sim\sim\sim\sim\sim}^{(1,3),(3,1)} & \begin{pmatrix} 0 & 1 & 0 \\ 1 & 0 & 1 \\ 0 & 1 & 0 \end{pmatrix} & \xrightarrow{\sim\sim\sim}^{(2,2)} & \begin{pmatrix} 0 & 0 & 0 \\ 0 & 1 & 0 \\ 0 & 0 & 0 \end{pmatrix} \\
 & & & & \\
 \xrightarrow{\sim\sim\sim\sim\sim\sim\sim\sim}^{(1,2),(2,1),(2,3),(3,2)} & \begin{pmatrix} 0 & 1 & 0 \\ 1 & 1 & 1 \\ 0 & 1 & 0 \end{pmatrix} & \xrightarrow{\sim\sim\sim}^{(2,2)} & \begin{pmatrix} 0 & 0 & 0 \\ 0 & 0 & 0 \\ 0 & 0 & 0 \end{pmatrix} & . &
 \end{array}$$

To find a shorter way it is enough just to cancel the clicks that are done twice:

$$\begin{pmatrix} 0 & 0 & 0 \\ 1 & 1 & 0 \\ 0 & 0 & 1 \end{pmatrix} \xrightarrow{\sim\sim\sim}^{(3,2)} \begin{pmatrix} 0 & 0 & 0 \\ 1 & 0 & 0 \\ 1 & 1 & 0 \end{pmatrix} \xrightarrow{\sim\sim\sim}^{(3,1)} \begin{pmatrix} 0 & 0 & 0 \\ 0 & 0 & 0 \\ 0 & 0 & 0 \end{pmatrix} .$$

Indeed, the clicks represent commuting involutions.

Observation 1.1. More generally, one can play the “Lights Out” game on any finite graph Γ . Sutner’s Garden-of-Eden Theorem [Su] says that *starting with the “all black” pattern on Γ one can always reach the “all white” pattern.* That is, the “all black” pattern is winning for any graph Γ .

A general question is: *For which graphs Γ one can win the “Lights Out” game on Γ starting with an arbitrary initial pattern?* In the latter case we say that Γ is winning. This turns out to be equivalent to a spectral problem for the corresponding Laplacian Δ_Γ on Γ . Indeed, the nonzero harmonic functions on Γ provide obstructions for the “Lights Out” game on Γ to always win.

Definition 1.2. Let Γ be a graph and K be an abelian group. A function h on the set of vertices of Γ with values in K is called harmonic¹ if

$$(\Delta_\Gamma h)(v) := h(v) + \sum_{[v,v'] \in \Gamma} h(v') = 0 \quad \forall v \in \Gamma.$$

Or, in other words, if

$$(1) \quad \langle h, a_v \rangle = 0 \quad \forall v \in \Gamma, \quad \text{where} \quad a_v = \delta_v + \sum_{[v,v'] \in \Gamma} \delta_{v'}.$$

We call a_v the star-function centered at v .

Observation 1.3. Given a finite field K and a simple finite graph Γ , one can equally play the game ‘‘Lights Out’’ on Γ with patterns taking values in K ; see e.g. [GMT]. The click in a vertex $v \in \Gamma$ corresponds to the translation $f \mapsto f + a_v$ in the vector space $\mathcal{F}(\Gamma, K)$ of all K -valued functions on Γ . Thus f is winning² if and only if $f \in \text{span}(a_v \mid v \in \Gamma)$.

For any harmonic function h on Γ and for any $f \in \mathcal{F}(\Gamma, K)$, by virtue of (1)

$$\langle h, f \rangle = \langle h, f + a_v \rangle \quad \forall v \in \Gamma.$$

Hence h provides a linear invariant of the game ‘‘Lights Out’’ on Γ , and any such invariant appears in this way. Therefore a pattern $f : \Gamma \rightarrow K$ is winning if and only if $f \perp \text{Harm}(\Gamma, K)$, where $\text{Harm}(\Gamma, K) = \ker(\Delta_\Gamma)$ stands for the space of all K -valued harmonic functions on Γ . So Γ is winning if and only if $\text{Harm}(\Gamma, K) = (0)$.

Problem 1.4. Given a finite field K , determine all winning $m \times n$ boards, or, alternatively, all those which possess a nonzero K -valued harmonic function.

Example 1.5. For $K = \mathbb{F}_2$, the square board 3×3 is winning, whereas the boards 4×4 and 5×5 are not as both of them possess nonzero binary harmonic functions, for instance

$$\begin{pmatrix} 1 & 1 & 1 & 0 \\ 0 & 1 & 0 & 1 \\ 0 & 0 & 1 & 1 \\ 0 & 0 & 0 & 1 \end{pmatrix} \quad \text{resp.,} \quad \begin{pmatrix} 1 & 1 & 0 & 1 & 1 \\ 0 & 0 & 0 & 0 & 0 \\ 1 & 1 & 0 & 1 & 1 \\ 0 & 0 & 0 & 0 & 0 \\ 1 & 1 & 0 & 1 & 1 \end{pmatrix}.$$

¹Alternatively, one can define harmonic functions by the identity

$$h(v) = \sum_{[v,v'] \in \Gamma} h(v') \quad \forall v \in \Gamma.$$

The class of harmonic functions remains the same if K is a field of characteristic 2 and changes in case $\text{Char}(K) = p > 2$. However, similar results hold after this replacement. We give below a general approach covering the both cases.

²That is, starting with f one can reach the ‘‘all white’’ pattern.

Observation 1.6. Problem 1.4 for a rectangular $m \times n$ board is closely related to a similar question for the toric $(m+1) \times (n+1)$ board; see [Za₁]. Considering the game “Lights Out” on toric boards rather than on rectangular ones provides certain advantages. Indeed, the toric $m \times n$ board $\mathbb{T}_{m,n}$ represents the Caley graph of the abelian group $\mathbb{Z}/m\mathbb{Z} \times \mathbb{Z}/n\mathbb{Z}$ for the standard choice of generators. Its maximal abelian cover is the Caley graph of the free abelian group $\Lambda = \mathbb{Z}^2$. Every harmonic function $h \in \text{Harm}(\mathbb{T}_{m,n}, K)$ can be lifted to a bi-periodic harmonic function $\tilde{h} \in \text{Harm}(\Lambda, K)$ with periods me_1 and ne_2 . Thus Problem 1.4 for toric boards is equivalent to the following one.

Problem 1.7. Given a lattice Λ and a field K , determine the pluri-periods of all nonzero pluri-periodic harmonic functions $h : \Lambda \rightarrow K$.

Example 1.8. The game “Lights Out” played over the binary field \mathbb{F}_2 on the toric board $\mathbb{T}_{10,10}$ does not always win. Indeed, $\mathbb{T}_{10,10}$ possesses nonzero binary harmonic functions, for instance, the following one obtained via the doubling of periods trick [Za₁]:

$$h = \begin{pmatrix} 0 & 1 & 1 & 0 & 1 & 0 & 1 & 0 & 1 & 1 \\ 1 & 0 & 0 & 0 & 0 & 0 & 1 & 0 & 0 & 0 \\ 1 & 0 & 1 & 0 & 1 & 1 & 0 & 1 & 1 & 0 \\ 0 & 0 & 1 & 0 & 0 & 0 & 1 & 0 & 0 & 0 \\ 1 & 1 & 0 & 1 & 1 & 0 & 1 & 0 & 1 & 0 \\ 0 & 0 & 1 & 0 & 0 & 0 & 0 & 0 & 1 & 0 \\ 1 & 0 & 1 & 0 & 1 & 0 & 1 & 1 & 0 & 1 \\ 0 & 0 & 0 & 0 & 1 & 0 & 0 & 0 & 1 & 0 \\ 1 & 0 & 1 & 1 & 0 & 1 & 1 & 0 & 1 & 0 \\ 1 & 0 & 0 & 0 & 1 & 0 & 0 & 0 & 0 & 0 \end{pmatrix}$$

This pattern h composed of five crosses

$$\begin{pmatrix} & & 1 & & \\ & & 1 & & \\ 1 & 1 & 0 & 1 & 1 \\ & & 1 & & \\ & & 1 & & \end{pmatrix}$$

lifts to a bi-periodic binary harmonic function \tilde{h} on the lattice $\Lambda = \mathbb{Z}^2$ with periods $10e_1, 10e_2$.

Observation 1.9. The Laplacian Δ_Λ acting on the space $\mathcal{F}(\Lambda, K)$ of all functions $\Lambda \rightarrow K$ provides a linear cellular automaton on Λ [MOW]. Actually any homogeneous linear cellular automaton on Λ appears in this way. Furthermore, Δ_Λ can be expressed as the convolution operator

$$\Delta_\Lambda : f \mapsto f * a_0$$

with kernel the star-function a_0 on Λ centered at the origin. Thus

$$\tilde{h} \in \text{Harm}(\Lambda, K) \iff \tilde{h} * a_0 = 0.$$

The period vectors of a pluri-periodic harmonic function \tilde{h} on Λ form a finite index sublattice

$$\Lambda' = \Lambda'(\tilde{h}) \subseteq \Lambda.$$

The quotient $\mathbb{T} = \Lambda/\Lambda'$ is a finite abelian group, and \tilde{h} is the pull-back of a function $h : \mathbb{T} \rightarrow K$ harmonic with respect to an appropriate Laplacian $\Delta_{\mathbb{T}}$ on \mathbb{T} .

Example 1.10. For a circular graph $\mathbb{T}_n = \text{Caley}(\mathbb{Z}/n\mathbb{Z})$ and for any field K of characteristic $p > 0$, one has

$$\text{Harm}(\mathbb{T}_n, K) \neq (0) \iff n \equiv 0 \pmod{3}.$$

Indeed if $n \equiv 0 \pmod{3}$ then

$$h(k) := k(\bmod 3) \in K, \quad k \in \mathbb{Z}/n\mathbb{Z},$$

is a nonzero K -valued harmonic function on \mathbb{T}_n . Conversely, we can write

$$\Delta_{\mathbb{T}_n} = 1 + \tau + \tau^{-1},$$

where

$$\tau : f(x) \mapsto f(x+1 \pmod{n})$$

is the right shift acting on $\mathcal{F}(\mathbb{T}_n, K)$. Hence by virtue of the Spectral Mapping Theorem,

$$\begin{aligned} 0 \in \text{spec}(\Delta_{\mathbb{T}_n}) &\iff \\ \exists \zeta \in \bar{K} : \zeta^n = 1, \quad 1 + \zeta + \zeta^{-1} = 0 \\ \iff \exists \zeta \in \bar{K} : \zeta \neq 1, \quad \zeta^n = 1, \quad \zeta^3 = 1 \\ &\iff n \equiv 0 \pmod{3}, \end{aligned}$$

where \bar{K} stands for the algebraic closure of K .

1.2. “Lights Out” played on circular graphs. For any finite simple graph Γ , the matrix of the “Markov operator” $\Delta_{\Gamma} - 1$ in the canonical base of δ -functions ($\delta_v : v \in \Gamma$) in the lattice $\mathcal{F}(\Gamma, \mathbb{Z})$ is just the adjacency matrix of Γ . For a circular graph \mathbb{T}_n with $n \geq 3$ vertices and for a linear path \mathbb{P}_n with $n \geq 1$ vertices we have, respectively,

$$\text{adj}(\mathbb{T}_n) = \begin{pmatrix} 0 & 1 & 0 & \dots & 0 & 0 & 1 \\ 1 & 0 & 1 & \dots & 0 & 0 & 0 \\ 0 & 1 & 0 & \ddots & 0 & 0 & 0 \\ \vdots & \vdots & \ddots & \ddots & \ddots & \vdots & \vdots \\ 0 & 0 & 0 & \ddots & 0 & 1 & 0 \\ 0 & 0 & 0 & \dots & 1 & 0 & 1 \\ 1 & 0 & 0 & \dots & 0 & 1 & 0 \end{pmatrix}, \quad \text{adj}(\mathbb{P}_n) = \begin{pmatrix} 0 & 1 & 0 & \dots & 0 & 0 & 0 \\ 1 & 0 & 1 & \dots & 0 & 0 & 0 \\ 0 & 1 & 0 & \ddots & 0 & 0 & 0 \\ \vdots & \vdots & \ddots & \ddots & \ddots & \vdots & \vdots \\ 0 & 0 & 0 & \ddots & 0 & 1 & 0 \\ 0 & 0 & 0 & \dots & 1 & 0 & 1 \\ 0 & 0 & 0 & \dots & 0 & 1 & 0 \end{pmatrix}.$$

We let

$$C_n(x) := (-1)^n \det(\operatorname{adj}(\mathbb{T}_n) - xI_n)$$

denote the characteristic polynomial of $\operatorname{adj}(\mathbb{T}_n)$. Then $C_n = (x-2)D_n \in \mathbb{Z}[x]$, where

$$D_3 = (x+1)^2, \quad D_4 = x^2(x+2) \quad \text{and} \quad D_n = xD_{n-1} - D_{n-2} + 2 \quad \forall n \geq 5.$$

In particular $3 \in \operatorname{spec}(\Delta_{\mathbb{T}_n}) \forall n \geq 3$, and the corresponding eigenfunctions are constant functions on \mathbb{T}_n . Furthermore,

$$C_3(-1) = 0, \quad C_4(-1) = C_5(-1) = -3 \quad \text{and} \quad C_{n+3}(-1) = C_n(-1) \quad \forall n \geq 3.$$

Hence over \mathbb{C} , for $n \geq 3$ one has:

$$0 \in \operatorname{spec}(\Delta_{\mathbb{T}_n}) \iff C_n(-1) = 0 \iff n \equiv 0 \pmod{3}.$$

Consequently, the ‘‘Lights Out’’ game on the circular graph \mathbb{T}_n ($n \geq 3$) is winning over a field K of characteristic $p \neq 3$ if and only if $n \not\equiv 0 \pmod{3}$. While for $p = 3$ none of the graphs \mathbb{T}_n ($n \geq 3$) is winning. Every non-winning graph \mathbb{T}_n carries a nonzero K -valued harmonic function. For $p = 3$ these are constant functions. For $p \neq 3$ and $n = 3k$ the space $\operatorname{Harm}(\mathbb{T}_n, K)$ consists of 3-periodic functions and is spanned by the function h from Example 1.10 above and its shifts.

1.3. How can one recognize winning boards? In Theorem 1.11 below we mention two different approaches to Problem 1.4 for the ‘‘Lights Out’’ game on toric boards. None of them is explicit. The first one applies over the Galois field \mathbb{F}_p , while the second one deals with its algebraic closure $\bar{\mathbb{F}}_p$. See e.g., [Su, GKW, HMP] for the proof of (a) and [Za₁] for (b).

Theorem 1.11. (a) *For a toric graph $\mathbb{T}_{m,n} = \operatorname{Caley}(\mathbb{Z}/m\mathbb{Z} \times \mathbb{Z}/n\mathbb{Z})$ one has*

$$\operatorname{Harm}(\mathbb{T}_{m,n}, \mathbb{F}_p) = (0) \iff \gcd(C_m^{(p)}(x), C_n^{(p)}(1-x)) = 1.$$

(b) *For a toric graph $\mathbb{T}_{\bar{n}} = \operatorname{Caley}(\mathbb{Z}/n_1\mathbb{Z} \times \dots \times \mathbb{Z}/n_s\mathbb{Z})$, where $\bar{n} = (n_1, \dots, n_s)$, one has*

$$\operatorname{Harm}(\mathbb{T}_{\bar{n}}, \mathbb{F}_p) \neq (0) \iff \exists (\zeta_1, \dots, \zeta_s) \in (\bar{\mathbb{F}}_p^\times)^s :$$

$$(*) \quad 1 + \sum_{i=1}^s (\zeta_i + \zeta_i^{-1}) = 0, \quad \zeta_i^{n_i} = 1, \quad i = 1, \dots, s.$$

1.4. Generalized Chebyshev-Dickson polynomials. Consider further a lattice Λ , a field K of characteristic $p > 0$, an arbitrary function $a : \Lambda \rightarrow K$ with finite support, and the corresponding Laplacian

$$\Delta_a : f \rightarrow f * a.$$

Let $f : \Lambda \rightarrow K$ be a pluri-periodic function with the lattice of periods $\Lambda' \subseteq \Lambda$. Then clearly the period lattice of the function $\Delta_a(f)$ contains Λ' . So the subspace $\mathcal{F}(\Lambda, K)^{\Lambda'}$ of all Λ' -periodic functions on Λ is Δ_a -invariant, of dimension

$$\dim \mathcal{F}(\Lambda, K)^{\Lambda'} = \operatorname{ind}(\Lambda', \Lambda).$$

Definition 1.12. We call a *generalized Chebyshev-Dickson polynomial* $T_{a,\Lambda'}$ the characteristic polynomial of the restriction $\Delta_a|_{\mathcal{F}(\Lambda, K)^{\Lambda'}}$. It has degree

$$\deg(T_{a,\Lambda'}) = \text{ind}(\Lambda', \Lambda).$$

The classical Chebyshev-Dickson polynomials T_n ³ correspond to

$$p = 2, \quad \Lambda = \mathbb{Z}, \quad \Lambda' = n\mathbb{Z}, \quad \text{and} \quad a = a_0 = \delta_0 + \delta_1 + \delta_{-1}.$$

Given a base $\mathcal{V} = (v_1, \dots, v_s)$ of the lattice Λ and a product sublattice $\Lambda' \subseteq \Lambda$, where

$$\Lambda' = \sum_{i=1}^s n_i \mathbb{Z} v_i,$$

the Chebyshev-Dickson polynomial $T_{a,\Lambda'}$ can be expressed via iterated resultants [Za₂].

Like in the classical case, the system of generalized Chebyshev-Dickson polynomials possesses the following divisibility properties [Za₂].

Theorem 1.13. (a) $\Lambda' \subseteq \Lambda'' \implies T_{a,\Lambda''} | T_{a,\Lambda'}$.
 (b) $\text{ind}(\Lambda', \Lambda'') = p^\alpha \implies T_{a,\Lambda'} = (T_{a,\Lambda''})^{p^\alpha}$.

1.5. The partnership graph. In this subsection we return to the special case related to the game “Lights Out”, where $K = \mathbb{F}_2$, $\Lambda = \mathbb{Z}^2$, and $a = a_0$ is the star function on Λ . The covering $\mathbb{T}_{km,ln} \rightarrow \mathbb{T}_{m,n}$ yields an inclusion

$$\text{Harm}(\mathbb{T}_{m,n}) \hookrightarrow \text{Harm}(\mathbb{T}_{km,ln}).$$

Thus one can stick in Problem 1.7 to “primitive” non-winning $m \times n$ toric boards.

Definition 1.14. A pair $(m, n) \in \mathbb{N}^2$ is called a pair of partners if there exists a solution (ζ_1, ζ_2) of (*) with exact torsion orders

$$m = \text{ord}(\zeta_1) \quad \text{and} \quad n = \text{ord}(\zeta_2).$$

Since $\text{Char}(K) = 2$, m and n are odd integers.

Following a suggestion by Don Zagier, we can represent the above partnership relation on a “partnership graph”. This graph \mathcal{P} has the set \mathbb{N}_{odd} of all positive odd integers as the set of vertices and the pairs of partners for the edges. We label \mathcal{P} by attributing to an edge $[m, n]$ the number of solutions of (*) divided by 2. Given a vertex $n \in \mathbb{N}_{\text{odd}}$, the sum of labels over all its incident edges⁴ equals $\varphi(n)$, where φ stands for the Euler totient function. Indeed, given a primitive m th root of unity ζ_1 , the equation (*) with $s = 2$ admits exactly 2 solutions of the form (ζ_1, ζ_2) and (ζ_1, ζ_2^{-1}) , which yields the claim. In particular, \mathcal{P} does not possess isolated vertices. The following simple observation is also due to Don Zagier.

Proposition 1.15. *All connected components of the partnership graph \mathcal{P} are finite.*

³See Appendix below.

⁴A loop at a vertex is count as a single incident edge.

Proof. Given $n \in \mathbb{N}_{\text{odd}}$, the order and the suborder of 2 modulo n are, respectively,

$$f(n) = \text{ord}_n 2 = \min\{j : 2^j \equiv 1 \pmod{n}\}$$

and

$$f_0(n) = \text{subord}_n 2 = \min\{j : 2^j \equiv \pm 1 \pmod{n}\}.$$

Thus $f(n)/f_0(n) \in \{1, 2\}$. Furthermore,

$$f(n) = 2f_0(n) \text{ is even} \iff \exists j \in \mathbb{N} : 2^j \equiv -1 \pmod{n}.$$

Letting $q = 2^{f_0(n)}$, n divides exactly one of $q - 1$ and $q + 1$. Namely $n \mid (q - 1)$ if $f_0(n) = f(n)$ and $n \mid (q + 1)$ otherwise.

According to (*) a pair (m, n) of odd naturals is a pair of partners (that is, $[m, n]$ is an edge of \mathcal{P}) if and only if $\xi + \xi^{-1} = 1 + \eta + \eta^{-1}$ for some primitive roots $\xi \in \mu_m$ and $\eta \in \mu_n$ (cf. also Example 1.16 below). Thus for a pair of partners (m, n) ,

$$f_0(m) = \deg(\xi + \xi^{-1}) = \deg(\eta + \eta^{-1}) = f_0(n).$$

Hence the suborder function f_0 is constant on each connected component of \mathcal{P} .

We let $\mathcal{V}_r = f_0^{-1}(r)$, $r = 1, 2, \dots$, denote the level sets of f_0 . By definition of f_0 , a level set \mathcal{V}_r is contained in the set of all divisors of $2^{2^r} - 1$. Therefore it is finite.

Given $n \in \mathbb{N}_{\text{odd}}$, we let $\mathcal{P}(n)$ denote the connected component of \mathcal{P} which contains the vertex n . Since the set of vertices of $\mathcal{P}(n)$ is contained in the finite set \mathcal{V}_r , where $r = f_0(n)$, the former set is finite as well, as stated. \square

The first 12 level sets $V_r = f_0^{-1}(r)$, $r = 1, \dots, 12$, and the corresponding subgraphs of the labelled partnership graph \mathcal{P} are shown on Figures 1-3 below; they were computed by Don Zagier with PARI. A vertex n on these figures is underlined iff $f_0(n) \neq f(n)$. These computations suggest that among the V_r 's, only V_5 is disconnected.

1.6. Symbolic variety. From now on we let K be an algebraically closed field of characteristic $p > 0$. Given a base $\mathcal{V} = (v_1, \dots, v_s)$ of a lattice Λ , one can identify Λ with \mathbb{Z}^s , where $s = \text{rk}(\Lambda)$. For a function $a : \Lambda \rightarrow K$ with finite support, the symbol of the corresponding Laplacian Δ_a is the Laurent polynomial

$$\sigma_a = \sum_{u=(u_1, \dots, u_s) \in \mathbb{Z}^s} a(u)x^{-u} \in K[x_1, x_1^{-1}, \dots, x_s, x_s^{-1}]$$

with the coefficient function a . The symbolic variety associated with Δ_a is

$$\Sigma_a = \sigma_a^{-1}(0).$$

More generally, to a sequence $\bar{a} = (a_1, \dots, a_t)$ ⁵ we associate its symbolic variety

$$\Sigma_{\bar{a}} = \{\sigma_{a_j} = 0 : j = 1, \dots, t\},$$

which is a closed subvariety of the affine algebraic torus $(K^\times)^s$.

⁵In other words, to the system of corresponding Laplacians $\Delta_{a_1}, \dots, \Delta_{a_t}$.

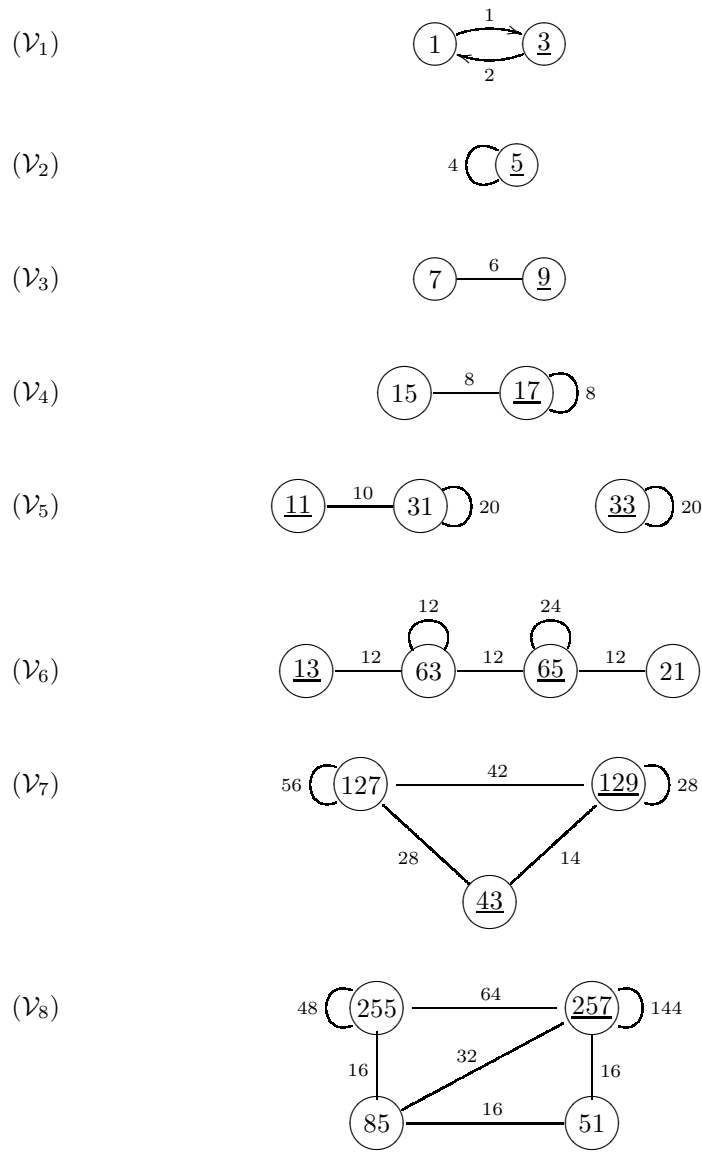


FIGURE 1.

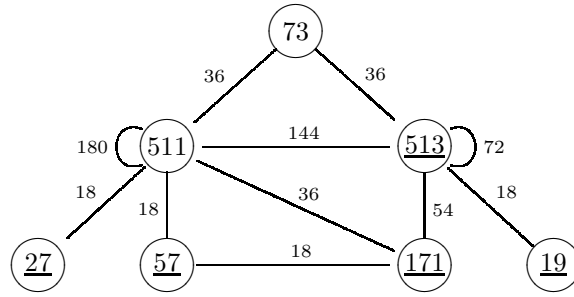
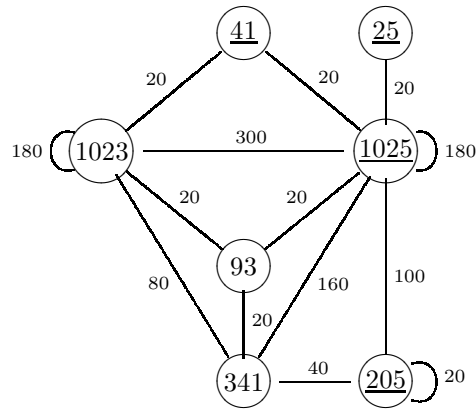
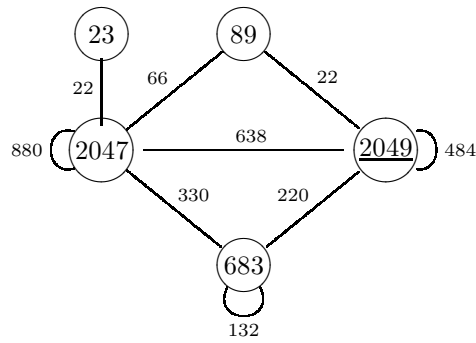
(\mathcal{V}_9)  (\mathcal{V}_{10})  (\mathcal{V}_{11}) 

FIGURE 2.

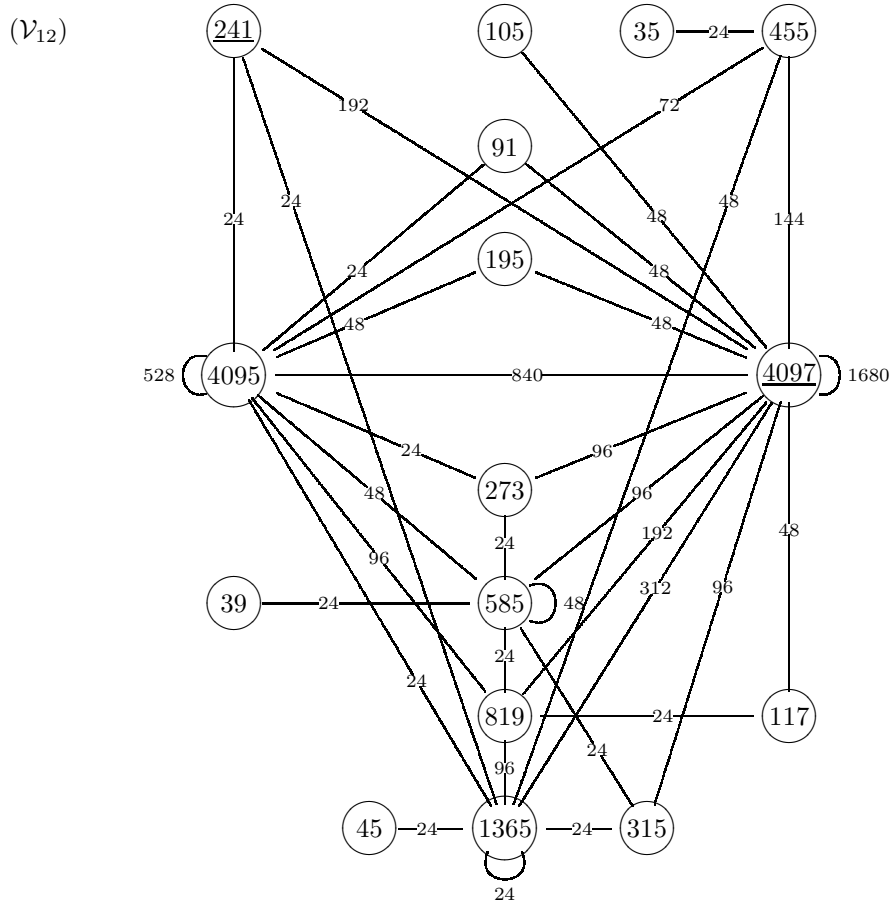


FIGURE 3.

Example 1.16. Consider again $K = \bar{\mathbb{F}}_2$ and the Laplacian Δ_{a_0} on the plane lattice $\Lambda = \mathbb{Z}^2$ with kernel the star function a_0 . The corresponding symbolic variety is the elliptic cubic curve

$$\Sigma_{a_0} = \{x + 1/x + y + 1/y = 1\} \subseteq (K^\times)^2.$$

The logarithm of the Hasse-Weil zeta-function counts points on Σ_{a_0} according to the filtration $\bar{F}_2 = \bigcup_{n \in \mathbb{N}} \mathbb{F}_{2^n}$. This formula suggests that the number of toric $m \times n$ boards which admit a nonzero binary harmonic function is infinite. Moreover, the number of primitive boards (i.e., those which are not produced using smaller ones) is also infinite. Indeed, the number of edges of the partnership graph \mathcal{P} is infinite, because the number of vertices is and \mathcal{P} has no isolated vertex.

We consider the algebraic closure $K = \bar{\mathbb{F}}_p$ of a Galois field \mathbb{F}_p . For $n \in \mathbb{N}$ coprime with $p = \text{Char}(K)$ we let $\mu_n \subseteq K^\times$ denote the subgroup of n th roots of unity. For a

multi-index $\bar{n} \in \mathbb{N}^s$, where $n_i \not\equiv 0 \pmod{p} \forall i$, we consider the finite s -torus

$$\mu_{\bar{n}} = \mu_{n_1} \times \dots \times \mu_{n_s} \subseteq (K^\times)^s.$$

The multiplicative group K^\times being a torsion group, the torus $(K^\times)^s$ is filtered by its finite subgroups:

$$(K^\times)^s = \bigcup_{\bar{n}} \mu_{\bar{n}}.$$

Furthermore,

$$(K^\times)^s = \prod_{\bar{n}} \nu_{\bar{n}},$$

where $\nu_{\bar{n}} \subseteq \mu_{\bar{n}}$ denotes the set of all elements of $\mu_{\bar{n}}$ whose i th coordinates are primitive n_i th roots of unity, $i = 1, \dots, s$. Given an algebraic subvariety $\Sigma \subseteq (K^\times)^s$ we wonder whether the multi-sequence $\text{card}(\Sigma \cap \nu_{\bar{n}})$ admits a recursive generating function.

1.7. Harmonic characters. We let $\text{Char}(\Lambda, K^\times)$ denote the set of all characters $\chi : \Lambda \rightarrow K^\times$. Given a base $\mathcal{V} = (v_1, \dots, v_s)$ of Λ we consider the associated isomorphism

$$(2) \quad j : \text{Char}(\Lambda, K^\times) \xrightarrow{\cong} (K^\times)^s, \quad \chi \mapsto (\chi(v_1), \dots, \chi(v_s)).$$

For $K = \bar{F}_p$ every K^\times -valued character of Λ is pluri-periodic. Given a sublattice $\Lambda' \subseteq \Lambda$ of finite index, all Λ' -periodic K^\times -valued characters can be produced by pulling back the K^\times -valued characters of the quotient group $\mathbb{T} = \Lambda/\Lambda'$.

A character χ is called a -harmonic if $\Delta_a(\chi) = 0$. The set of all a -harmonic characters of Λ is denoted by $\text{Char}_{a\text{-harm}}(\Lambda, K^\times)$. The next proposition follows immediately by using the Fourier transform on a finite abelian group; see [Za₂].

Proposition 1.17. *For any product sublattice $\Lambda' = \sum_{i=1}^s n_i \mathbb{Z}v_i \subseteq \Lambda$ of index*

$$\text{ind}(\Lambda', \Lambda) \not\equiv 0 \pmod{p},$$

the space $\text{Harm}_a(\mathbb{T}_{\bar{n}}, K)$ of all a -harmonic functions on the quotient group $\mathbb{T}_{\bar{n}} = \Lambda/\Lambda'$ possesses an orthonormal basis of a -harmonic characters. In particular

$$\text{Harm}_a(\mathbb{T}_{\bar{n}}, K) = \text{span} \left(\text{Char}_{a\text{-harm}}(\mathbb{T}_{\bar{n}}, K^\times) \right)$$

and so

$$\text{Harm}_a(\mathbb{T}_{\bar{n}}, K) \neq (0) \iff \text{Char}_{a\text{-harm}}(\mathbb{T}_{\bar{n}}, K^\times) \neq \emptyset.$$

Remark 1.18. The latter conclusion remains valid for any (not necessarily algebraically closed) field K of positive characteristic. Indeed, the space $\text{Harm}_a(\mathbb{T}_{\bar{n}}, K)$ is spanned by the traces of harmonic characters; see [Za₂].

There is a natural bijection between the a -harmonic characters $\text{Char}_{a\text{-harm}}(\mathbb{T}_{\bar{n}}, K^\times)$ and the points on the corresponding symbolic variety Σ_a with torsion multi-order dividing \bar{n} . More precisely, the following hold [Za₂].

Theorem 1.19. *Consider a product sublattice*

$$\Lambda' = \sum_{i=1}^s n_i \mathbb{Z} v_i \subseteq \Lambda$$

of index coprime to p . Then for $K = \overline{\mathbb{F}}_p$ the isomorphism j as in (2) yields bijections

$$j : \text{Char}_{a\text{-harm}}(\Lambda, K^\times) \xrightarrow{\cong} \Sigma_a \subseteq (K^\times)^s$$

and

$$j : \text{Char}_{a\text{-harm}}(\mathbb{T}_{\bar{n}}, K^\times) \xrightarrow{\cong} \Sigma_a \cap \mu_{\bar{n}},$$

where $\mathbb{T}_{\bar{n}} := \Lambda/\Lambda'$.

Corollary 1.20.

$$\begin{aligned} \dim \text{Harm}_a(\mathbb{T}_{\bar{n}}, K) &= \text{card}(\text{Char}_{a\text{-harm}}(\mathbb{T}_{\bar{n}}, K^\times)) \\ &= \text{card}(\Sigma_a \cap \mu_{\bar{n}}) = \text{mult}_{\lambda=0}(T_{a, \Lambda'}). \end{aligned}$$

Observation 1.21. Reversing the logic we let Σ be an arbitrary affine algebraic subvariety in the torus $(K^\times)^s$. Thus Σ can be defined by a finite sequence (p_j) of Laurent polynomials. When does Σ possess a point with a given torsion multi-order?

To answer this question, we pass to the associated system of Laplacians Δ_{a_j} , $j = 1, \dots, t$, where $a_j : \mathbb{Z}^s \rightarrow K$ is the coefficient function of the polynomial p_j . It is easily seen that the orthogonal projection

$$\pi : \mathcal{F}(\Lambda, K)^{\Lambda'} \rightarrow \ker(\Delta_{\bar{a}})$$

is given by

$$\pi = \prod_j (1 - \Delta_{a_j}^q)$$

for a suitable $q = p^\alpha$.

If $t = 1$ i.e., $\Sigma = \Sigma_a \subseteq (K^\times)^s$ is a hypersurface, we can indicate a dynamical way to determine whether $\Sigma_a \cap \mu_{\bar{n}} \neq \emptyset$. Namely the latter holds if and only if the following sequence of functions on the quotient group $\mathbb{T}_{\bar{n}} = \Lambda/\Lambda'$ is not periodic:

$$f_0 = \delta_0, \quad f_k = \Delta_a^k(\delta_0), \quad k \in \mathbb{N}.$$

Indeed, in the latter case $f_{k+l} = f_k$ for certain minimal k, l with $k > 0, l > 0$, and so $h = f_{k+l-1} - f_{k-1}$ is a nonzero harmonic function on $\mathbb{T}_{\bar{n}}$.

1.8. Winning boards and Artin's conjecture on primitive roots. The following results were elaborated in Hunziker-Machiavelo-Park [HMP]. We formulate them in terms of existence of a nonzero harmonic function on a toric square board with values in a Galois field \mathbb{F}_p as p varies.

Theorem 1.22. ([HMP]) *For an $n \times n$ torus $\mathbb{T}_{n,n}$ the following hold.*

(a)

$$\forall n \geq 3 \exists p : \text{Harm}(\mathbb{T}_{n,n}, \mathbb{F}_p) \neq (0).$$

(b)

$$\text{Harm}(\mathbb{T}_{n,n}, \mathbb{F}_p) \neq (0) \quad \forall p \iff n \equiv 0 \pmod{3} \quad \text{or} \quad n \equiv 0 \pmod{5}.$$

(c) *Except for at most 2 values of the prime p , the set of all primes l such that*

$$\text{Harm}(\mathbb{T}_{l,l}, \mathbb{F}_p) = (0)$$

is infinite.

(d) *If $n = \frac{p \pm 1}{2}$ and $p \geq 23$ then $\text{Harm}(\mathbb{T}_{n,n}, \mathbb{F}_p) \neq (0)$.*

(e) *We let P_p denote the set of all $n \in \mathbb{N}$ such that $\text{Harm}(\mathbb{T}_{n,n}, \mathbb{F}_p) \neq (0)$ while for any proper divisor d of n , $\text{Harm}(\mathbb{T}_{d,d}, \mathbb{F}_p) = (0)$. Then P_2 and P_3 are infinite.*

The proof of (c) is based on a result of Heath-Brown [HB], which concerns the following conjecture.

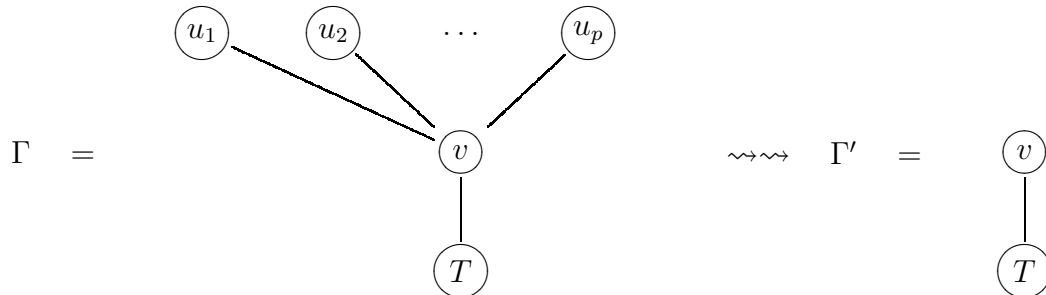
Artin's conjecture on primitive roots (1927; see [Mo, Mu]): *Every integer $n \neq -1$ which is not a square is a primitive root modulo l for an infinite number of primes l .*

Due to [HB] this conjecture holds indeed for all primes $n = p$ with at most 2 exceptions, and for all square-free integers n with at most 3 exceptions (see also [Mo, §5]). For instance, at least one among the primes 2, 3, 5 must satisfy Artin's condition. However, no specific prime p is known to possess the Artin property.

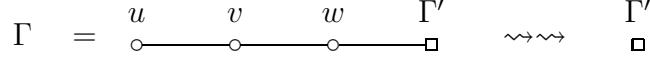
2. HARMONIC FUNCTIONS ON TREES

We fix a field K of characteristic $p > 0$ and a finite graph Γ . According to Amin-Slater-Zhang [ASZ] and Gravier-Mhalla-Tannier [GMT], one simplifies Γ by applying the following two surgeries:

- suppressing p extremal vertices u_1, \dots, u_p joint with a common neighbor v together with the edges $[u_i, v]$ ($i = 1, \dots, p$) as shown on the following diagram:



- suppressing an extremal linear branch of length 2, say, $[u, v, w]$, where u is an extremal vertex, together with all edges joining w with the rest Γ' of Γ :



The following simple observation is essentially due to [GMT].

Proposition 2.1. *Let a graph Γ' be obtained from Γ by performing a surgery as above. Then any K -valued harmonic function on Γ restricts to a K -valued harmonic function on Γ' and vice versa, any K -valued harmonic function on Γ' extends uniquely to a K -valued harmonic function on Γ . This extension provides an isomorphism*

$$\text{Harm}(\Gamma', K) \cong \text{Harm}(\Gamma, K).$$

In particular, for a linear path \mathbb{P}_n with $n \geq 3$ vertices we have

$$\text{Harm}(\mathbb{P}_n, K) \cong \text{Harm}(\mathbb{P}_{n-3}, K).$$

Consequently, $\text{Harm}(\mathbb{P}_n, K) \neq (0)$ if and only if $n \equiv 2 \pmod 3$.

Every finite graph Γ can be reduced, via a suitable sequence of the surgeries as above, to a graph, say, $\text{red}_p(\Gamma)$ such that any extremal linear branch of $\text{red}_p(\Gamma)$ has length 1, and at each vertex of $\text{red}_p(\Gamma)$ there are at most $p - 1$ such extremal linear branches.

In case $p = 2$ for a finite tree Γ such a graph $\text{red}_2(\Gamma)$ consists of isolated vertices, say, w_1, \dots, w_t and isolated edges, say, $[u_1, v_1], \dots, [u_s, v_s]$. Any harmonic function h on Γ takes value 0 at w_1, \dots, w_t , while $h(u_i) = h(v_i) \forall i = 1, \dots, s$. Conversely, any such a binary function on $\text{red}_2(\Gamma)$ is harmonic and extends uniquely to a binary harmonic function on Γ . This leads to the following result.

Corollary 2.2. *For a finite tree Γ , $\dim \text{Harm}(\Gamma, \mathbb{F}_2)$ is equal to the number s of isolated edges in any reduction $\text{red}_2(\Gamma)$ of Γ .*

We wonder whether there exists an alternative (non-recursive) combinatorial interpretation of the invariant $\dim \text{Harm}(\Gamma, \mathbb{F}_2)$ (it is related to the “parity dimension” as considered e.g., in [ASZ]).

Remark 2.3. Let us note that the number of isolated vertices in a reduction $\text{red}_2(\Gamma)$ depends on the reduction. Thus this is not in general an invariant of Γ . Indeed, a linear path with 3 vertices \mathbb{P}_3 admits two different reductions. One of them is empty, while the other one is \mathbb{P}_1 and so consists of a single vertex.

Example 2.4. We say that a graph Γ is odd if the degree of each vertex of Γ is. By virtue of Proposition 6 in [ASZ], for any finite odd tree Γ

$$\dim \text{Harm}(\Gamma, \mathbb{F}_2) = 1.$$

The only nonzero binary harmonic function on Γ is the constant function 1. However, $\dim \text{Harm}(\Gamma, \mathbb{F}_2) = \infty$ for any infinite locally finite odd tree Γ .

3. APPENDIX: CLASSICAL POLYNOMIALS

3.1. Normalized Chebyshev polynomials and Fibonacci polynomials. We recall that the Chebyshev polynomials of the first (second) kind⁶ satisfy the following relations:

$$V_0 = 1, \quad V_1 = x \quad \text{and} \quad V_n = 2xV_{n-1} - V_{n-2} \quad \forall n \geq 2,$$

respectively,

$$U_0 = 1, \quad U_1 = 2x \quad \text{and} \quad U_n = 2xU_{n-1} - U_{n-2} \quad \forall n \geq 2.$$

The normalized Chebyshev polynomials of the first (second) kind $G_n \in \mathbb{Z}[x]$ ($F_n \in \mathbb{Z}[x]$, respectively) are defined [HMP] via

$$G_0(x) = 2, \quad G_1(x) = x, \quad \text{and} \quad G_n(x) = xG_{n-1}(x) - G_{n-2}(x) \quad \forall n \geq 2,$$

respectively,

$$F_0(x) = 0, \quad F_1(x) = 1, \quad \text{and} \quad F_n(x) = xF_{n-1}(x) - F_{n-2}(x) \quad \forall n \geq 2.$$

The Fibonacci polynomials $f_n \in \mathbb{Z}[x]$ are generated via the recurrence relation:

$$f_0 = 0, \quad f_1 = 1, \quad f_n = xf_{n-1} + f_{n-2} \quad \forall n \geq 2.$$

They reduce to the Fibonacci numbers for $x = 1$ and satisfy identities similar to those known for the Fibonacci numbers. The polynomials F_n, G_n and xf_n are even (odd) iff n is. We have $G_n(x) = 2V_n\left(\frac{x}{2}\right)$ and

$$(-1)^n \det(\text{adj}(\mathbb{T}_n) - xI_n) = C_n(x) = G_n(x) - 2 \quad \forall n \geq 3,$$

respectively,

$$\det(\text{adj}(\mathbb{P}_{n-1}) - xI_{n-1}) = F_n(-x) \quad \forall n \geq 2.$$

Proposition 3.1. [Bi, HBJ, HMP, §2] *The normalized Chebyshev polynomials F_n, G_n and the Fibonacci polynomials f_n acquire the following properties:*

- $F_n(x + x^{-1}) = \frac{x^n - x^{-n}}{x - x^{-1}}$ and $G_n(x + x^{-1}) = x^n + x^{-n}$.
- $\gcd(F_m, F_n) = F_{\gcd(m,n)}$ and $\gcd(f_m, f_n) = f_{\gcd(m,n)}$.
- $F_m \mid F_n \iff f_m \mid f_n \iff m \mid n$.
- $F_{mn} = F_n \cdot (F_m \circ G_n)$ and $G_{mn} = G_m \circ G_n$.
- $(x^2 - 4)F_m F_n = G_{m+n} - G_{|m-n|}$ and $G_m G_n = G_{m+n} + G_{|m-n|}$.

The next result deals with the irreducible factorization of the Fibonacci polynomials.

Proposition 3.2. [Le, JRS, Corollary 2.3] *There are irreducible polynomials $\theta_n \in \mathbb{Z}[x]$ with nonnegative coefficients, of degree $\deg \theta_n = \varphi(n)$ ⁷ such that*

$$f_n = \prod_{d \mid n} \theta_d \quad \forall n \geq 1.$$

⁶With the conventions used e.g., in MAPLE.

⁷Here φ stands as before for the Euler totient function.

3.2. Dickson polynomials. We recall [LMT] that the Dickson polynomials $D_n(x, a) \in \mathbb{Z}[x, a]$ and $E_n(x, a) \in \mathbb{Z}[x, a]$ of the first (second) kind are defined recursively via:

$$D_0 = 2, \quad D_1 = x, \quad D_{n+1}(x, a) = xD_n(x, a) - aD_{n-1}(x, a),$$

and

$$E_0 = 1, \quad E_1 = x, \quad E_{n+1}(x, a) = xE_n(x, a) - aE_{n-1}(x, a),$$

respectively. They can be also characterized by the identities:

$$D_n(\mu_1 + \mu_2, \mu_1\mu_2) = \mu_1^n + \mu_2^n \quad \text{resp.}, \quad E_n(\mu_1 + \mu_2, \mu_1\mu_2) = \mu_1^{n+1} - \mu_2^{n+1} / (\mu_1 - \mu_2).$$

Furthermore, $E_{n-1} = D_n'/n$. For $a = 1$ the Dickson polynomials specialize to the normalized Chebyshev polynomials:

$$G_n(x) = D_n(x, 1) \quad \text{and} \quad F_{n+1}(x) = E_n(x, 1).$$

Similarly, $f_n(x) = \tilde{f}_n(x, 1)$, where $\tilde{f}(x, y) \in \mathbb{Z}[x, y]$ stands for the bivariate Fibonacci polynomials. These are defined [HL] by the recursion

$$\tilde{f}_0 = 0, \quad \tilde{f}_1 = 1, \quad \tilde{f}_n = x\tilde{f}_{n-1} + y\tilde{f}_{n-2} \quad \forall n \geq 2.$$

The polynomials f_n and \tilde{f}_n are irreducible over \mathbb{Q} if and only if n is prime [HL, WP]. An analog of Proposition 3.2 also holds for \tilde{f}_n [JRS].

3.3. Reduction to a positive characteristic. Given a prime p and a polynomial $F \in \mathbb{Z}[x]$, we let $F^{(p)} \in \mathbb{F}_p[x]$ denote the reduction of F modulo p . The Dickson polynomials reduced modulo p satisfy the relations [BZ]:

$$D_{p^\alpha m}^{(p)} = (D_m^{(p)})^{p^\alpha} \quad \text{resp.} \quad E_{p^\alpha m-1}^{(p)} = (E_{m-1}^{(p)})^{p^\alpha} (x^2 - 4a)^{\frac{p^\alpha-1}{2}},$$

where $m \not\equiv 0 \pmod{p}$. Similarly, for the reduction $F_m^{(p)}$ of the normalized Chebyshev polynomials of the second kind we have

Proposition 3.3. [HMP, §2]

- $F_m^{(p)} \mid F_n^{(p)} \iff m \mid n$.
- $F_{p^k m}^{(p)} = F_{p^k}^{(p)} \cdot (F_m^{(p)})^{p^k}$, where $F_{p^k}^{(p)} = (x^2 - 4)^{(p^k-1)/2}$.
- $F_{(p^k-1)/2}^{(p)} F_{(p^k+1)/2}^{(p)} = \frac{x^{p^k} - x}{x^2 - 4}$ if $p \neq 2$.

Corollary 3.4. [HMP, §2] *Every irreducible polynomial $\tau \in \mathbb{F}_p[x]$ of degree k occurs as a factor of $F_{p^k-1}^{(p)} F_{p^k+1}^{(p)}$ if $p = 2$ or of $F_{(p^k-1)/2}^{(p)} F_{(p^k+1)/2}^{(p)}$ if $p \neq 2$.*

Reducing the polynomials G_n modulo 2 yields the Chebyshev-Dickson polynomials $T_n \in \mathbb{F}_2[x]$. Actually $T_n = C_n^{(2)} = G_n^{(2)} = xF_n^{(2)} = xf_n^{(2)}$ for $n \geq 3$ ⁸. They can also be defined recursively:

$$T_0 = 0, \quad T_1 = x, \quad T_{n+1} = xT_n + T_{n-1},$$

⁸Although $C_0 \equiv T_0$, $C_1 \equiv T_1 \pmod{2}$, however $C_2 = x^2 - 1 \not\equiv T_2 = x^2 \pmod{2}$.

or, alternatively, via the relation

$$T_n(x) \equiv xU_{n-1}\left(\frac{x}{2}\right) \pmod{2},$$

where $U_n \in \mathbb{Z}[x]$ stands for the n th Chebyshev polynomial of the second kind.

Proposition 3.5. [GKW, SB, Su] *The Chebyshev-Dickson polynomials $T_n \in \mathbb{F}_2[x]$ acquire the following properties:*

- $T_n(x + x^{-1}) = x^n + x^{-n}$.
- $T_m \circ T_n = T_{mn}$.
- $\gcd(T_m, T_n) = T_{\gcd(m,n)}$.
- $T_m \mid T_n \iff m \mid n$.
- $T_{2^k m} = T_m^{2^k}$.
- $T_{2^k-1} T_{2^k+1} = (x^{2^k-1} - 1)^2$.

REFERENCES

- [ASZ] A. T. Amin, P. J. Slater, G.-H. Zhang, *Parity dimension for graphs—a linear algebraic approach*, Linear and Multilinear Algebra 50 (2002), 327–342.
- [BR] R. Barua, S. Ramakrishnan, σ -game, σ^+ -game and two-dimensional additive cellular automata, Theoret. Comput. Sci. 154 (1996), 349–366.
- [BZ] M. Bhargava, M. E. Zieve, *Factoring Dickson polynomials over finite fields*, Finite Fields Appl. 5 (1999), 103–111.
- [Bi] M. Bicknell, *A primer for the Fibonacci numbers VII*, Fibonacci Quart. 8 (1970), 407–420.
- [GKW] J. Goldwasser, W. Klostermeyer, H. Ware, *Fibonacci Polynomials and Parity Domination in Grid Graphs*, Graphs and Combinatorics 18 (2002), 271–283.
- [GMT] S. Gravier, M. Mhalla, E. Tannier, *On a modular domination game*, Theoret. Comput. Sci. 306 (2003), 291–303.
- [HB] D. R. Heath-Brown, *Artin’s conjecture for primitive roots*, Quart. J. Math. (2) 37 (1986), 27–38.
- [HBJ] V. E. Hoggatt Jr., M. Bicknell-Johnson, *Divisibility properties of polynomials in Pascal’s triangle*, Fibonacci Quart./ 16 (1978), 501–513.
- [HL] V. E. Hoggatt Jr., C. T. Long, *Divisibility properties of generalized Fibonacci polynomials*, Fibonacci Quart. 12 (1974), 113–120.
- [HMP] M. Hunziker, A. Machiavelo, J. Park, *Chebyshev polynomials over finite fields and reversibility of σ -automata on square grids*, Theoret. Comput. Sci. 320 (2004), 465–483.
- [JRS] G. Jacob, C. Reutenauer, J. Sakarovitch, *On a divisibility property of Fibonacci polynomials*, Preprint infres.enst.fr, January 6, 2006, 6p.
- [Le] D. Levy, *The irreducible factorization of Fibonacci polynomials over \mathbb{Q}* , Fibonacci Quart. 39 (2001), 309–319.
- [LMT] R. Lidl, G. L. Mullen, G. Turnwald, *Dickson polynomials*, Pitman Monographs in Pure and Applied Mathematics, 65. Longman Scientific and Technical, Harlow; John Wiley and Sons, Inc., New York, 1993.
- [MOW] O. Martin, A. M. Odlyzko, S. Wolfram, *Algebraic properties of cellular automata*, Comm. Math. Phys. 93 (1984), 219–258.
- [Mo] P. Moree, *Artin’s primitive root conjecture -a survey -*. arXiv:math/0412262 (2004), 30p.
- [Mu] M. Ram Murty, *Artin’s conjecture for primitive roots*. Math. Intelligencer 10 (1988), 59–67.

- [SB] P. Sarkar, R. Barua, *Multidimensional σ -automata, π -polynomials and generalised S -matrices*, Theoret. Comput. Sci. 197 (1998), 111–138.
- [Su] K. Sutner, *σ -automata and Chebyshev-polynomials*, Theoret. Comput. Sci. 230 (2000), 49–73.
- [WP] W. A. Webb, E. A. Parberry, *Divisibility properties of Fibonacci polynomials*, Fibonacci Quart. 7 (1969), 457–463.
- [Za₁] M. Zaidenberg, *Periodic binary harmonic functions on lattices*, Advances in Applied Mathematics, 2008, 42p. (to appear).
- [Za₂] M. Zaidenberg, *Convolution equations on lattices: periodic solutions with values in a prime characteristic field*, In: Geometry and Dynamics of Groups and Spaces. In Memory of Alexander Reznikov. Progress in Mathematics, Vol. 265. Kapranov, M.; Kolyada, S.; Manin, Y.I.; Moree, P.; Potyagailo, L.A. (Eds.) 2007, Birkhäuser, 719–740 (to appear).

UNIVERSITÉ GRENOBLE I, INSTITUT FOURIER, UMR 5582 CNRS-UJF, BP 74, 38402 St.
MARTIN D'HÈRES CÉDEX, FRANCE

E-mail address: `zaidenbe@ujf-grenoble.fr`