

Covariant spectator theory of np scattering: Phase shifts obtained from precision fits to data below 350 MeV

Franz Gross^{1,2} and Alfred Stadler^{3,4}

¹*College of William and Mary, Williamsburg, Virginia 23185*

²*Thomas Jefferson National Accelerator Facility, Newport News, VA 23606*

³*Centro de Física Nuclear da Universidade de Lisboa, 1649-003 Lisboa, Portugal, and*

⁴*Departamento de Física da Universidade de Évora, 7000-671 Évora, Portugal*

(Dated: November 2, 2018)

Using the covariant spectator theory (CST), we present two one boson exchange kernels that have been successfully adjusted to fit the 2007 world np data (containing 3788 data) below 350 MeV. One model (which we designate WJC-1) has 27 parameters and fits with a $\chi^2/N_{\text{data}} = 1.06$. The other model (designated WJC-2) has only 15 parameters and fits with a $\chi^2/N_{\text{data}} = 1.12$. Both of these models also reproduce the experimental triton binding energy without introducing additional irreducible three-nucleon forces. One result of this work is a new phase shift analysis, updated for all data until 2006, which is useful even if one does not work within the CST. In carrying out these fits we have reviewed the entire data base, adding new data not previously used in other high precision fits and restoring some data omitted in previous fits. A full discussion and evaluation of the 2007 data base is presented.

I. INTRODUCTION

This paper presents many details and new results from a recent application [1] of the covariant spectator theory (CST) [2, 3] to the description of low energy neutron-proton (np) scattering. In this work the parameters of generalized one-boson-exchange (OBE) models are adjusted to obtain precision fits to the np scattering data for lab energies $E_{\text{lab}} \leq 350$ MeV. The OBE models fixed by the fits give a simple, manifestly covariant description of the nuclear force, a necessary starting point for the computation of many properties of interacting few-body systems. These models will be particularly useful for the description of interactions where the two nucleon system has low relative momentum but recoils at GeV energies; in these cases a covariant approach based on a fit to low energy data is both necessary and effective. Furthermore, following the procedure of Ref. [4], exchange currents consistent with these OBE models can be easily determined and conserved currents defined. With these extensions these models can be applied to the description of the electromagnetic interactions studied at Jefferson Laboratory and elsewhere.

A brief overview of the theory is presented in Sec. II, where the parameters of the class of OBE models considered in this work are defined. CST models of this type were first applied to the quantitative description of np scattering in 1992 [5], and except for a few important differences the theory is unchanged. Details of the theory are reviewed in Appendices.

We present two models motivated by quite different philosophies. Both fit the data very well. The first, WJC-

1 with 27 adjustable parameters, gives a high precision fit with a $\chi^2/N_{\text{data}} = 1.06$. Here we allowed the masses of the heavy bosons and most of the coupling constants to vary in order to obtain the best fit possible. For the second, WJC-2, we simplified the model as much as possible by fixing some of the meson masses and eliminating some of the less important degrees of freedom. The goal was to see how good a fit could be achieved with *only* 15 essential parameters. This fit was less precise but still remarkably good, giving a $\chi^2/N_{\text{data}} = 1.12$. In Sec. III we compare the quality of these fits to the 1993 Nijmegen phase shift analysis [6], the 1995 Argonne AV18 potential [7], and the 2001 CD-Bonn potential [8]. The data base we use is listed and discussed in Sec. IV. It includes data from the original Nijmegen [6] and Bonn analyses [8], as well as additional data from the SAID on-line data base [9], the Nijmegen NN-OnLine data base [10], and a few sets we have collected ourselves. This data base is completely up-to-date, including more data than used in any previous analysis. The χ^2 we obtain for Model WJC-1 is as good as other high precision fit, and both models require fewer parameters than ever used before.

To obtain such “perfect” fits it is necessary to reject certain sets of measurements that seem to be inconsistent with the bulk of the data. We use a statistical selection criteria first introduced by the Nijmegen group [11], and these are reviewed and discussed in detail in Sec. IV. We show, using specific examples, how these selection criteria work. Data reported to have systematic errors can be scaled during the fits, and we give an example of the impact of this scaling.

The phase shifts obtained from the fit are given and discussed in Sec. V. We find significant difference be-

tween our phases and the famous Nijmegen phases [6] obtained from the 1993 analysis.

The CST has also been used to calculate the three-body wave function and the triton binding energy [12, 13]. (We have not yet included the Coulomb part of the pp interaction, and hence cannot calculate pp scattering or the binding energy of ${}^3\text{He}$). In 1997, using a family of less precise models, we found [12] that the correct triton binding energy emerged *automatically* from the model that gave the best fit to the two-body data, requiring no new mechanisms or assumptions. In Sec. VI we show how this remarkable result continues to hold for these new high precision models, suggesting that it is a robust feature of the CST. Sec. VII presents our conclusions.

Details of the theory and the models have been developed in several long Appendices, which also review and compile many results reported previously. Appendix A gives a short introduction to all of Appendices. Appendix B discusses some of the implications of the CST prescription that one particle is on-shell. We show there that (i) the equations satisfy the generalized Pauli principal, even though the equations *appear* to treat the two identical particles differently (because only one particle is on-shell), (ii) the equations give the *same* answer for the fully on-shell scattering amplitude, independent of which particle is on-shell (the convention used here is to place particle 1 on-shell), and (iii) the new prescription used in this paper for removing spurious singularities from the kernel is simple and effective. Appendix C shows that the OBE models used in this paper are able to reproduce the spin and isospin structure of the most general *on-shell* NN kernel, explaining why bosons of spin 2 and larger are not needed. Appendix D discusses the role of the nucleon form factor in removing (spurious) deeply bound states from the theory, and Appendix E gives a detailed review of the helicity, angular momentum expansions, and symmetry relations used to reduce the equations to the simple form used for numerical solutions.

II. OVERVIEW OF THE THEORY

In the CST [2, 3], the two-body scattering amplitude M is the solution of a covariant integral equation derived from field theory (sometimes referred to as the ‘‘Gross equation’’). In common with many other equations, it has the form

$$M = V - VGM \quad (2.1)$$

where V is the irreducible kernel (playing the role of a potential) and G is the intermediate state propagator. As with the Bethe-Salpeter (BS) equation [14], if the kernel is exact and nucleon self energies are included in the propagators, iteration of the CST equation generates the full Feynman series. In cases where this series does not converge (nearly always!) the equation solves the problem nonperturbatively. With the BS equation the

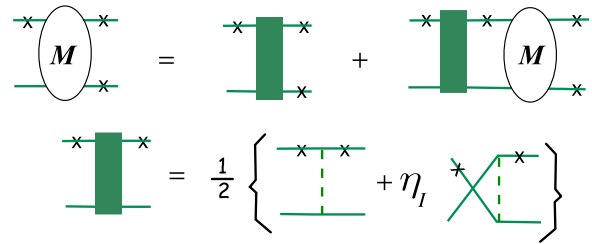

FIG. 1: (Color on line) Top line: diagrammatic representation of the Covariant Spectator equation (2.2) with particle 1 on-shell (the on-shell particle is labeled with a \times). Second line: diagrammatic representation of the definition of the antisymmetrized kernel (2.6).

four-momenta of all A intermediate particles are subject only to the conservation of total four-momentum $P = \sum_{i=1}^A p_i$, so the integration is over $4(A-1)$ variables. In the CST equation, all but one of the intermediate particles are restricted to their positive-energy mass shell, constraining $A-1$ energies (they become functions of the three-momenta) and leaving only $3(A-1)$ internal variables, the *same number* of variables as in nonrelativistic theory. Since the on-shell constraints are covariant, the resulting equations remain manifestly covariant even though all intermediate loop integrations reduce to three dimensions, which greatly simplifies their numerical solution and physical interpretation. This framework has been applied successfully to many problems, in particular also to the two- and three-nucleon system [5, 12, 13].

The specific form of the CST equation for the two-nucleon scattering amplitude M , with particle 1 on-shell in both the initial and final state, is derived in Ref. [5] (referred to as Ref. I below) and illustrated in Fig. 1. The equation is

$$M_{12}(p, p'; P) = \bar{V}_{12}(p, p'; P) - \int \frac{d^3k}{(2\pi)^3} \frac{m}{E_k} \bar{V}_{12}(p, k; P) G_2(k, P) M_{12}(k, p'; P), \quad (2.2)$$

where P is the conserved total four-momentum, and p, p' , and k are relative four-momenta related to the momenta of particles 1 and 2 by $p_1 = \frac{1}{2}P + p$, $p_2 = \frac{1}{2}P - p$, $E_k = \sqrt{m^2 + k^2}$ is the energy of the on-shell particle 1 in the cm system, and

$$M_{12}(p, p'; P) \equiv M_{\lambda\lambda', \beta\beta'}(p, p'; P) = \bar{u}_\alpha(\mathbf{p}, \lambda) \mathcal{M}_{\alpha\alpha'; \beta\beta'}(p, p'; P) u_{\alpha'}(\mathbf{p}', \lambda') \quad (2.3)$$

is the matrix element of the Feynman scattering amplitude \mathcal{M} between positive energy Dirac spinors of particle 1. The definitions of the nucleon spinors $u(p, \lambda)$ (with λ the helicity of the nucleon) and the partial wave decomposition of the amplitude M_{12} and \bar{V}_{12} are given in Appendix E. The propagator for the off-shell particle 2 is

$$G_2(k, P) \equiv G_{\beta\beta'}(k_2) = \frac{(m + \not{k}_2)_{\beta\beta'}}{m^2 - k_2^2 - i\epsilon} H^2(k_2) \quad (2.4)$$

with $k_2 = P - k_1$, $k_1^2 = m^2$, and H the form factor of the off-shell nucleon (related to its self energy), normalized to unity when $k_2^2 = m^2$. In this paper we use

$$H(p) = \left[\frac{(\Lambda_N^2 - m^2)^2}{(\Lambda_N^2 - m^2)^2 + (m^2 - p^2)^2} \right]^2. \quad (2.5)$$

See Appendix D for further discussion of the nucleon form factor H . The indices 1 and 2 refer collectively to the two helicity or Dirac indices of particle 1, either $\{\lambda\lambda'\}$ or $\{\alpha\alpha'\}$, and particle 2, $\{\beta\beta'\}$.

The covariant kernel \bar{V} is explicitly antisymmetrized, as illustrated in the second line of Fig. 1. In its Dirac form it is

$$\begin{aligned} \bar{V}_{\alpha\alpha';\beta\beta'}(p, k; P) \\ = \frac{1}{2} [V_{\alpha\alpha';\beta\beta'}(p, k; P) + \eta_I V_{\beta\alpha';\alpha\beta'}(-p, k; P)], \end{aligned} \quad (2.6)$$

where the factor $\eta_I = \zeta(-)^{I+1}$ (with $I=0$ or 1 the isospin of the NN state) accounts for the sign change due to the exchange of the isospin indices (which are suppressed in these formulae), and $\zeta = 1$ for bosons and -1 for fermions. Hence, for fermions, the remaining amplitude has the symmetry $\eta_I = (-)^I$ under particle interchange $\{p_1, \alpha\} \leftrightarrow \{p_2, \beta\}$ as required by the generalized Pauli principle. This symmetry insures that identical results emerge if a different particle is chosen to be on-shell in either the initial or final state. Some details of the construction of this equation can be found in Appendix B.

It is assumed that the kernel can be written as a sum of OBE contributions

$$V_{\alpha\alpha';\beta\beta'}(p, k; P) = \sum_b V_{12}^b(p, k; P) \quad (2.7)$$

with individual boson contributions of the form

$$V_{12}^b(p, k; P) = \epsilon_b \delta \frac{\Lambda_1^b(p_1, k_1) \otimes \Lambda_2^b(p_2, k_2)}{m_b^2 + |q^2|} f(\Lambda_b, q) \quad (2.8)$$

with $b = \{s, p, v, a\}$ denoting the boson type, $q = p_1 - k_1 = k_2 - p_2 = p - k$ the momentum transfer, m_b the boson mass, ϵ_b a phase factor, and $\delta = 1$ for isoscalar bosons and $\delta = \tau_1 \cdot \tau_2 = -1 - 2(-)^I$ for isovector bosons. All boson form factors, f , have the simple form

$$f(\Lambda_b, q) = \left[\frac{\Lambda_b^2}{\Lambda_b^2 + |q^2|} \right]^4 \quad (2.9)$$

with Λ_b the boson form factor mass. The use of the absolute value $|q^2|$ amounts to a covariant redefinition of the propagators and form factors in the region $q^2 > 0$. It is a significant new theoretical improvement that removes all singularities and can be justified by a detailed study of the structure of the exchange diagrams, as discussed in detail in Appendix B 2 c. The axial vector bosons are treated as contact interactions, with the structure as in (2.8), but with the propagator replaced by a constant, $m_a^2 + |q^2| \rightarrow m^2$, where the nucleon mass sets a convenient

TABLE I: Mathematical forms of the bNN vertex functions, with $\Theta(p) \equiv (m - \not{p})/2m$. The vector propagator is $\Delta_{\mu\nu} = g_{\mu\nu} - q_\mu q_\nu / m_v^2$ with the boson momentum $q = p_1 - k_1 = k_2 - p_2$.

$J^P(b)$	ϵ_b	$\Lambda_1 \otimes \Lambda_2$	$\Lambda(p, k)$ or $\Lambda^\mu(p, k)$
$0^+(s)$	-	$\Lambda_1 \Lambda_2$	$g_s - \nu_s [\Theta(p) + \Theta(k)]$
$0^-(p)$	+	$\Lambda_1 \Lambda_2$	$g_p \gamma^5$ $-g_p(1 - \lambda_p) [\Theta(p)\gamma^5 + \gamma^5\Theta(k)]$
$1^-(v)$	+	$\Lambda_1^\mu \Lambda_2^\nu \Delta_{\mu\nu}$	$g_v [\gamma^\mu + \frac{\kappa_v}{2M} i\sigma^{\mu\nu}(p - k)_\nu]$ $+g_v \nu_v [\Theta(p)\gamma^\mu + \gamma^\mu\Theta(k)]$
$1^+(a)$	+	$\Lambda_1^\mu \Lambda_2^\nu g_{\mu\nu}$	$g_a \gamma^5 \gamma^\nu$

scale not related to a boson mass (the effective boson mass in a contact interaction is infinite). The explicit forms of the numerator functions $\Lambda_1^b \otimes \Lambda_2^b$ can be inferred from Table I. Note that $\lambda_p = 0$ corresponds to pure pseudovector coupling, and that the definitions of the off-shell coupling parameters λ or ν differ for each boson.

In the most general case the kernel is the sum of the exchange of pairs of pseudoscalar, scalar, vector, and axial vector bosons, with one isoscalar and one isovector meson in each pair. If the external particles are all on-shell, we show in Appendix C that these 8 bosons give the *most general* spin-isospin structure possible (because the vector mesons have both Dirac and Pauli couplings, the required 10 invariants can be expanded in terms of only 8 boson exchanges), explaining why bosons with more complicated quantum numbers are not required. Model WJC-1 allows the boson masses (except the pion) to vary, letting the data fix the best mass for each boson in each exchange channel. Finally, charge symmetry is broken by treating charged and neutral pions independently, and by adding a one-photon exchange interaction, simplified by assuming the neutron coupling is purely magnetic, $i\sigma^{\mu\nu} q_\nu$, and that the remaining electromagnetic form factors F_1 and F_2 have the dipole form. To solve the CST NN equation numerically, it was expanded in a basis of partial wave helicity states as described in Ref. I and Appendix E.

The three-body CST equation, derived in Refs. [3, 13]

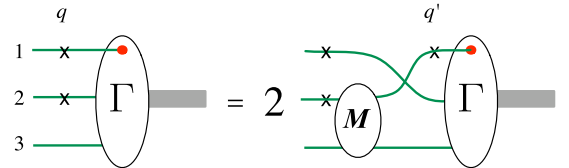

FIG. 2: (Color on line) Diagrammatic representation of the Covariant Spectator equation for the three-body bound state vertex function Γ with particles 1 and 2 on-shell (labeled with a \times). Here particle 1 is the spectator to the last two-body interaction between particles 2 and 3, described by the scattering amplitude M with particle 3 off-shell. The spectator has three momentum q after the two-body interaction and q' before.

and first solved numerically in Ref. [12], is illustrated in Fig. 2. Once the two-body amplitude is determined, the three-body vertex function and the three-body binding energy can be calculated *without any new parameters*.

The best, short summary of the three-body theory can be found in Re. [12]. Here we wish to draw attention to only one feature of this theory. Since the spectator (particle 1 in this case) is on-shell, the relativistic mass W of the interacting two-body subsystem depends on q , the magnitude of the spectator three-momentum, through the relation

$$W^2 = M_t^2 + m^2 - 2M_t E_q, \quad (2.10)$$

where E_q is the spectator energy in the three-body rest system and M_t is the triton mass. Note that this mass is zero at the critical momentum

$$q_{\text{crit}} = \sqrt{\frac{(M_t^2 + m^2)^2}{4M_t^2} - m^2} \simeq \frac{4}{3}m \quad (2.11)$$

where the later relation holds approximately because $M_t \simeq 3m$. Initially, as suggested by Fig. 2, the spectator momentum is integrated over all possible values from 0 to ∞ , and for $q' > q_{\text{crit}}$ this would require knowledge of the two-body scattering amplitude in space-like regions where $W^2 < 0$. This is surely beyond the region where the OBE description could be taken seriously.

Fortunately the spectator theory presents its own solution to this problem. As the spectator momentum q approaches the critical value q_{crit} and the mass W of the two-body system approaches zero, it can be shown [13] that the three-body vertex function Γ goes to zero as a high power of W , providing a natural cutoff that insures that the contributions from the region $W^2 \simeq 0$ (where q is close to q_{crit}) are very small. In applications the integral over q , initially extending from $0 \rightarrow \infty$, is approximated by the covariant integral over the finite interval $[0, q_{\text{crit}}]$. We will study these features in more detail in Appendix D.

III. MESON PARAMETERS AND QUALITY OF THE FITS

Previous models of the kernel, such as models IA, IB, IIA, and IIB of Ref. I [5] and the updated, ν -dependent versions such as W16 used in [12], had been obtained by fitting the potential parameters to the Nijmegen or VPI phase shifts. In a second step the χ^2 to the observables was determined. The models presented in this paper were fit directly to the data, using a minimization program that can constrain two of the low-energy parameters (the deuteron binding energy, $E_d = -2.2246$ MeV, and the 1S_0 scattering length, $a_0 = -23.749$ fm, chosen to fit the very precise cross sections at near zero lab energy). This was a significant improvement, both because the best fit to the 1993 phase shifts did not guarantee a best fit to the

TABLE II: Values of the 27 parameters for WJC-1 with 7 bosons and 2 axial vector contact interactions. All masses and energies are in MeV; other couplings are dimensionless; $G_b = g_b^2/(4\pi)$. Parameters in **bold** were varied during the fit; those labeled with an * were constrained to equal the one above. The triton binding energy is E_t (with its experimental value in parentheses).

b	I	G_b	m_b	λ_b or ν_b	κ_ν	Λ_b
π^0	1	14.608	134.9766	0.153	—	4400
π^\pm	1	13.703	139.5702	-0.312	—	4400*
η	0	10.684	604	0.622	—	4400*
σ_0	0	2.307	429	-6.500	—	1435
σ_1	1	0.539	515	0.987	—	1435*
ω	0	3.456	657	0.843	0.048	1376
ρ	1	0.327	787	-1.263	6.536	1376*
h_1	0	0.0026	—	—	—	1376*
a_1	1	-0.436	—	—	—	1376*
$\Lambda_N = \mathbf{1656}$; $E_t = -8.48$ (-8.48)						

TABLE III: Values of the 15 parameters for WJC-2 with 7 bosons. See the caption to Table II for further explanation.

b	I	G_b	m_b	λ_b or ν_b	κ_ν	Λ_b
π^0	1	14.038	134.9766	0.0	—	3661
π^\pm	1	14.038*	139.5702	0.0	—	3661*
η	0	4.386	547.51	0.0	—	3661*
σ_0	0	4.486	478	-1.550	—	3661*
σ_1	1	0.477	454	1.924	—	3661*
ω	0	8.711	782.65	0.0	0.0	1591
ρ	1	0.626	775.50	-2.787	5.099	1591*
$\Lambda_N = \mathbf{1739}$; $E_t = -8.50$ (-8.48)						

TABLE IV: Comparison of precision np models and the 1993 Nijmegen phase shift analysis. Our calculations are in bold face. Number of data used in each fit is in parentheses.

models		$\chi^2/N_{\text{data}}(N_{\text{data}})$		
Reference	# ^a year ^b	1993	2000	2007
PWA93[6]	39 ^c 1993	0.99(2514)	—	—
		1.09^d (3010)	1.11 (3336)	1.12 (3788)
Nijm I[17]	41 ^c 1993	1.03 ^c (2514)	—	—
AV18[7]	40 ^c 1995	1.06(2526)	—	—
CD-Bonn[8]	43 ^c 2000	—	1.02(3058)	—
WJC-1	27 2007	1.03 (3010)	1.05 (3336)	1.06 (3788)
WJC-2	15 2007	1.09 (3010)	1.11 (3336)	1.12 (3788)

^aNumber of parameters

^bIncludes all data prior to this year.

^cFor a fit to both pp and np data.

^dOur fitting procedure uses the effective range expansion. The Nijmegen 3S_1 parameters were taken from Ref. [16], but as no 1S_0 parameters are available we used those of WJC-1.

2007 data base, and because the low-energy constraints stabilized the fits.

The three-body binding energy is very sensitive to the off-shell coupling of the sigma meson, ν_σ , but it turns out that the value of ν_σ determined by the best fit to the two-body data also gives an essentially perfect fit to the triton binding energy, as shown in Sec. VI. This confirms the result first reported in Fig. 1 of Ref. [12].

The parameters obtained in the fits are shown in Tables II and III. The χ^2/N_{data} resulting from the fits are compared with results obtained from earlier fits in Table IV. The data base used in the fits is derived from the previous SAID [9, 15] and Nijmegen [6] analyses with some new data added. The current data set includes a total of 3788 data, 3336 of which are prior to 2000 and 3010 prior to 1993. For comparison, the PWA93 was fit to 2514, AV18 to 2526, and CD-Bonn to 3058 np data. We restored some data sets previously discarded because their χ^2 were no longer outside of statistically acceptable limits, and this increased the χ^2 slightly. A full discussion of the data and our selection criteria are given in Sec. IV.

In both of our models the high-momentum cutoff is provided by the *nucleon* form factor and not the meson form factors. Hence the very hard pion form factors merely reflect the fact that the nucleon form factors are sufficient to model the short range physics in the pion exchange channel. The off-shell scalar couplings are perhaps the most uncommon features of these models. They are clearly essential for the accurate prediction of three-body binding energies [12]. It is gratifying to see that the pseudoscalar components of the pion couplings (proportional to λ_p) remain close to zero, even when unconstrained, and that effective masses of all the bosons remain in the expected range of 400-800 MeV.

Aside from this, the parameters of WJC-2 are quite close to values expected from older OBE models of nuclear forces. A possible exception is the pion coupling constant, somewhat larger than the $g^2/(4\pi) = 13.567$ found by the Nijmegen group. The high-precision Model WJC-1 shows some novel features: (a) $g_{\pi^0} > g_{\pi^\pm}$, (b) large g_η , and (c) small g_ω .

During the fits we did not restrict the signs of $G_b = g_b^2/(4\pi)$, and the fact that they turn out to be positive is an important prediction of the OBE model. The exception was the strength of the a_1 “meson” in Model WJC-1. Since $G_a < 0$, this requires reinterpreting this “exchange” as a contact interaction (allowed within the general framework of an OBE model) with its sign not fixed by theory. This approach was further supported by the discovery that allowing the axial vectors to have finite masses did not significantly improve the fits.

Why do these OBE models work so well? We are reminded of the Dirac equation; it automatically includes the $p^4/(8m^3)$ energy correction that contributes to fine structure, the Darwin term (including the Thomas precession), the spin-orbit interaction, and the anomalous gyromagnetic ratio. Similarly, the CST automatically

generates relativistic structures hard to identify, and impossible to add to a nonrelativistic model without new parameters.

IV. SELECTION OF DATA

The data used in the fits were originally obtained from R. A. Arndt’s SAID program [15], kept up-to-date by the George Washington University [9] NN on-line data base. These were then compared with the data tables used in the 1993 Nijmegen phase shift analysis [6], with the additional data used by CD-Bonn [8], and with the Nijmegen group’s on-line data base [10]. We also added a few data sets that had either been overlooked, or were too recent to be included in any of these other data sets. We discussed details of the data selection and rejection (and other issues) with several members of the Nijmegen group [18]. We believe that our new 2007 data set is the most complete available at the present time.

The full data file included some data that were never published in refereed journals, and, following the accepted practice, these were excluded from consideration right from the beginning. The set of published data includes 3788 data used in our fits, listed in Table V, and an additional 1180 published data that we did not use, listed in Table VI. There are two principal reasons for excluding published data. Some data were extracted from deuteron or other few-body targets and might be subject to unknown theoretical errors associated with this extraction. These data are labeled with a “c” in the comment column of Table VI. In agreement with previous practice these data were excluded; fortunately the data set is now so complete that it is no longer necessary to use such data. Other data have improbably large (or small) statistical errors (i.e. χ^2), and following the practice first introduced by the Nijmegen group this data is also excluded.

Considerable time and effort was spent examining this last criterion in detail, and an independent decision about whether or not to exclude each data set was made. In doing so, the same criterion originally introduced by the Nijmegen group [11] was used. The heart of the data selection process is to evaluate whether or not each data set is consistent with the rest of the data. If a particular data set has an error that is statistically “too large” or “too small,” then this set is highly unlikely to be correct, and it is justified to exclude the set from the analysis.

If the data satisfy a gaussian distribution, it is pointed out in Ref. [11] that the statistical distribution of $z \equiv \chi^2/n$ for n data will satisfy the following normalized distribution

$$\mathcal{P}_n(z) = \frac{n(nz/2)^{n/2-1}}{2\Gamma(n/2)} \exp(-nz/2), \quad (4.1)$$

with expectation value $z = 1$ and variance $\delta z = 2/\sqrt{n}$.

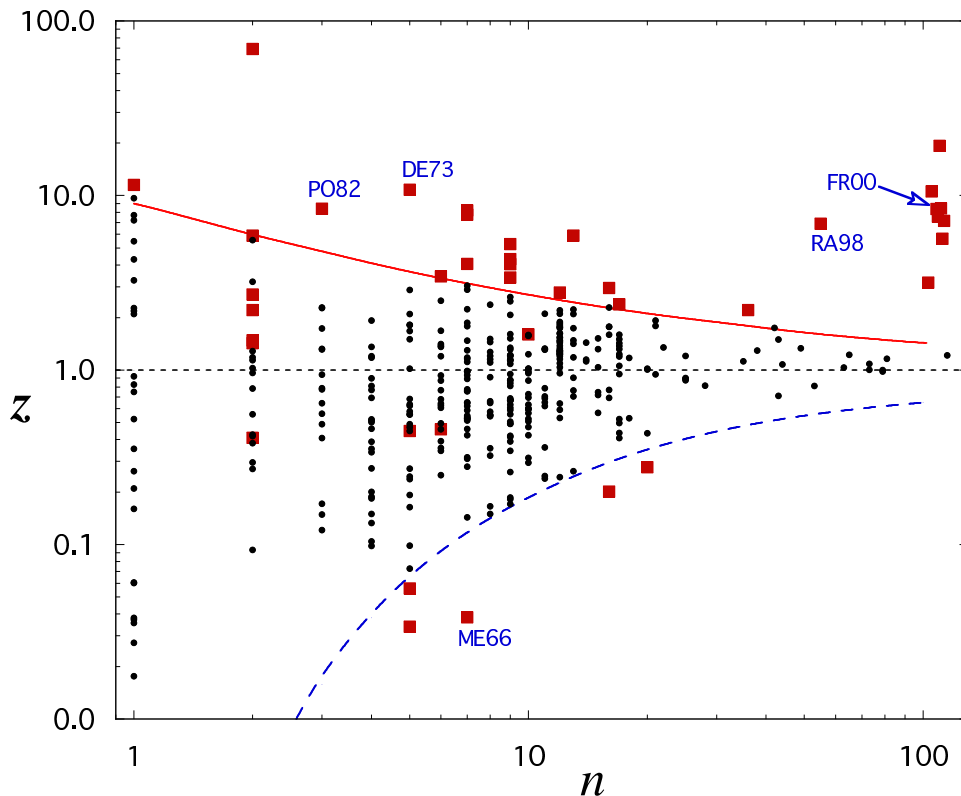

FIG. 3: (Color on line) Log-log scatter plot showing the value of $z = \chi^2/n$ for each data set with n data. The sets that are retained are represented by small circles; those rejected by larger boxes. The z_{max} (solid line) and z_{min} (dashed line) limits given by Eq. (4.3) are shown. The five labeled data sets are discussed in Figs. 5, 7, and 8.

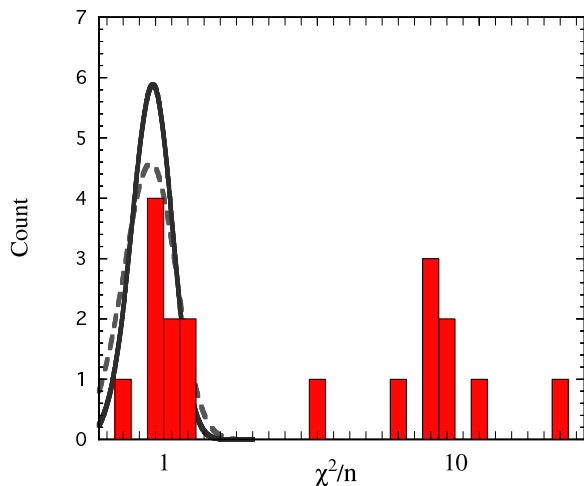

FIG. 4: (Color on line) Distribution in χ^2/n of data sets with $n > 50$. The continuous curves are the theoretical distributions (normalized to this number of sets) with $n = 100$ (solid curve) and $n = 60$ (dashed curve). (Both curves are given in order to show the dependence of the theoretical distributions (4.1) on n .)

We adopt the Nijmegen criteria that the error is “too large” or “too small” if the probability that such a measurement could be obtained is less than 0.27%. This corresponds to the “ 3σ ” criterion, obtained by considering

the probability that a measurement lies beyond the 3σ limit of a gaussian distribution, either too large or too small. For a measurement with expected value of zero, this probability is obtained by integrating the normalized distribution over the regions that are “too large” or “too small” by 3σ

$$\mathcal{P}_{3\sigma} = 2 \int_{3\sigma}^{\infty} dx N \exp\left(-\frac{x^2}{2\sigma^2}\right) = 0.0027 \quad (4.2)$$

The 3σ criterion thus leads to both minimum and maximum allowed values of z that depend on the number of data in each set. These are given by

$$\begin{aligned} 0.0027 &= \int_{z_{max}(n)}^{\infty} dz \mathcal{P}_n(z) \\ 0.0027 &= \int_0^{z_{min}(n)} dz \mathcal{P}_n(z). \end{aligned} \quad (4.3)$$

Fig. 3 shows a scatter plot of $z = \chi^2/n$ versus the number of measurements n for each of the 393 published sets listed in Tables V and VI. Those sets included in the analysis (from Table V) are represented by a dot, and those excluded (from Table VI) by a small square. The maximum and minimum z allowed by the criteria of Eq. (4.3) are also shown in the figure. If all of these data sets were statistically consistent with each other, we

TABLE V: List of all data used in the fitting. Here n_1 is the number of energy or angular measurements in the set and n_2 is the number of data points used in the fit (including a data point for systematic error whenever specified, and reduced in some cases by rejection of measurements at the particular angles or energies given in the footnote). For each set with a systematic error specified by “sys” (column 7), the χ_{sys}^2 and scale factor (as defined in the text) are also given. When given, the comment code consists of three letters, as discussed in the text.

E_{lab}	Ref.	Type	θ	n_1	n_2	sys	χ_{sys}^2	scale	χ_t^2	χ_t^2/n	comments
0.0	DI75[19]	SGT	—	1	1	no systematic error			2.18	2.18	NLx
0.0	HO71[20]	SGT	—	1	1	no systematic error			0.06	0.06	NLx
0.0	KO90[21]	SGT	—	1	1	no systematic error			9.65	9.65	xLx
0.0	FU76[22]	SGT	—	1	1	no systematic error			5.48	5.48	NLx
0.1- 0.6	AL55[23]	SGT	—	5	5	no systematic error			2.24	0.45	NLx
0.5- 3.2	EN63[24]	SGT	—	2	2	no systematic error			2.06	1.03	NLS
0.5- 24.6	CL72[25]	SGT	—	114	115	0.1% 9.88 1.003			139.48	1.21	RRS
0.8- 20.0	CL69[26]	SGT	—	17	15	no systematic error			11.20	0.75	NLS [1]
1.0- 2.5	FI54[27]	SGT	—	2	2	no systematic error			11.08	5.54	xxS
1.3	ST54[28]	SGT	—	1	1	no systematic error			0.75	0.75	xxS
1.5- 27.5	DA71[29]	SGT	—	27	28	0.1% 0.12 1.000			22.85	0.82	NLS
2.5	DV71[30]	SGT	—	1	1	no systematic error			7.72	7.72	NLS
2.7	HR69[31]	DSG	130.0-150.0	2	2	no systematic error			0.54	0.27	NLS
3.0	HR69[31]	DSG	130.0-150.0	2	2	no systematic error			2.57	1.28	NLS
3.3	HR69[31]	DSG	130.0-150.0	3	3	no systematic error			1.47	0.49	NLS
3.7- 11.6	WI95[32]	SGTT	—	9	9	no systematic error			11.81	1.31	NLS
3.7	HR69[31]	DSG	130.0-150.0	4	4	no systematic error			1.42	0.35	NLS
4.0	HR69[31]	DSG	130.0-150.0	4	4	no systematic error			0.53	0.13	NLS
4.3	HR69[31]	DSG	130.0-150.0	4	4	no systematic error			2.01	0.50	NLS
4.7	HR69[31]	DSG	130.0-150.0	4	4	no systematic error			2.05	0.51	NLS
4.7	HA53[33]	SGT	—	1	1	no systematic error			2.27	2.27	xxS
4.9	HR69[31]	DSG	130.0-150.0	4	4	no systematic error			1.09	0.27	NLS
5.0- 19.7	WA01[34]	SGTL	—	6	6	no systematic error			5.23	0.87	xLS
5.0- 19.7	RA99[35]	SGTL	—	6	6	no systematic error			5.23	0.87	Nxx
5.0- 17.1	RA99[35]	SGTT	—	5	5	no systematic error			8.38	1.68	Nxx
5.1	HR69[31]	DSG	130.0-150.0	4	4	no systematic error			3.24	0.81	NLS
5.2	HR69[31]	DSG	130.0-150.0	4	4	no systematic error			4.72	1.18	NLS
7.2- 14.0	BR58[36]	SGT	—	6	6	no systematic error			15.00	2.50	NLS
7.6	WE92[37]	P	65.8-124.8	4	5	3.0% 0.18 1.013			10.48	2.10	NLS
10.0	BO01[38]	DSG	59.9-180.0	6	7	0.8% 0.03 1.001			2.17	0.31	xLS
10.0	HO88[39]	P	44.5-165.3	12	13	4.0% 0.23 0.981			9.93	0.76	NLS
10.7- 17.1	WA01[34]	SGTT	—	3	3	no systematic error			3.97	1.32	xLS
11.0	MU71[40]	P	90.0	1	1	no systematic error			0.04	0.04	NLS
12.0	WE92[37]	P	46.0-125.2	8	9	3.0% 0.39 1.019			14.48	1.61	NLS
13.5	TO77[41]	P	90.0	1	1	no systematic error			0.04	0.04	NLS
13.7	SC88[42]	AYY	90.0	1	1	no systematic error			7.20	7.20	NLS
14.0	AR70[43]	DSG	80.0-100.0	3	4	1.6% 0.13 1.006			0.80	0.20	RRS
14.0	SC88[42]	AYY	90.0	1	1	no systematic error			2.09	2.09	NxS
14.1	SE55[44]	DSG	70.0-173.0	6	7	4.0% 0.02 1.005			1.00	0.14	NLS
14.1	PO52[45]	SGT	—	1	1	no systematic error			0.01	0.01	xxS
14.1	BR81[46]	P	50.6-156.6	10	11	3.0% 0.00 0.998			3.97	0.36	NLS
14.1	AL53[47]	DSG	48.0-154.5	8	8	float 1.061			1.32	0.17	xxS
14.1	GR65[48]	DSG	90.0-170.0	5	5	float 1.001			2.35	0.47	NLS
14.1	NA60[49]	DSG	89.0-165.0	4	5	0.7% 0.09 0.998			0.36	0.07	NLS

[1] 1.2 9.9

TABLE V: (continued)

E_{lab}	Ref.	Type	θ	n_1	n_2	sys	χ_{sys}^2	scale	χ_t^2	χ_t^2/n	comments
14.1	WE92[37]	P	45.9-125.2	5	6	3.0%	0.17	1.013	3.76	0.63	NLS
14.1	SH74[50]	DSG	52.5-172.0	8	8	no systematic error			2.85	0.36	xLS
14.1	BU97[51]	DSG	89.7-155.7	6	7	7.1%	0.00	1.005	5.43	0.78	NLS
14.5	FI77[52]	P	40.0-120.0	8	9	5.0%	0.01	1.005	7.87	0.87	NLS
14.8	TO77[41]	P	90.0	1	1	no systematic error			0.35	0.35	NLS
15.7	MO67[53]	DSG	56.6-161.8	16	16	float	0.978		11.10	0.69	NLS
15.8-110.0	BO61[54]	SGT	—	34	35	2.0%	0.14	0.993	39.25	1.12	NLS
15.8	CL98[55]	DT	132.4	1	1	no systematic error			4.31	4.31	NLS
16.0	TO77[41]	P	90.0	1	1	no systematic error			0.04	0.04	NxS
16.0	WE92[37]	P	46.0-125.2	5	6	3.0%	0.18	0.987	7.19	1.20	NLS
16.2	GA72[56]	P	70.0-130.0	3	3	no systematic error			0.51	0.17	NLS
16.2	BR96[57]	SGTT	—	1	1	no systematic error			0.00	0.00	NLS
16.2	BR97[58]	SGTL	—	1	1	no systematic error			0.16	0.16	NLS
16.4	BE62[59]	P	100.0-140.0	3	4	9.3%	0.00	0.997	2.77	0.69	NLS
16.4	JO74[60]	P	90.0-150.0	4	4	no systematic error			3.59	0.90	NLS
16.8	MU71[40]	P	90.0	1	1	no systematic error			0.03	0.03	NLS
16.9	MO74[61]	P	40.0-140.0	4	5	6.0%	0.26	1.032	3.13	0.63	NLS
16.9	TO88[62]	P	51.0-143.7	11	12	2.0%	0.03	1.004	15.56	1.30	NLS
17.0	WI84[63]	P	33.1-122.9	6	7	2.0%	0.00	0.999	3.67	0.52	NLS
17.4	OC91[64]	DT	132.9	1	2	5.5%	0.338	1.03	2.28	1.14	NLS
17.8- 29.0	PE60[65]	SGT	—	5	5	no systematic error			7.52	1.50	NLS
17.9	GA55[66]	DSG	80.0-175.0	11	12	1.9%	0.14	1.007	12.44	1.04	NLS
18.5	WE92[37]	P	65.6-125.0	4	5	3.0%	0.14	1.011	2.79	0.56	NLS
19.0	WI84[63]	P	33.1-122.9	6	7	3.0%	0.01	1.004	4.35	0.62	NLS
19.6- 28.0	GR66[67]	SGT	—	3	4	0.1%	0.04	1.000	3.07	0.77	NLS
19.7	DA59[68]	SGT	—	1	1	no systematic error			0.82	0.82	NLS
20.5	LA65[69]	P	21.5-100.5	9	10	18.8%	0.38	0.896	6.02	0.60	NLS
21.1	MO74[61]	P	40.0-140.0	6	7	3.0%	0.29	1.016	5.31	0.76	NLS
21.6	JO74[60]	P	50.0-170.0	7	7	float	0.802		2.96	0.42	NLS
21.6	SI89[70]	P	77.5-150.0	5	6	4.0%	0.33	0.978	3.86	0.64	NLS
22.0	WI84[63]	P	33.1-151.4	8	9	3.1%	0.34	0.982	13.66	1.52	NLS
22.2	FI90[71]	DSG	104.6-164.9	5	6	10.0%	0.00	1.002	2.15	0.36	NLS
22.5	FL62[72]	DSG	65.0-175.0	12	12	float	1.021		6.38	0.53	NLS
22.5	SC63[73]	DSG	7.0- 51.0	6	7	3.3%	0.03	0.994	3.21	0.46	RRS
22.5	FL62[72]	SGT	—	1	2	2.0%	0.13	1.007	0.84	0.42	xxS
23.1	MA66[74]	AYY	130.0-174.0	4	4	no systematic error			0.39	0.10	NLS
23.1	PE63[75]	P	50.0-150.0	6	7	4.0%	0.00	1.000	3.77	0.54	NLS
23.1	MU71[40]	P	140.0-150.0	2	3	20.0%	0.12	1.074	0.45	0.15	NLS
23.1	MA66[74]	P	140.0-150.0	2	3	12.2%	0.03	1.022	0.36	0.12	NLS
23.7	BE62[59]	P	80.0-140.0	4	5	10.9%	0.11	1.038	1.22	0.24	NLS
24.0	RO70[76]	DSG	89.0-164.7	4	5	0.5%	3.90	1.010	14.40	2.88	RRS
24.0	BU73[77]	DSG	71.3-157.9	4	4	float	1.015		2.09	0.52	NLS
24.0	MA72[78]	DSG	39.3- 50.5	2	2	no systematic error			0.76	0.38	NLS
24.6- 59.3	BR70[79]	SGT	—	8	9	3.0%	0.00	0.999	8.53	0.95	NLS
25.0	WI84[63]	P	33.1-151.4	8	9	2.9%	0.39	0.982	5.30	0.59	NLS
25.0	FI90[71]	DSG	104.6-164.9	5	6	10.0%	0.00	1.003	1.50	0.25	NLS
25.0	SR86[80]	P	50.7-148.4	11	12	2.5%	0.07	1.007	11.50	0.96	NLS
25.0	SR86[80]	P	128.7-164.6	5	6	2.5%	0.02	0.996	2.75	0.46	NLS
25.3	DR79[81]	DSG	180.0	1	1	no systematic error			0.00	0.00	NLS
25.5	OC91[64]	DT	131.1	1	1	no systematic error			0.26	0.26	NLS
25.8	MO77[82]	DSG	20.1- 90.5	8	9	3.0%	0.01	0.998	4.56	0.51	NLS
25.8	MO77[82]	DSG	89.5-178.0	8	9	3.0%	0.00	1.002	3.78	0.42	NLS
26.9- 72.5	BO85[83]	SGT	—	5	5	no systematic error			5.10	1.02	NLS
27.2	BU73[77]	DSG	71.3-157.8	5	5	float	1.005		1.36	0.27	NLS
27.4	FI90[71]	DSG	104.6-164.9	5	6	10.0%	0.00	1.003	2.07	0.35	NLS
27.5	SC63[73]	DSG	7.0- 72.0	8	9	3.0%	0.69	0.976	1.68	0.19	RRS
27.5	SC63[73]	DSG	159.0-173.0	3	3	float	1.161		2.32	0.77	RRS

TABLE V: (continued)

E_{lab}	Ref.	Type	θ	n_1	n_2	sys	χ_{sys}^2	scale	χ_t^2	χ_t^2/n	comments
27.5	WI84[63]	P	33.1-151.4	8	8	3.0%	0.43	0.981	9.22	1.15	NLS [2]
29.0	BE97[84]	DSG	40.0-140.0	6	7	5.0%	0.06	1.012	15.62	2.23	RLS
29.6	MU71[40]	P	60.0-120.0	3	4	10.0%	0.03	0.982	1.36	0.34	NLS
29.6	EL75[85]	P	50.0-150.0	11	11	no systematic error			2.72	0.25	RRS
30.0	LA65[69]	P	21.5-100.5	9	10	8.3%	0.06	1.021	12.33	1.23	NLS
30.0	LA65[69]	P	139.0-158.5	3	4	8.3%	0.02	1.011	1.56	0.39	NLS
30.0	WI84[63]	P	33.1-151.4	8	9	2.9%	0.24	0.986	3.51	0.39	NLS
31.1	DR79[81]	DSG	180.0	1	1	no systematic error			0.06	0.06	NLS
31.6	RY72[86]	P	60.5-100.6	2	2	no systematic error			2.37	1.19	NLS
32.5	SC63[73]	DSG	7.0- 82.0	9	10	2.1%	5.15	0.955	15.79	1.58	RRS
32.5	SC63[73]	DSG	129.0-173.0	6	7	4.0%	3.29	1.078	7.78	1.11	RRS
32.5	RY72[86]	P	80.6	1	1	no systematic error			0.92	0.92	NLS
32.9	FI90[71]	DSG	89.4-164.8	6	7	10.0%	0.00	1.003	5.28	0.75	NLS
33.0	WI84[63]	P	33.1-151.4	8	9	2.9%	1.47	0.966	5.48	0.61	NLS
33.0-350.0	LI82[87]	SGT	—	72	73	1.1%	0.01	1.001	73.18	1.00	NLS
34.5	BE97[84]	DSG	40.0-140.0	6	7	5.0%	0.01	1.006	6.22	0.89	RLS
35.8	FI90[71]	DSG	89.4-164.8	6	7	10.0%	0.00	1.001	8.12	1.16	NLS
36.0	WI84[63]	P	33.1-151.4	8	9	2.9%	1.43	0.967	10.24	1.14	NLS
37.5	SC63[73]	DSG	7.0- 92.0	10	11	2.0%	0.99	0.980	6.84	0.62	RRS
37.5	SC63[73]	DSG	118.0-173.0	7	8	4.0%	5.04	1.099	9.66	1.21	RRS
37.5	BE97[84]	DSG	40.0-140.0	6	7	5.0%	0.11	1.017	21.29	3.04	RLS
38.0	TA53[88]	SGT	—	1	2	2.6%	0.41	1.017	1.12	0.56	xxS
39.7	FI90[71]	DSG	89.4-164.8	6	7	10.0%	0.01	0.988	10.31	1.47	RRS
40.0	LA65[69]	P	21.5-101.0	9	10	10.6%	0.04	0.980	7.28	0.73	NLS
40.0	LA65[69]	P	109.0-158.5	6	7	10.6%	0.26	0.949	3.83	0.55	NLS
40.0	WI84[63]	P	33.1-151.4	8	9	2.9%	0.19	0.988	10.22	1.14	NLS
40.0	BL85[89]	DSG	90.0-178.5	3	3	no systematic error			1.69	0.56	NLS
41.0	BE97[84]	DSG	40.0-140.0	6	7	5.0%	0.63	1.041	20.23	2.89	RLS
42.5	SC63[73]	DSG	7.0-102.0	11	12	2.0%	0.72	0.983	14.84	1.24	RRS
42.5	SC63[73]	DSG	78.0-173.0	11	12	4.0%	3.43	1.080	19.52	1.63	RRS
45.0	BL85[89]	DSG	90.0-178.5	3	3	no systematic error			5.19	1.73	NLS
45.0	BE97[84]	DSG	40.0-140.0	6	7	5.0%	0.03	1.009	8.23	1.18	RLS
47.5	SC63[73]	DSG	7.0-102.0	11	12	2.0%	1.49	0.976	20.82	1.74	RRS
47.5	SC63[73]	DSG	78.0-173.0	11	12	4.0%	2.39	1.066	22.64	1.89	RRS
49.0	BE97[84]	DSG	40.0-140.0	6	7	5.0%	0.14	1.019	6.93	0.99	RLS
50.0	WO85[90]	DT	179.0	1	1	no systematic error			0.02	0.02	xLx
50.0	BL85[89]	DSG	90.0-178.5	3	3	no systematic error			3.94	1.31	NLS
50.0	LA65[69]	P	21.5-101.0	9	10	4.7%	0.15	0.982	2.94	0.29	NLS
50.0	LA65[69]	P	99.0-158.5	6	7	4.7%	0.00	1.003	4.54	0.65	NLS
50.0	MO77[82]	DSG	20.3- 90.8	8	9	3.0%	0.01	0.997	4.42	0.49	NLS
50.0	MO77[82]	DSG	69.2-173.3	12	13	3.0%	0.01	1.004	18.38	1.41	NLS
50.0	JO77[91]	AYY	109.0-174.0	4	5	25.0%	0.15	1.109	1.19	0.24	NLS
50.0	RO78[92]	P	69.3-149.6	9	10	3.6%	0.13	1.013	6.02	0.60	NLS
50.0	GA80[93]	P	60.6-120.6	7	7	4.0%	0.01	0.995	4.11	0.59	NLS [3]
50.0	FI80[94]	AYY	108.0-174.0	4	5	7.8%	0.47	1.057	2.44	0.49	NLS
50.0	WI84[63]	P	33.1-151.4	8	9	3.4%	0.85	0.970	10.95	1.22	NLS
50.0	FI90[71]	DSG	89.4-164.8	6	7	10.0%	0.01	1.009	4.57	0.65	NLS
50.0	FI80[94]	P	108.0-174.0	4	5	2.0%	0.00	1.001	0.82	0.16	NLS
52.5	SC63[73]	DSG	7.0-112.0	12	13	1.7%	2.61	0.973	22.56	1.74	RRS
52.5	SC63[73]	DSG	78.0-173.0	11	12	3.8%	0.69	1.033	14.37	1.20	RRS
53.0	BE97[84]	DSG	40.0-140.0	6	7	5.0%	0.25	1.026	3.70	0.53	RLS
55.1	BL85[89]	DSG	90.0-178.5	3	3	no systematic error			1.94	0.65	NLS

[2] 151.4

[3] 120.6

TABLE V: (continued)

E_{lab}	Ref.	Type	θ	n_1	n_2	sys	χ_{sys}^2	scale	χ_t^2	χ_t^2/n	comments
57.5	SC63[73]	DSG	7.0-112.0	12	13	2.0%	2.23	0.971	15.36	1.18	RRS
57.5	SC63[73]	DSG	78.0-173.0	11	12	4.0%	1.90	1.058	21.13	1.76	RRS
58.8	BE76[95]	DSG	11.8- 42.3	9	10	10.0%	0.06	0.976	6.33	0.63	NLS
60.0	LA65[69]	P	21.5-101.0	9	10	3.9%	0.31	1.022	5.67	0.57	NLS
60.0	LA65[69]	P	99.0-158.5	7	8	3.9%	0.00	0.998	12.05	1.51	NLS
61.0	BL85[89]	DSG	90.0-166.0	2	2	no systematic error			1.57	0.79	NLS
62.2	BL85[89]	DSG	90.0-178.5	3	3	no systematic error			6.80	2.27	NLS
62.5	SC63[73]	DSG	7.0-112.0	12	13	2.0%	0.01	1.002	27.24	2.10	RRS
62.5	SC63[73]	DSG	78.0-173.0	11	12	4.0%	6.36	1.112	25.25	2.10	RRS
62.7	BE97[84]	DSG	40.0-140.0	6	7	5.0%	0.10	1.016	13.04	1.86	RLS
65.0	BL85[89]	DSG	90.0-178.5	3	3	no systematic error			2.36	0.79	NLS
66.0	HA92[96]	SGTL	—	1	1	no systematic error			0.52	0.52	NLS
67.5	BR92[97]	P	38.6-103.1	12	13	4.0%	0.00	1.000	9.18	0.71	NLS
67.5	BR92[97]	P	82.0-155.2	19	20	4.0%	0.15	0.985	20.38	1.02	NLS
67.5	BE76[95]	DSG	11.9- 42.4	9	10	10.0%	0.06	0.975	9.57	0.96	NLS
67.5	HA91[98]	AZZ	104.8-168.1	20	21	6.0%	0.00	1.004	19.89	0.95	NLS
70.0	BL85[89]	DSG	90.0-178.5	3	3	no systematic error			6.85	2.28	NLS
70.0	SC63[73]	DSG	7.0-122.0	12	13	2.0%	0.01	0.998	28.90	2.22	RRS
70.0	SC63[73]	DSG	78.0-173.0	11	12	4.0%	9.67	1.142	19.42	1.62	RRS
70.0	LA65[69]	P	21.5-101.0	9	10	3.9%	0.71	1.034	9.82	0.98	NLS
70.0	LA65[69]	P	98.5-158.5	7	8	3.9%	0.01	0.996	5.29	0.66	NLS
72.8	BE97[84]	DSG	40.0-140.0	6	7	5.0%	0.11	1.017	3.60	0.51	RLS
76.2	BL85[89]	DSG	90.0-166.0	2	2	no systematic error			6.41	3.20	NLS
76.7	BE76[95]	DSG	11.9- 49.6	11	11	10.0%	0.00	1.002	7.58	0.69	NLS [4]
80.0	SC63[73]	DSG	7.0-112.0	12	13	2.0%	0.82	1.018	19.28	1.48	RRS
80.0	SC63[73]	DSG	78.0-173.0	11	12	4.0%	3.76	1.084	16.02	1.34	RRS
80.0	LA65[69]	P	21.5-101.5	9	10	4.2%	0.37	1.026	5.26	0.53	NLS
80.0	LA65[69]	P	98.5-158.5	7	8	4.2%	0.42	0.973	4.42	0.55	NLS
86.5	BE76[95]	DSG	11.9- 49.7	11	12	10.0%	0.05	0.978	17.25	1.44	NLS
89.5	SC63[73]	DSG	7.0-122.0	13	14	2.0%	1.95	1.029	15.72	1.12	RRS
89.5	SC63[73]	DSG	78.0-173.0	11	12	4.0%	4.12	1.088	15.13	1.26	RRS
90.0	LA65[69]	P	21.5-101.5	9	10	5.1%	0.31	1.029	5.95	0.60	NLS
90.0	LA65[69]	P	98.5-158.5	7	8	5.1%	0.14	0.982	2.59	0.32	NLS
90.0	CH57[99]	DSG	9.0-175.0	17	17	float		1.003	25.48	1.50	NLS
91.0	SA54[100]	DSG	59.8-176.6	25	25	float		1.082	22.52	0.90	xxS
93.4-106.8	CU55[101]	SGT	—	4	4	no systematic error			1.85	0.46	NLS
95.0	ME04[102]	DSG	27.5-150.0	10	11	5.0%	0.67	1.043	7.78	0.71	xxS
95.0	ST57[103]	P	22.5-159.5	15	16	8.0%	0.01	1.008	28.33	1.77	NLS
96.0	KL02[104]	DSG	152.4-175.0	11	12	5.0%	0.06	0.988	7.72	0.64	xxS
96.0	BL04[105]	DSG	80.0-160.0	9	10	3.0%	0.55	1.023	10.17	1.02	xxS
96.0	JO05[106]	DSG	19.9- 75.6	12	12	no systematic error			22.27	1.86	xxS
96.0	GR58[107]	DSG	29.3- 58.8	4	5	5.0%	0.10	0.984	0.49	0.10	NLS
96.8	BE76[95]	DSG	11.9- 49.8	11	12	10.0%	0.08	0.972	16.55	1.38	NLS
98.0	HI56[108]	P	58.6-159.5	9	10	14.3%	0.08	1.043	4.71	0.47	NLS
99.0	SC63[73]	DSG	7.0-122.0	13	14	1.7%	1.69	1.023	20.07	1.43	RRS
99.0	SC63[73]	DSG	78.0-173.0	11	12	3.8%	0.28	1.021	15.51	1.29	RRS
100.0	LA65[69]	P	21.5-101.5	9	10	7.3%	0.00	0.995	3.13	0.31	NLS
100.0	LA65[69]	P	98.5-158.5	7	8	7.3%	0.09	0.979	4.42	0.55	NLS
105.0	TH55[109]	DSG	6.2- 61.4	7	8	8.0%	0.01	0.992	1.20	0.15	NLS
107.6	BE76[95]	DSG	12.0- 50.0	11	12	10.0%	0.08	0.973	17.77	1.48	NLS
108.5	SC63[73]	DSG	7.0-122.0	13	14	2.0%	0.64	1.016	16.05	1.15	RRS
108.5	SC63[73]	DSG	78.0-173.0	11	12	4.0%	0.27	1.021	21.76	1.81	RRS
110.0	LA65[69]	P	22.0-102.0	9	10	10.0%	0.00	1.003	10.19	1.02	NLS

TABLE V: (continued)

E_{lab}	Ref.	Type	θ	n_1	n_2	sys	χ_{sys}^2	scale	χ_t^2	χ_t^2/n	comments
110.0	LA65[69]	P	98.0-158.0	7	8	10.0%	0.24	0.953	8.86	1.11	NLS
118.8	BE76[95]	DSG	12.0- 50.1	11	12	10.0%	0.08	0.972	14.85	1.24	NLS
120.0	CO64[110]	SGT	—	1	1	no systematic error			0.01	0.01	xxS
120.0	LA65[69]	P	22.0-102.0	9	10	14.9%	0.01	1.013	4.24	0.42	NLS
120.0	LA65[69]	P	98.0-158.5	7	8	14.9%	0.09	0.957	4.62	0.58	NLS
125.0-168.0	SH65[111]	SGT	—	2	3	12.0%	0.20	1.056	1.22	0.41	NLS
125.9-344.5	GR85[112]	SGT	—	12	13	1.5%	0.02	1.002	3.42	0.26	NLS
126.0	CA64[113]	P	33.0- 81.9	6	7	10.0%	0.03	0.984	3.70	0.53	NLS
128.0	HO60[114]	DSG	78.1-169.7	10	11	2.2%	0.03	1.004	2.63	0.24	NLS
128.0	HO60[114]	P	78.1-169.7	10	11	10.0%	0.00	0.998	14.51	1.32	NLS
128.0	PA62[115]	DT	124.0-160.0	5	5	no systematic error			9.08	1.82	NLS
128.0	CO64[110]	DT	170.0	1	1	no systematic error			0.00	0.00	NLS
129.0	MS66[116]	DSG	73.2-176.8	15	16	6.5%	0.00	1.004	12.32	0.77	NLS
129.0	HO74[117]	DSG	32.6- 92.0	9	10	16.0%	0.00	0.994	5.07	0.51	NLS
129.0	HO74[117]	DSG	76.2-167.3	16	17	7.0%	0.00	1.003	6.95	0.41	NLS
130.0	RA56[118]	DSG	25.0-155.0	14	15	3.2%	1.08	1.034	10.82	0.72	NLS
130.5	BE76[95]	DSG	11.0- 50.2	11	12	10.0%	0.04	0.981	13.14	1.10	NLS
135.0	LE63[119]	A	42.1- 83.6	5	6	4.0%	0.00	1.003	2.96	0.49	xRS
137.0	TH55[109]	DSG	6.3- 61.8	7	8	5.0%	0.07	0.987	4.34	0.54	NLS
137.0	LE63[119]	R	42.1- 83.6	5	5	no systematic error			3.42	0.68	xRS
137.0	GR58[107]	DSG	19.3- 58.3	5	6	5.0%	1.99	1.076	3.66	0.61	NLS
140.0	ST62[120]	P	20.7-159.3	14	15	4.4%	0.18	1.019	22.81	1.52	NLS
142.8	BE76[95]	DSG	11.0- 50.3	11	12	10.0%	0.03	0.984	2.92	0.24	NLS
143.0	KU61[121]	P	41.0-118.0	8	8	float		1.194	18.94	2.37	xRS
150.0	MS66[116]	DSG	63.2-176.8	16	17	6.5%	0.01	1.006	8.90	0.52	NLS
155.4	BE76[95]	DSG	11.1- 50.5	11	11	10.0%	0.05	0.978	23.07	2.10	NLS [5]
162.0	BO78[122]	DSG	178.5-122.2	43	43	float		1.004	64.33	1.50	NLS
168.5	BE76[95]	DSG	11.1- 50.6	11	11	10.0%	0.05	0.978	14.36	1.31	NLS [6]
175.3	DA96[123]	P	86.6-106.0	20	21	3.1%	9.54	1.106	37.62	1.79	NLS
177.9	BO78[122]	DSG	179.2-122.0	44	44	float		1.003	47.50	1.08	NLS
180.0-332.0	BI91[124]	SGTL	—	4	4	no systematic error			0.42	0.10	NLS
180.0-332.0	BI91[124]	SGTT	—	4	4	no systematic error			0.60	0.15	NLS
181.0	SO87[125]	P	57.5-126.1	10	10	4.0%	0.00	1.002	8.70	0.87	NLS [7]
181.0	SO87[125]	AYY	57.5-126.1	10	11	8.0%	0.03	0.986	14.61	1.33	NLS
181.8	BE76[95]	DSG	11.1- 50.8	11	12	10.0%	0.07	0.975	15.42	1.28	NLS
194.0	SA06[126]	DSG	92.7-177.0	15	16	1.5%	0.00	1.000	36.56	2.29	xxS
194.5	BO78[122]	DSG	179.2-121.2	42	42	float		1.080	73.39	1.75	RRS
195.6	BE76[95]	DSG	11.2- 50.9	11	12	10.0%	0.09	0.971	21.19	1.77	NLS
197.0	SP67[127]	DT	147.4-126.9	3	3	no systematic error			2.82	0.94	xRS
199.0	TH68[128]	DSG	76.9-158.1	8	6	float		1.045	8.14	1.36	NLS [8]
199.0	TH68[128]	P	76.9-158.1	8	9	10.0%	0.20	1.047	22.31	2.48	RRS
200.0	KA63[129]	DSG	6.3-173.8	20	21	2.1%	0.00	1.000	40.34	1.92	RRS
200.0	KA63[129]	SGT	—	1	1	no systematic error			0.00	0.00	NLS
203.1	DA96[123]	P	77.6-101.0	24	25	3.1%	0.02	1.004	30.07	1.20	NLS
210.0	BE76[95]	DSG	11.2- 51.1	11	12	10.0%	0.11	0.969	13.90	1.16	NLS
211.5	BO78[122]	DSG	178.0-120.4	43	43	float		1.000	30.63	0.71	NLS
212.0	KE82[130]	DSG	15.8- 72.9	4	5	2.0%	0.30	0.989	2.89	0.58	NLS
212.0-319.0	KE82[130]	SGT	—	3	4	0.8%	0.00	1.000	0.75	0.19	NLR
217.2	DA96[123]	P	77.6-101.0	24	25	3.1%	0.74	1.027	22.20	0.89	NLS
220.0	CL80[131]	P	49.6-162.1	16	17	3.0%	0.16	1.012	20.97	1.23	NLS

[5] 39.5

[6] 39.6

[7] 119.6

[8] 86.6 96.3

TABLE V: (continued)

E_{lab}	Ref.	Type	θ	n_1	n_2	sys	χ_{sys}^2	scale	χ_t^2	χ_t^2/n	comments
220.0	CL80[131]	DT	98.3-152.5	10	11	3.0%	0.00	1.001	8.65	0.79	NLS
220.0	AM77[132]	RT	161.0	1	2	3.0%	0.025	1.00	0.59	0.30	NLx
220.0	AM77[132]	RPT	161.0	1	2	3.0%	0.000	1.00	0.85	0.43	NLx
220.0	AX80[133]	RT	97.6-152.5	7	8	3.0%	0.02	1.004	7.30	0.91	NLS
220.0	AX80[133]	AT	97.6-152.5	7	8	3.0%	0.02	0.995	11.56	1.44	NLS
220.0	BA89[134]	AYY	71.0-144.2	16	17	7.5%	0.00	1.003	16.14	0.95	NLS
220.0	BA89[134]	P	71.0-144.2	17	17	2.5%	0.08	1.007	7.41	0.44	NLS [9]
220.0	BA89[134]	P	71.0-144.2	16	17	5.0%	0.20	1.023	8.44	0.50	NLS
224.3	BE76[95]	DSG	11.2- 51.2	11	12	10.0%	0.10	0.969	14.71	1.23	NLS
228.0	BA89[134]	RT	160.9	1	1	no systematic error			3.27	3.27	xRS
229.1	BO78[122]	DSG	178.4-119.6	49	49	float		0.999	65.31	1.33	NLS
239.5	BE76[95]	DSG	11.3- 51.4	11	12	10.0%	0.02	0.987	7.13	0.59	NLS
247.2	BO78[122]	DSG	178.4-118.8	53	53	float		0.997	42.99	0.81	NLS
260.0	KE50[135]	DSG	37.7-180.0	15	16	4.0%	0.09	1.012	25.52	1.59	xxS
260.0	AH98[136]	RT	105.4-159.0	8	9	3.0%	3.07	1.055	23.57	2.62	NLS
260.0	AH98[136]	AT	105.4-159.0	8	9	3.0%	0.03	1.005	10.33	1.15	NLS
260.0	AH98[136]	AT	104.4-118.0	3	4	3.0%	0.00	1.001	0.74	0.18	NLS
260.0	AH98[136]	DT	105.4-159.0	8	9	3.0%	0.00	0.999	3.72	0.41	NLS
260.0	AH98[136]	DT	104.4-118.0	3	4	3.0%	0.00	0.999	7.69	1.92	NLS
260.0	AH98[136]	P	105.4-159.0	8	9	2.0%	0.00	1.001	7.89	0.88	NLS
260.0	AH98[136]	P	104.4-118.0	3	4	2.0%	0.09	0.994	4.81	1.20	NLS
260.0	AR00[137]	P	90.0-118.0	8	9	1.8%	0.20	1.008	7.56	0.84	xLS
260.0	AR00[137]	P	102.0-162.0	16	17	1.8%	0.46	1.012	17.95	1.06	xLS
260.0	AR00[137]	AYY	90.0-118.0	8	9	3.9%	0.16	1.016	5.02	0.56	xLS
260.0	AR00[137]	AYY	102.0-162.0	16	17	3.9%	3.92	1.084	20.35	1.20	xLS
260.0	AR00[137]	AZZ	86.0-118.0	9	10	7.2%	1.58	1.099	6.95	0.69	xLS
260.0	AR00[137]	AZZ	102.0-162.0	16	17	7.2%	1.86	1.109	23.31	1.37	xLS
260.0	AN00[138]	D	88.0-120.0	5	6	2.4%	1.25	1.028	8.47	1.41	xLS
260.0	AN00[138]	D0SK	88.0-120.0	5	6	2.4%	0.95	1.024	10.08	1.68	xLS
260.0	AN00[138]	DT	88.0-120.0	5	6	2.4%	0.00	1.000	4.60	0.77	xLS
260.0	AN00[138]	AT	96.0-120.0	4	5	2.4%	0.01	1.002	9.06	1.81	xLS
260.0	AN00[138]	AT	104.0-160.0	8	9	2.4%	0.03	1.004	10.79	1.20	xLS
260.0	AN00[138]	RT	96.0-120.0	4	5	2.4%	0.00	1.000	3.17	0.63	xLS
260.0	AN00[138]	RT	104.0-160.0	8	9	2.4%	0.04	0.995	6.08	0.68	xLS
260.0	AN00[138]	NNKK	104.0-160.0	8	9	2.4%	0.01	1.003	12.10	1.34	xLS
260.0	AN00[138]	NSKN	96.0-120.0	4	5	2.4%	0.00	1.000	0.96	0.19	xLS
260.0	AN00[138]	NSKN	104.0-160.0	8	9	2.4%	0.01	1.002	2.35	0.26	xLS
260.0	AN00[138]	NSSN	96.0-120.0	4	5	2.4%	0.00	0.999	2.78	0.56	xLS
260.0	AN00[138]	NSSN	104.0-160.0	8	9	2.4%	0.00	1.000	1.53	0.17	xLS
261.0	DA96[123]	P	68.6- 89.0	21	22	2.8%	5.00	0.941	29.65	1.35	NLS
265.8	BO78[122]	DSG	178.8-118.0	63	63	float		0.994	65.07	1.03	NLS
267.2	BE76[95]	DSG	11.4- 51.7	11	11	10.0%	0.18	0.960	7.18	0.65	NLS [10]
284.0	DA02[139]	P	113.0-176.3	14	15	3.0%	0.19	1.013	8.52	0.57	xLS
284.8	BO78[122]	DSG	178.7-117.2	73	73	float		0.991	79.11	1.08	NLS
300.0	DE54[140]	DSG	35.0-175.0	15	16	10.0%	0.01	1.009	28.31	1.77	xxS
304.2	BO78[122]	DSG	178.7-115.7	79	79	float		0.987	78.87	1.00	NLS
307.0	CH67[141]	P	33.1-141.5	8	8	3.0%	0.03	0.995	10.14	1.27	NLS [11]
309.6	BE76[95]	DSG	11.5- 52.1	11	12	10.0%	0.01	0.989	15.25	1.27	NLS
310.0	CA57[142]	P	21.6-164.9	19	18	4.0%	0.12	0.986	9.53	0.53	NLS [12]
312.0	BA93[143]	P	50.2-129.4	24	25	4.0%	2.58	0.940	21.86	0.87	NLS

[9] 144.2

[10] 11.4

[11] 47.8

[12] 53.4 147.7

TABLE V: (continued)

E_{lab}	Ref.	Type	θ	n_1	n_2	sys	χ_{sys}^2	scale	χ_t^2	χ_t^2/n	comments	
312.0	BA94[144]	AZZ	50.2- 89.6	11	12	4.0%	0.08	1.012	18.49	1.54	NLS	
312.0	FO91[145]	SGTL	—	1	1	no systematic error			0.21	0.21	xLx	
314.0	DA02[139]	P	113.0-176.3	14	15	3.0%	0.01	1.003	15.54	1.04	xLS	
315.0	AR00[137]	P	102.0-162.0	16	17	1.2%	0.50	1.009	22.40	1.32	xLS	
315.0	AR00[137]	AYY	78.0-118.0	11	12	3.7%	3.98	1.080	17.57	1.46	xLS	
315.0	AR00[137]	AYY	102.0-162.0	16	17	3.7%	6.46	1.104	27.09	1.59	xLS	
315.0	AR00[137]	AZZ	78.0-118.0	11	12	7.1%	5.62	1.202	26.36	2.20	xLS	
315.0	AR00[137]	AZZ	102.0-162.0	16	17	7.1%	4.38	1.175	24.29	1.43	xLS	
315.0	AN00[138]	D	80.0-120.0	6	7	1.9%	2.43	1.031	6.53	0.93	xLS	
315.0	AN00[138]	D0SK	80.0-120.0	6	7	1.9%	0.50	1.014	9.08	1.30	xLS	
315.0	AN00[138]	DT	80.0-120.0	6	7	1.9%	0.00	1.000	12.50	1.79	xLS	
315.0	AN00[138]	AT	80.0-120.0	6	7	1.9%	0.00	1.000	1.96	0.28	xLS	
315.0	AN00[138]	AT	104.0-162.0	8	9	1.9%	0.00	1.000	6.20	0.69	xLS	
315.0	AN00[138]	RT	80.0-120.0	6	7	1.9%	0.00	1.000	2.22	0.32	xLS	
315.0	AN00[138]	RT	104.0-162.0	8	9	1.9%	0.11	1.006	7.30	0.81	xLS	
315.0	AN00[138]	NNKK	104.0-162.0	8	9	1.9%	0.01	0.998	1.64	0.18	xLS	
315.0	AN00[138]	NSKN	88.0-120.0	5	6	1.9%	0.00	1.001	2.35	0.39	xLS	
315.0	AN00[138]	NSKN	104.0-162.0	8	9	1.9%	0.27	1.010	18.69	2.08	xLS	
315.0	AN00[138]	NSSN	80.0-120.0	6	7	1.9%	0.00	1.001	6.88	0.98	xLS	
315.0	AN00[138]	NSSN	104.0-162.0	8	9	1.9%	0.00	1.000	9.78	1.09	xLS	
318.0	AH98[136]	RT	105.1-159.0	8	9	3.0%	1.28	1.035	6.04	0.67	NLS	
318.0	AH98[136]	AT	105.1-159.0	8	9	3.0%	0.02	1.004	3.11	0.35	NLS	
318.0	AH98[136]	AT	89.2-118.1	5	6	3.0%	0.02	1.004	5.59	0.93	NLS	
318.0	AH98[136]	DT	105.1-159.0	8	9	3.0%	0.02	1.004	10.94	1.22	NLS	
318.0	AH98[136]	DT	89.2-118.1	5	6	3.0%	0.00	1.000	4.07	0.68	NLS	
318.0	AH98[136]	P	105.1-159.0	8	9	2.0%	0.24	1.010	6.03	0.67	NLS	
318.0	AH98[136]	P	89.2-118.1	5	6	2.0%	0.03	1.004	8.28	1.38	NLS	
319.0	KE82[130]	DSG	66.7-177.0	64	65	3.9%	0.24	0.981	79.57	1.22	NLx	
319.0	KE82[130]	DSG	11.1- 94.5	7	8	2.0%	0.55	1.015	5.18	0.65	NLx	
324.1	BO78[122]	DSG	178.8-114.9	81	81	float		0.982	93.97	1.16	NLS	
325.0	AS77[146]	P	44.9-159.4	42	38	12.0%	0.88	0.899	49.19	1.29	NLx [13]	
325.0	AM77[132]	RT	160.5	1	2	3.0%	0.129	1.01	1.92	0.96	NLx	
325.0	AM77[132]	RPT	160.5	1	2	3.0%	0.000	1.00	0.19	0.09	NLx	
325.0	AS77[146]	DT	87.3-149.0	8	9	3.0%	0.00	1.001	4.44	0.49	NLx	
325.0	CL80[131]	P	45.0-159.4	21	18	3.0%	0.35	1.018	21.13	1.17	NLS [14]	
325.0	CL80[131]	DT	84.2-152.9	12	13	3.0%	0.13	1.011	11.74	0.90	NLS	
325.0	AX80[133]	RT	76.8-153.5	9	10	3.0%	0.00	0.998	15.86	1.59	NLS	
325.0	AX80[133]	AT	76.8-144.5	8	9	3.0%	0.03	0.995	5.71	0.63	NLS	
325.0	BA89[134]	AYY	61.9-145.9	19	20	6.8%	0.05	1.015	20.18	1.01	NLS	
325.0	BA89[134]	P	61.9-145.9	19	20	2.5%	0.03	0.996	8.67	0.43	NLS	
343.0	AM77[132]	RT	141.7-167.0	4	4	no systematic error			5.42	1.35	NLS	
343.8	BE76[95]	DSG	11.6- 52.5	11	12	10.0%	0.07	1.027	18.32	1.53	NLS	
344.0	DA02[139]	P	113.0-176.3	14	15	3.0%	0.37	0.982	19.71	1.31	xLS	
344.3	BO78[122]	DSG	179.1-114.1	80	79	float		0.975	77.53	0.98	NLS [15]	
350.0	SI56[147]	P	46.4-158.2	10	9	float		0.979	6.01	0.67	NLR [16]	
350.0	AS62[148]	DSG	114.2-165.1	10	10	float		0.976	15.70	1.57	NLS	
350.0	AS62[148]	DSG	160.7-173.8	7	7	float		0.991	6.89	0.98	NLS	
TOTALS				3563	3788						1.06	

[13] 45.0 50.0 55.0 55.8 60.0

[14] 45.0 50.1 60.3 118.4

[15] 131.5

[16] 46.4

TABLE VI: List of all data not used in the fitting.

E_{lab}	Ref.	Type	θ	n_1	n_2	sys	χ_{sys}^2	scale	χ_t^2	χ_t^2/n	comments
0.5- 2.0	PO82[149]	SGT	—	3	3	no systematic error			25.26	8.42	xLxb
14.1	SU67[150]	DSG	11.9- 92.8	16	16	float		0.997	3.22	0.20	NLSs
16.9	TO88[62]	P	136.5-166.5	4	5	1.0%	0.00	1.000	0.17	0.03	NLSs
29.9	FI90[71]	DSG	104.6-164.9	5	6	10.0%	0.01	1.008	20.67	3.45	NLSb
31.5	BE97[84]	DSG	40.0-140.0	6	7	5.0%	0.01	0.995	54.28	7.75	RLRb
50.0	FI80[94]	P	108.0-174.0	4	5	2.0%	0.00	1.000	0.28	0.06	NLSs
58.5	BE97[84]	DSG	40.0-140.0	6	7	5.0%	0.00	1.002	57.50	8.21	RLRb
63.1	KI80[151]	DSG	39.4-165.8	19	17	3.0%	0.01	0.998	40.44	2.38	NLSb
67.5	GO94[152]	DSG	87.3-172.9	15	16	5.0%	0.09	1.016	47.27	2.95	RLSb
67.7	BE97[84]	DSG	40.0-140.0	6	7	5.0%	0.13	1.018	28.37	4.05	RLSb
88.0-150.9	ME66[153]	SGT	—	6	7	0.1%	0.00	1.000	0.27	0.04	RRSs
152.0	PA71[154]	DSG	77.8-169.3	13	13	float		0.961	76.64	5.90	RRSb
162.0	RA98[155]	DSG	73.0-179.0	54	55	4.0%	0.13	1.014	378.89	6.89	RRRb
199.9	FR00[156]	DSG	81.1-179.3	102	103	5.0%	0.04	1.010	326.47	3.17	RLRb
203.0	RE66[157]	RT	139.0-179.2	5	6	14.0%	0.01	0.989	2.75	0.46	xRSc
212.0	WA62[158]	D	40.0- 80.0	5	5	no systematic error			2.24	0.45	xRSc
212.0	KE82[130]	DSG	88.6-177.4	39	36	3.2%	0.00	1.002	79.50	2.21	NLSb
217.0	TI61[159]	P	40.0-120.0	9	10	12.0%	0.79	1.119	15.99	1.60	xRSc
219.8	FR00[156]	DSG	80.8-179.3	104	105	5.0%	0.20	1.023	1108.80	10.56	RLRb
223.0	AB88[160]	DTRT	161.0	1	2	0.3%	0.000	1.00	11.81	5.90	xRSc
225.0	AX80[133]	RT	161.0	1	2	3.0%	1.512	1.04	2.96	1.48	xRSc
225.0	AX80[133]	RPT	161.0	1	2	3.0%	0.000	1.00	4.42	2.21	xRRc
240.2	FR00[156]	DSG	80.6-179.3	107	108	5.0%	0.36	1.031	903.59	8.37	RLRb
247.2-344.3	DE73[161]	SGT	—	4	5	0.2%	1.56	0.998	54.04	10.81	RLRb
260.0	AN00[138]	D	104.0-160.0	8	9	2.4%	9.90	1.082	30.50	3.39	xLSb
260.0	AN00[138]	D0SK	104.0-160.0	8	9	2.4%	23.25	1.131	38.95	4.33	xLSb
261.9	FR00[156]	DSG	80.3-179.2	108	109	5.0%	0.58	1.040	823.93	7.56	RLRb
280.0	FR00[156]	DSG	80.1-179.2	109	110	5.0%	2.80	1.091	2117.63	19.25	RLRb
300.2	FR00[156]	DSG	79.8-179.2	111	112	3.1%	10.73	1.113	632.15	5.64	RLRb
315.0	AR00[137]	P	78.0-118.0	11	12	1.2%	2.07	1.018	33.36	2.78	xLSb
315.0	AN00[138]	D	104.0-162.0	8	9	1.9%	12.10	1.071	47.53	5.28	xLSb
315.0	AN00[138]	D0SK	104.0-162.0	8	9	1.9%	18.99	1.090	36.33	4.04	xxSb
320.1	FR00[156]	DSG	79.5-179.2	110	111	2.7%	13.37	1.110	936.42	8.44	RLRb
325.0	AB88[160]	DTRT	160.5	1	2	0.3%	0.597	1.00	138.12	69.06	xLSc
325.0-350.0	BY87[162]	SGTR	—	2	2	no systematic error			0.82	0.41	xxR?
325.0	BA89[134]	P	61.9-145.9	19	20	4.3%	0.05	0.990	5.55	0.28	NLSs
332.5	AX80[133]	RT	160.5	1	2	3.0%	2.787	1.05	5.42	2.71	xRSc
332.5	AX80[133]	RPT	160.5	1	2	3.0%	0.000	1.00	2.85	1.42	xRRc
337.0	BA89[134]	RT	160.5	1	1	no systematic error			11.50	11.50	xRSb
340.0	FR00[156]	DSG	79.3-179.2	112	113	2.4%	14.85	1.102	807.49	7.15	RLRb
TOTALS				1153	1180					7.55	

might expect at most *one* set to lie either above or below the 3σ limits (i.e. $393 \times 0.0027 \simeq 1$), and these would most likely lie close to the boundaries, where there are already several sets. The plot shows graphically that most of the data sets excluded for statistical reasons lie way outside of the 3σ limits, and it appears to be clearly justified to discard them.

Applying these criteria to our complete data set, with $n = 3788$, gives 3σ rejection limits of $0.937 \leq z \leq 1.065$. Our best fit just lies within these limits, allowing us to conclude that the overall fit itself satisfies the 3σ criterion.

The comment column of Table VI gives a four character symbol that details information about the data that

have been skipped. The *first* character is either N, R, or x, where N denotes a data set that was used in the Nijmegen/Machleidt fits [6, 8], R a set that was rejected, and x a set that was not listed. The second character is either L, R, or x, where L denotes a data set that is listed in NN-OnLine, the Nijmegen online data base [10], R a set listed there but labeled for rejection, and x a set that is not listed. The third character is either S, R, or x, where S denotes a data set that is listed in the 2005 SAID data base [9], R a set listed there but labeled for rejection, and x a set that is not listed. Finally, the fourth character is either b, s, c, or ?, where b means that its χ^2 is too large (as discussed above), s means that the χ^2 is too small, c means that the measurement is from a com-

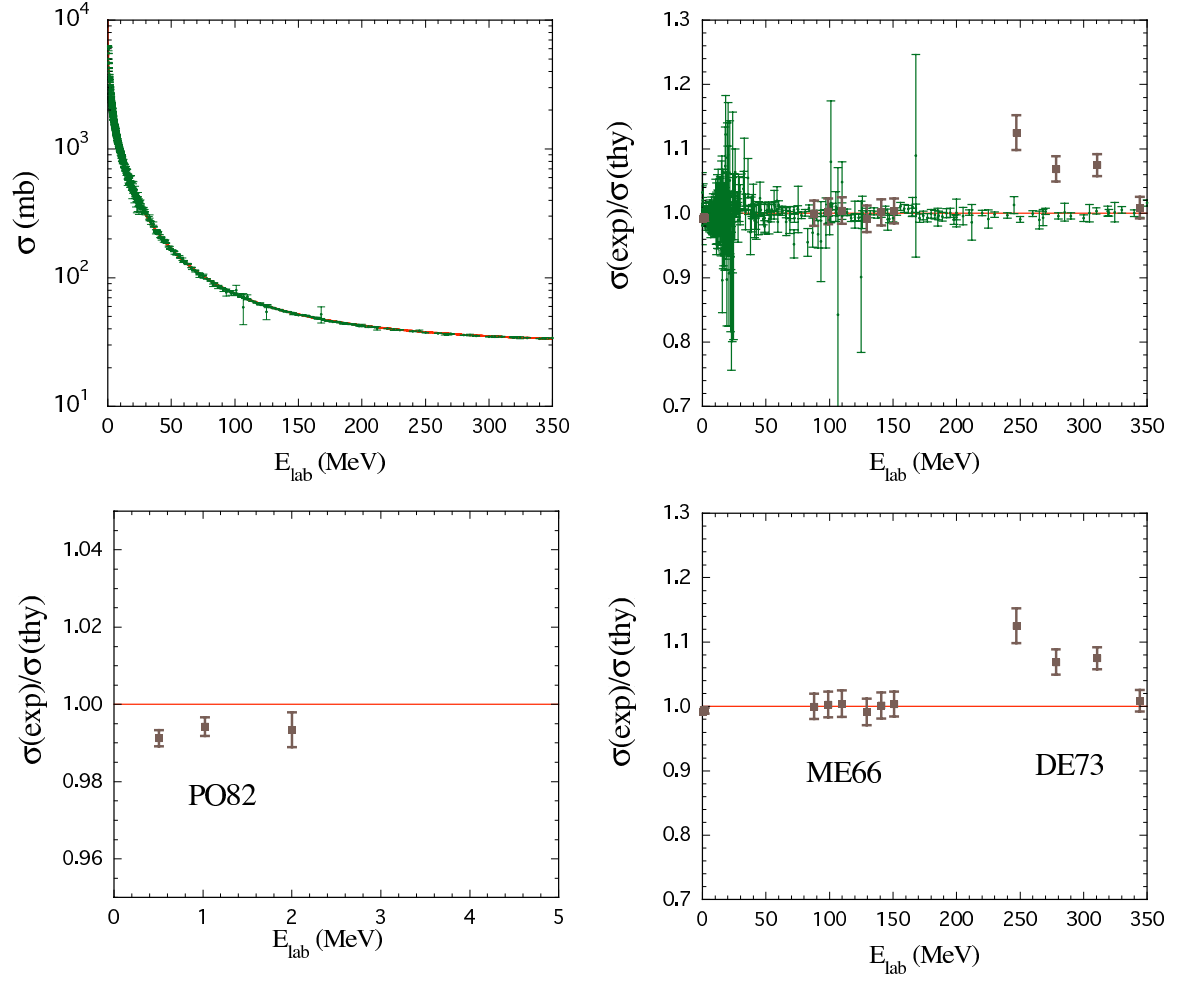

FIG. 5: (Color on line) Total cross section as a function of lab energy. The lower two panels compare the three rejected cross section data sets, PO82 [149] (shown in the lower left panel on an expanded energy scale, and also in the lower right panel as three indistinguishable points near zero), ME66 [153], and DE73 [161] with theory. The very small χ^2 for ME66 is due to an overestimate of the errors (not consistent with the expected statistical fluctuations) while the other data sets disagree strongly with the fit (theory), and all three sets lie well outside the boundaries (see their locations on Fig. 4). The solid line is the fit (referred to as the theory).

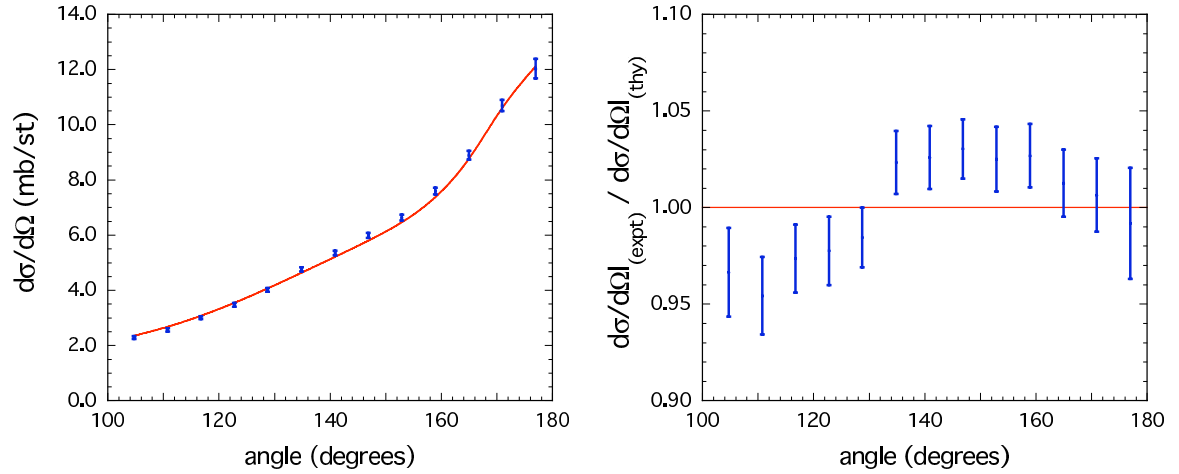

FIG. 6: (Color on line) Example of the quality of the fit to some recent 194 MeV differential cross section data [126].

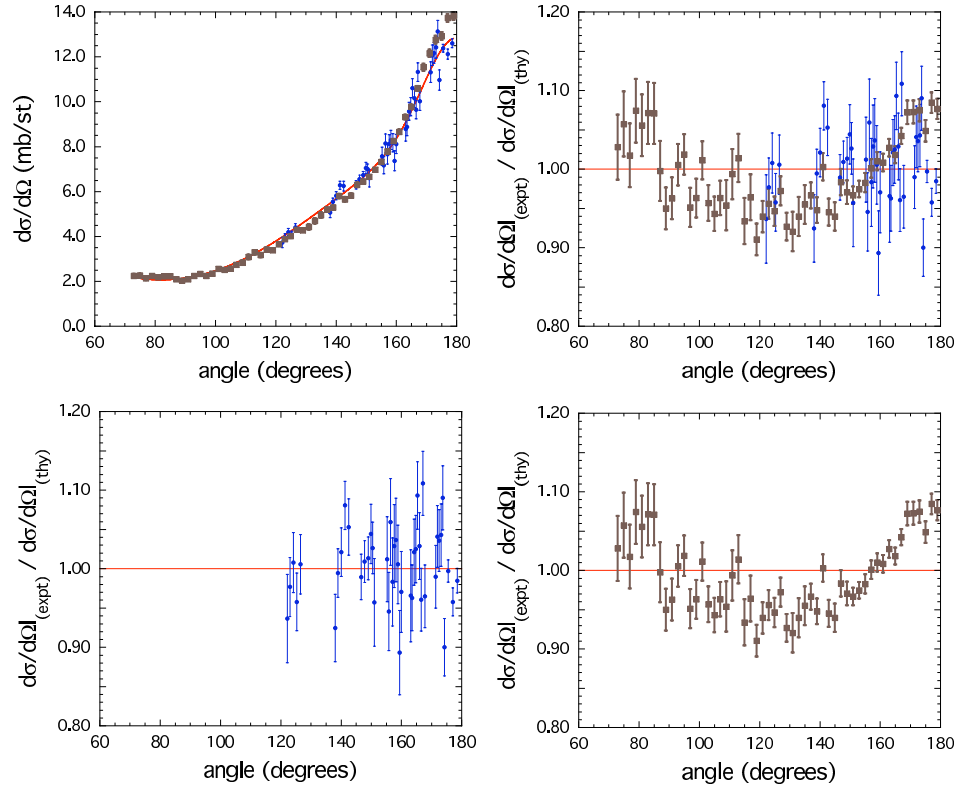

FIG. 7: (Color on line) Differential cross section measurements at 162 MeV [122, 155]. The upper two panels show both data sets, the lower-left panel shows only the data set BO78 [122] which is kept, the bottom-right panel only the data set RA98 [155] which is excluded. RA98 seems to have some unexplained systematic error, particularly at the backward angles, giving it the wrong shape and a large χ^2/n of 6.9.

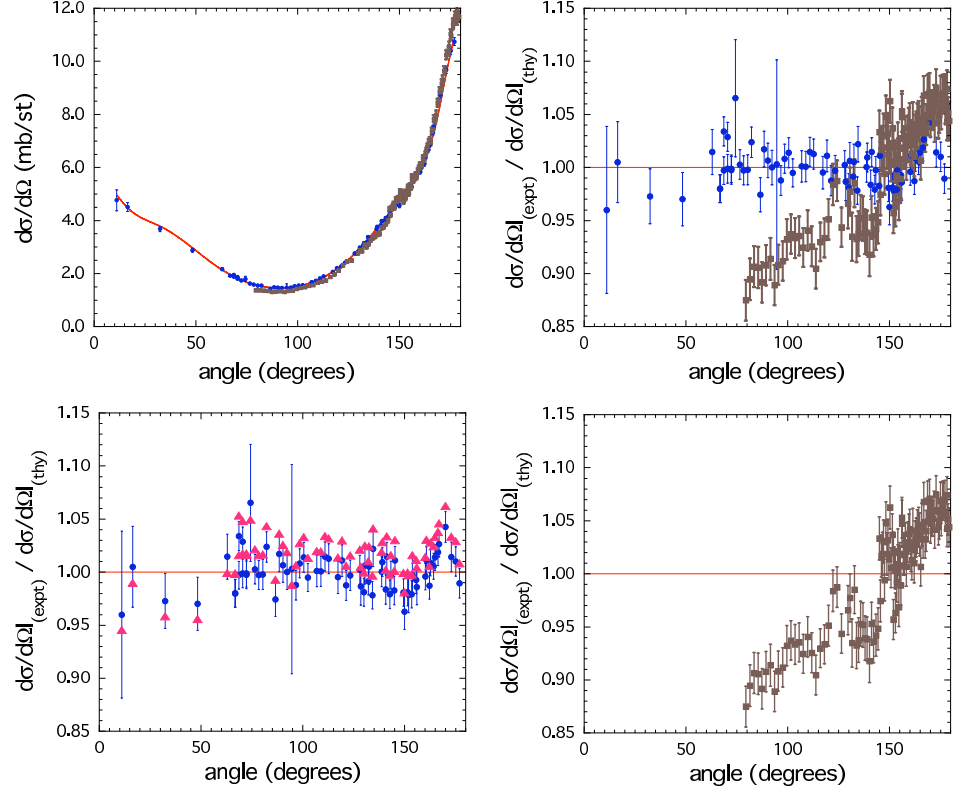

FIG. 8: (Color on line) Differential cross section measurements at 319 MeV [130] and 320.1 MeV [156]. The data set FR00 [156] shown in the bottom-right panel is excluded; do to some large unexplained systematic error it has the wrong shape and a large χ^2/n of 8.4. The lower-left panel shows the effect of scaling on the KE82 data [130], as discussed in the text. In this panel the triangles are *unscaled* data not shown in the upper panels; the small circles are scaled data shown also in the upper panels.

posite target (and hence subject to unknown theoretical errors), and ? means that the data set is questionable for other reasons. Hence, for example the 50 MeV polarization measurements of FI80 have the label NLSs, meaning that they are listed in all the data bases, but we have rejected them because their χ^2 is too small (below the minimum line in Fig. 3). Similarly, the 340 MeV differential cross section measurements of FR00 carries the notation RLRb, meaning that it was rejected by Machleidt and SAID, listed without comment in the NN-OnLine data base, and rejected here because its χ^2 is too large (above the maximum line in Fig. 3).

The same code is used for comments, when available, for data sets used in the fit (shown in Table VI). For example, the cross section measurements from 0.5 to 24.6 MeV of CL72 contain the comment RRS, meaning that they were rejected in the Nijmegen/Machleidt fits and NN-OnLine, and listed without comment in SAID. We have kept these data because their $\chi^2/n_2 = 1.21$ lies within the statistically acceptable range for a data set with 115 points, although this decision clearly increases the χ^2 of the overall fit.

Next, we take a brief look at the statistical distribution of the 18 large data sets with more than 50 points each. Together these total 1607 measurements, and also include the bulk of the rejected data (926 out of 1180). The distribution of these 18 sets is shown in Fig. 4, which compares the histogram of distributions with the theoretical distributions for data sets with $n = 100$ and $n = 60$ points. The figure shows clearly how the 9 sets with large χ^2 lie way beyond the region that is probable, while the 9 sets that have been used in the fit satisfy a reasonable distribution (but still skewed slightly toward χ^2 that are too large). If we had only these large data sets to work with, it might not be clear that we have rejected the right data, but it is important to realize that the overall fit is largely fixed by the large number of data in *smaller* sets, which number 3107 out of all the 3788 data which are kept.

The rejection of data is couched in statistical terms, but examination of actual data sets shows that the “judgement” of statistics agrees with one’s intuitive notions. To get a feeling for how rejected data compare with the *whole* data set, and to see how good the fits really are, we look at a few examples illustrated in Figs. 5, 6, 7, and 8. Figure 5 shows the fit to total cross section data. The rejected data has not been included in the upper left panel, showing how close the data is to the fit. The lower two panels show the three rejected cross section data sets, and one can easily see why the χ^2 of the sets PO82 and DE73 is too high. On the other hand, the set ME66 illustrates a situation in which the χ^2 is too low: the actual scatter of the data around the theoretical line is much smaller than is to be expected from the size of experimental error bars. In this case the data seem perfectly consistent with the fit, but it seems that there is something wrong with the error estimates so that the set cannot be used to properly constrain the fit. As

an example of the overall quality of the fit, Fig. 6 shows how consistent the new 194 MeV differential cross section measurements [126] are with the rest of the data. Finally, Figs. 7 and 8 show measurements of the differential cross sections in the backward directions at 162 and 320 MeV. In each of these cases, one data set is consistent with the fit, and one is inconsistent. The reasons are similar in both cases; the inconsistent data sets seem to have some unexplained angular dependent systematic error in the backward direction which disagrees with the rest of the data base (as represented by the fit). The data sets at 162 and 320 MeV are certainly inconsistent with each other, and we emphasize that we can only decide which of these sets to include and which to exclude because of the presence of *all of the other data*.

Finally, we discuss systematic errors and how they are treated. As specified by the experimentalists, data may have a specified systematic error, no systematic error (absolute measurements), or an arbitrarily large systematic error (floated data). In all cases the χ_t^2 for a data set can be written

$$\chi_t^2 = \sum_{i=1}^n \frac{(Z o_i - t_i)^2}{(Z \delta o_i)^2} + \frac{(Z - 1)^2}{(\delta_{\text{sys}})^2} \quad (4.4)$$

where o_i and t_i are the measured and calculated value of the observable at point i , δo_i and δ_{sys} are the statistical errors at point i and the systematic error, and Z is a factor by which the data and errors are scaled to improve agreement with theory. The last term in (4.4) is denoted χ_{sys}^2 . The value of Z is chosen to minimize χ_t . Data with no systematic error cannot be scaled ($Z = 1$, so χ_{sys}^2 is zero), data that floats could be treated using (4.4) with $\delta_{\text{sys}} = \infty$ so that $\chi_{\text{sys}}^2 = 0$ no matter what the value of Z , and data with a specified systematic error generally fit the theory best if $Z \neq 1$ giving a value of $\chi_{\text{sys}}^2 > 0$ (as shown in the tables). In this case the term χ_{sys}^2 is a new contribution to the overall error and is counted as a new data point.

The lower-left panel of Fig. 8 illustrates how data with systematic error are adjusted to improve the fit. At 319 MeV, KE82 [130] measured the differential cross section over an angular range from 11.1 to 94.5 degrees with an estimated systematic error of 2%, and over an angular range from 66.7 to 177 degrees with an estimated systematic error of about 4%. These errors permit us to scale these two data sets independently in order to get the best fit to the data, and as reported in Table V, the result scales the data in the first range by $Z = 1.015$, and in the second by $Z = 0.981$. These shifts give a small additional χ_{sys}^2 of 0.55 and 0.24, respectively. In the figure the solid triangles show the data *before* scaling, and the solid circles (centered on the error bars) show the data *after* scaling. Close examination of the figure shows how these small shifts improve the overall fit.

TABLE VII: Isoscalar and 1S_0 np phase shifts for Model WJC-1.

E_{lab}	1S_0	1P_1	3S_1	3D_1	ϵ_1	3D_2	1F_3	3D_3	3G_3	ϵ_3	3G_4	1H_5	3G_5	3I_5	ϵ_5	3I_6
1	62.071	-0.196	147.644	0.007	0.111	0.006	0.000	-0.005	0.005	-0.001	0.000	0.000	-0.003	0.003	0.000	0.000
5	63.608	-1.561	117.998	-0.163	0.685	0.231	-0.012	-0.009	0.011	0.012	0.001	0.000	-0.008	0.007	-0.001	0.000
10	59.885	-3.202	102.408	-0.664	1.172	0.880	-0.068	-0.008	0.013	0.082	0.014	-0.002	-0.011	0.011	0.001	0.000
25	50.631	-6.701	80.398	-2.836	1.780	3.855	-0.432	0.033	-0.029	0.566	0.176	-0.032	-0.025	0.014	0.037	0.012
50	39.911	-10.289	62.498	-6.567	2.072	9.285	-1.155	0.308	-0.231	1.652	0.744	-0.169	-0.072	0.000	0.209	0.093
75	31.944	-12.907	51.264	-9.809	2.257	13.988	-1.770	0.784	-0.545	2.681	1.470	-0.353	-0.132	-0.037	0.459	0.243
100	25.468	-15.139	42.838	-12.578	2.469	17.699	-2.270	1.345	-0.923	3.563	2.238	-0.544	-0.187	-0.094	0.736	0.436
125	19.957	-17.149	36.004	-14.968	2.722	20.473	-2.689	1.910	-1.336	4.298	3.003	-0.725	-0.230	-0.165	1.017	0.653
150	15.137	-19.001	30.222	-17.058	3.005	22.448	-3.062	2.426	-1.764	4.903	3.744	-0.891	-0.257	-0.246	1.290	0.882
175	10.825	-20.723	25.155	-18.906	3.315	23.775	-3.413	2.865	-2.192	5.396	4.451	-1.039	-0.269	-0.335	1.550	1.118
200	6.899	-22.332	20.573	-20.561	3.657	24.585	-3.757	3.214	-2.611	5.799	5.119	-1.173	-0.268	-0.429	1.796	1.355
225	3.291	-23.843	16.370	-22.059	4.020	24.986	-4.105	3.470	-3.015	6.127	5.747	-1.292	-0.255	-0.527	2.027	1.590
250	-0.050	-25.271	12.471	-23.431	4.394	25.064	-4.464	3.635	-3.400	6.395	6.331	-1.400	-0.233	-0.628	2.243	1.822
275	-3.160	-26.629	8.834	-24.698	4.767	24.885	-4.838	3.712	-3.762	6.614	6.872	-1.498	-0.203	-0.729	2.444	2.050
300	-6.065	-27.930	5.441	-25.868	5.120	24.504	-5.228	3.708	-4.099	6.794	7.368	-1.590	-0.168	-0.831	2.631	2.272
325	-8.807	-29.181	2.183	-26.967	5.477	23.962	-5.635	3.630	-4.408	6.943	7.822	-1.676	-0.130	-0.932	2.804	2.488
350	-11.403	-30.390	-0.962	-28.005	5.833	23.293	-6.058	3.486	-4.690	7.067	8.233	-1.758	-0.091	-1.032	2.966	2.698

TABLE VIII: Isovector (except the 1S_0) np phase shifts for Model WJC-1.

E_{lab}	3P_0	3P_1	1D_2	3P_2	3F_2	ϵ_2	3F_3	1G_4	3F_4	3H_4	ϵ_4	3H_5	1J_6	3H_6	3J_6	ϵ_6
1	0.206	-0.100	0.001	0.017	0.007	-0.003	0.000	0.000	-0.004	0.004	0.000	0.000	0.000	-0.003	0.003	0.000
5	1.630	-0.869	0.039	0.259	0.018	-0.049	-0.004	0.000	-0.009	0.009	-0.001	0.000	0.000	-0.006	0.006	0.000
10	3.614	-1.918	0.147	0.744	0.033	-0.176	-0.024	0.002	-0.012	0.013	-0.004	0.000	0.000	-0.009	0.009	-0.001
25	8.036	-4.570	0.640	2.672	0.122	-0.714	-0.183	0.030	-0.003	0.023	-0.038	-0.010	0.002	-0.014	0.014	-0.003
50	10.605	-7.868	1.627	6.010	0.342	-1.540	-0.568	0.125	0.077	0.048	-0.159	-0.064	0.016	-0.015	0.022	-0.021
75	10.117	-10.587	2.671	8.754	0.577	-2.104	-0.948	0.243	0.231	0.084	-0.310	-0.149	0.042	-0.008	0.030	-0.053
100	8.348	-13.066	3.706	10.820	0.788	-2.443	-1.283	0.370	0.442	0.129	-0.463	-0.247	0.074	0.007	0.041	-0.095
125	6.053	-15.416	4.685	12.318	0.957	-2.617	-1.575	0.502	0.694	0.179	-0.610	-0.349	0.110	0.029	0.054	-0.142
150	3.564	-17.675	5.577	13.378	1.071	-2.675	-1.835	0.639	0.969	0.232	-0.747	-0.448	0.147	0.060	0.068	-0.191
175	1.028	-19.863	6.364	14.109	1.124	-2.653	-2.071	0.779	1.257	0.288	-0.872	-0.543	0.185	0.098	0.084	-0.240
200	-1.470	-21.985	7.037	14.594	1.112	-2.576	-2.295	0.922	1.549	0.344	-0.984	-0.632	0.223	0.143	0.101	-0.289
225	-3.891	-24.046	7.594	14.890	1.036	-2.462	-2.511	1.068	1.835	0.398	-1.085	-0.715	0.262	0.193	0.118	-0.337
250	-6.216	-26.051	8.037	15.036	0.896	-2.325	-2.726	1.214	2.112	0.450	-1.175	-0.792	0.301	0.249	0.137	-0.384
275	-8.438	-28.004	8.374	15.062	0.697	-2.173	-2.944	1.361	2.375	0.497	-1.253	-0.864	0.341	0.310	0.156	-0.428
300	-10.542	-29.911	8.612	14.988	0.441	-2.015	-3.165	1.506	2.622	0.540	-1.321	-0.930	0.381	0.374	0.176	-0.471
325	-12.542	-31.776	8.760	14.839	0.135	-1.854	-3.393	1.649	2.852	0.576	-1.380	-0.993	0.421	0.442	0.196	-0.512
350	-14.435	-33.601	8.824	14.627	-0.218	-1.694	-3.627	1.790	3.064	0.605	-1.429	-1.052	0.462	0.511	0.216	-0.552

V. PHASE SHIFTS AND LOW-ENERGY PARAMETERS

Numerical values of the phase shifts for Model WJC-1 are given in Tables VII and VIII, and the phase shifts for both models are compared to the Nijmegen 1993 phases in Figs. 9, 10, and 11.

Note that the $J = 4$ phases are very similar, but there are significant differences (a few degrees in many cases) between the three sets of phases for $J \leq 3$ (except that all three sets give a nearly identical ϵ_3). For all but the 3P_0 and 1P_1 phases, there is a tendency for our two models to agree (or at least have the same shape) and differ from the Nijmegen phases. This is especially true of the 1S_0 , $^3S_1 - ^3D_1$, 1D_2 , 3D_2 , $^3P_2 - ^3F_2$, 1F_3 , and $^3D_3 - ^3G_3$ phases, where our two models are much closer (identical in some cases) than the separation from the Nijmegen phases. In other cases this trend is less clear. The 3P_1

and ϵ_1 phases are less close together and only depart from Nijmegen above 100 MeV, while WJC-1 and WJC-2 straddle the the Nijmegen 3F_3 and ϵ_2 phases, showing a clearly different trend only above 200 MeV. This universal pattern is broken by the 3P_0 and 1P_1 phases. The Nijmegen 3P_0 phase is very close to WJC-1 up to a cross over point about 200 MeV, where it then tracks Model WJC-2. The differences in the 1P_1 phases are small, but in the neighborhood of 200 MeV, the WJC-1 and Nijmegen models are very close together and clearly distinct from WJC-2.

We were surprised that the phase shifts for Model WJC-1 (which we regard as a new, accurate NN phase shift analysis) were not in closer agreement with the Nijmegen phases. In the beginning we thought it would be sufficient to fit our model to the Nijmegen phases, and then calculate the χ^2 in a second step, without further fitting. Our early models did not give a very good fit to

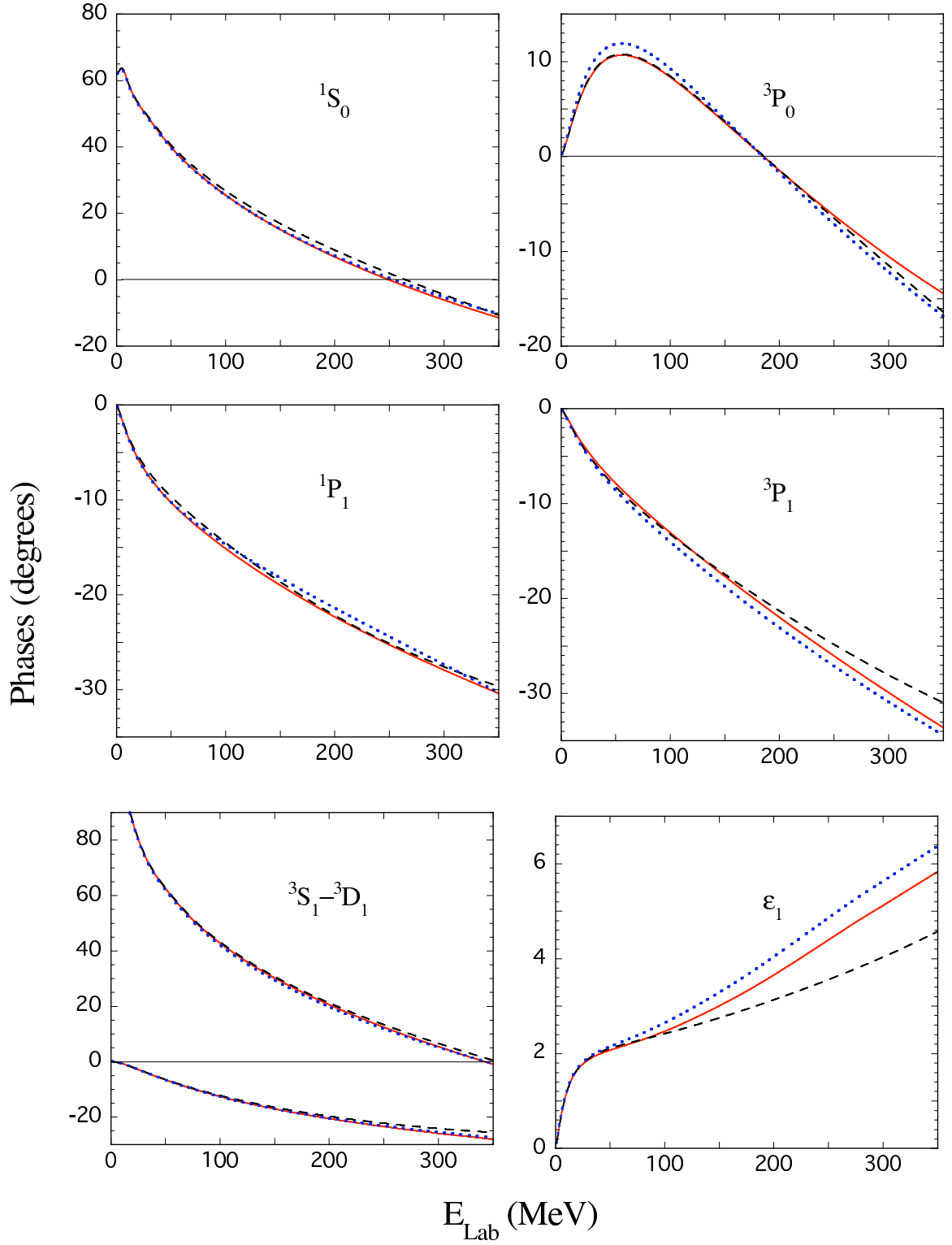

FIG. 9: (Color on line) Phase shifts and mixing parameters for all states with $J \leq 1$. Models WJC-1 (solid line) and WJC-2 (dotted line) are compared to the Nijmegen phases (dashed line).

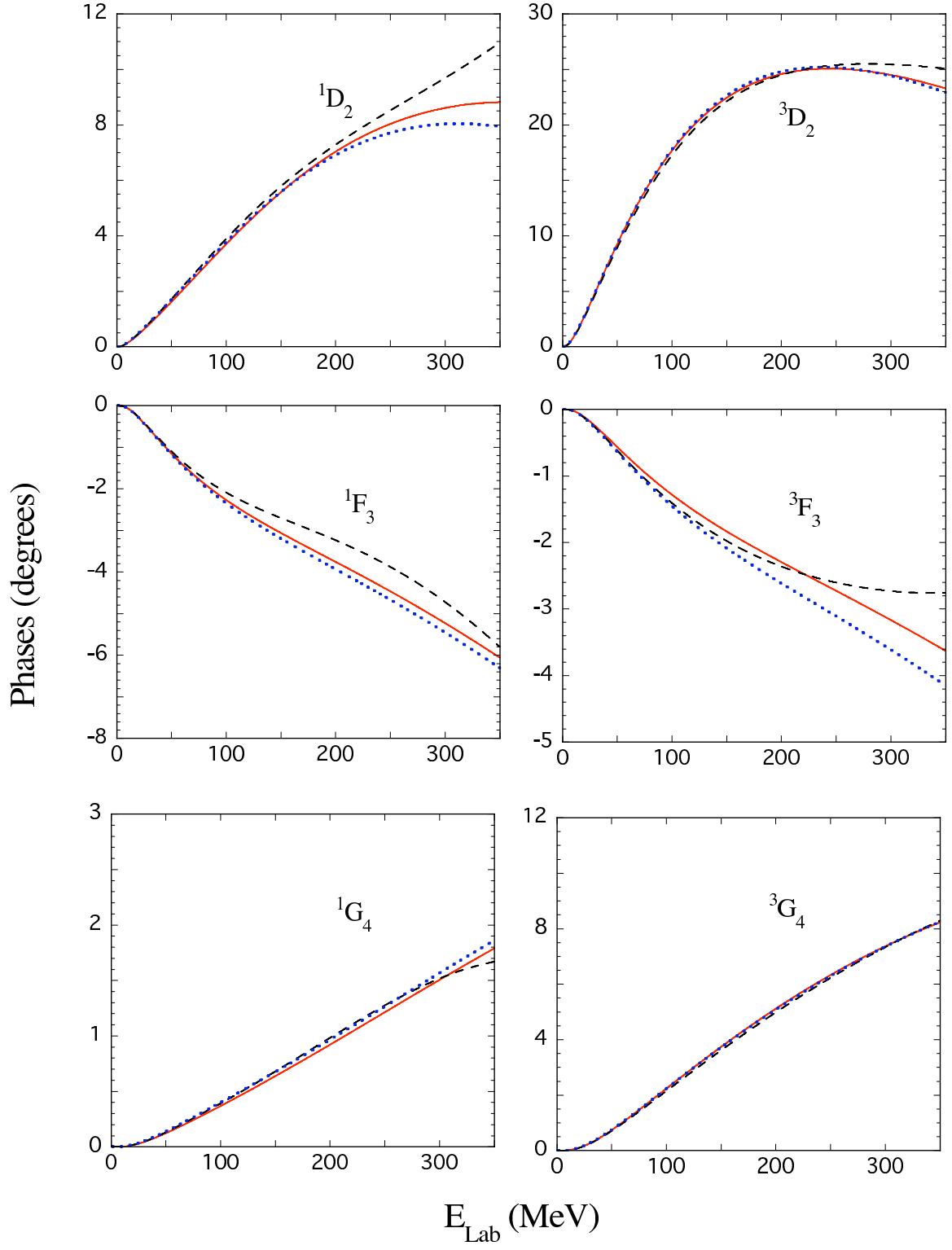

FIG. 10: (Color on line) Singlet and uncoupled triplet phase shifts for all states with $2 \leq J \leq 4$. Curves are drawn as in Fig. 9.

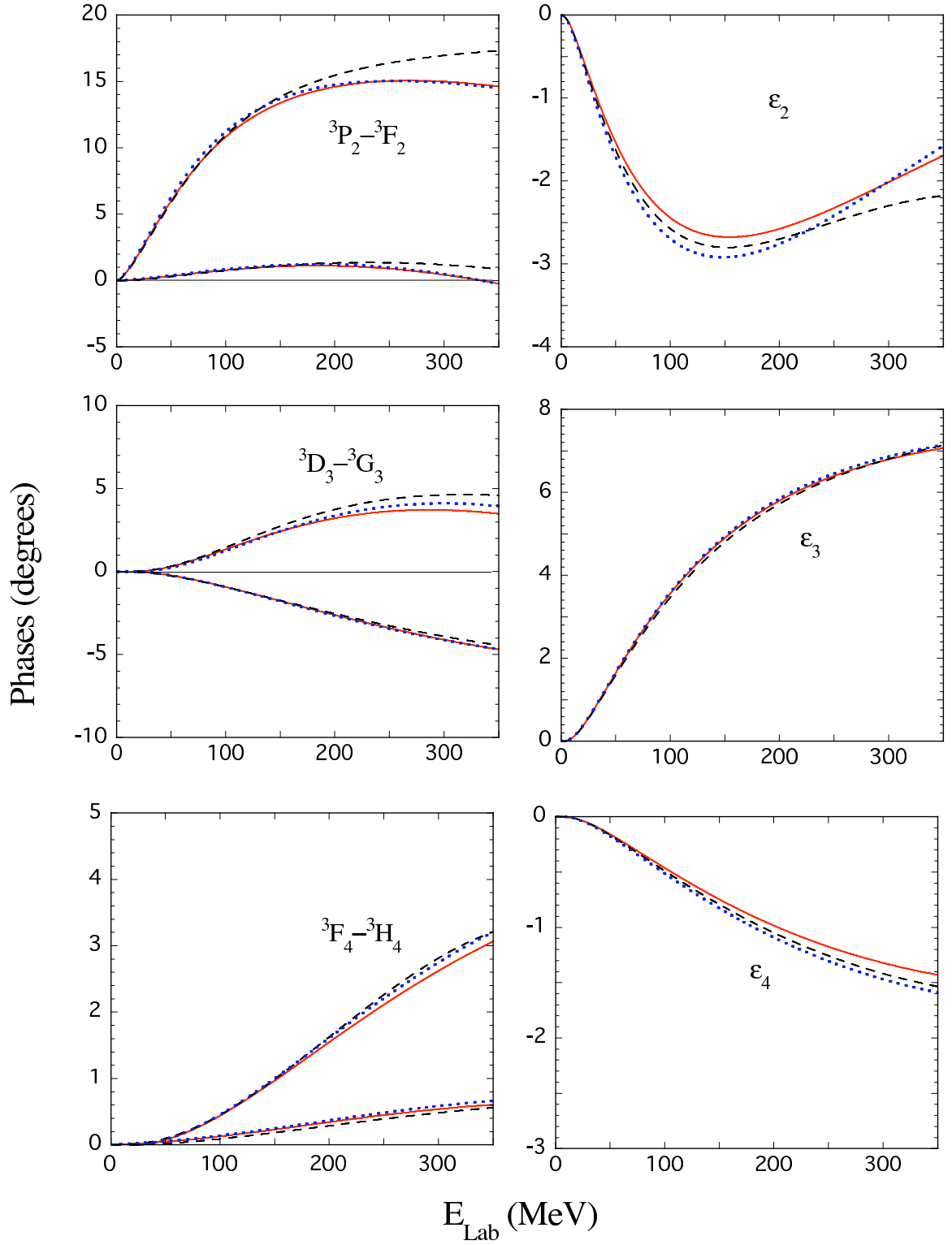

FIG. 11: (Color on line) Triplet coupled phase shifts and mixing parameters for states with $2 \leq J \leq 4$. Curves are drawn as in Fig. 9.

the Nijmegen phases, and we assumed that our higher $\chi^2/N_{\text{data}} \sim 2$ was due to this deficiency. Later, our fits to the Nijmegen phases improved, and we also developed the capability to fit the data directly. We then discovered

that, starting from a good fit to the Nijmegen phases and fitting the data in a second step, not only lead to significant improvement in the χ^2 , but also to a region away from the best fit to the Nijmegen phases. Eventually,

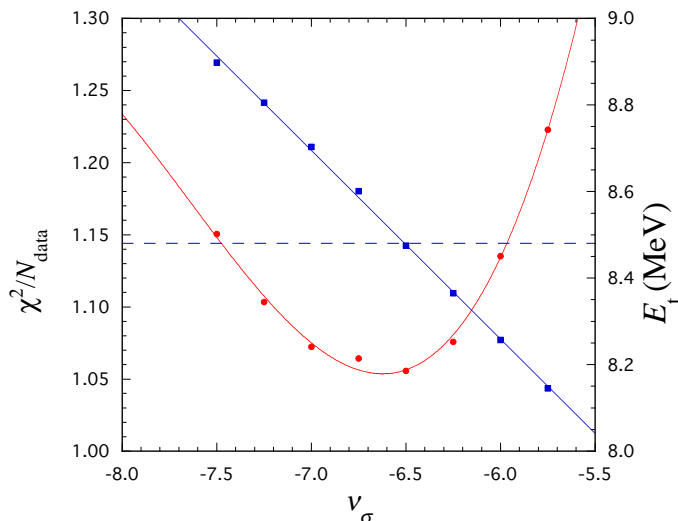

FIG. 12: (Color on line) The family of WJC-1 models with ν_{σ_0} constrained to various fixed values. The left-hand axis shows the best χ^2/N_{data} that can be found for each value of ν_{σ_0} (the data shows some scatter with respect to the solid line, which is a cubic fit to the 8 cases shown), and the right hand axis shows the triton binding energy (E_t in MeV) for each member of the family. Note that the correct binding energy (shown by the dashed horizontal line) is obtained for the value of ν_{σ_0} that also gives the best fit to the data.

as we acquired more experience and skill with the fits, we realized that it was counterproductive to fit the Nijmegen phases too accurately; improving the accuracy of the fit to the phases only lead us away from the best fit to the data. When we started using the WJC-1 phases as a first step in future fits (such as Model WJC-2), this problem vanished and a good fit to the phases assured a good fit to the data. We conclude that the WJC-1 phases are more accurate, and that any discrepancy between the fits to the phases and the fits to the data will be greatly reduced if the WJC-1 phases are used.

VI. THE THREE-BODY BINDING ENERGY

The covariant OBE models of the NN interaction presented in this paper possess a remarkable property: they can explain the three-body binding energy of the triton, naturally and without additional assumptions. This result, first reported in Ref. [12], might have appeared to be an accident. Now that we also see it for the more accurate models reported here, we believe it to be a robust feature of the covariant spectator theory, for which there might be a simple explanation (but at this time we have not found it).

The result is shown in Figs. 12 and 13. For both models we have found that both the triton binding energy E_t and the quality of the fit (as measured by χ^2/N_{data}) are particularly sensitive to the off-shell coupling ν_{σ_0} of the σ_0 meson. For Model WJC-1, the best fit gave $\nu_{\sigma_0} = -6.5$ (cf. Table II) and this is confirmed by fixing ν_{σ_0} at var-

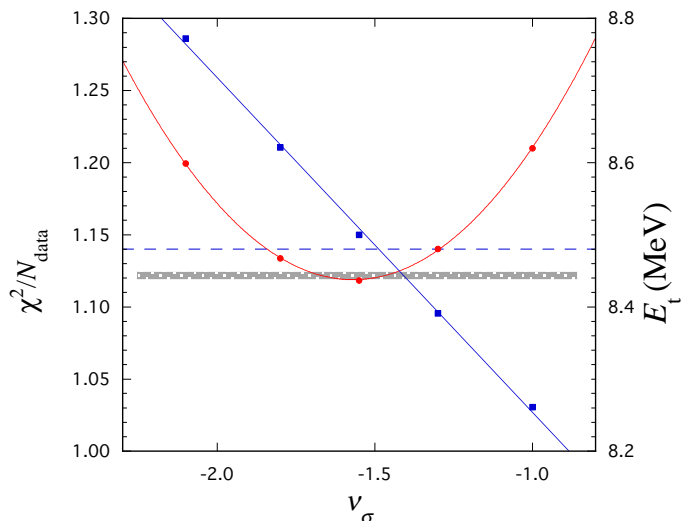

FIG. 13: (Color on line) The family of WJC-2 models with ν_{σ_0} constrained to various fixed values. Here the fit to χ^2/N_{data} is a quadratic, and the binding energy for the best case, 8.50, is shifted slightly from the experimental value. However, shifting ν_{σ_0} by about 0.05 should give exact agreement with the binding energy, and this shift changes χ^2/N_{data} by less than 0.003 (one standard deviation for about 3500 data, shown as a shaded band on the figure). (See the caption to Fig. 12 for further explanation.)

ious values and refitting (by allowing *all* of the parameters *except* ν_{σ_0} to vary). The triton binding energy is approximately linear in ν_{σ_0} , and the figure shows that the value of ν_{σ_0} that gives the experimental value of -8.48 *also* gives the best fit to the two-body data. An identical conclusion holds for Model WJC-2, as shown in Fig. 13.

Nonrelativistic calculations of the triton binding cannot reproduce the experimental results without adding a three-body force. How can our results be consistent with this well known observation? The answer, discussed first in Ref. [12] and later in various conference talks, depends on how the three-body force is defined.

As an example, consider two successive emissions (or absorptions) of a scalar meson from an off-shell nucleon. The interactions along the nucleon line will include cross terms of the form

$$\begin{aligned} & \Lambda(p_3, p_2)S(p_2)\Lambda(p_2, p_1) \\ &= -\frac{g_\sigma\nu_\sigma}{2m} \left\{ (m - \not{p}_2) \frac{H^2(p_2)}{m - \not{p}_2} + \frac{H^2(p_2)}{m - \not{p}_2} (m - \not{p}_2) \right\} \\ &= -\frac{g_\sigma\nu_\sigma}{m} H^2(p_2). \end{aligned} \quad (6.1)$$

This is equivalent to a contact interaction [with the form factor $H^2(p_2)$] as illustrated in Fig. 14. Successive applications of this affect will generate an infinite number of multi-loop contributions to two and three-body forces. A few of the simplest cases are shown in Figs. 15 and 16.

Clearly, off-shell OBE couplings, when iterated to all orders, generate an infinite series of effective two and three-body force diagrams (and n -body forces for the n -body problem) involving loops and effective contact

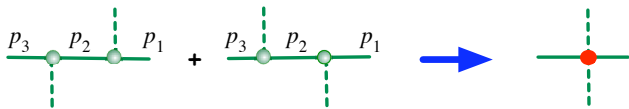

FIG. 14: (Color on line) Diagrams showing the collapse of off-shell interactions into an effective contact interaction, as derived in Eq. (6.1).

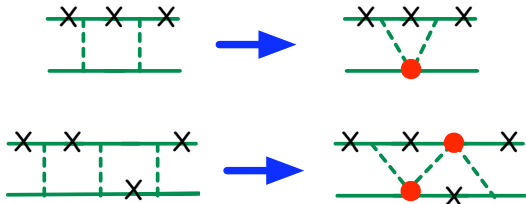

FIG. 15: (Color on line) Examples, from the two-body sector, of one and two-loop diagrams generated by iteration of *off-shell OBE* couplings. The off-shell couplings *automatically* generate these diagrams, but the same result could be obtained from a theory *without* off-shell couplings if these diagrams (and an infinite number of others) were added explicitly to the two-body force. The lines marked with an \times are on-shell particles and in each case a mechanism similar to that shown in Fig. 14 collapses the off-shell propagation to a point.

interactions. If *all* of the diagrams so generated could be calculated explicitly, and added as separate two and three-body forces, then it would be possible to remove the off-shell couplings from the OBE kernels without altering any results. There is a correspondence theorem,

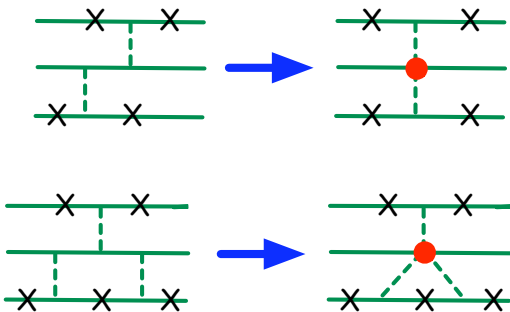

FIG. 16: (Color on line) Examples, from the three-body sector, of no-loop and one-loop diagrams generated by iteration of *off-shell OBE* couplings. The off-shell couplings *automatically* generate these diagrams, but the same result could be obtained from a theory *without* off-shell couplings if these diagrams (and an infinite number of others) were added explicitly to the three-body force. The lines marked with an \times are on-shell particles and in each case a mechanism similar to that shown in Fig. 14 collapses the off-shell propagation to a point.

or a duality relation, which can be stated as follows: *a pure OBE theory with off-shell OBE couplings is equivalent to another theory with an infinite number of two and three-body forces but no off-shell OBE couplings.* So the existence of three-body forces depends on the structure of the two-body interactions, and cannot be uniquely defined.

In conclusion: Figs. 12 and 13 show that the effective two and three-body forces that depend on ν_{σ_0} are related in such a way that a *single* value of ν_{σ_0} gives *both* two-body loop contributions that give the best fit to the two-body data *and* three-body forces that fit the triton binding energy. This result is a robust consequence of the spectator theory, but its origin is not understood.

VII. CONCLUSIONS AND OUTLOOK

In this paper we use the covariant spectator theory (CST) with a simple one-boson exchange (OBE) kernel to fit np scattering data for laboratory energies below 350 MeV. We present two precision fits to the data. One model, designated WJC-1, has 27 parameters and fits the 2007 data base with a $\chi^2/N_{\text{data}} = 1.06$ for $N_{\text{data}} = 3788$ data. A second model, with many parameters fixed at physical values, has only 15 free parameters and fits with a $\chi^2/N_{\text{data}} = 1.12$, as good as the fit of the 1993 Nijmegen phase shifts to the 2007 data base. Both of these models have a simple one-boson exchange structure without any special partial-wave-dependent parameters, and have far fewer parameters than have been needed for previous high precision fits. The fit from our best model WJC-1 automatically produces a new, accurate NN phase shift analysis, useful even outside of the context of the CST.

In carrying out this study, we have updated the np database by adding published data up through 2006 not previously included in any other fits, and doing an independent evaluation of which data are to be excluded and which are to be retained. As a result, our database includes more data than used by the Nijmegen group in their famous 1993 partial wave analysis, or by the Idaho group in their construction of the CD-Bonn potential.

Using the three-body CST equations, the binding energy of the triton can be calculated from the NN scattering amplitude. A remarkable feature of this calculation is that the *correct* binding energy emerges automatically from the best fit to the two-body data, *without need for any additional three-body forces.* This result is due to the presence of off-shell couplings for the scalar meson exchanges that are part of the kernel. The same result could be obtained using a kernel without such off-shell couplings, provided an infinite number of two-body loop diagrams of a particular structure were added to the two-body kernel, and an infinite number of three-body force diagrams of a corresponding structure were added to the three-body equations. The off-shell scalar couplings are therefore a remarkably efficient way to unify and improve both the description of the two- and three-body

systems without departing from a kernel with a simple OBE structure.

The next task is to see if it is possible to construct a nonrelativistic, phase equivalent potential, that, when inserted into a Schrödinger equation, will give the same phase shifts as those of model WJC-1. This will require several new ideas, but we believe that this should be possible. Along the way we will learn more precisely what are the nature of the "relativistic corrections" that account for the success of the CST.

The OBE structure of the NN kernel allows for a comparative simple construction of *consistent* (but not unique) electromagnetic interaction currents, and this work can therefore be extended to the description of electromagnetic scattering from the deuteron. The new off-shell scalar exchange couplings will generate a new kind of isoscalar exchange current that can be tested in elastic electron-deuteron scattering (deuteron form factors). We expect new exchange current contributions to the deuteron quadrupole moment, which may shed some light on failure of current potential models to explain this important low-energy parameter.

Finally, note that all the tools needed for an accurate relativistic calculation of the three-body scattering problem are now in hand. A first step might be to study elastic nd scattering and see if this relativistic approach can help with the A_y puzzle.

In conclusion, we believe that the availability of these precision fits should make it possible to extend the great success of precision nonrelativistic few-body physics into a relativistic domain.

Acknowledgments

This work is the conclusion of an effort extending over more than a decade, supported initially by the DOE through grant No. DE-FG02-97ER41032, and recently supported by Jefferson Science Associates, LLC under U.S. DOE Contract No. DE-AC05-06OR23177. A. S. was supported by FCT under grant No. POCT1/ISFL/2/275 and thanks the Jefferson Lab Theory Group for the hospitality extended to him during several visits while this work was performed. We also acknowledge prior work by R. Machleidt and J.W. Van Orden, who wrote some earlier versions of parts of the NN code. The data analysis used parts of the SAID code supplied to us by R. A. Arndt. Helpful conversations with the the Nijmegen group (J. J. de Swart, M. C. M. Rentmeester, and R.G.E. Timmermans) and with R. Schiavilla are gratefully acknowledged.

APPENDIX A: OVERVIEW

Many features of the two-body theory are described in detail in the following appendices.

The form of the partial wave expansion of Eq. (2.2) is derived in Appendix E. Some features of the on-shell prescription of the CST are discussed in Appendix B, and in particular, we discuss the removal of spurious singularities from the kernel in Sec. B 2 c. This latter issue has been a problem with the CST for many years, and in this work we feel we have found a satisfactory solution. The simplest one channel CST (used here) also has spurious singularities when the mass of the two-body system $W \rightarrow 0$. These lead to the existence of deeply bound states which are an artifact of the one channel approximation. It is shown in Appendix D that these bound states have no effect on any of the results of this paper, and can in fact be removed by artificially setting the kernel to zero for small masses W .

The OBE model appears to provide no rule for how many bosons to include in the kernel, and in the absence of such a rule seems to have little predictive power. Strictly speaking this is objection cannot be answered, since the OBE model is, at its foundation, merely a phenomenology. Still, we show in Appendix C that the exchange of only scalar, pseudoscalar, vector (with both Dirac and Pauli couplings), and axial vector mesons, one of each isospin, is sufficient to describe the most general spin and isospin structure of an on-shell NN kernel (but not the most general functional dependence, of course). This provides a partial answer to this objection.

APPENDIX B: ON-SHELL PRESCRIPTION

In this appendix we discuss the nature of the requirement that one of the two nucleons is restricted to its positive energy mass-shell (by convention, nucleon 1). If the particles are identical, identical results are obtained when nucleon 2 is on-shell. In this appendix we represent the nucleon energy $\sqrt{m^2 + \mathbf{k}^2}$ by $E(k)$ (instead of E_k used in the rest of the paper).

1. Non-identical particles

If the particles are distinguishable, the spectator formalism places the heavier of the two (assumed to be particle 1 in this paper) on-shell. The OBE kernel is then

$$V(\mathbf{p}, \mathbf{p}'; P) = \frac{N_1(p_1, p'_1) N_2(p_2, p'_2)}{m_{\text{ex}}^2 - (p - p')^2} \quad (\text{B1})$$

where, in the rest frame with $P = \{W, \mathbf{0}\}$,

$$\begin{aligned} p_1 &= \{E_1(p), \mathbf{p}\} \\ p_2 &= \{W - E_1(p), -\mathbf{p}\}. \end{aligned} \quad (\text{B2})$$

with $E_1(p) = \sqrt{m_1^2 + p^2}$. The relative momentum in the rest frame is therefore

$$p = \frac{1}{2}(p_1 - p_2) = \{E_1(p) - \frac{1}{2}W, \mathbf{p}\}. \quad (\text{B3})$$

The kernel is written as a function of the relative three-momenta only, since the prescription that particle 1 is on-shell fixes the relative energy, and it cannot be changed. In spite of this, the kernel is covariant because the mass shell constraint that defines the relative energy is covariant

The denominator of (B1) is manifestly covariant, and depends on the energy difference $(p_0 - p'_0)^2$, which is referred to as the retardation factor. This factor plays an important role which we now discussed in detail.

To demonstrate the importance and role of retardation, the denominator will be evaluated in a frame where the total momentum is $P = \{P_0, \mathbf{0}_\perp, P_\parallel\}$. Explicitly,

$$D = \omega_{\mathbf{p}-\mathbf{p}'}^2 - [E_1(p + \frac{1}{2}P_\parallel) - E_1(p' + \frac{1}{2}P_\parallel)]^2, \quad (\text{B4})$$

where $\omega_{\mathbf{q}} = \sqrt{m_{\text{ex}}^2 + \mathbf{q}^2}$ is the mass-shell energy of the exchanged meson and $E_1(p + \frac{1}{2}P_\parallel)$ is a shorthand notation for $\sqrt{m_1^2 + p_\perp^2 + (p_\parallel + \frac{1}{2}P_\parallel)^2}$. Assuming that the components of \mathbf{p} and \mathbf{p}' are much smaller than $E_\parallel \equiv E_1(\frac{1}{2}P_\parallel)$, and keeping terms to order p^2 only, the denominator may be expanded

$$\begin{aligned} D &\simeq m_{\text{ex}}^2 + (\mathbf{p}_\perp - \mathbf{p}'_\perp)^2 + (p_\parallel - p'_\parallel)^2 \\ &\quad - \left\{ E_\parallel \left[1 + \frac{P_\parallel p_\parallel}{2E_\parallel^2} + \mathcal{O}\left(\frac{p^2}{E_\parallel^2}\right) \right] \right. \\ &\quad \left. - E_\parallel \left[1 + \frac{P_\parallel p'_\parallel}{2E_\parallel^2} + \mathcal{O}\left(\frac{p'^2}{E_\parallel^2}\right) \right] \right\}^2 \\ &\simeq m_{\text{ex}}^2 + (\mathbf{p}_\perp - \mathbf{p}'_\perp)^2 + \frac{1}{\gamma^2}(p_\parallel - p'_\parallel)^2 \\ &= \omega_{\mathbf{p}-\mathbf{p}'}^2 - \frac{\gamma^2 - 1}{\gamma^2}(p_\parallel - p'_\parallel)^2 \end{aligned} \quad (\text{B5})$$

where

$$E_1(\frac{1}{2}P_\parallel) = E_\parallel = \gamma m_1. \quad (\text{B6})$$

Note that the retardation factor suppresses the dependence of kernel on the parallel component of p and p' . In the limiting case when $\gamma \rightarrow \infty$ the kernel (and hence the wave function) will not depend on the parallel component, leading to a coordinate space wave function with a $\delta(r_\parallel)$ dependence. This describes a wave function contracted into a thin disk in the direction of motion, as intuitively expected.

If $m_2 = m_1$, the same result emerges from the time ordered formalism (which, however, is not manifestly covariant). In the time ordered formalism the kernel obtained from the two time orderings of the meson exchange (ignoring the numerators) is

$$\begin{aligned} V_{\text{To}}(\mathbf{p}, \mathbf{p}'; P_\parallel) &= [2\omega(\omega + E_{1-} + E'_{1+} - \mathcal{E})]^{-1} \\ &\quad + [2\omega(\omega + E'_{1-} + E_{1+} - \mathcal{E})]^{-1} \end{aligned} \quad (\text{B7})$$

where $E_{1\pm}^{(\prime)} = E_1(p^{(\prime)} \pm \frac{1}{2}P_\parallel)$, $\mathcal{E} = (W^2 + P_\parallel^2)^{1/2}$ (with W the mass of the two-body system), and $\omega = \omega_{\mathbf{p}-\mathbf{p}'}$.

Assuming that p and p' are much smaller than E_\parallel , that $2E_\parallel - \mathcal{E} \sim \mathcal{O}(p^2)$, and expanding the energy factors to order p (neglecting terms of order p^2) gives

$$\begin{aligned} V_{\text{To}}(\mathbf{p}, \mathbf{p}'; P_\parallel) &\simeq \left[2\omega \left(\omega - \frac{P_\parallel}{2E_\parallel}(p_\parallel - p'_\parallel) \right) \right]^{-1} \\ &\quad + \left[2\omega \left(\omega + \frac{P_\parallel}{2E_\parallel}(p_\parallel - p'_\parallel) \right) \right]^{-1} \\ &\simeq \left[\omega^2 - \frac{\gamma^2 - 1}{\gamma^2}(p_\parallel - p'_\parallel)^2 \right]^{-1}, \end{aligned} \quad (\text{B8})$$

in agreement with the Spectator result (B5). This result has been obtained recently for QED in 1+1 dimension by Järvinen [163].

It can be shown that the Spectator results do *not* agree with the time ordered formalism if $m_2 \neq m_1$, or if the binding energy is not small.

We think that the retardation factors may be partly responsible for the success of the OBE approximation to the CST theory. We have seen that the retardation factors present in time-ordered theory are similar (at least for nonrelativistic energies), so a time-ordered calculation might also enjoy similar success if its retardation factors were retained.

2. Identical particles

The extension of the Spectator theory to identical particles is less than straightforward, and is perhaps one reason why it has not been used more widely. Here we review and describe the justification and motivation for the prescription used previously, which has been found to have many advantages for applications.

a. Kernel for both particles on-shell in the initial state

Begin with the case when both particles in the initial state are on-shell. In this case the prescription is unique, and free from problems. We antisymmetrize the kernel in the initial state, as shown in Fig. 17. The explicit form of the kernel is

$$\begin{aligned} V_{\alpha\alpha',\beta\beta'}^1(\mathbf{p}, \mathbf{p}^*; P) &= \frac{1}{2} \left\{ \frac{N_{\alpha\alpha'}(p_1, p_1^*) N_{\beta\beta'}(p_2, p_2^*)}{m_{\text{ex}}^2 - (p - p^*)^2} \right. \\ &\quad \left. + \eta_I \frac{N_{\alpha\beta'}(p_1, p_2^*) N_{\beta\alpha'}(p_2, p_1^*)}{m_{\text{ex}}^2 - (p + p^*)^2} \right\}, \end{aligned} \quad (\text{B9})$$

where η_I is a phase depending on the isospin of the NN channel under consideration, the superscript 1 denotes the fact that particle 1 is on-shell in the final state, and p^* is the relative four-momentum when *both* particles in the initial state are on-shell. In the two-body rest system,

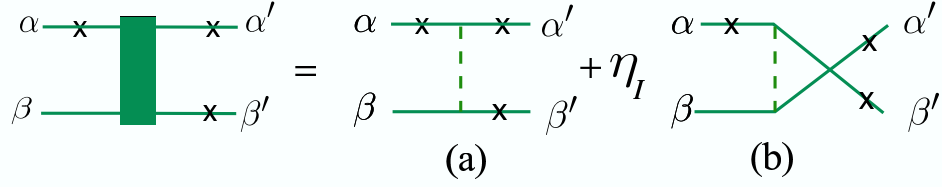

FIG. 17: (Color on line) Diagrammatic representation of the symmetrized OBE kernel given in Eq. (B9) (with the factor of $1/2$ suppressed). Particle 1 in the final state is on-shell (denoted by the \times) and the particles in the initial state, with relative four-momentum p^* , are *both* on-shell. With our convention, Feynman diagrams are written so that the end of each external line is always labeled with the same four-momentum and Dirac index ($\alpha, \alpha', \beta, \beta'$); this requires crossing the initial nucleon lines in the exchange term (b). Diagrammatically, the symmetry relation (B11) corresponds to crossing the initial nucleon lines and interchanging the α' and β' indices, giving the same two diagrams multiplied by the factor η_I .

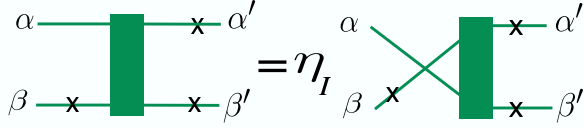

FIG. 18: (Color on line) Diagrammatic representation of the interchange rule for the symmetrized kernel, Eq. (B15). Here the solid box represents the full kernel, which is the sum of the two diagrams as shown in Fig. 17. The left-hand diagram is V^2 and the right hand diagram is V^1 (with indices and momenta exchanged).

where $P = \{W, \mathbf{0}\}$,

$$\begin{aligned} p^* &= \{0, \mathbf{p}^*\}; & |\mathbf{p}^*|^2 &= \frac{1}{4}W^2 - M^2 \\ p_1^* &= \{\frac{1}{2}W, \mathbf{p}^*\} \\ p_2^* &= \{\frac{1}{2}W, -\mathbf{p}^*\} \end{aligned} \quad (\text{B10})$$

The antisymmetrized kernel satisfies the relation

$$V_{\alpha\alpha',\beta\beta'}^1(\mathbf{p}, \mathbf{p}^*; P) = \eta_I V_{\alpha\beta',\beta\alpha'}^1(\mathbf{p}, -\mathbf{p}^*; P). \quad (\text{B11})$$

Note that, since the particles are identical, we could just as well have started with the case when particle 2 is on-shell in the final state (instead of particle 1). To distinguish this case from the standard case (particle 1 on shell) we make the substitution $p \rightarrow \hat{p}$ so that in the rest system

$$\begin{aligned} \hat{p}_1 &= \{W - E(p), \mathbf{p}\} = \frac{1}{2}P + \hat{p} \\ \hat{p}_2 &= \{E(p), -\mathbf{p}\} = \frac{1}{2}P - \hat{p} \\ \hat{p} &= \frac{1}{2}(\hat{p}_1 - \hat{p}_2) = \{\frac{1}{2}W - E(p), \mathbf{p}\}. \end{aligned} \quad (\text{B12})$$

We observe that \hat{p} differs from p only in the sign of p_0 , so they are identical when $p_0 = 0$ (*both* particles are on shell). The kernel for particle 2 on-shell can be obtained from (B9) if \hat{p} is substituted for p everywhere. Explicitly,

$$\begin{aligned} V_{\alpha\alpha',\beta\beta'}^2(\mathbf{p}, \mathbf{p}^*; P) &= \frac{1}{2} \left\{ \frac{N_{\alpha\alpha'}(\hat{p}_1, p_1^*) N_{\beta\beta'}(\hat{p}_2, p_2^*)}{m_{\text{ex}}^2 - (\hat{p} - p^*)^2} \right. \\ &\quad \left. + \eta_I \frac{N_{\alpha\beta'}(\hat{p}_1, p_2^*) N_{\beta\alpha'}(\hat{p}_2, p_1^*)}{m_{\text{ex}}^2 - (\hat{p} + p^*)^2} \right\}, \end{aligned} \quad (\text{B13})$$

where the superscript 2 refers to particle 2 on-shell. Under the interchange of $\mathbf{p} \rightarrow -\mathbf{p}$, the momenta are mapped as follows

$$\begin{aligned} \hat{p}_1 &\rightarrow p_2 \\ \hat{p}_2 &\rightarrow p_1 \\ \hat{p} &\rightarrow -p. \end{aligned} \quad (\text{B14})$$

This implies that

$$V_{\alpha\alpha',\beta\beta'}^2(\mathbf{p}, \mathbf{p}^*; P) = \eta_I V_{\beta\alpha',\alpha\beta'}^1(-\mathbf{p}, \mathbf{p}^*; P). \quad (\text{B15})$$

This is the symmetry we want to preserve in the following discussion: *in the rest frame, the amplitude for particle 1 on-shell can be obtained from that for particle 2 on-shell by interchanging Dirac indices, multiplying by the phase η_I , and changing the sign of the relative three-momentum*. This interchange rule, illustrated in Fig. 18, is the proper way to apply the Pauli principle to a state with one particle off-shell and one particle on-shell.

It is instructive to see how the interchange rule can be derived directly from the Feynman diagrams of Fig. 17. This is illustrated in Fig. 19. Here we use the fact that, if the labeling of the external particles is unchanged, any Feynman diagram can be “twisted” [i.e. all of the internal vertices on the top of the diagram exchanged with those on the bottom] without changing its value.

b. Calculation of the half on-shell scattering amplitude

Armed with the kernel (B9), the *half on-shell scattering amplitude* (defined to be the scattering amplitude with both particles on-shell in the *initial* state) can be calculated. As a first (incorrect) attempt, consider the uncoupled integral equations for the amplitudes M^1 and M^2 shown in Fig. 20. These equations define the scattering amplitudes as the infinite series generated by the initial on-shell interaction V^1 or V^2 followed successive exchanges of the unsymmetrized kernels V^{11} (for M^1) or

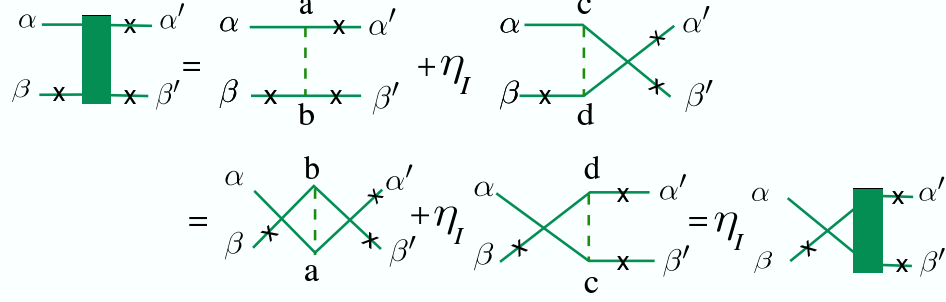

FIG. 19: (Color on line) Drawing showing how the interchange rule of Fig. 18 [and Eq. (B15)] can be derived diagrammatically. All Feynman diagrams are equal to their twisted versions. In this example we start with V^2 , equal to the two boson exchange diagrams shown in the first row. Each diagram is then twisted [obtained, in this example, by exchanging the vertices $a \leftrightarrow b$ and $c \leftrightarrow d$ while leaving the labeling of all external particles unchanged], as shown in the second row, and then the two twisted diagrams are collected into $\eta_I V^1$ (with a change in the sign of the final state three-momentum and the final Dirac indices exchanged, as suggested by the labeling of the diagram).

V^{22} (for M^2), where

$$V_{\alpha\alpha',\beta\beta'}^{11}(\mathbf{p}, \mathbf{k}; P) = \frac{N_{\alpha\alpha'}(p_1, k_1) N_{\beta\beta'}(p_2, k_2)}{m_{\text{ex}}^2 - (p - k)^2}$$

$$V_{\alpha\alpha',\beta\beta'}^{22}(\mathbf{p}, \mathbf{k}; P) = \frac{N_{\alpha\alpha'}(\hat{p}_1, \hat{k}_1) N_{\beta\beta'}(\hat{p}_2, \hat{k}_2)}{m_{\text{ex}}^2 - (\hat{p} - \hat{k})^2}, \quad (\text{B16})$$

where p_1 , etc., were previously defined in Eq. (B2) and \hat{p}_1 , etc., were defined in Eq. (B12), and the k 's and \hat{k} 's are similarly defined in terms of \mathbf{k} instead of \mathbf{p} . Note that V^{22} has particle 2 on-shell in both the initial and final state, while particle 1 is on-shell in V^{11} .

The advantage of the equations in Fig. 20 is that the

kernels (B16) are free of singularities for all values of the three momenta (this will be discussed in more detail below). Furthermore, by twisting the diagrams as demonstrated in Fig. 19, it is easy to see that these two amplitudes are related by the generalized Pauli principle (B15). This is illustrated in Fig. 21.

The problem with this prescription is subtle. When both particles in the final state are on-shell, we obtain two different answers, depending on whether or not we start with M^1 or M^2 . These differences are illustrated in Fig. 21. Explicitly, consider the leftmost diagrams (a) and (a'). If both final particles are on shell, these boxes are

$$M_{\alpha\alpha',\beta\beta'}^{(a)}(\mathbf{p}^*, \mathbf{p}^*; P_0) = \int \frac{d^3k}{(2\pi)^3} \frac{V_{\alpha\gamma,\beta\delta}^1(\mathbf{p}^*, \mathbf{k}; P) \Lambda_{\gamma\gamma'}(k_1) \Lambda_{\delta\delta'}(k_2) V_{\gamma'\alpha',\delta'\beta'}^1(\mathbf{k}, \mathbf{p}^*; P)}{2E(k)W[2E(k) - W]}$$

$$M_{\alpha\alpha',\beta\beta'}^{(a')}(\mathbf{p}^*, \mathbf{p}^*; P_0) = \int \frac{d^3k}{(2\pi)^3} \frac{V_{\alpha\gamma,\beta\delta}^2(\mathbf{p}^*, \mathbf{k}; P) \Lambda_{\gamma\gamma'}(k_1) \Lambda_{\delta\delta'}(k_2) V_{\gamma'\alpha',\delta'\beta'}^2(\mathbf{k}, \mathbf{p}^*; P)}{2E(k)W[2E(k) - W]}, \quad (\text{B17})$$

where $P_0 = \{W, \mathbf{0}\}$ and here we use the notation $\Lambda(k) = m + \not{k}$. For a simple scalar meson exchange, for example, these become

$$M_{\alpha\alpha',\beta\beta'}^{(a)}(\mathbf{p}^*, \mathbf{p}^*; P_0) = \int_k \frac{(m + E(k)\gamma^0 - \mathbf{k}^i\gamma^i)_{\alpha\alpha'}(m + [W - E(k)]\gamma^0 + \mathbf{k}^i\gamma^i)_{\beta\beta'}}{2E(k) - W}$$

$$M_{\alpha\alpha',\beta\beta'}^{(a')}(\mathbf{p}^*, \mathbf{p}^*; P_0) = \int_k \frac{(m + [W - E(k)]\gamma^0 - \mathbf{k}^i\gamma^i)_{\alpha\alpha'}(m + E(k)\gamma^0 + \mathbf{k}^i\gamma^i)_{\beta\beta'}}{2E(k) - W}, \quad (\text{B18})$$

where

$$\int_k \equiv \int \frac{d^3k}{(2\pi)^3} \frac{1}{2E(k)W\Delta(\mathbf{p}^*, \mathbf{k})\Delta(\mathbf{k}, \mathbf{p}^*)}, \quad (\text{B19})$$

and the denominators of the meson propagators are $\Delta(\mathbf{p}, \mathbf{k}) = \omega_{\mathbf{p}-\mathbf{k}}^2 - [E(p) - E(k)]^2$. When the two final

particles are on shell, the difference between these two should be zero, but instead it is

$$\Delta M \equiv M^{(a')} - M^{(a)} = \int_k \left\{ (m - \mathbf{k}^i\gamma^i)_{\alpha\alpha'} \gamma_{\beta\beta'}^0 - \gamma_{\alpha\alpha'}^0 (m + \mathbf{k}^i\gamma^i)_{\beta\beta'} \right\}. \quad (\text{B20})$$

$$\begin{aligned}
M^1 &= \frac{1}{2} \left\{ \text{Diagram (a)} + \eta_I \text{Diagram (b)} \right\} + \text{Diagram (a)} M^1 \\
&= \frac{1}{2} \left\{ \text{Diagram (a)} + \eta_I \text{Diagram (b)} + \dots \right\} \\
M^2 &= \frac{1}{2} \left\{ \text{Diagram (a')} + \eta_I \text{Diagram (b')} \right\} + \text{Diagram (a')} M^2 \\
&= \frac{1}{2} \left\{ \text{Diagram (a')} + \eta_I \text{Diagram (b')} + \dots \right\}
\end{aligned}$$

FIG. 20: (Color on line) Diagrammatic representation of (incorrect) uncoupled integral equations for the half on-shell scattering amplitudes M^1 and M^2 . The proposed equations are given on the first and third lines. The second and fourth lines give the scattering amplitudes iterated to 4th order. These equations satisfy the reflection property (B15), but are unsatisfactory because *when both final state particles are on-shell* diagrams (a) and (b) are not equal to diagrams (a') and (b').

$$\begin{aligned}
M^1 &\rightarrow \text{Diagram (a)} + \eta_I \text{Diagram (b)} = \text{Diagram (a)} + \eta_I \text{Diagram (b)} \rightarrow M^2 \\
M^2 &\rightarrow \text{Diagram (a')} + \eta_I \text{Diagram (b')} = \text{Diagram (a')} + \eta_I \text{Diagram (b')} \rightarrow M^1
\end{aligned}$$

FIG. 21: (Color on line) Top row: diagrams (a) and (b) from the 4th order expansion of M^1 ; bottom row: diagrams (a') and (b') from the 4th order expansion of M^2 (in both cases the overall factor of $\frac{1}{2}$ has been suppressed). The right shows the twisted versions of each diagram on the left. Comparison of the two top-left diagrams with the two bottom-right ones shows that the symmetry (B15) is indeed satisfied (and similarly for the top-right and bottom-left). However, when both final state particles are on shell, these amplitudes are not equal; for example the leftmost figures (a) and (a') differ by which particle is on-shell inside the box.

To be convinced that this is not zero, pick the special case of forward scattering $\mathbf{p}'^* = \mathbf{p}^* \equiv \mathbf{p}$ and evaluate between positive energy spinors with spins $\lambda_1 = \lambda'_1$ and $\lambda_2 = \lambda'_2$. The only component of \mathbf{k} that does not integrate to zero in the forward direction is that in the \mathbf{p} direction, and we may substitute $\mathbf{k}^i \rightarrow (\mathbf{k} \cdot \mathbf{p})\mathbf{p}^i/p^2$, giving

$$\begin{aligned}
\bar{u}_\alpha(\mathbf{p}, \lambda_1)\bar{u}_\beta(-\mathbf{p}, \lambda_2) \Delta M u_{\alpha'}(\mathbf{p}, \lambda_1)u_{\beta'}(-\mathbf{p}, \lambda_2) \\
= \int_k \frac{2\mathbf{k} \cdot \mathbf{p}E(p)}{m^2} \neq 0. \quad (\text{B21})
\end{aligned}$$

(As written, these integrals do not converge, but this is readily corrected by adding form factors, which are

identical for both terms and so do not change the results. In order to simplify the equations, these form factors have been omitted.)

The way to correct this problem is to couple the two equations together, as shown in Fig. 22. Here the off-shell exchange kernels V^{12} and V^{21} are drawn using a dot-dashed line with a small circle at each end, in anticipation of the fact that their definition could differ from the standard meson propagators used in V^{11} and V^{22} . When both final state particles are on-shell, the amplitudes M^1 and M^2 will now be equal, provided the

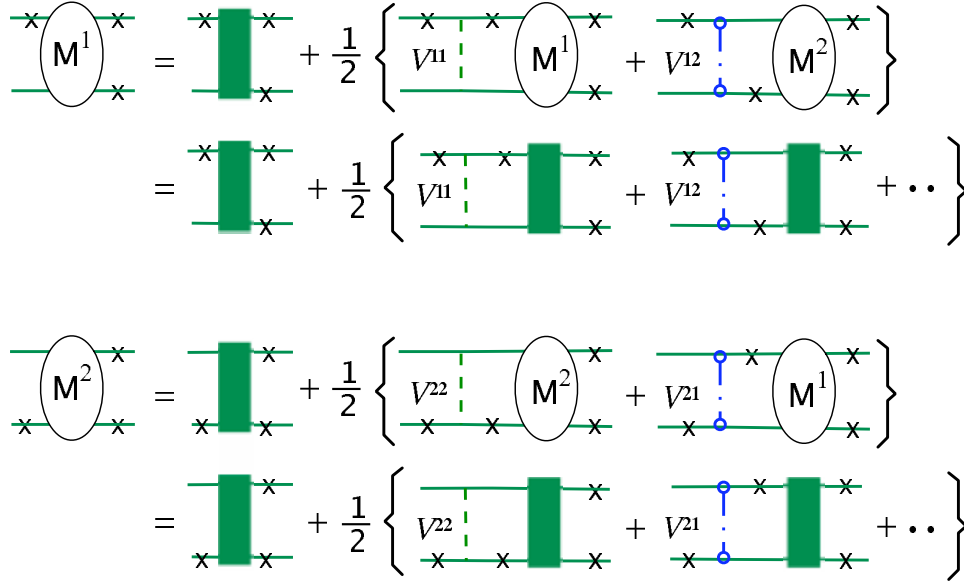

FIG. 22: (Color on line) Diagrammatic representation of coupled integral equations for the half on-shell scattering amplitudes M^1 and M^2 . The equations are given on the first and third lines. The second and fourth lines give the scattering amplitudes iterated to 4th order. These equations satisfy the reflection property (B15), and also give identical results when both final state particles are on-shell, provided that, for this on-shell point, $V^{22} = V^{12}$ and $V^{11} = V^{21}$.

following conditions are satisfied

$$\begin{aligned} V_{\alpha\alpha',\beta\beta'}^{12}(\mathbf{p}^*, \mathbf{k}; P) &= V_{\alpha\alpha',\beta\beta'}^{22}(\mathbf{p}^*, \mathbf{k}; P) \\ V_{\alpha\alpha',\beta\beta'}^{21}(\mathbf{p}^*, \mathbf{k}; P) &= V_{\alpha\alpha',\beta\beta'}^{11}(\mathbf{p}^*, \mathbf{k}; P), \end{aligned} \quad (\text{B22})$$

where, as before, the magnitude of \mathbf{p}^* is given by the mass shell condition (B10).

The definition of these kernels implied by field theory (Model B of Ref. I) is

$$\begin{aligned} V_{\alpha\alpha',\beta\beta'}^{12}(p, \mathbf{k}; P) &= \frac{N_{\alpha\alpha'}(p_1, \hat{k}_1) N_{\beta\beta'}(p_2, \hat{k}_2)}{m_{\text{ex}}^2 - (p - \hat{k})^2} \\ V_{\alpha\alpha',\beta\beta'}^{21}(p, \mathbf{k}; P) &= \frac{N_{\alpha\alpha'}(\hat{p}_1, k_1) N_{\beta\beta'}(\hat{p}_2, k_2)}{m_{\text{ex}}^2 - (\hat{p} - k)^2}. \end{aligned} \quad (\text{B23})$$

When the two final particles are on shell, the variables with and without hats are equal, so the constraints (B22) are automatically satisfied [compare Eq. (B16)]. However, the definition (B23) is not ideal because off-shell these kernels have singularities.

c. Singularities in the exchange kernels and their removal

To see how these singularities arise, look at the exchange denominator for V^{21} in the rest frame. If we define

$$\begin{aligned} q_{\text{ex}}^2(z) &= (\hat{p} - k)^2 \\ &= [W - E(p) - E(k)]^2 - \mathbf{p}^2 - \mathbf{k}^2 + 2\mathbf{p}\mathbf{k}z \end{aligned} \quad (\text{B24})$$

where $\mathbf{p} = |\mathbf{p}|$, $\mathbf{k} = |\mathbf{k}|$, and $z = (\mathbf{p} \cdot \mathbf{k})/pk$ is the cosine of the angle between \mathbf{p} and \mathbf{k} , the denominator can be

written

$$\begin{aligned} m_{\text{ex}}^2 - q_{\text{ex}}^2(z) &= m_{\text{ex}}^2 + (\mathbf{p} - \mathbf{k})^2 - [W - E(p) - E(k)]^2 \\ &= [\omega_{\mathbf{p}-\mathbf{k}} + W - E(p) - E(k)] \\ &\quad \times [\omega_{\mathbf{p}-\mathbf{k}} - W + E(p) + E(k)]. \end{aligned} \quad (\text{B25})$$

When $\mathbf{p} - \mathbf{k} = 0$, for example, this denominator is zero at

$$W = 2E(p) \pm m_{\text{ex}}. \quad (\text{B26})$$

One of these zeros appears only when $W \geq 2m + m_{\text{ex}}$, corresponding to the singularity associated with meson production. This is a physical singularity and is avoided by working at energies below the production threshold. The second zero at $W = 2E(p) - m_{\text{ex}}$ occurs at all physical energies for values of the three-momentum

$$p^2 \geq \frac{(W + m_{\text{ex}})^2}{4} - m^2 \simeq (368 \text{ MeV})^2, \quad (\text{B27})$$

where 368 MeV is the threshold for pion exchange when $W = 2m$. This is an unphysical singularity. In Ref. I it was shown that this singularity cancels exactly when the kernel is calculated to all orders. Hence, the cancellation of the imaginary part is easily implemented order by order by simply dropping it and treating the singularity as a principal value. In Ref. I, one of the models studied (referred to as Model B) evaluated these principal values numerically. This direct calculation of the principal values was somewhat complicated, numerically inaccurate, and hard to extend to calculations of electromagnetic currents and the three-body system. The effort would be justified if the treatment of these singularities

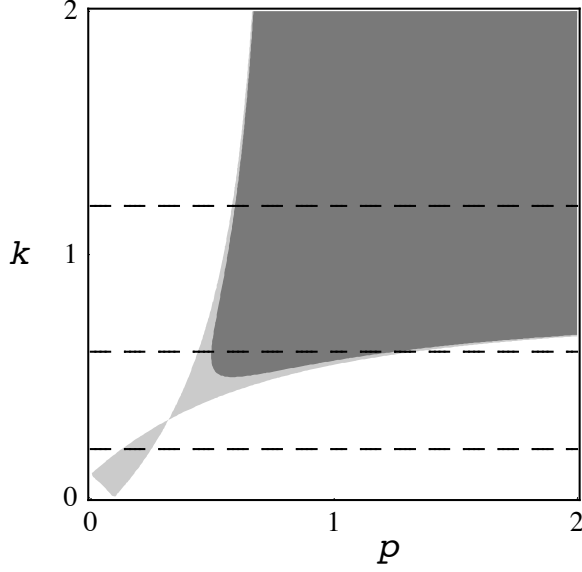

FIG. 23: Here p and k are in units of m , with $W = 2.1m$. The dark shaded area is the region where $q_{\text{ex}}^2(1) > m_{\text{ex}}^2$, with m_{ex} equal to the pion mass. The light shaded area is the region where $m_{\text{ex}}^2 > q_{\text{ex}}^2(1) > 0$, and the white area has $0 > q_{\text{ex}}^2(1)$ [except for the tiny triangular region near the origin where $q_{\text{ex}}^2(1) \geq q_{\text{ex}}^2(-1) > 0$]. The singularities occur along the boundary between the dark and light shaded regions. The three horizontal lines mark $k = 0.2, 0.6$, and 1.2 .

were physically significant, but since they are cancelled by higher order terms in the kernel, it is desirable to find a way to remove them, order by order, just as the imaginary parts are removed.

To explore the nature of these singularities, and to see how they could be removed, it is sufficient to consider the S -wave projection of the singular meson propagator in V^{21} ,

$$V_{\text{ex}}(p, k) \equiv \int_{-1}^1 dz \frac{1}{m_{\text{ex}}^2 - q_{\text{ex}}^2(z)}. \quad (\text{B28})$$

Using the principal value prescription for the z integration, the function V_{ex} is

$$V_{\text{ex}}(p, k) = \frac{1}{2pk} \ln \frac{|m_{\text{ex}}^2 - q_{\text{ex}}^2(1)|}{|m_{\text{ex}}^2 - q_{\text{ex}}^2(-1)|}. \quad (\text{B29})$$

For comparison, the S -wave projection of the direct kernel (denoted V_{direct}) is proportional to the same function with $q_{\text{ex}}^2(z) \rightarrow q_{\text{dir}}^2(z) = [E(p) - E(k)]^2 - \omega_{\mathbf{p}-\mathbf{k}}^2$. This propagator is not singular, as mentioned above.

The locus of the singularities of V_{ex} in the p, k plane is shown in Fig. 23. In this example the momenta are expressed in units of the nucleon mass, $W = 2.1m$, and the exchanged mass is the pion mass. The three lines at fixed k_i mark regions where V_{ex} has 0, 2, or 1 singularities in p . The functions $F(p) = V_{\text{ex}}(p, k_i)$ at these three fixed values of k_i are shown in Fig. 24, with the smooth functions $V_{\text{direct}}(p, k_i)$ shown for comparison. The singularities are sharp, narrow spikes that clearly represent un-

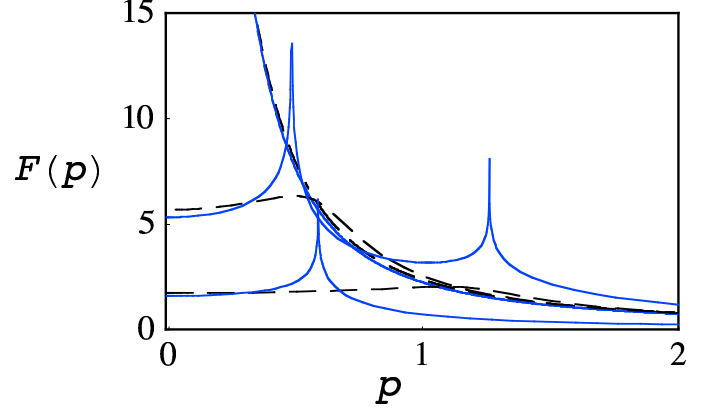

FIG. 24: (Color on line) Plots of the 6 dimensionless functions $F(p) = V_{\text{ex}}(p, k_i)$ (solid lines) and $F(p) = V_{\text{direct}}(p, k_i)$ (dashed lines) for the dimensionless values of $k_i = 0.2, 0.6$ and 1.2 as shown in Fig. 23. The curves can be distinguished by looking at their behavior at small p , which is roughly proportional to $1/k_i$.

physical behavior. For small p (below the region of singularities) $V_{\text{direct}}(p, k) \simeq V_{\text{ex}}(p, k)$. In the singular region, $V_{\text{direct}}(p, k_i)$ gives roughly a p -averaged value of $V_{\text{ex}}(p, k_i)$ up to $p \simeq 1$, and at larger p it looks like $V_{\text{direct}}(p, k_i)$ gives roughly a k -averaged value of $V_{\text{ex}}(p, k_i)$. In all, it looks like $V_{\text{direct}}(p, k) \simeq$ an average value of $V_{\text{ex}}(p, k)$ over the entire region of k, p space.

In the work of Ref. I, the two cases shown in Fig. 24 were both studied. Model A replaced the *denominators* of the exchanged terms with the denominators of the direct term, leaving the numerators unchanged. Specifically Model A employed the following prescriptions for the exchange kernels V^{12} and V^{21}

$$\begin{aligned} V_{\alpha\alpha', \beta\beta'}^{12}(\mathbf{p}, \mathbf{k}; P) &\rightarrow V_{\alpha\alpha', \beta\beta'}^{12, A}(\mathbf{p}, \mathbf{k}; P) \\ &= \frac{N_{\alpha\alpha'}(p_1, \hat{k}_1) N_{\beta\beta'}(p_2, \hat{k}_2)}{m_{\text{ex}}^2 - (p + \hat{k})^2} \\ V_{\alpha\alpha', \beta\beta'}^{21}(\mathbf{p}, \mathbf{k}; P) &\rightarrow V_{\alpha\alpha', \beta\beta'}^{21, A}(\mathbf{p}, \mathbf{k}; P) \\ &= \frac{N_{\alpha\alpha'}(\hat{p}_1, k_1) N_{\beta\beta'}(\hat{p}_2, k_2)}{m_{\text{ex}}^2 - (\hat{p} + k)^2}, \end{aligned} \quad (\text{B30})$$

where, in the rest frame the relative four-momentum \hat{k} is defined as in Eq. (B12). Note that

$$\begin{aligned} p = p_1 - \frac{1}{2}P &= \{E(p) - \frac{1}{2}W, \mathbf{p}\} = \hat{p} - 2\frac{\hat{p} \cdot P}{P^2} \\ \hat{p} = \frac{1}{2}P - \hat{p}_2 &= \{\frac{1}{2}W - E(p), \mathbf{p}\} = p - 2\frac{p \cdot P}{P^2}. \end{aligned} \quad (\text{B31})$$

These equalities show how $\hat{p}(p)$ can be expressed in terms of p (\hat{p}). In the rest frame the denominators of (B30) are now

$$\begin{aligned} m_{\text{ex}}^2 - (p + \hat{k})^2 &= \omega_{\mathbf{p}+\mathbf{k}}^2 - [E(p) - E(k)]^2 \\ m_{\text{ex}}^2 - (\hat{p} + k)^2 &= \omega_{\mathbf{p}+\mathbf{k}}^2 - [E(p) - E(k)]^2, \end{aligned} \quad (\text{B32})$$

equal (except for the sign of \mathbf{p}) to the denominators of the direct term.

A major advantage of this prescription is that it satisfies the important reflection property (B15) and the constraints (B22). In fact, when either the initial or final state is on-shell, the exchange terms in (B30) are indistinguishable from the field theory forms (B23).

However, to complete a program of electromagnetic few body calculations requires that exchange (or interaction) currents be found that are consistent with the interaction kernel. Unfortunately, finding interaction currents consistent with Model A is far from straightforward. The momentum carried by the exchange term in Model A is not related to the momentum transferred at the vertices (i.e. $\hat{p} + k \neq k_1 - p_2$ for example) and hence the exchange term cannot be easily related to any kind of OBE mechanism. The Model A exchange term is a phenomenological 4-point function, and while it is possible to find interaction currents consistent with a 4-point function, the lack of a meson exchange structure means that field theory is not very helpful in guiding its construction. Ultimately this current must be found phenomenologically, with resulting ambiguities, and much of the value of the connection between field theory and the Spectator theory is lost. An additional related problem is that it is not clear how to use Model A to define amplitudes when *both* particles in the final (or initial state) are off-shell, and such amplitudes are needed for complete electromagnetic calculations. While it is certainly possible to use Model A for a calculation of NN and NNN wave functions, scattering amplitudes, and simple electromagnetic observables, these shortcomings lead to the consideration of other options.

Model C: In applications to electromagnetic interactions, where it is necessary to know both the interaction current and the extension of the kernel to cases where *both* final (or initial) nucleons are off-shell, there are significant advantages in retaining the basic OBE structure of the kernel. The essential feature of the OBE structure is that there is a meson propagator that depends *only* on the square of the four-momentum q^2 , and that q is equal to the momentum transferred between the nucleons. If the kernel has this form, it is known how to calculate consistent interaction currents. Furthermore, if the functional form of the propagator is altered so that it has no singularities for any real value of q^2 , it is straightforward to use it even when both nucleons are off-shell.

After some consideration of these issues, we settled on a very simple and straightforward prescription that satisfies all of the requirements outlined above. Simply stated, the prescription is to replace the four momentum transfer in all OBE expressions by the negative of its absolute value

$$q^2 \rightarrow -|q^2|. \quad (\text{B33})$$

Since q^2 is always negative in the direct terms, this will not alter the direct terms at all, preserving the basic results of the Spectator theory when the particles are not identical so that only one particle is on-shell. For the

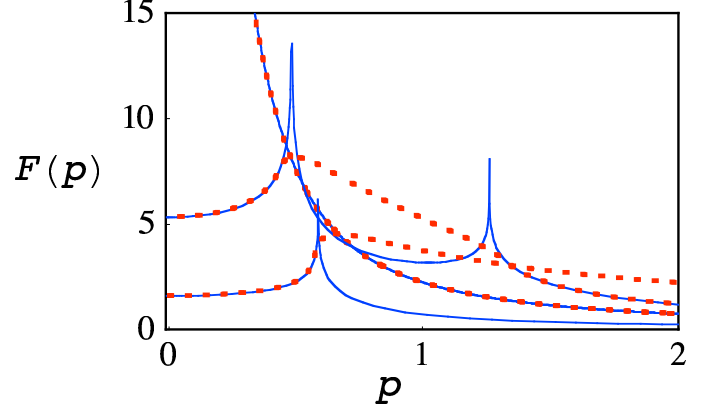

FIG. 25: (Color on line) Plots of the 6 dimensionless functions $F(p) = V_{\text{ex}}(p, k_i)$ (solid lines) and $F(p) = V_{\text{ex}}^C(p, k_i)$ (dotted lines) for the dimensionless values of $k_i = 0.2, 0.6$ and 1.2 as shown in Fig. 23. The curves can be distinguished by looking at their behavior at small p , which is roughly proportional to $1/k_i$.

exchange terms, the illustrative integral (B28) becomes

$$V_{\text{ex}}^C(p, k) \equiv \int_{-1}^1 dz \frac{1}{m_{\text{ex}}^2 + |(\hat{p} - k)^2|}. \quad (\text{B34})$$

If $-q^2 = B(p, k) - 2pkz$, with $B(p, k) = p^2 + k^2 - q_0^2$, q^2 will change sign whenever

$$-2pk < B(p, k) < 2pk. \quad (\text{B35})$$

Hence the integral V^C becomes

$$V_{\text{ex}}^C(p, k) = \frac{1}{2pk} \ln R, \quad (\text{B36})$$

where the form of R depends on the sign of q^2 , with

$$R = \begin{cases} \frac{m_{\text{ex}}^2 + B + 2pk}{m_{\text{ex}}^2 + B - 2pk} & 2pk < B \\ \frac{(m_{\text{ex}}^2 + 2pk)^2 - B^2}{m_{\text{ex}}^4} & -2pk < B < 2pk \\ \frac{m_{\text{ex}}^2 - B + 2pk}{m_{\text{ex}}^2 - B - 2pk} & B < -2pk. \end{cases} \quad (\text{B37})$$

Note that both V^C and dV^C/dp (with k held constant) are continuous. These functions are compared with V_{ex} in Fig. 25. They interpolate between the singularities, just as Model A did, but, as discussed above, the construction of exchange currents for Model C is more straightforward than for Model A. All of the results presented in this paper use this Model C prescription.

APPENDIX C: GENERAL FORM OF THE ON-SHELL NN KERNEL

In this Appendix we show that the 8 meson exchanges used in this calculation are sufficient to describe the *most*

general spin and isospin structure of the NN kernel in the case when all of the external nucleons are on their mass-shell.

As is well known, the most general 4×4 Dirac matrix can be expanded in terms of the 16 bi-linear covariants, $\mathbf{1}$, γ^μ , $\sigma^{\mu\nu}$, $\gamma^5\gamma^\mu$, and γ^5 . Requiring that the NN kernel be covariant, gives the most general expansion

$$\begin{aligned} \mathcal{V}_{12} = & F_s \mathbf{1}_1 \mathbf{1}_2 + F_v (\gamma^\mu)_1 (\gamma_\mu)_2 + F_t (\sigma^{\mu\nu})_1 (\sigma_{\mu\nu})_2 \\ & + F_a (\gamma^5 \gamma^\mu)_1 (\gamma^5 \gamma_\mu)_2 + F_p \gamma_1^5 \gamma_2^5, \end{aligned} \quad (\text{C1})$$

where (suppressing the nucleon spin indices) $\mathcal{O}_i = \bar{u}(p_i) \mathcal{O} u(k_i)$ are the nucleon matrix elements of the operators. If the particles are off shell, there are a great many more possible terms [165].

The on-shell OBE kernel has the form

$$\begin{aligned} \mathcal{V}_{12}^{\text{OBE}} = & f_s \mathbf{1}_1 \mathbf{1}_2 + f_a (\gamma^5 \gamma^\mu)_1 (\gamma^5 \gamma_\mu)_2 + f_p \gamma_1^5 \gamma_2^5 \\ & + f_v \left[\gamma^\mu + \frac{\kappa_v}{2m} i \sigma^{\mu\alpha} q_\alpha \right]_1 \left[\gamma_\mu - \frac{\kappa_v}{2m} i \sigma_{\mu\beta} q_\beta \right]_2, \end{aligned} \quad (\text{C2})$$

where $q = p_1 - k_1 = k_2 - p_2$ and we have used the fact that the $q^\mu q^\nu / m_v^2$ term in the propagator of the vector meson reduces to zero when the nucleons are on shell. Using the well known Gordon decomposition for an on shell particle

$$i \sigma^{\mu\nu} (p_i - k_i)_\nu = 2m \gamma^\mu - Q_i^\mu, \quad (\text{C3})$$

where $Q_i \equiv p_i + k_i$, we can transform the OBE term into the form

$$\begin{aligned} \mathcal{V}_{12}^{\text{OBE}} = & f'_s \mathbf{1}_1 \mathbf{1}_2 + f_a (\gamma^5 \gamma^\mu)_1 (\gamma^5 \gamma_\mu)_2 + f_p \gamma_1^5 \gamma_2^5 \\ & + f'_v (\gamma^\mu)_1 (\gamma_\mu)_2 - f_v \frac{\kappa_v (1 + \kappa_v)}{2m} [(\mathcal{Q}_2)_1 \mathbf{1}_2 + \mathbf{1}_1 (\mathcal{Q}_1)_2], \end{aligned} \quad (\text{C4})$$

where

$$\begin{aligned} f'_s &= f_s + f_v \frac{\kappa_v^2}{4m^2} Q_1 \cdot Q_2 \\ f'_v &= f_v (1 + \kappa_v)^2. \end{aligned} \quad (\text{C5})$$

Note that this expansion has 5 terms. To show that it has the most general spin dependence possible, we need only show that the most general expansion (C1) can be cast into this form.

To this end we use the identity (recalling that, in our notation, $\epsilon_{0123} = 1$ and $\gamma^5 = i\gamma^0\gamma^1\gamma^2\gamma^3$)

$$\epsilon^{\mu\nu\alpha\beta} \sigma_{\alpha\beta} = 2i\gamma^5 \sigma^{\mu\nu}. \quad (\text{C6})$$

Contracting both sides with $p_i - k_i$ and taking the on-shell matrix element (so the Dirac equation can be used) gives

$$\epsilon^{\mu\nu\alpha\beta} (\sigma_{\alpha\beta})_i (p_i - k_i)_\nu = -2\gamma_i^5 Q_i^\mu. \quad (\text{C7})$$

Now, using this identity for both particles 1 and 2, multiplying the two terms together by contracting the free

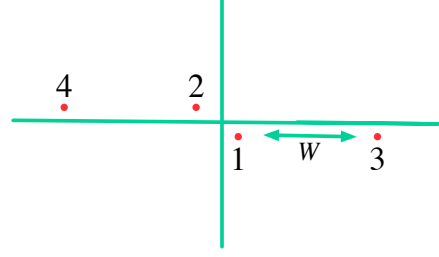

FIG. 26: (Color on line) The four poles in the complex p_0 plane arising from the term $[(m^2 - p_1^2)(m^2 - p_2^2)]^{-1}$. The CST (with particle 1 on-shell) keeps only the pole at $p_0 = E(p) - \frac{1}{2}W$ (#1). When $W \rightarrow 0$ the pole at $p_0 = E(p) + \frac{1}{2}W$ (#3) cannot be neglected. The full description in this case requires the two-channel spectator equation.

index μ , reducing the expressions using the Dirac equation, and rearranging terms gives a very useful identity

$$\begin{aligned} & (\mathcal{Q}_2)_1 \mathbf{1}_2 + \mathbf{1}_1 (\mathcal{Q}_1)_2 \\ &= \frac{Q_1 \cdot Q_2}{2m} [\mathbf{1}_1 \mathbf{1}_2 + \gamma_1^5 \gamma_2^5] \\ &+ 2m (\gamma^\mu)_1 (\gamma_\mu)_2 - \frac{q^2}{4m} (\sigma^{\alpha\beta})_1 (\sigma_{\alpha\beta})_2, \end{aligned} \quad (\text{C8})$$

allowing the invariant $[(\mathcal{Q}_2)_1 \mathbf{1}_2 + \mathbf{1}_1 (\mathcal{Q}_1)_2]$ to be expressed in terms of the invariants of Eq. (C1). Substituting this into Eq. (C4) gives the following correspondence

$$\begin{aligned} F_s &= f_s - f_v \kappa_v \frac{Q_1 \cdot Q_2}{4m^2} \\ F_v &= f_v (1 + \kappa_v) \\ F_t &= f_v \kappa_v (1 + \kappa_v) \frac{q^2}{8m^2} \\ F_a &= f_a \\ F_p &= f_p - f_v \kappa_v (1 + \kappa_v) \frac{Q_1 \cdot Q_2}{4m^2}. \end{aligned} \quad (\text{C9})$$

Hence every term in the most general spin and isospin expansion (C1) can be expressed in terms of OBE parameters.

However, the OBE assumption imposes severe constraints on the functional form of the F_i ; an arbitrary form is not possible. In particular, the model assumes κ_v is a constant, so the ratio F_t/F_v is proportional to q^2 , and $F_t = 0$ at $q^2 = 0$. The OBE model also assumes the f_i depend only on q^2 (and not on the energy squared s), so only F_s and F_p have an energy dependence through their dependence on $Q_1 \cdot Q_2$.

APPENDIX D: NUCLEON FORM FACTOR AND REMOVAL OF SINGULARITIES AT SMALL W

To provide needed convergence, the nucleon propagator is multiplied by a form factor, $H^2(p)$. [As suggested

by the notation, this form factor is the square of the function $H(p)$; the reasons for this will be discussed below.] The dressed propagator is therefore

$$S_D(p) = H^2(p)S_0(p) = \frac{H^2(p)}{m - \not{p}}. \quad (\text{D1})$$

In the cm frame, the propagator of the off-shell particle (taken to be particle 2) is

$$S_2(p) = \frac{H^2(p_2)(m + \not{p}_2)}{W[2E(p) - W]}. \quad (\text{D2})$$

The singularity at $W = 2E(p)$ gives rise to the elastic scattering cut, but the singularity at $W = 0$ is unphysical. This singularity is due to the presence the negative energy pole in the propagator of particle 2 (see Fig. 26, where this pole is labeled 3), which is very distant from the physical scattering region, and becomes important only when $W \rightarrow 0$ where it pinches the positive energy pole from particle 1 (labeled pole 1 in the figure). When $W = 0$ these two poles coalesce into a double pole, giving a finite result.

The singularity at $W = 0$ is therefore removed by including the contributions from both poles 1 and 3, which doubles the number of channels needed in the calculation. The spectator theory that includes channels from both pole 1 and 3 is referred to as the two-channel spectator theory, and has been used for the description of the pion as a bound state of a massive constituent quark and antiquark, where an accurate description of states with masses near zero is required [166, 167].

In these calculations two-body scattering near $W = 0$ plays a role in the three-body spectator equation when the spectator three-momentum $q \rightarrow q_{\text{crit}}$, as discussed briefly in Sec. II above. In this work we have used the nucleon form factor given in Eq. (2.5) above, and with this simple choice the two-body scattering near $W = 0$ gives a number of spurious deeply bound states. These deeply bound states are “spurious” because they would not exist if the propagator (D2) did not have a singularity at $W = 0$, and this singularity could be removed by using the two channel spectator theory.

All states with binding energies greater than -1800 MeV (corresponding to values of $W \gtrsim 78$ MeV) are tabulated in Tables IX and X, and there may be more in the region $0 < W < 78$ MeV. Except for the deuteron, model WJC-1 has no states with binding energies greater than -1500 and model WJC-2 has none with binding energies greater than -1200 MeV. But the convergence of the three-body integrals is such that, numerically, states with masses $W \lesssim m$ make no contribution at all. Hence a realistic description of two-body scattering for binding energies greater than about -940 MeV is sufficient, and since neither model has any spurious states in this region, the results are independent of their existence.

To understand this result, consider the two-body subsystem of particles 2 and 3 in the three-body equation, displayed in Fig. 2 in Sec. II. In the three-body rest

TABLE IX: Deeply bound states for Model WJC-1. There are no states with binding energies greater than -1500 MeV except for the deuteron at a binding energy of -2.22 MeV.

channel	states	channel	states
1S_0	no bound states	3P_0	no bound states
1P_1	2 states < -1600	1G_4	no bound states
3P_1	3 states < -1500	3G_4	2 states < -1600
$^3S_1 - ^3D_1$	1 state < -1700	$^3F_4 - ^3H_4$	1 state < -1700
1D_2	1 state < -1600	1H_5	1 state < -1700
3D_2	1 state < -1600	3H_5	no bound states
$^3P_2 - ^3F_2$	no bound states	$^3G_5 - ^3I_5$	1 state < -1700
1F_3	1 state < -1600	1I_6	1 state < -1700
3F_3	2 states < -1600	3I_6	1 state < -1700
$^3D_3 - ^3G_3$	1 state < -1700	$^3H_6 - ^3K_6$	1 state < -1700

TABLE X: Deeply bound states for Model WJC-2. There are no states with binding energies greater than -1200 MeV except for the deuteron at a binding energy of -2.22 MeV.

channel	states	channel	states
1S_0	no bound states	3P_0	2 states < -1400
1P_1	3 states < -1200	1G_4	2 states < -1600
3P_1	3 states < -1400	3G_4	2 states < -1600
$^3S_1 - ^3D_1$	1 state < -1600	$^3F_4 - ^3H_4$	no bound states
1D_2	1 state < -1500	1H_5	2 states < -1600
3D_2	1 state < -1400	3H_5	no bound states
$^3P_2 - ^3F_2$	2 states < -1600	$^3G_5 - ^3I_5$	1 state < -1700
1F_3	1 state < -1500	1I_6	no bound states
3F_3	2 states < -1600	3I_6	2 states < -1600
$^3D_3 - ^3G_3$	1 state < -1700	$^3H_6 - ^3K_6$	no bound states

frame, where the four-momenta of the three particles satisfy $k_1 + k_2 + k_3 = (M_t, \mathbf{0})$, the total four-momentum of the pair is $P_{23} = k_2 + k_3$, and the four-momentum of the on-shell spectator particle 1 is $k_1 = (E_{k_1}, \mathbf{k}_1) \equiv (E_q, -\mathbf{q})$, such that $P_{23} = \mathbf{q}$. We choose \mathbf{q} along the positive \hat{z} direction, and the relative three-momentum \mathbf{p} of the pair particles in the $\hat{x}\hat{z}$ plane, oriented at an angle θ with respect to \mathbf{q} . Given the invariant mass W of the pair, its four-momentum is $P_{23} = (\mathcal{E}_q, \mathbf{q})$, and the relative momentum $p = \frac{1}{2}(k_2 - k_3)$ becomes

$$p = \left(E_{\frac{1}{2}\mathbf{q}+\mathbf{p}} - \frac{1}{2}\mathcal{E}_q, p \sin \theta, 0, p \cos \theta \right), \quad (\text{D3})$$

with $\mathcal{E}_q = \sqrt{W^2 + \mathbf{q}^2}$ and $E_{\frac{1}{2}\mathbf{q}+\mathbf{p}} = \sqrt{m^2 + (\frac{1}{2}\mathbf{q} + \mathbf{p})^2}$.

The boost B is chosen to bring the two-body subsystem to its rest frame, such that

$$\tilde{P}_{23} = BP_{23} = (W, 0, 0, 0). \quad (\text{D4})$$

The same boost is now applied to the relative momentum p and yields the relative pair momentum in its rest

frame, where the two-body scattering amplitude is actually calculated when the three-body equation is solved,

$$\begin{aligned} \tilde{p} &= Bp = \begin{pmatrix} \frac{\mathcal{E}_q}{W} & 0 & 0 & -\frac{q}{W} \\ 0 & 1 & 0 & 0 \\ 0 & 0 & 1 & 0 \\ -\frac{q}{W} & 0 & 0 & \frac{\mathcal{E}_q}{W} \end{pmatrix} p \\ &= \begin{pmatrix} \frac{\mathcal{E}_q}{W} \left(E_{\frac{1}{2}q+p} - \frac{1}{2}\mathcal{E}_q \right) - \frac{q}{W}p \cos \theta \\ p \sin \theta \\ 0 \\ -\frac{q}{W} \left(E_{\frac{1}{2}q+p} - \frac{1}{2}\mathcal{E}_q \right) + \frac{\mathcal{E}_q}{W}p \cos \theta \end{pmatrix} \end{aligned} \quad (\text{D5})$$

The magnitude of the relative three-momentum squared becomes

$$\tilde{p}^2 = p^2 \sin^2 \theta + \left[\sqrt{1 + \frac{q^2}{W^2}} \left(p \cos \theta + \frac{q}{2} \right) - \frac{q}{W} E_{\frac{1}{2}q+p} \right]^2. \quad (\text{D6})$$

Near the critical momentum, when $W \rightarrow 0$, this reduces to

$$\tilde{p}^2 \rightarrow p^2 \sin^2 \theta + \frac{q}{W} \left[p \cos \theta + \frac{q}{2} - E_{\frac{1}{2}q+p} \right]^2, \quad (\text{D7})$$

and because

$$E_{\frac{1}{2}q+p} > p \cos \theta + \frac{q}{2}, \quad (\text{D8})$$

the term inside the brackets cannot vanish, and therefore \tilde{p}^2 diverges. Since the two-body scattering amplitude goes to zero as a high power of the magnitude of the relative three-momentum, this strongly suppresses the high q (or low W) contributions. It may be surprising that this happens even when \mathbf{p} is perpendicular to the direction of the boost. If both particles were on-shell, the energy component of the relative momentum would be zero and indeed no change of magnitude of the three-vector would occur as a result of the boost. However, since one particle is off-shell, a non-zero energy component mixes with the three-vector components and changes their magnitude for all angles θ .

If the nucleon form factor is to be interpreted as a self-energy, the form factor $H(p)$ can be a covariant function of p^2 only. However, since the light cone $p^2 = 0$ is covariant under all Poincaré transformations, this function may have a different functional form in each of the three regions invariant under Lorentz transformations: (i) the forward light cone defined by $p_0 > |\mathbf{p}| > 0$, (ii) the space-like region (sometimes referred to as the “now” region) defined by $p^2 < 0$, and (iii) the backward light cone defined by $p_0 < -|\mathbf{p}| < 0$.

Bearing this in mind, a nucleon form factor could be chosen to greatly reduce the interaction for all energies below $W < m$, insuring that the singularities at $W = 0$ are suppressed and there are no spurious bound states. The simplest way to eliminate the deeply bound states is to use the form factor to cut off the interaction for all

$W < W_{\text{crit}}$, where we could choose $W_{\text{crit}} \simeq 1200$ MeV. As our discussion shows, this would not alter *any of the results in this paper*. The only phenomenological objection to such a choice is that the electromagnetic exchange currents are usually difficult to calculate for a nucleon form factor that depends on W^2 as well as p^2 . However, if the W^2 dependence is a sharp cutoff, then the exchange currents will also be zero for all $W < W_{\text{crit}}$, and the problem is avoided. We have not used this possibility in this paper; it may be investigated in subsequent work.

In summary: the previous discussion shows that modifying the nucleon form factor by adding a cutoff

$$H_0 = H(p) [W^2 - (1200 \text{ MeV})^2] \quad (\text{D9})$$

is a covariant change that will remove all of the spurious bound states, but will otherwise not change *any* of the other results in this paper. Hence the spurious bound states present no problem at all.

APPENDIX E: COMPUTATION OF THE OBE KERNEL AND REDUCTION OF THE TWO-BODY EQUATIONS

1. Overview

In this appendix, we work out the detailed form of the partial wave expansion of Eq. (2.2).

The first step is to define the helicity spinors in the $\hat{x}\hat{z}$ scattering plane, and this is done in Sec. E2. Here we define the states for both ρ -spin (where $\rho = +$ is the positive energy spinor, u , and $\rho = -$ is the negative energy spinor, v). The spinors for particle 1 and 2 are related by a rotation about the \hat{y} axis (and a phase).

Next, in Sec. E3 the off-shell propagator is decomposed into a sum of two terms, one with the off-shell particle in a positive ρ -spin state and the other in a negative ρ -spin state. There are therefore two channels, one channel describing the propagation of two positive ρ -spin states, $\{\rho_1\rho_2\} = \{++\}$, and one the propagation of a positive and a negative ρ -spin state, $\{\rho_1\rho_2\} = \{+-\}$. Using the properties of the rotation group, the two-body states for all $\{\rho_1\rho_2\}$ and arbitrary (θ, ϕ) are defined, and the partial wave expansions of the states is given in Sec. E4. Section E5 gives the symmetries of the two-body states under parity and particle exchange. The exchange operator relates states with different ρ -spins to each other. Equipped with the partial wave expansions from Sec. E4, the expansions of the two-body kernel are developed in Sec. E6. The partial wave matrix elements can be written in terms of a simple integral in the $\hat{x}\hat{z}$ plane. Using this formalism, the two-body partial wave equations are given in Sec. E7.

The partial wave equations (E36) are not efficient for solution, since they mix states of different parities. In Sec. E8 these equations are separated into the three independent scattering states with good parity and exchange symmetry: spin singlet, uncoupled triplet (referred to

as ‘‘triplet’’ below), and coupled triplet (referred to as ‘‘coupled’’ below). The final result, Eq. (E49), involves four coupled channels for all states with total angular momentum $J \geq 1$ and two channels of the special cases with $J = 0$.

2. Nucleon helicity spinors

The nucleon helicity spinors are defined as in previous references. The four-component helicity spinors can be written as a direct product of a two-component spinor in Dirac rho-space and a two-component spinor in spin 1/2 space. For particle 1 (in the sense of Jacob and Wick [168]) they are

$$\begin{aligned} u_1^+(\mathbf{p}, \lambda) &\equiv u(\mathbf{p}, \lambda) = u_1(\mathbf{p}, \lambda) = N_+(p\lambda) \otimes \chi_\lambda(\theta) \\ u_1^-(\mathbf{p}, \lambda) &\equiv v(-\mathbf{p}, \lambda) = v_1(\mathbf{p}, \lambda) = N_-(p\lambda) \otimes \chi_\lambda(\theta) \end{aligned} \quad (\text{E1})$$

where the rho-space spinors are

$$\begin{aligned} N_+(p\lambda) &= \begin{pmatrix} \cosh \frac{1}{2}\zeta \\ 2\lambda \sinh \frac{1}{2}\zeta \end{pmatrix} \\ N_-(p\lambda) &= \begin{pmatrix} -2\lambda \sinh \frac{1}{2}\zeta \\ \cosh \frac{1}{2}\zeta \end{pmatrix}, \end{aligned} \quad (\text{E2})$$

with $p = |\mathbf{p}|$ and $\tanh \zeta = p/E_p$. For momenta limited to the $\hat{x}\hat{z}$ plane, the spin 1/2 spinors are

$$\begin{aligned} \chi_{1/2}(\theta) &= R_y(\theta) \begin{pmatrix} 1 \\ 0 \end{pmatrix} = \begin{pmatrix} \cos \frac{1}{2}\theta \\ \sin \frac{1}{2}\theta \end{pmatrix} \\ \chi_{-1/2}(\theta) &= R_y(\theta) \begin{pmatrix} 0 \\ 1 \end{pmatrix} = \begin{pmatrix} -\sin \frac{1}{2}\theta \\ \cos \frac{1}{2}\theta \end{pmatrix}, \end{aligned} \quad (\text{E3})$$

where $R_y(\theta)$ is the active rotation through angle θ about the \hat{y} axis. These definitions are identical to those given in Eq. (A9) of Ref. [5], Eq. (4.23) of Ref. [13], and Eq. (A4) of Ref. [164]. The spinors (E1) will be collectively denoted

$$\begin{aligned} u_1^\rho(\mathbf{p}, \lambda) &= N_\rho(p\lambda) \otimes \chi_\lambda(\theta) \equiv u_1^\rho([p, \theta], \lambda) \\ &= \mathcal{R}_y(\theta) u_1^\rho([p, 0], \lambda) \end{aligned} \quad (\text{E4})$$

where the ρ -spin is either + or -.

Similarly, the helicity spinors for particle 2 are obtained by a rotation from those for particle 1. Following the conventions of Jacob and Wick the rotation is

$$\begin{aligned} u_2^\rho(\mathbf{p}, \lambda) &= \mathcal{R}(\theta) u_1^\rho(\mathbf{p}, \lambda) \\ &\equiv e^{-i\pi/2} \mathcal{R}_y(\theta) \mathcal{R}_z(\pi) \mathcal{R}_y(\pi) \mathcal{R}_y^{-1}(\theta) u_1^\rho(\mathbf{p}, \lambda) \end{aligned} \quad (\text{E5})$$

where $\mathcal{R}_y = e^{-i\theta \mathcal{J}_y}$ is the rotation through angle θ about the \hat{y} axis. Using the decomposition (E4) the rotation

operates only on the spinors χ , and

$$\begin{aligned} \mathcal{R}(\theta) \chi_\lambda(\theta) &\equiv e^{-i\pi/2} R_y(\theta) R_z(\pi) R_y(\pi) R_y^{-1}(\theta) \chi_\lambda(\theta) \\ &= R_y(\theta) \chi_{-\lambda}(0) = \chi_{-\lambda}(\theta) \end{aligned} \quad (\text{E6})$$

where the χ are as defined in (E3). Hence the spinors for particle 2 are

$$\begin{aligned} u_2^\rho(\mathbf{p}, \lambda) &= N_\rho(p\lambda) \otimes \chi_{-\lambda}(\theta) = (-1)^{1/2-\lambda} \mathcal{R}_y(\pi) u_1^\rho(\mathbf{p}, \lambda) \\ &\equiv u_2^\rho([p, \theta], \lambda) = \mathcal{R}_y(\theta) u_2^\rho([p, 0], \lambda). \end{aligned} \quad (\text{E7})$$

These relations agree with Eq. (A9) of Ref. [5] and Eq. (A6) of Ref. [164], and the definition given in Ref. [13]. It also follows that

$$u_1^\rho(\mathbf{p}, \lambda) = (-1)^{1/2+\lambda} \mathcal{R}_y(\pi) u_2^\rho(\mathbf{p}, \lambda). \quad (\text{E8})$$

Although the scattering will be restricted to the $\hat{x}\hat{z}$ plane, the definition of angular momentum states requires treatment of rotations about the \hat{z} axis. Here we depart from the conventions of Jacob and Wick, followed in Ref. I, and define the states for momentum in an arbitrary direction by

$$\begin{aligned} |(p, \theta, \phi) \lambda_1 \lambda_2; \rho_1 \rho_2) &\equiv e^{-i\phi \mathcal{J}_z} u_{1\alpha}^{\rho_1}(\mathbf{p}, \lambda_1) u_{2\beta}^{\rho_2}(\mathbf{p}, \lambda_2) \\ &= \mathcal{R}(\phi, \theta, 0) |(p, 0, 0) \lambda_1 \lambda_2; \rho_1 \rho_2), \end{aligned} \quad (\text{E9})$$

where $\mathcal{R}(\phi, \theta, \gamma) = e^{-i\phi \mathcal{J}_z} e^{-i\theta \mathcal{J}_y} e^{-i\gamma \mathcal{J}_z}$ is the general rotation through Euler angles ϕ , θ , and γ , and α and β are the Dirac indices on subspace 1 and 2, respectively (usually suppressed). In Ref. I and Jacob and Wick the states were defined using the rotation $\mathcal{R}(\phi, \theta, -\phi)$; the convention (E9) is favored for extensions of this formalism to three-body states, as discussed in [13]. One of the objectives of this appendix is to show that all of the results of Ref. I also follow from the definition (E9).

3. Separation of the off-shell particle into ρ -spin states

In the cm system, where $k_2 = \{W - E_k, -\mathbf{k}\}$, with \mathbf{k} the spatial components of the relative four-momentum $k = \frac{1}{2}(k_1 - k_2)$, the propagator for the off-shell particle 2 can be written

$$\begin{aligned} &\frac{1}{m - k_2} \\ &= \frac{m}{E_k} \sum_\lambda \left\{ \frac{u_2^+(\mathbf{k}, \lambda) \bar{u}_2^+(\mathbf{k}, \lambda)}{2E_k - W} - \frac{u_2^-(\mathbf{k}, \lambda) \bar{u}_2^-(\mathbf{k}, \lambda)}{W} \right\}, \end{aligned} \quad (\text{E10})$$

where u_2^ρ are the spinors defined in Eq. (E5). Substituting this into Eq. (2.2), allowing for relative momenta in all directions as defined in Eq. (E9), and keeping all the indices, gives the following equations

$$\begin{aligned} M_{\lambda_1 \lambda_2, \lambda'_1 \lambda'_2}^{\rho_1 \rho_2, \rho'_1 \rho'_2}(p, p'; P) &= \bar{V}_{\lambda_1 \lambda_2, \lambda'_1 \lambda'_2}^{\rho_1 \rho_2, \rho'_1 \rho'_2}(p, p'; P) \\ &- \sum_{\mu_1 \mu_2 \rho k} \bar{V}_{\lambda_1 \lambda_2, \mu_1 \mu_2}^{\rho_1 \rho_2, (+)\rho}(p, k; P) G^\rho(k) M_{\mu_1 \mu_2, \lambda'_1 \lambda'_2}^{(+)\rho, \rho'_1 \rho'_2}(k, p'; P) \end{aligned} \quad (\text{E11})$$

where

$$\sum_{\mu_1 \mu_2 \rho k} = \int \frac{d^3 k}{(2\pi)^3} \sum_{\mu_1=-1/2}^{1/2} \sum_{\mu_2=-1/2}^{1/2} \sum_{\rho=-}^{+} \quad (\text{E12})$$

and, using the notation of Eq. (E9), the matrix elements of the kernel (and scattering amplitude) are

$$\begin{aligned} \overline{V}_{\lambda_1 \lambda_2, \lambda'_1 \lambda'_2}^{\rho_1 \rho_2, \rho'_1 \rho'_2}(p, p'; P) &= \frac{m^2}{E_p E_{p'}} \\ &\times \langle (p, \theta, \phi) \lambda_1 \lambda_2; \rho_1 \rho_2 | \overline{V}(p, p'; P) | (p', \theta', \phi') \lambda'_1 \lambda'_2; \rho'_1 \rho'_2 \rangle \end{aligned} \quad (\text{E13})$$

and the propagators for $\rho = +$ and $-$ states are

$$G^+(k) = \frac{1}{2E_k - W}, \quad G^-(k) = -\frac{1}{W}. \quad (\text{E14})$$

Note that the factors of m/E_k in (E10) and the volume integral in (2.2) are absorbed if the kernel and scattering amplitude are normalized as in Eq. (E13). [The propagators (E14) differ by a factor of $k^2/(2\pi)^3$ from the $g^\pm(k)$ of Eq. (2.89) of Ref. I; in this paper this factor is written explicitly in all equations.]

Equation (E11) is simplified further by expanding the kernel and scattering amplitude in states with good angular momentum. These states are defined in the next section.

4. Angular momentum states

States of good angular momentum are projected from the general two-particle states (E9) by integrating over the polar and azimuthal angles, as was done in Ref. [13]. The result is

$$\begin{aligned} |pJM_J, \lambda_1 \lambda_2; \rho_1 \rho_2\rangle &\equiv \eta_J \int d\Omega_p D_{M_J, \lambda}^{J*}(\phi, \theta, 0) \\ &\times |(p, \theta, \phi) \lambda_1 \lambda_2; \rho_1 \rho_2\rangle, \end{aligned} \quad (\text{E15})$$

where the following shorthand notation

$$\begin{aligned} \lambda &= \lambda_1 - \lambda_2 \\ \eta_J &= \sqrt{\frac{2J+1}{4\pi}} \\ \int d\Omega_p &\equiv \int_0^{2\pi} d\phi \int_0^\pi d\theta \sin\theta \end{aligned} \quad (\text{E16})$$

will be used repeatedly below. Equation (E15) agrees with Eq. (4.8) of Ref. [13].

The coupling coefficients (compare with Eq. (2.84) of Ref. I) are

$$\begin{aligned} \langle \mathbf{p} | JM_J, \lambda_1 \lambda_2; \rho_1 \rho_2 \rangle & \\ &\equiv \langle (p, \theta, \phi) \lambda_1 \lambda_2; \rho_1 \rho_2 | pJM_J, \lambda_1 \lambda_2; \rho_1 \rho_2 \rangle \\ &= \eta_J D_{M_J, \lambda}^{J*}(\phi, \theta, 0) \end{aligned} \quad (\text{E17})$$

and the partial wave expansion of the states becomes

$$\begin{aligned} |(p, \theta, \phi) \lambda_1 \lambda_2; \rho_1 \rho_2\rangle & \\ &= \sum_{JM_J} \eta_J D_{M_J, \lambda}^J(\phi, \theta, 0) |pJM_J, \lambda_1 \lambda_2; \rho_1 \rho_2\rangle. \end{aligned} \quad (\text{E18})$$

The normalization condition

$$\eta_J^2 \int d\Omega_p D_{M_J, \lambda}^{J*}(\phi, \theta, 0) D_{M_J', \lambda}^{J'}(\phi, \theta, 0) = \delta_{JJ'} \delta_{M_J M_J'} \quad (\text{E19})$$

insures that (E15) and (E18) are consistent.

5. Symmetries of the angular momentum states

a. Parity

Under the $\mathcal{Y} = \exp(-i\pi\mathcal{J}_y)\mathcal{P}$ transformation (parity followed by rotation through angle π about the \hat{y} axis), the nucleon helicity spinors transform to

$$\begin{aligned} \mathcal{Y} u_1^p(\mathbf{p}, \lambda) &= \gamma^0 N_\rho(p\lambda)(-i\sigma_y)\chi_\lambda(\theta) \\ &= \rho(-1)^{1/2+\lambda} u_1^p(\mathbf{p}, -\lambda) \\ \mathcal{Y} u_2^p(\mathbf{p}, \lambda) &= \gamma^0 N_\rho(p\lambda)(-i\sigma_y)\chi_{-\lambda}(\theta) \\ &= \rho(-1)^{1/2-\lambda} u_2^p(\mathbf{p}, -\lambda). \end{aligned} \quad (\text{E20})$$

In the notation of Eq. (E9), the parity relation for NN states can be written

$$\begin{aligned} \mathcal{Y} |(p, \theta, 0) \lambda_1 \lambda_2; \rho_1 \rho_2\rangle & \\ &= \rho_1 \rho_2 (-1)^{1+\lambda} |(p, \theta, 0) -\lambda_1 -\lambda_2; \rho_1 \rho_2\rangle. \end{aligned} \quad (\text{E21})$$

Note that $(-1)^{2\lambda} = 1$, showing that these results are identical to those previously given in Eqs. (A14) and (A17) of Ref. I.

The effect of parity on the states of good angular momentum follows from (E15) and (E21)

$$\begin{aligned} \mathcal{P} |pJM_J, \lambda_1 \lambda_2; \rho_1 \rho_2\rangle &= \eta_J \int d\Omega_p D_{M_J, \lambda}^{J*}(\phi, \theta, 0) \\ &\times \mathcal{R}(\phi, \theta, 0) \mathcal{R}^{-1}(0, \pi, 0) \mathcal{Y} |(p, 0, 0) \lambda_1 \lambda_2; \rho_1 \rho_2\rangle \\ &= \eta_J \int d\Omega_{p'} \sum_{\lambda'} D_{M_J, \lambda'}^{J*}(\phi', \theta', 0) D_{\lambda', \lambda}^{J*}(0, \pi, 0) \\ &\times \mathcal{R}(\phi', \theta', 0) \rho_1 \rho_2 (-1)^{1+\lambda} |(p, 0, 0) -\lambda_1 -\lambda_2; \rho_1 \rho_2\rangle \\ &= \rho_1 \rho_2 (-1)^{J-1} |pJM_J, -\lambda_1 -\lambda_2; \rho_1 \rho_2\rangle. \end{aligned} \quad (\text{E22})$$

The second line follows from the first by introducing the rotation $\mathcal{R}(\phi', \theta', 0)$ with $0 \leq \phi' \leq 2\pi$ and $0 \leq \theta' \leq \pi$ such that $\mathcal{R}(\phi', \theta', 0) = \mathcal{R}(\phi, \theta, 0) \mathcal{R}^{-1}(0, \pi, 0)$, and using the group representation properties of the D matrices. The second follows from the relations $D_{\lambda', \lambda}^J(0, \pi, 0) = d_{\lambda', \lambda}^J(\pi) = (-1)^{J-\lambda} \delta_{\lambda', -\lambda}$.

It is convenient to work with good angular momentum states that also have definite parity. From (E22) these are

$$\begin{aligned} |pJM_J, \lambda_1 \lambda_2; \rho_1 \rho_2; \delta_P\rangle &\equiv |pJM_J, \lambda_1 \lambda_2; \rho_1 \rho_2\rangle \\ &+ \delta_P \rho_1 \rho_2 (-1)^{J-1} |pJM_J, -\lambda_1 -\lambda_2; \rho_1 \rho_2\rangle \end{aligned} \quad (\text{E23})$$

where

$$\mathcal{P} |pJM_J, \lambda_1 \lambda_2; \rho_1 \rho_2; \delta_P\rangle = \delta_P |pJM_J, \lambda_1 \lambda_2; \rho_1 \rho_2; \delta_P\rangle. \quad (\text{E24})$$

b. Particle interchange

Under particle interchange \mathcal{P}_{12} , *either* the Dirac indices of the two spinors are exchanged, *or* the helicity and ρ -spin labels are exchanged. These two forms of the interchange operator are

$$\begin{aligned} \mathcal{P}_{12} |(p, \theta, 0) \lambda_1 \lambda_2; \rho_1 \rho_2\rangle &= u_{1\beta}^{\rho_1}(\mathbf{p}, \lambda_1) u_{2\alpha}^{\rho_2}(\mathbf{p}, \lambda_2) \\ &= (-1)^{1+\lambda} \mathcal{R}_y(\pi) |(p, \theta, 0) \lambda_2 \lambda_1; \rho_2 \rho_1\rangle, \end{aligned} \quad (\text{E25})$$

where the relations (E7) and (E8) were used in the last step. Since $\mathcal{R}_y(2\pi) = 1$, this result is identical to (A27) and the equation following (A31) of Ref. I.

The effect of the interchange operator on the states of good angular momentum is computed in the same way as the effect of the parity operator. Using (E25) with $\mathcal{R}_y(\pi)$ replaced by $\mathcal{R}_y^{-1}(\pi)$ gives

$$\begin{aligned} \mathcal{P}_{12} |pJM_J, \lambda_1 \lambda_2; \rho_1 \rho_2\rangle &= \eta_J \int d\Omega_p D_{M_J, \lambda}^{J*}(\phi, \theta, 0) \\ &\times \mathcal{R}(\phi, \theta, 0) \mathcal{R}^{-1}(0, \pi, 0) (-1)^{1+\lambda} |(p, 0, 0) \lambda_2 \lambda_1; \rho_2 \rho_1\rangle \\ &= \eta_J \int d\Omega_{p'} \sum_{\lambda'} D_{M_J, \lambda'}^{J*}(\phi', \theta', 0) D_{\lambda', \lambda}^{J*}(0, \pi, 0) \\ &\times \mathcal{R}(\phi', \theta', 0) (-1)^{1+\lambda} |(p, 0, 0) \lambda_2 \lambda_1; \rho_2 \rho_1\rangle \\ &= (-1)^{J-1} |pJM_J, \lambda_2 \lambda_1; \rho_2 \rho_1\rangle. \end{aligned} \quad (\text{E26})$$

This agrees with Eq. (A32) of Ref. I.

6. Partial wave expansion of the kernel

Using the fact that the kernel (and scattering amplitude) conserves angular momentum, the matrix elements of the kernel in angular momentum space are

$$\begin{aligned} \langle pJM_J, \lambda_1 \lambda_2; \rho_1 \rho_2 | \bar{V}(p, p'; P) | p'J'M_{J'} \lambda'_1 \lambda'_2; \rho'_1 \rho'_2 \rangle \\ = \bar{V}_{\lambda_1 \lambda_2, \lambda'_1 \lambda'_2}^{J \rho_1 \rho_2, \rho'_1 \rho'_2}(p, p'; P) \delta_{JJ'} \delta_{M_J M_{J'}}, \end{aligned} \quad (\text{E27})$$

where the angular momentum states were defined in Eq. (E15). Setting $J = J'$ and $M_J = M_{J'}$ gives the

following partial wave projections

$$\begin{aligned} \bar{V}_{\lambda_1 \lambda_2, \lambda'_1 \lambda'_2}^{J \rho_1 \rho_2, \rho'_1 \rho'_2}(p, p'; P) \\ = \eta_J^2 \int \int d\Omega_p d\Omega_{p'} D_{M_J, \lambda}^J(\phi_p, \theta_p, 0) D_{M_J, \lambda'}^{J*}(\phi_{p'}, \theta_{p'}, 0) \\ \times \bar{V}_{\lambda_1 \lambda_2, \lambda'_1 \lambda'_2}^{\rho_1 \rho_2, \rho'_1 \rho'_2}(p, p'; P). \end{aligned} \quad (\text{E28})$$

The most general partial wave expansion wave expansion for \bar{V} is therefore

$$\begin{aligned} \bar{V}_{\lambda_1 \lambda_2, \lambda'_1 \lambda'_2}^{\rho_1 \rho_2, \rho'_1 \rho'_2}(p, p'; P) = \sum_{JM_J} \bar{V}_{\lambda_1 \lambda_2, \lambda'_1 \lambda'_2}^J(p, p'; P) \\ \times \eta_J^2 D_{M_J, \lambda}^{J*}(\phi_p, \theta_p, 0) D_{M_J, \lambda'}^J(\phi_{p'}, \theta_{p'}, 0). \end{aligned} \quad (\text{E29})$$

The consistency of (E28) and (E29) is assured by the orthonormality relation (E19). The expansion (E29) is very convenient for the general derivation of the partial wave equations.

However, in order to carry out practical calculations, it is more convenient to express the partial wave relations in their simplest form. Equation (E29) can be simplified by carrying out the sum over the angular momentum projections M_J , using the addition theorem for the d functions,

$$d_{\lambda' \lambda}^J(\theta) = \sum_{M_J} D_{M_J, \lambda}^J(\phi_p, \theta_p, 0) D_{M_J, \lambda'}^{J*}(\phi_{p'}, \theta_{p'}, 0), \quad (\text{E30})$$

where $\cos \theta = \hat{\mathbf{p}} \cdot \hat{\mathbf{p}}'$. This gives an alternative form for the partial wave expansion

$$\bar{V}_{\lambda_1 \lambda_2, \lambda'_1 \lambda'_2}^{\rho_1 \rho_2, \rho'_1 \rho'_2}(p, p'; P) = \sum_J \eta_J^2 d_{\lambda' \lambda}^J(\theta) V_{\lambda_1 \lambda_2, \lambda'_1 \lambda'_2}^{J \rho_1 \rho_2, \rho'_1 \rho'_2}(p, p'; P), \quad (\text{E31})$$

which agrees with Eq. (2.85) of Ref. I. Using the orthogonality of the d matrices

$$2\pi \eta_J^2 \int_0^\infty \sin \theta d\theta d_{\lambda' \lambda}^J(\theta) d_{\lambda' \lambda}^{J'}(\theta) = \delta_{JJ'}. \quad (\text{E32})$$

gives the simple result for the partial wave projection of the kernel

$$\begin{aligned} \bar{V}_{\lambda_1 \lambda_2, \lambda'_1 \lambda'_2}^{J \rho_1 \rho_2, \rho'_1 \rho'_2}(p, p'; P) = 2\pi \int_0^\pi \sin \theta d\theta d_{\lambda' \lambda}^J(\theta) \\ \times \bar{V}_{\lambda_1 \lambda_2, \lambda'_1 \lambda'_2}^{\rho_1 \rho_2, \rho'_1 \rho'_2}(p, p'; P). \end{aligned} \quad (\text{E33})$$

This result can also be obtained directly from (E28) by averaging over the spin projections M_J , using the addition theorem (E30), and integrating over the redundant angles. If we choose the scattering to be in the $\hat{x}\hat{z}$ plane, with $\mathbf{p}' = \{0, 0, p'\}$ and $\mathbf{p} = \{p \sin \theta, 0, p \cos \theta\}$, the matrix elements and the integrals (E33) are easily evaluated.

7. Partial wave expansion of the equations

Equation (E11) can now be expanded in partial waves using the general expansion (E29). The integral with particle 1 propagating on-shell in the intermediate state,

$$\langle \bar{V}GM \rangle = \sum_{\mu_1 \mu_2 \rho k} \bar{V}_{\lambda_1 \lambda_2, \mu_1 \mu_2}^{\rho_1 \rho_2, (+)\rho}(p, k; P) G^\rho(k) M_{\mu_1 \mu_2, \lambda'_1 \lambda'_2}^{(+)\rho, \rho'_1 \rho'_2}(k, p'; P), \quad (\text{E34})$$

can be easily reduced if both \bar{V} and M are expanded in partial waves using (E29), and the integral over Ω_k carried out using the orthogonality relations (E19). Recalling that $\lambda = \lambda_1 - \lambda_2$ (and similarly for λ' and μ), the result becomes

$$\begin{aligned} \langle \bar{V}GM \rangle &= \int_0^\infty \frac{k^2 dk}{(2\pi)^3} \int d\Omega_k \sum_{\substack{\mu_1 \mu_2 \rho \\ J J' M_J M_{J'}}} \bar{V}_{\lambda_1 \lambda_2, \mu_1 \mu_2}^{J \rho_1 \rho_2, (+)\rho}(p, k; P) G^\rho(k) M_{\mu_1 \mu_2, \lambda'_1 \lambda'_2}^{J' (+)\rho, \rho'_1 \rho'_2}(k, p'; P) \\ &\quad \times \eta_J^2 \eta_{J'}^2 D_{M_J, \lambda}^{J*}(\phi, \theta, 0) D_{M_J, \mu}^J(\phi_k, \theta_k, 0) D_{M_{J'}, \mu}^{J'*}(\phi_k, \theta_k, 0) D_{M_{J'}, \lambda'}^{J'}(\phi', \theta', 0) \\ &= \int_0^\infty \frac{k^2 dk}{(2\pi)^3} \sum_{\substack{\mu_1 \mu_2 \rho \\ J M_J}} \bar{V}_{\lambda_1 \lambda_2, \mu_1 \mu_2}^{J \rho_1 \rho_2, (+)\rho}(p, k; P) G^\rho(k) M_{\mu_1 \mu_2, \lambda'_1 \lambda'_2}^{J (+)\rho, \rho'_1 \rho'_2}(k, p'; P) \\ &\quad \times \eta_J^2 D_{M_J, \lambda}^{J*}(\phi, \theta, 0) D_{M_J, \lambda'}^J(\phi', \theta', 0). \end{aligned} \quad (\text{E35})$$

Comparing this with the partial wave expansions for $V(p, p'; P)$ and $M(p, p'; P)$ leads directly to the partial wave equations

$$\begin{aligned} M_{\lambda_1 \lambda_2, \lambda'_1 \lambda'_2}^{J \rho_1 \rho_2, \rho'_1 \rho'_2}(p, p'; P) &= \bar{V}_{\lambda_1 \lambda_2, \lambda'_1 \lambda'_2}^{J \rho_1 \rho_2, \rho'_1 \rho'_2}(p, p'; P) \\ &\quad - \int_0^\infty \frac{k^2 dk}{(2\pi)^3} \sum_{\mu_1 \mu_2 \rho} \bar{V}_{\lambda_1 \lambda_2, \mu_1 \mu_2}^{J \rho_1 \rho_2, (+)\rho}(p, k; P) G^\rho(k; P) M_{\mu_1 \mu_2, \lambda'_1 \lambda'_2}^{J (+)\rho, \rho'_1 \rho'_2}(k, p'; P). \end{aligned} \quad (\text{E36})$$

These equations allow us to find $M_{\lambda_1 \lambda_2, \lambda'_1 \lambda'_2}^{J \rho_1 \rho_2, \rho'_1 \rho'_2}$ once we know $M_{\lambda_1 \lambda_2, \lambda'_1 \lambda'_2}^{J (+)\rho_2, \rho'_1 \rho'_2}$. To find $M_{\lambda_1 \lambda_2, \lambda'_1 \lambda'_2}^{J (+)\rho_2, \rho'_1 \rho'_2}$ we need only set $\rho_1 = +$ in Eq. (E36). But these are not the equations we will solve; they must first be simplified using parity and particle interchange symmetry.

8. Separation into channels with good parity and interchange symmetry

Parity is conserved and, as discussed in Appendix B, interchange symmetry is imposed by explicitly antisymmetrizing the kernel. Therefore, the equations can be decoupled into channels with good parity and interchange symmetry.

Suppressing the momentum dependence (except for the relative energy, p_0 , of the final state pair), the partial wave expression of the antisymmetrized kernel is

$$\begin{aligned} &\bar{V}_{\lambda_1 \lambda_2, \lambda'_1 \lambda'_2}^{J \rho_1 \rho_2, \rho'_1 \rho'_2} \\ &= \frac{1}{2} \left\{ V_{\text{dir } \lambda_1 \lambda_2, \lambda'_1 \lambda'_2}^{J \rho_1 \rho_2, \rho'_1 \rho'_2}(p_0) + \delta_I V_{\text{ex } \lambda_1 \lambda_2, \lambda'_1 \lambda'_2}^{J \rho_1 \rho_2, \rho'_1 \rho'_2}(p_0) \right\} \\ &= \frac{1}{2} \left\{ V_{\text{dir } \lambda_1 \lambda_2, \lambda'_1 \lambda'_2}^{J \rho_1 \rho_2, \rho'_1 \rho'_2}(p_0) + \eta \delta_I V_{\text{dir } \lambda_2 \lambda_1, \lambda'_1 \lambda'_2}^{J \rho_2 \rho_1, \rho'_1 \rho'_2}(-p_0) \right\}, \end{aligned} \quad (\text{E37})$$

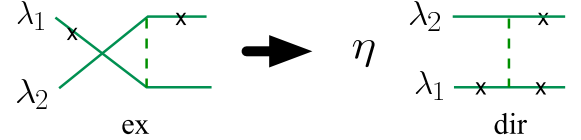

FIG. 27: (Color on line) Diagrammatic representation of the transformation of the exchange term, with relative energy p_0 into a direct term with relative energy $-p_0$ (called an “alternating” term in Ref. I). The phase η arises from the exchange operation derived in Eq. (E26).

where V_{dir} are the Dirac matrix elements of the direct kernel defined in Eq. (B16) above, $\delta_I = (-1)^I$, and $\eta = (-1)^{J-1}$. In the last line Eq. (E26) was used to express the exchange diagram in terms of the direct diagram, as illustrated in Fig. 27. Equation (E37) displays the fact that the exchange of particles in the final state (equivalent to $\lambda_1 \leftrightarrow \lambda_2$, $\rho_1 \leftrightarrow \rho_2$, and $p_0 \rightarrow -p_0$) multiplies the kernel by the phase δ_I , as expected.

An antisymmetrized kernel with good parity can be constructed from (E37) by combining terms with differ-

TABLE XI: The 16 independent helicity amplitudes $\mathbf{V}_{\lambda_2\lambda'_2}(\delta_{p_0}, \delta_S) \equiv \mathbf{V}_{++\lambda_2\lambda'_2}^{J++}(\delta_{p_0}, \delta_S)$. Only the sign of the helicity is specified: $\lambda_2 = +$ means $\lambda_2 = +1/2$. The parity of each potential is $\eta\delta_S$, where $\eta \equiv (-1)^{J-1}$. The symmetry \mathcal{P}_{12} under particle interchange is shown.

name	amplitude	\mathcal{P}_{12}	name	amplitude	\mathcal{P}_{12}
v_1	$\mathbf{V}_{++}(+, -)$	η	v_2	$\mathbf{V}_{--}(-, -)$	η
v_3	$\mathbf{V}_{+-}(+, -)$	η	v_4	$\mathbf{V}_{-+}(-, -)$	η
v_5	$\mathbf{V}_{++}(-, -)$	$-\eta$	v_6	$\mathbf{V}_{--}(+, -)$	$-\eta$
v_7	$\mathbf{V}_{+-}(-, -)$	$-\eta$	v_8	$\mathbf{V}_{-+}(+, -)$	$-\eta$
v_9	$\mathbf{V}_{++}(+, +)$	η	v_{10}	$\mathbf{V}_{--}(+, +)$	η
v_{11}	$\mathbf{V}_{+-}(+, +)$	η	v_{12}	$\mathbf{V}_{-+}(+, +)$	η
v_{13}	$\mathbf{V}_{++}(-, +)$	$-\eta$	v_{14}	$\mathbf{V}_{--}(-, +)$	$-\eta$
v_{15}	$\mathbf{V}_{+-}(-, +)$	$-\eta$	v_{16}	$\mathbf{V}_{-+}(-, +)$	$-\eta$

TABLE XII: Symmetries of the 16 independent kernels with $\rho_1 = \rho'_1 = +$ and four different combinations of $\{\rho_2, \rho'_2\}$. For convenience, the values of δ_{p_0} and δ_S taken from Table XI are given. In each case the parity is $\rho'_2\eta\delta_S$ and the exchange symmetry is $\eta\delta_{p_0}(\rho_2\rho'_2\delta_S)^{(\lambda_1-\lambda_2)}$. All phases except δ_{p_0} and δ_S are in terms of η ; for \pm read $\pm\eta$.

name	$\{\rho_2\rho'_2\} =$		++		+-		-+		--	
	δ_S	δ_{p_0}	\mathcal{P}	\mathcal{P}_{12}	\mathcal{P}	\mathcal{P}_{12}	\mathcal{P}	\mathcal{P}_{12}	\mathcal{P}	\mathcal{P}_{12}
v_1	-	+	-	+	+	+	-	+	+	+
v_2	-	-	-	+	+	-	-	-	+	+
v_3	-	+	-	+	+	+	-	+	+	+
v_4^a	-	-	-	+	+	-	-	-	+	+
v_5	-	-	-	-	+	-	-	-	+	-
v_6	-	+	-	-	+	+	-	+	+	-
v_7	-	-	-	-	+	-	-	-	+	-
v_8^a	-	+	-	-	+	+	-	+	+	-
v_9	+	+	+	+	-	+	+	+	-	+
v_{10}	+	+	+	+	-	-	+	-	-	+
v_{11}	+	+	+	+	-	+	+	+	-	+
v_{12}^a	+	+	+	+	-	-	+	-	-	+
v_{13}	+	-	+	-	-	-	+	-	-	-
v_{14}	+	-	+	-	-	+	+	+	-	-
v_{15}	+	-	+	-	-	-	+	-	-	-
v_{16}^a	+	-	+	-	-	+	+	+	-	-

^aThe phase of these kernels under \mathcal{P}_{12} in the +- and -+ sectors differs from Ref. I.

ent helicities. We could define (but will not use)

$$\overline{\overline{V}}_{\lambda_1\lambda_2, \lambda'_1\lambda'_2}^{J\rho_1\rho_2, \rho'_1\rho'_2} = \left\{ \overline{V}_{\lambda_1\lambda_2, \lambda'_1\lambda'_2}^{J\rho_1\rho_2, \rho'_1\rho'_2} + \delta_S \overline{V}_{\lambda_1\lambda_2, -\lambda'_1 -\lambda'_2}^{J\rho_1\rho_2, \rho'_1\rho'_2} \right\}. \quad (\text{E38})$$

where $\delta_S = \delta_P \rho'_1 \rho'_2 \eta$. Under parity, the phase of this kernel and the good parity state (E24) are both δ_P .

In this paper, instead of using the kernels (E38), we

introduce the related family

$$\begin{aligned} & \mathbf{V}_{\lambda_1\lambda_2, \lambda'_1\lambda'_2}^{J\rho_1\rho_2, \rho'_1\rho'_2}(\delta_{p_0}, \delta_S) \\ &= \frac{1}{2} \left\{ V_{\text{dir } \lambda_1\lambda_2, \lambda'_1\lambda'_2}^{J\rho_1\rho_2, \rho'_1\rho'_2}(p_0) + \delta_S V_{\text{dir } \lambda_1\lambda_2, -\lambda'_1 -\lambda'_2}^{J\rho_1\rho_2, \rho'_1\rho'_2}(p_0) \right. \\ & \left. + \delta_{p_0} V_{\text{dir } \lambda_1\lambda_2, \lambda'_1\lambda'_2}^{J\rho_2\rho_1, \rho'_1\rho'_2}(-p_0) + \delta_{p_0} \delta_S V_{\text{dir } \lambda_1\lambda_2, -\lambda'_1 -\lambda'_2}^{J\rho_2\rho_1, \rho'_1\rho'_2}(-p_0) \right\}, \quad (\text{E39}) \end{aligned}$$

where δ_{p_0} is the phase of \mathbf{V} under $p_0 \rightarrow -p_0$ and $\rho_1 \leftrightarrow \rho_2$, and δ_S is phase introduced in Eq. (E38). *These linear*

TABLE XIII: Symmetries of the 16 independent off-shell kernels with $\rho_1 = -$ and $\rho'_1 = +$ and four different combinations of $\{\rho_2, \rho'_2\}$. In each case the parity is $\rho'_2 \eta \delta_S$ and the exchange symmetry is $\eta \delta_{p_0} (-\rho_2 \rho'_2 \delta_S)^{\lambda_1 - \lambda_2}$. All phases are in terms of η ; for \pm read $\pm \eta$.

$\{\rho_2 \rho'_2\} =$	++		+-		-+		--	
name	\mathcal{P}	\mathcal{P}_{12}	\mathcal{P}	\mathcal{P}_{12}	\mathcal{P}	\mathcal{P}_{12}	\mathcal{P}	\mathcal{P}_{12}
v_1	-	+	+	+	-	+	+	+
v_2	-	-	+	+	-	+	+	-
v_3	-	+	+	+	-	+	+	+
v_4	-	-	+	+	-	+	+	-
v_5	-	-	+	-	-	-	+	-
v_6	-	+	+	-	-	-	+	+
v_7	-	-	+	-	-	-	+	-
v_8	-	+	+	-	-	-	+	+
v_9	+	+	-	+	+	+	-	+
v_{10}	+	-	-	+	+	+	-	-
v_{11}	+	+	-	+	+	+	-	+
v_{12}	+	-	-	+	+	+	-	-
v_{13}	+	-	-	-	+	-	-	-
v_{14}	+	+	-	-	+	-	-	+
v_{15}	+	-	-	-	+	-	-	-
v_{16}	+	+	-	-	+	-	-	+

combinations are very similar to those used in Ref. I, with the few differences identified in Table XII. The notational changes introduced in this paper simplify some of the discussion but do not change any of the numerical results found in Ref. I.

The phase of the kernels (E39) under the parity transformation is still $\delta_P = \rho'_1 \rho'_2 \eta \delta_S$, but their exchange symmetries are more complicated. Before looking at these symmetries, note that these kernels have the special feature that the helicities of the outgoing particles are identical in every term. It turns out that (E39) are in one-to-one correspondence with (E38) provided the phases are matched correctly. If $\lambda_1 = \lambda_2$, Eqs. (E38) and (E39) are identical (provided $\delta_I = \eta \delta_{p_0}$). If $\lambda_1 = -\lambda_2$ (the only other possibility) we can use the parity relation (E22) to transform each of the last two terms in (E39) into

$$\begin{aligned}
 V_{\text{dir } \lambda_1 \lambda_2, \lambda'_1 \lambda'_2}^{J \rho_2 \rho_1, \rho'_1 \rho'_2}(-p_0) &= \rho_T V_{\text{dir } -\lambda_1 -\lambda_2, -\lambda'_1 -\lambda'_2}^{J \rho_2 \rho_1, \rho'_1 \rho'_2}(-p_0) \\
 &= \rho_T V_{\text{dir } \lambda_2 \lambda_1, -\lambda'_1 -\lambda'_2}^{J \rho_2 \rho_1, \rho'_1 \rho'_2}(-p_0), \quad (\text{E40})
 \end{aligned}$$

where $\rho_T \equiv \rho_1 \rho_2 \rho'_1 \rho'_2$, and the last line is true only because $\lambda_1 \neq \lambda_2$. This has the effect of interchanging λ_1 and λ_2 , but also changes the signs of the initial helicities, and hence has the additional effect of interchanging the last two terms of Eq. (E39). Hence, the result will be identical to (E38) if $\delta_I = \eta \delta_{p_0} \rho_T \delta_S$. The results for both equal and unequal λ_i can therefore be combined into the compact formula $\delta_I = \eta \delta_{p_0} (\rho_T \delta_S)^{\lambda_1 - \lambda_2}$.

So the only difference between the sets of kernels (E39) and (E38) are the definitions of the phases. We found

that the the set (E39) were more convenient to work with in practical calculations. and the preceding argument shows that the phases of these kernels are

$$\begin{aligned}
 \delta_P &= \rho'_1 \rho'_2 \eta \delta_S & \text{parity} \\
 \delta_I &= \eta \delta_{p_0} (\rho_T \delta_S)^{\lambda_1 - \lambda_2} & \text{exchange}
 \end{aligned} \quad (\text{E41})$$

If particle 1 is on-shell, so that $\rho_1 = \rho'_1 = +$, there are 16 independent kernels for each J, ρ_2 and ρ'_2 . Using parity and exchange symmetry, the amplitudes can always be arranged so that $\lambda_1 = \lambda'_1 = +1/2$, leaving the helicities of particle 2 and the phases δ_S and δ_{p_0} unconstrained. Following the notation of Ref. I, the 16 independent amplitudes, denoted v_i , are defined in Table XI. The parity and interchange symmetry of these kernels is also given in the table.

Similar symmetries exist for the kernels with one or two negative rho-spin indices, but as given in Eq. (E41), the negative parity of the negative energy spinors alters the relations. The symmetries of all the kernels with $\rho_1 = \rho'_1 = +$ are summarized in Table XII.

In some applications (not discussed in this paper) kernels (and scattering amplitudes) are needed in which *both* particles in the final state off-shell. This requires the use of kernels with $\rho_1 = -$. The symmetries of these kernels are given in Table XIII. Since the parity is defined by the structure of the initial state, the parity of these potentials is identical to those with $\rho_1 = +$. The exchange symmetry, defined by the final state, is unchanged when $\lambda_1 = \lambda_2$, but the use of (E41) introduces an extra minus sign when $\lambda_1 \neq \lambda_2$.

TABLE XIV: Symmetries of the four independent NN scattering channels. The isospin assignments are given for $J = 0, 1, 2, \dots$.

channel	\mathcal{P}	\mathcal{P}_{12}	isospin
singlet (S)	$-\eta$	η	$0, 1, 0, \dots$
triplet (T)	$-\eta$	$-\eta$	$1, 0, 1, \dots$
coupled (C)	η	η	$0, 1, 0, \dots$
virtual (V)	η	$-\eta$	

Scattering is divided into four distinct channels, depending on the symmetry under parity and interchange. These four groups are defined in Table XIV. Singlet and triplet channels have $L = J$, and thus, for the positive ρ -spin sector, must have parity equal to $(-1)^J$, leading to $\delta_S = -1$. Under particle interchange, the singlet channel with total spin equal to zero gives a phase equal to η ; requiring this to be antisymmetric leads to the isospin assignment $I = (1 - (-1)^J)/2$. For the triplet channel the symmetry is $-\eta$ and the isospin is $I = (1 + (-1)^J)/2$. The coupled channel has $L = J \pm 1$, giving $\delta_S = +1$, symmetry equal to η , and isospin assignment $I = (1 - (-1)^J)/2$. Finally, it is possible to construct an unphysical virtual coupled channel state with parity η and interchange symmetry $-\eta$, but this state has $\delta_{p_0} = -1$ in all four kernels, giving no scattering when $p_0 = 0$ (the on-shell condition). While they completely decouple from physical two-body scattering, they do contribute, in principle, to three-body scattering [13].

Organizing the helicity and ρ -spin of the initial state in a column vector with labels $|\lambda_2, \rho_2'\rangle$ (by assumption, $\lambda_1' = +$ and $\rho_1' = +$)

$$|\Gamma\rangle = \begin{pmatrix} |+, +\rangle \\ |+, -\rangle \\ |-, +\rangle \\ |-, -\rangle \end{pmatrix}, \quad (\text{E42})$$

and picking potentials from Table XII with the correct symmetry properties for each channel, the singlet matrix is

$$\mathbf{V}_S = \begin{pmatrix} v_1^{++} & v_9^{+-} & v_3^{++} & v_{11}^{+-} \\ v_1^{-+} & v_9^{--} & v_3^{-+} & v_{11}^{--} \\ v_4^{++} & v_{16}^{+-} & v_2^{++} & v_{14}^{+-} \\ v_8^{-+} & v_{12}^{--} & v_6^{-+} & v_{10}^{--} \end{pmatrix} \quad (\text{E43})$$

the triplet matrix is

$$\mathbf{V}_T = \begin{pmatrix} v_5^{++} & v_{13}^{+-} & v_7^{++} & v_{15}^{+-} \\ v_5^{-+} & v_{13}^{--} & v_7^{-+} & v_{15}^{--} \\ v_8^{++} & v_{12}^{+-} & v_6^{++} & v_{10}^{+-} \\ v_4^{-+} & v_{16}^{--} & v_2^{-+} & v_{14}^{--} \end{pmatrix} \quad (\text{E44})$$

and the coupled matrix is

$$\mathbf{V}_C = \begin{pmatrix} v_9^{++} & v_1^{+-} & v_{11}^{++} & v_3^{+-} \\ v_9^{-+} & v_1^{--} & v_{11}^{-+} & v_3^{--} \\ v_{12}^{++} & v_8^{+-} & v_{10}^{++} & v_6^{+-} \\ v_{16}^{-+} & v_4^{--} & v_{14}^{-+} & v_2^{--} \end{pmatrix}. \quad (\text{E45})$$

In this paper, the kernels v_4, v_8, v_{12} , and v_{16} in the ρ -spin sectors $\{+, -\}$ and $\{-, +\}$ are defined with a different phase from Ref. I (see the footnote to Table XII). This phase change leads to the following correspondence between this paper and Ref. I: in the $+-$ and $-+$ sectors *only*, substitute $v_4 \leftrightarrow v_{16}$ and $v_8 \leftrightarrow v_{12}$. These substitutions bring equations (E43), (E44), and (E45) into agreement with equations (2.106), (2.107), and (2.108) of Ref. I. In conclusion: *the matrices given in this paper are identical to the matrices given in Ref. 1; only the names of some of the elements have changed.*

The matrices \mathbf{V}^{off} that couple an on-shell initial state (with $\rho_1' = +$) to a final state when $\rho_1 = -$ (present only if *both* particles in the final state are off-shell) can be constructed from the symmetries in Table XIII. The singlet kernel is

$$\mathbf{V}_S^{\text{off}} = \begin{pmatrix} v_1^{++} & v_9^{+-} & v_3^{++} & v_{11}^{+-} \\ v_1^{-+} & v_9^{--} & v_3^{-+} & v_{11}^{--} \\ v_8^{++} & v_{12}^{+-} & v_6^{++} & v_{10}^{+-} \\ v_4^{-+} & v_{16}^{--} & v_2^{-+} & v_{14}^{--} \end{pmatrix}, \quad (\text{E46})$$

the triplet kernel is

$$\mathbf{V}_T^{\text{off}} = \begin{pmatrix} v_5^{++} & v_{13}^{+-} & v_7^{++} & v_{15}^{+-} \\ v_5^{-+} & v_{13}^{--} & v_7^{-+} & v_{15}^{--} \\ v_4^{++} & v_{16}^{+-} & v_2^{++} & v_{14}^{+-} \\ v_8^{-+} & v_{12}^{--} & v_6^{-+} & v_{10}^{--} \end{pmatrix} \quad (\text{E47})$$

and the coupled matrix is

$$\mathbf{V}_C^{\text{off}} = \begin{pmatrix} v_9^{++} & v_1^{+-} & v_{11}^{++} & v_3^{+-} \\ v_9^{-+} & v_1^{--} & v_{11}^{-+} & v_3^{--} \\ v_{16}^{++} & v_4^{+-} & v_{14}^{++} & v_2^{+-} \\ v_{12}^{-+} & v_8^{--} & v_{10}^{-+} & v_6^{--} \end{pmatrix}. \quad (\text{E48})$$

With this notation the partial wave equations (E36) with parity and particle interchange symmetry as defined in Table XIV can be written

$$\mathbf{M}_I = \mathbf{V}_I - \int_0^\infty \frac{k^2 dk}{(2\pi)^3} \mathbf{V}_I \mathbf{G} \mathbf{M}_I \quad (\text{E49})$$

where $I = \{S, T, C\}$ and the propagator matrix is

$$\mathbf{G} = \begin{pmatrix} G^+ & 0 & 0 & 0 \\ 0 & G^- & 0 & 0 \\ 0 & 0 & G^+ & 0 \\ 0 & 0 & 0 & G^- \end{pmatrix} \quad (\text{E50})$$

with G^\pm defined in Eq. (E14). These are the equations that are solved numerically.

-
- [1] F. Gross and A. Stadler, *Phys. Lett. B* **657**, 176 (2007) [arXiv:0704.1229 [nucl-th]].
- [2] F. Gross, *Phys. Rev.* **186**, 1448 (1969); *Phys. Rev. D* **10**, 223 (1974); *Phys. Rev. C* **26**, 2203 (1982).
- [3] F. Gross, *Phys. Rev. C* **26**, 2226 (1982).
- [4] F. Gross and D. O. Riska, *Phys. Rev. C* **36**, 1928 (1987).
- [5] F. Gross, J. W. Van Orden, and K. Holinde, *Phys. Rev. C* **45**, 2094 (1992). Referred to as Ref. I.
- [6] V. G. J. Stoks, R. A. M. Komp, M. C. M. Rentmeester and J. J. de Swart, *Phys. Rev. C* **48**, 792 (1993).
- [7] R. B. Wiringa, V. G. J. Stoks, and R. Schiavilla, *Phys. Rev. C* **51**, 38 (1995).
- [8] R. Machleidt, *Rev. C* **63**, 024001 (2001).
- [9] The NN data base maintained by the Center for Nuclear Studies (CNS) at the George Washington University, found at <http://gwdac.phys.gwu.edu/>. Our reference is the SP05 (2005) set dated 4/03/05.
- [10] The Nijmegen group's NN-OnLine data base, found at <http://nn-online.org/>.
- [11] J. R. Bergervoet, P. C. van Campen, W. A. van der Sanden, and J. J. de Swart, *Phys. Rev. C* **38**, 15 (1988).
- [12] A. Stadler and F. Gross, *Phys. Rev. Lett.* **78**, 26 (1997).
- [13] A. Stadler, F. Gross and M. Frank, *Phys. Rev. C* **56**, 2396 (1997).
- [14] E. E. Salpeter and H. A. Bethe, *Phys. Rev.* **84**, 1232 (1951).
- [15] SAID interactive dial-in program, R. A. Arndt, private communication.
- [16] J. J. de Swart, C. P. F. Terheggen and V. G. J. Stoks, Int. Symp. on the Deuteron, Dubna, Russia, July, 1995, arXiv:nucl-th/9509032.
- [17] V. G. J. Stoks, R. A. M. Klomp, C. P. F. Terheggen, and J. J. de Swart, *Phys. Rev. C* **49**, 2950 (1994).
- [18] M. C. M. Rentmeester, J. J. de Swart, and R. G. E. Timmermans, private communication.
- [19] W. Dilg, *Phys. Rev. C* **11**, 103 (1975).
- [20] T.L. Houk, *Phys. Rev. C* **3**, 1886 (1971).
- [21] L. Koester and W. Nistler, *Z. Phys. A* **337**, 341 (1990).
- [22] Y. Fujita, K. Kobayashi, T. Oosaki, and R.C. Block, *Nucl. Phys. A* **258**, 1 (1976).
- [23] W.D. Allen and A.T.G. Ferguson, *Proc. Phys. Soc. London, Sec. A* **68**, 1077 (1955).
- [24] C.E. Engelke, R.E. Benenson, E. Melkonian, and J.M. Lebowitz, *Phys. Rev.* **129**, 324 (1963).
- [25] J.M. Clement, P. Stoler, C.A. Goulding, and R.W. Fairchild, *Nucl. Phys. A* **183**, 51 (1972).
- [26] P.J. Clements and A. Langsford, *Phys. Lett. B* **30**, 25 (1969).
- [27] R.E. Fields, R.L. Becker, and R.K. Adair, *Phys. Rev.* **94**, 389 (1954).
- [28] C.L. Storrs and D.H. Frisch, *Phys. Rev.* **95**, 1252 (1954).
- [29] J.C. Davis and H.H. Barschall, *Phys. Rev. C* **3**, 1798 (1971).
- [30] J.C. Davis *et al.*, *Phys. Rev. C* **4**, 1061 (1971).
- [31] Gy. Hrehuss and T. Czibók, *Phys. Lett. B* **28**, 585 (1969).
- [32] W.S. Wilburn *et al.*, *Phys. Rev. C* **52**, 2351 (1995).
- [33] E.M. Hafner *et al.*, *Phys. Rev.* **89**, 204 (1953).
- [34] J.R. Walston *et al.*, *Phys. Rev. C* **63**, 014004 (2001).
- [35] B.W. Raichle *et al.*, *Phys. Rev. Lett.* **83**, 2711 (1999).
- [36] A. Bratenahl, J.M. Peterson, and J.P. Stoering, *Phys. Rev.* **110**, 927 (1958).
- [37] G.J. Weisel *et al.*, *Phys. Rev. C* **46**, 1599 (1992).
- [38] N. Boukharouba *et al.*, *Phys. Rev. C* **65**, 014004 (2001).
- [39] D. Holslin, J. McAninch, P.A. Quin, and W. Haeberli, *Phys. Rev. Lett.* **61**, 1561 (1988).
- [40] G.S. Mutchler and J.E. Simmons, *Phys. Rev. C* **4**, 67 (1971).
- [41] W. Tornow, P.W. Lisowski, R.C. Byrd, and R.L. Walter, *Phys. Rev. Lett.* **39**, 915 (1977).
- [42] M. Schöberl *et al.*, *Nucl. Phys. A* **489**, 284 (1988).
- [43] J. Arvieux and J. Pouxé, *Phys. Lett. B* **32**, 468 (1970).
- [44] J.D. Seagrave, *Phys. Rev.* **97**, 757 (1955).
- [45] H.L. Poss, E.O. Salant, G.A. Snow, and L.C.L. Yuan, *Phys. Rev.* **87**, 11 (1952).
- [46] J.E. Brock *et al.*, *Nucl. Phys. A* **361**, 368 (1981).
- [47] J.C. Allred, A.H. Armstrong, and L. Rosen, *Phys. Rev.* **91**, 90 (1953).
- [48] E. Greiner and H. Karge, *Ann. Phys. (Leipzig)* **16**, 354 (1965).
- [49] T. Nakamura, *J. Phys. Soc. Jpn.* **15**, 1359 (1960).
- [50] S. Shirato and K. Saitoh, *J. Phys. Soc. Jpn.* **36**, 331 (1974).
- [51] W. Bürkle and G. Mertens, *Few Body Syst.* **22**, 11 (1997).
- [52] R. Fischer *et al.*, *Nucl. Phys. A* **282**, 189 (1977).
- [53] W.T. Morton, *Proc. Phys. Soc. London* **91**, 899 (1967).
- [54] P.H. Bowen *et al.*, *Nucl. Phys.* **22**, 640 (1961).
- [55] P. Clotten *et al.*, *Phys. Rev. C* **58**, 1325 (1998).
- [56] R. Garrett *et al.*, *Nucl. Phys. A* **196**, 421 (1972).
- [57] J. Brož *et al.*, *Z. Phys. A* **354**, 401 (1996).
- [58] J. Brož *et al.*, *Z. Phys. A* **359**, 23 (1997).
- [59] W. Benenson, R.L. Walter, and T.H. May, *Phys. Rev. Lett.* **8**, 66 (1962).
- [60] D.T.L. Jones and F.D. Brooks, *Nucl. Phys. A* **222**, 79 (1974).
- [61] C.L. Morris, T.K. O'Malley, J.W. May, Jr., and S.T. Thornton, *Phys. Rev. C* **9**, 924 (1974).
- [62] W. Tornow *et al.*, *Phys. Rev. C* **37**, 2326 (1988).
- [63] J. Wilczynski *et al.*, *Nucl. Phys. A* **425**, 458 (1984).
- [64] M. Ockenfels *et al.*, *Nucl. Phys. A* **534**, 248 (1991).
- [65] J.M. Peterson, A. Bratenahl, and J.P. Stoering, *Phys. Rev.* **120**, 521 (1960).
- [66] A. Galonsky and J.P. Judish, *Phys. Rev.* **100**, 121 (1955).
- [67] D.E. Groce and B.D. Sowerby, *Nucl. Phys.* **83**, 199 (1966).
- [68] R.B. Day, R.L. Mills, J.E. Perry, Jr., and F. Scherb, *Phys. Rev.* **114**, 209 (1959).
- [69] A. Langsford *et al.*, *Nucl. Phys.* **74**, 241 (1965).
- [70] B.R.S. Simpson and F.D. Brooks, *Nucl. Phys. A* **505**, 361 (1989).
- [71] G. Fink *et al.*, *Nucl. Phys. A* **518**, 561 (1990).
- [72] E.R. Flynn and P.J. Bendt, *Phys. Rev.* **128**, 1268 (1962).
- [73] J.P. Scanlon *et al.*, *Nucl. Phys.* **41**, 401 (1963).
- [74] J.J. Malanify, P.J. Bendt, T.R. Roberts, and J.E. Simmons, *Phys. Rev. Lett.* **17**, 481 (1966).
- [75] R.B. Perkins and J.E. Simmons, *Phys. Rev.* **130**, 272 (1963).
- [76] L.N. Rothenberg, *Phys. Rev. C* **1**, 1226 (1970).

- [77] T.W. Burrows, *Phys. Rev. C* **7**, 1306 (1973).
- [78] T.G. Masterson, *Phys. Rev. C* **6**, 690 (1972).
- [79] F.P. Brady *et al.*, *Phys. Rev. Lett.* **25**, 1628 (1970).
- [80] J. Sromicki *et al.*, *Phys. Rev. Lett.* **57**, 2359 (1986).
- [81] M. Drogg and D.M. Drake, *Nucl. Instrum. Methods* **160**, 143 (1979).
- [82] T.C. Montgomery *et al.*, *Phys. Rev. C* **16**, 499 (1977).
- [83] A. Bol *et al.*, *Phys. Rev. C* **32**, 623 (1985).
- [84] S. Benck, I. Slypen, V. Corcalciuc, and J-P. Meulders, *Nucl. Phys. A* **615**, 220 (1997).
- [85] R.A. Eldred, B.E. Bonner, and T.A. Cahill, *Phys. Rev. C* **12**, 1717 (1975).
- [86] N. Ryu *et al.*, *Nucl. Phys. A* **180**, 657 (1972).
- [87] P.W. Lisowski *et al.*, *Phys. Rev. Lett.* **49**, 255 (1982).
- [88] A. E. Taylor and E. Wood, *Phil. Mag.* **44**, 95 (1953).
- [89] A. Bol *et al.*, *Phys. Rev. C* **32**, 308 (1985).
- [90] H.L. Woolverton *et al.*, *Phys. Rev. C* **31**, 1673 (1985).
- [91] S.W. Johnsen *et al.*, *Phys. Rev. Lett.* **38**, 1123 (1977).
- [92] J.L. Romero *et al.*, *Phys. Rev. C* **17**, 468 (1978).
- [93] R. Garrett *et al.*, *Phys. Rev. C* **21**, 1149 (1980).
- [94] D.H. Fitzgerald *et al.*, *Phys. Rev. C* **21**, 1190 (1980).
- [95] A.J. Bersbach, R.E. Mischke, and T.J. Devlin, *Phys. Rev. D* **13**, 535 (1976).
- [96] P. Haffter *et al.*, *Nucl. Phys. A* **548**, 29 (1992).
- [97] C. Brogli-Gysin *et al.*, *Nucl. Phys. A* **541**, 137 (1992).
- [98] M. Hammans *et al.*, *Phys. Rev. Lett.* **66**, 2293 (1991).
- [99] C.Y. Chih and W.M. Powell, *Phys. Rev.* **106**, 539 (1957).
- [100] R.H. Stahl and N.F. Ramsey, *Phys. Rev.* **96**, 1310 (1954).
- [101] V. Culler and R.W. Waniek, *Phys. Rev.* **99**, 740 (1955).
- [102] P. Mermod *et al.*, *Phys. Lett. B* **597**, 243 (2004).
- [103] G. H. Stafford *et al.*, *Nuovo Cimento Lett.* **5**, 1589 (1957).
- [104] J. Klug *et al.*, *Nucl. Instrum. Methods A* **489**, 282 (2002).
- [105] V. Blideanu, *Phys. Rev. C* **70**, 014607 (2004).
- [106] C. Johansson, *Phys. Rev. C* **71**, 024002 (2005).
- [107] T. C. Griffith *et al.*, *Proc. Phys. Soc. London, Sec. A* **71**, 305 (1958).
- [108] P. Hillman *et al.*, *Nuovo Cimento Lett.* **3**, 633 (1956).
- [109] J. J. Thresher *et al.*, *Proc. Royal Soc. London, Sec. A* **229**, 492 (1955).
- [110] W.G. Collins, Jr. and D.G. Miller, *Phys. Rev.* **134**, B575 (1964).
- [111] M.W. Shapiro, A.M. Cormack, A.M. Koehler, *Phys. Rev.* **138**, B823 (1965).
- [112] V. Grundies, J. Franz, E. Rössle, and H. Schmitt, *Phys. Lett. B* **158**, 15 (1985).
- [113] A.S. Carroll, P.M. Patel, N. Strax, and D. Miller, *Phys. Rev.* **134**, B595 (1964).
- [114] R.K. Hobbie and D. Miller, *Phys. Rev.* **120**, 2201 (1960).
- [115] P.M. Patel, A. Carroll, N. Strax, and D. Miller, *Phys. Rev. Lett.* **8**, 491 (1962).
- [116] D.F. Measday, *Phys. Rev.* **142**, 584 (1966).
- [117] V.J. Howard *et al.*, *Nucl. Phys. A* **218**, 140 (1974).
- [118] T. C. Randle *et al.*, *Proc. Phys. Soc. London, Sec. A* **69**, 760 (1956).
- [119] J. Lefrançois, R.A. Hoffman, E.H. Thorndike, and R. Wilson, *Phys. Rev.* **131**, 1660 (1963).
- [120] G. H. Stafford *et al.*, *Proc. Phys. Soc. London* **79**, 430 (1962).
- [121] A.F. Kuckes and R. Wilson, *Phys. Rev.* **121**, 1226 (1961).
- [122] B.E. Bonner *et al.*, *Phys. Rev. Lett.* **41**, 1200 (1978).
- [123] C.A. Davis *et al.*, *Phys. Rev. C* **53**, 2052 (1996).
- [124] R. Binz *et al.*, *Nucl. Phys. A* **533**, 601 (1991).
- [125] J. Sowinski *et al.*, *Phys. Lett. B* **199**, 341 (1987).
- [126] M. Sarsour, *Phys. Rev. C* **74**, 044003 (2006).
- [127] D. Spalding, A.R. Thomas, and E.H. Thorndike, *Phys. Rev.* **158**, 1338 (1967).
- [128] A.R. Thomas, D. Spalding, and E.H. Thorndike, *Phys. Rev.* **167**, 1240 (1968).
- [129] Yu. M. Kazarinov and Yu. N. Simonov, *Sov. Phys. JETP* **16**, 24 (1963).
- [130] R.K. Keeler *et al.*, *Nucl. Phys. A* **377**, 529 (1982).
- [131] A.S. Clough *et al.*, *Phys. Rev. C* **21**, 988 (1980).
- [132] C. Amsler *et al.*, *Nucl. Instrum. Methods* **144**, 401 (1977).
- [133] D. Axen *et al.*, *Phys. Rev. C* **21**, 998 (1980).
- [134] D. Bandyopadhyay *et al.*, *Phys. Rev. C* **40**, 2684 (1989).
- [135] E. Kelly, C. Leith, E. Segrè, and C. Wiegand, *Phys. Rev.* **79**, 96 (1950).
- [136] A. Ahmidouch *et al.*, *Eur. Phys. J C* **2**, 627 (1998).
- [137] J. Arnold *et al.*, *Eur. Phys. J C* **17**, 67 (2000).
- [138] J. Arnold *et al.*, *Eur. Phys. J C* **17**, 83 (2000).
- [139] M. Daum *et al.*, *Eur. Phys. J C* **25**, 55 (2002).
- [140] J. De Pangher, *Phys. Rev.* **95**, 578 (1954).
- [141] D. Cheng, B. Macdonald, J.A. Helland, and P.M. Ogden, *Phys. Rev.* **163**, 1470 (1967).
- [142] O. Chamberlain *et al.*, *Phys. Rev.* **105**, 288 (1957).
- [143] J. Ball *et al.*, *Nucl. Phys. A* **559**, 489 (1993).
- [144] J. Ball *et al.*, *Nucl. Phys. A* **574**, 697 (1994).
- [145] J.M. Fontaine *et al.*, *Nucl. Phys. B* **358**, 297 (1991).
- [146] C. Amsler *et al.*, *Phys. Lett. B* **69**, 419 (1977).
- [147] R.T. Siegel, A.J. Hartzler, and W.A. Love, *Phys. Rev.* **101**, 838 (1956).
- [148] A. Ashmore *et al.*, *Nucl. Phys.* **36**, 258 (1962).
- [149] W.P. Poenitz and J.F. Whalen, *Nucl. Phys. A* **383**, 224 (1982).
- [150] A. Suhami and R. Fox, *Phys. Lett. B* **24**, 173 (1967).
- [151] N.S.P. King *et al.*, *Phys. Rev. C* **21**, 1185 (1980).
- [152] J. Gotz *et al.*, *Nucl. Phys. A* **574**, 467 (1994).
- [153] D.F. Measday and J.N. Palmieri, *Nucl. Phys.* **85**, 142 (1966).
- [154] J.N. Palmieri and J.P. Wolfe, *Phys. Rev. C* **3**, 144 (1971).
- [155] J. Rahm *et al.*, *Phys. Rev. C* **57**, 1077 (1998).
- [156] J. Franz, E. Rössle, H. Schmitt, and L. Schmitt, *Phys. Scripta* **T87**, 14 (2000).
- [157] N.W. Reay, E.H. Thorndike, D. Spalding, and A.R. Thomas, *Phys. Rev.* **150**, 801 (1966).
- [158] R.E. Warner and J.H. Tinlot, *Phys. Rev.* **125**, 1028 (1962).
- [159] J.H. Tinlot and R.E. Warner, *Phys. Rev.* **124**, 890 (1961).
- [160] R. Abegg *et al.*, *Phys. Rev. C* **38**, 2173 (1988).
- [161] T.J. Devlin *et al.*, *Phys. Rev. D* **8**, 136 (1973).
- [162] J. Bystricky *et al.*, *J. de Physique* **48**, 1901 (1987).
- [163] M. Jarvinen, *Phys. Rev. D* **71**, 085006 (2005) [arXiv:hep-ph/0411208].
- [164] J. Adam, Jr., F. Gross, S. Jeschonnek, P. Ulmer and J. W. Van Orden, *Phys. Rev. C* **66**, 044003 (2002) [arXiv:nucl-th/0204068].
- [165] J. A. Tjon and S. J. Wallace, *Phys. Rev. C* **32**, 1667 (1985).
- [166] F. Gross and J. Milana, *Phys. Rev. D* **43**, 2401 (1991).

- [167] C. Savkli and F. Gross, Phys. Rev. C **63**, 035208 (2001) [arXiv:hep-ph/9911319].
- [168] M. Jacob and G. C. Wick, Annals Phys. **7** (1959) 404 [Annals Phys. **281** (2000) 774].