

More Really is Different

Mile Gu,¹ Christian Weedbrook,¹ Álvaro Perales,^{1,2} and Michael A. Nielsen^{1,3}

¹*Department of Physics, University of Queensland, St Lucia, Queensland 4072, Australia.*

²*Dpto. Automática, Escuela Politécnica, Universidad de Alcalá, Alcalá de Henares, Madrid 28871, Spain.*

³*Perimeter Institute for Theoretical Physics, Waterloo, Ontario N2L 2Y5, Canada.*

(Dated: November 26, 2024)

In 1972, P. W. Anderson suggested that ‘More is Different’, meaning that complex physical systems may exhibit behavior that cannot be understood only in terms of the laws governing their microscopic constituents. We strengthen this claim by proving that many macroscopic observable properties of a simple class of physical systems (the infinite periodic Ising lattice) cannot in general be derived from a microscopic description. This provides evidence that emergent behavior occurs in such systems, and indicates that even if a ‘theory of everything’ governing all microscopic interactions were discovered, the understanding of macroscopic order is likely to require additional insights.

PACS numbers: 89.75.-k, 75.10.Hk

I. INTRODUCTION

The reduction of collective systems to their constituent parts is indispensable to science. The behavior of ideal gases can be understood in terms of a simple model of non-interacting point particles; the properties of chemical compounds predicted through their underlying atomic structure; and much of the recent advances in biology has been achieved by reducing biological behavior to properties of the DNA molecule.

These and other triumphs have fostered the optimistic belief that all scientific theories can ultimately be reduced to a small set of fundamental laws; that the universe is broken up into a series of reductive levels (e.g., ecosystems, multicellular living organisms, cells, molecules, atoms, elementary particles); and that any scientific theory that governs one reductive level can be mathematically deduced from the laws that govern the reductive levels below it [1, 2]. This encourages certain subfields to claim a kind of moral high ground, based on an ideal of science as determining the fundamental microscopic behavior, with the rest ‘just’ details.

Of course, many disagree that the rest is just details. In 1972, P. W. Anderson laid out such a case in his article “More is Different” [2], arguing that complex systems may possess emergent properties difficult or impossible to deduce from a microscopic picture. Anderson gives several examples which he suggests illustrate this idea, based on broken symmetry, and goes so far as to claim that in the limit of infinite systems, emergent principles take over and govern the behavior of the system, which can no longer be deduced from the behavior of the constituent parts. Since macroscopic laws that govern macroscopic observables often implicitly assume this infinite limit, they cannot logically be derived, even in principle, from microscopic principles. Is Anderson correct? His examples were largely speculative. The question of whether some macroscopic laws may be fundamental statements about nature or may be deduced from some ‘theory of everything’ remains a topic of debate among scientists [1, 3].

In this article we strengthen Anderson’s claims by proving that standard notions of reductionism cannot generally hold in a widely studied class of collective systems, the infinite square Ising lattice. We show that for a large class of macroscopic observables, including many of physical interest, the value of those observables is formally undecidable, i.e., cannot generally be computed from the fundamental interactions in the lattice. Consequently, any macroscopic law that governs the behavior of such properties cannot be deduced from first principles. Our result therefore indicates that perhaps a ‘theory of everything’ may not explain all natural phenomena; additional experiments and intuition may be required at each reductive level.

Our paper is inspired by previous results [4, 5, 6] on undecidability in physical systems. We employ a similar strategy, which is to map computational models into equivalent physical systems; the undecidability of the computational models then implies that there must exist undecidable properties of those physical systems. Our proof extends this mapping so that these undecidable properties encompass a large class of observables that are physically interesting on macroscopic scales. These results present analytical evidence for emergence.

II. REDUCTIONISM AND THE PERIODIC ISING LATTICE

Square Ising lattices describe a classical system of spins arranged at the vertices of a d -dimensional rectangular grid. The state of each spin is described by a single value (0 or 1) and interacts only with its $2d$ neighbors. In this paper, we work with planar lattices ($d = 2$), though our results easily generalize to higher dimensions. While this simple model was first introduced to describe magnetic materials [7], where each spin describes the orientation of a microscopic magnetic moment, it has become ubiquitous in modeling a diverse range of collective systems, including lattice gases [7], neural activity [8], protein folding [9], and flocking [10]. Emergence in such

models would thus suggest it is of common occurrence in nature. For convenience, we use the standard terminology of magnetism, though our arguments apply equally to other applications of the model.

Mathematically, we index each spin of the 2-d square Ising lattice by a vector of integers $\mathbf{x} = (i, j)$ (Fig. 1(a)), such that $s_{\mathbf{x}} \in \{0, 1\}$ denotes the state of the spin at location \mathbf{x} . Interactions on this lattice are described by the Hamiltonian H , a function that maps each configuration of the lattice to a real number corresponding to energy. The general Ising model with an external field has a Hamiltonian of the form [7]

$$H = \sum c_{\mathbf{x}, \mathbf{y}} s_{\mathbf{x}} s_{\mathbf{y}} + \sum M_{\mathbf{x}} s_{\mathbf{x}} \quad (1)$$

where $c_{\mathbf{x}, \mathbf{y}}$ are the interaction energies between spins $s_{\mathbf{x}}$ and $s_{\mathbf{y}}$, and $M_{\mathbf{x}}$ describes the external field at site \mathbf{x} . We say spins j and k interact if $c_{j, k} \neq 0$. The ground states of the system are configurations that minimize the value of H .

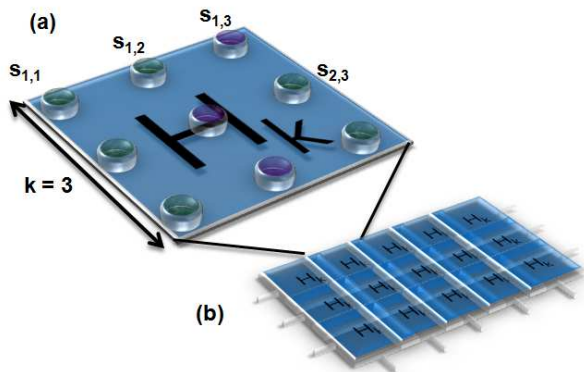

FIG. 1: The square Ising lattice (a) consists of a rectangular grid of spins such that only adjacent spins interact, i.e., $c_{\mathbf{x}, \mathbf{y}} = 0$ unless $|\mathbf{x} - \mathbf{y}| = \sum_i |x_i - y_i| = 1$. Such a lattice is periodic if it can be specified completely by some Hamiltonian H_k that acts on a $K \times K$ Ising block (b). Note that the Hamiltonians are tessellated in such a way that the adjacent blocks always share one common row or column.

Consider a macroscopic system modeled by a square Ising lattice of $N \times N$ spins, with $N \gg 1$. Such systems often exhibit periodicity, i.e., clusters of spins are often found to experience similar interactions. We can specify such systems by periodic Ising models, which consist of a tessellation of spin blocks, each governed by identical intra- and inter-block interactions (Fig. 1 (b)).

Understanding the behavior of such a macroscopic system need not entail knowledge of the dynamics of each individual microscopic constituent. The physically relevant observables, at macroscopic scales, such as magnetization (the proportion of spin in state 1), are generally global properties of the lattice. Insight into the behavior of such systems may be obtained from knowledge of the macroscopic laws that govern the dynamics of such

properties. While *a priori*, there is no guarantee that such laws should exist, the existence of thermal physics and other macroscopic principles suggests that the universe conspires in many instances to give the macroscopic world some sort of order [3].

In contrast, reductionism contends that any macroscopic order can be understood by decomposing the system to its basic interactions, i.e., the known interactions of each periodic block within the lattice. Thus, from a reductionist perspective, the fundamental science of such a system is the determination of these interactions, and the rest is just working out the consequences of those interactions.

We construct a class of periodic Ising models that directly contradict this perspective. In particular, we consider 2-d macroscopic lattices where the spins of a 1-d edge are fixed by some spatially varying external magnetic field. We will show that at its lowest energy state, a general class of macroscopic properties cannot be generally predicted from knowledge of the lattice Hamiltonian H_k . Thus any macroscopic law that governs these quantities must be logically independent of the fundamental interactions.

In practice, of course, many periodic Ising systems are soluble. What relevance, then, do these results have for the practice of science? We observe that in many cases of physical interest (e.g., the 3-d Ising model), no explicit, formal solution is known; it is possible that this is not merely a product of our ignorance, but rather because no solution exists.

III. THE APPROACH

Our approach is inspired by the existence of ‘emergent’ phenomena in mathematics. Unlike physical systems, the axioms that define a mathematical system, its analogous ‘theory of everything’, are known; yet, many properties of such systems cannot be proven either true or false, and hence are formally undecidable [11]. The Turing machine [12] is one such system. First proposed to formally describe a universal computer, Turing machines are theoretical devices that consist of a finite state machine that operates on an unbounded one-dimensional array of binary states. Despite the fact that the behavior of these machines is formally characterized, most questions regarding their long-term dynamics are undecidable.

One well known example of undecidability is the halting problem [12], which asks whether a given machine ever halts on a specific input. In fact, a much more general class of questions is undecidable. Rice’s theorem [13] states that any non-trivial question about a Turing machine’s black-box behaviour is undecidable, i.e., any question about the functional relationship between inputs and outputs. For example, Rice’s theorem tells us that there is no general algorithm which will tell us whether or not a given Turing machine acts to square its input, although of course for specific machines it may be possible to de-

termine whether or not this is the case.

Numerous simple physical systems capable of simulating arbitrary Turing machines have been proposed, e.g., [5, 14]. Since such ‘universal’ systems are as powerful as Turing machines, and thus an arbitrary computer, the only viable general method of predicting the dynamics of such systems is by direct simulation. The only way to find whether or not it halts is to run the machine *ad infinitum*, there exists no algorithm that can determine the eventual behavior of any universal system.

The ‘Game of Life’ [15] is a well-known example. The state of this system consists of an infinite 2-dimensional rectangular grid of cells, each of which is either alive or dead. The system evolves in discrete time steps, where the fate of each cell depends on the state of the eight cells in its neighborhood (i.e., the 3×3 block centered around the cell). Although this simple system exhibits dynamics entirely defined only by a binary function (its update function) on nine bits, it is universal. The ‘Game of Life’ is not unique, and belongs to a general class of discrete dynamical systems known as cellular automata (CA), including Life without Death [16] and the 1-dimensional Rule 110 [17].

The dynamics of a CA are governed by an update rule applied identically to each cell, reminiscent of a periodic Ising lattice where each block experiences the same Hamiltonian. This motivates encoding the dynamics of a CA in the ground state of the periodic Ising lattice. While such constructions exist [18, 19], our constructions must be tailored so computing the macroscopic properties of the lattices would entail knowledge of the undecidable properties of the underlying CA.

IV. THE CELLULAR AUTOMATA ENCODING

We encode the dynamics of any d -dimensional CA within the ground states of a $(d + 1)$ -dimensional periodic Ising lattice with a particular H_K . The construction is not unique; a given CA may be simulated by an infinite number of different periodic Ising lattices.

Formally, we consider a CA that consists of a d -dimensional lattice of cells, each of which may be either 0 or 1. The neighborhood of a cell is the set of cells in a block of cells $(2r + 1)$ on a side, and centered on the cell, where r is some positive integer that specifies the size of the neighborhood we are considering. The way the state of a CA changes at each time-step is dictated by a local update rule, i.e., a function, f , that maps this neighborhood to $\{0, 1\}$. For example, the state of any 1-dimensional CA is defined by an infinite array of binary numbers $\dots b_{-1,t} b_{0,t} b_{1,t} b_{2,t} \dots$ at time t . If $r = 1$, then at $t + 1$, the state of each cell updates according to $b_{k,t+1} = f(b_{k-1,t}, b_{k,t}, b_{k+1,t})$. In order to avoid burdensome notation we will explicitly outline the mapping of a CA to a periodic Ising lattice for the simple case of $d = r = 1$. The general mapping follows identical ideas.

We make use of ‘designer Ising blocks’, bounded 2-

dimensional blocks of spins with an associated Hamiltonian whose ground state encodes a desired logical operation f . The input is encoded in bits on one boundary of the block, while output bits on the boundary opposite (Fig. 2). Formally, consider an arbitrary binary function f with m inputs and n outputs; we define a ‘designer Ising block’ as follows. Take a $C \times D$ block of spins, where $C, D > \max(m, n)$, governed by a Hamiltonian H_f with ground state set \mathcal{G}_f . We designate m input spins, $\vec{s} = (s_1, s_2, \dots, s_m)$ from the first row to encode the input and n output spins, $\vec{r} = (r_1, r_2, \dots, r_n)$ from the last row as output.

We say a configuration of the lattice, \mathbf{s} , satisfies $\{\vec{s}, \vec{r}\}$ if the input and output spins are in states \vec{s} and \vec{r} respectively. Suppose that (1) there exists $\mathbf{s} \in \mathcal{G}_f$ that satisfies $\{\vec{s}, \cdot\}$ for each of the 2^m possible inputs of f and (2) every $\mathbf{s} \in \mathcal{G}_f$ satisfies $\{\vec{s}, \vec{r} = f(\vec{s})\}$, then we can set the ground state of the Ising block to simulate the action of f on any desired input by appropriately biasing the input spins by external fields. In fact, previous results [19] indicate appropriate blocks exist for any f ; we outline an explicit method in the Appendix.

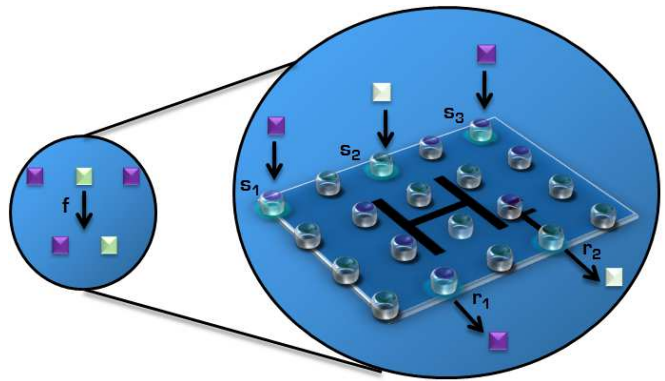

FIG. 2: For any binary function f , we can construct an Ising block such that its ground state encodes f . If the input bits s_i are fixed, then the output bits $r_i = f(s_i)$ when this block is at ground state.

To simulate the dynamics of a CA with an update function f , we utilize designer Ising blocks that simulate (1) the update function f ; (2) the three way FANOUT function that takes a bit as input and makes two copies; (3) the SWAP function, which switches the states of its two inputs. Like the construction of a digital circuit these building blocks can be tessellated together to simulate the dynamics of any given CA (See Figure 3). The set of ground states of the resulting periodic Hamiltonian encodes the dynamics of the given CA for all possible initial conditions. The application of an external field to the first row (layer) of the lattice then simulates the evolution of the encoded CA with a particular initial condition. Thus, the ground state of the periodic Ising model is universal.

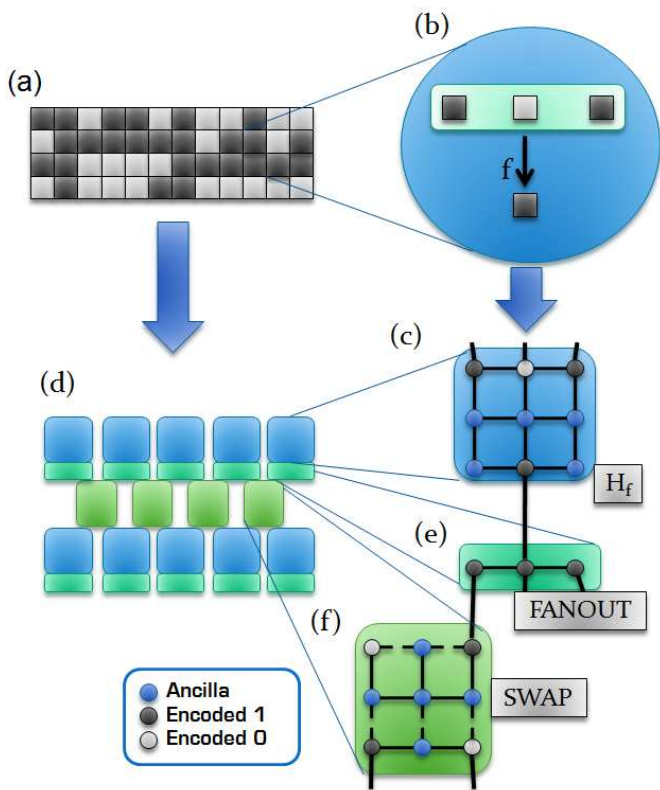

FIG. 3: (Color online) The dynamics of any given CA (a) with update rule f (b) can be encoded in the ground state of a periodic Ising lattice (c) through a periodic tessellation of designer Ising blocks that simulate the operations f (d), FANOUT (e), and SWAP (f).

V. UNDECIDABLE MACROSCOPIC OBSERVABLES

For each Turing machine, T , with input x , we can construct a periodic Ising lattice such that knowledge of its ground state implies complete knowledge of $T(x)$. Thus, the ground state of such lattices must be undecidable. This result can be strengthened. Rice’s theorem not only predicts that $T(x)$ is non-computable, but also all black box properties of T . Examples include, ‘is $T(x) > 500$? for all inputs’ and ‘does T double all its inputs’. Properties such as these must correspond to a property of the Ising lattice.

This motivates a *Rice’s theorem for physical systems*. Any property of a physical system is specified by a function P that maps the configuration space of the system to the real numbers. Suppose the system is universal, and thus encodes an underlying Turing machine T . Provided the observable property is dependent on the output of $T(x)$, so that knowledge of P implies non-zero information about $T(x)$, then P cannot be computable for all such systems. This result is quite general. Given an Ising lattice, there are infinitely many ways of encoding a Turing machine. Provided a single one of these encodings

affect the value of P , then ‘Rice’s theorem for physical systems’ applies.

A useful example is the ‘prosperity’ of a CA, the probability that a randomly chosen cell at a random time step is alive. This equates to the proportion of living cells, averaged over all time steps from 0 to infinity. In many universal CAs (Game of Life, Life without Death), information is encoded in the presence or absence of clusters of living cells of specific configurations, referred to as gliders or ladders. Different computational results lead to different numbers of gliders, and these gliders may cause unbounded growth of living cells. Thus, the prosperity of a CA is indeed dependent on the output of an encoded Turing machine, and must be undecidable.

The prosperity of a CA is essentially a macroscopic observable — for a magnetic system, it is just the average magnetization of the system, up to an additive constant. Such observables are *averaging properties*. That is, we can divide the Ising lattice into a periodic tessellation of finitely sized blocks such that the property depends on the average of some non-constant function f on each block. Formally, let $P : \mathcal{C} \rightarrow \mathbb{R}$ be a general function that maps each configuration of the Ising lattice into a real number, where \mathcal{C} is the configuration space of the Ising lattice. Divide the Ising lattice into a periodic tessellation of finitely sized Ising blocks B_1, B_2, \dots of size $C \times D$, for some fixed $C, D \in \mathbb{N}$. Let $\mathcal{C}_{C \times D}$ denote the configuration space of each block. We introduce a non-trivial function $f : \mathcal{C}_{C \times D} \rightarrow \mathbb{R}$, i.e., there exists $\mathbf{s}_1, \mathbf{s}_2 \in \mathcal{C}_{C \times D}$ such that $|f(\mathbf{s}_1) - f(\mathbf{s}_2)| \geq \epsilon$, for some fixed $\epsilon > 0$. Define $\mathcal{A}(\mathbf{s}) : \mathcal{C} \rightarrow \mathbb{R}$, $\mathcal{A}(\mathbf{s}) = \langle f(\mathbf{s}) \rangle$ as the average of f over all B_i .

We say that P is an averaging macroscopic property if knowledge of $P(\mathbf{s})$ gives information about the value of $\mathcal{A}(\mathbf{s})$ for some choice of C and D . Explicitly, let \mathcal{R}_A be the range of \mathcal{A} and \mathcal{R}_P be the range of P . Suppose that for each $p \in \mathcal{R}_P$, $P(\mathbf{s}) = p$ implies $\mathcal{A}(\mathbf{s}) \notin [a, b]$ for some non-zero interval $[a, b]$, then P is an averaging macroscopic property. Total magnetization, average spin-spin correlation, and most standard quantities of physical interest can be shown to fall into this category. Indeed, we will show that given such a macroscopic property P , we construct a modified encoding scheme such that the value of the given observable is almost entirely dependent on the ‘prosperity’ of the underlying CA.

The primary strategy is to replace the FANOUT blocks in our encoding scheme with ‘magnifier blocks’ (See Fig. 4 a). The ‘magnifier block’ is a ‘designer Ising block’ that simulates the 3-way FANOUT and additionally exhibits a ground state with notably different contributions to P depending on its input. Provided these blocks are of sufficient size, knowledge of P implies knowledge of the average input of these magnifiers, i.e., the prosperity of the underlying CA.

Formally, assume P is decidable. In particular, the proposition ‘ $P(\mathbf{s}) = p$ at ground state \mathbf{s} ?’ is decidable for any p . Then, there must exist an interval $[a, b]$ such that the proposition ‘ $A(s)$ lies outside $[a, b]$ at ground state’

is also decidable. However, since the Ising lattice is universal, a magnifier for any function exists. Therefore, we may construct a magnifier that ensures that $A(s) \in [a, b]$ iff the underlying prosperity is less than $1/2$. The decidability of P then implies knowledge of the underlying prosperity. Hence, *any such macroscopic property of the periodic Ising lattice is generally undecidable*. We illustrate this with a number of examples:

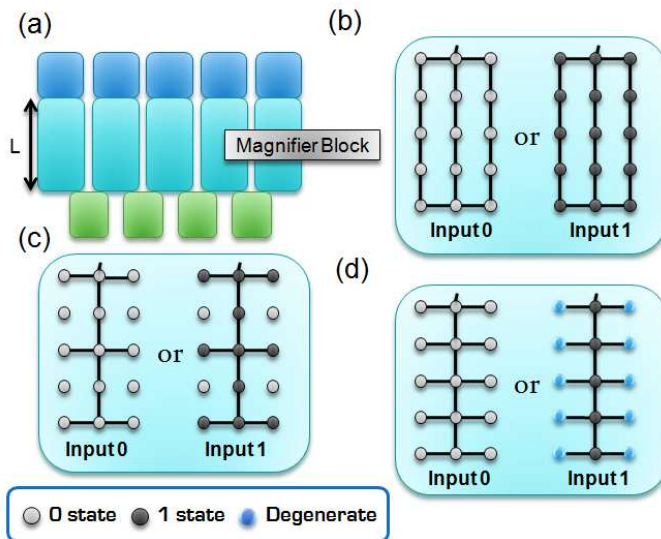

FIG. 4: Magnifier blocks can be inserted into the CA encoding (a) and made large enough such that their properties dominate the properties of the lattice. The ground state of these spin blocks (pictured) can exhibit significantly different values of magnetization (b), correlations functions (c) and degeneracy (d), for different inputs. Here, degenerate spins denote spins whose state has no effect on the energy of the lattice.

1. A magnetization magnifier has ground states of either all 0's or all 1's (Fig. 4 (b)). Thus, magnetization is undecidable.
2. The correlation length measures the scaling of $\lim_{r \rightarrow \infty} \langle s_{l,m}, s_{l,m+r} \rangle$ (where $\langle \cdot \rangle$ denotes an average over all lattice sites) with r . Knowledge of the correlation length allows us to solve the undecidable question of whether the encoded CA will eventually have no living cells [20]. Thus the correlation length is undecidable.
3. Finite range correlations, i.e., $\langle s_{l,m}, s_{l,m+r} \rangle$ or $\langle s_{l,m}, s_{l+r,m} \rangle$, for some r , measure periodic structures. Since this property depends on the correlations of finitely sized blocks (magnified in Fig. 4 (c)), these correlations are undecidable.
4. The partition function at zero temperature is determined by the degeneracy of the system. Since degeneracy can be magnified, (Fig. 4 (d)) partition functions are non-computable.

Chaitin [21] has emphasized that such undecidability results automatically imply results about what is provable in such systems. In particular, our results imply that for any such observable, there must *exist* a specific Ising lattice for which it is not possible to prove the ground state value of the observable. The reason, in outline, is that if such a proof always existed, then it would be possible to construct an algorithm for determining the value of the observable, simply by enumerating and checking all possible proofs. We expect that this result readily generalizes to lattices of finite temperatures and more exotic macroscopic observables using different encodings and non-deterministic CAs.

VI. DISCUSSION AND CONCLUSION

It may be objected that our results only hold in infinite lattices, and hence are not relevant for real finite physical systems. Most scientists would agree that any finite system, with finite energy, exhibits behavior that is computable (but c.f., [22]). Yet infinite systems also play an essential role in developing our understanding of real physical systems. Even if we possessed a supercomputer capable of simulating complex systems, we would still not understand the system without referring to macroscopic concepts such as phase transitions and the renormalization group [23], which apply only in the limit of infinite systems. Yet these same tools are essential to our understanding of the behavior of real physical systems.

In summary, Ising models play an important role in modeling many physical and biological phenomena. Our results indicate that in such systems, many general macroscopic ground state properties cannot be computed from fundamental laws governing the microscopic constituents. Despite complete characterization of the system, we can assign two different values to any such property, and there would exist no logical way to prove which assignment is correct. Instead, in specific instances, the best one can do is assert the value of some physically interesting properties as axiomatic, perhaps on the basis of experimental evidence or (finite) simulations; this would truly be an example where ‘more is different’.

Although macroscopic concepts are essential for understanding our world, much of fundamental physics has been devoted to the search for a ‘theory of everything’, a set of equations that perfectly describe the behaviour of all fundamental particles. The view that this is the goal of science rests in part on the rationale that such a theory would allow us to derive the behavior of all macroscopic concepts, at least in principle. The evidence we’ve presented suggests this view may be overly optimistic. A ‘theory of everything’ is one of many components necessary for complete understanding of the universe, but is not necessarily the only one. The development of macroscopic laws from first principles may involve more than just systematic logic, and could require conjectures suggested by experiments, simulations or insight.

M.G., C.W. and M.A.N. acknowledge support from the Australian Research Council. A.P. acknowledges financial support from Spanish MEC (Programa para la Movilidad). M.A.N. thanks Gerard Milburn and Cris Moore for discussions. M.G. and C.W. thank Nick Menicucci, Niloufer Johansen and Guifre Vidal for discussions.

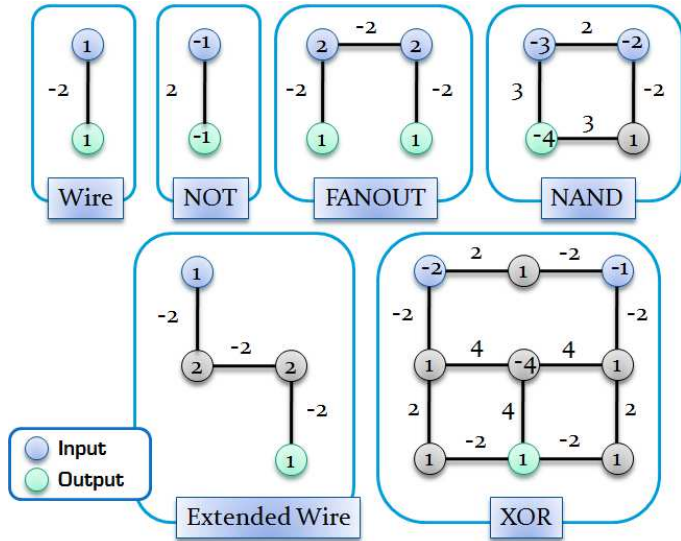

FIG. 5: (Color online) The interaction graphs of ‘designer Ising blocks’ that simulate each of the basic boolean operations. These blocks can then be linked together by wires to simulate an arbitrary computation.

APPENDIX A: UNIVERSALITY OF ISING BLOCKS

In this section, we prove that the ground states of designer Ising blocks are universal. Any boolean function f can be represented by a logic circuit that consists of the following components: (1) wires (2) FANOUT gates and (3) NAND gates. Mathematically, these operations are defined as (1) Wire(b_1) = b_1 , (2) FANOUT(b_1) = (b_1, b_1) (3) NAND(b_1, b_2) = $\neg(b_1 \wedge b_2)$.

We convert this to a *planar circuit*, that is, one in which no wires intersect. This is achieved by replacing each intersection with a SWAP gate, SWAP(b_1, b_2) = (b_2, b_1). Such SWAP gates can be decomposed into a network of three XOR gates i.e., SWAP(b_1, b_2) = XOR₁(XOR₂(XOR₁(b_1, b_2))), where XOR₁(b_1, b_2) = ($b_1 \oplus b_2, b_2$) and XOR₂(b_1, b_2) = ($b_1, b_1 \otimes b_2$).

Observe that designer Ising blocks can be constructed to simulate of these components, i.e., (1) wires (2) FANOUT gates (3) NAND gates and (4) XOR gates (c.f., Fig. 5). Therefore, any planar circuit, and hence any boolean function, can be implemented by a designer Ising block.

-
- [1] Weinberg, S. *Dreams of a Final Theory* (Pantheon Books, 1993).
 - [2] Anderson, P.W. More Is Different. *Science* **177**, 393 (1972).
 - [3] Laughlin, R.B. and Pines, D. The Theory of Everything. *Proc. Natl. Acad. Sci. U.S.A.* **97**, 28 (2000).
 - [4] Wolfram, S. Undecidability and intractability in theoretical physics. *Phys. Rev. Lett.* **54**, 735 (1985).
 - [5] Moore, C. Unpredictability and undecidability in dynamical systems. *Phys. Rev. Lett.* **64**, 2354 (1990).
 - [6] Schlijper, A.G. Tiling problems and undecidability in the cluster variation method. *J. Stat. Phys.* **50**, 689 (1988).
 - [7] Chandler, D. *Introduction to modern statistical mechanics* (Oxford University Press, New York, 1987).
 - [8] Rojas, R. *Neural Networks - A Systematic Introduction* (Springer, 1996).
 - [9] Bryngelson, J.D. and Wolynes, P.G. Spin Glasses and the Statistical Mechanics of Protein Folding. *Proceedings of the National Academy of Sciences of the United States of America* **84**, p. 7524 (1987).
 - [10] Toner, J. and Tu, Y. Long-Range Order in a Two-Dimensional Dynamical XY Model: How Birds Fly Together. *Phys. Rev. Lett.* **75**, 4326 (1995).
 - [11] Gödel, K. Über formal unentscheidbare Stze der Principia Mathematica und verwandter Systeme I. *Monatshefte für Math. u. Physik* **38**, 173 (1931).
 - [12] Turing, A.M. On computable numbers, with an application to the Entscheidungsproblem. *Proc. Lond. Math. Soc.* **2** **42**, 230 (1936).
 - [13] Rice, H.G. Classes of recursively enumerable sets and their decision problems. *Trans. Amer. Math. Soc.* **74**, 358 (1953).
 - [14] Fredkin, E. and Toffoli, T. Conservative logic. *International Journal of Theoretical Physics* **21**, 219 (1982).
 - [15] Berlekamp, E. Conway, J. and Guy, R. *Winning Ways for your mathematical plays* (Academic Press, Oxford, 1982).
 - [16] Griffeath, D. and Moore, C. Life without death is P-complete. *Complex Systems* **10**, 437 (1996).
 - [17] Cook, M. Universality in Elementary Cellular Automata. *Complex Systems* **15**, (2004).
 - [18] Domany, E. and Kinzel, W. Equivalence of Cellular Automata to Ising Models and Directed Percolation. *Phys. Rev. Lett.* **53**, 311 (1984).
 - [19] Barahona, F. On the computational complexity of Ising spin glass models. *J. Phys. A: Math. Gen.* **15**, 3241 (1982).
 - [20] Wolfram, S. *Cellular automata and complexity* (Addison-Wesley, Redwood City, CA, 1994).
 - [21] Chaitin, G.J. Gödel’s theorem and information. *International Journal of Theoretical Physics* **22**, 941 (1982).
 - [22] Penrose, R. *The emperor’s new mind.* (Oxford University

Press, Oxford, 1989).

- [23] Fisher, M.E. Renormalization group theory: Its basis and formulation in statistical physics. *Rev. Mod. Phys.* **70**,

653 (1998).

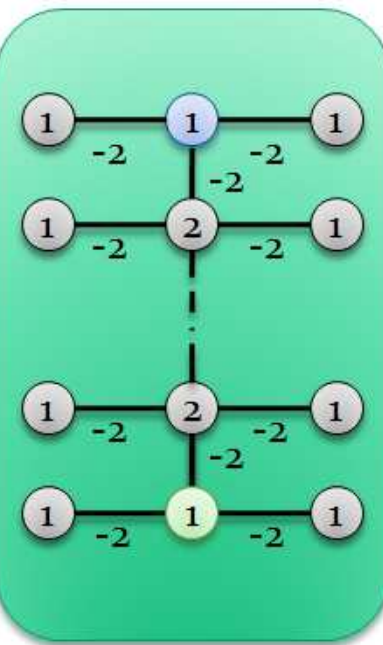

(a)

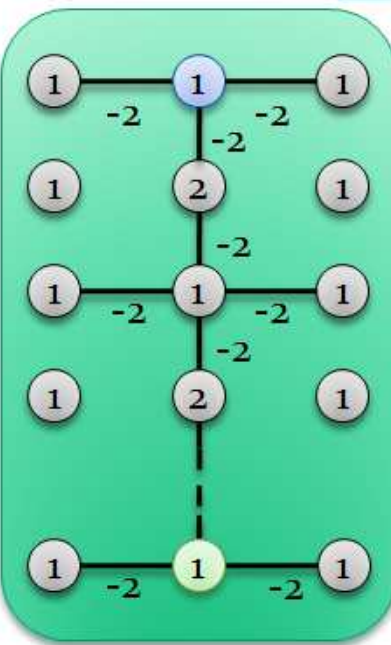

(b)

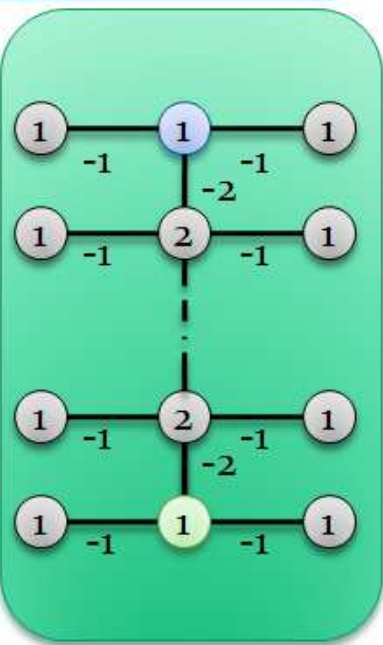

(c)