

1 – d gravity in infinite point distributions

A. Gabrielli^{1,2}, M. Joyce³, F. Sicard³

¹*SMC, INFN/CNR, Physics Department,
University “La Sapienza” of Rome, 00185-Rome, Italy*

²*Istituto dei Sistemi Complessi,*

CNR, Via dei Taurini 19, 00185-Rome, Italy and

³*Laboratoire de Physique Nucléaire et Hautes Énergies,
Université Pierre et Marie Curie - Paris 6, CNRS IN2P3 UMR 7585, Paris, F-75005, France*

The dynamics of infinite, asymptotically uniform, distributions of purely self-gravitating particles in one spatial dimension provides a simple and interesting toy model for the analogous three dimensional problem treated in cosmology. In this article we focus on a limitation of such models as they have been treated so far in the literature: the force, as it has been specified, is well defined in infinite point distributions only if there is a centre of symmetry (i.e. the definition requires explicitly the breaking of statistical translational invariance). The problem arises because naive background subtraction (due to expansion, or by “Jeans swindle” for the static case), applied as in three dimensions, leaves an unregulated contribution to the force due to surface mass fluctuations. Following a discussion by Kiessling of the Jeans swindle in three dimensions, we show that the problem may be resolved by defining the force in infinite point distributions as the limit of an exponentially screened pair interaction. We show explicitly that this prescription gives a well defined (finite) force acting on particles in a class of perturbed infinite lattices, which are the point processes relevant to cosmological N -body simulations. For identical particles the dynamics of the simplest toy model (without expansion) is equivalent to that of an infinite set of points with inverted harmonic oscillator potentials which bounce elastically when they collide. We discuss and compare with previous results in the literature, and present new results for the specific case of this simplest (static) model starting from “shuffled lattice” initial conditions. These show qualitative properties of the evolution (notably its “self-similarity”) like those in the analogous simulations in three dimensions, which in turn resemble those in the expanding universe.

PACS numbers:

I. INTRODUCTION

The development of clustering in initially quasi-uniform *infinite* distributions of point particles evolving purely under their Newtonian self-gravity has been the subject of extensive numerical study in cosmology over the last several decades (see e.g. [1] for a review). This is the case because these “N-body” (particle) simulations of the Newtonian limit are believed to give a very good approximation to the formation of structure formation in current dark matter dominated models of the universe. The impressive growth in the size of these simulations has led essentially to phenomenological models of the associated dynamics. Analytical understanding, which would be very useful in trying to extend the numerical results and also control for their reliability, remains very limited. In attempts to progress in this direction it is natural to look to simplified toy models which may provide insight and qualitative understanding. Such models may also be interesting theoretically in a purely statistical mechanics setting, and specifically in the context of the investigation of out of equilibrium dynamics of systems with long-range interactions (see e.g. [2, 3]).

An obvious toy model for this full $3 - d$ problem is the analogous problem in $1 - d$, i.e., the generalization to an infinite space (static or expanding) of the so-called “sheet model”, which is formulated for finite mass distributions. In this latter model, which has been quite extensively

investigated (see, e.g., [4, 5, 6, 7, 8, 9] and references therein), particles in $1 - d$ experience pair forces independent of their separation, like those between parallel self-gravitating sheets in $3 - d$ of infinite extent. Several groups of authors [10, 11, 12, 13, 14, 15, 16, 17, 18, 19, 20] have then discussed different variants on this model to develop the analogy with the $3 - d$ infinite space problem. Just as for the finite sheet model, these models have the particular interest of admitting exact solutions between sheet crossings, which means that they can be easily evolved numerically to machine precision, and at modest numerical cost for quite large numbers of particles.

In this article we revisit the basics of these toy models (in either static or expanding universes), addressing the problem of their general formulation for infinite distributions. Indeed, as we will discuss, previous discussions have required, in their implementation, the imposition of symmetry about a point, or finite extent of the considered density perturbations¹. Such a restriction on the class of point processes which can be considered, and notably the requirement that statistical translational invari-

¹ This is not true of the treatments in [11, 12], which start directly from the fluid limit (rather than from a particle description). See further discussion below.

ance be broken, is not desirable. Indeed in the context of the cosmological problem, this latter property of the distributions usually considered as initial conditions for simulations is very important, because of the “cosmological principle” which supposes that there are no preferred centres (see e.g. [21, 22]). Further the question of the extrapolation of the finite version of the model (which is what is simulated numerically) to the infinite system limit has, as we will discuss below, not been carefully examined. We will show that problems with the definition of the force (as used in these previous treatments) arise from a subtlety about how the so-called “Jeans swindle” is applied in one dimension. We draw here on the work of Kiessling in [23], where it has been shown that, in $3 - d$, the usual formulation of the Jeans swindle — subtraction of a compensating negative mass background in calculation of the potential — may be more physically formulated as a prescription for the calculation of the *force* in the infinite volume limit. It turns out, as we will see, that while in $3 - d$ it is sufficient to prescribe that the force on a given particle is obtained by summing symmetrically about it (e.g. summing in spheres of radius R with centre at the particle, and then sending R to infinity), in $1 - d$ this limiting procedure needs to be further specified. More specifically the force turns out to be defined in $1 - d$ for a broader class of point distributions — and notably for distributions without a centre — when the summation is performed by taking the unscreened limit of the same sum for a screened version of the interaction, rather than as the limit of the sum truncated to a finite symmetric “top-hat” interval.

In the next section we give a more detailed heuristic discussion of the problem of defining the force in the infinite volume limit, and then give the prescription we adopt. We then present in Sect. III a rigorous calculation showing that the force is indeed well defined for a certain class of infinite perturbed lattices, i.e., infinite configurations generated by perturbing particles off a perfect lattice. To do this we treat these infinite point distributions as stochastic point processes and study the probability distribution of the force on particles [22, 24]. For finite variance displacements off the lattice, either correlated or uncorrelated, which do not cause particles to cross one another, the result turns out to be extremely simple: the force on any particle is simply proportional to its displacement from its lattice site. In the following section we turn to consider the definition of dynamical models using this force. While the most evident model is the simple one obtained by using the conservative Newtonian dynamics under the derived forces, there is also a simple variant with an additional damping term which is the natural toy model for the $3 - d$ cosmological problem (with an expanding background). Given that particle crossings are, up to interchanges of particle labels, equivalent, in $1 - d$, to an elastic collision (with exchange of velocities) the evolution in these toy models, starting from infinite perturbed lattices in the class in which we have shown the force to be defined, is in fact equivalent

at all times simply to an infinite set of particles with inverted harmonic oscillator potentials centred at their original lattice sites, and which collide elastically when they meet. In the last subsection of this section, we then give a detailed discussion of the relation of these two toy models to those which have been discussed previously in the literature, explaining that our formulation provides essentially both a simplification, and a generalization, of most of these previous treatments. In Sect. V we present briefly results of numerical simulations for the simplest toy model (without expansion), and uncorrelated initial displacements to the lattice (the “shuffled lattice”). We show that in this case the evolution of the clustering in time is qualitatively very similar to that which has been observed in the analogous $3 - d$ system. Notably these static space simulations share the features of “hierarchical” structure formation and “self-similarity” which are well documented in full $3 - d$ simulations. In the final section we summarize our findings and conclusions, and discuss some directions we envisage for further work.

II. FROM FINITE TO INFINITE SYSTEMS

A. Definitions

By gravity in one dimension we mean the pair interaction corresponding to an attractive force independent of separation, i.e., the force $f(x)$ on a particle at coordinate position x exerted by a particle at the origin is given by

$$f(x) = -g \frac{x}{|x|} = -g \operatorname{sgn}(x), \quad (1)$$

where g is the coupling. Equivalently it is the pair interaction given by the pair potential $\phi(x) = g|x|$ which satisfies the $1 - d$ Poisson equation for a point source, $\frac{d^2\phi}{dx^2} = 2g\delta_D(x)$ (where δ_D is the Dirac delta function). Comparing with the $3 - d$ Poisson equation shows the equivalence with the case of an infinitely thin plane of infinite extent and surface mass density $\Sigma = g/2\pi G$, which explains the widely used name “sheet model”. We will work in the one dimensional language, referring to “particles”. For convenience we will set the mass of these particles, which will always be equal here, to unity.

B. Finite system

Let us consider first the case of a finite system, consisting of a finite number N of particles (with either open boundary conditions, or contained in a finite box). Denoting by x_i the coordinate position of the i^{th} particle along the real axis, the force field $F(x)$ (i.e. the force on a test particle) at the point x is

$$F(x) = g \sum_i \operatorname{sgn}(x_i - x) = g \int dy n(y) \operatorname{sgn}(y - x), \quad (2)$$

where $n(y) = \sum_i \delta_D(y - x_i)$ is the microscopic number density and the integral is over the real line². Equivalently it may be written as

$$F(x) = g \left[N_{>}(x) - N_{<}(x) \right]. \quad (3)$$

where $N_{>}(x)$ ($N_{<}(x)$) is the number of particles to the right (left) of x . The dynamics of this model, from various initial conditions and over different times scales, has been extensively explored in the literature (see references given above).

C. Infinite system limit

Let us consider now the infinite system limit, i.e., an infinite uniform distribution of points³ on the real line with some mean density n_0 (e.g. a Poisson process). It is evident that the forces acting on particles are not well defined in this limit, as the difference between the number of particles on the right and left of a given particle depends on how the limit is taken. Formally we can write the force field of Eq. (2) as

$$F(x) = gn_0 \int dy \operatorname{sgn}(y - x) + g \int dy \delta n(y) \operatorname{sgn}(y - x), \quad (4)$$

where $\delta n(y) = n(y) - n_0 = \sum_i \delta_D(y - x_i) - n_0$ represents the number density fluctuation. While the second term would, naively, be expected to converge if the fluctuations $\delta n(y)$ can decay sufficiently rapidly, the first term, due to the mean density, is explicitly badly defined (as the integral is only semi-convergent). Precisely the same problem arises for gravity in infinite $3 - d$ distributions. The solution, known as the “Jeans swindle”, is the subtraction of the contribution due to the mean density. As discussed by Kiessling in [23], rather than a “swindle”, this is, in $3 - d$, in fact a mathematically well-defined regularisation of the physical problem, corresponding simply to the prescription that the force at a point be summed so that it vanishes in the limit of exact uniformity. The simplest form of such a prescription in $3 - d$ is that the force on a particle be calculated by summing symmetrically about the particle (e.g. by summing about the considered point in spheres of radius R , and then sending $R \rightarrow \infty$). This formulation needs no explicit use of a “background subtraction”, since the term due to the mean density does not contribute when the sum is performed symmetrically.

Applying the same reasoning to the $1 - d$ case would lead to the prescription

$$F(x) = g \int dy \delta n(y) \operatorname{sgn}(y - x). \quad (5)$$

The question is whether this expression for the gravitational force is now well defined, and if it is, in what class of infinite point distributions. As we will detail in the next section of the paper, this question may be given a precise answer, as in $3 - d$, by considering the probability density function of the force in such distributions, described as stochastic point processes in infinite space. In the rest of this section we will simply explain the problems which arise when the infinite system limit of expression Eq. (5) is taken using a simple top-hat prescription. This discussion motivates the use of a smooth version of this prescription, which we then show rigorously in the subsequent section to give a well defined force for a broad class of infinite perturbed lattices.

For Eq. (5) to be well defined in an infinite point distribution it must give the same answer no matter how it is calculated. Two evident top-hat prescriptions for its calculation are the following. On the one hand it may be written as

$$F(x) = g \lim_{L \rightarrow \infty} \int_{x-L}^{x+L} dy n(y) \operatorname{sgn}(y - x), \quad (6)$$

or, equivalently,

$$F(x) = g \lim_{L \rightarrow \infty} \left[N(x, x+L) - N(x-L, x) \right], \quad (7)$$

where $N(x, y)$ is the number of points between x and y , i.e., the force is proportional to the difference in the number of points on the right and left of x inside a *symmetric interval centred on x* , when the size of the interval is taken to infinity. On the other hand, we can write

$$F(x) = g \lim_{L \rightarrow \infty} \int_{-L}^{+L} dy \delta n(y) \operatorname{sgn}(y - x), \quad (8)$$

or, equivalently,

$$F(x) = g \lim_{L \rightarrow \infty} \left[N(x, L) - N(-L, x) \right] + 2gn_0x, \quad (9)$$

i.e., we integrate the mass density fluctuations in a top-hat centred *on some arbitrarily chosen origin*.

That these expressions are both badly defined in an infinite Poisson distribution is easy to see: in this case the fluctuation in mass on the right of any point is uncorrelated with that on the left, giving a typical force proportional to the square root of the mass in a randomly placed window of size L , which grows in proportion to \sqrt{L} (and thus diverges). Calculating the force with Eq. (7) one of us (AG) has shown in [25] that it is in fact not well defined either in a class of more uniform distributions

² We use the standard convention that $\operatorname{sgn}(0) = 0$, which implies this same formula is valid for the force on a particle of the distribution (rather than a test particle) at x .

³ By “uniform” we mean that the point process has a well defined *positive* and spatially constant mean density, i.e., it becomes homogeneous at sufficiently large scales.

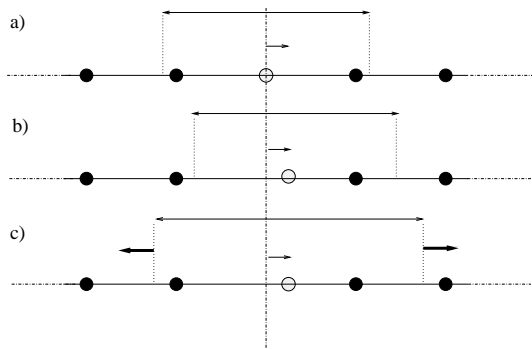

FIG. 1: Calculation of the force using a top-hat regularisation centred on the point considered, i.e., as defined in Eq. (7). In an unperturbed lattice (case a) the force on points of the lattice vanishes. However, as shown in b) and c), when a single point is displaced off lattice, the force becomes badly defined, oscillating between g and zero as the size of top-hat goes to infinity.

of points, randomly perturbed lattices⁴. Why this is so can be understood easily by considering, as illustrated in Fig. 1, the calculation of the force using Eq. (7) in such configurations. While on the unperturbed lattice (case a) the force on all points of the lattice is well-defined (and vanishing, as it should be), this is no longer true when a particle is displaced: the force on the displaced particle now oscillates deterministically (between g in case b, and zero in case c) and does not converge as $L \rightarrow \infty$.

For the same case, of a single particle displaced off an infinite perfect lattice, the prescription Eq. (9) for the force does, however, give a well-defined result if one chooses as origin a point of the *unperturbed* lattice: since the first (“particle”) term is unchanged by the displacement of the particle, the only non-vanishing contribution comes from the second (“background”) term, giving a finite force

$$F(u) = 2gn_0u, \quad (10)$$

where u is the displacement of the particle from its lattice site (i.e. the centre of symmetry) and we assume u is smaller than the lattice spacing. If we consider now, however, applying random displacements of small amplitude (compared to the interparticle spacing) to the other particles of the lattice, the problem of the first prescription Eq. (7) reappears: at any given L the first term in Eq. (9) picks up a stochastic fluctuation which varies discretely between $\pm g$ and zero, and does not converge as $L \rightarrow \infty$. This will evidently be the case for any such configuration generated by displacing particles off a lattice, and

⁴ The force is, however, shown to be well defined in this class of point distributions using the analogous definition for any power law interaction in which the pair force decays with separation. See [25] for details.

more generally for any stochastic particle distribution in $1 - d$. It is thus necessary to introduce some additional constraint to make this surface contribution to the force vanish.

The previous literature on this model employ top-hat prescriptions equivalent to Eq. (9) to calculate the force, adding such a constraint. On the one hand, Aurell et al. in [13] restrict themselves to the study of an infinite perfect lattice off which only a *finite* number are initially displaced. In this case the problematic surface fluctuation vanishes for sufficiently large L . On the other hand [10, 16, 17, 18] impose exact symmetry in the displacements about some chosen point, which is then taken as the origin of the symmetric summation interval. A particle entering (or leaving) at one extremity of the interval is then always compensated by one doing the same at the other extremity.

We note that it is only in [13] that the problem of the infinite system limit is actually considered. In the other works the authors do not discuss this limit explicitly: they consider and study in practice a finite system, with a prescription for the force equivalent to Eq. (9) where $2L$ is the system size, i.e., without the explicit limit $L \rightarrow \infty$. Symmetry about the origin is imposed because this allows one to use periodic boundary conditions. Such a *finite* periodic system of period $2L$ is equivalent to a finite system of size L with reflecting boundary conditions. The dynamics of such a system is of course always well defined, for any (finite) initial distribution of the points in the box. This does not, however, mean that this dynamics can be defined in the limit that the size of the system is taken to infinity. This is the question we focus on here, as the definition of such a limit is essential if a proper analogy is to be made with the cosmological problem in $3 - d$: in this case the gravitational force is well defined in the infinite system limit, for a class of statistically translationally invariant distributions representing the initial conditions of cosmological models⁵.

The problems with the top-hat prescriptions arise, as we have seen, from non-convergent fluctuations at the surface of a top-hat window, which will be generic in statistically translationally invariant point processes. It is thus natural to consider smoothing the summation window, and specifically a prescription for Eq. (5) such as:

$$F(x) = g \lim_{\mu \rightarrow 0} \int dy n(y) \operatorname{sgn}(y - x) e^{-\mu|x-y|}, \quad (11)$$

⁵ Numerically one treats, of course, a periodic system, but it is an *infinite* periodic system, i.e., the force is calculated by summing over the particles in the finite box and all its (infinite) copies. This is the so-called “replica method”, used also widely in equilibrium systems such as the one component plasma [27]. The infinite sum is usually calculated using the Ewald sum method. To obtain results independent of the chosen periodic box, the prescription for the force must converge in the appropriate class of infinite point distributions.

or, equivalently,

$$F(x) = g \lim_{\mu \rightarrow 0} \sum_i \text{sgn}(x_i - x) e^{-\mu|x_i - x|}, \quad (12)$$

where the sum runs over all particles in the (infinite) distribution. Rather than a smoothing of the summation window, this can be interpreted more physically in terms of the screening of the gravitational interaction, i.e., the pair force law of Eq. (1) is replaced by

$$f_\mu(x) = -g \text{sgn}(x) e^{-\mu|x|}, \quad (13)$$

and the gravitational force in the infinite system limit is defined as that obtained when the screening length is taken to infinity, *after* the infinite system is taken⁶ (see Fig. 2). This treatment is borrowed from the class of infrared problems well known in quantum field theory. The standard procedure of handling infrared divergences is to apply an infrared regularization, to solve the regularized problem, and to remove the regularization at the end of the calculation, perhaps involving a renormalization.

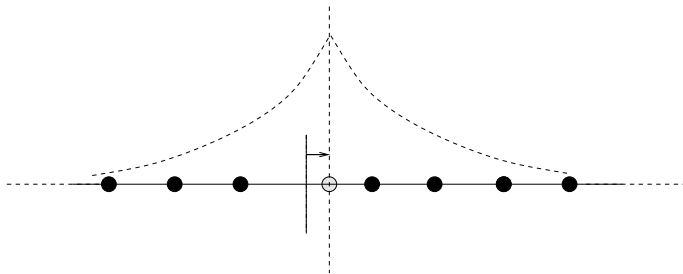

FIG. 2: Schematic representation of the smooth screening of the force (or, equivalently, summation window).

For the case of a single particle displaced off a perfect lattice discussed above it is simple to calculate the force using Eq. (11). Denoting the lattice spacing by ℓ , and the displacement by u , we have

$$F(u) = g \lim_{\mu \rightarrow 0} \sum_{n \neq 0} \text{sgn}(n\ell - u) e^{-\mu|n\ell - u|}. \quad (14)$$

For $|u| \leq \ell$ the sum gives

$$2 \sinh(\mu u) \left(\sum_{n > 0} e^{-\mu n \ell} \right). \quad (15)$$

Expanding this in powers of μ we obtain

$$F_\mu(u) = \frac{2gu}{\ell} + O(\mu). \quad (16)$$

Taking the limit $\mu \rightarrow 0$ gives Eq. (10), i.e., the result obtained using the top-hat prescription Eq. (9). The equivalence of the two prescriptions can likewise be shown to apply when displacements are applied to a *finite* number of particles on the lattice (which leave the forces unchanged, and equal to Eq. (10), if there are no crossings). Thus the only difference between the prescriptions is how they treat the contribution from particles at arbitrarily large distances when the infinite system limit is taken.

We will show rigorously in the next section that, for a class of infinite perturbed lattices in which particles do not cross, the prescription Eq. (11) simply removes the problematic surface contribution present in the top-hat prescriptions (without applying any additional constraint of symmetry). This gives a force on each particle equal to Eq. (10) where u is the displacement of the particle, the only difference with respect to the case of a finite number of displaced particles being that the origin of this displacement may be redefined by a net translation of the whole system induced by the infinite displacements. The force felt by each particle is thus equivalent to that exerted by an inverted harmonic oscillator about an (unstable) equilibrium point. We note that this expression for the force is in fact what one would expect from a naive generalization of the analogous results in $3-d$. In the latter case it can be shown [26] that the force on a single particle displaced off an infinite lattice by a vector \mathbf{u} is, to linear order in $|\mathbf{u}|$, simply

$$\mathbf{F}(\mathbf{u}) = 4\pi G\rho_0 \mathbf{u}/3. \quad (17)$$

This force is simply that which is inferred, by Gauss's law, as due to a uniform background of mass density $-\rho_0$ (i.e. due to the mass of such a background contained in a sphere of radius $|\mathbf{u}|$). The $1-d$ result is exactly analogous, as $2n_0|u|$ is simply the mass inside the interval of "radius" $|u|$. While this result is valid, in $3-d$, only at linear order and for the case of a single displaced particles, it is exactly valid in $1-d$ in absence of particle crossings and for a broad class of displacement statistics. The reason is simply that in $1-d$ the force on a particle is unaffected by displacements of other particles, unless the latter cross the considered particle.

III. FORCES IN INFINITE PERTURBED LATTICES

In this section we calculate, using the definition Eq. (12), the gravitational force on particles in a class of infinite perturbed lattices. To do this we describe these point distributions as generated by a stochastic process in which the particles are displaced⁷. The force on a

⁶ Although we will not use the interparticle potential in our calculations, we note that $f_\mu(x) = -d\phi_\mu/dx$ where $\phi_\mu(x) = -ge^{-\mu|x|}/\mu$ is the solution of $\frac{d^2\phi_\mu}{dx^2} - \mu^2\phi_\mu = 2g\delta_D(x)$.

⁷ For an introduction to the formalism of stochastic point processes i.e. stochastic spatial distributions of point-particles with identical mass, see, e.g., [22].

particle (or the force field at a point in space) is then itself a stochastic variable, taking a different value in each realization of the point process, and the question of its definedness can be cast in terms of the existence of the probability distribution function (PDF) of the force. We thus calculate here the PDF of the force on a particle with a given displacement u , in the ensemble of realizations of the displacements of the other particles. The result is that, for the class of stochastic displacement fields in which displacements are such that particles do not cross, this force PDF becomes simply a Dirac delta function. This gives the anticipated result, that the only force which results is that due to the particle's own displacement given by Eq. (10), modulo an additional term describing a contribution from the coherent displacement of the whole infinite lattice if the average displacement is non-zero.

A. Stochastic perturbed lattices

Let us consider first an infinite $1-d$ regular chain of unitary mass particles with lattice spacing $\ell > 0$, i.e., the position of the n^{th} particle is $X_n = n\ell$, and the microscopic number density can be written as

$$n_{in}(x) = \sum_{n=-\infty}^{+\infty} \delta_D(x - n\ell). \quad (18)$$

We now apply a stochastic displacement field $\{U_n\}$ to this system, in which the displacement U_n is applied to the generic n^{th} particle with $n \in \mathbb{Z}$. Let us call $\{u_n\}$ the single realization of the stochastic field $\{U_n\}$. The corresponding realization of the point process thus has microscopic number density

$$n(x) = \sum_{n=-\infty}^{+\infty} \delta_D(x - n\ell - u_n). \quad (19)$$

This displacement field is completely characterized by the joint displacement PDF $\mathcal{P}(\{u_n\})$ where $\{u_n\}$ is the set of all particle displacements with $n \in \mathbb{Z}$. We will further assume that this stochastic process is statistically translationally invariant, i.e. $\mathcal{P}(\{u_n\}) = \mathcal{P}(\{u_{n+l}\})$ for any integer l . This implies in particular that the one displacement PDF (for the displacement applied to a single particle) is independent of the position of that particle, i.e., the function

$$p_m(u) \equiv \int \prod_n du_n \mathcal{P}(\{u_n\}) \delta_D(u - u_m) \quad (20)$$

is independent of m , i.e. $p_m(u) = p(u)$. Moreover the joint two-displacement PDF

$$q_{nm}(u, v) = \int \prod_n du_n \mathcal{P}(\{u_n\}) \delta_D(u - u_m) \delta_D(v - u_n)$$

depends parametrically on the lattice positions n, m only through their relative distance $(m - n)$.

B. Mean value and variance of the total force

Let us denote in general by $F_\mu(x_0)$ the total gravitational force, with finite screening μ , acting on the particle at x_0 and due to all the other particles placed at x_n :

$$F_\mu(x_0) = g \sum_{n \neq 0} \text{sgn}(x_n - x_0) e^{-\mu|x_n - x_0|}. \quad (21)$$

Writing now $x_n = n\ell + u_n$ in Eq. (21), we can write the total screened force on the particle at $x_0 = u_0$ in a perturbed lattice for a given realization of the displacement field:

$$F_\mu(u_0) = g \sum_{n \neq 0} \text{sgn}(n\ell + u_n - u_0) e^{-\mu|n\ell + u_n - u_0|}. \quad (22)$$

Note that, given the assumed statistical translational invariance of the field $\{U_n\}$ the statistical properties of the force are the same for all particles in the system. If, further, we assume now that the displacements from the lattice are such that *particles do not cross*, i.e. $\text{sgn}(n\ell + u_n - u_0) = \text{sgn}(n)$ for $n \neq 0$, this can be written as

$$F_\mu(u_0) = g \sum_{n=1}^{\infty} e^{-\mu n\ell} f_n, \quad (23)$$

where we define for, $n \geq 1$,

$$f_n \equiv f_n(\mu) = e^{-\mu(u_n - u_0)} - e^{-\mu(u_0 - u_n)}.$$

We now take the average of Eq. (23) over all realizations of the displacements of all particles, except the chosen one u_0 , which we consider as fixed. We denote this conditional average as $\langle \cdot \rangle_0$, while we use $\langle \cdot \rangle$ for the unconditional average. In order to do this we need the conditional PDF of U_n to U_0 , which by definition of conditional probability is

$$P_n(u; u_0) = \frac{q_{n0}(u, u_0)}{p(u_0)}. \quad (24)$$

By using this function we can write

$$\langle f_n(\mu) \rangle_0 = e^{\mu u_0} \tilde{P}_n(\mu; u_0) - e^{-\mu u_0} \tilde{P}_n(-\mu; u_0) \quad (25)$$

and therefore

$$\langle F_\mu(u_0) \rangle_0 = g \sum_{n=1}^{\infty} \left[e^{\mu u_0} \tilde{P}_n(\mu; u_0) - e^{-\mu u_0} \tilde{P}_n(-\mu; u_0) \right] e^{-\mu n\ell} \quad (26)$$

where we have defined

$$\begin{aligned} \tilde{P}_n(\mu; u_0) &= \int_{-\infty}^{\infty} du P_n(u; u_0) e^{-\mu u}, \\ &= \sum_{k=0}^{\infty} \frac{(-\mu)^k \langle U_n^k \rangle_0}{k!}. \end{aligned} \quad (27)$$

The latter equality is valid when all the moments $\langle U_n^k \rangle_0$ of $P_n(u; u_0)$ are finite. Note that, given the assumption that particles do not cross, it follows from the definition (24) that $q_{n0}(u, u_0) = 0$ for $u + n \leq u_0$ respectively for $n \geq 0$. Therefore $P_n(u; u_0)$ is always zero for some sufficiently negative u_0 dependent value of u if $n > 0$, and likewise for sufficiently positive values if $n < 0$. This ensures that the integral in Eq. (27) is indeed finite.

In order to study the behavior of Eq. (26) for $\mu \rightarrow 0$, we will assume that

$$q_{nm}(u, v) \xrightarrow{|n-m| \rightarrow \infty} p(u)p(v). \quad (28)$$

This corresponds to the assumption that the displacement field is a well defined stochastic field, which requires (see e.g. [22]) that the two-displacement correlations vanish as the spatial separation diverges. We will discuss in the next section the restriction this corresponds to on the large scale behaviour of the density perturbations, which is of particular relevance when one considers the analogy to $3-d$ cosmological simulations.

Assuming Eq. (28) we can write

$$P_n(u; u_0) = p(u) + r_n(u; u_0),$$

where $r_n(u; u_0)$ is a function vanishing for $|n| \rightarrow \infty$ and with zero integral over u for any n . As a consequence

$$\tilde{P}_n(\mu; u_0) = \tilde{p}(\mu) + \tilde{r}_n(\mu; u_0), \quad (29)$$

where we used the definition analogous to Eq. (27) for $\tilde{p}(\mu)$ and $\tilde{r}_n(\mu; u_0)$, and the latter vanishes for $\mu \rightarrow 0$ and/or $n \rightarrow \infty$. If we now suppose that both $\langle U \rangle$ and $\langle U_n \rangle_0$ are finite, with evidently $\langle U_n \rangle_0 \rightarrow \langle U \rangle$ for $n \rightarrow \infty$, we can write at lower order:

$$\begin{aligned} \tilde{p}(\mu) &= 1 - \mu \langle U \rangle + o(\mu), \\ \tilde{r}_n(\mu; u_0) &= \mu(\langle U \rangle - \langle U_n \rangle_0) + o(\mu). \end{aligned} \quad (30)$$

It is now simple, by substituting Eqs. (29) and (30) into Eq. (26), to show that, if $(\langle U \rangle - \langle U_n \rangle_0)$ decays in n as a negative power law or faster, we have

$$\langle F(u_0) \rangle_0 \equiv \lim_{\mu \rightarrow 0} \langle F_\mu(u_0) \rangle_0 = 2gn_0(u_0 - \langle U \rangle). \quad (31)$$

We will now show that both for uncorrelated displacements, and then more generally for correlated displacements with decaying correlations, this average force is in fact the exact force in every realization. We do so by simply showing that

$$\lim_{\mu \rightarrow 0} \left[\langle F_\mu^2(u_0) \rangle_0 - \langle F_\mu(u_0) \rangle_0^2 \right] = 0. \quad (32)$$

This implies that the variance of the conditional PDF of the total force F acting on the particle at u_0 vanishes, i.e., this PDF is a Dirac delta function at the average value given by Eq. (31). Compared to the simple case of a single displaced particle we analysed above, the only effect of the (infinite number of) other displacements is

to possibly shift the centre of mass of the whole (infinite) distribution with respect to which the displacement of the single particle is defined.

In order to show Eq. (32) we note first that the second conditional moment of F may be written

$$\begin{aligned} \langle F_\mu^2(u_0) \rangle_0 &= g^2 \sum_{n,m}^{1,\infty} e^{-\mu(n+m)\ell} \langle f_n f_m \rangle_0 \\ &= \langle F_\mu(u_0) \rangle_0^2 + g^2 \sum_{n=1}^{\infty} e^{-2\mu n\ell} A_n(\mu) \\ &\quad + g^2 \sum_{n,m}^{1,\infty} e^{-\mu(n+m)\ell} B_{nm}(\mu), \end{aligned} \quad (33)$$

with

$$\begin{aligned} A_n(\mu) &= \langle f_n^2 \rangle_0 - \langle f_n \rangle_0^2, \\ B_{nm}(\mu) &= \langle f_n f_m \rangle_0 - \langle f_n \rangle_0 \langle f_m \rangle_0 \quad (m \neq n), \end{aligned} \quad (34)$$

and where $\sum'_{n,m}$ as usual indicates the sum over m and n with the exception of the $n = m$ terms. To prove Eq. (32) it is sufficient to show that the last two terms in Eq. (33) go continuously to zero as μ does so.

C. Lattice with uncorrelated displacements

We consider first the case that the displacements are uncorrelated and identically distributed, i.e.,

$$\mathcal{P}(\{u_n\}) = \prod_{n=-\infty}^{+\infty} p(u_n). \quad (35)$$

We refer to this as a ‘‘shuffled lattice’’ configuration (following [22]). In this case conditional and unconditional averages coincide. Given the assumption that the displacements do not make particles cross, we must have that $p(u) = 0$ for $|u| > \ell/2$, implying that all the moments of $p(u)$ are necessarily finite.

In this case the u_n are statistically independent and identically distributed random variables. Given the definition Eq. (24), it follows that the f_n also have this property, i.e.,

$$\langle f_n f_m \rangle = \langle f_n \rangle \langle f_m \rangle, \quad (36)$$

and thus that $B_{nm}(\mu) = 0$. Further $A_n(\mu)$ is independent of n and can be expressed explicitly as

$$A_n(\mu) = e^{2\mu u_0} [\tilde{p}(2\mu) - \tilde{p}^2(\mu)] - e^{-2\mu u_0} [\tilde{p}(-2\mu) - \tilde{p}^2(-\mu)]. \quad (37)$$

Expanding this expression in μ about $\mu = 0$, we find that the leading non-vanishing term is at order μ^2 . The desired result, Eq. (32), follows as

$$\sum_{n=1}^{\infty} e^{-2\mu n\ell} = \frac{e^{-2\mu\ell}}{1 - e^{-2\mu\ell}} = O(\mu^{-1}) \quad \text{for } \mu \rightarrow 0,$$

where $O(\mu^l)$ means as usual a term of order l in μ .

D. Lattice with correlated displacements

We now consider the case where the displacements are non-trivially correlated. In order to calculate $A_n(\mu)$ and $B_{nm}(\mu)$ we need both the conditional single displacement PDF $P_n(u; u_0)$ and the conditional two-displacement PDF $Q_{nm}(u, v; u_0)$, both conditioned to the fixed value u_0 of the stochastic displacement U_0 . The function $Q_{nm}(u, v; u_0)$ is defined by the rules of conditional probability as

$$Q_{nm}(u, v; u_0) = \frac{s_{nm0}(u, v, u_0)}{p(u_0)},$$

where $s_{nml}(u, v, w)$ is the joint three displacement PDF of having the three displacements u, v, w respectively at the lattice sites n, m, l .

Let us start from the evaluation of $A_n(\mu)$. From its definition it is simple to show that

$$\begin{aligned} \langle f_n^2(\mu) \rangle_0 &= e^{2\mu u_0} \tilde{P}_n(2\mu; u_0) + e^{-2\mu u_0} \tilde{P}_{-n}(-2\mu; u_0) \\ &\quad - 2\tilde{Q}_{n-n}(\mu, -\mu; u_0), \end{aligned} \quad (38)$$

where

$$\tilde{Q}_{nm}(\mu, \nu; u_0) = \int \int_{-\infty}^{+\infty} du dv Q_{nm}(u, v; u_0) e^{-(\mu u + \nu v)}.$$

In order to study the limit $\mu \rightarrow 0$ we have to expand $\tilde{P}_n(\mu; u_0)$ and $\tilde{Q}_{nm}(\mu, \pm\mu; u_0)$ in powers of μ . Assuming that at least the first two moments of the displacement statistics are finite, we can write

$$\begin{aligned} \tilde{P}_n(\mu; u_0) &= 1 - \mu \langle U_n \rangle_0 + \frac{\mu^2}{2} \langle U_n^2 \rangle_0 + o(\mu^2), \\ \tilde{Q}_{nm}(\mu, \pm\mu; u_0) &= 1 - \mu (\langle U_n \rangle_0 \pm \langle U_m \rangle_0) + \frac{\mu^2}{2} (\langle U_n^2 \rangle_0 \\ &\quad + \langle U_m^2 \rangle_0 \pm \langle U_n U_m \rangle_0) + o(\mu^2). \end{aligned} \quad (39)$$

Using this result and Eqs. (25) and (38) in the definition (34) of $A_n(\mu)$, it is simple to show that

$$\begin{aligned} A_n(\mu) &= \mu^2 \left[e^{2\mu u_0} (\langle U_n^2 \rangle_0 - \langle U_n \rangle_0^2) \right. \\ &\quad \left. + e^{-2\mu u_0} (\langle U_{-n}^2 \rangle_0 - \langle U_{-n} \rangle_0^2) \right. \\ &\quad \left. + 2(\langle U_n U_{-n} \rangle_0 - \langle U_n \rangle_0 \langle U_{-n} \rangle_0) \right] + o(\mu^2). \end{aligned} \quad (40)$$

Note that for $|n| \rightarrow \infty$ we have $\langle U_n \rangle_0 \rightarrow \langle U \rangle$, $\langle U_n^2 \rangle_0 \rightarrow \langle U^2 \rangle$ and $\langle U_n U_{-n} \rangle_0 \rightarrow \langle U \rangle^2$. Therefore we can write

$$A_n(\mu) \xrightarrow{n \rightarrow \infty} \mu^2 (\langle U^2 \rangle - \langle U \rangle^2) (e^{2\mu u_0} + e^{-2\mu u_0}),$$

where we have used the fact that, as the coefficients of the higher order contributions in μ to $A_n(\mu)$ are non-diverging, they can be neglected. This is sufficient to conclude that

$$\sum_{n=1}^{\infty} e^{-\mu n} A_n(\mu) = O(\mu), \quad (41)$$

where $O(\mu^l)$ as usual means a term of order μ^l , and therefore the sum vanishes as μ for $\mu \rightarrow 0$.

Let us now move to analyze the last sum in Eq. (33). We study the behavior of $B_{nm}(\mu)$ as defined by Eq. (34). It is simple to show that

$$\begin{aligned} \langle f_n f_m \rangle_0 &= e^{-2\mu u_0} \tilde{Q}_{nm}(\mu, \mu; u_0) + e^{2\mu u_0} \tilde{Q}_{-n-m}(-\mu, -\mu; u_0) \\ &\quad - \tilde{Q}_{n-m}(\mu, -\mu; u_0) - \tilde{Q}_{-nm}(-\mu, \mu; u_0). \end{aligned} \quad (42)$$

Using this equation together with Eqs. (34), (25) and (39), we can write

$$\begin{aligned} B_{nm}(\mu) &= \mu^2 [e^{-2\mu u_0} g(n, m; u_0) + e^{2\mu u_0} g(-n, -m; u_0) \\ &\quad - g(n, -m; u_0) - g(-n, m; u_0)] + o(\mu^2), \end{aligned} \quad (43)$$

where we have called

$$g(n, m; u_0) = \langle U_n U_m \rangle_0 - \langle U_n \rangle_0 \langle U_m \rangle_0,$$

i.e., the conditional displacement covariance matrix. Since this is a ‘‘conditional’’ correlation it does not depend simply on $n - m$, but on both n and m in a non-trivial way. However for both $|n|, |m| \rightarrow \infty$ the conditional averages coincide with the unconditional ones and therefore we can write

$$g(n, m; u_0) = c(|n - m|) [1 + h(n, m; u_0)], \quad (44)$$

where $c(|n - m|) = \langle U_n U_m \rangle - \langle U \rangle^2$ is the unconditional displacement covariance matrix, and $h(n, m; u_0) \rightarrow 0$ for $|n|, |m| \rightarrow \infty$. In order to analyze the asymptotic behavior for small μ of

$$I(\mu) \equiv \sum'_{n,m} e^{-\mu(n+m)} B_{nm}(\mu), \quad (45)$$

it is sufficient to study the behavior of the sum coming from the first term (or equivalently the second) of $B_{nm}(\mu)$ in Eq. (43) as it is the most slowly convergent one, i.e., basically to study the following sum:

$$J(\mu) = \sum'_{n,m} e^{-\mu(n+m)} g(n, m; u_0).$$

Since $h(n, m; u_0) \rightarrow 0$ for $|n|, |m| \rightarrow \infty$, the small μ scaling behavior of $J(\mu)$ is the same if we replace $g(n, m; u_0)$ by $c(|n - m|)$:

$$J(\mu) \simeq \sum'_{n,m} e^{-\mu(n+m)} c(|n - m|). \quad (46)$$

This can be also shown by the following argument: assuming that $h(n, m; u_0)$ is bounded, say $|h(n, m; u_0)| \leq A$, we can write

$$\begin{aligned} |J(\mu)| &\leq \sum'_{n,m} e^{-\mu(n+m)} |g(n, m; u_0)| \\ &\leq (1 + A) \sum'_{n,m} e^{-\mu(n+m)} |c(|n - m|)|. \end{aligned}$$

Therefore the convergence to zero of μ^2 times the right-hand side of Eq. (46) is a sufficient condition to have the variance of F to vanish for $\mu \rightarrow 0$.

Let us now analyze the right-hand side of Eq. (46). We can write

$$\begin{aligned} & \sum'_{n,m} e^{-\mu(n+m)} c(|n-m|) \\ &= \sum'_{n,m} e^{-\mu(n+m)} c(|n-m|) - c(0) \frac{1}{e^{2\mu} - 1}, \quad (47) \end{aligned}$$

where $c(0)$ is the single displacement variance. Note that the second term is of order μ^{-1} at small μ and therefore gives rise to a term at linear order in μ in Eq. (45). Let us introduce the Fourier transform $\tilde{c}(k)$ of $c(n)$, defined by

$$c(n) = \int_{-\pi}^{\pi} \frac{dk}{2\pi} \tilde{c}(k) e^{ikn}.$$

Using this in the right-hand side of Eq. (47) we get

$$\begin{aligned} & \sum'_{n,m} e^{-\mu(n+m)} c(|n-m|) \\ &= \int_{-\pi}^{\pi} \frac{dk}{2\pi} \tilde{c}(k) \frac{1}{e^{2\mu} + 1 - 2e^{\mu} \cos k}. \quad (48) \end{aligned}$$

The small μ limit of this integral is dominated by the behavior at small k of the integrand. In this limit the following approximation holds ($e^{2\mu} + 1 - 2e^{\mu} \cos k \simeq (\mu^2 + k^2)$). Let us also assume that $c(n) \sim n^{-\alpha}$ at large n (with in general $\alpha > 0$)⁸ which implies at small $|k|$ $\tilde{c}(k) \sim |k|^{\alpha-1}$ for $0 < \alpha \leq 1$ (with logarithmic corrections for $\alpha = 1$) and $\tilde{c}(k) \sim |k|^{\beta}$ with $\beta \geq 0$ for $\alpha > 1$. Therefore the small μ behavior of Eq. (48) is the same as that of the simple integral

$$\int_{-\pi}^{\pi} \frac{dk}{2\pi} \frac{\tilde{c}(k)}{\mu^2 + k^2} \sim \begin{cases} \mu^{\alpha-2} & \text{for } 0 < \alpha \leq 1, \\ \mu^{\beta-1} & \text{for } \alpha > 1. \end{cases} \quad (49)$$

Taking also into account the second term in Eq. (47), we can therefore conclude that

$$\sum'_{n,m} B_{nm}(\mu) e^{-(n+m)\mu} \sim \begin{cases} \mu^{\alpha} & \text{for } 0 < \alpha < 1, \\ \mu & \text{for } \alpha \geq 1. \end{cases} \quad (50)$$

This, together with the results for the first sum in Eq. (33), it follows that at small μ

$$\langle F_{\mu}^2(u_0) \rangle_0 - \langle F_{\mu}(u_0) \rangle_0^2 \sim \begin{cases} \mu^{\alpha} & \text{for } 0 < \alpha < 1, \\ \mu & \text{for } \alpha \geq 1, \end{cases} \quad (51)$$

⁸ The case of a decay faster than any power, e.g. exponential decay, can be included for $\alpha \rightarrow \infty$.

i.e. it vanishes in the $\mu \rightarrow 0$ limit and the PDF of the total force acting on a particle displaced by u_0 from its lattice position is $W(F; u_0) = \delta[F - 2g(u_0 - \langle U \rangle)]$. In other words, even in the case of spatially correlated displacements, the total force acting on a particle is a deterministic quantity equal to $2g(u_0 - \langle U \rangle)$ with no fluctuations. This value depends only on the displacement of the particle on which we are calculating the force and not on the displacements of other particles as it does in $3-d$ [26].

IV. DYNAMICS OF 1D GRAVITATIONAL SYSTEMS

In the previous section we have shown the prescription Eq. (11) for the $1-d$ gravitational force to give a well defined result in a class of infinite displaced lattice distributions. This result can be used in the construction of different toy models, through different prescriptions for the dynamics associated to these forces. In this section we discuss two such models, analogous to the $3-d$ cases of gravitational clustering in an infinite static or expanding universe, respectively. In the last subsection we discuss in detail the relation of these models to previous treatments of such models in the literature.

As motivation let us first comment on the reason for our interest in the case of perturbed lattices: in $3-d$ cosmological N -body simulations precisely such configurations are used as initial conditions. The reason is that by displacing particles from a lattice in this way, one can represent accurately, at sufficiently large scales, low-amplitude density perturbations about uniformity with a desired power spectrum $P(k)$ (for a detailed discussion see e.g. [22] or [40]). This algorithm is strictly valid in the limit of very small relative displacements of particles, so that the assumption that particles do not cross in our derivation is a reasonable one (although not, as we will discuss in our conclusions, rigorously valid). The further assumption Eq. (28) we have made, on the decay of correlations, corresponds, also to a reasonable restriction on the class of initial power spectra. Indeed it can be shown easily that it corresponds, in d dimensions, to the assumption that $P(k)/k^2$ be integrable at $k = 0$. In $3-d$ this corresponds to $P(k \rightarrow 0) \sim k^n$ with $n > -1$, which is strictly satisfied in typical cosmological models which are characterised by an exponent $n = 1$ at asymptotically small k .

A. Toy models: static

The simplest such model is the conservative Newtonian dynamics associated to the derived force law, i.e., with equation of motion

$$\ddot{x}_i = F_i(\{x_j, j = 0..\infty\}, t), \quad (52)$$

where F_i is the gravitational force on the i -th particle of the distribution, with position x_i at time t (and dots denote derivatives with respect to t), calculated using the prescription Eq. (12), i.e.,

$$\ddot{x}_i = -g \lim_{\mu \rightarrow 0} \sum_{j \neq i} \text{sgn}(x_i - x_j) e^{-\mu |x_i - x_j|}. \quad (53)$$

We have shown that, for the case of an infinite lattice subjected to displacements which (i) do not make the particles cross, and (ii) satisfy Eq. (28), the force on the right-hand side is simply given deterministically as proportional to the particle's displacement (when $\langle U \rangle$, the average displacement, is zero). Denoting then the displacements of the i -th particle by u_i , i.e. $x_i = i\ell + u_i$, the equation of motion is therefore

$$\ddot{u}_i(t) = 2gn_0 u_i(t), \quad (54)$$

i.e., simply that of an inverted harmonic oscillator. The same equation is valid in the case that $\langle U \rangle \neq 0$ if we define $x_i = i\ell + \langle U \rangle + u_i$. This equation of motion is valid, of course, only as long as the non-crossing condition is satisfied. While it is in principle straightforward to generalize our calculation of the force to incorporate the effects of a finite number of crossings, it is much more convenient to make use of the following fact, which we recalled above: particles crossings in $1-d$ are equivalent, up to exchange of particle labels, to elastic collisions between particles, in which velocities are exchanged. This means that if we are interested in properties of the model which do not depend on particle labels, the model of $1-d$ self-gravitating particles is *equivalent* to a model in which particles bounce elastically. In this case the particles displacements from their original lattice sites are *at all times* such that there is no crossing of particles, and Eq. (54) remains valid, except exactly at ‘‘collisions’’. The dynamics of this model is therefore equivalent to that of an infinite set of inverted harmonic oscillators centred on the sites of a perfect lattice which bounce elastically, exchanging velocities, when they collide. As in the finite ‘‘sheet model’’ the equation of motion may be integrated exactly. Defining, for convenience, time in units of the characteristic ‘‘dynamical’’ time $\tau_{dyn} = 1/\sqrt{2gn_0}$, the evolution between collisions is given exactly by

$$u_i(t_0 + t) = u_i(t_0) \cosh t + v_i(t_0) \sinh t, \quad (55)$$

$$v_i(t_0 + t) = u_i(t_0) \sinh t + v_i(t_0) \cosh t, \quad (56)$$

where $u_i(t_0)$ [$v_i(t_0)$] is the position (velocity) after the preceding collision. The solution of the dynamics requires simply the determination of the next crossing time, which involves the solution of a quadratic equation (in e^t), followed by an appropriate updating of the velocities of the colliding particles.

B. Toy models: expanding

The model we have just discussed is the $1-d$ analogy for the problem of gravitational clustering in an infinite

static universe, with equations of motion

$$\ddot{\mathbf{r}}_i = -Gm \sum_{j \neq i}^J \frac{\mathbf{r}_i - \mathbf{r}_j}{|\mathbf{r}_i - \mathbf{r}_j|^3}, \quad (57)$$

for identical particles of mass m . We use the superscript J on the sum to indicate that the sum is calculated using the Jeans swindle. As we have discussed this ‘‘swindle’’ in $3-d$ can be implemented by summing symmetrically about the point i either in a top-hat (i.e. sphere) or using the limiting procedure with a screening.

The equations of motion for particles in an infinite *expanding* $3-d$ universe are usually written in the form

$$\ddot{\mathbf{x}}_i + 2H\dot{\mathbf{x}}_i = -\frac{Gm}{a^3} \sum^J \frac{\mathbf{x}_i - \mathbf{x}_j}{|\mathbf{x}_i - \mathbf{x}_j|^3}, \quad (58)$$

where \mathbf{x}_i are the so-called *comoving coordinates* of the particles, $H(t) = \dot{a}/a$ is the Hubble ‘‘constant’’, and $a(t)$ is the scale factor which is a solution of the equations

$$H^2 = \left(\frac{\dot{a}}{a}\right)^2 = \frac{8\pi G}{3a^3} \rho_0 + \frac{C}{a^2}, \quad (59)$$

$$\frac{\ddot{a}}{a} = -\frac{4\pi G}{3a^3} \rho_0, \quad (60)$$

where ρ_0 is the mean mass density when $a = 1$, and C is a constant of integration⁹.

Note that these equations can be derived entirely in a Newtonian framework, and correspond simply to a different regularisation of the infinite system limit than that employed in the Jeans swindle: instead of discarding the effect of the mean mass density, the force is regularised so that the mean density sources a homologous expansion (or contraction) of the whole system. This corresponds to taking equations of motion

$$\ddot{\mathbf{r}}_i = -Gm \lim_{R \rightarrow \infty} \sum_{j \neq i, |\mathbf{r}_j| < R} \frac{\mathbf{r}_i - \mathbf{r}_j}{|\mathbf{r}_i - \mathbf{r}_j|^3}, \quad (61)$$

i.e. with the sum for the force calculated by summing symmetrically *about a chosen origin*. Dividing the sum into a term due to the mean mass density and a term due to fluctuations about this density, this may be written as

$$\ddot{\mathbf{r}}_i = -\frac{4\pi G\rho}{3} \mathbf{r}_i - Gm \sum^J \frac{\mathbf{r}_i - \mathbf{r}_j}{|\mathbf{r}_i - \mathbf{r}_j|^3}, \quad (62)$$

Neglecting the second term (i.e. taking only the force due to the mean density) gives an equation of motion admitting solutions of the form $\mathbf{r}_i(t) = a(t)\mathbf{r}_i(t_0)$, with

⁹ $C = 0$ corresponds to the flat Einstein de Sitter universe, $C > 0$ to a closed universe, and $C < 0$ to an open universe. In the Newtonian derivation of these equations, given below, C can be expressed in terms of the physical particle velocities at some initial time.

$a(t)$ satisfying Eqs. (59) and (60). Changing to comoving coordinates defined by $\mathbf{r}_i = a(t)\mathbf{x}_i$ in Eq. (61) [or in Eq. (62)], and using Eq. (60), then gives Eq. (58).

Note that setting $a(t) = 1$ in Eq. (58) gives exactly the static case Eq. (57), i.e., the Jeans swindle in static space corresponds *formally* to the non-expanding limit of an expanding FRW universe. This static solution $a(t) = 1$ is, however, a solution to Eqs. (59) and (60) only if $\rho_0 = 0$ (and $C = 0$), i.e., it is not a *physical* limit of the expanding case but corresponds to the different prescription, Eq. (57), for calculating the force in the infinite volume limit. While almost all numerical studies are of the expanding case (for a review, see e.g., [1]), a recent study [28] of the static case for such initial conditions has shown that the evolution of clustering is, in essential respects, qualitatively similar in both cases. This suggests that it may be possible to understand essential qualitative features of the dynamics of structure formation in the universe in the conceptually simpler framework in which there is no expansion.

With the $3 - d$ equation of motion in the form of Eq. (58) it is evident how the static $1 - d$ model discussed above is naturally modified to mimic the $3 - d$ expanding case: one can simply replace the force term due to the infinite $3 - d$ distribution [i.e. the sum on the right-hand side of Eqs. (58)] by that due to the $3 - d$ distribution consisting of infinite sheets. The summation prescription implementing the Jeans swindle for the general $3 - d$ case, i.e. spherical top-hat summation, is then, as we have discussed at length above, most appropriately replaced by the smooth prescription we have given. Thus we take the following $1 - d$ equation for the positions x_i of the particles (sheets):

$$\ddot{x}_i + 2H\dot{x}_i = -\frac{2\pi G\Sigma}{a^3} \lim_{\mu \rightarrow 0} \sum_{j \neq i} \text{sgn}(x_i - x_j) e^{-\mu|x_i - x_j|}, \quad (63)$$

where the sum extends over the infinite distribution of sheets, and we have explicitly made the identification $g = 2\pi G\Sigma$ (where Σ is the mass per unit surface).

With initial conditions in the class of $1 - d$ infinite perturbed lattices for which we have shown the sum for the force to be well defined and given by Eq. (10), we then have

$$\ddot{u}_i + 2H\dot{u}_i = \frac{4\pi G\rho_0}{a^3} u_i, \quad (64)$$

where we have used that the mean comoving mass density $\rho_0 = \Sigma n_0$ (i.e. physical mass density when $a = 1$). As in the static case, this equation of motion remains valid at all times if we exchange the labels of particles when they cross, so that they bounce instead of passing through one another.

For the case of an Einstein de Sitter (EdS) universe, which corresponds to $C = 0$ in Eq. (59), $a(t) = (6\pi G\rho_0)^{1/3} t^{2/3}$ and Eqs. (64) simplify to

$$\ddot{u}_i + \frac{4}{3t}\dot{u}_i = \frac{2}{3t^2}u_i \quad (65)$$

of which the independent solutions are $u_i(t) \propto t^{2/3}$ and $u_i(t) \propto t^{-1}$ [which are simply the well known growing and decaying solutions for small perturbations to a self-gravitating fluid in an EdS universe (see, e.g., [21])]. The evolution in between ‘‘collisions’’ is thus given by

$$u_i(t) = u_i(t_0) \left[\frac{3}{5} \left(\frac{t}{t_0} \right)^{2/3} + \frac{2}{5} \left(\frac{t}{t_0} \right)^{-1} \right] + v_i(t_0) t_0 \left[\frac{3}{5} \left(\frac{t}{t_0} \right)^{2/3} - \frac{3}{5} \left(\frac{t}{t_0} \right)^{-1} \right]. \quad (66)$$

Note that, from Eq. (66) the determination of the crossings in these models, instead of a quadratic equation in the static model, thus involves the solution of a fifth order equation (for $t^{1/3}$).

C. Discussion of previous literature

1. Static models

A few previous studies [13, 18, 19] have considered static $1 - d$ toy models, defining the force on the right hand side of Eq. (52) as the derivative of a potential, which is the sum of the contribution from the sheets in a finite system of size L , and an additional one due to a uniform negative background. This is exactly the ‘‘naive’’ version of the Jeans swindle discussed above, and corresponds exactly to the prescription Eq. (9) for the calculation of the force (with L finite). The authors of [13] discuss explicitly the problems associated with taking the infinite system limit. As a result they limit their analysis only to a case for which their prescription gives a unique and finite result: a finite number of particles displaced off an infinite perfect lattice, modelling a finite localized perturbation embedded in an otherwise uniform universe. It is simple to verify that equation of motion for these displacements is then exactly Eq. (54), which we have now shown to be valid for the infinite lattice with perturbations which do not break the lattice translational invariance.

In [18, 19], on the other hand, the dynamics is formulated for a system of finite L , and the problem of the definedness of the force in the infinite system limit is not explicitly addressed. Instead it is dealt with implicitly by assuming that the finite system is symmetric about some point. Taking this latter point as origin of coordinates, the top-hat prescription Eq. (9) for the force at coordinate position x may then be rewritten as

$$F(x) = -2gN(0, x) + 2gn_0x, \quad (67)$$

in which the size of the system does not explicitly appear. Labelling the particles by their position with respect to the origin ($i = 1 \dots N$), the force on the i -th particle may then be written

$$F_i = 2gn_0 \left[x_i - \left(\frac{L}{N} \right) (i - 1) \right], \quad (68)$$

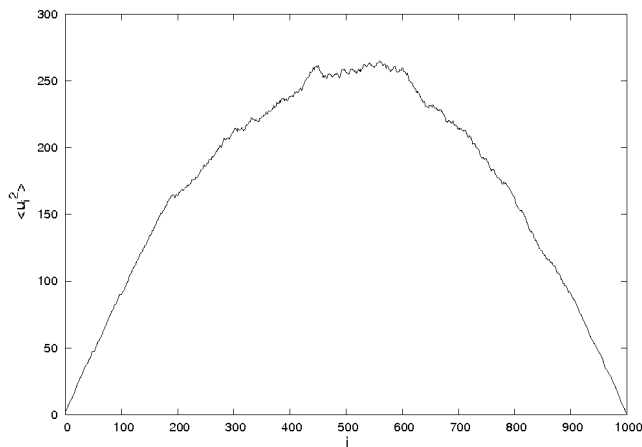

FIG. 3: The variance of the displacement u_i (see text) as a function of a particle’s ordered position i , calculated for one thousand realizations of one thousand particles randomly placed in an interval.

where x_i is the position of the particle. For any *finite* system the quantity in brackets can be considered as the displacement u_i of the particle i from its “original” lattice site [at $(i - 1)L/N$]. Thus the equation of motion for the particles is again identical to that we have derived.

We note again that we have derived this force law in this article without the assumption of symmetry (and without the explicit introduction of a background). Further, and most crucially, we have shown it to remain valid for a certain class of distributions when the infinite volume limit is taken — perturbed lattices without crossing and displacements of finite variance. In this respect we underline, as we have done in Sect. II, that while in the formulation of [18] the same equations of motion Eq. (54) are valid for the particles in *any* finite symmetric system, this does not mean that the infinite system limit is well defined, even with the assumed symmetry. It is illustrative to see what “goes wrong” when the infinite system limit is taken, specifically, for the case of a Poisson distribution, i.e., when we consider a system of size L in which we distribute N particles randomly, and then take $L \rightarrow \infty$ at fixed $n_0 = N/L$. The problem is that forces, although defined at any finite L by Eq. (68), diverge as L does. This can most easily be seen by considering the force written as Eq. (67): the force on a particle at x , as it is proportional to the fluctuation in the number of particles in the interval $[0, x]$ about its average value, grows in proportion to \sqrt{x} . Working with Eq. (68) this corresponds to the fact, which can easily be shown, that the variance of the displacements u_i (as defined above) diverges, violating an essential assumption for the perturbed lattices in the preceding section. Further this variance (in the finite system) depends also on i , so that discrete translational invariance, which we also assumed, is likewise broken. These properties are illustrated in Fig. 3, which shows the variance of the displacement u_i as

a function of i , as measured in one thousand realizations of one thousand randomly thrown particles. In a typical realization the force on a particle in the centre of the box is thus much larger than that on a particle at the boundaries. This means that the typical force on a particle therefore not only diverges as L does, but that in a finite system *its typical value depends on the position of the particle with respect to the boundaries*. In practice this means that all the particle trajectories in a symmetric finite system of initially Poisson distributed particles are, right from the initial time, modified when L is increased, and do not converge well as $L \rightarrow \infty$. Simulations of such initial conditions reported in [19] show the associated coherent global evolution of the mass distribution, which contrasts qualitatively with the local clustering characteristic of the $1 - d$ (and cosmological) simulations which we will describe in the next section.

2. Expanding models

We note first that Eq. (64) coincides exactly with that obtained in the so-called Zeldovich approximation in $3 - d$ (see, e.g., [21, 29]), when u_i is replaced by a vector function $\mathbf{u}(\mathbf{x})$. This approximation describes the evolution of displacement fields $\mathbf{u}(\mathbf{x})$ engendering small amplitude fluctuations to a self-gravitating *fluid* in an expanding universe, and can be obtained rigorously by a perturbative treatment of the full fluid equations [29] in the lagrangian formalism¹⁰. For the case of one-dimensional perturbations it is well known (see [21] and references therein) that this approximation becomes exact, up to the time when caustics form, corresponding to the crossing of “sheets” of fluid (i.e. particles in our case). It is thus, perhaps, not surprising, *a posteriori*, that we recover exactly the Zeldovich approximation for the motion of *discrete* sheets up to the time they cross: as the pair force between sheets is independent of separation, the only way a sheet can “see” that the force sourcing its motion is discrete, rather than continuous (as in the fluid limit), is when it crosses other sheets.

Eq. (64) can equally be derived [30, 31] using a perturbative treatment of the dynamics of an infinite perturbed lattice (in $3 - d$) of *particles*. For plane wave displacements of the particles with a wave-vector orthogonal to one of the lattice planes, the amplitude of the displacement wave obeys exactly this equation in the limit that the discreteness of the mass distribution in these orthogonal planes is neglected. This latter assumption is weaker than that used in this framework to derive the Zeldovich approximation for a general perturbation, which would require also that the displacement be of long wavelength compared to the discreteness scale in the direction par-

¹⁰ \mathbf{x} is a lagrangian coordinate and the fluid is exactly uniform when $\mathbf{u}(\mathbf{x}) = 0$.

allel to it.

In the studies of [11, 12], the authors study exactly the equations of motion Eq. (64) for the displacements of sheets perturbed off a perfect lattice (as in cosmological simulations). They adopt these equations arguing that they represent the fluid limit for $1-d$ perturbations in a $3-d$ expanding universe. While *before* sheet crossing (i.e. the formation of caustics), as discussed above, this is indeed known to be true — these equations are just the Zeldovich approximation which is, in this regime, exact — the extension to longer times is argued to be valid because the “collisionless” sheets of fluid will simply pass through one another. Our derivation of these equations shows that this in fact corresponds to the *discrete* particle/sheet model. Indeed we have *not* taken the fluid limit in our derivation, and the equations do not represent the fluid limit of this model. It simply happens to be the case that in this model, before crossing, the equations correspond with those in the fluid limit, for the physical reasons we have mentioned above. After crossing this equivalence breaks down, and the prescription used by [11] to “analytically continue” the fluid model beyond its regime of validity actually maps onto this discrete particle/shell model. We will discuss further in our conclusions the definition of the fluid limit for the $1-d$ models we are considering here.

The other two groups who have considered $1-d$ toy models incorporating $3-d$ expansion have, as in this article, worked in a particle/sheet framework. Both the original model, proposed in [10] and studied further in [14], and the subsequent one proposed and studied in [15, 16] and [17], derive their (different) equations of motion by following, formally, the steps described above leading from Eq. (61) to Eq. (58). The force on the right hand side of Eq. (57) is simply that due to the sheets, calculated in the analogous manner¹¹, i.e.,

$$\ddot{r}_i = 2\pi G \Sigma \lim_{L \rightarrow \infty} \sum_{r_j \in [-L, L]} \text{sgn}(r_j - r_i). \quad (69)$$

The change to comoving coordinates, when assumed also to rescale the mass in the sheets in the orthogonal direction (so that $\Sigma \rightarrow \Sigma/a^2$), gives

$$\begin{aligned} & \ddot{x}_i + 2H\dot{x}_i \\ &= \frac{2\pi G \Sigma}{a^3} \left[\lim_{L \rightarrow \infty} \sum_{x_j \in [-L, L]} \text{sgn}(x_j - x_i) + 2n_0 x_i \right], \end{aligned} \quad (70)$$

¹¹ In [10] the force term is simply denoted E_i , without an explicit prescription for calculating it. It can be inferred from the description given subsequently of the numerical simulations that the implicit summation is the symmetric top-hat centred at the spatial origin. In [15, 16], on the other hand, the top-hat regularisation is explicit.

provided that $a(t)$ obeys the equation

$$\frac{\ddot{a}}{a} = -\frac{4\pi G}{a^3} \rho_0. \quad (71)$$

As above $\rho_0 = \Sigma n_0$ is the mass density (in $3-d$) when $a = 1$.

The Eqs. (70) are those adopted by [10, 14, 15, 16, 17]. The term which we have written on the right hand side of the equation corresponds exactly to the prescription Eq. (9) for the calculation of the force. It incorporates the required subtraction of the effect of the background, so that motion in comoving coordinates is sourced only by perturbations to uniformity. Just as in the static models of [13, 18] discussed above, which are obtained formally by setting $a = 1$ in Eq. (70), this force is well defined only if symmetry is assumed about the chosen origin in the point distribution. This is indeed the assumption made in the numerical studies of [10, 14, 15, 16, 17].

The difference between the models of [10, 14] and of [15, 16] (studied also in [17]) arises only in what is assumed in each case about the scale factor $a(t)$. The former authors impose an EdS cosmology behaviour for the scale factor, $a(t) \propto t^{2/3}$, and require that it is a solution of Eq. (71). While this is mathematically consistent, it is not physically coherent: comparing Eq. (71) and Eq. (59) we see that it corresponds to imposing a Hubble expansion sourced by a mean density three times the physical mass density of the sheet (or, equivalently, assuming that the gravitational constant is not the same for the background as for the perturbations). Refs. [15, 16], on the other hand, simply impose that $a(t)$ be the EdS expansion, with the right normalization. This amounts to adding “by hand” a term to the derived equation [17]. While this is not mathematically rigorous within the context of the derivation just described, it is more appropriate physically. Indeed it corresponds effectively to simply replacing the Jeans swindle $3-d$ force term in Eq. (58) by the prescription Eq. (9). This differs from the “derivation” we have given above for Eqs. (63) only in the form of the Jeans swindle adopted. For the case that symmetry about the origin is assumed, we have the same equations of motion. In a finite system Eq. (68) is valid and so the equations of motion in their numerical simulations reduce exactly to Eqs. (64).

In conclusion the equations of motion Eqs. (64) are exactly the same as those used by [11, 12], and by [15, 16, 17]. The only difference in practice between all these studies are the initial conditions adopted and also the analysis of the resultant clustering given. Rather than working in the cosmological time variables, the latter authors define, a new time coordinate $\tau = \sqrt{2/3} \ln t$. Eqs. (65), for the case of an EdS universe, then take the very simple form

$$\frac{d^2 u_i}{d\tau^2} + \frac{1}{\sqrt{6}} \frac{du_i}{d\tau} = u_i. \quad (72)$$

In these variables the model is thus equivalent to an infinite set of inverted oscillators which bounce elastically,

with an additional *constant* damping. Because of the fifth order equation which must be solved to determine the crossings (now for the parameter $t^{1/3} = e^{\tau/\sqrt{6}}$), the model has been dubbed the “quintic” model by the authors of [15].

The model of [10, 14], on the other hand, is mathematically consistent but of less apparent relevance to the “real” $3 - d$ cosmological model, as the expansion it imposes on the sheets is not the physical $3 - d$ expansion. Indeed in this respect we note that, in the derivation of [10], any function $a(t)$ satisfying Eq. (71) can be adopted with the same consistency. The only way in fact in which the derivation of the $3 - d$ equations can be rigorously adapted to $1 - d$ is by using the $1 - d$ expansion law derived from Eq. (69) in the limit of uniformly distributed sheets. This is

$$a(t) = 1 + H_0 t - 2\pi G n_0 t^2, \quad (73)$$

where $H_0 = H(t = 0)$, i.e., free fall in a constant gravitational field of strength $4\pi G n_0$. As this is very different to the $3 - d$ expansion law it is probably not a variant of the toy model which is of practical interest.

V. CASE STUDY: INFINITE SHUFFLED LATTICES IN A STATIC UNIVERSE

We present in this section results of a numerical study of the static toy model above, starting from the simple “shuffled lattice” initial conditions. Our aim here in this brief presentation is simply to illustrate the qualitative similarity of the evolution to that observed in the exactly analogous $3 - d$ model, which has been presented and studied in [28] (see also [32, 33]). In particular we wish to illustrate that the toy model manifests the “hierarchical” and “self-similar” behaviours of the latter, which are features also of expanding universe simulations in $3 - d$. The studies cited above of this case [13, 18, 19] start from different initial conditions and focus on evolution on much longer times scales in which the finiteness of the box, or initial perturbation, is explicitly important. The study in [18, 19] considers, in particular, the regime of thermalisation, which is defined only for finite systems. On the other hand the dynamics we analyse is very similar qualitatively to that studied in the expanding models [10, 11, 14, 17]. Indeed the methods of analysis we use below are, as in [11], the standard ones used in cosmological simulations.

A. Numerical simulations

In a $3 - d$ cosmological N -body simulation, as we have noted, the underlying infinite physical system is treated numerically using the “replica method”, i.e., an infinite, but periodic, system is used. The numerical integration involves calculating the force on each of the N particles

by summing over this infinite system. Physical results should, of course, not depend on the size of the periodic box L . The underlying reason why this is true is that the forces on particles converge well in the infinite volume limit. More specifically the force on a given particle is that due to particles in a finite region about it. The size of this latter region is initially of order the mean inter-particle separation, but increases as clustering develops in the system. As long as the characteristic scale for this clustering is small compared to the chosen box size L , results are, to a good approximation, independent of L . A finite simulation can thus represent well the infinite system for a finite amount of time.

In the $1 - d$ case we have seen that for a class of perturbed lattices — which are the configurations used as initial conditions in cosmological simulations — the force is given exactly as a trivial function only of the particle displacement. Thus, to simulate numerically the evolution of this infinite system, the step in which the force is calculated is trivial (rather than involving the approximation of an infinite sum). The only question which arises is how to treat the boundary conditions of the finite sub-system of this infinite system which one can simulate. Periodic boundary conditions, i.e., particles which leave the finite interval on one side enter at the other side, are the evident simple choice, as they have advantage of maintaining (discrete) translational invariance. We could, however, easily use other boundary conditions (e.g. simply neglecting mass loss, or injecting mass in a stochastic manner to compensate average loss), and our results should not depend on this choice, just as they should not depend on the size of the interval.

We consider here “shuffled lattice” initial conditions and specifically with the PDF for the (independent) displacements applied to particles from their initial lattice sites:

$$p(u) = \begin{cases} \frac{1}{\Delta} & \text{if } u \in [-\Delta/2, +\Delta/2], \\ 0 & \text{otherwise.} \end{cases}$$

We set the initial velocities to zero. There are in this case thus two parameters in the model: the lattice spacing ℓ and the amplitude Δ of the “shuffling”. As we are treating the infinite system limit, and the gravitational force provides itself no characteristic length scale, there is in fact only *one relevant parameter* characterizing this class of initial conditions, which can be taken to be the dimensionless ratio $\frac{\Delta}{\ell}$ (just as in the analogous initial conditions in $3 - d$, see [28]).

Numerically we have simply evolved the particle positions as given by Eqs. (55) and (56) between crossings. The subsequent crossing is determined at each time, and the positions and velocities of the crossing particles are updated accordingly. For numerical efficiency we have implemented the optimized algorithm, using a heap, described in detail in [34].

B. Evolution of clustering: visual inspection

Shown in Fig. 4 are snapshots of the initial conditions and evolved configurations at $t = 2, 5, 8, 10\tau_{dyn}$, for a system with 5000 particles. The plots in the left hand panels show the number of particles $N(i)$ in each lattice cell at each time, which is proportional to the mass density in each cell. Defining the number density contrast as

$$\delta(x) = \frac{n(x) - n_0}{n_0}, \quad (74)$$

where $n(x) = \sum_{i=1}^N \delta_D(x - x_i)$ is the microscopic number density, the plots represent the evolution of $\bar{\delta}(x) + 1$, where the bar indicates an average over the unit lattice cell. In the phase space plots, in the right hand panels, each point represents simply one particle.

One sees clearly that the evolution appears to proceed in a “bottom-up” manner by the hierarchical formation of clusters which increase in size in time, starting from the smallest scale (of order the lattice spacing). The sense in which the system is representative of the evolution of an infinite system is manifest in the fact that the system does not appear to have a preferred centre — clusters form in apparently random locations without sensitivity to the boundaries. Indeed we do not follow the evolution for longer times than those shown precisely because the finite size of the system then becomes important. We note that the dynamical features displayed in this regime are similar to those seen in the first studies of the $1-d$ expanding model of [7].

C. Evolution of the Power Spectrum

In cosmology the primary diagnostic used to characterize the evolution of clustering in infinite space is the *power spectrum* (PS) (or *structure factor*) of the particle system. Since we consider distributions which are periodic in an interval of size L , we can write the density contrast as a Fourier series

$$\delta(x) = \frac{1}{L} \sum_k \exp(ikx) \hat{\delta}(k), \quad (75)$$

with $k \in \{(2\pi/L)n, n \in \mathbb{Z}\}$. The coefficients $\hat{\delta}(k)$ are given by

$$\hat{\delta}(k) = \int_L dx \delta(x) \exp(ikx). \quad (76)$$

The PS is then defined as (see e.g. [22])

$$P(k) = \frac{1}{L} \langle |\hat{\delta}(k)|^2 \rangle, \quad (77)$$

where $\langle \dots \rangle$ represents the average over an ensemble of realizations of the system.

The evolution of the PS estimated using an average over 500 realisations of our system (with 5000 particles) is shown in Fig. 5.

The evolution is qualitatively like that observed in $3-d$ simulations (both static and expanding), and the $1-d$ expanding simulations of [11]. At small wavenumbers the evolution of the PS shows a simple temporal amplification. This is the behaviour expected from a linearized treatment (see, e.g., [21]) of the equations for a self-gravitating fluid, which gives independent evolution of each mode of the density field governed precisely by Eq.(64) in the expanding case, and Eq. (54) for the static case¹².

For the latter case, and vanishing initial velocities, this gives

$$P(k, t) = P(k, 0) \cosh^2(t/\tau_{dyn}). \quad (78)$$

We will see below that this is indeed a very good description of the small k evolution. Note that the initial PS at small k is a simple power law $P(k) \propto k^2$, which is that of the initial shuffled lattice. The exact form of this PS can in fact be derived analytically (see [28] for the exact expression, and [22, 35] for a derivation), and for the case we are considering takes the form of a simple interpolation between this small k behaviour and the asymptotic behaviour $P(k) = 1/n_0$ (characteristic of any point distribution).

The regime in which linear amplification is valid decreases with time, i.e., linear amplification is observed in a range $k < k_{NL}(t)$, where $k_{NL}(t)$ is a wave-number which decreases as a function of time. This is precisely the qualitative behavior one would anticipate as linear theory is expected to hold only above a scale which, in real space, because of clustering, increases with time. At all times, the PS converges at large wave-numbers ($k > k_N$, where k_N is the Nyquist frequency) to the asymptotic value $1/n_0$. This is simply a reflection of the necessary presence of shot noise fluctuations at small scales due to the particle nature of the distribution. In the intermediate range of k , i.e. $k_{NL}(t) < k \leq k_N$, the evolution is quite different than that given by linear theory. This is the regime of non-linear clustering in which the density fluctuations are large in amplitude.

One of the important properties of cosmological simulations is that, starting from initial conditions with PS which are simple power law (for k smaller than the Nyquist frequency), the evolution of clustering is, at sufficiently long times and large scales, “self-similar” (see [28] for a discussion and references). By this it is meant that the evolution of clustering, above a given spatial scale,

¹² Note that, for the $1-d$ model the derivation of this result for the density contrast follows trivially from the continuity equation.

The latter gives $\delta(x) = -du(x)/dx$ in the limit of small density fluctuations $\delta(x)$, so that amplification as a function of time of $\delta(x)$ in this limit is simply that of the displacements $u(x)$.

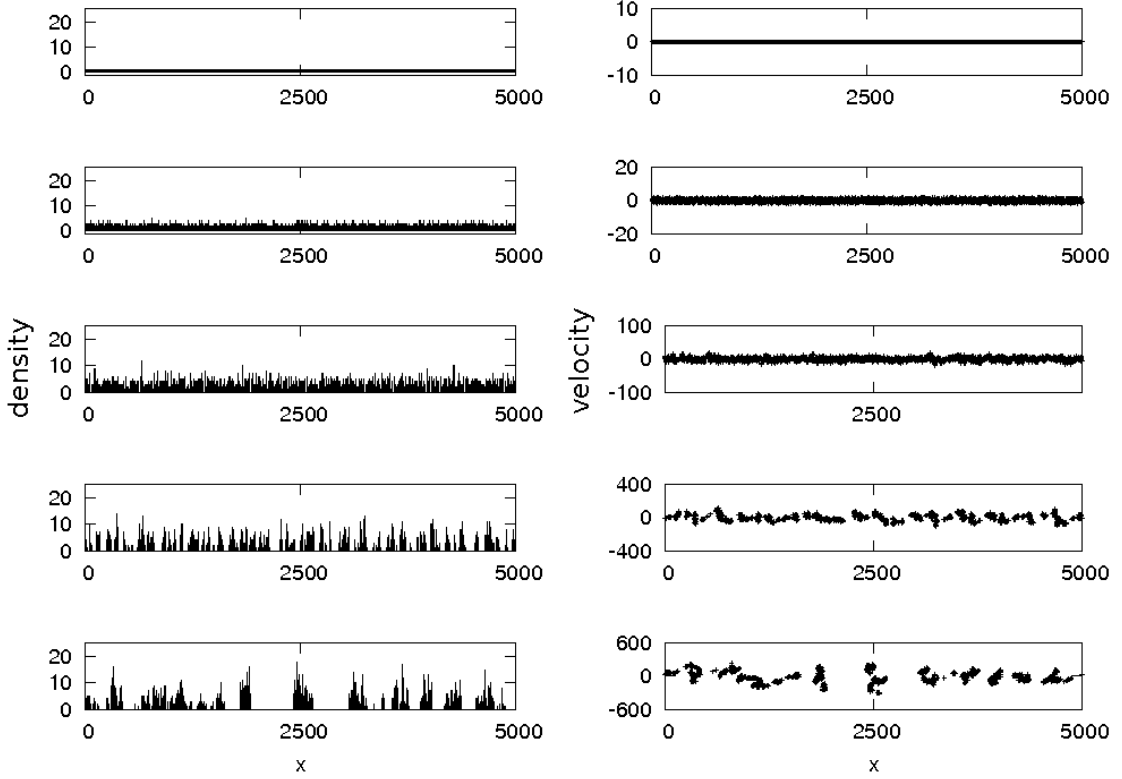

FIG. 4: Left panels: the number of points in each lattice cell in the initial conditions (first panel) and at times $t = 2, 5, 8, 10\tau_{dyn}$; Right panels: distribution of particles in single particle phase space at the same times.

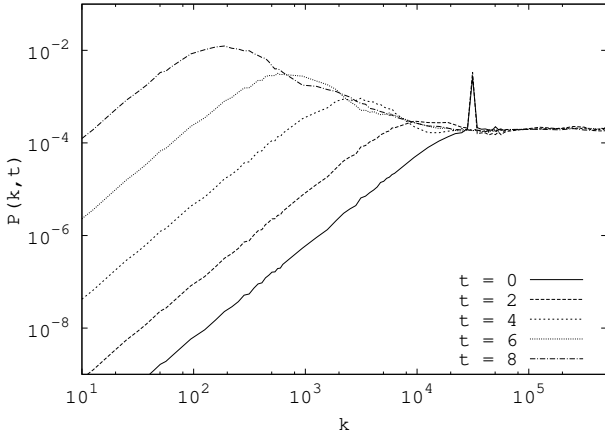

FIG. 5: Evolution of the PS, averaged over 500 realizations of a system with 5000 particles. We have set $L = 1$.

is equivalent to an appropriate time-dependent rescaling of the length scales. For the PS this relation is written conveniently (in $1 - d$) as

$$kP(k, t) = kR_s(t) \times P(kR_s, t_s), \quad (79)$$

where $R_s(t)$ is the time dependent rescaling of length¹³, normalized by at some arbitrary time t_s . Physically this behaviour (observed in $3 - d$ for a range of initial PS) is interpreted as due to the fact that the non-linear clustering at a given scale at a sufficiently long time is sensitive only to the initial perturbations at larger scales and their evolution (and insensitive, notably, to the initial interparticle distance, which provides another potential characteristic length scale in the initial conditions). Indeed this latter evolution (i.e. the regime of linear amplification) is, for a power-law initial PS, itself “self-similar” in the sense of Eq. (79), and the observation of self-similarity is simply that this relation extends into the non-linear regime. The small k behaviour of the PS (proportional to k^2) taken together with the fact that it is amplified at small k as given by linear theory then imply that the self-similar scaling will be characterised by the function

$$R_s(t) = \left(\frac{\cosh(t/\tau_{dyn})}{\cosh(t_s/\tau_{dyn})} \right)^{2/3} \rightarrow \exp\left(\frac{2}{3} \frac{t - t_s}{\tau_{dyn}}\right). \quad (80)$$

It is the latter exponential form, for asymptotically large

¹³ Note that this kind of scaling behavior of the PS is found also in other statistical physics problems characterized by dynamical structure formation as for instance *coarsening* and *spinodal decomposition* in first order phase transitions [36].

times, which is the relevant one for the self-similar behaviour, as in this limit the reference time t_s is arbitrary.

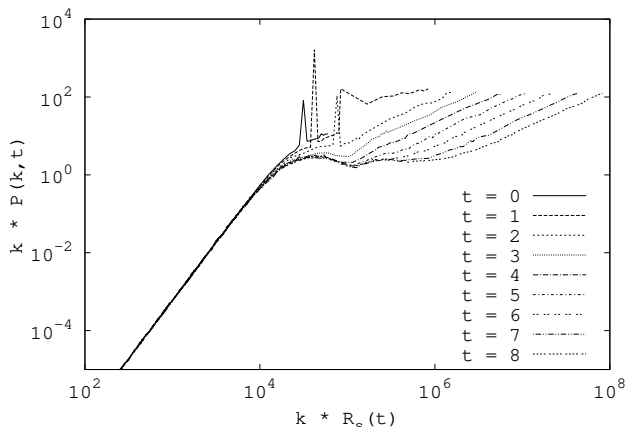

FIG. 6: Evolution of $k \times P(k, t)$ as a function of $k \times R_s(t)$ where $R_s(t)$ is as given in Eq. (80). Exact self-similar evolution would correspond to the superposition of the curves.

To assess the validity of this approximation in our system, we show in Fig. 6 the temporal evolution of $k \times P(k)$ as a function of the dimensionless parameter $k \times R_s(t)$, and taking $t_s = 0$. At small k , we see that right from the initial time the self-similarity is indeed followed (as the rescaled curves are always superimposed at these scales). This is simply a check on the result validity of linear theory in this regime, as anticipated above. As time progresses we see the range of k in which the curves are superimposed increases, extending further with time into the non-linear regime. This is precisely what is observed in the analogous $3-d$ simulations: as non-linearity develops it is characterized by this self-similarity. Note that the behavior at asymptotically large k is constrained to be proportional to k/n_0 at all times, corresponding to the shot noise present in all particle distributions with average density n_0 and which, by definition, does not evolve in time (and therefore cannot manifest self-similarity).

D. Evolution of the Mass Variance

It is instructive also to characterise the evolution through simple real space statistics. In order to distinguish the “non-linear” regime of large fluctuations from the “linear” regime of small fluctuations (in which the linear fluid theory is expected to be valid), it is useful to consider the normalized variance of particle number (or mass) in intervals, defined as

$$\sigma^2(x) = \frac{\langle N^2(x) \rangle - \langle N(x) \rangle^2}{\langle N(x) \rangle^2}, \quad (81)$$

where $N(x)$ is the number of particles in an interval of length $2x$.

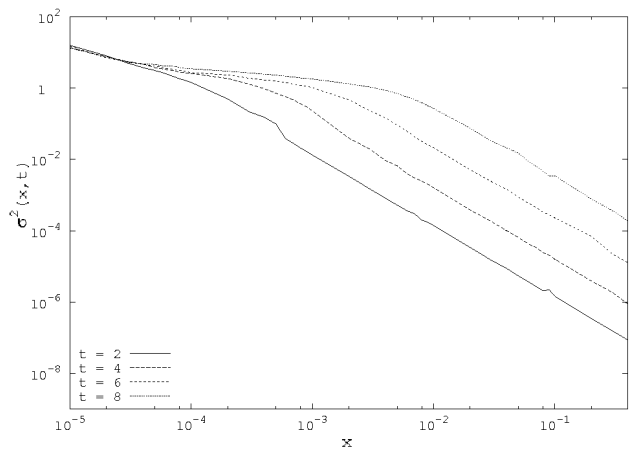

FIG. 7: Normalized mass variance in intervals of width $2x$ for the different times indicated. As in the previous figures the results are for an average over 500 realizations of a system with 5000 particles.

We show in Fig. 7 the temporal evolution of $\sigma^2(x)$ estimated using an ensemble average over 500 realizations of our system (and using periodic boundary conditions in the estimation, as in the simulations). As in the case of the PS above there are three regimes. At large scales we see a simple amplification of the initial functional behaviour, which in this case corresponds to $\sigma^2(x) \propto x^{-2}$. Note that this behaviour simply corresponds to unnormalized mass fluctuations independent of scale, which is the most rapid decay (proportional to the surface) possible in any spatially homogeneous point distribution. At small scales, on the other hand, we observe $\sigma^2(x) \propto x^{-1}$ which is the shot noise behaviour intrinsic to any such distribution at small scales. The range of scales between these two limiting behaviours is that of the non-linear clustering resolved non-trivially at this particle density. We see that the cross-over to this regime from the linear regime occurs approximately where the amplitude of the fluctuations is or order unity.

This behaviour of the variance illustrates very clearly the “hierarchical” nature of the clustering, which is generic in the evolution of $3-d$ simulations starting from a very broad class of initial conditions: the initial small fluctuations at a given scale are amplified (according to linear theory) until the fluctuations in overdense regions collapse forming structures. Theoretically such behaviour is expected [21] for any initial fluctuations with PS with behaviours $P(k) \sim k^n$ where $n < 4$, while for $n > 4$ it is expected that the effects of clustering at small scales will dominate over that of the linear evolution of the very uniform distribution at larger scales.

It is instructive to probe also in real space the self-similar behaviour described using the PS. To do so consider, following [28], the temporal evolution of scale $\lambda(\alpha, t)$ defined by the relation

$$\sigma^2[\lambda(\alpha, t)] = \alpha, \quad (82)$$

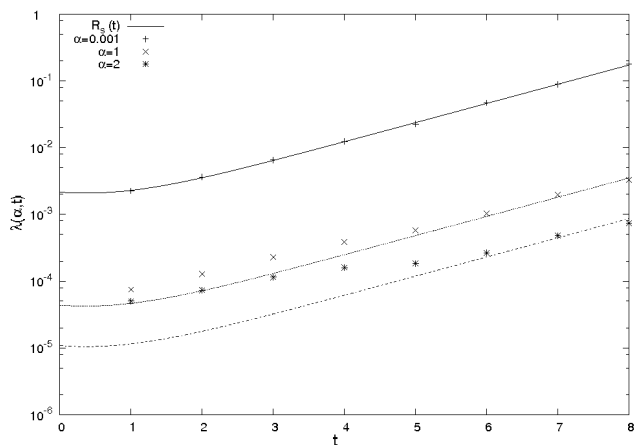

FIG. 8: Evolution, as a function of time, of the scale at which the normalized mass variance has the indicated amplitude. The lines correspond to the exactly self-similar behaviour (see text).

where α is a chosen constant. Self-similarity, at a given amplitude of the variance, then corresponds to $\lambda(\alpha, t) \propto R_s(t)$. In Fig. 8 we show $\lambda(\alpha, t)$ for the indicated values of α , as well as the curves proportional to $R_s(t)$ corresponding to the self-similar behaviour. Such a graph illustrates even more clearly than the evolution of the PS how self-similarity propagates progressively to the regime of larger amplitudes as time goes on, describing in this way the clustering further into the non-linear regime.

While these behaviours are all qualitatively similar to those in the $3-d$ case, there are also notable differences. For example the maximal amplitude reached by the variance in the range of times explored is much smaller than that in $3-d$ — of order only a few compared to a hundred or more in the latter case[28]. This is probably indicative of a much weaker non-linear clustering in the former case, associated with the smoother behaviour of the $1-d$ force at small scales. This difference is also reflected in the behaviour of the PS, which flattens much more rapidly to its asymptotic Poisson value in the $1-d$ case — at around the Nyquist frequency rather than at considerably larger wavenumbers in the $3-d$ case.

VI. SUMMARY AND DISCUSSION

We have revisited in this article a basic question concerning the definition of the gravitational force in $1-d$ infinite point distributions. Previous definitions of this quantity in the literature have required the assumption of the existence of a special point (centre) in the distribution, i.e., explicit global breaking of statistical translational invariance which is typically a feature of the infinite distributions one instead wishes to study. We have noted that the problem, associated with the non-converging surface fluctuations in such distributions,

may be solved by employing a definition using a smooth screening which is sent to zero at the end of the calculation. We have then shown explicitly that this leads to a well defined force for a specific class of infinite perturbed lattices — those subject to perturbations of finite variance which do not make particles cross. In this case, when the mean displacement of particles is also assumed to vanish, the force on each particle take a unique value which is simply proportional to its own displacement from its lattice site. We note that we have assumed also that variance of the displacement fields is finite, which restricts to initial density fluctuations which have a sufficiently rapidly decaying power spectrum at small wavenumber (specifically, such that $P(k \rightarrow) \sim k^n$ where $n > 1$, analogous to the same condition with $n > -1$ in $3-d$).

We have then discussed different dynamical toy models which incorporate this definition of the force — the simple conservative Newtonian dynamics and then one which incorporates a damping term mimicking the effect of $3-d$ expansion. Since the crossing of particles is equivalent, up to labels, to elastic collisions with exchange of velocities, the configurations generated by such dynamics, at any finite time, are always in the class of infinite perturbed lattices for which the force is defined (provided such a configuration is the initial condition). This is the case because, at any finite time, collisions/crossings may only correlate particles up to a finite distance, and the correlation properties of displacements at asymptotically large separations therefore always obey the required conditions. The equations of motion are then simply those of an infinite set of inverted harmonic oscillators (with damping in the expanding case) with centres on the original lattice sites, and which bounce elastically when they collide. In this context we have also discussed in detail the different formulations of these models in the previous literature. We have then presented some results for the development of clustering in the simplest model, for the simplest class of initial conditions. We have underlined the similarity of the results to those which have been obtained for the analogous system in $3-d$, which is itself a simplified model for the full cosmological model. The physical meaning of the prescription adopted for the force is also very clearly illustrated by these simulations: the dynamics we observe in this infinite system limit is simply that which would occur in a system with a screened gravitational force, in the regime in which the size of the structures is much less than the scale of the screening.

A few additional remarks on our prescription for the force, and the class of point distributions we have considered, are appropriate:

- While we have emphasized that our definition of the force does not require explicit breaking of translational invariance, we have in fact shown it to give a well defined answer only for a class of point processes which have discrete statistical translational invariance (by lattice vectors) rather than full statistical translational symmetry. We will consider in

forthcoming work the more general question of the general conditions on point processes for the force to be defined. In this respect we note that it has, in fact, been shown in [37] that *any* point process in $1 - d$ with a variance of mass in an interval which is bounded necessarily breaks continuous statistical translational invariance. While we have not shown here that the definedness of the $1 - d$ force requires, in general, such boundedness of the variance, it is straightforward to show that this boundedness indeed characterizes the class of perturbed lattices for which we have found the force to be defined.

- We note that the results of [37] in fact generalize an earlier result (see [38] and references therein), that the thermodynamic equilibria of the $1 - d$ one component plasma (OCP, or “jellium” model) break translational invariance. This model is in fact just the same system we are considering here up to the sign of the force, with the difference that the presence of a physical neutralizing negative background is specified. We therefore do not have, a priori, the freedom to use the regularization of the problem in the infinite system limit which we have exploited here. We note, however, that if we were to do so, i.e., define the model in the thermodynamic limit as the zero screening limit of a screened Coulomb interaction in $1 - d$, we obtain, for the class of perturbed lattices we have determined, a quite trivial model in which all particles are simple harmonic oscillators about their lattice sites, which bounce elastically when they collide. It would be interesting to investigate further whether such a formulation of the OCP is in fact equivalent to the usual one.
- Even if the force itself is not defined, with our prescription, for a given point process in the infinite volume limit, it may still be possible to construct toy models of clustering in an infinite space, with only the weaker condition that *differences* in forces at a finite separation be defined. This is related also to the restriction on the variance of the displacements we imposed, which we have noted corresponds to a restriction on the small wavenumber behaviour of the power spectra for which the force is defined. If one considers differences in the forces rather than forces, it is simple to show that any power spectrum of density fluctuations which is integrable at small wavenumber can be treated. We will discuss this issue, and the more general conditions for definition of the force, in forthcoming work.
- In cosmological simulations initial conditions are prepared by applying stochastic perturbations to a perfect lattice (see e.g. [39, 40]). These per-

turbations usually have a correlated Gaussian joint PDF, which means that in the $1 - d$ analogy the no-crossing condition we have required cannot be satisfied. In practice, however, the initial amplitudes are always chosen sufficiently small so that no such crossing occurs in the finite simulation box, and indeed the approximation in which the algorithm for the initial conditions is valid corresponds to this limit. To establish rigorously that our results can be extended to incorporate this case would require a generalisation of the calculation we have given which incorporates the contribution to the force PDF from crossings. This will lead to a non-zero variance in the PDF, but one would expect that its effect should indeed be negligible in the limit that the typical displacement (measured by the displacement variance) is small compared to the lattice spacing.

In future work we aim to exploit further this model, and the expanding variant, as toy models for the cosmological problem. Despite the previous works in the literature which have explored various versions of these models in the regime in which the analogy to $3 - d$ cosmological simulations is most direct, and found various simple behaviours in the clustering — notably the studies of [10, 11, 12, 14, 17] — they have led so far to little of the analytical insight one might hope to gain from a toy model. For example, although fractal behaviours have been documented in numerical simulations by [10, 14, 17], the relevant exponents remain unexplained. The very simple formulation of the models we have given may help in this respect.

These toy models may also be useful in understanding other aspects of numerical simulations in $3 - d$, such as the question of the importance of discreteness effects: in cosmological simulations the aim is to reproduce as closely as possible through a particle simulation the Vlasov-Poisson limit, which corresponds to an appropriate infinite particle number limit. The corrections which arise due to finite particle number are poorly understood (see [41] for a detailed discussion and references), leading to the absence of control on the associated errors in theoretical predictions. Although there are evidently important differences, the problem can be formulated and studied in the greatly simplified $1 - d$ context. This requires firstly a clear formulation of the Vlasov-Poisson limit, which so far has been given rigorously only for finite systems [42]. This then allows one to define an appropriate numerical extrapolation which should be used to study convergence. In $1 - d$ there is the interesting possibility also of performing directly simulations of the Vlasov-Poisson system for comparison.

We thank D. Fanelli, M. Kiessling, B. Marcos, B. Miller and F. Sylos Labini for useful discussions and exchanges, and B. Jancovici for providing us with references [37, 38].

-
- [1] J. Bagla, *Curr. Sci.* **88**, 1088 (2005), astro-ph/0411043.
- [2] T. Dauxois, S. Ruffo, E. Arimondo, and M. Wilkens, *Dynamics and Thermodynamics of Systems with Long Range Interactions* (Springer, Berlin, 2002).
- [3] A. Campa, A. Giansanti, G. Morigi, and F. Sylos Labini, *Dynamics and Thermodynamics of Systems with Long Range Interactions: Theory and experiments* (AIP Conference Proceedings, Volume 970, 2008).
- [4] F. Hohl and M. Feix, *Astrophys. J.* **147**, 147 (1967).
- [5] C. Reidl and B. Miller, *Astrophys. J.* **371**, 371 (1991).
- [6] G. Severne and M. Luwel, *Astrophys. Sp. Sci.* **122**, 299 (1986).
- [7] J.L. Rouet and M.R. Feix, *Phys. Rev.* **E59**, 73 (1999).
- [8] T. Tsuchiya and N. Gouda, *Phys. Rev.* **E61**, 948 (2000).
- [9] B.N. Miller, *Trans. Th. Stat. Phys.* **34**, 367 (2005), astro-ph/0412142.
- [10] J.L. Rouet, M.R. Feix, and M. Navet, *Vistas Astron.* **33**, 357 (1990).
- [11] T. Yano and N. Gouda, *Astrophys. J. Supp.* **118**, 267 (1998), astro-ph/9806026.
- [12] T. Tatekawa and K. Maeda, *Astrophys. J.* **547**, 531 (2001), astro-ph/0003124.
- [13] E. Aurell, D. Fanelli, and P. Muratore-Ginanneschi, *Physica D* **148**, 272 (2001).
- [14] B.N. Miller and J.L. Rouet, *Phys. Rev.* **E65**, 056121 (2002), astro-ph/0412142.
- [15] E. Aurell and D. Fanelli, *Self-gravitating systems in a three dimensional expanding universe* (2002).
- [16] E. Aurell and D. Fanelli, *Astron. Astrophys.* **395**, 399 (2002).
- [17] B.N. Miller and J.L. Rouet, *C. R. Phys.* **7**, 383 (2006).
- [18] P. Valageas, *Astron. Astrophys.* **450**, 450 (2006).
- [19] P. Valageas, *Phys. Rev.* **E74**, 016606 (2006).
- [20] B.N. Miller, J.L. Rouet and E. Le Guirriec, *Phys. Rev.* **E76**, 036705 (2007).
- [21] P. J. E. Peebles, *The Large-Scale Structure of the Universe* (Princeton University Press, 1980).
- [22] A. Gabrielli, F. Sylos Labini, M. Joyce, and L. Pietronero, *Statistical Physics for Cosmic Structures* (Springer, 2004).
- [23] M. K.-H. Kiessling, *Adv. Appl. Math.* **31**, 132 (2003), astro-ph/9910247.
- [24] S. Chandrasekhar, *Rev. Mod. Phys.* **15**, 1 (1943).
- [25] A. Gabrielli, *Phys. Rev.* **E72**, 066113 (2005).
- [26] A. Gabrielli, T. Baertschiger, M. Joyce, B. Marcos, and F. Sylos Labini, *Phys. Rev.* **E74**, 021110 (2006), cond-mat/0603124.
- [27] M. Baus and J.-P. Hansen, *Physics Reports* **59**, 1 (1980).
- [28] T. Baertschiger, M. Joyce, A. Gabrielli, and F. Sylos Labini, *Phys. Rev.* **E75**, 021113 (2007), cond-mat/0607396.
- [29] T. Buchert, *Mon. Not. R. Astron. Soc.* **254**, 729 (1992).
- [30] M. Joyce, B. Marcos, A. Gabrielli, T. Baertschiger, and F. Sylos Labini, *Phys. Rev. Lett.* **95**, 011304 (2005), astro-ph/0504213.
- [31] B. Marcos, T. Baertschiger, M. Joyce, A. Gabrielli, and F. Sylos Labini, *Phys. Rev* **D73**, 103507 (2006), astro-ph/0601479.
- [32] T. Baertschiger, M. Joyce, A. Gabrielli, and F. Sylos Labini, *Phys. Rev.* **E76**, 011116 (2007), cond-mat/0612594.
- [33] T. Baertschiger, M. Joyce, F. Sylos Labini, and B. Marcos, *Phys. Rev.* **E77**, 051114 (2008).
- [34] A. Noullez, E. Aurell, and D. Fanelli, *J. Comp. Phys.* **186**, 697 (2003).
- [35] A. Gabrielli, *Phys. Rev.* **E70**, 066131 (2004), cond-mat/0409594.
- [36] A. Bray, *Adv. Phys.* **43**, 357 (1994).
- [37] M. Aizenman, S. Goldstein, and J. Lebowitz, *J. Stat. Phys.* **103**, 601 (2001).
- [38] M. Aizenman and P. A. Martin, *Commun. Math. Phys.* **78**, 99 (1980).
- [39] H. M. P. Couchman, *Astrophys. J.* **368**, L32 (1991).
- [40] M. Joyce and B. Marcos, *Phys. Rev.* **D75**, 063516 (2007), astro-ph/0410451.
- [41] M. Joyce, B. Marcos, and T. Baertschiger, *Mon. Not. R. Astron. Soc.* **394**, 751 (2009).
- [42] W. Braun and K. Hepp, *Comm. Math. Phys.* **56**, 101 (1977).