



Precision VLBI astrometry: Instrumentation, algorithms and pulsar parallax determination

Adam Travis Deller

Presented in fulfillment of the requirements
of the degree of Doctor of Philosophy

January 2009

Faculty of Information and Communication Technology
Swinburne University

Abstract

This thesis describes the development of DiFX, the first general-purpose software correlator for radio interferometry, and its use with the Australian Long Baseline Array to complete the largest Very Long Baseline Interferometry (VLBI) pulsar astrometry program undertaken to date in the Southern Hemisphere. This two year astrometry program has resulted in the measurement of seven new pulsar parallaxes, which has more than trebled the number of measured VLBI pulsar parallaxes in the Southern Hemisphere. These measurements included a determination of the distance and transverse velocity of PSR J0437–4715 with better than 1% accuracy, enabling improved tests of General Relativity; the first significant measurement of parallax for the famous double pulsar system PSR J0737–3039A/B, which will allow tests of General Relativity in this system to proceed to the 0.01% level and also offers insights into its formation and high-energy emission; and a factor of four revision to the estimated distance of PSR J0630–2834, which had previously appeared to possess extremely unusual x-ray emission characteristics. Additionally, the ensemble of refined distance and transverse velocity estimates have enabled a widely applicable improvement in knowledge of pulsar luminosities in several wavebands and the Galactic electron distribution at southern latitudes. Finally, the DiFX software correlator developed to enable this science has been extensively tested and verified against three existing hardware correlators, and is now an integral part of the upgraded Long Baseline Array Major National Research Facility used by astronomers throughout Australia and the world; furthermore, it has been selected to facilitate a major upgrade of the world's only full-time VLBI instrument, the Very Long Baseline Array operated by the National Radio Astronomy Observatory in the US.

Acknowledgements

Like anyone who has navigated the hazards of completing a PhD, I have many people to thank, personally and professionally – and in many cases both – for my progress to this point. My supervisors – Prof. Steven Tingay, Prof. Matthew Bailes and Dr. John Reynolds – have guided me from astronomy newcomer to where I am now, and set me a high standard to aspire to for the remainder of my career. Special thanks go to Steven, whose door was always open as I crash–coursed my way through interferometry at the outset of my thesis. There are countless other friends and colleagues from many institutes world–wide I would like to thank for their professional input, and to mention but a few, Emil, Joris, Chris, Michael, Walter and Craig have all lent me sage advice, careful reading, a cool head in an apparent crisis and a good supply of jokes, puns and general comic relief many times over the last three and a half years.

No PhD occurs in isolation and I would like to thank the many people who have enabled me to remain a largely sane and well–adjusted individual. To my friends from university, the Swinburne R&D course, triathlon, home, abroad and everywhere – I’m lucky to know you all, and thanks for everything. Extra credit and thanks go to my flatmates past and present, all of whom I count amongst my closest friends – Gaz, Andy, Leeanne and Trish.

I would also like to thank the observatory staff at the ATCA and Parkes telescopes where I undertook the majority of my observing for this thesis – Phil, Robin, Dave, Euan and everyone; your helpfulness, professionalism and knowledge was extremely valuable to me and much appreciated.

This thesis made extensive use of the PSRCAT tool made available by the Australia Telescope National Facility at <http://www.atnf.csiro.au/research/pulsar/psrcat/>. The Long Baseline Array, without which there would be no Southern Hemisphere astrometry, is part of the Australia Telescope which is funded by the Commonwealth of Australia for operation as a National Facility managed by CSIRO. The authors of the DIFMAP and ParselTongue software packages deserve universal acclaim for their excellent and freely available data reduction tools.

Finally, and most importantly, I would like to thank those closest to me for the love and support that is bestowed regardless of the path I take in science or life. To Anneke, who has patiently listened to innumerable tirades against LaTeX, AIPS, and any number of other frustrations, and always had a gentle word of reassurance – you have given me happiness and confidence during the long days of writing. To my family – Maxine, Rod, Tim, Loren, Norm, Craig, and others – thank you for your unwavering support and encouragement in every endeavour I have chosen, not just throughout my undergraduate and postgraduate studies, but ever since I was old enough to talk and question – and talk back.

Declaration

I hereby declare that all work within this thesis, with the exceptions noted below, is solely my own work and contains no material which has been accepted to the award of any other degree or diploma.

Much of the material in Chapters 4, 5 and 6 was drawn from the publications Deller et al. (2007), Deller et al. (2008), Deller et al. (2009a), and Deller et al. (2009b). I gratefully acknowledge the useful discussions and critical analysis provided by my co-authors during the preparation of these publications. Furthermore, I would like to acknowledge that the comparison between DiFX and the Bonn MkIV correlator in Chapter 4.4.3 is based on the publication Tingay et al. (2008) and I am grateful to Professor Steven Tingay for providing the figures.

A handwritten signature in black ink, appearing to read 'A. Deller', written in a cursive style.

Adam Travis Deller

January 2009

Contents

| | |
|--|------------|
| Abstract | i |
| List of Figures | ix |
| List of Tables | xii |
| 1 INTRODUCTION | 1 |
| 1.1 Thesis motivation | 1 |
| 1.2 Thesis outline | 5 |
| 2 PULSARS | 7 |
| 2.1 Discovery and studies | 7 |
| 2.2 Current understanding | 8 |
| 2.2.1 Formation | 8 |
| 2.2.2 Composition | 10 |
| 2.2.3 Emission | 12 |
| 2.2.4 Isolated pulsar evolution | 14 |
| 2.2.5 Binary pulsars | 16 |
| 2.3 Observing pulsars in the radio waveband | 17 |
| 2.3.1 Pulsar timing | 19 |
| 2.3.2 VLBI pulsar observations | 25 |
| 3 RADIO INTERFEROMETRY | 27 |
| 3.1 Conceptual overview | 27 |
| 3.2 Historical development | 27 |
| 3.3 VLBI | 29 |
| 3.4 Instrumentation and hardware | 30 |
| 3.5 Mathematical description | 32 |
| 3.6 Calibration and editing | 37 |
| 3.7 Imaging | 38 |
| 3.8 Astrometry and geodesy | 41 |
| 4 DIFX: AN FX STYLE SOFTWARE CORRELATOR | 43 |
| 4.1 Mathematical description of a correlator | 43 |
| 4.1.1 Quasi-monochromatic formalism | 43 |
| 4.1.2 Baseband conversion and sampling | 45 |

| | | |
|----------|---|-----------|
| 4.1.3 | Geometric compensation and channelisation | 46 |
| 4.1.4 | Cross-multiplication and accumulation | 48 |
| 4.2 | Correlator implementations | 49 |
| 4.2.1 | FX vs XF correlators | 49 |
| 4.2.2 | Hardware platforms | 50 |
| 4.3 | DiFX | 52 |
| 4.3.1 | The DiFX code | 52 |
| 4.3.2 | Antenna-based operations | 53 |
| 4.3.3 | Baseline-based operations | 56 |
| 4.3.4 | Special processing operations: pulsar binning | 58 |
| 4.3.5 | Operating DiFX | 60 |
| 4.4 | Deployment and verification | 60 |
| 4.4.1 | Comparison to the LBA S2 correlator | 61 |
| 4.4.2 | Comparison to the VLBA correlator | 65 |
| 4.4.3 | Comparison to the MPIfR geodetic correlator | 69 |
| 4.5 | Performance benchmarking | 70 |
| 4.5.1 | Networking considerations | 73 |
| 4.5.2 | CPU-limited performance | 74 |
| 4.6 | Additional applications | 75 |
| 4.6.1 | LBA eVLBI | 75 |
| 4.6.2 | VLBA sensitivity upgrade | 76 |
| 4.6.3 | High Sensitivity Array observations of pulsar scintillation | 76 |
| 4.6.4 | EVN pulsar astrometry | 77 |
| 4.6.5 | Widefield VLBI | 77 |
| 4.6.6 | Australian/New Zealand geodesy | 78 |
| 4.6.7 | Worldwide geodesy | 79 |
| 5 | OBSERVATIONS, DATA REDUCTION AND ANALYSIS | 81 |
| 5.1 | Goals and target selection | 81 |
| 5.2 | Observations | 82 |
| 5.3 | Data reduction | 84 |
| 5.3.1 | Amplitude and weight calibration and flagging | 84 |
| 5.3.2 | Geometric model and ionospheric corrections | 85 |
| 5.3.3 | Fringe-fitting and amplitude calibration refinement | 86 |
| 5.3.4 | Pulsar scintillation correction | 89 |
| 5.4 | Positional determination and parallax fitting | 91 |

| | | |
|----------|--|------------|
| 5.5 | Technique check: PSR J1559–4438 | 94 |
| 5.5.1 | Initial results | 94 |
| 5.5.2 | Ionospheric correction | 95 |
| 5.5.3 | Data weights | 100 |
| 5.5.4 | Final results | 102 |
| 5.6 | Optimal data weighting | 102 |
| 5.7 | Contributions to systematic error | 105 |
| 6 | ASTROMETRIC RESULTS AND INTERPRETATION | 107 |
| 6.1 | Binary millisecond pulsars | 107 |
| 6.1.1 | PSR J0437–4715 | 109 |
| 6.1.2 | PSR J0737–3039A/B | 114 |
| 6.1.3 | PSR J2145–0750 | 125 |
| 6.2 | Isolated pulsars | 126 |
| 6.2.1 | PSR J0108–1431 | 127 |
| 6.2.2 | PSR J0630–2834 | 131 |
| 6.2.3 | PSR J1559–4438 | 133 |
| 6.2.4 | PSR J2048–1616 | 136 |
| 6.2.5 | PSR J2144–3933 | 139 |
| 6.3 | Analysis of distance and velocity models | 144 |
| 6.3.1 | Analysis of newly–measured pulsars | 147 |
| 6.3.2 | Impact of DM distance errors | 150 |
| 6.4 | Systematic errors and astrometric accuracy | 153 |
| 6.4.1 | The future of pulsar astrometry | 157 |
| 7 | CONCLUSIONS | 161 |
| 7.1 | VLBI instrumentation | 161 |
| 7.2 | VLBI pulsar astrometry | 162 |
| | Bibliography | 165 |
| | Publications | 185 |

List of Figures

| | | |
|------|---|----|
| 1.1 | Antennas that regularly participate in VLBI | 4 |
| 2.1 | The interior structure of a neutron star | 11 |
| 2.2 | Representation of the pulsar magnetosphere | 13 |
| 2.3 | The distribution of known pulsars in the P - B diagram | 16 |
| 2.4 | Propagation effects on radio pulses in the ISM | 18 |
| 2.5 | Geometric delays in pulsar timing | 20 |
| 2.6 | The dispersed signal of PSR J0437-4715 | 21 |
| 3.1 | Resolution of a single dish compared to a two-element interferometer | 28 |
| 3.2 | Hardware components of an interferometer | 31 |
| 3.3 | Response of a two-element interferometer | 33 |
| 3.4 | Definition of interferometer coordinate systems | 36 |
| 4.1 | Illustration of the geometric delay in integer-sample and fractional-sample components | 47 |
| 4.2 | Overview of the software correlator architecture | 53 |
| 4.3 | Comparison of S2 and DiFX visibility amplitudes with time | 62 |
| 4.4 | Comparison of S2 and DiFX visibility phases with time | 63 |
| 4.5 | Comparison of S2 and DiFX visibility amplitude and phase with frequency | 64 |
| 4.6 | Comparison of VLBA and DiFX visibility amplitudes with time | 66 |
| 4.7 | Comparison of VLBA and DiFX visibility phases with time | 67 |
| 4.8 | Comparison of S2 and DiFX visibility amplitude and phase with frequency | 68 |
| 4.9 | Comparison of Bonn MkIV and DiFX visibility amplitudes with time | 71 |
| 4.10 | Comparison of Bonn MkIV and DiFX visibilities with frequency | 72 |
| 4.11 | Performance benchmarking of DiFX | 75 |
| 4.12 | Cross-power dynamic spectrum for the pulsar B0834-04 on the GBT-Arecibo baseline, correlated using DiFX | 78 |
| 5.1 | Typical uv coverage for 1650 MHz and 8400 MHz observations | 83 |
| 5.2 | LBA images of the VLBI phase reference sources | 87 |
| 5.3 | LBA images of the VLBI phase reference sources continued | 88 |
| 5.4 | Illustration of the effects of diffractive scintillation on pulsar observations | 90 |
| 5.5 | Position fit for PSR J1559-4438, using sensitivity-weighted visibilities | 95 |

| | | |
|------|--|-----|
| 5.6 | Position shifts caused by ionospheric correction vs. pulsar-Sun angular separation | 97 |
| 5.7 | Position fit for PSR J1559–4438 without ionospheric corrections | 98 |
| 5.8 | Position fit for PSR J1559–4438 after dropping the first epoch | 99 |
| 5.9 | Self-calibration corrections for the ATCA station on PSR J1559–4438 . . . | 101 |
| 5.10 | Position fit for PSR J1559–4438 using equally weighted visibilities | 103 |
| 6.1 | Motion of PSR J0437–4715, with measured positions overlaid on the best fit | 109 |
| 6.2 | Images of B0736–303, using different source models | 116 |
| 6.3 | Motion of PSR J0737–3039A/B, with measured positions overlaid on the best fit | 118 |
| 6.4 | Motion of PSR J2145–0750, with measured positions overlaid on the best fit | 126 |
| 6.5 | Motion of PSR J0108–1431, with measured positions overlaid on the best fit | 128 |
| 6.6 | Motion of PSR J0630–2834, with measured positions overlaid on the best fit | 132 |
| 6.7 | Motion of PSR J1559–4438, with measured positions overlaid on the best fit | 134 |
| 6.8 | Motion of PSR J2048–1616, with measured positions overlaid on the best fit | 137 |
| 6.9 | Motion of PSR J2144–3933, with measured positions overlaid on the best fit | 140 |
| 6.10 | Correlation between 1400 MHz radio luminosity and spin-down luminosity | 142 |
| 6.11 | Pulsar parallax distance versus TC93 distance | 145 |
| 6.12 | Pulsar parallax distance versus NE2001 distance | 146 |
| 6.13 | Histogram of TC93 errors for pulsars with measured parallaxes | 147 |
| 6.14 | Histogram of NE2001 errors for pulsars with measured parallaxes | 148 |
| 6.15 | Histogram of NE2001 errors, with models of error distribution | 151 |
| 6.16 | Synthetic 2D velocity distribution | 152 |
| 6.17 | VLBI parallax error plotted against pulsar flux density | 154 |
| 6.18 | VLBI parallax error plotted against calibrator throw in degrees | 156 |

List of Tables

| | | |
|-----|---|-----|
| 1.1 | Comparison of major VLBI arrays | 2 |
| 4.1 | Maximum decorrelation incurred due to “Post-F” fringe rotation | 48 |
| 4.2 | Linear fit parameters for visibility amplitude vs time for DiFX and the LBA S2 correlator, with 95% confidence limits | 63 |
| 4.3 | Linear fit parameters for visibility amplitude (in units of correlation coef- ficient) vs time for DiFX and the VLBA correlator, with 95% confidence limits | 67 |
| 5.1 | Target pulsars | 82 |
| 5.2 | Observation summary | 84 |
| 5.3 | Observed pulsar scintillation parameters and estimated scattering disk sizes | 91 |
| 5.4 | Initial results (sensitivity-weighted visibilities) for PSR J1559–4438 | 96 |
| 5.5 | Average position shift due to ionospheric corrections for PSR J1559–4438 | 97 |
| 5.6 | Final results (equally weighted visibilities) for PSR J1559–4438 | 103 |
| 5.7 | Noise-added fits for PSR J1559–4438, sensitivity-weighted visibilities | 104 |
| 5.8 | Noise-added fits for PSR J1559–4438, equally weighted visibilities | 104 |
| 6.1 | Astrometric fits for all target pulsars | 108 |
| 6.2 | Fitted VLBI results for PSR J0437–4715 and comparative timing values (positions re-referenced to the VLBI proper motion epoch) | 111 |
| 6.3 | Comparison of distance and velocity to non VLBI-derived estimates | 149 |

1

INTRODUCTION

1.1 Thesis motivation

Radio astronomy, in particular radio interferometry and its high resolution sub-branch Very Long Baseline Interferometry (VLBI, discussed in detail in Chapter 3), is a field in which advances in instrumentation – driven in this case by developments in consumer and industrial electronics – have enabled rapid, ongoing advances in science, by expanding the parameter space scientists can explore. This has led to a dependency between engineer and scientist which is rarely seen in other fields of astronomy – most radio astronomers have at least a passing knowledge of the systems they use, and many are themselves developers as well as users of instruments. This is especially true for part-time VLBI arrays such as the Australian Long Baseline Array (LBA).

Another field of study with a strong overlap between engineer and astronomer is pulsar astronomy. Radio pulsars (discussed in detail in Chapter 2) are rapidly rotating neutron stars that emit radiation from their magnetic poles. Neutron stars form from the collapsed cores of once-massive stars following a supernova explosion. Due to the pulsar’s very high moment of inertia, the pulsar spin period P is typically very stable. The misalignment of the rotation and magnetic axes leads to the radiation being observed as a series of pulses (dispersed in frequency by intervening ionised matter) at Earth. Analysis of pulsar data typically requires dedicated, high speed signal processing, which has led to most pulsar groups developing and deploying their own digital electronic systems on a telescope by telescope basis.

VLBI is an integral tool for the study of pulsars, allowing the determination of kinematic parameters of individual pulsars in a (relatively) precise and model-independent fashion. This use of high-resolution observations to accurately measure object positions is known as astrometry. As discussed in Section 2.3.2, the addition of independent kinematic

Table 1.1. Comparison of major VLBI arrays

| Array name | Array stations | Maximum station data rate (Mbps) | Maximum baseline length (km) | Active observing (weeks/year) |
|-------------------------------------|----------------|----------------------------------|------------------------------|-------------------------------|
| VLBA ¹ | 10 | 512 | 8600 | 52 |
| EVN ² | 18 | 1024 | 10000 | 10–15 |
| LBA (S2 – pre-2005) ³ | 6 | 128 | 1700 | 3–4 |
| LBA (DiFX – post-2005) ³ | 6 | 1024 | 1700 | 3–4 |

¹<http://www.vlba.nrao.edu/>²<http://www.evlbi.org/intro/intro.html>³<http://www.atnf.csiro.au/vlbi/>

information allows the calculation of geometrical effects which alter the observed arrival time of pulses. If the signature of the annual orbital parallax on pulsar position imposed by the Earth’s motion around the Sun can be detected, the resultant determination of pulsar distance can be used to accurately calibrate the pulsar luminosity at all wavebands, as well as further refining the pulse arrival time corrections.

While Southern Hemisphere instrumentation has played a crucial role in the study of pulsars – the Parkes and Molonglo radiotelescopes in Australia have discovered over half of the known radio pulsar population – few pulsar VLBI observations have been made from the Southern Hemisphere. Three previous Southern Hemisphere surveys (Dodson et al., 2003; Legge, 2002; Bailes et al., 1990) have resulted in the measurement of two pulsar parallaxes, whereas 16 Northern Hemisphere parallaxes were published at the time of writing, with nine obtained in a single program (Briskin et al., 2002). This is primarily due to the capabilities of the American Very Long Baseline Array (VLBA) and the European VLBI Network (EVN) instruments, both of which possessed advantages in recording bandwidth, support and observation cadence compared to the LBA, which is the only Southern Hemisphere VLBI array. The LBA, VLBA and EVN antennas are shown in Figure 1.1 – full details of these arrays are shown in Table 1.1.

Despite the advantages of Northern Hemisphere arrays, there are many unique pulsars which lie too far south to be effectively observed from the Northern Hemisphere such as the unique double pulsar system PSR J0737–3039A/B, the longest period radio pulsar PSR J2144–3933, and the nearest and brightest millisecond pulsar PSR J0437–4715. These objects and others offer insights into pulsar formation, evolution and many other related fields of research, but have yet to be the subjects of detailed study at the highest angular resolution. The LBA offers the only means to undertake high angular resolution studies of these objects.

The key impediment faced by the LBA at the outset of this thesis (in early 2005), compared to the VLBA and EVN, was a lack of sensitivity. As discussed in Chapter 3, the sensitivity of an interferometer is proportional to the square root of the bandwidth of the signal it accepts, which is limited by the digital sampling, recording and processing hardware employed by the array. As shown in Table 1.1, in 2005 the LBA was significantly limited in the bandwidth it could record, compared to the VLBA and EVN. This meant that targeting the most scientifically desirable Southern Hemisphere pulsars, many of which are faint radio sources, would require impossibly large amounts of telescope time to obtain sufficient sensitivity. An upgrade of the LBA was thus the only feasible alternative to obtain astrometric information on these objects.

This upgrade involved replacing the existing tape-based recorders and signal processing hardware (the "correlator", discussed in Chapters 3 and 4) with disk-based recorders and an alternate correlator capable of handling higher data rates. At the commencement of this thesis, new disk-based recorders were being tested with a preliminary correlator based on a software algorithm running on a small supercomputer (West, 2004). Despite verifying the functionality of the disk-based system, this initial "software correlator" was too slow (taking weeks to correlate a day's observing) for production usage. A refined, more efficient software correlator was required, which was developed during this thesis and became known as DiFX (short for Distributed FX correlator – the FX terminology is explained in Chapter 4).

Thus, from the outset, this thesis aimed to address the twin goals of a developing a flexible, powerful, and efficient software correlator to make use of the higher bandwidths available with a disk-based system, and the integration of that correlator into the LBA to produce an instrument with the flexibility and sensitivity necessary to successfully undertake an astrometric program encompassing the most scientifically fruitful Southern Hemisphere pulsars. The undertaking of this astrometric program also necessitated the development of significant new algorithms and tools for astrometric data reduction, and the characterisation and improvement of many areas of LBA operations.

While the development of the DiFX software correlator was a necessary precursor to the desired astrometric science, the improved sensitivity and flexibility of the new system extended the capabilities of the LBA for all science targets. Indeed, DiFX has also been adopted by several new or upgraded arrays external to Australia, most notably the VLBA. Section 4.6 briefly discusses some science highlights external to this thesis that have been obtained using the DiFX software correlator on both the LBA and other arrays.

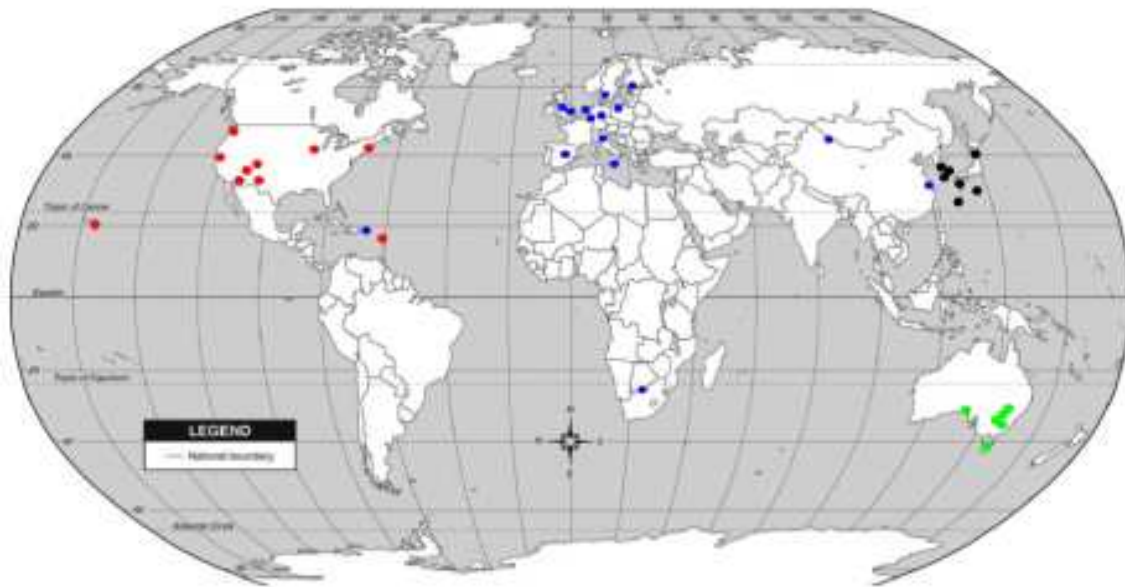

Figure 1.1 The location of antennas regularly participating in VLBA (red), EVN (blue) and LBA (green) observations. Antennas which are sometimes added to one or more arrays on an ad-hoc basis, or that belong to other arrays such as the Japanese VLBI Network (JVN) or the Korean VLBI Network (KVN) are shown in black.

1.2 Thesis outline

An overview of the historical studies and present understanding of pulsars is given in Chapter 2, along with a discussion of the pulsar science which is possible through the use of VLBI astrometry. Chapter 3 presents a conceptual and mathematical overview of radio interferometry, including VLBI, and covers the application of VLBI to astrometric observations. Chapter 4 covers the development, testing and verification of DiFX, the final version of the software correlator developed to fulfil the first primary goal of this thesis. Chapter 5 examines the post-correlation data analysis undertaken on all astrometric datasets, showing the transformation from correlated data to pulsar positions at a given epoch. Chapter 6 highlights the results obtained from the LBA astrometric program and shows the implications of the measured pulsar distances and kinematics, both for each pulsar individually and for population studies as a whole. Concluding remarks are made in Chapter 7.

2

PULSARS

2.1 Discovery and studies

When the existence of highly compressed stellar objects consisting primarily of neutrons – *neutron stars* – was postulated as a possible result of a supernova explosion by Baade and Zwicky in 1934, the field of radio astronomy was barely taking its first tentative steps. A third of a century later, however, it would be radio astronomy that provided a remarkable confirmation of the existence of neutron stars, beginning with PhD student Jocelyn Bell noticing a periodic “little bit of scruff” while observing at a Cambridge radiotelescope. This discovery was published the following year (Hewish et al., 1968) and shortly after the rotating neutron star origin of the signal was independently proposed by Gold (1968) and Pacini (1968).

These periodic radio sources became known as “pulsars”, and a flood of theoretical and observational results followed the initial discovery. Before the end of the decade, pulsars were detected in the x-ray (Fritz et al., 1969) and optical (Cocke et al., 1969) wavebands, with detection in gamma rays following shortly after (Fazio et al., 1972). By 1980 over 300 pulsars had been discovered and the neutron star origin, with the radio emission powered by the conversion of rotational energy, was well established.

Since that time, however, a series of observational surprises have shown that the neutron stars can manifest themselves in a variety of guises:

- *recycled* or *millisecond* pulsars, with lower ($\sim 10^8$ gauss) magnetic field strengths and spin frequencies in the hundreds of Hz, formed through accretion of matter in a binary system (Alpar et al., 1982; van den Heuvel, 1975);

- Anomalous X-ray Pulsars (AXPs), which emit more energy than can be explained by their spindown rate, and Soft Gamma Repeaters (SGRs), both of which are believed to be magnetars – neutron stars with extremely high ($\geq 10^{14}$ gauss) magnetic fields, where the magnetic field decay powers repeated powerful outbursts in x-rays and gamma-rays (Thompson and Duncan, 1996); and
- Nulling pulsars, intermittent pulsars and Rotating Radio Transients (RRATs), where the radio emission is intermittently suppressed (see e.g. Wang et al., 2007; Backer, 1970; McLaughlin et al., 2006). In the case of RRATs, as few as one pulse in thousands is emitted.

As the objects studied in this thesis are all rotation-powered, non-nulling radio pulsars, the remainder of this chapter will focus on these objects.

2.2 Current understanding

2.2.1 Formation

Ordinary radio pulsars are believed to form in the supernova explosions which result when massive stars exhaust their supply of the light elements which had fueled nuclear fusion. With the abrupt removal of radiation pressure which had supported the star against gravity, a rapid contraction follows. Depending on the stellar core mass, one of three compact objects is formed in the final contraction – a white dwarf, neutron star or black hole. With a core mass of less than roughly 1.4 solar masses (M_{\odot}), the stellar material becomes completely ionised during the core collapse, and the Fermi pressure of the resultant degenerate electron gas grows until, when the core is several thousand km in radius, it balances the gravitational force and a stable, cooling white dwarf remains. However, for cores exceeding the Chandrasekhar limit of roughly $1.4 M_{\odot}$, the rising degenerate electron pressure is not sufficient to halt further collapse into a denser state – a process first recognised by Chandrasekhar (1931). This violent contraction and ejection of stellar material is known as a core collapse supernova.

For core masses exceeding the Chandrasekhar limit, the collapsing material reaches densities and temperatures sufficient to fuse electrons and protons into neutrons and electron neutrinos via the process of inverse beta decay:



The escape of these neutrinos from the collapsing core cools the collapsing material, and the simultaneous loss of thermal and Fermi pressure removes any means for the stellar material to resist gravitational collapse. It should be noted that the timescale of the neutrino emission remains somewhat uncertain, due to the difficulty of simulating the extreme environment of the supernova collapse (see e.g. Fryer and Warren, 2002, and references therein). The collapsing matter largely conserves angular momentum and magnetic flux, and thus the initially modest rotation speeds and magnetic fields of the progenitor star are amplified immensely as the core compresses.

The production of a neutron star or black hole depends upon the core mass – for masses below about $3 M_{\odot}$, the Fermi pressure of the degenerate neutron fluid grows until it balances the gravitational pressure at a stellar radius of roughly 10 km. The resultant neutron star has a core density of $\geq 10^{14}$ g cm³, several times denser than an atomic nucleus. The inferred composition of neutron stars is discussed further in Section 2.2.2. For collapsing core masses above about $3 M_{\odot}$, even neutron degeneracy pressure is insufficient to stop the collapse, and the core is predicted to collapse completely to form a black hole in a *hypernova* explosion (Iwamoto et al., 1998).

Observations of pulsars have shown that the simple core collapse model described above alone cannot completely explain typical pulsar characteristics. One of the chief problems is the extremely high space velocity which many pulsars have been observed to possess. Recent estimates (Hobbs et al., 2005) put that average pulsar 3D birth velocity at 400 km s^{-1} , with the fastest known pulsar (PSR B1508+55; Chatterjee et al., 2005) possessing an astonishing transverse velocity of 1100 km s^{-1} ! These velocity values are much higher than those possessed by the massive stars which are neutron star progenitors ($\sim 20 \text{ km s}^{-1}$; see e.g. Feast and Shuttleworth, 1965), which along with the small number of pulsars in binary systems implies that some physical process imparts a large velocity on most neutron stars at birth (e.g. Dewey and Cordes, 1987; Bailes, 1989). Whilst the disruption of binary systems may account for some pulsar velocities, it appears that some kind of “kick” mechanism during the formation process is required to adequately explain the full range of observed systems. Counter-examples, such as the PSR J0737–3039A/B system discussed in Section 6.1.2, seem to imply that kicks are not universal, further complicating interpretations of the physical mechanism.

While many theories have been advanced, generally requiring an asymmetry in the collapse and/or neutrino emission during the supernova formation, or asymmetric electromagnetic radiation after the collapse (see e.g. Fryer, 2004; Lai et al., 2001), the exact nature of the kick mechanism remains unclear. It is important to note that many theories of pulsar kicks predict that the kick is aligned with the pulsar spin axis, which is tested observationally by measuring the polarisation position angle of pulsars (e.g. Johnston et al., 2005; Rankin, 2007) or the position angle of an observed pulsar wind nebula and/or jet (e.g. Gaensler et al., 2002; Helfand et al., 2001) and comparing to the velocity position angle. Thus, studies of the space velocities of pulsars allow important insights into their formation processes.

2.2.2 Composition

The composition of the end state of matter in the interior of a neutron star is still the subject of controversy. The Equation of State (EoS) of the material at the core of a neutron star, which describes the relationship between density and pressure, is a much sought-after result which could be obtained from a simultaneous measurement of a neutron star mass and radius (see eg. Lattimer and Prakash, 2007). The extreme environment means that exotic forms of matter could exist in the core, such as unconfined quarks (Prakash, 2007). The difficulty of such measurements means that to date, a wide range of EoS's remain permitted. The discussion below assumes neutron stars do not contain exotic material.

Figure 2.1 shows the generally accepted taxonomy of a “normal” neutron star. It can be broadly divided into the “crust” and “core” regions – although the phase transitions between the regions are poorly understood and intermediate layers could exist. The crust consists of atomic nuclei and free electrons, since the pressure near the neutron star surface is low enough to permit nuclei to remain intact. The atomic nuclei are locked in a solid lattice-like structure. This rigid crust “freezes” the magnetic field configuration of the neutron star in place. As the density increases further from the surface, free neutrons (which are predicted to exhibit superfluidity) are present along with nuclei and electrons (e.g. Sandulescu et al., 2004) – this is shown as the “inner crust” in Figure 2.1. At a depth of several km, the pressure becomes too great for atomic nuclei to exist and a transition to a neutron-only environment occurs.

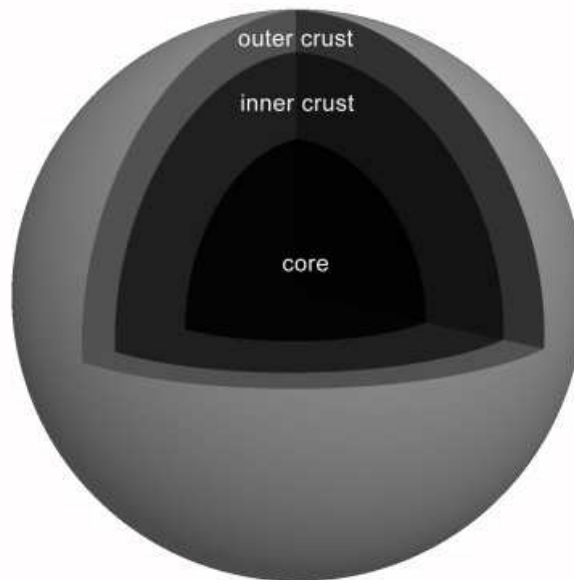

Figure 2.1 The interior structure of a neutron star. The (predominantly iron) nuclei in the crust form a solid lattice, “freezing” the magnetic field of the neutron star in place, while free neutrons in the inner crust and core are believed to exhibit superfluidity.

The neutron core of a neutron star is expected to be superfluid, although the mathematical treatment of the formation of Cooper pairs of neutrons at nuclear density is exceedingly complex. Some free protons are also expected to exist in the core, forming a superconducting dynamo which is the source of the neutron star’s magnetic field. Observational support for this model has come from pulsar glitches – events where the rotational frequency undergoes a sudden increase (spin-up), before recovering over a longer period to resume the steady spin-down caused by the loss of rotational energy. The spin-up can be explained by a transfer of angular momentum between the crust and core facilitated by vortices in the superfluid core, changing the neutron star’s moment of inertia (Larson and Link, 2002).

2.2.3 Emission

Despite decades of intense study, a complete picture of the pulsar emission mechanism has proved elusive. However, some aspects are well understood, and the generally agreed facts are presented below.

A schematic diagram of an ordinary radio pulsar is shown in Figure 2.2. The “light cylinder” reflects the distance from the pulsar at which a particle with the same angular velocity as the pulsar would be required to travel at the speed of light – thus, the region outside the light cylinder is prevented from co-rotating with the pulsar. As shown in Figure 2.1, the solid crust of the neutron star locks the magnetic field of the pulsar and forces it to co-rotate with the star.

The pulsar magnetosphere (shown in Figure 2.2) is the relativistic charged plasma which co-rotates with the pulsar, first postulated by Goldreich and Julian (1969). This co-rotation of the magnetosphere means that magnetic field lines which originate close to the magnetic axis of the pulsar are forced to remain open, since their closure would require them to cross the light cylinder, meaning the plasma locked to these field lines would be traveling faster than the speed of light. Thus, for some region around each magnetic pole the field lines cannot close – these regions are known as the “polar caps”.

The presence of charged plasma in the pulsar magnetosphere can explain both the non-thermal and thermal emission of pulsars – the non-thermal emission by synchrotron emission from electrons and positrons spiralling away from the pulsar around the open magnetic field lines, and the thermal emission from the polar cap regions, which would be heated by the impact of infalling relativistic material. The charged particles which form the pulsar magnetosphere are continually replenished through a pair-production process (Daugherty and Harding, 1982), fed by high-energy γ -ray photons, themselves produced by curvature radiation from particles accelerated along the curved magnetic field lines in a very large electric potential produced in a vacuum gap somewhere in the magnetosphere. However, the process which produces the coherent radio emission is still not understood (see e.g. Lyutikov et al., 1999, and references therein).

The precise site of the massive electric potential required to produce very high energy γ -ray photons is not yet well understood. Early models such as Ruderman and Sutherland (1975) proposed the site of the acceleration was deep in the magnetosphere, near the polar cap, while later models (e.g. Cheng et al., 1986; Chiang and Romani, 1994) proposed a location much higher in the magnetosphere, in a region known as the outer gap. The difficulty of testing these models with the available observations means that one or both could be correct, and the location of the gap could vary from pulsar to pulsar.

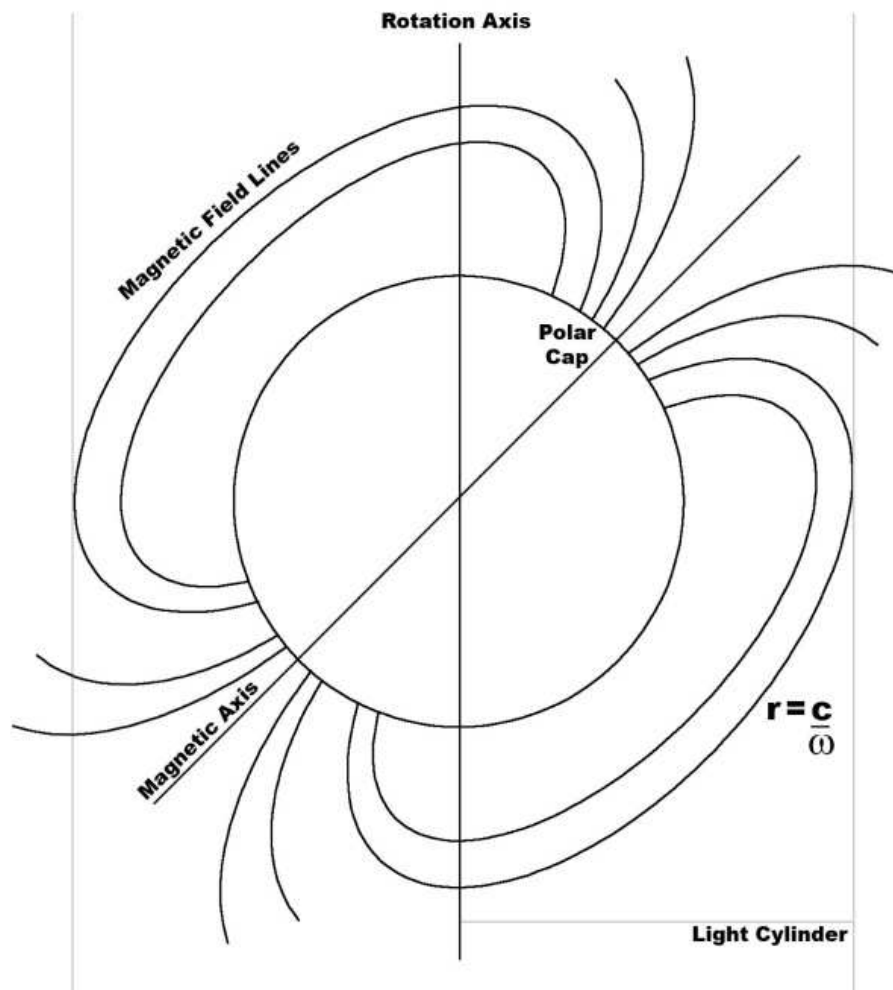

Figure 2.2 Representation of the pulsar magnetosphere. Magnetic field lines with an opening angle greater than a critical value are forced to remain open by the co-rotating charged plasma locked to closed field lines within the light cylinder (Michel, 1974). The resultant rotating magnetic dipole emits electromagnetic radiation, and pair production in the intense magnetic field provides a source of charged particles which are either accelerated away from the star – the “pulsar wind” – or back onto the polar cap (the region defined by open field lines), heating it. The heated polar cap is believed to be a source of thermal x-rays.

Another avenue for understanding the pulsar emission mechanism is higher-frequency observations. Rotation-powered pulsars have been detected in the optical (e.g. Zharikov et al., 2004), ultraviolet (e.g. Kargaltsev et al., 2004), and x-ray (e.g. Kargaltsev et al., 2006) wavebands, frequently with contradictory results. While some observations have suggested a non-thermal spectrum for higher energy radiation, presumed to originate in the pulsar magnetosphere, others have found emission consistent with a solely thermal source. Thermal emission will be generated over the entire neutron star surface, but as shown in Figure 2.2 the polar cap regions are expected to be heated relative to the remainder of the surface and may dominate the high-energy thermal emission. Models of pulsar surface temperatures are presently poorly constrained, and hence accurate luminosities for rotation-powered pulsars detected in the optical to x-ray wavebands are essential for ongoing attempts to understand the pulsar emission mechanism. The chief uncertainty in many pulsar luminosity estimates is the large uncertainty in the pulsar distance. Removing these uncertainties for specific objects through direct measurement of pulsar distances is one of the applications of this thesis.

As shown in Figure 2.2, the misalignment of the rotational and magnetic axis of the pulsar leads to the emission beam tracing a conical shape on the sky. If the beam of radiation intersects with Earth during its path, an observer on Earth can detect periodic pulsed emission.

2.2.4 Isolated pulsar evolution

For ordinary radio pulsars, the emission of electromagnetic radiation due to the rotating magnetic dipole, governed by the classical electrodynamics, is the primary mechanism for energy loss. This “magnetic braking” leads to a steady increase in the pulsar’s rotational period as rotational energy is lost. Under the assumption that other forms of energy loss are negligible, the following relation between P , \dot{P} and surface magnetic field strength B can be obtained (see e.g. Lorimer and Kramer, 2005):

$$B = \sqrt{\frac{3c^3}{8\pi^2} \frac{I}{R^6 \sin^2 \alpha} P \dot{P}} \quad (2.2)$$

where R is the neutron star radius (usually estimated as 10 km), I is its moment of inertia (usually estimated as 10^{45} g cm²) and α is the angle between the magnetic moment of the neutron star and its spin axis.

A common way of visualising the known pulsar population is to plot $\log P$ against $\log \dot{P}$, or equivalently (under the assumption of pure magnetic dipole braking) $\log P$ against

$\log B$ using equation 2.2. This is shown in Figure 2.3. This diagram shows three distinct pulsar populations – “normal” radio pulsars in the centre, with $10^{11} < B < 10^{13}$ G and $10^{-2} < P < 10^1$ s, recycled pulsars with $B < 10^{10}$ G and short rotational periods, and magnetars/AXPs with $B > 10^{14}$ G and generally long rotational periods.

While the evolution of the magnetic field strength of non-recycled, rotation-powered pulsars over their lifetimes has been the subject of considerable debate (see e.g. Goldreich and Reisenegger 1992; Bhattacharya, 2002), numerical simulations (e.g. Bhattacharya et al., 1992) support the view that the field strength does not evolve with time, and so constant field strength is generally assumed. Additionally, pulsars are often assumed to be born with initial spin periods of order 1–20 milliseconds, which is reasonable based upon conservation of angular momentum of the progenitor, and is backed up by simulations (Ott et al., 2006). However, various observational results suggest that pulsars can also be born with considerably longer spin periods (e.g. PSR J1811–1925, 65 ms, Torii et al. 1999; PSR J0538+2817, 140 ms, Kramer et al. 2003). Nevertheless, generally speaking, pulsars are born close to the left of the P – \dot{P} diagram and evolve towards the right along lines of constant B . The pulsar “characteristic age” τ_c can be estimated by assuming the initial spin period is negligible compared to the current period using:

$$\tau_c = \frac{P}{(n-1)\dot{P}} \quad (2.3)$$

where n is the braking index, which is equal to 3 for pure magnetic dipole braking in a vacuum.

The pulsar’s true age could vary considerably from its characteristic age if the initial spin period P_0 was a significant fraction of the current spin period, or if the assumption that magnetic braking is the dominant form of energy loss is incorrect. An alternative way of estimating pulsar ages is to use the “kinematic” age, which is calculated when the pulsar’s position, proper motion and birth location are known. This method can generally only be used for pulsars associated with a known supernova remnant, or for whom the uncertainty in birth location (pulsars are generally assumed to be born close to the Galactic plane, with a scale height of approximately 100–130 pc – Cordes and Chernoff 1998, Faucher-Giguère and Kaspi 2006) is unimportant, such as pulsars with a Galactic height many times the scale height, with a well-determined vertical proper motion. Comparison of kinematic and characteristic ages can lead to constraints on the birth location or initial spin periods of pulsars.

It is apparent from Figure 2.3 that a region of parameter space with low magnetic field strength and long periods is completely depopulated of pulsars. This pulsar “death

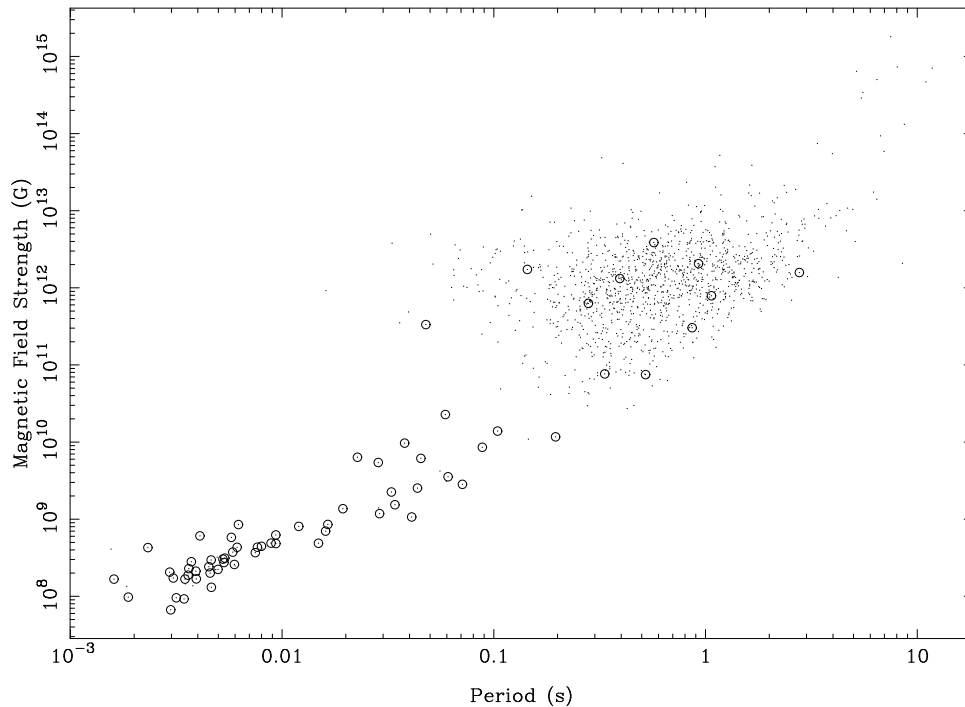

Figure 2.3 Plot of known pulsars showing the distribution of spin period P and surface magnetic field strength B (as calculated from \dot{P} using Equation 2.2). Binary systems are shown as semi-filled circles and isolated neutron stars with dots. Magnetars lie in the upper right-hand corner of the plot, and recycled pulsars in the lower left-hand corner.

zone” arises naturally from the pair-production cascade emission mechanism discussed in Section 2.2.3 – once the curvature radiation no longer produces photons with sufficient energy to initiate a pair-production cascade, the observable radio emission ceases. However, several observed pulsars (including most notably the $P = 8.5$ s PSR J2144–3933) contradict this simple picture, being observable despite being past the pulsar death line. The existence of observable long-period pulsars such as PSR J2144–3933 may be explained by invoking inverse Compton scattering as the source of the pair-production cascade, replacing curvature radiation (Zhang et al., 2000). Observations of pulsars in the death zone which allow some insight into their fundamental properties such as luminosity may help to resolve the questions as to how their radio emission is maintained.

2.2.5 Binary pulsars

Pulsars exist in a wide range of binary systems, orbiting other neutron stars (including the famous double pulsar system PSR J0737–3039A/B), white dwarfs, main-sequence and post main-sequence stars. Their presence in binary systems is a prerequisite for the

formation of recycled pulsars, where the accretion of matter from a companion star that is overflowing its Roche lobe transfers angular momentum to the pulsar, spinning it up to millisecond periods (see e.g. Bhattacharya and van den Heuvel, 1991, for a comprehensive discussion). Although rarer than lone pulsars, binary pulsars offer a number of unique science opportunities, discussed below.

The kinematics of binary systems including a pulsar offer an insight into the supernova events which form neutron stars, since the binary system must survive the supernova undisturbed¹. The orbital semi-major axes and eccentricities of known binary pulsars allows some constraints to be placed on the types of progenitor stars and supernovae that lead to these systems.

Pulsars in close binary orbits travel at relativistic speeds and offer the possibility to test the predictions of General Relativity (GR) against alternate theories of gravity in the strong-field gravity regime. Examples of post-Keplerian effects² include decay in orbital period \dot{P}_b due to gravitational wave emission, relativistic orbital precession and Shapiro delay (Shapiro, 1964). The detection of these effects is dependent on the precision timing of pulse arrival, which is discussed in Section 2.3.1.

Finally, mergers of compact objects in binary systems are expected to be one of the first sources of gravitational waves to be directly detected (e.g. Belczynski et al., 2002). The population size of relativistic binaries in our Galaxy is crucial when estimating the frequency of merger events throughout the local Universe, and thus the probability of success for the Laser Interferometer Gravitational Wave Observatory (LIGO). Estimates of population size for relativistic binaries depend on the spatial density and luminosity function of the systems, which require accurate distances. Thus, observations of existing binary systems can contribute to the expected frequency of gravitational wave events, and hence event detection rates with LIGO.

2.3 Observing pulsars in the radio waveband

As shown in Section 2.2.3, pulsars generate beams of coherent, broad-band radio emission which is observed as a pulse train at Earth, due to the pulsar's rotation sweeping the beam past Earth. Pulsars are generally observed to have steep spectra – the mean spectral index for normal radio pulsars is -1.8 (Maron et al., 2000).

In order for the pulsar signal to propagate to Earth, it must pass through the pulsar's

¹Globular cluster binaries, which have a much higher incidence of interactions, do not necessarily offer the same insight

²Those not predicted by classical mechanics

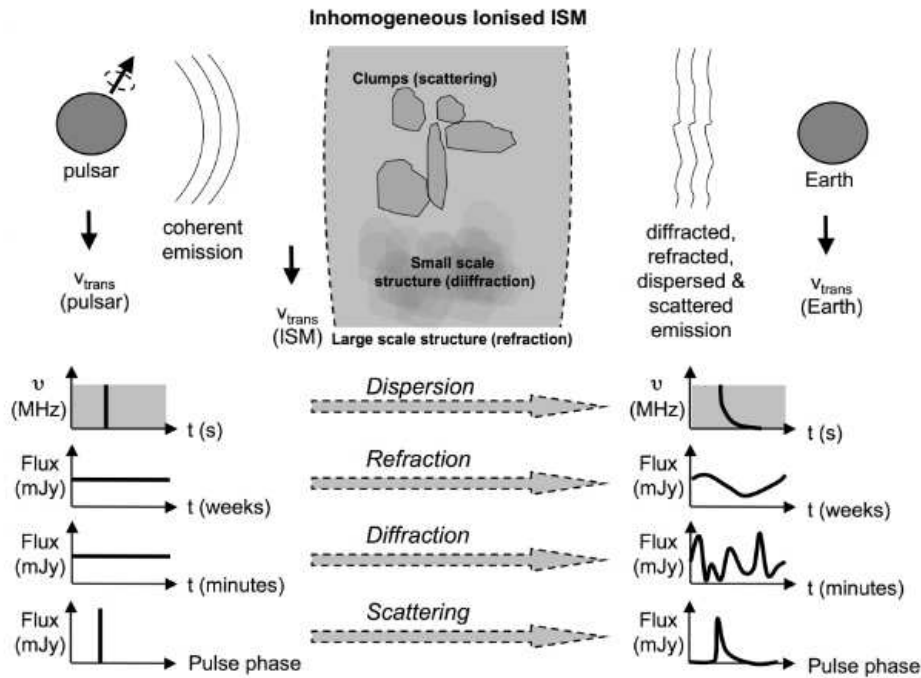

Figure 2.4 The effect on pulsar radiation of travelling through a medium of non-zero density. The broadband pulses, which are initially aligned in frequency, are dispersed by ionised material along the line of sight. Density variations cause refractive and diffractive scintillation and scattering.

local environment, the interstellar medium (ISM) and Earth's own atmosphere. Each of these environments is typically composed, at least in part, by non-uniformly distributed ionised matter which interacts with the radio waves. Essentially, the radiation traverses a path of continually varying refractive index, which causes dispersion, scintillation (both refractive and diffractive), scattering and (for polarized radiation in the presence of magnetic fields) Faraday rotation. These effects are summarised below in Figure 2.4.

Much of the unique science made possible by pulsars depends upon their intrinsic rotational stability, enabling their pulsed signals to be taken as accurate clock ticks. For this approach to be viable, the propagation effects discussed above must be overcome, along with a host of other error sources. This discipline of *pulsar timing* is discussed below.

2.3.1 Pulsar timing

Pulsar timing determines a pulse time of arrival (TOA) by cross-correlating the observed pulse profile from an observation (obtained by averaging in time and frequency) and a template. This is then compared with a timing model, and a “timing residual” obtained. A bootstrap procedure follows, with the model undergoing refinement until an optimal model is obtained. Typical timing residuals can be very small fractions of a pulse period (e.g. 0.003% for PSR J0437–4715; Verbiest et al., 2008). For most pulsars, the intrinsic average pulse profile is very stable over time (see e.g. Hotan et al., 2004), although this is not universal. Geodetic precision can cause secular changes in pulse profile over long timescales, an effect which has been seen in PSR B1913+16 (Weisberg et al., 1989) and PSR J1141–6545 (Hotan et al., 2005). On much shorter timescales, so-called “mode-changing” pulsars such as PSR B0329+54 (e.g. Liu et al., 2006; Lyne, 1971) switch between two or more modes, in which pulse components vary in relative and absolute strength. Such complications are not relevant to this thesis and are not considered further.

The averaging of recorded data in time requires an accurate model for pulse arrival times – the pulsar ephemeris. The instantaneous position of the source (pulsar) and observer (telescope on Earth) must be calculated to a high degree of precision. The pulsar reference position, proper motion, binary motion (if applicable), rotational period and period derivative must be known, as well as the Earth’s ephemeris and telescope location. This a priori model is summarised below in Figure 2.5.

Averaging the received pulsar signal in frequency requires the removal of the dispersive effects of the ISM. An example of a dispersed pulsar signal is shown in Figure 2.6. The time delay τ_d in seconds experienced by a pulse at frequency ν GHz can be expressed as:

$$\tau_d = \frac{DM}{2.41 \times 10^2 \nu^2} \quad (2.4)$$

where DM is the so-called “Dispersion Measure” associated with a pulsar. DM is defined as the integral of electron column density along the line of sight to the pulsar, quoted here in pc cm^{-3} . Observed values of DM range from $< 5 \text{ pc cm}^{-3}$ for very nearby pulsars, to $> 1000 \text{ pc cm}^{-3}$ for distant pulsars in the Galactic plane. While DM is often assumed to be constant, the relative motion of the pulsar, Earth, and ISM actually lead to continual small changes in DM due to the changing electron content along the line of sight, and for precision timing the time variation of DM must be measured and applied.

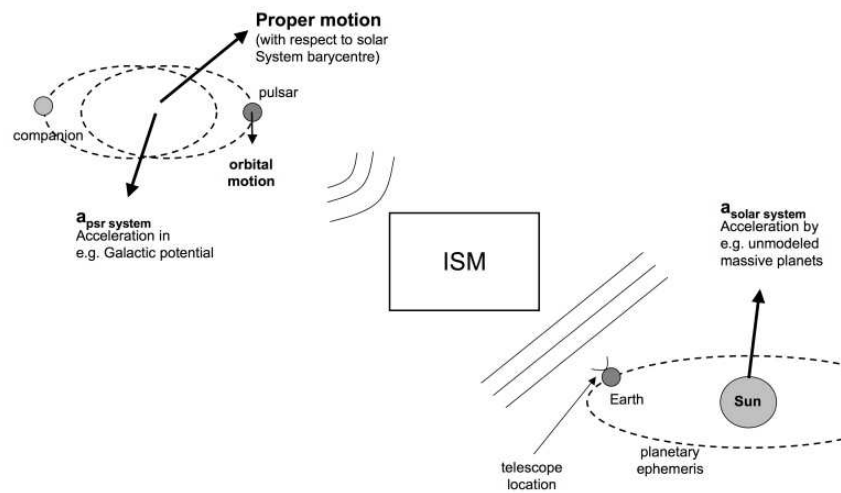

Figure 2.5 Components of the geometric model used in recording pulse arrival times. The orbital and transverse velocity and acceleration of both the pulsar and observer must be modeled, requiring an ephemeris for both the pulsar and Earth.

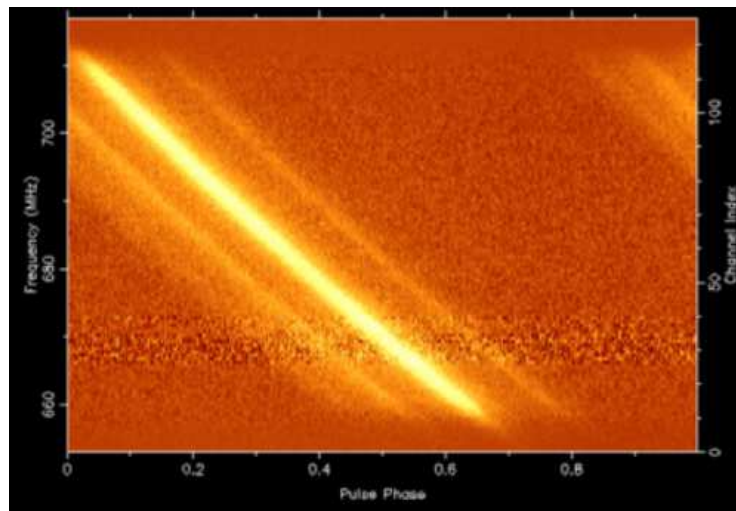

Figure 2.6 The intensity of pulsar PSR J0437–4715, shown as a function of frequency and pulse phase (time modulo the pulse period, expressed in units of fractional pulse period). The increasing delay of the signal with decreasing frequency is clearly apparent.

For pulsar timing, this frequency–dependent dispersion is simply an inconvenience to be characterised and removed, as discussed below. However, it also provides an accurate measure of the ionised content of the ISM lying between the pulsar and observer, which can be translated into an estimate of the pulsar distance, given an estimation of the density of the ionised ISM along the line of sight. Widely used models of the Galactic electron distribution, which allow calculation of the ionised ISM content along arbitrary sightlines, have been constructed by Taylor and Cordes (1993), which is hereafter referred to as the TC93 model, and Cordes and Lazio (2002), hereafter referred to as the NE2001 model. Since pulsar luminosities vary over many orders of magnitude, this provides the most useful estimate of distance which can be obtained for the entire pulsar population. However, since the density of the ionised ISM can also vary over many orders of magnitudes on small scales, feedback into the electron distribution models in the form of model–independent distances is crucial to improve the quality of distance estimates for the bulk of known pulsars. Methods of obtaining such model–independent distances through VLBI are discussed in Section 2.3.2 below, and demonstrated in Chapter 6.

Removal of the frequency–dependent delay from the observed pulsar signal, to allow the summation of data in frequency to improve the signal to noise ratio (SNR), can be accomplished in one of two ways. *Incoherent dedispersion* (Voûte et al., 2002; Large et al., 1969) makes use of a filterbank to divide the observed radio band into narrow frequency channels, and compensates the delay on a channel by channel basis, with delays appropriate

for the mean channel frequency. Since the channels remain a finite width B_c MHz, there is some small residual smearing which can be calculated for an observing frequency of ν GHz by:

$$t_{\text{smear}} = \frac{8.3 \times B_c \times DM}{\nu^3} \mu\text{s} \quad (2.5)$$

Alternatively, *coherent dedispersion* may be employed. Essentially, this approach applies a suitable filter to the baseband data (containing the inverse of the transfer function of the ISM) before the channelisation process, minimising finite bandwidth effects (however, the fundamental limitation of the original sampling time remains). This approach was first suggested by Hankins and Rickett (1975), and is becoming increasingly prevalent in high-precision timing campaigns (eg Hotan et al., 2006; Hessels et al., 2006).

As shown in Figure 2.4, refractive scintillation is caused by large-scale structure in the ISM, which acts as a large lens focussing or defocussing the pulsar radiation. This naturally leads to amplitude fluctuations in the pulsar signal, and since it is caused by large-scale structure, acts over long time periods and large observing bandwidths. Diffractive scintillation, on the other hand, is caused by small-scale fluctuations in the ISM, with diffraction producing an interference pattern on a plane which the Earth traverses. Variations in amplitude are seen as the Earth passes through the diffraction “scintles” due to its transverse velocity, and the diffraction pattern itself moves at the relative speed of the pulsar compared to the ISM where the diffraction is occurring. Cordes et al. (1986) give a more detailed overview of the physics of scintillation.

Since the pulsar velocity is usually much larger than that of the Earth or ISM, scintillation observations of pulsars can be used to make an estimate of the magnitude of the pulsar transverse velocity. This requires an estimation of the pulsar distance and a number of simplifying assumptions about the nature of the scattering material. A comprehensive discussion of the use of scintillation studies to make velocity estimates can be found in Cordes and Rickett (1998). For the commonly assumed case of a single, dominant thin scattering screen, the scintillation speed v_{ISS} is given (e.g. Gupta et al., 1994) by:

$$v_{\text{ISS}} = A_v \frac{\sqrt{D \Delta \nu_d X}}{\nu \Delta t_d} \quad (2.6)$$

where A_v is a constant related to the structure function of the ISM (equal to $3.85 \times 10^4 \text{ km s}^{-1}$ for Kolmogorov turbulence in the thin-screen approximation; Gupta et al. 1994; Cordes and Rickett 1998), D is the distance to the pulsar in kpc, X is the ratio of the Earth-screen distance to the pulsar-screen distance, ν is the observing frequency in GHz

and $\Delta\nu_d$ and Δt are the decorrelation bandwidth in MHz and decorrelation time in seconds respectively. The decorrelation bandwidth and time are determined observationally by averaging diffraction scintles and determining the mean bandwidth and time required for the pulsar intensity to fall to $1/e$ of the peak value. The magnitude of the true pulsar velocity $|v_T|$ is related to the scintillation speed by $X \times |v_T| = V_{\text{ISS}}$ (Gupta et al., 1994; Cordes and Rickett, 1998). Comparison of predicted pulsar scintillation velocities to observed values from VLBI and pulsar timing are made in Chapter 6.

Inhomogeneities in the ISM also lead to scattering, where reflected “echoes” of the pulsed emission are seen after a time delay, as shown in Figure 2.4. Scattering scales strongly with frequency, but the exact form of the scaling depends on the distribution of material in the intervening ISM – for the commonly assumed Kolmogorov model of turbulence in the ISM, the frequency dependence of scattering is $\nu^{-4.4}$ (e.g. Lee and Jokipii, 1975).

All of these time-variable propagation effects lead to variations in the pulse arrival time estimates. The dominant effect is that of DM variations, as shown by You et al. (2007). Scattering variations are less noticeable, and variations due to refractive and diffractive scintillation have traditionally been neglected, although simulations suggest that their effects are detectable at low frequencies for well-timed pulsars (Foster and Cordes, 1990).

A final source of arrival time errors can be instrumental in nature. The propagation of signals through analog or digital filterbank and sampling system must invariably involve delays, which vary from instrument to instrument, and telescope to telescope. Changes to the signal path before the pulsar hardware can also affect instrumental delays. For long time series of pulsar observations, which generally span multiple instruments, calibration of the unknown relative instrumental delays introduces additional free parameters to the timing model.

A pulsar timing campaign requires regular observations to obtain a series of residual delays. Whilst the arrival time errors due to finite signal to noise should be zero-mean, Gaussian distributed random noise, incorrectly modeled or neglected effects manifest as clear trends in the residual errors. For example, an error in P will result in residuals which linearly diverge from 0, while an unmodeled binary companion will lead to periodic movement in residuals at the binary period of the system. Historically, analysis of pulsar timing data and the fitting of pulsar parameters has used the software package TEMPO³, although more recently a more advanced package known as TEMPO2⁴ (Hobbs et al., 2006) is now available, and incorporates support for higher precision experiments than TEMPO,

³<http://www.atnf.csiro.au/research/pulsar/tempo/>

⁴<http://www.atnf.csiro.au/research/pulsar/psrtime/tempo2/>

as well as simultaneous timing of multiple pulsars.

A large proportion of the exciting science possible using pulsar timing involves binary pulsars. For example, exploration of GR effects is generally only possible in binary systems⁵. The relevant equations in which a VLBI measurement of kinematics can contribute to the precision of a timing result are presented below – for an excellent review of all the equations relevant to pulsar timing, see the pulsar handbook of Lorimer and Kramer (2005).

For this thesis, the important timing equations are those dealing with orbital motion in binary pulsars. Equation 2.8 shows the factors which contribute to an observed change in binary period \dot{P}_b^{obs} :

$$\dot{P}_b^{\text{obs}} = \dot{P}_b^{\text{int}} - \dot{P}_b^{\text{kin}} \quad (2.7)$$

$$= \left(\dot{P}_b^{\text{GR}} + \dot{P}_b^{\text{drag}} + \dot{P}_b^{\text{tid}} + \dot{P}_b^{\text{ml}} \right) - \left(\dot{P}_b^{\text{acc}} + \dot{P}_b^{\text{Shk}} \right) \quad (2.8)$$

where the intrinsic contributions to \dot{P}_b^{obs} due to energy loss from the system (\dot{P}_b^{int}) consist of relativistic effects such as the emission of gravitation radiation (\dot{P}_b^{GR}), atmospheric drag (\dot{P}_b^{drag}), mass loss (\dot{P}_b^{ml}), and tidal dissipation (\dot{P}_b^{tid}), and the kinematic contribution \dot{P}_b^{kin} consists of the relative acceleration of the pulsar to the timing reference point (the solar system barycentre) \dot{P}_b^{acc} and the apparent acceleration caused by the pulsar's proper motion \dot{P}_b^{Shk} , which is known as the Shklovskii effect (Shklovskii, 1970). The kinematic contributions to \dot{P}_b^{obs} can be expressed as:

$$\frac{\dot{P}_b^{\text{acc}}}{P_b} = \frac{1}{c} \overrightarrow{BP} \cdot (\overrightarrow{a}_{\text{psr}} - \overrightarrow{a}_{\text{bar}}) \quad (2.9)$$

and

$$\frac{\dot{P}_b^{\text{Shk}}}{P_b} = \frac{v_{\text{T}}^2}{c d} \quad (2.10)$$

where \overrightarrow{BP} is a unit vector from the solar system barycentre to the pulsar, $\overrightarrow{a}_{\text{psr}}$ is the acceleration of the pulsar system, $\overrightarrow{a}_{\text{bar}}$ is the acceleration of the solar system barycentre, v_{T} is the transverse velocity of the pulsar, d is the distance from the pulsar to Earth and c is the speed of light. The acceleration terms $\overrightarrow{a}_{\text{bar}}$ and $\overrightarrow{a}_{\text{psr}}$ incorporate Galactic rotation, the vertical potential of the Galaxy (and the parent cluster for globular cluster pulsars), and any unmodeled nearby perturbing massive bodies. These apparent and actual accelerations due to kinematic effects also affect the pulsar's spin period P in a similar manner, for both isolated and binary pulsars.

⁵A counter-example is microlensing of pulsars, although this is yet to be observed

Equations 2.8 – 2.10 show that in the presence of accurate timing data for a binary pulsar and sufficiently accurate modeling of one set of parameters, one of the contributing factors to \dot{P}_b can be calculated. This was famously demonstrated by Taylor and Weisberg (1989) for \dot{P}_b^{GR} in the PSR B1913+16 system. Combining the measured value for \dot{P}_b with the observed and modeled components can yield a limit on the anomalous acceleration of the pulsar with respect to the Solar System. This anomalous acceleration can be interpreted as a change in the value of Newton’s gravitational constant G (Verbiest et al., 2008), the presence of a distant, massive planetary companion in the Solar System (Zakamska and Tremaine, 2005), or an error in the estimate of the Galactic gravitational potential (Bell and Bailes, 1996).

Often, the most uncertain contribution to \dot{P}_b^{obs} is the Shklovskii term \dot{P}_b^{Shk} , due to the large uncertainty which is generally associated with most pulsar distance measurements, which contributes a large uncertainty to the transverse velocity. Even in the case of excellent timing data, such as the Verbiest et al. (2008) measurement of PSR J0437–4715, direct measurement of distance through detection of the annual parallax yields an uncertainty of 8%, resulting in an unacceptably large error in \dot{P}_b^{Shk} , if the aim is to constrain another contribution⁶ to \dot{P}_b^{obs} . If the transverse velocity of a pulsar can be supplied through an independent measurement of parallax and proper motion, such as VLBI astrometry, the uncertainty in \dot{P}_b^{Shk} can be reduced sufficiently to allow significant constraints on other terms in \dot{P}_b^{obs} . An example of this is shown, with limits on \dot{G} and massive planetary companions, for PSR J0437–4715 in Section 6.1.1.

2.3.2 VLBI pulsar observations

For the purposes of VLBI, pulsars can be considered as unremarkable radio sources, except for the possibility of improving the sensitivity of observations through pulsar “gating”: blanking the telescope data at times when the pulsar flux is low or zero. This has the effect of eliminating noise which would otherwise be accumulated during these times, and hence improves sensitivity by a factor which can be estimated by $\frac{1}{\sqrt{\text{pulsar duty cycle}}}$. To date, VLBI pulsar gating has always used incoherent dedispersion, as the small amount of smearing incurred compared to coherent dedispersion has a negligible impact on the recovered signal to noise ratio. Pulsar gating is discussed in more detail in Section 4.3.4.

Despite the impressive resolution obtainable with VLBI (< 1 mas), the small physical size of the pulsar emission region means that even the nearest pulsars are completely

⁶ In this instance, the authors modeled all other contributions and used \dot{P}_b^{obs} to measure the distance to the pulsar

unresolved on VLBI baselines (assuming a pulsar emission height of 1000 km – most likely a gross overestimate – yields an angular size of $0.07 \mu\text{as}$ at 100 pc). Potential exceptions to this rule are the interactions of pulsars with their surrounding environment, such as pulsar wind nebulae (PWN), or interactions with companions, such as PSR B1259–63 (Johnston et al., 1999), although no such detections have yet been published. It is also worth noting that VLBI observations of pulsars can be used to obtain very high resolution speckle images of scattering disks in the ISM. The first example of such an observation (which used the DiFX software correlator) is briefly discussed in Section 4.6.3.

Thus, the main application of VLBI observations of pulsars is to obtain astrometric information, either for the purpose of making associations with other observed structures such as supernova remnants (e.g. Brisken, 2005), or to improve the accuracy of kinematic and distance information for use in timing, luminosity, and Galactic electron distribution models. It is these latter applications which are the focus of this thesis, and they are explored in detail in Chapter 6.

3

RADIO INTERFEROMETRY

3.1 Conceptual overview

Radio interferometry makes use of the spatial separation of two or more antennas to obtain information about smaller angular structures in the radio sky than can be gleaned from single-dish studies. Whilst one can probe smaller angular scales with a single dish by increasing the dish diameter, this has two undesirable side effects. Firstly, the smaller beam means that the survey speed of the instrument is not improved, despite the improved sensitivity. Secondly, the cost and technical difficulty imposed by the larger physical diameter of the antenna rapidly become prohibitive. The inverse relationship between dish size and “primary beam” – the full-width at which the antenna response has dropped to one half its peak – is illustrated in Figure 3.1(a). Figure 3.1(b) shows how a pair of antennas – the classic two-element interferometer – can discriminate between structure which lie within the primary beams of the individual elements. With a full mathematical treatment of interferometry deferred until Section 3.5, it is sufficient at this point to note the potential degeneracies of a single measurement with the two-element interferometer, and to observe that different projected antenna spacings – *baselines* – would be required to determine the structure of the source being observed.

3.2 Historical development

Radio astronomy was founded in 1933, when Karl Jansky published the detection of the Galactic background at low frequency (Jansky, 1933). Considerable progress in the new wavelength regime, however, was delayed until the end of the second world war, at which time large quantities of military radio equipment began to be used for radio astronomy. The first interferometric observations were made around this time in Australia, using a

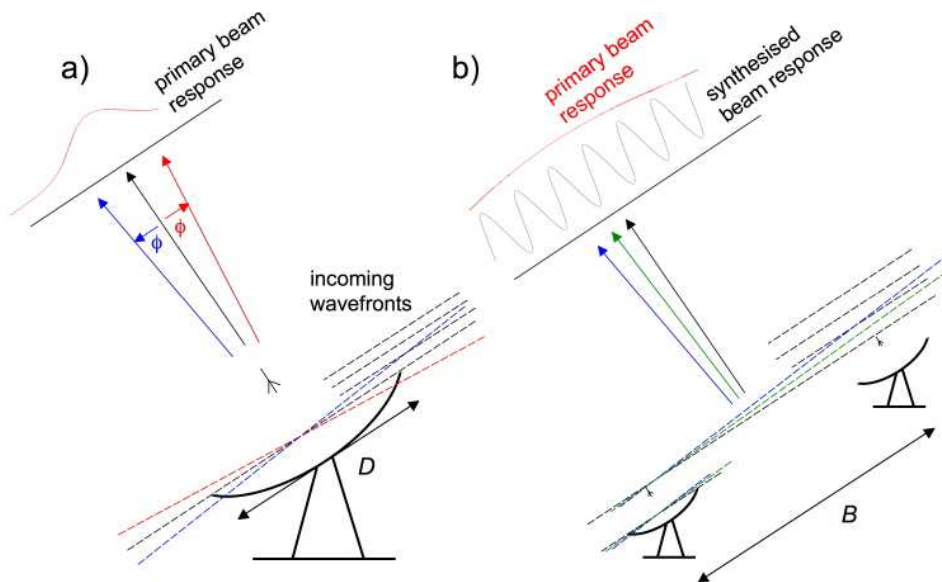

Figure 3.1 Resolution of a single dish compared to a two–element interferometer. (a) Response of a single antenna element. As diameter D increases, the radiation collected at the edges of the dish becomes further out of phase for a given angular offset ϕ . As wavelength λ decreases, a fixed time/distance offset at the edge of the dish corresponds to a greater amount of phase. The full width half maximum (FWHM) of the antenna response – the “primary beam” – is given by $1.22\lambda/D$. (b) Response of a two–element interferometer. The FWHM of the “synthesised beam” is given by the similar expression $1.22\lambda/B$, where B is the projected distance between the antennas, in a plane perpendicular to the observation direction.

single receiving element mounted on a sea cliff (Pawsey et al., 1946). This arrangement made use of the path delay provided by the reflection off the sea surface; however, arrays of separate receiving elements soon appeared (Ryle and Vonberg, 1946).

These early interferometers measured only the changing intensity of the summed interferometer signal – a direct analogue to the optical two-slit experiment. A major advance came with the advent of phase-switching interferometers (Ryle, 1952), which introduced a periodic phase inversion to one of the interferometer elements. This allowed the measurement of the multiplicative term between the elements without the addition of the individual squared signals, considerably improving interferometer sensitivity. This, in turn, was made redundant through the improved stability of frequency standards which allowed direct multiplication of the signals from interferometer elements.

The ongoing rapid improvements in the capabilities of digital electronic equipment has allowed correspondingly rapid improvements in interferometer capabilities. The cost of new instruments is now generally dominated by the structural components of the antennas and associated infrastructure, making the upgrade of existing instruments with new electronic components an attractive proposition. Such upgrades are underway or recently completed for the Very Large Array (the Expanded VLA: Perley et al., 2004) and several VLBI arrays, which are discussed below.

3.3 VLBI

As radio interferometers developed, a natural tendency was to increase baseline length to achieve better angular resolution. This trend quickly reached the limits at which information could be distributed to and received from antennas in real time with existing technology. To overcome this limitation, disconnected stations were equipped with recording media to store baseband data until it could be brought to a common location, and made use of independent frequency standards. Early examples of science undertaken with such arrays were published by Clark et al. (1967) and Moran et al. (1967). The technological limitations on VLBI were progressively lifted, and a number of ad-hoc and part-time VLBI arrays functioned around the world from the 1970s onwards. These included the Network Users Group in North America¹, the European VLBI Network (EVN)², the Asia-Pacific Telescope (APT)³, and the Australian Long Baseline Array (LBA)⁴. A purpose-built, full-time VLBI array was commissioned in the US in the 1990s – the Very Long Baseline

¹discussed along with other early North American efforts by Kellermann and Cohen (1988)

²<http://www.evlbi.org/>

³<http://www.vsop.isas.jaxa.jp/apt/>

⁴<http://www.atnf.csiro.au/vlbi/>

Array (VLBA)⁵. Throughout the development of VLBI, the use of independent frequency standards and non-real time correlation has remained the defining distinction between VLBI and regular “connected element” interferometry, although recently pseudo-realtime correlation has become possible on some VLBI arrays through the use of high bandwidth fibre optic links (“eVLBI”), which is discussed further in Section 4.6.1. For a comprehensive overview of the development of VLBI and radio interferometry in general, see Kellermann and Moran (2001).

VLBI allows the highest angular resolution available to imaging in astronomy at any waveband, which allows the detailed study of the most distant objects in the Universe, as well as objects with small physical extent in the more nearby Universe. Historically, targets of interest have included active galactic nuclei (AGN), radio galaxies, masers and pulsars. Studying the emission of these objects on the smallest scales has given unique insight into the physics that power them, as well as throwing up surprising discoveries such as apparent superluminal motion (Whitney et al., 1971). One of the most important applications of VLBI has little to do with the sources themselves, however, and is the creation and maintenance of a stable, quasi-inertial reference frame upon which astronomical positions can be based. Historically the domain of optical astronomy (and defined most recently by the FK5 reference frame; Fricke et al., 1988), this responsibility was assumed by VLBI when the International Celestial Reference Frame (ICRF) superseded the FK5 reference frame in 1998. Defined by 212 distant radio sources (Ma et al., 1998), it has been extended to include several hundred additional “candidate” and “new” sources (Fey et al., 2004). VLBI measurements also form an important contribution to the International Terrestrial Reference Frame (ITRF), which along along with the ICRF is discussed further in Section 3.8.

3.4 Instrumentation and hardware

The purpose of an element in a modern radio interferometer is to obtain a digitised time-domain representation of the radio energy within a desired frequency band incident upon the element, adding as little noise as possible in the process. Once this has been achieved, digital signal processing can be used to compute the correlation between array elements, which along with a knowledge of the array geometry can be used to generate a model of the observed sky in the first the spatial frequency domain, then the image domain. This section describes the hardware required – a mathematical description of the foundations of interferometry is presented in Section 3.5. The description below assumes a typical

⁵<http://www.vlba.nrao.edu/>

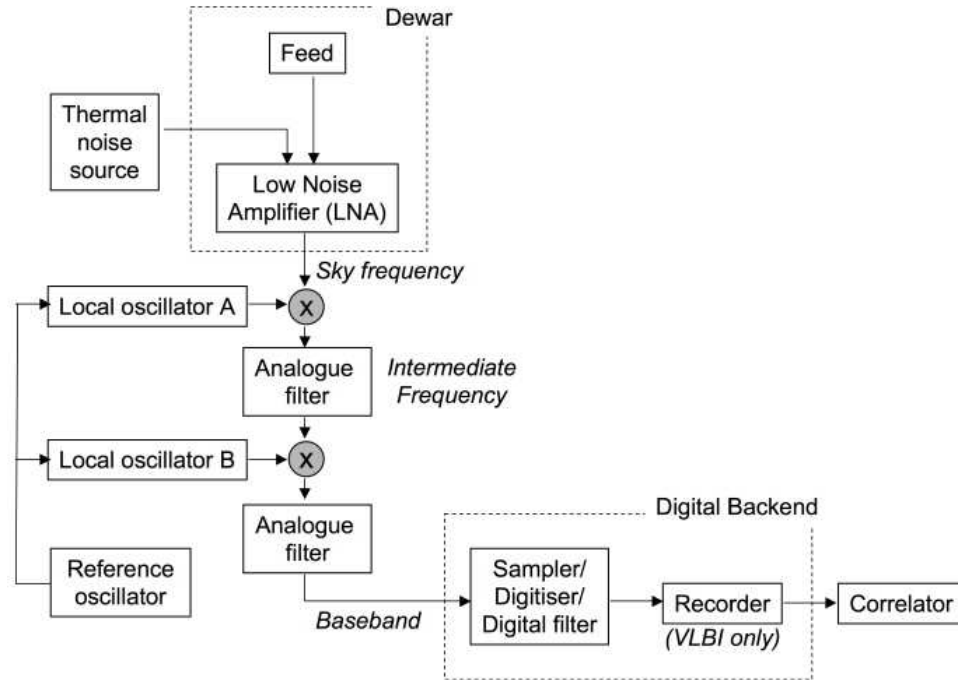

Figure 3.2 Hardware components of an interferometer.

reflecting concentrator (dish) type radio telescope, referred to throughout as an antenna. Figure 3.2 shows the components discussed below.

The electric field present at the focal point of an antenna is converted to an electrical voltage by a sensor referred to as a feed. Typical feeds consist of two components sensitive to two (usually linear, although circular is possible) orthogonal polarisations. The feed itself typically resides within a *feed horn*, whose purpose is to shape the illumination of the feed to the antenna surface and hence optimise the antenna primary beam response. The time-varying voltage signal $v(t)$ at the feed is linearly proportional to the electric field $E(t)$ present at the feed.

The voltage signal induced in the feed is extremely small, as the radio power influencing the voltage is itself extremely small. Thus, the first stage of signal manipulation is to amplify the signal using a Low Noise Amplifier (LNA). This first stage of amplification dominates the noise budget of the receiver system, and so considerable effort is made to minimise the noise contribution of the LNA. The dominant noise contribution comes from thermal electron motion, and so feeds and LNAs are often housed in a cooled chamber – a dewar – as shown in Figure 3.2.

The calibration of received power is generally undertaken through the injection of a known noise source prior at the beginning of the receiver system, prior to the LNA. By modulating the noise source on and off, the rise in measured power can be used to calculate the total power. This procedure is particularly important for VLBI, where there are no unresolved, constant flux sources that can be used for absolute flux calibration, as discussed in Section 3.6. The noise source is usually a thermally controlled resistive load, which is coupled to the input of the LNA.

Once the received signal has been amplified, it must generally be downconverted from the sky frequency to a lower frequency where digital electronics can be efficiently used. This is achieved by a series of mixing operations, often with filtering applied at each stage to prevent aliasing of the signal. The reference oscillator for the mixing stages is generally based on an atomic oscillator, such as rubidium or hydrogen (commonly used for VLBI due to the excellent frequency stability). This “local oscillator” is distributed to all antennas in a connected element array, but this is not feasible for VLBI arrays.

Once the data is at or close to “baseband” (frequency range starting at 0 Hz), it can be sampled and digitised, at which point digital signal processing can be applied. The sampler/digitiser (and recorder, for VLBI) is collectively referred to as a “digital backend”, and modern examples incorporate features such as digital filtering (e.g. Iguchi et al., 2005) to improve the data quality. The digitised data is then transported to the correlator, which produces the sampled visibilities (scaled fractional correlation between antennas) as a function of frequency and time. The correlator is the focal point of the hardware chain in terms of this thesis, and correlators in general and the DiFX software correlator in particular are discussed in more detail in Chapter 4.

3.5 Mathematical description

All of the salient concepts of interferometric Fourier synthesis imaging can be succinctly illustrated using a two–element interferometer, so this simplified example will be presented here. It should be noted that this section draws heavily on the explanation of interferometer theory presented in Thompson (1999). Throughout, the standard interferometric assumptions of a far–field, spatially incoherent source are made. A diagram of a two–element interferometer is shown in Figure 3.3. The elements are separated by a baseline \mathbf{b} , and are both pointing in the direction of the unit vector $\hat{\mathbf{s}}$. The geometric time delay between the signal arriving at antenna A and antenna B is given by $\tau_g(t) = \mathbf{b} \cdot \hat{\mathbf{s}}/c$, where c is the speed of light. It is shown as a function of time since, depending on the choice of reference axis, either \mathbf{b} or $\hat{\mathbf{s}}$ will change with time as the Earth rotates.

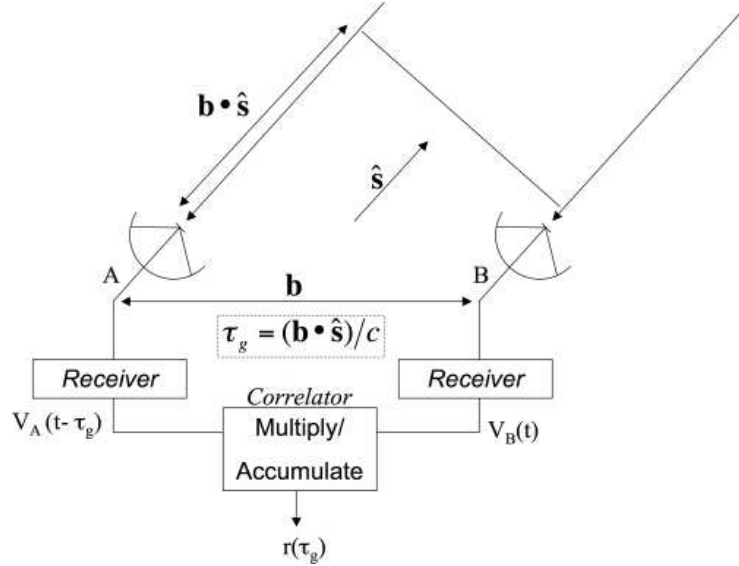

Figure 3.3 Response of a two-element interferometer

Considering the astronomical signal initially to be a monochromatic wave of frequency ν considerably simplifies the analysis, reducing the correlator function to a simple multiply and accumulate⁶, while still demonstrating the Fourier relation between interferometer observables and the actual sky brightness distribution. In this case, the response of a single element will be of the form $V = v \cos 2\pi\nu t$, and so the correlator output can (in the absence of any delay tracking) be written as:

$$\begin{aligned}
 r(t) &= \langle V_A(t)V_B(t) \rangle & (3.1) \\
 &= v_A v_B \cos 2\pi\nu(t - \tau_g) \cos 2\pi\nu t \\
 &= v_A v_B \cos 4\pi\nu t - 2\pi\nu\tau_g + v_A v_B \cos 2\pi\nu\tau_g \\
 &\simeq v_A v_B \cos 2\pi\nu\tau_g
 \end{aligned}$$

Thus, assuming the averaging time is long compared to the term at twice sky frequency, but short compared to the changing τ_g , the correlator output will be a sinusoid-like function (since τ_g is not varying linearly, it is not a true sinusoid) with amplitude $V_A V_B$, which is proportional to the received power.

If radio brightness is represented by I , then the radio brightness in the direction of \hat{s} can be written as $I(\hat{s})$. Brightness, which is the desired quantity when mapping the radio

⁶the non monochromatic case will be considered in the following chapter

sky, is measured in power per unit area, per unit bandwidth, per unit solid angle, and can be placed in units of $\text{W m}^{-2} \text{Hz}^{-1} \text{sr}^{-1}$. From this it follows that from a source element $d\Omega$ in the direction $\hat{\mathbf{s}}$, an antenna with effective area $A(\hat{\mathbf{s}})$ accepting bandwidth $\Delta\nu$ will receive power equal to $A(\hat{\mathbf{s}})I(\hat{\mathbf{s}})\Delta\nu d\Omega$. Since the correlator output was proportional to received power, by neglecting constant gain factors the correlator output from solid angle $d\Omega$ can be written as:

$$dr = A(\hat{\mathbf{s}})I(\hat{\mathbf{s}})\Delta\nu d\Omega \cos 2\pi\nu\tau_g \quad (3.2)$$

The correlator output can then be written as integration over the whole sky ($S \equiv 4\pi$ steradians)⁷:

$$r = \Delta\nu \int_S A(\hat{\mathbf{s}})I(\hat{\mathbf{s}}) \cos \frac{2\pi\nu\mathbf{b} \cdot \hat{\mathbf{s}}}{c} d\Omega \quad (3.3)$$

In general, interferometric images are made in a relatively small solid angle, as constrained by the antenna primary beams. Thus, it is convenient to rewrite $\hat{\mathbf{s}}$ as $\hat{\mathbf{s}} = \mathbf{s}_0 + \boldsymbol{\sigma}$, where the image centre \mathbf{s}_0 is fixed and is referred to as the *phase centre*. Substituting this into equation 3.3 yields:

$$\begin{aligned} r &= \Delta\nu \cos \frac{2\pi\nu\mathbf{b} \cdot \mathbf{s}_0}{c} \int_S A(\boldsymbol{\sigma})I(\boldsymbol{\sigma}) \cos \frac{2\pi\nu\mathbf{b} \cdot \boldsymbol{\sigma}}{c} d\Omega \\ &- \Delta\nu \sin \frac{2\pi\nu\mathbf{b} \cdot \mathbf{s}_0}{c} \int_S A(\boldsymbol{\sigma})I(\boldsymbol{\sigma}) \sin \frac{2\pi\nu\mathbf{b} \cdot \boldsymbol{\sigma}}{c} d\Omega \end{aligned} \quad (3.4)$$

At this point, it is necessary to introduce the term *visibility*. The visibility is a measure of the coherence of the radio sky brightness distribution, modified by the antenna response, between an antenna pair. It is a complex quantity defined as:

$$V \equiv |V|e^{i\phi_V} = \frac{1}{A_0} \int_S A(\boldsymbol{\sigma})I(\boldsymbol{\sigma})e^{2\pi i\nu\mathbf{b} \cdot \boldsymbol{\sigma}/c} d\Omega \quad (3.5)$$

where A_0 is the antenna response at the phase centre. Subsequently, it will be shown that the visibility is, under certain assumptions, actually the Fourier transform of the radio sky brightness $I(\boldsymbol{\sigma})$. First, however, the relationship of correlator output to visibility will be shown. By separating the real and imaginary components of Equation 3.5, the following expressions are obtained:

$$A_0|V| \cos \phi_V = \int_S A(\boldsymbol{\sigma})I(\boldsymbol{\sigma}) \cos \frac{2\pi i\nu\mathbf{b} \cdot \boldsymbol{\sigma}}{c} d\Omega \quad (3.6)$$

⁷In practice, however, the limitations of the primary beam of the antenna elements means that $A(\hat{\mathbf{s}})$ is only non-zero for a small solid angle

and

$$A_0|V| \sin \phi_V = - \int_S A(\boldsymbol{\sigma}) I(\boldsymbol{\sigma}) \sin \frac{2\pi i \nu \mathbf{b} \cdot \boldsymbol{\sigma}}{c} d\Omega \quad (3.7)$$

which can then be substituted into Equation 3.5 to obtain:

$$r = A_0 \Delta \nu |V| \cos \left(\frac{2\pi \nu \mathbf{b} \cdot \mathbf{s}_0}{c} - \phi_V \right) \quad (3.8)$$

Thus, a correlator with no delay tracking measures the visibility, modulated by a fringe pattern with frequency dependent on frequency and baseline, and an amplitude dependent on the antenna response. The removal of this fringe pattern by a realistic correlator to enable direct measurement of visibility, as well as dealing with the effects of finite bandwidth and frequency down-conversion, are discussed in Chapter 4.

Once the complex visibility has been sampled by an interferometer, the desired result is generally an image of the radio sky brightness distribution. In order to show the validity of synthesis imaging, it is necessary to define the coordinate systems for both visibility and sky brightness. These are illustrated in Figure 3.4. The three orthogonal coordinate axes for a visibility point are $(\hat{\mathbf{u}}, \hat{\mathbf{v}}, \hat{\mathbf{w}})$, with the corresponding axes in the brightness distribution being $(\hat{\mathbf{l}}, \hat{\mathbf{m}}, \hat{\mathbf{n}})$. The natural units for the visibility axes are wavelengths corresponding to the observed frequency. This convention will be followed for the remainder of this thesis. In general radio astronomy convention, the $\hat{\mathbf{w}}$ axis points in the direction \mathbf{s}_0 , while $\hat{\mathbf{u}}$ and $\hat{\mathbf{v}}$ are orthogonal to each other and the $\hat{\mathbf{w}}$ axis, and are on the plane containing the $\hat{\mathbf{w}}$ axis and celestial East and North respectively. The synthesised image is assumed to be two-dimensional, and so positions on the sky are described in terms of l and m . The vector quantity $\hat{\mathbf{s}}$ can be expressed as $l\hat{\mathbf{l}} + m\hat{\mathbf{m}} + n\hat{\mathbf{n}}$.

The quantities \mathbf{b} , $\hat{\mathbf{s}}$, \mathbf{s}_0 and Ω referred to in the above derivation can then be expressed as:

$$\frac{\nu \mathbf{b} \cdot \hat{\mathbf{s}}}{c} = ul + vm + wn \quad (3.9)$$

$$\frac{\nu \mathbf{b} \cdot \mathbf{s}_0}{c} = w \quad (3.10)$$

$$d\Omega = \frac{dl dm}{n} = \frac{dl dm}{\sqrt{1 - l^2 - m^2}} \quad (3.11)$$

Substituting Equations 3.9–3.11 into Equation 3.5 yields:

$$V(u, v, w) = \frac{1}{A_0} \int_{-\infty}^{\infty} \int_{-\infty}^{\infty} A(l, m) I(l, m) e^{-2\pi i [ul + vm + w(\sqrt{1 - l^2 - m^2} - 1)]} \frac{dl dm}{\sqrt{1 - l^2 - m^2}} \quad (3.12)$$

Since, as components of a unit vector, $l^2 + m^2 + n^2 = 1$, the integrand is necessarily 0

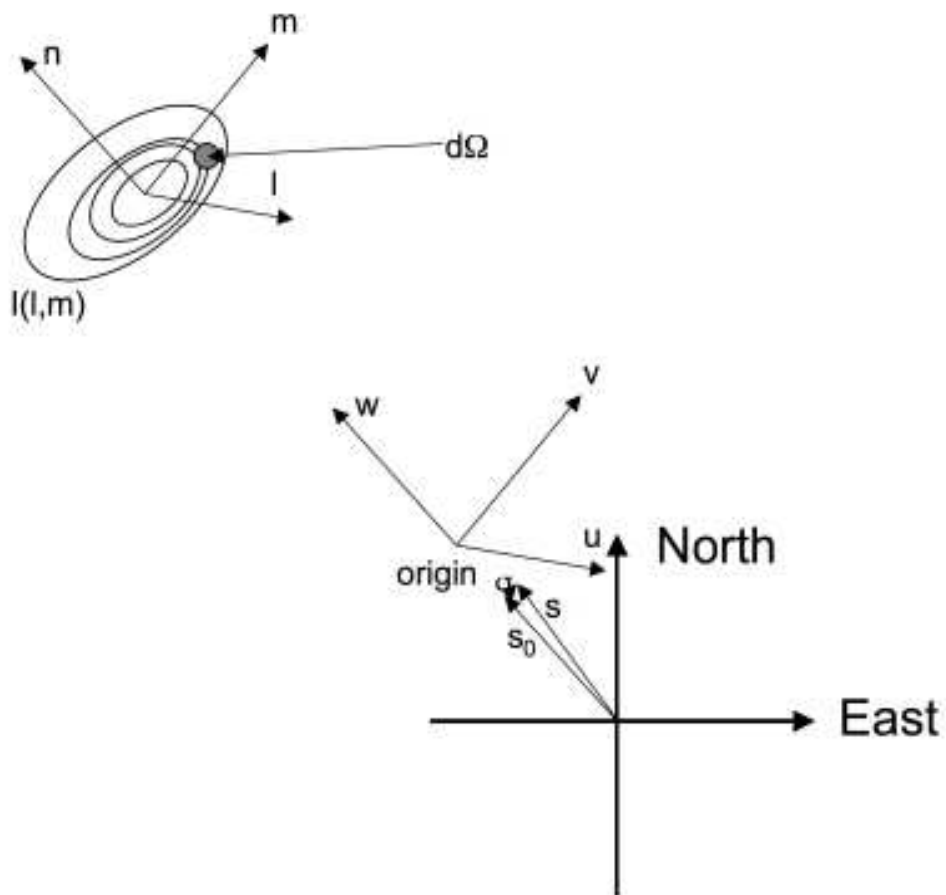

Figure 3.4 Definition of interferometer coordinate systems used throughout this thesis.

where $l^2 + m^2 \geq 1$.

To obtain the radio sky brightness distribution $I(l, m)$, it is necessary to invert Equation 3.12. Whilst possible in the generalised form given above, it is conceptually difficult and computationally expensive. If the visibility equation given above can be reduced to the form of a two-dimensional Fourier transform (necessitating the removal of the w term), the inversion can be carried out using a Fast Fourier Transform (Cooley and Tukey, 1965), which is much more computationally tractable. If l and m are constrained to be small – restricting the field of view to a small solid angle – then the term $\sqrt{1 - l^2 - m^2}$ reduces to 1, eliminating w from Equation 3.12 and leaving:

$$V(u, v) = \frac{1}{A_0} \int_{-\infty}^{\infty} \int_{-\infty}^{\infty} A(l, m) I(l, m) e^{-2\pi i[ul+vm]} dl dm \quad (3.13)$$

Equation 3.13 can be inverted via the Fourier relation to yield:

$$\frac{1}{A_0} A(l, m) I(l, m) = \int_{-\infty}^{\infty} \int_{-\infty}^{\infty} V(u, v) e^{2\pi i[ul+vm]} du dv \quad (3.14)$$

Thus, the correlator output can be transformed, under certain assumptions, to yield the original sky brightness. For a more detailed description of the limitations of the small-field assumption and methods of circumventing it, see Thompson (1999).

3.6 Calibration and editing

Before the transformation of visibilities into a sky brightness distribution can take place, incorrect and uncorrectable visibilities must be removed (a process known as flagging), and the remaining visibilities correctly calibrated. Visibilities which must be flagged are typically those which have been affected by equipment failure, radio frequency interference (RFI) or severe propagation problems (rapid ionospheric visibility at low frequencies, water vapour variations at high frequencies, and physical problems such as antenna shadowing). Flagging can be automated (based on logs of telescope and electronic failures, for example, or on the visibility values themselves) or manual, where visibilities are inspected by eye and questionable samples removed. Flagging is an inexact procedure which has been the subject of numerous analyses (e.g. Middelberg, 2006; Ekers, 1999).

Calibrating the interferometer output amplitude to obtain the true visibility amplitude requires, as shown in Equation 3.8, a knowledge of the peak antenna response. As discussed in Section 3.4, this can be achieved through the use of noise calibration at the individual antennas. For short-baseline arrays, this calibration is typically refined by including an

observation of a known “flux calibrator”, a compact, unconfused source known to possess stable flux. Antenna-based correction factors can be derived by comparing the measured visibilities with the known values. This is a luxury not available to VLBI arrays, since there are no constant flux sources which are still compact on VLBI baselines (Walker, 1999). Thus, accurate logging of antenna noise calibration is especially crucial for the absolute, as well as relative, calibration of VLBI observations.

At this stage, it is also possible to make corrections to the visibility phases, to compensate for dispersive and non-dispersive delays which were not correctly accounted for in the correlator model – that is, the first term in the cosine of Equation 3.8 was not correctly subtracted. Typically, this involves measured atmospheric and ionospheric quantities that were not available at the time of correlation, and are most commonly required in VLBI observations. Other potentially correctable errors which can occur during VLBI correlation include geometric model errors due to incorrect Earth Orientation Parameters (EOPs). These values, which collectively describe the orientation and rotational phase of the Earth to very high precision, are made available by the International Earth Rotation Service (IERS⁸), and are calculated using intensive geodetic VLBI observations (see Section 3.8 below).

Once calculated, the application of corrections is simple, amounting to a simple scaling of visibility amplitudes or rotation of phase. Typically, the rate of change of corrections is small, and so the error caused by the finite visibility sampling duration is not a concern. For very rapidly varying corrections, or for errors which cannot be modeled and subtracted, however, the sampled visibilities remain in error. Residual visibility errors add noise to an interferometric image, but may be corrected (in some circumstances) in the imaging stage as discussed below.

3.7 Imaging

This section is meant as an overview of the main techniques used in VLBI to produce radio images. It does not cover complicating factors such as the (potentially inhomogeneous) antenna primary beam responses, wide-field effects, the effect of spectral and temporal averaging, or gridding techniques. For a complete reviews of radio synthesis imaging, see (for example) Thompson et al. (1994) and Pearson and Readhead (1984).

Once an edited, calibrated visibility set has been produced, it may be transformed into an image using the Fourier relation shown in equation 3.14. Generally speaking, however, the sampling of visibilities in the uv plane will be incomplete (especially for VLBI, where

⁸<http://www.iers.org/>

small numbers of antennas often mean extremely sparse sampling), which introduces considerable distortion in the transformed image. Essentially, the measured visibilities can be considered to be the product of the true Fourier transform of sky brightness with a sampling function $S(u, v)$, which is 1 (or indeed any non-zero weight, if weighting is applied in the uv plane) where visibilities were measured and 0 elsewhere. By virtue of the Fourier transform duality between multiplication and convolution, this leads to the transformed image effectively becoming the convolution of the true sky brightness with the Fourier transform of the sampling function $\mathcal{F}\{S(u, v)\} = s(l, m)$. This directly generated map is generally referred to as the “dirty” map, and the Fourier transform of the sampling function, $s(l, m)$ is known as the synthesized beam.

Thus, to obtain the true sky brightness distribution, it is necessary to “deconvolve” the effects of limited visibility sampling. In general, this takes the following iterative form:

1. Adjust sky brightness model (add/subtract/move components).
2. Compute visibilities expected due to this model.
3. Subtract expected visibilities from observed visibilities to obtain a “residual” brightness distribution.

Once the best source model has been obtained, it is convolved with a “restoring” beam, which is typically taken as an elliptical gaussian truncated at the first null of the synthesized beam, and the remaining residual map added. This generates a “clean” map with similar resolution to the original dirty map, but with the sidelobes generated by the synthesised beam minimised.

Various procedures have been developed to make use of a priori information to help guide step 1 above, and converge towards the best (and simplest) global solution for the true sky brightness, which is complicated by the fact the the measured visibilities are corrupted by noise. Popular examples of imaging algorithms include CLEAN (Högbom, 1974), least squares model fitting (Pearson, 1999), maximum entropy (MEM; Ables, 1974) and various derivatives and combinations of the above. In this thesis, both model fitting and CLEAN were used.

During the imaging process, it is possible to make use of additional relationships between groups of visibilities to improve the a priori calibration and remove errors in the visibilities. These “closure” quantities result from the relationship between the true and

observed visibilities, which can be written as shown in Section 3.5:

$$V_{mn}^{\text{obs}} = g_m g_n^* V_{mn} \quad (3.15)$$

$$|V_{mn}^{\text{obs}}| e^{i\phi_{mn}^{\text{obs}}} = |g_m| |g_n| |V_{mn}| e^{i(\phi_{g_m} - \phi_{g_n} + \phi_{mn})} \quad (3.16)$$

where $g_m = |g_m| \exp i\phi_{g_m}$ is the complex gain associated with antenna m . Considering only terms in the exponent of Equation 3.16 yields:

$$\phi^{\text{obs}_{mn}} = \phi_{g_m} - \phi_{g_n} + \phi_{mn} \quad (3.17)$$

and considering the summation of the phase terms from the common baselines of three antennas m , n and p gives the phase closure relationship for the ‘‘closure phase’’ $\phi_{mnp}^{\text{close}}$:

$$\phi_{mnp}^{\text{close}} = \phi_{mn}^{\text{obs}} + \phi_{np}^{\text{obs}} + \phi_{pm}^{\text{obs}} = \phi_{mn} + \phi_{np} + \phi_{pm} \quad (3.18)$$

Equation 3.18 shows that the closure phase is a quantity which is independent of the antenna-based gains, which include the effect of varying atmospheric propagation and other antenna-based errors, and as solely determined by the true visibility phase. Thus, if a sufficiently accurate model of the brightness distribution is available, deviations in phase from the model phase can be attributed to antenna-based errors and adjustments made to the value of ϕ_{g_m} for each antenna to minimise the difference between model and observed visibility phases. This procedure is known as ‘‘phase self-calibration’’.

By considering the magnitude terms of Equation 3.16, the following equation for closure amplitude $|V_{mnpq}^{\text{close}}|$ can be constructed from baselines of four antennas m , n , p and q :

$$|V_{mnpq}^{\text{close}}| = \frac{|V_{mn}^{\text{obs}}| |V_{pq}^{\text{obs}}|}{|V_{mp}^{\text{obs}}| |V_{nq}^{\text{obs}}|} = \frac{|V_{mn}| |V_{pq}|}{|V_{mp}| |V_{nq}|} \quad (3.19)$$

Equation 3.19 shows that the closure amplitude, like closure phase, is independent of the antenna-based complex gains, and similarly can be used to compute a correction to the gains to minimise the difference between model and observed visibilities. Unsurprisingly, this procedure is known as amplitude self-calibration.

While self-calibration is a useful tool for removing antenna-based errors and improving the fidelity of radio synthesis images (usually measured by *dynamic range* – the ratio of peak image flux to image noise), its principal drawback is that it can only attempt to reduce the difference between the observed visibilities and the model visibilities. If the input model does not resemble the actual sky brightness distribution, application of

self calibration will not improve image quality, and may limit the potential to improve the model in the future. Furthermore, if the closure quantities are extremely noisy, self calibration may act to fit noise to the model. For more details on the use of self-calibration in interferometric imaging, see Cornwell and Fomalont (1999).

3.8 Astrometry and geodesy

As shown in Equation 3.8, the uncorrected phase term of correlator output contains the true visibility phase for a source, corrupted by a geometric term. Actual correlator implementations, as discussed in the following chapter, attempt to remove this non-intrinsic term as precisely as possible. However, the ability to do this depends on the exact knowledge of both the \mathbf{b} and $\hat{\mathbf{s}}$ vectors, and thus on the exact location of the source and antennas. Errors in the assumed values for \mathbf{b} or $\hat{\mathbf{s}}$ will cause the correlator output phase to differ from the true visibility phase.

The use of the visibility phase error to calculate error in assumed source position (holding the baseline vector fixed) is known as *astrometry*, while calculating errors in assumed baseline vectors is known as *geodesy*. An excellent overview of the theory and practical difficulties of VLBI astrometry and geodesy is given in Fomalont (1999). It should be immediately apparent that disentangling the phase contributions due to unknown baseline and source vector errors *simultaneously* is a challenging task, and multiple baselines and sources are required to make such a global solution. Further complicating the problem are the residual visibility phase errors due to the unmodeled atmosphere and ionosphere. The contribution from the ionosphere is frequency-dependent and can be estimated and subtracted if observing frequencies span a wide fractional bandwidth and sufficiently high signal to noise ratios can be obtained, and astrometric/geodetic observations often use a dual-band “S/X” (2.3 GHz and 8.4 GHz) receiver for the purpose of obtaining widely separated bands (see e.g. Petrov et al., 2008). The contribution from the atmosphere (predominantly the wet and dry troposphere) is independent of frequency, however, and so improvements to the a priori model can only be made through the use of station weather information, such as water vapour radiometers (Roy et al., 2006).

The principal difficulty confronting astrometric and geodetic observations is that the powerful self-calibration technique cannot be used freely – since it acts to converge visibilities with a pre-existing model, incorrect usage will corrupt the measurements of source and antenna positions which are being sought. Sources used for astrometry and geodesy should ideally have no detectable structure, simplifying the problem, but suitably bright examples of such sources are rare (see e.g. Gontier et al., 2001). Thus, correct calibra-

tion of visibility phases through the careful modeling of propagation effects and source structure is of the utmost importance in astrometric and geodetic observations.

The fundamental reference frames which are the product of absolute astrometry and geodesy are the ICRF and ITRF, introduced in Section 3.3. They are maintained and improved by the IERS. The ongoing maintenance of these frames allows other users to undertake relative astrometry and (less commonly) geodesy, under the assumption that positions of the defining members of these frames are correct. This procedure of relative VLBI astrometry forms the basis of the measurement of pulsar position measurements made in this thesis, and as such is discussed in further detail in Chapter 5. Geodesy is not a fundamental component of this thesis, but will be mentioned where appropriate as it impacts on the astrometric measurements.

When undertaking relative, as opposed to absolute astrometry, one of the major practical differences is the use of single-band phase, as opposed to multi-band delay which is commonly used for absolute astrometry and geodesy. Even the best available a priori delay modeling is uncertain at the level of nanoseconds, which corresponds to multiple turns of phase at typical observing frequencies. Thus, for absolute astrometry the delay is generally estimated by the phase gradient between observing bands – the so-called “multi-band delay”. The concept of multi-band delay is explained in detail in Fomalont (1999). When conducting relative astrometry, however, the delays are calibrated to higher precision through observations of a known source, meaning the single-band phases no longer suffer from wrap ambiguities. This allows a higher precision estimation of relative position. However, the accuracy of the delay solution transfer from calibrator to target in relative astrometry depends on the angular separation of the two sources, and the gradient in residual delay between them. Clearly, it is desirable to minimise this angular separation, in addition to attempting to obtain the best possible modeling to minimise the residual error gradient. Pradel et al. (2006) present an comprehensive simulation-based analysis of errors in relative astrometry, including the effect of different error sources such as the wet and dry troposphere at different angular separations.

4

DIFX: AN FX STYLE SOFTWARE CORRELATOR

An in-depth description and analysis of the DiFX code was published in Deller et al. (2007), and the remainder of this chapter draws upon the material presented there, as well as the description of correlator functionality presented in Romney (1999).

4.1 Mathematical description of a correlator

Chapter 3 showed that a radio interferometer measures the spatial frequency components of the observed sky brightness distribution, and that this information, under certain restrictions, could be transformed into an estimation of the actual sky brightness distribution. However, this treatment was valid only for the unphysical case of a monochromatic radio source, and neglected the effect of data sampling, which is crucial to the operation of modern interferometers. In this section, I show the effects of relaxing these restrictions, and the functionality which must be incorporated into a realistic correlator to compensate. The description will be appropriate for an unconnected interferometer, and simplifications that can be adopted for connected interferometers will be noted where applicable. The mathematical derivation will be appropriate for an FX-type correlator (see Section 4.2.1 for the definition of an FX-type correlator), and the advantages and limitations compared to an XF-type correlator will be highlighted.

4.1.1 Quasi-monochromatic formalism

It is convenient to represent the electromagnetic radiation from the source as a quasi-monochromatic plane wave incident on the antennas, described (for a given antenna p)

by:

$$E_p(t + \tau_p) = A(t + \tau_p)e^{i2\pi\nu_0(t+\tau_p)} \quad (4.1)$$

The electric field component is given by the real component of Equation 4.1. It is clear that for a realistic, band-limited process $A(t + \tau_p)$, the electric field component will be a band-limited signal, centred on ν_0 . $A(t + \tau_p)$ is a complex signal which must also be covariance-stationary, ergodic and stochastic. The term τ_p shown in Equation 4.1 above represents the delay between antenna p and a reference point¹.

Since $A(t + \tau_p)$ has been asserted to be band-limited, it can be written as:

$$A(t + \tau_p) = \int_{-\infty}^{\infty} s(\nu)e^{i2\pi\nu(t+\tau_p)} d\nu \quad (4.2)$$

with the proviso that $s(\nu) = 0$ outside some limiting band $|\nu| < B$.

As shown in Section 3.5, the correlator's function is to compute the expectation of the cross correlation of the two received signals from antennas p and q :

$$\begin{aligned} r_{pq}(\tau) &= \langle E_p(t + \tau_p)E_q^*(t + \tau_q) \rangle & (4.3) \\ &= \langle E_p(t + \tau_g)E_q^*(t) \rangle \\ &= \langle A(t + \tau_g)A^*(t) \rangle e^{i2\pi\nu_0\tau_g} \\ &= \gamma_{pq}(\tau)e^{i2\pi\nu_0\tau_g} \end{aligned}$$

Throughout this thesis, the superscript * will be taken to mean complex conjugation². Since $A(t)$ is ergodic, the expectation can be approximated by a time average. As in Chapter 3, τ_g represents the geometric delay $\tau_p - \tau_q$ between antennas p and q . The term $\gamma_{pq}(\tau)$ is the covariance function of the stochastic process $A(t)$, and represents the unmodulated correlation between the electric fields on this baseline – the visibility, as shown in the previous chapter. This visibility is modulated by the time-varying phasor $e^{i2\pi\nu_0\tau_g}$.

Ultimately, the visibility is required as a function of frequency, which can be obtained

¹Usually the geocentre for VLBI, or some point near the centre of the array for connected element interferometers

²The real (non-complex) correlator described in Chapter 3 did not require the second signal to be conjugated in order to calculate the correlation function, for the obvious reason that all signals were real

by substituting the spectral representation for $A(t)$ into the expression for $\gamma_{pq}(\tau)$ as shown:

$$\begin{aligned}\gamma_{pq}(\tau) &= \langle A(t + \tau_g)A^*(t) \rangle \\ &= \left\langle \int_{-\infty}^{\infty} \int_{-\infty}^{\infty} s_p(\nu)s_q^*(\nu')e^{i2\pi[(\nu-\nu')t+\nu\tau_g]}d\nu d\nu' \right\rangle \\ &= \int_{-\infty}^{\infty} S_{pq}(\nu)e^{i2\pi\nu\tau_g}d\nu\end{aligned}\quad (4.4)$$

where $S_{pq}(\nu) = s_p(\nu)s_q^*(\nu)$ is the cross-power spectrum of $A(t)$, and can now be shown to be simply the Fourier transform of the covariance function:

$$S_{pq}(\nu) = \int_{-\infty}^{\infty} \gamma_{pq}(\tau)e^{-i2\pi\nu\tau}d\tau\quad (4.5)$$

Thus, in order to obtain the term $S_{pq}(\nu)$, which is the desired visibility term, a realistic correlator must convert the time domain signal to the frequency domain and account for the changing geometric delay τ_g and other practicalities such as frequency downconversion and sampling – in effect, compensating for the phasor term $e^{i2\pi\nu\tau_g}$. These steps are detailed in the following sections, assuming station-based corrections. Station-based removal of the phasor fringe term is generally only computationally feasible in an FX-style correlator architecture, as explained in Section 4.2.1.

4.1.2 Baseband conversion and sampling

Despite continual improvements in digital electronics which have produced cheaply available, high-speed (multi-Gsample s^{-1}) digital samplers, some form of frequency downconversion is ubiquitous in all arrays, with the exception of dedicated low-frequency instruments. For observations at wavelengths of several cm and shorter, this situation is unlikely to change in the near future. Typically, frequency conversion is a multi-stage process, utilising broad front-end filters, sharp intermediate-frequency (IF) filters and potentially digital filtering after sampling. The mathematical treatment below assumes a single conversion step directly to baseband, which is unrealistic but mathematically convenient. For an in-depth discussion of frequency conversion systems, see Thompson et al. (1994).

The application of a real, single sideband mixer with frequency ν_0 to the received signal $E(t)$ from Equation 4.1 yields the following signal:

$$V_p'(t + \tau_p) = E_p(t + \tau_p) \times \cos 2\pi\nu_0 t = \frac{A(t + \tau_p)}{2} \left[e^{i2\pi\nu_0 t} + e^{i2\pi\nu_0(2t + \tau_p)} \right]\quad (4.6)$$

The application of a low-pass filter removes the high-frequency term from Equation 4.6. At this point, it should be noted that in a connected element interferometer with a common clock, the phase of the downconversion signal can be varied continuously to compensate for the changing geometric phase (effectively replacing the oscillator signal $e^{i2\pi\nu_0 t}$ with $e^{i2\pi\nu_0(t-\tau_p)}$). This renders the fringe-rotation and fractional sample corrections detailed in Section 4.1.3 unnecessary. However, as this approach is not presently implemented on major VLBI arrays, the following analysis will assume that no phase compensation has been performed at the downconversion stage.

After frequency downconversion, the resultant bandlimited, baseband signal $V_p(t)$ is sampled. Since the process $A(t)$ is bandlimited with bandwidth B , the sampling interval must be no longer than $\Delta t = 1/2B$ in order to prevent aliasing of the sampled spectrum. Quantisation can be as coarse as 1 bit, although 2 bits has been widely used and newer instruments have tended to push towards higher precision in order to mitigate the effects of RFI, and obtain higher spectral dynamic ranges for spectral line observations. At the low bit precision typically used, the sampling function \mathcal{S} is typically non-linear, allowing an optimum placement of levels given the Gaussian distribution of V . The sampled signal $R_p(n)$ can then be written as:

$$R_p(n) = \mathcal{S}[V_p(t = n\Delta t)] \quad (4.7)$$

For the sake of clarity, the following discussion of geometric compensation will use the continuous notation for the baseband time series V_t , and the limitations placed by the sampling process will be highlighted where appropriate.

4.1.3 Geometric compensation and channelisation

In order to form the correct correlation between the array antennas, the geometric delay τ_p for each antenna must be removed. Initially, this is implemented as an integer-sample shift of the sampled signal $R_p(n)$ by N samples, where N is the rounded integer value of $\tau_p/\Delta t$. The shifted baseband signal is thus $V_p(t + \tau_p - n\Delta t) = A(t + \tau_p - n\Delta t)e^{i2\pi\nu_0\tau_p}$. Since the integer-sample shift cannot exactly compensate for the geometric delay τ_p , a “fractional-sample” error $\epsilon_p = \tau_p - n\Delta t$ remains at this point. A diagram of the sampled signal $R_p(n)$ which illustrates the geometric delay τ_p , the integer-sample delay $N\Delta t$ and the fractional-sample error ϵ_p for an antenna p at a given time is shown in Figure 4.1.

The compensation of the fringe phasor $e^{i2\pi\nu_0\tau_p}$ can now be performed. This step is generally referred to as *fringe rotation*. Conceptually this is simply applied as a complex

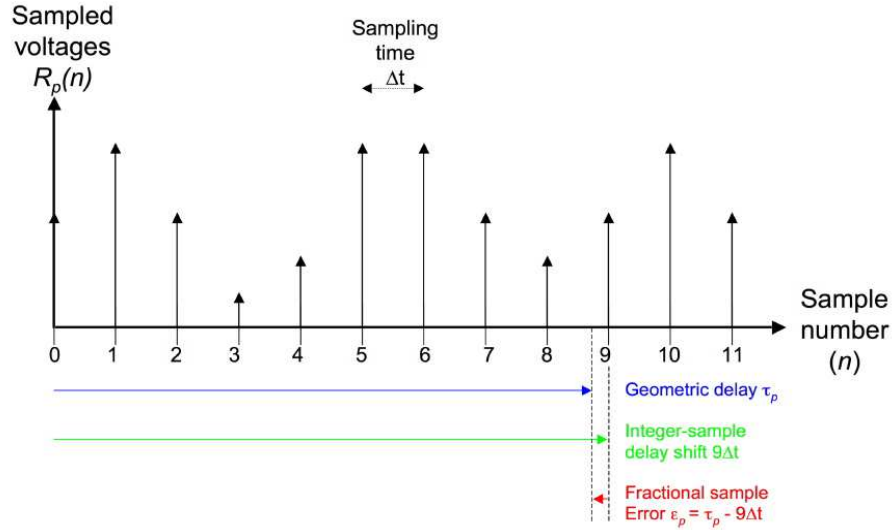

Figure 4.1 Geometric delay for a sampled signal $R_p(n)$ for an antenna p at a given instant of time. The exact geometric delay τ_p is shown in blue. The nearest integer-sample delay (shown in green) can be compensated by shifting the sampled datastream, leaving a fractional sample error ϵ_p (shown in red).

multiplication to V_p by the function $e^{-i2\pi\nu_0\tau_p}$, yielding the fringe-rotated, shifted base-band signal $V_p(t + \epsilon_p)e^{-i2\pi\nu_0\tau_p} = A(t + \epsilon_p)$, which is complex-valued. An alternative to a complex multiplication is to implement the multiplication with separate real-valued cosine and sine components. This ensures that the signal remains real-valued and allows the use of real-valued Fourier transformations. The “cosine” and “sine” arms of the correlator are then combined after Fourier transformation by applying a Hilbert transform to the sine arm before addition. For an example of this form of implementation of a complex correlator, see Thompson et al. (1994).

The shifted, fringe-rotated signal may now be transformed into the frequency domain as shown:

$$\mathcal{F}\{A(t + \epsilon_p)\} = s_\nu e^{i2\pi\nu\epsilon_p} \quad (4.8)$$

In practice, this step is implemented using a Fast Frequency Transform (FFT; Cooley and Tukey, 1965). This imposes a segmentation upon the data, since the FFT windows the time domain data with a window size equal to twice the desired number of spectral points.

The final geometric compensation step is the removal of the phase gradient generated by the presence of fractional sample error. Since the maximum magnitude of ϵ is half the sampling time ($1/(4B)$ seconds), the phase induced at the upper edge of the band ($\nu = B$) can range between $-\pi$ to π . Fractional sample correction is implemented as a

Table 4.1. Maximum decorrelation incurred due to “Post-F” fringe rotation

| Observation | Maximum baseline (km) | Frequency (MHz) | Spectral points per 16 MHz band | Maximum decorrelation (%) |
|-------------------------------|-----------------------|-----------------|---------------------------------|---------------------------|
| LBA low frequency continuum | 1400 | 1600 | 128 | 0.003 |
| LBA high frequency continuum | 1700 | 8400 | 128 | 0.13 |
| VLBA low frequency continuum | 8600 | 1600 | 128 | 0.12 |
| VLBA high frequency continuum | 8600 | 22200 | 128 | 21.1 |
| LBA water masers | 1700 | 22200 | 1024 | 47.6 |

complex multiplication of the frequency–domain data. After fractional sample correction, the spectral representation of the original signal $s(\nu)$ has been recovered exactly.

Finally, it is important to note at this point that realistic correlators approximate the true geometric delay function τ_p over short time intervals by a polynomial expansion. Over a the time duration of a single FFT window (typically microseconds, for bandwidths $B \sim \text{MHz}$ and spectral points $n \sim \text{hundreds}$), this can be (and usually is) approximated by a linear expansion. If the difference in fringe phase across an FFT window $\delta\phi = 2\pi\nu_0(\tau_p(t_1) - \tau_p(t_1 + 2n\Delta t))$ is small, the fringe term may be approximated by a constant over the entire FFT window. Since the Fourier transform is a linear transformation, this single complex factor then may equivalently be applied after the FFT, rather than to every individual sample before the FFT. In practice, this allows the fringe rotation operation to be merged with the fractional sample correction. “Post-F” fringe rotation allows a considerable saving in computational load, since for every FFT window it removes the need for $2n$ multiplications and $2n$ trigonometric operations, at the cost of n complex additions and one trigonometric operation. However, if the FFT window is long (high spectral resolution) and/or the fringe rate is very high (high frequencies and/or long baselines), the change in fringe phase over an FFT window may incur an unacceptable amount of decorrelation. The decorrelation can be calculated as $\text{sinc}(\delta\phi/2)$. Table 4.1 shows the maximum decorrelation which would be incurred through the use of post-F fringe rotation for some typical observations.

4.1.4 Cross–multiplication and accumulation

After each station has been individually delayed, fringe–rotated and corrected for fractional sample error, the desired visibility term $S_{pq}(\nu)$ can be obtained through a complex multiplication of the corrected baseband station data, after conjugating the second data stream:

$$S_{pq}(\nu) = s_p(\nu)s_q^*(\nu) \quad (4.9)$$

This is repeated for all baselines, and the result is accumulated for a desired time interval, typically seconds for narrow-field VLBI. If $p = q$, the result is an autocorrelation, which is necessarily real-valued. At the end of each integration period, the visibility data is normalised and stored. The normalisation can be performed in an a priori manner (in theory it is dependent only upon the integration time, since the normalised autocorrelations should tend to unity), but quantisation threshold errors make corrections based on the measured autocorrelation necessary. The corrections can be calculated and applied at correlation time, or in later processing.

4.2 Correlator implementations

4.2.1 FX vs XF correlators

As shown above, it is possible (and mathematically simplest) to form the visibility output of a correlator by Fourier transforming the station data, and then cross-multiplying the corrected data streams. This approach of channelisation (F) followed by cross-multiplication (X) is known as an FX-style correlator. Through the Fourier duality between convolution and multiplication, it is easy to see that another possible implementation of a correlator would be to form the convolution of the time series for each baseline and Fourier transform the result. This is the so-called XF style of correlator.

Until relatively recently, all correlators have been implemented as XF correlators – the FX concept was first implemented by Chikada et al. (1987). As the correlator developed for this thesis is of the FX type, details of the implementation of an XF-style correlator will not be given here – the interested reader is directed to Romney (1999) and references therein. However, some of the functional differences between XF and FX correlators are:

1. In an XF correlator, it is possible (indeed, necessary, to make the design computationally viable) to accumulate the lag values and perform a single Fourier transform on the accumulated lags before storing the visibilities.
2. XF correlators can operate at much lower precision than FX correlators and can generally make use of optimised, low-precision integer arithmetic. The presence of a Fourier transformation before accumulation (and the use of station-based fringe rotation) means that an FX-style correlator requires higher precision operations, although the FX architecture requires less operations overall. The use of low-precision operations (including fringe rotation) is generally necessary to make the architecture viable.

3. Due to the accumulation performed before transformation to the frequency domain, the fractional sample error cannot generally be approximated by a constant in an XF correlator, which means that correction of fractional sample error in the frequency domain in a station-based manner is not possible³. The usual alternative employed by XF correlators is baseline-based alignment of data, fringe rotation and fractional sample correction. This allows alignment of the data streams to within half a sample, as opposed to one sample with station based alignment, which when coupled with coordinated fringe rotation allows minimal decorrelation due to fractional sample errors (see Romney 1999 for details). Low precision fringe rotation (which cannot be employed in station-based fringe rotation due to the possible of spurious correlation between harmonics of the fringe function) can also be used in this approach for higher efficiency.

4.2.2 Hardware platforms

Both XF- and FX-style correlators have traditionally been highly application-specific devices, based on purpose-built integrated circuits (Application Specific Integrated Circuits – ASICs). In the last 20 years, Field Programmable Gate Arrays (FPGAs) have become popular components in correlator designs, with one prominent example being the Very Long Baseline Array (VLBA) correlator (Napier et al., 1994). FPGAs are reconfigurable or reprogrammable devices that offer more flexibility than application-specific integrated circuits (ASICs) while still being highly efficient. However, FPGAs still require a greater familiarity with the underlying hardware than coding on a general purpose CPU, and configurations can be specific to the particular FPGA, limiting portability. Throughout the remainder of this thesis, correlators based on ASICs and/or FPGAs will be referred to simply as “hardware correlators”. Modern VLBI hardware correlators include the NRAO Very Long Baseline Array correlator (Napier et al., 1994); the Joint Institute for VLBI in Europe (JIVE) correlator (Casse, 1999); the Canadian NRC S2 correlator (Carlson et al., 1999); the Japanese VLBI Space Observatory Programme (VSOP) correlator (Horiuchi et al., 2000); and the Australia Telescope National Facility (ATNF) S2 correlator (Wilson et al., 1996)

Generally speaking, hardware correlators allow the most efficient design possible, by tailoring the hardware to the processing required. However, this efficiency comes with two drawbacks – the design of the correlator incurs large Non-Recurring Engineering (NRE)

³Frequency domain fractional sample correction could be performed by shortening the accumulation time, or the equivalent fractional sample correction could be performed in the time domain via a convolution, but neither approach is generally computationally viable

costs, and upgrading or altering the completed correlator is difficult (although this second point is mitigated somewhat in FPGA-based correlators).

An alternative to a hardware correlator is to implement the correlation algorithm in a programming language such as C or C++, and run the correlation program in a generic multi-processor computing environment. Such a system will be hereafter referred to as a “software correlator”. The first VLBI correlators of the 1960’s were implemented in software (Bare et al., 1967; Moran et al., 1967), but data processing requirements soon outgrew the capabilities of existing mainframe computers, and dedicated hardware systems were quickly developed. In recent years, the pace of advances in commodity computing hardware have begun to outstrip the demand increases of VLBI data processing, and software correlators have again become economically feasible. The first modern, high data-rate software correlator was developed for VLBI by the Communications Research Laboratory (CRL) in Japan in the late 1990s (Kondo et al., 2004). Specialist software correlators have also been developed for purposes such as processing VLBI observations of spacecraft, which were used to track the Huygens probe as it entered the atmosphere of Titan (Avruch et al., 2006).

Compared to a hardware correlator, a software correlator offers several advantages: chiefly the ease and speed of development (minimising NRE), the adaptability of the system, and the flexibility of making alterations after the correlator has been deployed. The correlation algorithm is “embarrassingly parallel” and very well suited to commodity parallel computing architectures, such as Beowulf clusters with Gigabit ethernet interconnect.

Despite their obvious advantages in flexibility, by the mid-2000’s no software correlators had yet been developed which were compatible with all the major VLBI formats currently used world-wide. As discussed in Chapter 1, at this time the LBA was completing an upgrade which would provide the increased sensitivity necessary to undertake the pulsar astrometry program planned for this thesis, but which required a new correlator. Accordingly, a completely new, general-purpose software correlator was developed as part of this thesis. The primary goal of this correlator was to enable the LBA to undertake high-sensitivity observations and improve operational flexibility, but a secondary aim was for the correlator to be usable for VLBI (and indeed connected element interferometry) by many groups worldwide. The resultant “DiFX” software correlator is described in Section 4.3 below, and its testing and verification are described in Section 4.4. Performance benchmarking of the DiFX code is described in Section 4.5, and some of the additional applications it has enabled, beyond the pulsar astrometry of this thesis project, are described in Section 4.6.

4.3 DiFX

DiFX (Distributed FX) is the name given to a code project encompassing a FX-style correlator (`mpifxcorr`) implemented in C++ and utilising message passing conforming to the Message Passing Implementation (MPI⁴) standard, as well as related functionalities such as geometric model generation (`gencalc_delays`), a graphical front-end (DiFXGUI) and various data and visibility inspection tools and plug-in packages. The DiFX package can be downloaded from <http://astronomy.swin.edu.au/~adeller/software/difx/>.

DiFX requires an operating environment with a functional installation of MPI, and an implementation of a vector library. It was originally developed on an Intel cluster and by default makes use of the Intel Performance Primitives (IPP⁵) library for vector calculations. The IPP library is optimised for modern 32 and 64 bit CPU architectures and allows code acceleration of up to an order of magnitude compared to unoptimised code. It can run on any Intel or AMD CPU, but will only dispatch optimised code on Intel CPUs. An equivalent AMD library, the AMD Performance Library (APL⁶) is now available, but has not been tested.

4.3.1 The DiFX code

Figure 4.2 shows the high-level class structure of DiFX, along with the data flow. The correlation is managed by a master node (`FxManager`), which instructs data management nodes (`Datastream`) to send time ranges of baseband data to processing nodes (`Core`). The data are then processed by the `Core` nodes, and the results sent back to the `FxManager`. Double buffered, non-blocking communication is used to avoid latency delays and maximise throughput. Both the `Datastream` and `Core` classes can be (and have been) extended to allow maximum code re-use when handling different data formats and processing algorithms. The `Core` nodes make use of an allocatable number of threads to maximise performance on a heterogenous cluster.

The `Datastream` nodes can read the baseband data into their memory buffers from a local disk, a network disk or a network socket. Once the data are loaded into the `datastream` buffer, the remainder of the system is unaware of its origin. This is one of the most powerful aspects of this correlator architecture, meaning the same correlator can easily be used for disk-based VLBI correlation and real-time eVLBI, where the data is transmitted in real time from the telescopes to the correlator over optical fibre. The use

⁴<http://www-unix.mcs.anl.gov/mpi/>

⁵<http://www.intel.com/cd/software/products/asm-na/eng/perflib/ipp/index.htm>

⁶http://developer.amd.com/apl_help/aa_000_frames.html

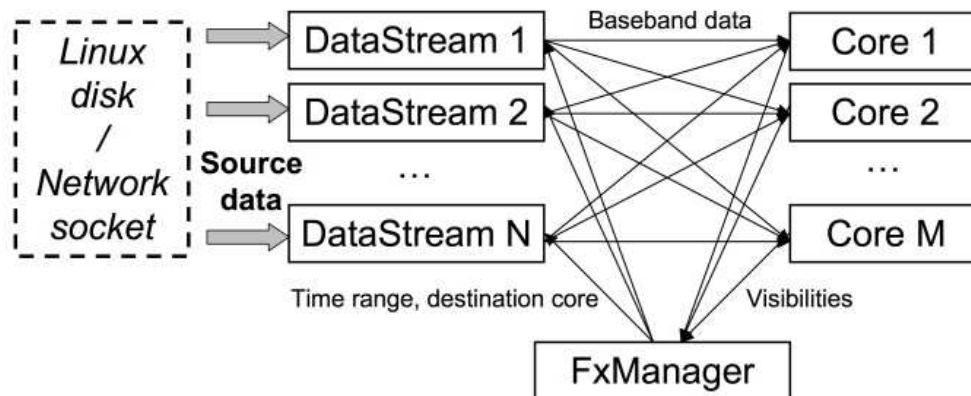

Figure 4.2 Overview of the software correlator architecture. Data is loaded into memory from a disk or network connection by Datastream nodes. These nodes are directed by a Master node to send data from given time ranges (typically several ms) to the processing elements (Core nodes). The processed data are sent to the master node for long-term accumulation and storage on disk.

of DiFX for eVLBI is discussed further in Section 4.6.1.

The implementation of the antenna- and baseline-based operations described in Section 4.1 that are necessary to form the visibility output of DiFX is described below. The additional processing required in the case of pulsar observations is also discussed.

4.3.2 Antenna-based operations

Alignment of telescope data streams

To correlate data from a number of different telescopes, the changing delays between those telescopes must be calculated and used to align the recorded data streams at a predetermined point in space (in this case the geocentre) throughout the experiment.

DiFX uses CALC 9⁷ to generate a geometric delay model $\tau_g(t)$ for each telescope in a given observation, at regular intervals (usually 1 second). CALC models many geometric effects, including precession, nutation, ocean and atmospheric loading, and is used by many VLBI correlators including the VLBA and EVN correlators. These delays are then interpolated (using a quadratic approximation) to produce accurate delays ($\Delta\tau < 1 \times 10^{-15}$ seconds, compared to an exact CALC value) in double precision for any time during the course of the observation. The estimated station clock offsets and rates are added to the CALC-generated geometric delays.

⁷<http://gemini.gsfc.nasa.gov/solve>

The baseband data for each telescope are loaded into large buffers in memory, and the interpolated delay model is used to calculate the accurate delay between each telescope and the centre of the Earth at any given time during the experiment. This delay, rounded to the nearest sample, is the integer sample delay. The difference between the delay and the integer sample delay is recorded as the antenna based fractional sample delay (up to ± 0.5 sample). Note that the alignment of any two data streams (as opposed to a data stream alignment with the geocentre) is accurate to ± 1 sample.

The integer-sample delay is used to offset the data pointer in memory and select the data to be correlated (some number of samples which is an integer number of FFT windows, starting from the time of alignment). The fractional sample error is retained to correct the phase as a function of frequency following alignment to within one sample, fringe rotation, and channelisation (Section 4.3.2).

Once the baseband data for each telescope have been selected, they are transferred to a processing node (“Core”) using a non-blocking MPI send, and unpacked from the coarsely quantised representation (usually a 2-bit representation) to a floating point (single precision) representation. Presently supported VLBI formats include the Australian standard LBADR (Phillips et al., in preparation), Mark5A and Mark5B (Whitney, 2003), and the Japanese format K5 (Koyama et al., 2004). If supported by the baseband format, missing or corrupted data is detected during the unpacking, and a count of valid samples is maintained. Ancillary data such as the sampled geometric delays at the beginning of each FFT window are also transferred (in double precision). From this point on, all operations in the correlator are performed using floating point arithmetic, in single precision unless otherwise specified. Note that the data volume is expanded by a factor of 16 at this point. The choice of single precision floats (roughly double the precision necessary) was dictated by the capabilities of modern CPUs, which process single-precision floating point numbers efficiently. Using sufficient precision also avoids the small decorrelation losses incurred by optimised, low precision operations often used in hardware correlators. This is a good example of the sacrifice of efficiency for simplicity and accuracy with a software correlator.

At this point all data streams from all telescopes are aligned to within ± 1 sample of each other and the fractional sample errors for each of the telescope data streams are recorded for later use. A set number of samples from each telescope data stream have been selected and are awaiting unpacking and processing on a “Core” node (e.g. a PC in a Beowulf cluster).

Fringe rotation

As shown in Section 4.1.3, for “pre-F” fringe rotation, the necessary complex fringe rotation function is assembled for each time sample by taking the sine and cosine of the geocentric delay multiplied by the sky frequency ν_0 in a vector operation; it is applied via a vector complex multiplication for each telescope’s data stream. The geometric delay at each time sample is obtained by interpolation between values supplied for the start and end of each FFT segment.

Since the baseband data have already been unpacked to a floating point representation by this stage, a floating point fringe rotation is applied which yields no fringe rotation losses, compared, for example, to a 6.25% loss of signal to noise for three level digital fringe rotation in a two level complex correlator (Roberts, 1997).

Implemented as such, fringe rotation represents a mixing operation and will result in a phase difference term which is quasi-stationary at zero phase (the desired term) and a phase sum term which has a phase rate of twice the fringe rotation function, $\sim 4\pi\nu_0\tau(t)$. The sum term vector averages to a (normally) negligible contribution to the correlator; for typical VLBI fringe rates (100s of kHz) and integration times (seconds) the relative magnitude of the unwanted contribution to each visibility point is $< 10^{-5}$. In a software correlator it would be simple to control the integration time so that the rapidly varying phase term is integrated over exactly an integral number of terms of phase, thus making no contribution to the correlator output. This feature is not currently implemented in DiFX.

As noted in Section 4.1.3, an alternative method of fringe rotation for sufficiently low fringe rates is to apply a single correction per FFT window (“post-F” fringe rotation). In this case, no modulation is applied to the time domain data, but a single fringe-rotation value (appropriate for the midpoint of the FFT window) is calculated and retained for application during fractional-sampled correction. Post-F fringe rotation is desirable in situations where the fringe rate is extremely low, when the double-frequency term introduced by the mixing operation of pre-F fringe rotation is not effectively averaged to zero over the course of an integration and makes a significant and undesirable contribution to the correlator output. Switching from pre-F to post-F fringe rotation would be beneficial for periods of time in most experiments when the source traverses periods of low phase rate. Sources near a celestial pole can have very low fringe rates for long periods of time. Alternatively, if very short correlator integration times are used, the sum term may not integrate to zero when using pre-F fringe rotation. Post-F fringe rotation would therefore be a natural choice in these circumstances.

It should be noted that it is possible to undertake the exact equivalent to pre-F fringe rotation in the frequency domain. However, this would involve the Fourier transform of the fringe rotation function and a convolution in the frequency domain, which is at least as computationally intensive as the complex multiplication of the data and fringe rotation in the time domain.

DiFX implements pre-F or post-F fringe rotation as a user controlled option.

Channelisation and fractional sample error correction

Once the data are aligned (and phase corrected, if pre-F fringe rotation is used), the time series data are converted into frequency series data (channelised), prior to cross multiplication.

Channelisation of the data can be accomplished using an FFT. If pre-F fringe rotation has been applied, the data are already in complex form, and so a complex-to-complex FFT is used. The positive or negative frequencies are selected in the case of upper or lower sideband data respectively. If post-F fringe rotation is to be applied, the data are still real and so a more efficient real-to-complex FFT may be used. This is possible due to the conjugate symmetry property of an FFT of a real data series. In this case, lower sideband data may be recovered by reversing and conjugating the resultant channels.

The final station-based operation is fractional-sample correction. The fractional sample error is assumed not to vary over the FFT window, which is equivalent to the assumption made for post-F fringe rotation, but is considerably less stringent since the phase change is proportional to the bandwidth, rather than sky frequency as in the case of fringe rotation. As shown in Section 4.1.3, the frequency domain correction manifests itself as a slope in the phase as a function of frequency across the observed bandwidth.

Thus, after channelisation, a further vector complex multiplication is applied to the channels, correcting the fractional sample error. In the case of post-F fringe rotation, the saved fringe rotation value is added to the fractional-sample correction for each frequency channel and the two steps are performed together.

4.3.3 Baseline-based operations

Cross multiplication of telescope data streams

For each selected baseline, the channelised, compensated data from the telescope pair are cross-multiplied on a channel by channel basis (after forming the complex conjugate for the channelised data from one telescope), using a complex vector multiplication, to

yield the frequency domain complex visibilities that are the fundamental observables of an interferometer. This is repeated for each selected band/polarisation on each selected baseline. If dual polarisations have been recorded for any given band, the cross-polarisation terms can also be multiplied, recovering polarisation information for the target source.

Integration of correlated output

Once the above cycle of operations has been completed, it is repeated and the resulting visibilities accumulated (complex added) until a set accumulation time has been reached. Generally, on each cycle the input time increment is equal to the corresponding FFT length (twice the number of spectral points), but it is also possible to overlap FFTs. This allows more measurements of higher lags and greater sensitivity to spectral line observations, at the cost of increased computation. At the Core node, this “Short Term Accumulation” (STA) is equal to the number of FFT windows sent by the Datastream nodes. The STA results are then returned to the FxManager via a non-blocking MPI send, along with ancillary information such as the number of “good” samples for each baseline. The desired number of STA results are then accumulated at the FxManager node to reach the desired integration time.

Calibration for nominal telescope T_{sys}

Cross multiplication, accumulation and normalisation gives the complex cross power spectrum for each baseline, representing the correlated fraction of the geometric mean of the powers detected at each telescope. To obtain the correlated power in units of Jy, the cross power spectra (amplitude components) should be scaled by the geometric mean of the powers received at each telescope measured in Jy i.e. the T_{sys} in Jy routinely measured at each antenna. Since the autocorrelation spectra are calculated concurrently with the cross-correlation spectra, this correction can be made within the correlator, before writing the visibilities to disk. Calibration is applied with a vector multiplication to each array of visibility spectra. Alternatively, the cross-correlation spectra can be simply be normalised by the number of contributing samples, and the calibration of the data can be completed offline, once measured, rather than a priori, T_{sys} information is available. The application of normalisation or a priori system calibration is a user selectable option in DiFX.

When the T_{sys} for each telescope is applied to calibrate the visibilities, it is also necessary to apply a scaling factor to compensate for decorrelation due to the coarse quantisation. This corrects the visibility amplitudes, but of course cannot recover the lost signal to noise. For the 2-bit data typically processed, this scaling factor is 1/0.88 in the

low-correlation limit (Cooper, 1970). The relationship becomes non-linear at high correlation and the scaling factor approaches unity as the correlation coefficient approaches unity. When applied on-line at the correlator, the low-correlation regime is assumed, and a correction for high-correlation cases can be applied in post-processing if necessary.

Export of visibility data

Once an accumulation interval has been reached, the visibilities must be stored in a useful format. DiFX can produce RPFITS⁸ format data, or an intermediate binary format which can be translated offline into FITS-IDI⁹. RPFITS and FITS-IDI files can be loaded into analysis packages such as AIPS¹⁰, CASA¹¹, or MIRIAD¹² for data reduction. Ancillary information is included in the FITS file along with the complex visibilities, time stamps, and (u,v,w) coordinates. Presently, only FITS-IDI output supports the storage of visibility weights, which are adjusted based on the count of “good” samples detected in the unpacking process.

4.3.4 Special processing operations: pulsar binning

As discussed in Chapter 2, pulsed signals are dispersed as they travel through the interstellar medium (ISM), resulting in a smearing of the pulse arrival time in frequency. In order to correct for the dispersive effects of the ISM, DiFX employs incoherent dedispersion (Voûte et al., 2002). This allows the visibilities generated by the correlator to be divided into pulse phase bins. Unlike hardware correlators which typically allow only a single on/off bin, or else employ 2^N bins of fixed width, DiFX allows an arbitrary number of bins placed at arbitrary phase intervals. The individual bins can be written out separately in the FITS file format to enable investigation of pulse phase dependent effects, or can be filtered within the correlator to maximise signal to noise, based on a priori pulse profile information.

To calculate which phase bin a visibility at a given frequency and time corresponds to, the software correlator requires information on the pulsar’s ephemeris, which is supplied in the form of one or more “polyc” files containing a polynomial description of apparent pulse phase as a function of time. These are generated using the pulsar analysis program TEMPO¹³, and require prior timing of a pulsar. Additional software has been produced

⁸<http://www.atnf.csiro.au/computing/software/rpfits.html>

⁹<http://www.aoc.nrao.edu/aips/FITS-IDI.html>

¹⁰<http://www.aoc.nrao.edu/aips>

¹¹<http://casa.nrao.edu/>

¹²<http://www.atnf.csiro.au/computing/software/miriad>

¹³http://pulsar.princeton.edu/tempo/reference_manual.html

to verify the pulsar timing by using the generated polyco files and the baseband data from an experiment, allowing phase bins to be accurately set before correlation.

For VLBI observations of pulsars, it is usually desirable to maximise the signal to noise of the observations by binning the visibilities based on the pulse phase, and applying a filter to the binned output based on the signal strength in that phase. Typically this filter is implemented as a binary on/off for each phase bin. Using the pulse profile generated from the baseband data of an observation, however, DiFX allows a user-specified number of bins to be generated and a filter applied based on pulse strength \times bin width, allowing the maximum theoretical retrieval of signal, as described below. This also reduces the output data volume, since only an “integrated on-pulse” visibility is retained, rather than potentially many phase bins.

Consider observing a single pulse, divided into M equally spaced phase bins. Let the pulsar signal strength as a function of phase bin be $S(m)$, and the noise in single phase bin be $Z \times \sqrt{M}$, where Z is the baseline sensitivity for an integration time of a single pulse period. When all bins are summed (effectively no binning), the S/N ratio will be:

$$\frac{\sum_{m=0}^M S(m)}{Z} \quad (4.10)$$

as the signal adds coherently while the noise adds in quadrature. For a simple on/off gate accepting only bins m_1 to m_2 , the S/N ratio will be:

$$\frac{\sum_{m=m_1}^{m_2} S(m)}{\sqrt{\sum_{m=m_1}^{m_2} (Z \times \sqrt{M})^2}} \quad (4.11)$$

Finally, for the case where each bin is weighted by the pulse signal strength in that bin, the S/N ratio will be:

$$\frac{\sum_{m=0}^M (S(m))^2}{\sqrt{\sum_{m=0}^M (S(m) \times Z \times \sqrt{M})^2}} \quad (4.12)$$

For a Gaussian shaped pulse, this allows a modest improvement in recovered signal to noise of 6% compared to an optimally placed single on/off bin. On a more complicated profile, such as a Gaussian main pulse with a Gaussian interpulse at half the amplitude, the improvement in recovered signal to noise increases to 21%. Throughout the remainder of this thesis, the term gate, when referring to a DiFX-correlated pulsar experiment, refers to a matched pulse filter in the sense described above.

4.3.5 Operating DiFX

DiFX is controlled via an interactive Graphical User Interface (GUI), which calls the various component programs and helper scripts. The primary purpose of the GUI is to facilitate easy editing of the text files which configure the correlator, run external programs such as the delay model generator, and provide feedback while a job is running. Two files are necessary to run the actual correlator program. The first is an experiment configuration file, containing tables of stations, frequency setups, etc, analogous to a typical hardware correlator job configuration script. The second file contains the list of compute nodes on which the correlator program will run.

While it is possible to run all tasks required to operate the correlator manually, in practise they are organised via the GUI. This consists of running a series of helper applications from the GUI to generate the necessary input for the correlator. These include a script to extract experiment information from the VLBI exchange (VEX) file used to configure and schedule the telescopes at observe time, a delay and (u,v,w) generator which makes use of CALC 9, and scripts to extract the current load of available nodes. Pulsar-specific information such as pulse profiles and bin settings can also be loaded. This information is presented via the GUI and adjustments to the configuration, such as selecting computational resources to be used, can be made before launching a correlation job.

In the future it is planned to incorporate some real-time feedback of amplitude, phase and lag information from the current correlation via the GUI. This would be similar to the visibility spectra displays available continuously at connected-element interferometers.

Alternative interfaces for configuring and launching DiFX have been developed by other users of the software, but are generally site-specific and interface to existing correlator control software. The foremost example of this approach is the VLBA, which is described in Section 4.6.2.

4.4 Deployment and verification

In order to verify that the DiFX correlator was functioning correctly, three separate comparisons were made against existing, well-verified hardware correlators. In each case, the comparison showed complete agreement once differences in correlator architecture were accounted for. These comparisons are detailed below.

4.4.1 Comparison to the LBA S2 correlator

Observations to provide data for a correlator comparison between DiFX and the ATNF S2 correlator were undertaken on March 12, 2006, with the following subset of the LBA: Parkes (64 m), ATCA (phased array of 5×22 m), Mopra (22 m), Hobart (26 m).

Data from these observations were recorded simultaneously to S2 tapes and the LBADR disks (Phillips et al. 2008, in preparation) during a 20 minute period, UT 02:30–02:50, corresponding to a scan on a bright quasar (PKS 0208–512). Two 16 MHz right circular polarisation (RCP) bands were recorded, in the frequency ranges 2252 – 2268 MHz and 2268 – 2284 MHz.

The data recorded on S2 tapes were shipped to the ATNF LBA S2 correlator (Wilson et al., 1996) at ATNF headquarters and processed. The S2 correlator is an XF-style hardware correlator. The data recorded to LBADR disks were shipped to the Swinburne University of Technology supercomputer and processed using the software correlator.

At both correlators identical T_{sys} values in Jy were specified for each antenna and applied in order to produce nominally calibrated visibility amplitudes, and both correlators used identical clock models, in the form of a single clock offset and linear rate as a function of time per antenna. The data were processed at each correlator using a two second integration time and 32 spectral channels across each 16 MHz band.

Different implementations of the CALC-based delay generation were used at each correlator, and thus small differences exist in the applied delay models, which leads to differences in the correlated visibility phase. These delay model differences were calculated and the phase due to differential delay model has been subtracted in the following discussion.

From both correlators, RPFITS format data were output and loaded into the MIRIAD software package (Sault et al., 1995) for inspection and analysis. The data from the two correlators are compared in Figures 4.3 – 4.5.

Figure 4.3 shows the visibility amplitudes for all baselines from both correlators as a function of time, over the period 02:36:00 – 02:45:00 UT, for one of the 16 MHz bands (2252 – 2268 MHz). These amplitudes represent the vector averaged data over the frequency channel range 10 – 21 (to avoid the edges of the band). The data for each baseline were fit to a first order polynomial model ($S(t) = \frac{dS}{dt}t + S_0$, where S is the flux density in Jy, t is the offset in seconds from UT 02:40:30, and S_0 is the extrapolated flux density at time UT 02:40:30, using a standard linear least squares routine. The root mean square (RMS) variation around the best fit model was calculated for each baseline. The fitted models are shown in Figure 4.3 and show no significant differences between the S2 correlator and the software correlator. Further, the calculated RMS for each baseline agrees very well

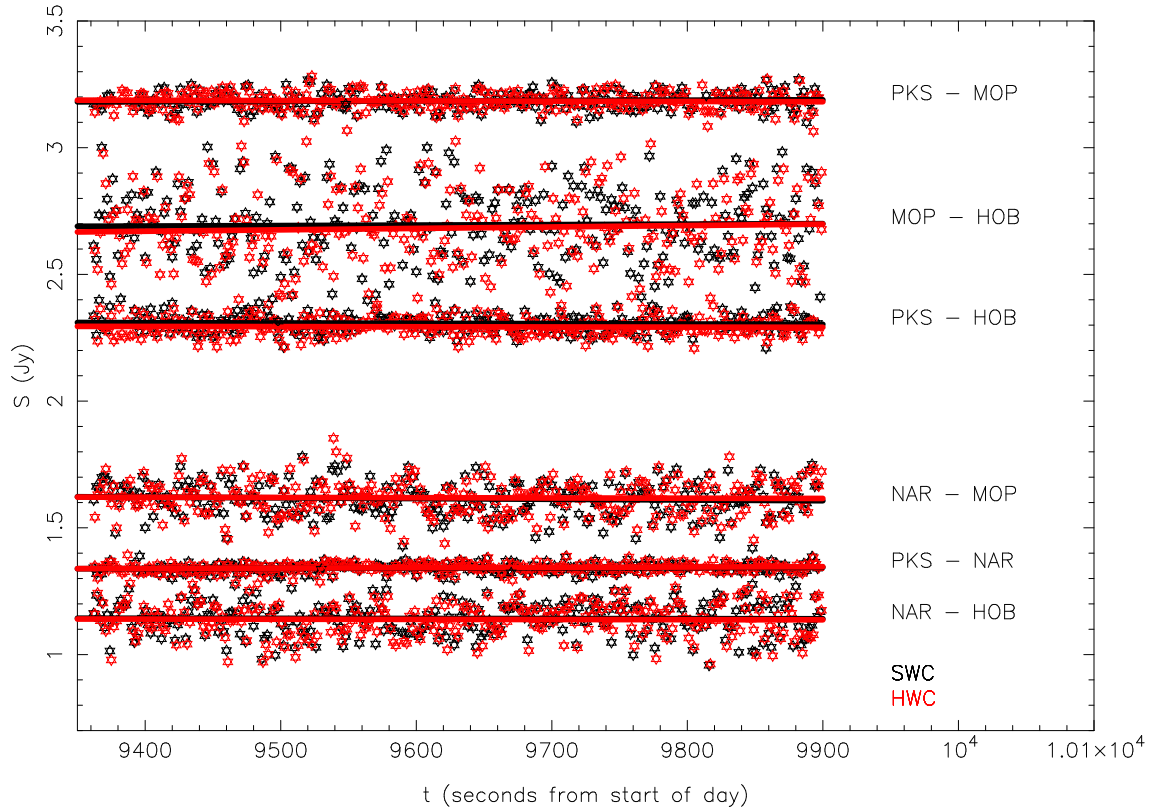

Figure 4.3 S2 (red) and DiFX (black) visibility amplitude vs time for the 2252 – 2268 MHz band on the source PKS 0208–512, as described in the text (PKS = Parkes; MOP = Mopra; HOB = Hobart; NAR = ATCA). Symbols represent the actual visibilities produced by the correlators, while the lines represent linear least-squares fits to the visibilities (one line per dataset).

between DiFX and the S2 correlator, as summarised in Table 4.2.

Figure 4.4 shows the visibility phase as a function of time for each of the six baselines in the array. Again the data represent the vector averaged correlator output over the frequency channel range 10 – 21 within the 2252 – 2268 MHz band. As discussed above, small differences between the delay models used at each correlator have been taken into account as part of this comparison.

Figure 4.5 shows a comparison of the visibility amplitudes and phases as a function of frequency in the 2252 – 2268 MHz band. The data represented here result from a vector average of the two datasets over a two minute time range, UT 02:40:00 – 02:42:00. Since the S2 correlator is an XF-style correlator, it cannot exactly correct fractional sample error in the same manner as an FX correlator such as DiFX, as the channelisation is performed after accumulation. The coarse (post-accumulation) fractional sample correction leads to decorrelation at all points except the band center, up to a maximum of $\sim 10\%$ at the band

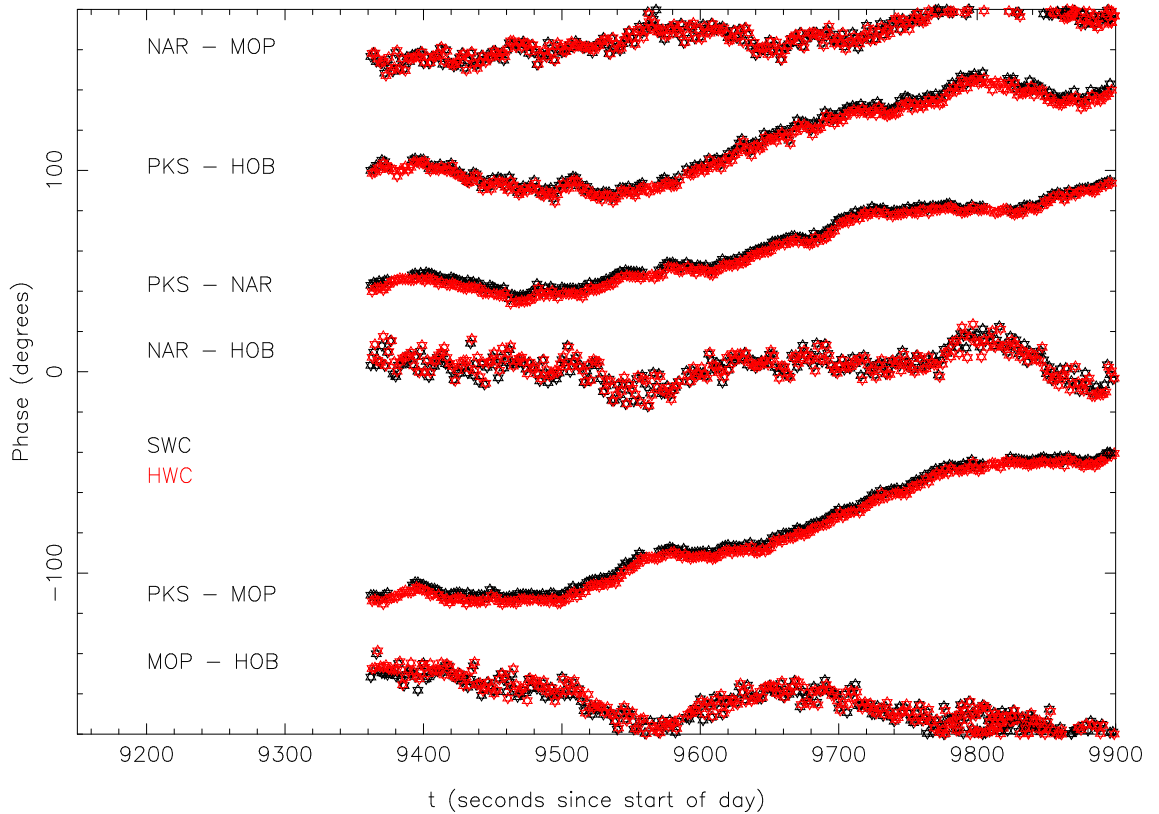

Figure 4.4 S2 (red) and DiFX (black) visibility phase vs time for the 2252 – 2268 MHz band on the source PKS 0208–512, as described in the text. Antenna labels are identical to Figure 4.3 above. The PKS-NAR baseline has been shifted by -50° for clarity.

Table 4.2. Linear fit parameters for visibility amplitude vs time for DiFX and the LBA S2 correlator, with 95% confidence limits

| Baseline | Offset _{DiFX} (Jy) | Offset _{LBA} (Jy) | Slope _{DiFX} ($\mu\text{Jy s}^{-1}$) | Slope _{LBA} ($\mu\text{Jy s}^{-1}$) |
|-----------|-----------------------------|----------------------------|---|--|
| PKS - NAR | 1.341 ± 0.030 | 1.343 ± 0.028 | 10 ± 13 | 14 ± 12 |
| PKS - MOP | 3.185 ± 0.058 | 3.185 ± 0.063 | 14 ± 24 | -11 ± 26 |
| PKS - HOB | 2.307 ± 0.058 | 2.293 ± 0.061 | -12 ± 24 | -6 ± 24 |
| NAR - MOP | 1.616 ± 0.109 | 1.619 ± 0.114 | -27 ± 43 | -10 ± 45 |
| NAR - HOB | 1.142 ± 0.111 | 1.139 ± 0.116 | -3 ± 44 | -5 ± 46 |
| MOP - HOB | 2.694 ± 0.256 | 2.681 ± 0.257 | 18 ± 101 | 56 ± 101 |

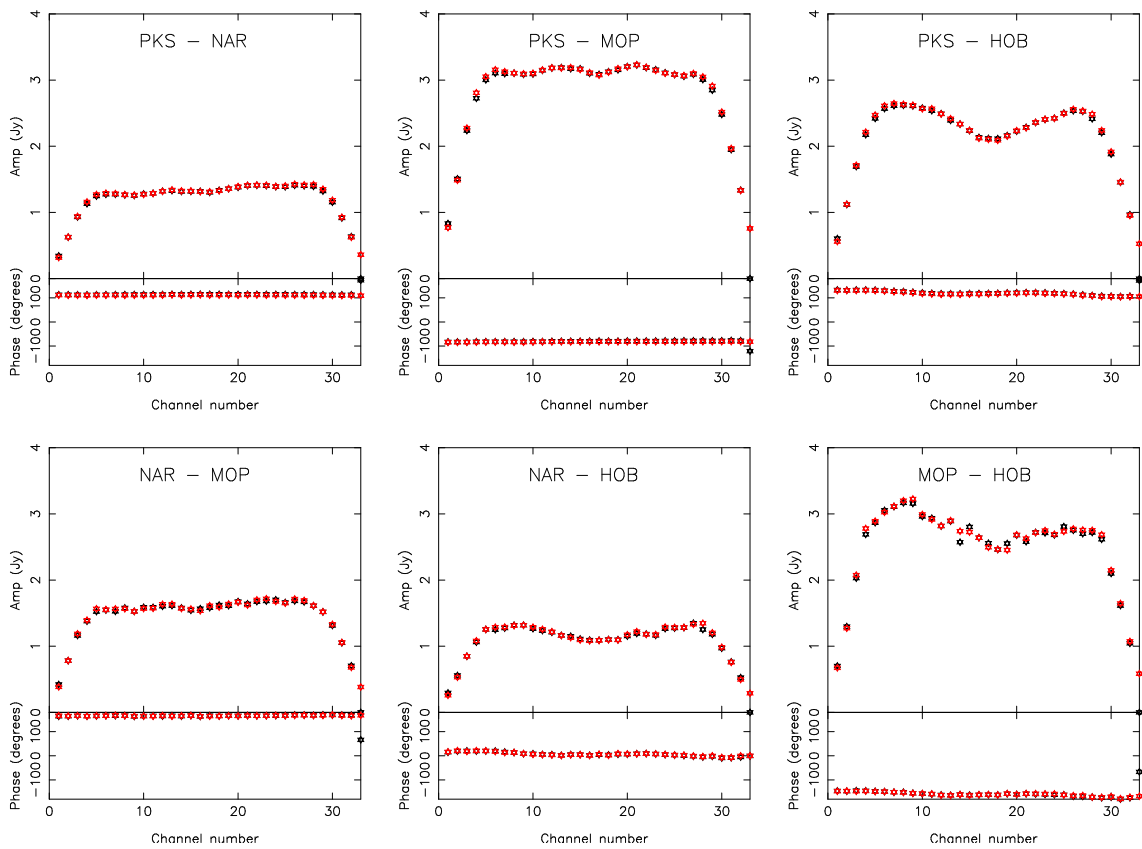

Figure 4.5 S2 (red) and DiFX (black) visibility amplitude and phase vs frequency data for the 2252 – 2268 MHz band on the source PKS 0208–512, as described in the text. Antenna labels are identical to Figure 4.3 above. The S2 data has been corrected for fractional-sample error decorrelation at the band edges as described in the text.

edges on long baselines where the geometric delay changes by a sample or more over an integration period. Compensation has been performed for this band edge decorrelation in the S2 correlator amplitudes shown in Figure 4.5.

4.4.2 Comparison to the VLBA correlator

Data obtained as part of a regular series of VLBA test observations were used as a basis for a correlator comparison between DiFX and the VLBA correlator, which is an FX-style hardware correlator (Napier et al., 1994). The observations were made on August 5, 2006 using the Brewster, Los Alamos, Mauna Kea, Owens Valley, Pie Town, and Saint Croix VLBA stations. One bit digitised data sampled at the Nyquist rate for four dual polarisation bands, each of 8 MHz bandwidth, were recorded using the Mk5 system (Whitney, 2003). The four bands were at centre frequencies of 2279.49, 2287.49, 2295.49, and 2303.49 MHz. The experiment code for the observations was MT628 and the source observed was 0923+392, a strong and compact active galactic nucleus. Approximately two minutes of data recorded in this way was used for the comparison.

The Mk5 data were correlated on the VLBA correlator and exported to FITS format files. The data were also shipped to the Swinburne supercomputer and correlated using DiFX, producing RPFITS format files. In both cases, no scaling of the correlated visibility amplitudes by the system temperatures were made at the correlators. The visibilities remained in the form of correlation coefficients for the purposes of the comparison – i.e. a system temperature of unity was used to scale the amplitudes. Each 8 MHz band was correlated with 64 spectral points, and an integration time of 2.048 seconds was used.

The VLBA correlator data were read into AIPS using FITLD with the parameter DIGICOR=1. The DIGICOR parameter is used to apply certain scalings to the visibility amplitudes for data from the VLBA correlator. Further, to obtain the most accurate scaling of the visibility amplitudes, the task ACCOR was used to correct for imperfect sampler thresholds, deriving corrections to the antenna-based amplitudes of $\sim 0.5\%$. These ACCOR corrections were applied to the data, which were then written to disk in FITS format.

The software correlator data were read directly into AIPS and then written to disk in the same FITS format as the VLBA correlator data. No corrections to amplitude or phase of the software correlated data were made in AIPS.

The VLBA correlator data and the software correlator data were both imported into MIRIAD for inspection and analysis, using the same software as used for the comparison with the LBA correlator described above. RCP from the 2283.49 – 2291.49 MHz band

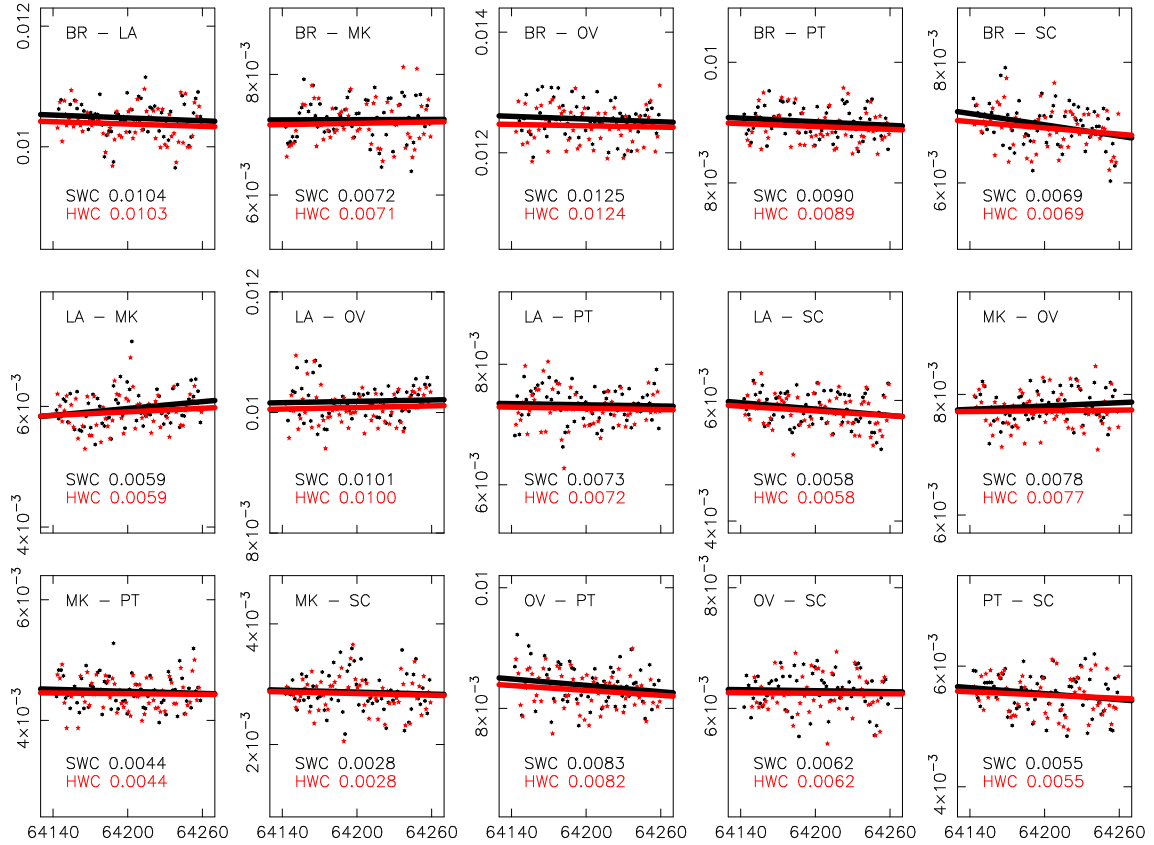

Figure 4.6 VLBA correlator (red) and DiFX (black) visibility amplitude vs time for the 2283.49 – 2291.49 RCP band from the VLBA test observation MT628, as described in the text. The units of time are seconds from UT 00:00:00, and the amplitude scale is correlation coefficient. Symbols represent the actual visibilities produced by the correlators, while the lines represent linear least-squares fits to the visibilities. The text annotation on each panel lists the average correlation coefficient amplitude for each correlator over the time period, as tabulated in Table 4.3.

over the time range UT 17:49:00 – 17:51:00 was used in all comparison plots below.

Since the delay models used by the VLBA and software correlators differ at the picosecond level, as is the case for the comparison with the LBA data in Section 4.4.1, differences in the visibility phase exist between the correlated datasets. As with the LBA comparison, compensation has been performed for the phase errors due to the delay model differences in the following comparison.

Figure 4.6 shows the visibility amplitudes for all baselines from both correlators as a function of time. These amplitudes represent the vector averaged data over the frequency channel range 10 – 55 (to avoid the edges of the band). The data for each baseline were fit to a first order polynomial model ($S(t) = \frac{dS}{dt}t + S_0$, where S is the correlation coefficient, t is the offset in seconds from UT 17:50:00, and S_0 is the extrapolated correlation coefficient

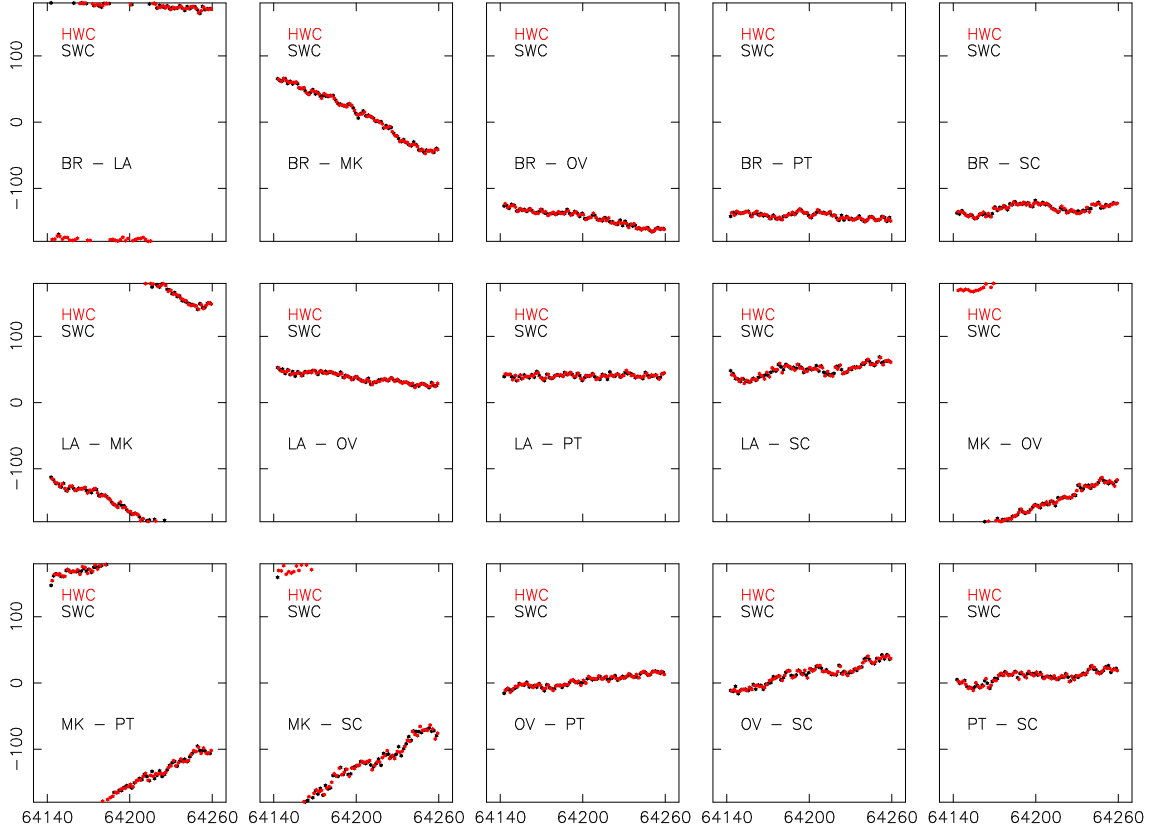

Figure 4.7 VLBA correlator (red) and DiFX (black) visibility phase vs time for the 2283.49 – 2291.49 RCP band from the VLBA test observation MT628, as described in the text. The units of time are seconds from UT 00:00:00, and phase is displayed in degrees.

Table 4.3. Linear fit parameters for visibility amplitude (in units of correlation coefficient) vs time for DiFX and the VLBA correlator, with 95% confidence limits

| Baseline | Offset _{DiFX} | Offset _{VLBA} | Slope _{DiFX} ($s^{-1} \times 10^{-6}$) | Slope _{VLBA} ($s^{-1} \times 10^{-6}$) |
|----------|------------------------|------------------------|---|---|
| BR - LA | 0.0104 ± 0.0004 | 0.0103 ± 0.0005 | -0.8 ± 1.7 | -0.9 ± 1.7 |
| BR - MK | 0.0072 ± 0.0005 | 0.0071 ± 0.0006 | 0.1 ± 1.8 | 0.5 ± 2.0 |
| BR - OV | 0.0125 ± 0.0005 | 0.0124 ± 0.0005 | -0.7 ± 1.7 | -0.5 ± 1.8 |
| BR - PT | 0.0090 ± 0.0004 | 0.0089 ± 0.0004 | -1.0 ± 1.3 | -1.2 ± 1.5 |
| BR - SC | 0.0069 ± 0.0005 | 0.0069 ± 0.0005 | -3.1 ± 2.0 | -2.5 ± 1.8 |
| LA - MK | 0.0059 ± 0.0005 | 0.0059 ± 0.0005 | 1.9 ± 1.7 | 1.4 ± 1.7 |
| LA - OV | 0.0101 ± 0.0005 | 0.0100 ± 0.0005 | 0.4 ± 1.7 | 0.6 ± 1.7 |
| LA - PT | 0.0073 ± 0.0005 | 0.0072 ± 0.0005 | -0.3 ± 1.7 | -0.5 ± 1.8 |
| LA - SC | 0.0058 ± 0.0004 | 0.0058 ± 0.0004 | -1.8 ± 1.5 | -1.9 ± 1.5 |
| MK - OV | 0.0078 ± 0.0004 | 0.0077 ± 0.0005 | 0.9 ± 1.5 | 0.3 ± 1.8 |
| MK - PT | 0.0044 ± 0.0004 | 0.0044 ± 0.0004 | -0.6 ± 1.7 | -0.3 ± 1.5 |
| MK - SC | 0.0028 ± 0.0005 | 0.0028 ± 0.0005 | -0.6 ± 1.8 | -0.7 ± 1.7 |
| OV - PT | 0.0083 ± 0.0005 | 0.0082 ± 0.0005 | -1.8 ± 1.8 | -1.9 ± 1.7 |
| OV - SC | 0.0062 ± 0.0005 | 0.0062 ± 0.0005 | -0.3 ± 1.8 | -0.2 ± 1.8 |
| PT - SC | 0.0055 ± 0.0005 | 0.0055 ± 0.0005 | -1.7 ± 2.0 | -1.3 ± 1.8 |

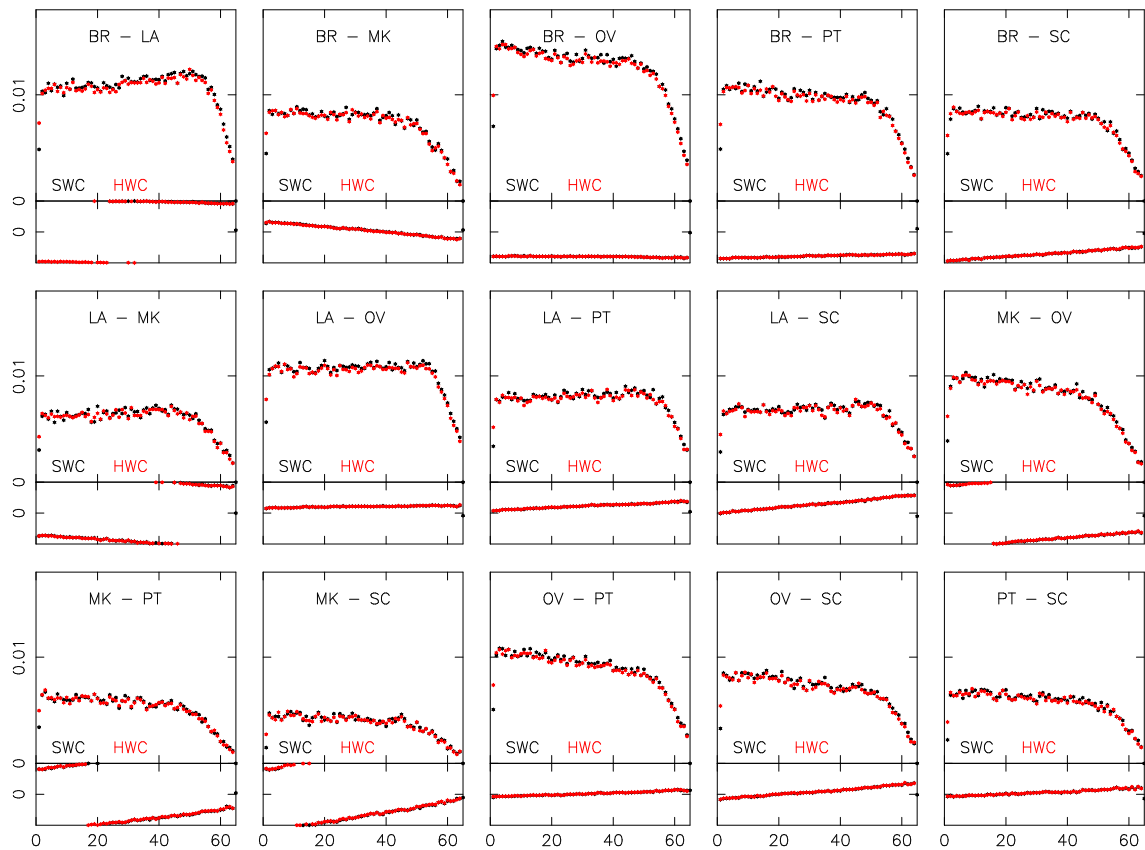

Figure 4.8 VLBA correlator (red) and DiFX (black) visibility amplitude and phase as a function of frequency for the 2283.49 – 2291.49 RCP band from the VLBA test observation MT628, as described in the text. The vertical scale for correlation coefficient amplitude on each panel is 0 – 0.018, while the phase scale spans $\pm 180^\circ$. The horizontal scale for each panel displays channels 0–64.

at time UT 17:50:00) using a standard least squares regression. The RMS variation around the best fit model was calculated for each baseline. The fitted models are shown in Figure 4.6 and show no significant differences between the VLBA correlator and DiFX. Further, the calculated RMS for each baseline agrees very well between the VLBA correlator and DiFX. The results of the comparison are summarised in Table 4.3.

Figure 4.7 shows the visibility phase as a function of time for each of the fifteen baselines in the array. Again, the data represents the vector averaged correlator output over the frequency channel range 10 – 55 within the band. As discussed above, small differences between the delay models used at each correlator cause phase offsets between the two correlators, and have been taken into account as part of this comparison.

Figure 4.8 shows a comparison of the visibility amplitudes and phases as a function of frequency in the band. The data represented here results from a vector average of the two datasets over a two minute time range. Figures 4.6, 4.7 and 4.8 show that the results obtained by the VLBA correlator and DiFX agree to within the RMS errors of the visibilities in each case, as expected. Since the VLBA correlator is an FX-style correlator, like DiFX, there is no requirement to correct for band-edge decorrelation as was required for the LBA correlator.

4.4.3 Comparison to the MPIfR geodetic correlator

Unlike the S2 and VLBA correlators, the MarkIV correlator operated by the Max Planck Institut für Radioastronomie (MPIfR) in Bonn, Germany, is used primarily for geodetic observations. The MarkIV correlator, an XF-type hardware correlator (Whitney, 1993), has been used heavily for geodetic VLBI processing for many years as part of the International VLBI Service (IVS; <http://ivscc.gsfc.nasa.gov/>) and is one of a very small number of trusted geodetic correlators around the world.

The comparison with this correlator is described in detail in Tingay et al. (2008), and the results are summarised here. The data used for the correlator comparison was a subset of the data collected for a geodetic experiment (BM261) conducted with the NRAO VLBA on 2007 July 03. One minute of data (11:23:00 UT – 11:24:00 UT) from four antennas were selected for the purposes of the comparison: Fort Davis (FD), Pie Town (PT), Owens Valley (OV), and Kitt Peak (KP). 8 dual polarisation bands of bandwidth 8 MHz were recorded, with the following centre frequencies: 1350.55, 1358.55, 1366.55, 1374.55, 1382.55, 1390.55, 1398.55, 1406.55 MHz. For the comparison, the RCP data from the 1350.55 MHz band was used.

The data at the VLBA antennas were recorded to Mark5 disk packs and transported

to the MarkIV correlator at MPIfR, where correlation was performed with the MarkIV correlator. The comparison subset of data was then exported from the Mark5 units to a standard filesystem and correlated using DiFX on a commodity cluster of linux machines at MPIfR. The data were correlated with 128 frequency channels across the band. Prior to correlation, a clock model was derived for the experiment and applied identically for each correlator. As with the previous two comparisons, however, geometric models were derived independently, and the model difference was calculated and subtracted from the following analysis.

Figure 4.9 shows the visibility phase as a function of time for each of the six baselines correlated. As with the previous comparisons, the data represents the vector averaged correlator output from the centre of the band (frequency channels 32 – 96), and the phase offsets due to small differences between the delay models used at each correlator have been corrected in this analysis. Figure 4.10 shows a comparison of the visibility amplitudes and phases as a function of frequency in the band. The data represented here results from a vector average of the two datasets over the one minute comparison time range.

Figures 4.9 and 4.10 show that the results obtained by the MarkIV correlator and DiFX are in good agreement. Since the MarkIV correlator is used primarily for geodesy and the amplitude correction signal path is not well documented, no attempt has been made to improve the a priori amplitude corrections in the manner of the VLBA correlator comparison. As the MarkIV correlator is an XF-style correlator and the visibilities were not corrected for fractional-sample decorrelation at the band edge, a noticeable difference can be seen at the band edge in amplitudes. Figure 4.9 also shows several glitches in visibility phase in the MarkIV correlator output. The origin of these glitches is unknown, but they are almost certainly an error in the MarkIV correlator output, as no glitches are seen to occur on correlators simultaneously and the magnitude of the phase jump is many times the phase RMS. A possible cause of the phase jumps is an error on the Mark5 Station Unit during playback at the correlator (C. Phillips, private communication).

4.5 Performance benchmarking

In order to keep every compute node used in the correlation fully loaded, they must be kept supplied with raw data. If this condition is satisfied, the correlation is CPU-limited, and the addition of further nodes will result in a linear performance gain. In practise, however, at some point obtaining data from the data source (network socket or disk) and transmitting it across the local network to the processing nodes will no longer occur quickly enough, and the correlation becomes data-limited rather than CPU-limited.

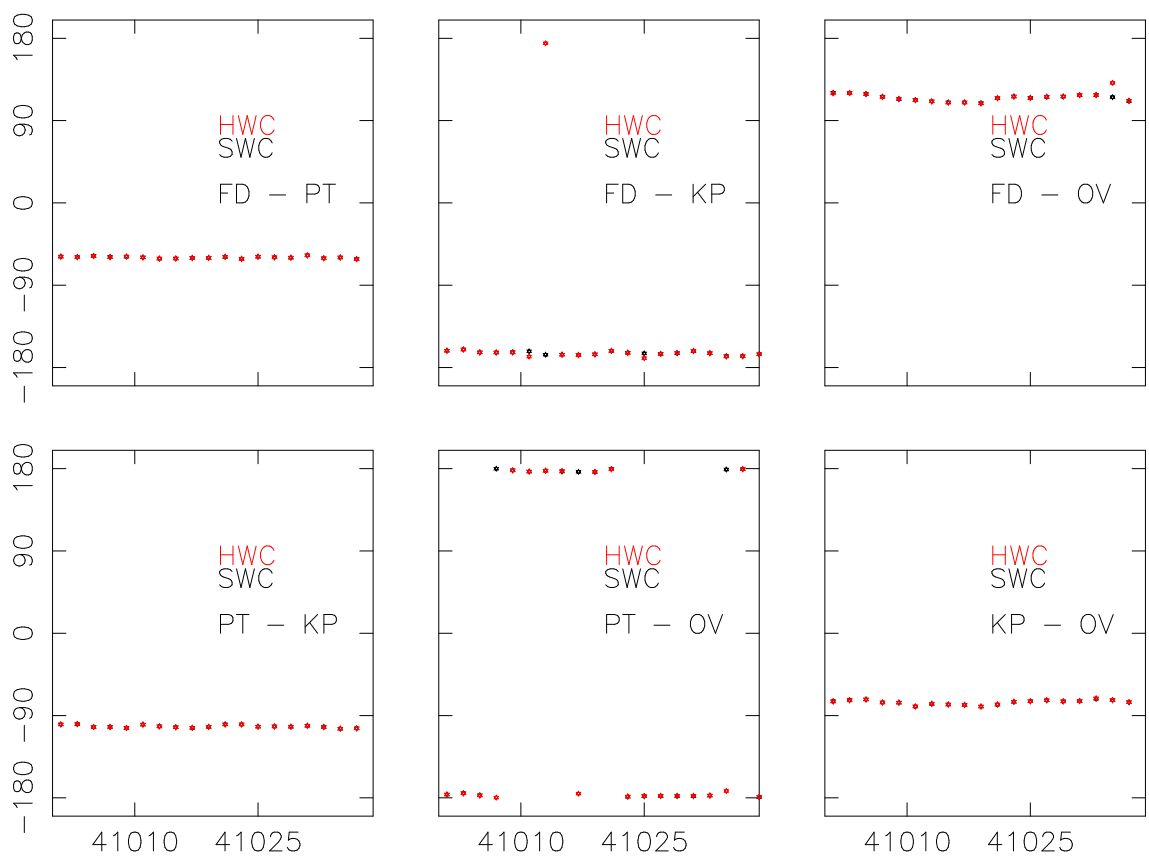

Figure 4.9 Geodetic correlator (red) and DiFX (black) visibility amplitude vs time for the 1346.55 – 1354.55 RCP band from the geodetic observation BM261, as described in the text. The units of time are seconds from UT 00:00:00, and the phase is displayed in degrees.

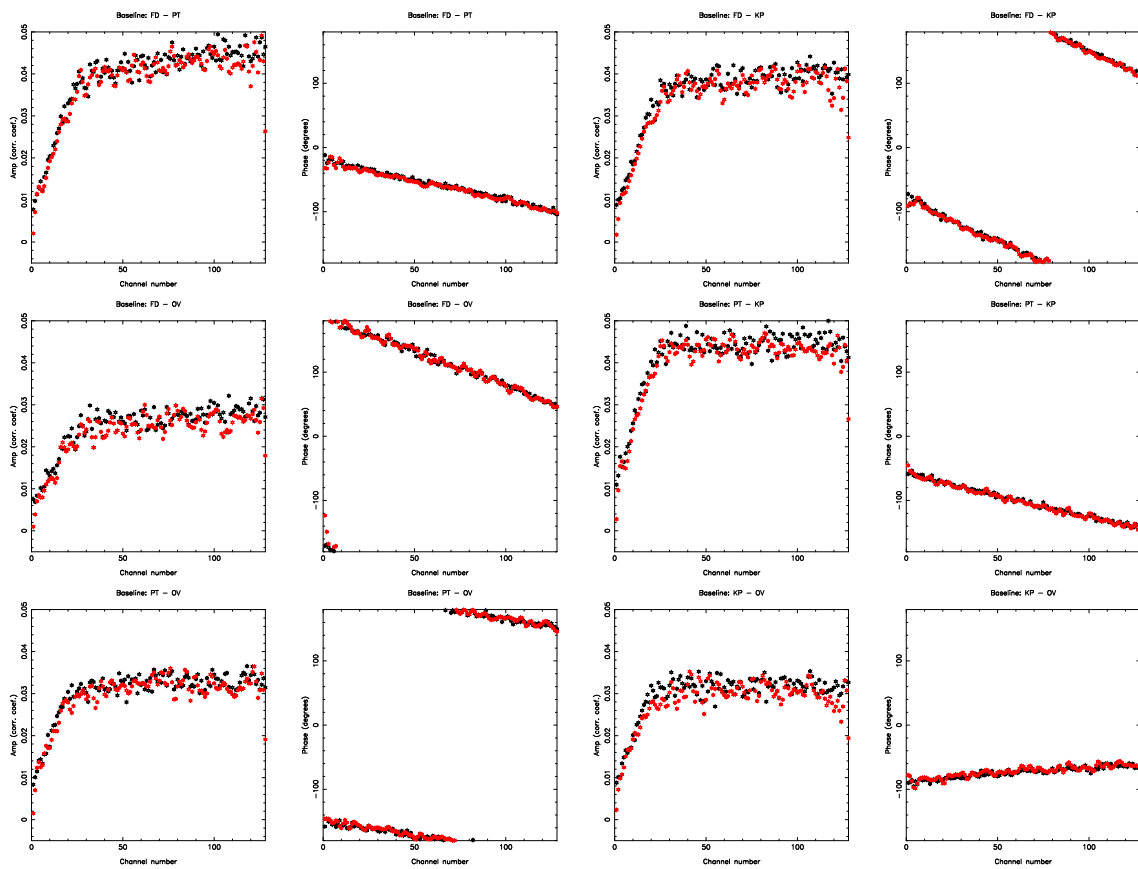

Figure 4.10 Geodetic correlator (red) and DiFX (black) visibility amplitude and phase as a function of frequency for the 1346.55 – 1354.55 RCP band from the geodetic observation BM261, as described in the text. The vertical scale for correlation coefficient amplitude on each panel is 0 – 0.05, while the phase scale spans $\pm 180^\circ$. The horizontal scale for each panel displays channels 0–128.

Correct selection of correlation parameters, and good cluster design, will minimise the networking overhead imposed on a correlation job, and ensure that all compute nodes are fully utilised. This is discussed in Section 4.5.1 below, and performance profiles for the CPU-limited case are presented in Section 4.5.2.

4.5.1 Networking considerations

As described in Section 4.3.1, double-buffered communications to the processing nodes are used to ensure that nodes are never idle as long as sufficient aggregate networking capability is available. The use of MPI communications adds a small but unavoidable overhead to data transfer, meaning the maximum throughput of the system is slightly less than the maximum network capacity on the most heavily loaded data path.

There are two significant data flows: out of each Datastream and into the FxManager. For any high speed correlation, there will be more Core nodes than Datastream nodes, so the aggregate rate into a Core will be lower than that out of a Datastream. The flow out of a Core is a factor of N_{cores} times lower than that into the FxManager node.

If processing in real time (when processing time equals observation time), the rate out of each Datastream will be equal to the recording rate, which can be up to 1 Gbps with modern VLBI arrays and is within the capabilities of modern commodity ethernet equipment. The rate into the FxManager node will be equal to the product of the recording rate, the compression ratio, and the number of Cores, where the compression ratio is the ratio of data into a Core to data out of a Core. This is determined by the number of antennas (since number of baselines scales with number of antennas squared), the number of channels in the output cross-power spectrum, the number of polarisation products correlated, and the integration time used before sending data back to the FxManager node.

It is clearly desirable to maximise the size of data messages sent to a core for processing, since this minimises the data rate into the FxManager node for a given number of Cores. However, if the messages are too large, performance will suffer as RAM capacity is exceeded. Network latency may also become problematic, even with buffering. Furthermore, it should be apparent that in this architecture, the Cores act as short-term accumulators (STAs), with the FxManager performing the long term accumulation. The length of the STA sets the minimum integration time. It is important to note, however, that the STA interval is entirely configurable in the software correlator, to be as short as a single FFT, although network bandwidth and latency are likely to be limiting factors in this case.

For the majority of experiments it is possible to set a STA length which satisfies all the network criteria and allows the Cores to be maximally utilised. For combinations of large numbers of antennas and very high spectral and time resolution, however, it is impossible to set an STA which allows a satisfactorily low return data rate to the FxManager node. In this case, real time processing of the experiment is not possible without the installation of additional network and/or CPU capacity on the FxManager node.

It is important to emphasise that although it is possible to find experimental configurations for which DiFX suffers a reduction in performance, these configurations would be impossible on existing hardware correlators. If communication to the FxManager node is limiting performance, it is also possible to parallelize a disk-based experiment by dividing an experiment into several time ranges and processing these time ranges simultaneously, allowing an aggregate processing rate which equals real time. This is actually one of the most powerful aspects of the software correlator, and one which would allow scheduling of correlation to always ensure the cluster was being fully utilised.

4.5.2 CPU-limited performance

Figure 4.11 shows the results of performance testing on the Swinburne cluster available in 2006 (3.2 GHz Pentium 4 machines, Gigabit ethernet network) for different array sizes and spectral resolutions. The results shown in Figure 4.11 were obtained for data for which the aggregate bandwidth was 64 MHz, broken up into 8 bands each of 8 MHz bandwidth (4 × dual polarisation 8 MHz bands: data were 2-bit sampled: antenna data rate 256 Mbps). Node requirements for real-time operation are extrapolated from the compute time on an 8 node cluster. The correlation integration time is 1 second and all correlations provide all four polarisation products. RAM requirements per node ranged from 10 – 50 MB depending on spectral resolution, showing that large amounts of RAM are unnecessary for typical correlations. It can be seen that even a modestly sized commodity cluster can process a VLBI-sized array in real time at currently available data rates.

Recently, the Swinburne supercomputer cluster has been upgraded to multicore, 64 bit machines. Testing on this architecture has shown that the correlation code performance scales near-linearly with the number of threads used per node (up to the number of CPU cores), as expected for this embarrassingly parallel problem. Data rates of up to 1 Gbps per antenna have been correlated in real-time on these new machines, in the eVLBI experiments described in Section 4.6.1.

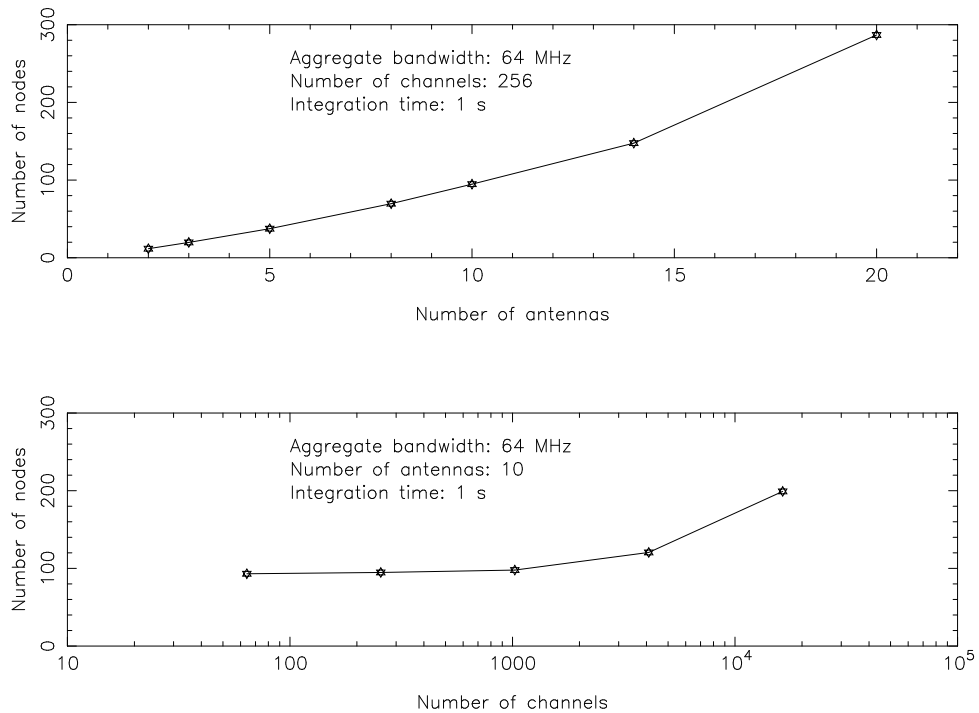

Figure 4.11 Benchmark data showing the computational requirements of DiFX to correlate in real-time, as described in the text. The nodes are single core 3.2 GHz Pentium processors with 1 GB RAM, and in both benchmarks 64 MHz of total bandwidth per station was correlated with a 1 second integration period. Top panel shows the scaling of computational requirements with number of antenna, using 256 spectral points per 8 MHz subband. Bottom panel shows the scaling of computational requirements with spectral points per subband for a ten station array.

4.6 Additional applications

Whilst DiFX was developed with the primary aim of servicing the needs of the LBA, every effort was made during development to ensure that DiFX would be adaptable to the needs of other interferometers that required an upgrade path from an existing correlator. This approach has enabled the use of DiFX to correlate data from every major VLBI array in the world, as well as facilitating the rapid development of several new instruments. Those science highlights which are external to this thesis are summarised briefly below.

4.6.1 LBA eVLBI

Operational eVLBI modes have been tested using DiFX, using real-time data from the three ATNF telescopes (Parkes, ATCA, and Mopra), the University of Tasmania telescope in Hobart, and international telescopes including the Kashima 34m telescope in Japan,

and the Shanghai 25m telescope in China. These observations have seen data rates up to 1 Gbps per antenna using Australian-only antennas, and 512 Mbps per antenna in international experiments, equaling the highest data rate experiments performed with the EVN (highest published data rate 256 Mbps¹⁴; Paragi et al., 2007). Correlation has taken place using computing resources at Swinburne University, the ATNF, and the University of Western Australia in Perth (a Cray XD-1 utilising Opteron processors and on-board Xilinx FPGAs). A more extensive description of the eVLBI activities of the LBA using DiFX can be found in Phillips et al. (2007).

First science results from these eVLBI experiments have recently been published, and include observations of the Galactic x-ray binary Circinus X-1 (Phillips et al., 2007) and the supernova remnant of SN1987A (Tingay, 2008).

4.6.2 VLBA sensitivity upgrade

The VLBA is the only full-time VLBI instrument in the world, and has been responsible for much of the rapid advance in VLBI science over the past decade. When designed, it used the Mark4 tape system (Whitney, 1993), and it has been upgraded to use the Mark5A disk-based system (Whitney, 2003). Recently, a major upgrade to VLBA sensitivity has been planned, aiming to reach data rates of 4 Gbps, an 8-fold increase over the current maximum data rate. Information on the planned sensitivity upgrade is available at <http://www.vlba.nrao.edu/memos/sensi/>. In order to reach these increased data rates, the VLBA requires both a new digital backend and a new correlator. The digital backend, named Mark5C, is under development, and DiFX has been chosen as the upgrade path for the correlator. “First light” with VLBA data on a local installation of DiFX has been obtained in 2008, and production usage is expected to commence in late 2008. Support and configuration tools have been developed to allow DiFX to function as a “drop-in” replacement for the existing hardware correlator, allowing duplication of existing functionality at the same time as providing new capabilities.

4.6.3 High Sensitivity Array observations of pulsar scintillation

As discussed in Chapter 2, the inhomogeneous distribution of the ISM leads to diffractive and refractive scattering of signals from compact sources such as pulsars. Whilst single-dish studies of pulsar scintillation have already shed considerable light on the nature of the structures in the ISM responsible for this scintillation (see e.g. Cordes et al., 2006,

¹⁴for unpublished higher data rate results, see http://www.expres-eu.org/512Mbps_6tel.html

and references therein), high frequency resolution VLBI observations of scintillating pulsars offer the possibility of directly imaging the ISM structures at extremely high spatial resolution.

The capabilities of DiFX for this type of analysis have recently been demonstrated with observations of PSR B0834–04 in 2005 (Briskin et al., in preparation). Elements of the High Sensitivity Array (HSA), comprising the NRAO Green Bank Telescope (GBT; 100 m), Westerbork (14×25 m), Jodrell Bank (76 m), and Arecibo (305 m) were used to provide an ultra-sensitive array at 327 MHz. The data were recorded using the Mk5 system and correlated on a prototype implementation of DiFX. The main requirement on the correlation was 250 Hz wide frequency channels, over the broadest bandwidth available, to maximise signal to noise. For these observations a 32 MHz band was available. The DiFX correlation used 131,072 frequency channels, obtaining a frequency resolution of 244 Hz. Such extreme frequency resolution for a continuum experiment is beyond the capabilities of any existing hardware correlator. Figure 4.12 shows a section of the dynamic spectrum from this observation which shows the scintillation structure as a function of time and frequency on the GBT–Arecibo baseline. A deconvolution process allows the generation of a speckle image of the scattering disk using the interferometric phase information (Briskin et al., in preparation). The effective resolution of the speckle image is better than 1 mas, revealing structure which is a factor of 40 smaller than the synthesised beam of the interferometer.

4.6.4 EVN pulsar astrometry

DiFX has been used to correlate Mark5 data from the EVN with multiple pulsar gates and phase centres to make an image of the pulsar distribution in the globular cluster M15 (Deller et al., in preparation). Through phase referencing to a nearby quasar and taking an ensemble average of pulsar motions over several epochs, it will be possible to obtain the proper motion of the cluster with a higher signal/noise ratio than would be possible using a single pulsar. It is also possible to further improve the calibration of the data by using the brightest pulsar as an in-beam calibrator, improving the sensitivity to the other pulsars in the cluster and making it possible to conduct extremely precise relative astrometry to probe the intra-cluster dynamics.

4.6.5 Widefield VLBI

DiFX is being used to correlate VLBA observations of the Chandra Deep Field South, using high time and frequency resolution which is not available with the existing VLBA hardware



Figure 4.12 The cross-power dynamic spectrum showing scintillation variations for the pulsar B0834–04 on the Green Bank Telescope – Arecibo baseline. Brightness represents the visibility amplitude and colour represents the visibility phase. Increasing frequency runs left to right and increasing time runs top to bottom. This section of the dynamic spectrum represents just 5% of the time span and 0.5% of the bandwidth of the observation (330 seconds and 160 kHz).

correlator. This project aims to obtain VLBI-resolution imaging over a 30×30 arcminute field of view. Post-correlation phase shifting to potential targets identified from lower-resolution observations allows many targets to be imaged from a single correlator pass. In the future, DiFX will support multiple phase centres during correlation, eliminating the need for post-correlation shifting and averaging of visibilities before imaging, which will enable this and other larger-scale VLBI surveys to be carried out quickly and efficiently.

4.6.6 Australian/New Zealand geodesy

A new 3-element, full time geodetic array is planned to commence operations in Australia in 2009 as part of the AuScope project¹⁵. This array will contribute to observations which address both local and global geodetic goals. Closely linked to the AuScope project is the development of a geodetic VLBI capacity in New Zealand, led by the Centre for Radio-physics and Space Science at Auckland University of Technology¹⁶. The DiFX software correlator will be used for the correlation of these new geodetic arrays.

¹⁵<http://www.auscope.org.au/>

¹⁶http://www.aut.ac.nz/about/faculties/design_and_creative_technologies/faculty_research_office/centre_for_radiophysics_and_space_research/mission.htm

4.6.7 Worldwide geodesy

As is the case with many areas of VLBI, the geodetic community is currently planning a significant upgrade in capabilities. This upgrade is spearheaded by a sensitivity increase driven by wider recording bandwidths, but also includes new hardware such as smaller, more rapidly slewing antennas and new, improved digital backends. The upgrade project is known as VLBI2010¹⁷, and aims to achieve an initial recording rate of 2–4 Gbps with the potential for expansion to 8, 16 or even 32 Gbps. As the Mark 4 hardware correlators currently used for geodetic VLBI are limited to a 1 Gbps correlation rate, this project will necessitate new and improved correlator infrastructure (Niell et al., 2005). At present, the use of DiFX in this role is being investigated by MPIfR, with activities including the correlator comparison shown in Section 4.4.3.

¹⁷<http://ivs.nict.go.jp/mirror/about/wg/wg3/>

5

ASTROMETRIC OBSERVATIONS, DATA REDUCTION AND ANALYSIS

5.1 Goals and target selection

The observational program of this thesis encompassed 8 pulsars, which are listed in Table 5.1. As already noted in Chapter 1, previous Southern Hemisphere VLBI pulsar astrometry programs (Dodson et al., 2003; Legge, 2002; Bailes et al., 1990) have yielded only two published pulsar parallaxes, so one primary motivation was to increase the number of southern VLBI parallaxes and hence improve models of Galactic electron distributions at southern declinations. Additionally, as this is the first such large scale southern parallax study, target pulsars of varying brightness and predicted distance were chosen in order to determine the types of targets that would be feasible for future southern VLBI studies. The brightness and predicted distance of the selected targets are shown below in Table 5.1. Within the bounds of these criteria, however, it was possible to choose target pulsars for which a VLBI parallax would enable a deeper understanding of additional astrophysical phenomena.

The chosen targets can be divided into three broad categories: binary pulsars used for tests of GR and gravitational wave detection (PSR J0437–4715, PSR J0737–3039A/B and PSR J2145–0750), pulsars with unusual luminosity in the radio (low luminosity pulsars PSR J0108–1431 and PSR J2144–3933) or x-ray (PSR J0630–2834, whose x-ray luminosity is anomalously high), and “technique check” sources which are bright and predicted to be nearby (PSR J1559–4438 and PSR J2048–1616). The results for each pulsar, and the implications of these results, are discussed individually in Chapter 6.

The remainder of this chapter will be devoted to describing the observations and data reduction applied to all pulsars, with a particular focus on the tools developed for pulsar

Table 5.1. Target pulsars

| Pulsar name | DM distance (pc) ^a | 1600 MHz flux (mJy) | Pulsar gating gain | Equivalent gated 1600 MHz flux (mJy) | Reference source | Calibrator/target separation (deg) |
|---------------|---------------------------------|---------------------|--------------------|--------------------------------------|------------------|------------------------------------|
| J0108–1431 | 130 | 0.6 ^b | 5.1 | 3 | J0111–1317 | 1.5 |
| J0437–4715 | 140 | 140 | 6.25 | 875 | J0439–4522 | 1.9 |
| J0630–2834 | 2150 | 23 | 3.5 | 81 | J0628–2805 | 0.7 |
| J0737–3039A/B | 570 | 1.6 | 2.5 | 4 | J0738–3025 | 0.4 |
| J1559–4438 | 1600 | 40 | 3.6 | 144 | J1604–4441 | 0.9 |
| J2048–1616 | 640 | 13 | 3.6 | 47 | J2047–1639 | 0.5 |
| J2144–3933 | 180 | 0.8 ^b | 10 | 8 | J2141–3729 | 2.1 |
| J2145–0750 | 500 | 8 ^b | 4.3 | 34 | J2142–0437 | 3.3 |

^aTaken from Taylor & Cordes (1993)

^bPulsar suffers heavily from long timescale scintillation, so individual epochs vary considerably from the average value shown.

astrometry reduction which address aspects of the data reduction process not previously highlighted in the literature. In order to illustrate the concepts, the results for PSR J1559–4438 will be used, as this proved the superior of the two “technique check” sources.

5.2 Observations

Eight observational epochs were spread over a two year period from May 2006 to February 2008. Epochs were typically 24 hours in duration and a subset of the eight pulsars were observed, depending on which were closest to parallax extrema. The observing frequency was centred on 1400 MHz for the first observation, and 1650 MHz for the remaining seven observations. PSR J0437–4715 was observed separately, with four epochs of 12 hours duration, centred on 8400 MHz. Observations at this higher frequency were made possible by the high flux and narrow pulse profile of PSR J0437–4715. Dual circular polarization was used at all frequencies.

The Australian Long Baseline Array (LBA) consists of six antennas – the Australia Telescope National Facility (ATNF) telescopes in New South Wales (Parkes, Australia Telescope Compact Array [ATCA], Mopra); the University of Tasmania telescopes at Hobart, Tasmania and Ceduna, South Australia; and the NASA DSN facility at Tidbinbilla, Australian Capital Territory. The Parkes, phased ATCA, Mopra, and Hobart telescopes participated in all experiments, but a Tidbinbilla antenna (70m or 34m) was used only when available, and Ceduna participated in observations of J0437–4715 only¹. The maximum baseline length with Ceduna is 1700 km, and without Ceduna is 1400 km. Representative uv coverage at 1650 MHz and 8400 MHz is shown in Figure 5.1.

All observations used the recently introduced LBADR disk-based recording system

¹Ceduna does not possess a 1600 MHz receiver, so could only participate in the higher frequency experiments

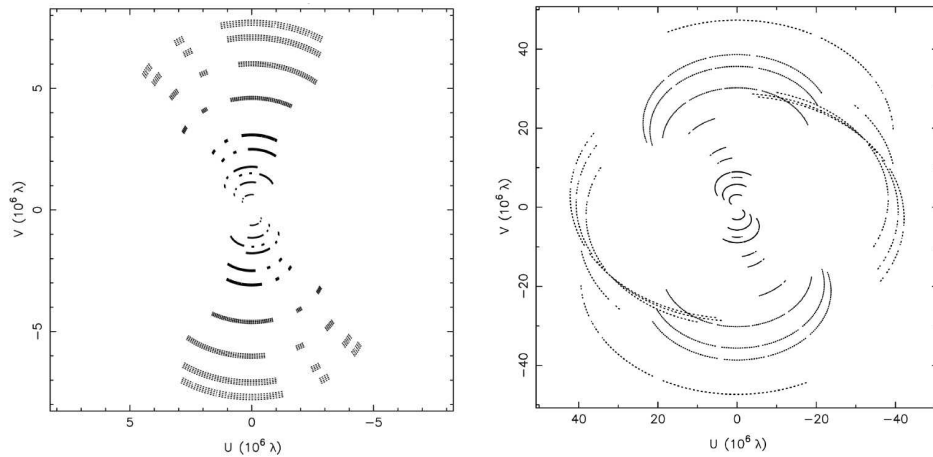

Figure 5.1 Typical uv coverage at 1650 MHz (no Ceduna; left panel) and at 8400 MHz (with Ceduna; right). The target sources are PSR J1559–4438 and PSR J0437–4715 respectively. Without Ceduna, the uv coverage is heavily biased north–south, and wide hour–angle coverage is necessary to gain acceptable uv coverage. The displayed plots are optimal uv coverage – equipment failure or telescope commitments often meant only a subset of this coverage was obtained.

(Phillips et al., in preparation). At the three ATNF observatories, the presence of two Data Acquisition System (DAS) units allowed a recording rate of 512 Mbps (8×16 MHz bands, Nyquist sampled at 2 bits), while the non-ATNF stations recorded at 256 Mbps (4×16 MHz bands). For epochs where dual-polarization feeds were available at all antennas, two frequency bands were dropped at the non-ATNF stations, but as some of the NASA DSN feeds are single polarization only, 1650 MHz epochs featuring the 70m NASA antenna and 8400 MHz epochs featuring the 34m NASA antenna instead retained a single polarization of all frequency bands. The observation dates, targets, and participating antennas are summarised in Table 5.2.

A phase reference cycle time of six minutes, apportioned equally to target and calibrator, was used for all observations. As the LBA consists of disparate antennas ranging up to 70m in diameter (and, when phased, the ATCA has an equivalent diameter of hundreds of metres for the purposes of calculating field of view), it was not possible to utilise in-beam calibrators for any sources, unlike recent pulsar astrometric programs using the VLBA (Chatterjee et al., 2001, 2005).

The data were correlated using matched filtering on pulse profiles with the DiFX software correlator, producing RPFITS format visibility data. Table 5.1 shows the predicted gain due to pulse profile filtering for each target source. Pulsar ephemerides were ob-

Table 5.2. Observation summary

| Observation date (MJD) | Duration (hours) | Observed pulsars | Participating telescopes |
|------------------------|------------------|---|---|
| 53868 | 12 | 0437–4715 | Parkes, ATCA, Mopra, Hobart, Ceduna |
| 53870 | 15 | 1559–4438, 2048–1616, 2144–3933, 2145–0750 | Parkes, ATCA, Mopra, Hobart |
| 53970 | 24 | 0108–1431, 0630–2834, 0737–3039 1559–4438, 2048–1616, 2144–3933 | Parkes, ATCA, Mopra, Hobart, DSS43 (70m) |
| 54055 | 12 | 0437–4715 | Parkes, ATCA, Mopra, Hobart, Ceduna, ^A DSS43 (70m) |
| 54057 | 24 | 0108–1431, 0630–2834, 0737–3039 1559–4438, 2048–1616, 2144–3933, 2145–0750 | Parkes, ATCA, Mopra, Hobart, DSS43 (70m) |
| 54127 | 24 | 0108–1431, 0630–2834 0737–3039, 1559–4438, 2144–3933 | Parkes, ATCA, Mopra, Hobart, DSS43 (70m) |
| 54181 | 12 | 0437–4715 | Parkes, ATCA, Mopra, Hobart, Ceduna, DSS43 (70m) ^B |
| 54182 | 24 | 0630–2834, 0737–3039, 1559–4438 2048–1616, 2144–3933, 2145–0750 | Parkes, ATCA, Mopra, ^C Hobart, DSS43 (70m) |
| 54307 | 24 | 0108–1431, 0630–2834 0737–3039, 1559–4438, 2144–3933 | Parkes, ATCA, Mopra, Hobart, DSS43 (70m) |
| 54413 | 24 | 0108–1431, 0630–2834, 0737–3039 1559–4438, 2048–1616, 2144–3933, 2145–0750 | Parkes, ATCA, Mopra, Hobart |
| 54417 | 12 | 0437–4715 | Parkes, ATCA, Mopra, Hobart, Ceduna, DSS34 (34m) ^B |
| 54500 | 24 | 0108–1431, 0630–2834 0737–3039, 1559–4438, 2144–3933 | Parkes, ATCA, Mopra, Hobart, DSS43 (70m) ^D |

^AEquipment failure meant no useful data was available from Ceduna for this session.

^BLimited time (~ 4 hours) was available at the DSS telescopes in these sessions.

^CEquipment failure led to the loss of half of the Mopra data from this session.

^DSetup errors meant no useful DSS43 data was available from this session.

tained using the ATNF Pulsar Catalogue (Manchester et al., 2005), with the exception of the double pulsar PSR J0737–3039A/B, which was periodically updated with the latest published ephemeris. Two second integrations and 64 spectral points per 16 MHz band were used for all observations.

5.3 Data reduction

Data reduction was performed principally in AIPS, using the python interface Parsel-Tongue (Kettenis et al., 2006). The DIFMAP package (Shepherd, 1997) was used for imaging and self calibration. The data reduction was implemented as a pipeline, with user interaction for imaging, editing of solution tables, and visibility flagging. All scripts used in the data reduction process are freely available and can be downloaded from <http://astronomy.swin.edu.au/~adeller/software/scripts/>. The individual stages of the pipeline are described below.

5.3.1 Amplitude and weight calibration and flagging

Amplitude calibration using the measured telescope system temperatures was carried out using the AIPS tasks APCAL and ANTAB. Flagging based on predicted or (when available) logged telescope off-source times due to slewing or failures was applied using UVFLG,

while the first and last 10 seconds of every scan was excised with the task QUACK. For the ATCA, the tied array infrastructure required flagging the first three correlator integrations (totaling 30 seconds) of each scan with QUACK. The weight of each visibility point, which is set to a constant value when the RPFITS format data is loaded into AIPS, was initially scaled by the predicted baseline sensitivity using a ParselTongue script. The effect of data weighting is investigated further in Section 5.6.

5.3.2 Geometric model and ionospheric corrections

At the low frequencies which are generally used for pulsar astrometry, ionospheric variations usually make the dominant contribution to systematic error (see e.g. Brisken et al., 2002). Using ionospheric models based on Global Position System (GPS) data provided by the NASA Jet Propulsion Laboratory², the AIPS task TECOR was used to correct phase variations due to the ionosphere. This observing program roughly coincided with the solar minimum of 2006, and consequently the ionospheric variations were generally at a minimum. For PSR J0437–4715, which was observed at 8.4 GHz, the position shifts introduced by ionospheric correction were very small ($\sim 100 \mu\text{as}$) and did not improve the quality of the astrometric fit, so this step was not applied for PSR J0437–4715.

Total Electron Content (TEC) models suffer at southern declinations due to the relatively sparse distribution of GPS receivers at southern latitudes. Consequently, the derived ionospheric corrections are much less reliable for the LBA than for similar Northern Hemisphere instruments. The dispersive delay corrections generated by TECOR were inspected for each epoch, and the effectiveness of different TEC maps is investigated in Section 5.5.2.

While the observational program was underway, considerably more accurate station positions were derived for several LBA antennas using archival geodetic observations and the OCCAM software (Titov et al., 2004), a dedicated 22 GHz LBA geodetic experiment (Petrov et al., in preparation), and GPS survey measurements. Additionally, more accurate positions for some calibrators were published in the 5th VLBA Calibrator Survey (VCS5; Kovalev et al., 2007). The visibilities were corrected to account for the revised positions using an AIPS SN table generated with the Wizardry feature of ParselTongue, which stored the difference between the initial and corrected geometric models.

For some pulsars, their proper motions ($> 100 \text{ mas yr}^{-1}$) cause significant position shifts over the course of a 24 hour observation, comparable in some cases to the epoch positional accuracy. As the geometric model generation used in DiFX at the time of these

²available from the Crustal Dynamics Data Information Systems (CDDIS) archive: <http://cddis.gsfc.nasa.gov/pub/gps/products/ionex/>

observations could not account for proper motion, the visibility phases and uvw values were corrected in AIPS using a SN table generated by ParselTongue, interpolating between predicted positions for the pulsar at the start and end of the experiment. This also allowed the proper motion to be refined (or, in some cases, measured for the first time) over the course of the observations before the final corrections were applied.

5.3.3 Fringe-fitting and amplitude calibration refinement

Fringe fitting was performed using the AIPS task FRING, using a point source model, on the phase reference calibrator data for each target pulsar. Subsequently, a single structural model was produced for each calibrator using the combined datasets from all epochs. With the exception of B0736–303, each source was modeled using a dominant component (delta or narrow Gaussian) fixed at the phase center, and 0 – 2 secondary components which were allowed to vary in position³. The flux density of all components was allowed to vary. Typically, the variation in flux density of secondary component(s) between epochs was < 1% of the image peak flux density. Images were then generated using uniform weighting (bin size two pixels) and baseline weights set to predicted noise RMS (difmap uvweight settings 2,-1). The images of each phase reference source are shown in Figures 5.2 and 5.3. With the exception of B0736–303 and J2142–0437, the corrections due to reference source structure were very small.

The solutions were applied to each calibrator and the data averaged in frequency, exported to disk and loaded into DIFMAP. The calibrator model was loaded and several iterations of self-calibration and modelfitting performed. The difmap ‘modelfit’ command uses the Levenberg–Marquardt least-squares minimisation algorithm to fit the free model parameters to the visibility points, incorporating the visibility weights. The self calibration corrections were then written to disk as an AIPS SN table using the ‘cordump’ patch to difmap⁴. Additionally, data points flagged in DIFMAP were collated in a Wizardry script and converted into a flag file suitable for the AIPS task UVFLG.

³B0736–303 was modeled using a combination of CLEAN and modelfit components, and is discussed further in Section 6.1.2

⁴<http://astronomy.swin.edu.au/~elenc/difmap-patches/>

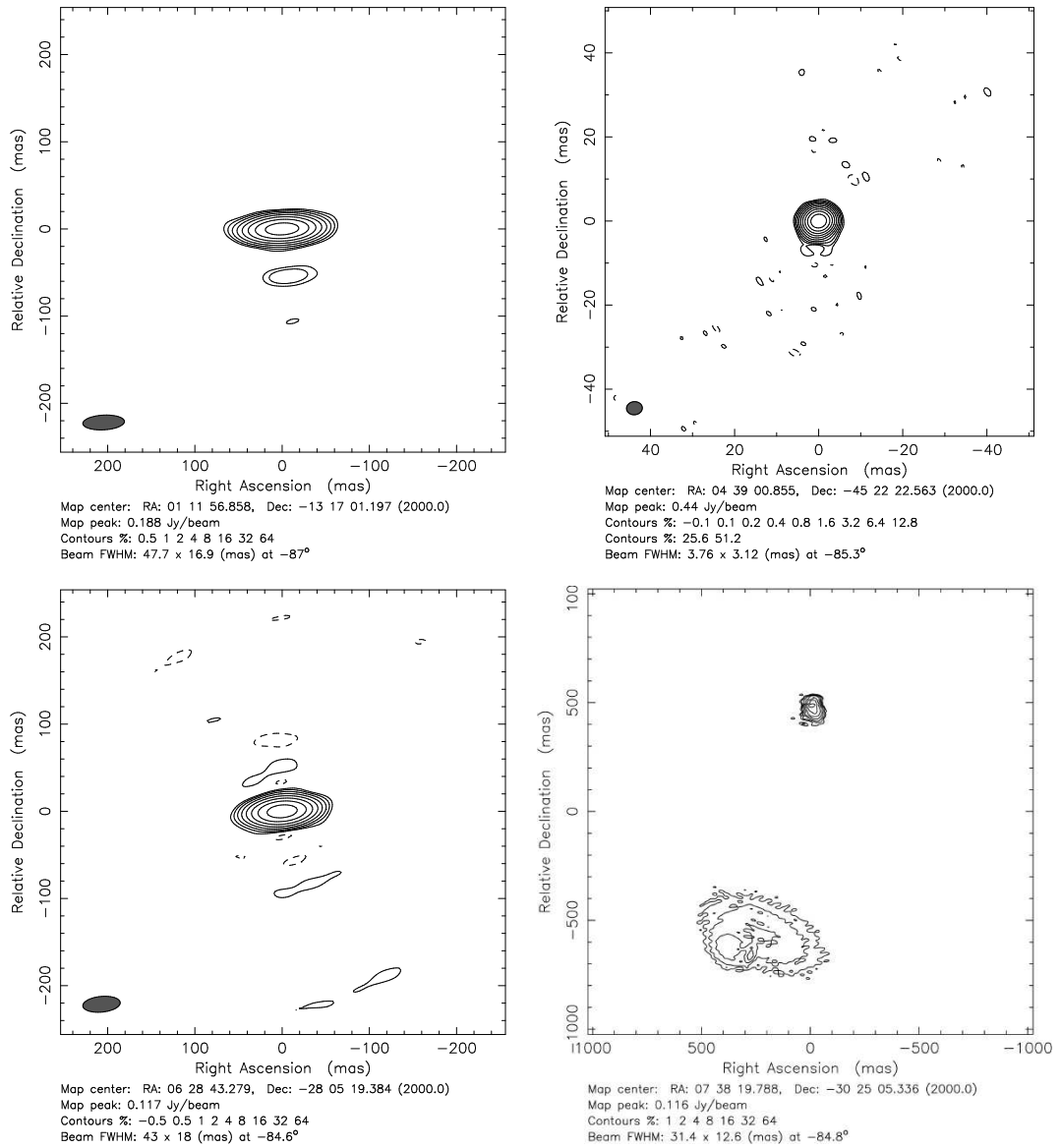

Figure 5.2 LBA images of the phase reference sources J0111-1317, J0439-4522, J0628-2805 and B0736-303. 0.4 mas pixels were used for J0439-4522 (8 GHz observations) and 2 mas pixels used elsewhere. Uniform weighting with visibility weights raised to the power -1 was used for all images.

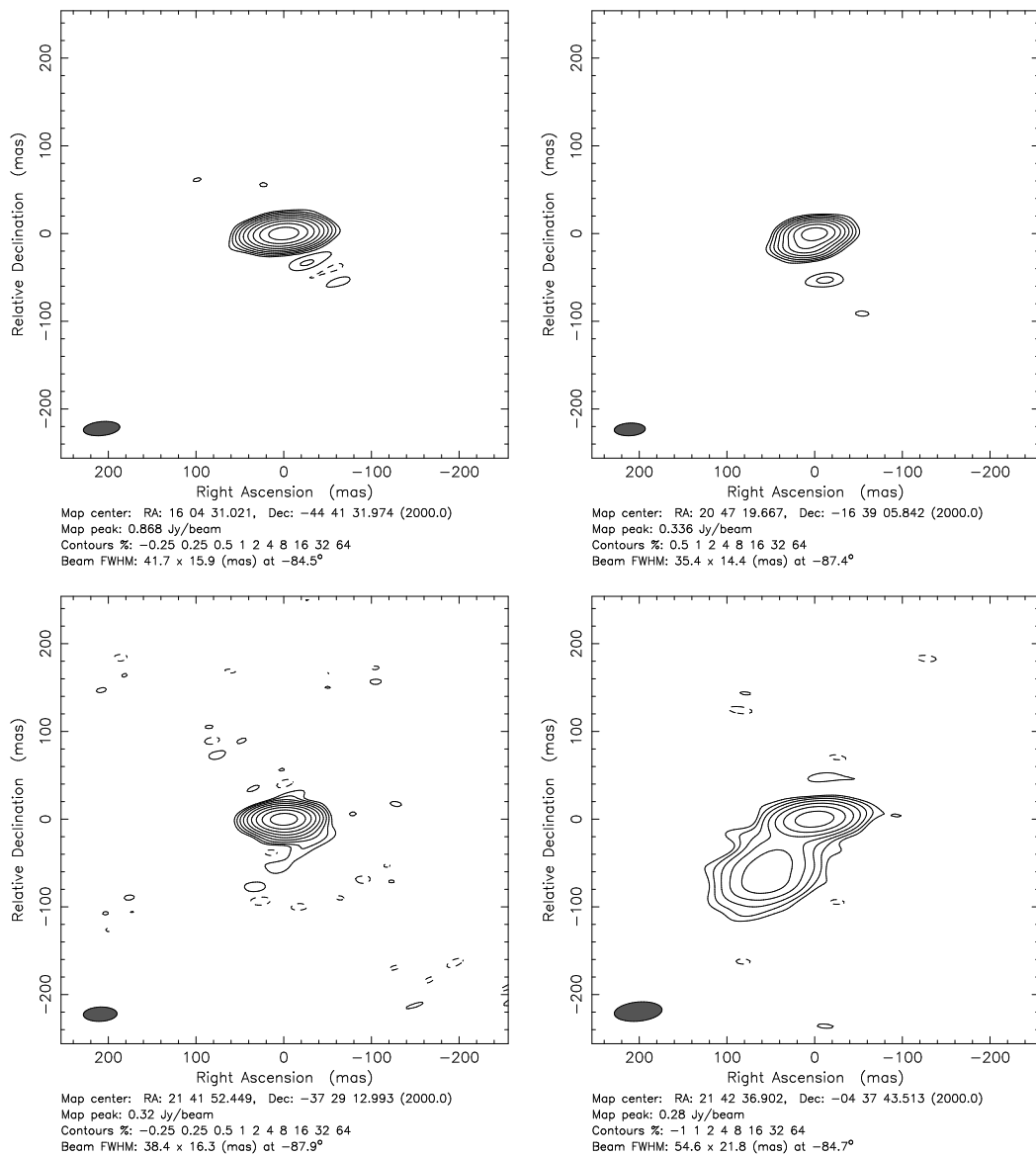

Figure 5.3 LBA images of the phase reference sources J1604-4441, J2047-1639, J2141-3729 and J2142-0437. 2 mas pixels and uniform weighting with visibility weights raised to the power -1 were used for all images.

The amplitude corrections generated in this manner allowed compensation for imperfectly measured system temperature values, and were also applied to visibility weights. For bands which could not be self-calibrated, due to only being observed by the three ATNF antennas, a correction was estimated based on the nearest band with self calibration solutions of the same polarization. The self calibration solutions were loaded into AIPS using TBIN, and applied to the target pulsars using CLCAL.

The use of bandpass calibration was investigated but found to make insignificant difference to the fitted target position. The LBA Data Acquisition System (DAS) utilizes digital filtering and typical bandpass phase ripple was < 2 degrees. When averaging in frequency, the lowest and highest 10% of the band was discarded and the central 80% of the band averaged with uniform weight assigned to each channel.

5.3.4 Pulsar scintillation correction

Nearby pulsars can suffer dramatic, and rapid, variations in visibility amplitude due to diffractive scintillation. The size of the scintillation pattern is typically much larger than the size of the Earth, and so the amplitude variations are essentially independent of baseline length. Maximal amplitude fluctuations (where the RMS is equal to the mean flux density) are seen for pulsars in the strong scattering regime (see e.g. Walker, 1998), which can be predicted from Galactic electron distribution models. The NE2001 model (Cordes and Lazio, 2002) predicts that strong scintillation should be observed for PSR J0630–2834, PSR J1559–4438, PSR J2048–1616, PSR J2144–3933 and PSR J2145–0750. An example is shown for PSR J1559–4438 in Figure 5.4a, which shows the variation of visibility amplitude with time for Tidbinbilla baselines over a 2 hour period. Observed scintillation parameters for target pulsars are shown in Table 5.3. Assuming the material responsible for the scintillation is turbulent, with a Kolmogorov distribution, the scintillation time τ_{scint} and scintillation bandwidth B_{scint} can be scaled to the frequencies used in these observations with the relations $\tau_{\text{scint}} \propto \nu^{1.2}$ and $B_{\text{scint}} \propto \nu^{4.4}$ (Cordes et al., 1986).

Left uncorrected, the variation in visibility amplitude with time scatters power throughout the image plane, as shown in Figure 5.4c, which shows the residuals for PSR J1559–4438 after fitting a single point source to the visibilities shown in Figure 5.4a. To overcome this, a ParselTongue script was written to produce an AIPS SN table which would flatten visibility amplitudes by averaging data over all sensitive baselines to 1/4 of the scintillation time, normalizing, and taking the square root to obtain an antenna based correction. The visibility weights were then scaled by the inverse of the square of the correction, upweighting points when the amplitude was high and downweighting points of low significance. The

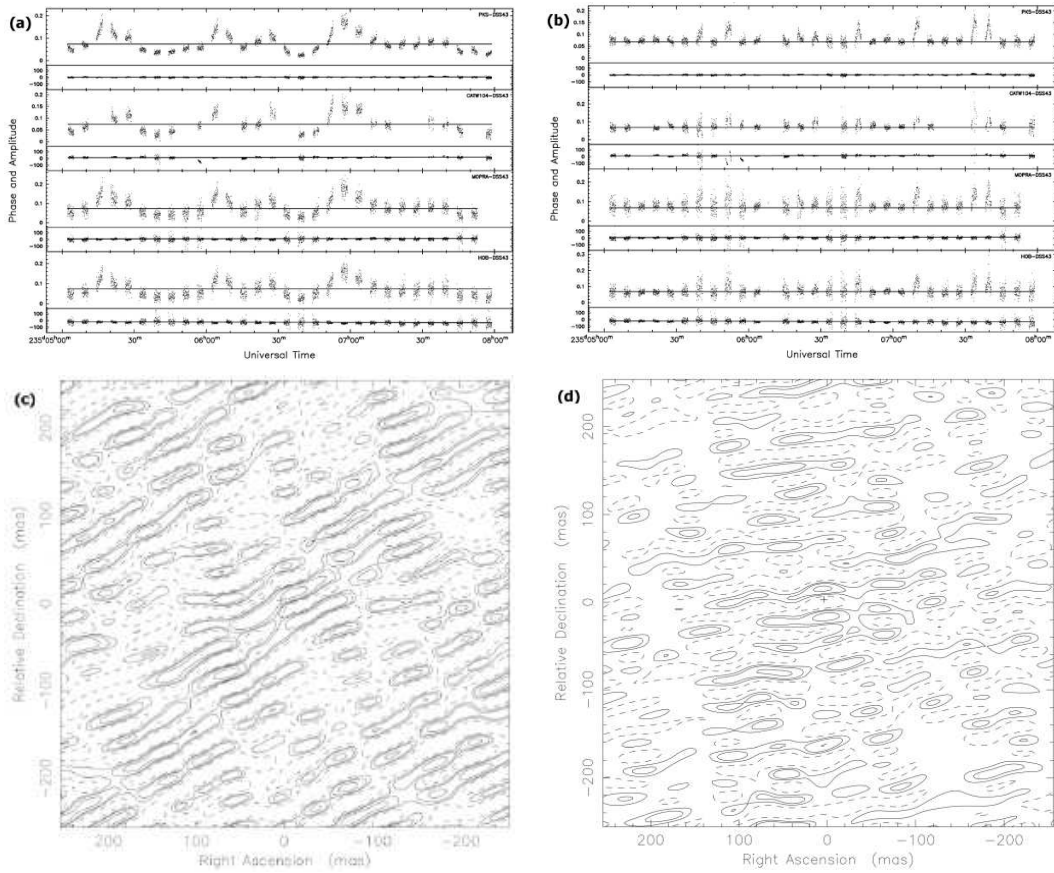

Figure 5.4 The effects of diffractive scintillation for PSR J1559-4438. Panel a) shows the uncorrected visibility amplitude on baselines including the Tidbinbilla antenna from one experiment – the scintillation timescale of several minutes is apparent. Panel b) shows the same visibility amplitudes after correcting for scintillation. Panel c) shows the image residuals of the uncorrected dataset – contours are 1,2,4 and 8 mJy/beam. Panel d) shows image residuals after correcting for scintillation, with contours at 1,2 and 4 mJy/beam – the improvement in image quality is obvious.

Table 5.3. Observed pulsar scintillation parameters and estimated scattering disk sizes

| Pulsar name | Scintillation time (s) | Scintillation bandwidth (MHz) | Observing frequency (MHz) | Reference | Scattering disk size ^a (mas, 1650 MHz) |
|-------------|------------------------|-------------------------------|---------------------------|------------------------|---|
| J0108–1431 | * ^b | * | * | Johnston et al. (1998) | 0.003 |
| J0437–4715 | 600 | 17.4 | 660 | Johnston et al. (1998) | 0.052 |
| J0630–2834 | 456 | 0.2 | 327 | Bhat et al. (1999) | 0.022 |
| J0737–3039A | > 70 ^c | 1.4 ^d | 1400 | Coles et al. (2005) | 0.406 |
| J1559–4438 | 77 | 0.16 | 660 | Johnston et al. (1998) | 0.133 |
| J2048–1616 | 138 | 0.54 | 327 | Bhat et al. (1999) | 0.023 |
| J2144–3933 | 1500 | 2.9 | 660 | Johnston et al. (1998) | 0.126 |
| J2145–0750 | 1510 | 1.48 | 436 | Johnston et al. (1998) | 0.046 |

^aCalculated from decorrelation bandwidth where available, and taken from NE2001 model where scintillation measurements are unavailable

^bScintillation parameters have not been measured, but are believed to be extremely large, as expected for a very nearby pulsar

^cVaries considerable with orbital velocity – values quoted for highest transverse velocity

^dColes, private communication

effect of these corrections is shown in Figures 5.4b and 5.4d, which show the visibility amplitudes and image residuals respectively. In this example, the signal to noise ratio (SNR) of the detection is improved by a factor of two when the visibility amplitudes are corrected for scintillation, which reduces the position determination error by a corresponding factor.

5.4 Positional determination and parallax fitting

The calibrated visibilities for each pulsar were averaged in frequency, written to disk and loaded into DIFMAP. A single delta function model component was initialized at the peak of the dirty image, and the modelfit command used to obtain the best fit for the pulsar visibility data. Each observing band, as well as the combined dataset, was then imaged separately using uniform weighting (as before with a bin size of 2 pixels and weights set to predicted baseline SNR) producing 8 images which were saved and read back into AIPS using the task FITLD. Variations to the weighting scheme are discussed in Section 5.5.3. The AIPS task JMFIT was used to determine the pulsar position and formal (SNR-based) errors in the image plane. Systematic offsets of several (3–6) mas were observed at all epochs between the 4 bands that were only contributed to by the three ATNF antennas, and the 4 bands common to all antennas. The magnitude and direction of these offsets varied between epochs, and so the ATNF-only bands (which additionally had formal errors of approximately five times the other bands, primarily due to the shorter baselines) were dropped. It is suspected that these offsets were caused by the lack of an accurate amplitude self-calibration solution for these bands.

For each pulsar, the best fit values of J2000 position (right ascension and declination), proper motion (right ascension and declination) and parallax were initially determined by iteratively minimising the error function calculated by summing the value of predicted minus actual position over all measurements, weighted by the individual measurement errors. The iterative minimisation code used is described in Brisken et al. (2002), and accounts for the covariances between parameters when calculating the uncertainty of fitted parameters. A reference time for the proper motion was chosen to be 31 Dec 2006 (MJD 54100) to minimize proper motion uncertainty contributions to be position uncertainty.

This approach yields error estimates for the 5 fitted parameters which are almost certainly an underestimate, for two reasons:

1. There are systematic errors, varying from band to band within an epoch (intra-epoch errors) such as the residual unmodeled differential ionosphere, bandpass effects etc, and varying from epoch to epoch (inter-epoch errors) caused by effects dependent on observing time, such as seasonal or diurnal ionospheric variations, and variations in refractive scintillation image wander (Rickett, 1990). These should increase the error on each individual measurement, but estimating the magnitude of the systematic component for each individual measurement is poorly constrained.
2. Each measurement is assumed to be completely independent, whereas as noted above correlated errors are expected between measurements from the same epoch. In essence, this approach overestimates the number of independent measurements, lowering the reduced chi-squared and implying a better fit than the actual result.

It is possible to make an estimate of the magnitude of the intra-epoch errors by comparing the scatter in fitted positions from the individual bands. Forming a weighted centroid position for each epoch utilising all measurements from that epoch allows an estimation of the likelihood that the measured points are consistent with that centroid, through the calculation of a reduced chi-squared value. If the reduced chi-squared value exceeds unity, the presence of unmodeled systematic errors can be inferred.

Since there is no a priori knowledge of the systematic error distribution, an equal systematic error was allocated to to each measurement, and added in quadrature to the original measurement error. The errors in right ascension and declination are treated separately. This is necessarily an iterative procedure, since the weighted centroid will be altered by the addition of these systematic error estimates. In effect, this assumes a zero mean, gaussian distribution for the systematic errors. Although this is unlikely to be the true distribution, it is the most reasonable assumption available, and certainly

more correct than assuming no systematic errors at all. The intra-epoch systematic error estimate for an epoch is obtained when the reduced chi-squared reaches unity.

Once a single position measurement and error has been calculated for each epoch, the fit to position, parallax and proper motion was re-calculated, and the reduced chi-squared of the fit inspected again. Since the degrees of freedom were reduced, the addition of systematic errors did not always result in a lowering of reduced chi-squared. The presence of inter-epoch systematic errors was inferred if the reduced chi-squared remained greater than unity. Again, without knowledge of the underlying distribution of these errors, it was decided to apportion an equal amount to each epoch, iterating until a reduced chi-squared of unity was obtained. As with intra-epoch errors, right ascension and declination were treated separately.

Thus, the final astrometric dataset for each pulsar consisted of a single position measurement for each epoch, with a total error equal to the weighted sum of the individual band formal errors, added in quadrature to the estimates of intra-epoch and inter-epoch systematic errors.

For each pulsar, the robustness of error estimation after the inclusion of estimated systematic contributions was checked by implementing a bootstrap technique. Bootstrapping, which involves repeated trials on samples selected with replacement from the population of measured position points, is a statistical technique allowing the estimation of parameter errors without a complete knowledge of the underlying distribution (Press et al., 2002). It differs from Monte Carlo analysis in that bootstrapping uses the original sample set as a population to draw from, whereas Monte Carlo techniques generate data samples based upon assumed parameter distributions. In this instance, the original single band position measurements were taken as the population, and N samples were drawn, where N was the original number of measurements. Each bootstrap consisted of 10,000 such trials, and the parameter errors estimated from the variance of the resultant distributions. A minimum of 3 different epochs needed to be included to ensure a fit was possible - on the rare occasion that a trial did not satisfy this requirement, it was re-drawn.

Thus, three sets of fitted parameters and errors were obtained for each pulsar - a “naive” result using the single-band positions (which generally possessed a reduced chi-squared greater than 1.0), a bootstrap result, and a more conservative estimate which attempts to account for the impact of systematic errors (the “inclusive” fit). In general, the estimated magnitude of errors on fitted parameters increased through these three different schemes. Typically, the ratio in the errors on the inclusive fit to those on the naive fit ranged from 0.95 to 1.90. The final error values obtained from the inclusive fit

are the most accurate estimation possible, and are believed to be inherently conservative. All quoted errors are 1σ unless otherwise stated.

Pulsar positions are given in the ICRF frame, and position errors are the formal astrometric fit errors only and do not include the component due to reference source position uncertainty. With the exception of B0736–303, all reference sources have been previously observed in ICRF or VLBA Calibrator Series (VCS) observations, and possess position uncertainties ranging from 0.8 mas to 1.6 mas. B0736–303 was observed using the VLBA in phase-referencing mode, with ICRF source B0736–332 used as a calibrator. This relative astrometry obtained the position of B0736–303 in the ICRF frame, but the precision was limited to tens of milliarcseconds, due to the large differential ionospheric contribution at the low elevation of the sources for the VLBA.

This position error is unacceptably large, and accordingly the position of B0736–303 was “reverse-engineered” from the astrometric fit to the position of PSR J0737–3039A/B. Since the position of PSR J0737–3039A/B is known to better than one mas in the Solar System reference frame, and the Solar System frame and ICRF are aligned at the several mas level, the VLBI position obtained from the astrometric fit could be compared to the timing position and a calibrator offset deduced. As with the VLBA phase referencing to B0736–332, a small position offset due to phase referencing errors can be expected, but as PSR J0737–3039A/B is much closer to B0736–303 (~ 20 arcminutes, as opposed to three degrees for B0736–332), and is observed at higher elevation using the LBA, these residual errors are much smaller. As described in Section 6.1.2, the position of B0736–332 was adjusted to ensure a match between the timing and VLBI positions for PSR J0737–3039A/B, resulting in a final positional accuracy for B0736–303 estimated at approximately five mas. In hindsight, phase-referencing of B0736–303 to B0736–332 should also have been performed using the LBA, but insufficient time was available for such an observation after this position error was discovered, and a single LBA observation would be unlikely to improve on the estimated five mas accuracy eventually determined for B0736–303.

5.5 Technique check: PSR J1559–4438

5.5.1 Initial results

Using the techniques described above, initial results were obtained for PSR J1559–4438 (shown in Table 5.4). The motion of PSR J1559–4438 in right ascension and declination is shown in Figure 5.5, along with the fitted path according to the inclusive fit. The fit is

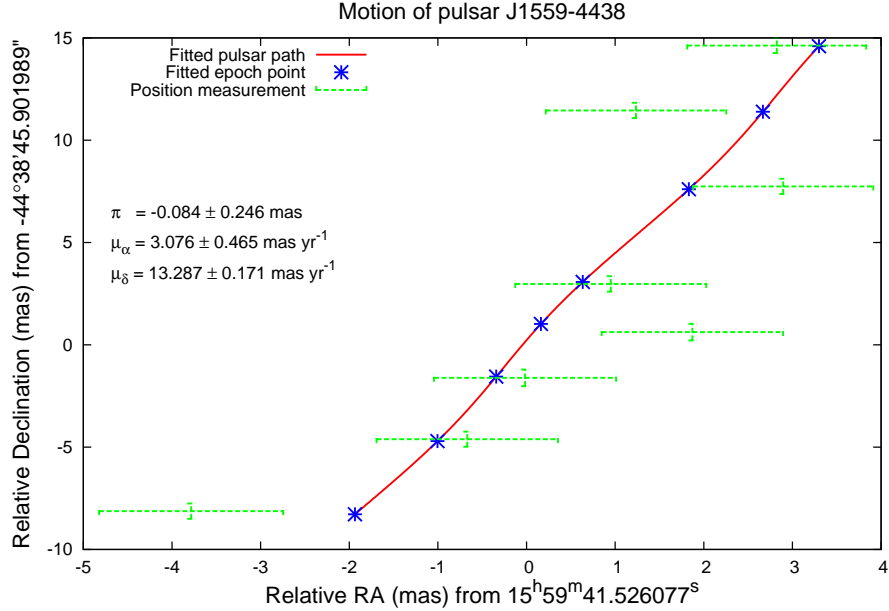

Figure 5.5 Motion of the pulsar in right ascension and declination, with measured positions overlaid on the best fit. Sensitivity-weighted visibilities were used. The motion of the pulsar is positive in right ascension and declination. The first epoch (lower left) is clearly inconsistent.

clearly unsatisfactory, since it predicts a negative parallax (though consistent with zero). The final column of Table 5.4 shows that systematic errors far exceed the nominal single-epoch positional accuracies, and inspection of Figure 5.5 shows that the first epoch (MJD 53870) is markedly discrepant with the remaining epochs.

As shown below, fine-tuning of the data reduction is required in order to obtain optimal results from each pulsar, in particular with regard to the details of the ionospheric corrections and the visibility weighting schemes used in imaging. The steps taken for PSR J1559–4438 are described below in Sections 5.5.2 and 5.5.3.

5.5.2 Ionospheric correction

The obvious source of the large systematic errors present in the initial fit shown in Section 5.5.1 is the varying ionospheric correction between epochs. Accordingly, as a first check, the position fits for each epoch were recalculated after subtracting the differential ionospheric correction between PSR J1559–4438 and its phase reference – in effect, removing the applied ionospheric correction and leaving the data uncorrected for ionospheric effects. This was implemented using a ParselTongue script which made a two-point inter-

Table 5.4. Initial results (sensitivity-weighted visibilities) for PSR J1559–4438

| Parameter | Naive fit | Bootstrap fit | Inclusive fit |
|--------------------------------------|-----------------------------|-----------------------------|-----------------------------|
| Right ascension (J2000) | 15:59:41.526092 ± 0.000005 | 15:59:35.526093 ± 0.000031 | 15:59:41.526077 ± 0.000026 |
| Declination (J2000) | -44:38:45.902028 ± 0.000017 | -44:38:45.902034 ± 0.000062 | -44:38:45.901989 ± 0.000102 |
| μ_α (mas yr ⁻¹) | 2.64 ± 0.07 | 2.65 ± 0.44 | 3.08 ± 0.46 |
| μ_δ (mas yr ⁻¹) | 13.36 ± 0.02 | 13.36 ± 0.06 | 13.29 ± 0.17 |
| π (mas) | -0.066 ± 0.038 | -0.054 ± 0.193 | -0.083 ± 0.245 |
| Nominal distance (pc) | -15100 | -18500 | -11900 |
| Nominal v_t (km s ⁻¹) | -974 | -1190 | -770 |
| Reduced chi-squared | 8.8 | | 1.0 |
| Mean epoch fit error (mas) | | | 0.198 |
| Intra-epoch sys. error (mas) | | | 0.097 |
| Inter-epoch sys. error (mas) | | | 1.070 |

polation between adjacent calibrator scans to calculate the differential correction to the target (which was not absorbed into the fringe-fit), which was stored in a CL table and subtracted using the AIPS task SPLAT. The applied values were saved for later analysis.

Intuitively, the largest ionospheric corrections would be expected when the angular displacement of the pulsar from the sun is small, since this angular separation (along with the level of solar activity) is the largest influence on the TEC. The angular displacement at each epoch between the original fitted position and the position obtained when ionospheric correction was removed is presented in Table 5.5, and plotted against angular separation of the pulsar from the sun at the time of observation in Figure 5.6. The revised astrometric fit obtained without ionospheric correction is plotted in Figure 5.7.

It is immediately apparent from Figure 5.6 that the first epoch (MJD 53870) is discrepant in that the position shift due to ionospheric correction is unusually large, given the large angular separation from the Sun. As shown in Figure 5.7, this epoch becomes more consistent with the fit when the ionospheric correction is removed, this epoch becomes more consistent with the fit, but the third epoch (MJD 54057) becomes much more inconsistent. This is unsurprising, however, since this epoch had the smallest pulsar–Sun separation and the largest ionospheric corrections.

To investigate whether the chosen ionospheric map was at fault, the first epoch was re-reduced with all available maps from the NASA CDDIS archive⁵, but no significant change was found in fitted position. Given that the different TEC maps make use of many of the same GPS stations, this is unsurprising. This problem is exacerbated at southern declinations due to the low density of GPS receivers at southern latitudes. Additionally, any errors in the TEC maps would have an impact $\sim 40\%$ greater for this first epoch, due to its lower observing frequency of 1400 MHz, compared with the 1650 MHz center frequency used for all subsequent observations.

⁵<ftp://cddis.gsfc.nasa.gov/pub/gps/products/ionex/>

Table 5.5. Average position shift due to ionospheric corrections for PSR J1559–4438

| Epoch MJD | RA shift (mas) | Dec shift (mas) | Sun separation (deg) |
|-----------|----------------|-----------------|----------------------|
| 53870 | –5.36 | 0.27 | 153.5 |
| 53970 | –1.34 | 0.15 | 96.4 |
| 54057 | –6.61 | 0.39 | 25.8 |
| 54127 | –3.15 | –0.07 | 63.0 |
| 54182 | –2.66 | 0.35 | 113.6 |
| 54307 | –2.51 | 0.34 | 120.1 |
| 54413 | –3.68 | 0.20 | 30.8 |
| 54500 | –2.89 | 0.05 | 69.8 |

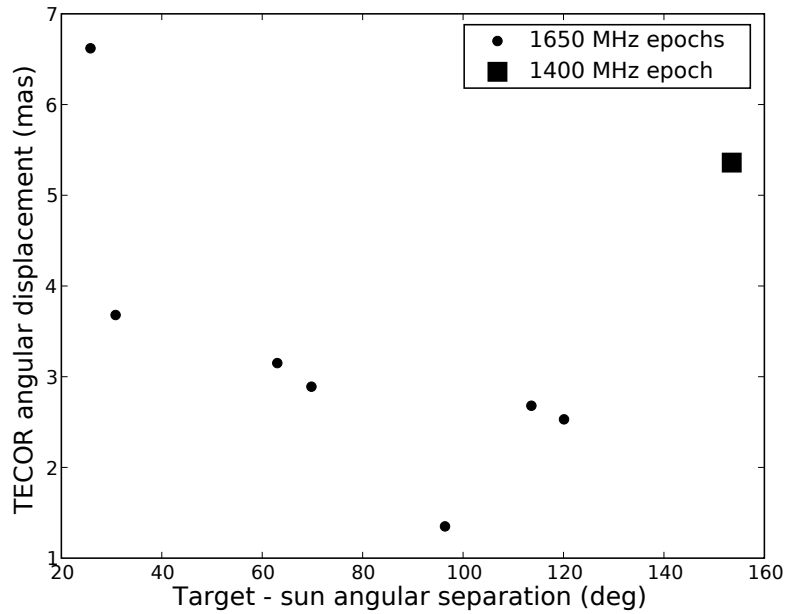

Figure 5.6 Shift in fitted position due to ionospheric correction for PSR J1559–4438 vs angular separation between the pulsar and the Sun. The single 1400 MHz epoch has an unusually large correction given the large angular separation between the pulsar and the Sun.

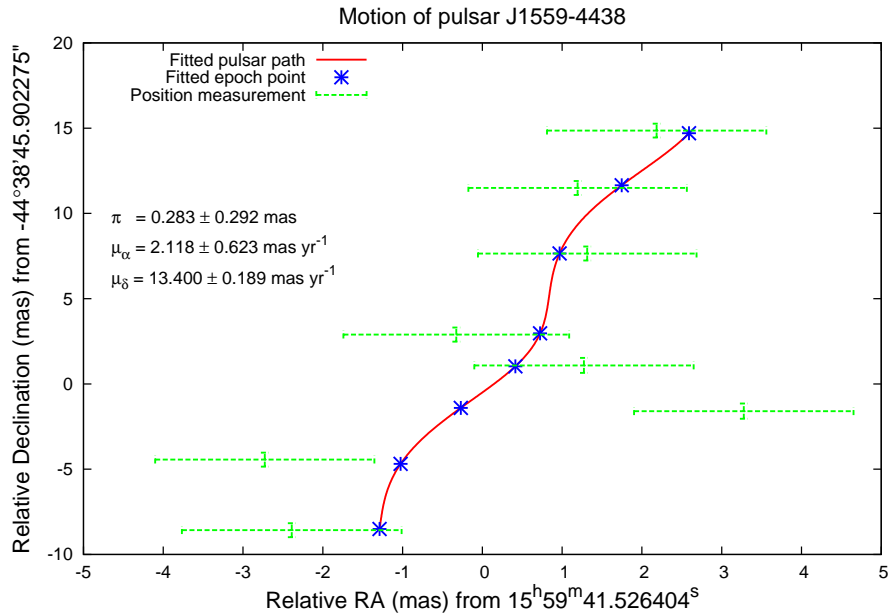

Figure 5.7 Motion of the pulsar in right ascension and declination, with measured positions overlaid on the best fit, when ionospheric corrections have been removed. Sensitivity-weighted visibilities were used. The first epoch (lower left) is now more consistent, but the third epoch (during which the pulsar–Sun angular separation was only 26 degrees) is now inconsistent.

Thus, due to the probability of residual ionospheric errors for this epoch, and also the potential for frequency-dependent calibrator source structure, the first epoch (MJD 53870, the only 1400 MHz epoch) was dropped from all further analysis. The fit to the remaining seven epochs, with ionospheric corrections re-enabled, is shown in Figure 5.8. While a realistic fit is now obtained, the measurement of parallax is still not significant.

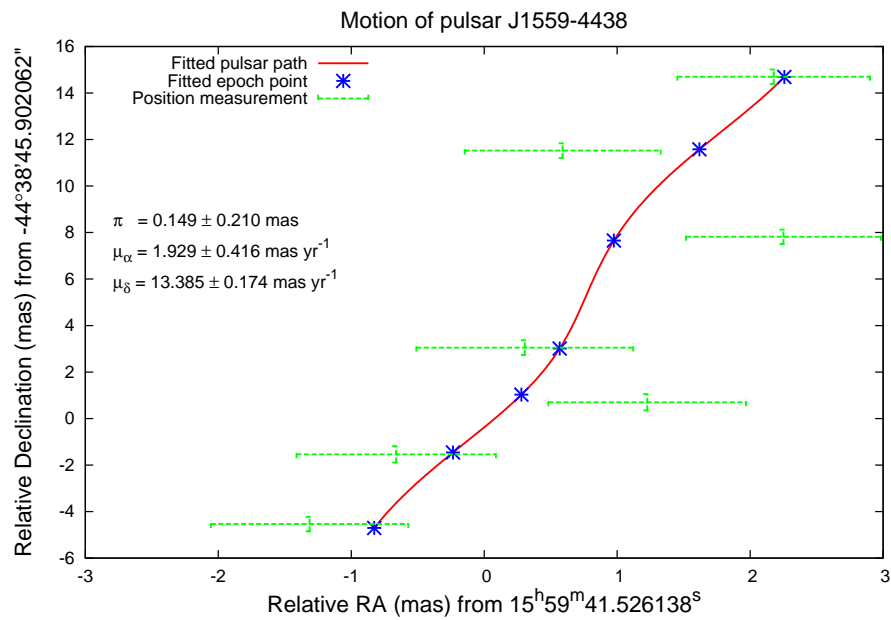

Figure 5.8 Motion of the pulsar in right ascension and declination, with measured positions overlaid on the best fit, with ionospheric corrections reinstated but the first epoch dropped. Sensitivity-weighted visibilities were used. The fit is improved considerably.

5.5.3 Data weights

Initial pulsar imaging and position fitting used visibilities weighted according to the best estimate of instantaneous baseline sensitivity. Whilst this is theoretically optimal for data which consists only of signal S and additive random thermal errors E_{therm} , it fails to account for the presence of multiplicative systematic errors $E_{\text{sys}} = e^{i\phi_{\text{sys}}(t)}$ caused by residual calibration errors. Typically, these systematic errors are dominated by atmospheric and ionospheric gradients, although other contributions include antenna and calibrator source position errors, time-variation of antenna bandpasses, and instrumental phase jitter. Fomalont (2005) presents a theoretical review of phase referencing errors, while Pradel et al. (2006) presents a simulation-based approach.

If $\phi_{\text{sys}}(t)$ had zero-mean and was ergodic, its effect would be indistinguishable from thermal noise and could be easily estimated, allowing the visibility weights to be corrected. For antenna/source position errors and large-scale atmospheric/ionospheric structure, however, the residual errors are correlated over long times, causing systematic shifts in the fitted position for the target.

When normal sensitivity-based weighting is employed in the presence of substantial and persistent systematic phase errors, the systematic noise on the most sensitive baseline will be absorbed into the fit, at the cost of a poorer fit to the less sensitive baselines. The magnitude of the induced error will be dependent on the ratio of systematic to thermal errors, and the discrepancy in sensitivity between the most and least sensitive baselines in the array. For the LBA, the most sensitive baseline (Parkes-DSS43: system equivalent flux density 30 Jy) is roughly 13 times more sensitive than the least sensitive (Hobart-Mopra: 380 Jy). Thus, the LBA is particularly susceptible to the influence of systematic errors, due to the pronounced variation in baseline sensitivities.

The systematic errors can be crudely estimated (in a model-dependent fashion) by performing phase-only self-calibration on the target pulsar over a sufficiently long timescale to obtain sufficient SNR, and comparing the magnitude of the corrections to those expected from thermal noise alone. While this approach probes systematic errors over a somewhat shorter time period than those which would dominate for inter-epoch errors (tens of minutes, rather than hours), it is illustrative of the presence of systematic errors overall. Such corrections are shown in Figure 5.9 for the ATCA station using a three-minute solution interval during the observation on MJD 54127. The corrections are clearly correlated over timescales of tens of minutes, and the RMS deviation of 4.4° is an order of magnitude greater than the estimated thermal phase RMS of 0.4° (calculated in this high-SNR limit as station sensitivity divided by target flux density, scaled by pulse filtering gain

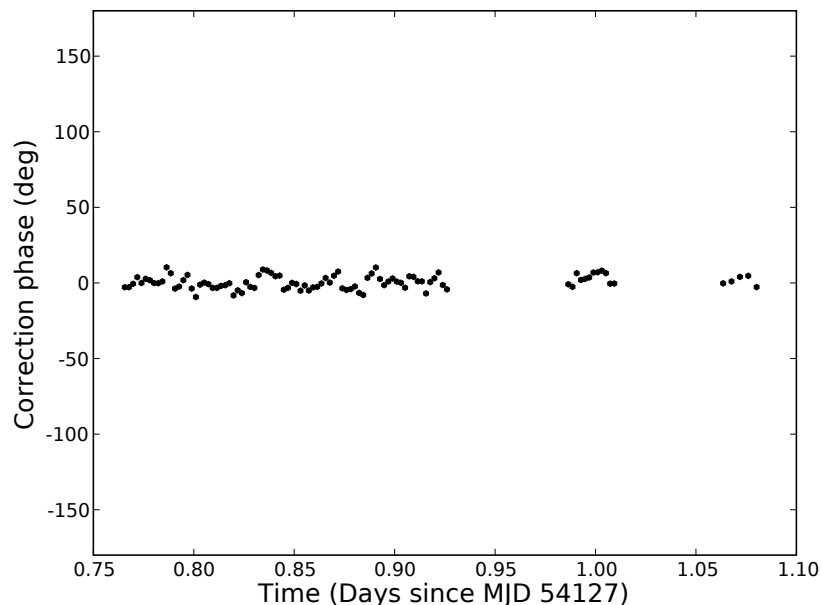

Figure 5.9 Self-calibration corrections, using a three-minute timescale, for the ATCA station on PSR J1559–4438. Clear systematic deviations are seen from the zero-mean distribution expected from purely thermal noise. The RMS of the corrections exceeds those expected due to thermal noise by an order of magnitude.

and converted from radians to degrees). Thus, for this observation, systematic errors \gg thermal errors and weighting visibilities by sensitivity actually degrades the quality of the position fit.

If the average E_{sys} could be accurately estimated for each baseline over the duration of an experiment, the baseline visibility weights could be adjusted by assuming that E_{sys} is time-invariant. Even more desirable would be the estimation of E_{sys} as a function of time, allowing a time-variable adjustment of the visibility weights. Given present instrumentation, there is no way to reliably estimate systematic error (time dependent or independent) in a model independent fashion. In the limit where $E_{\text{sys}} \gg E_{\text{therm}}$, however, the visibility weight for each baseline (regardless of sensitivity) will be dominated by the systematic error contribution, resulting in approximately equal weights for all visibilities. Accordingly, visibility weights for all baselines were reset to an equal, constant value and data reduction repeated. The results are discussed below in Section 5.5.4.

5.5.4 Final results

The revised fit obtained using equally weighted visibility data is described in Table 5.6 and plotted in Figure 5.10. Through comparison of Table 5.6 with Table 5.4, it can be seen that the average fit error for a single epoch has increased by 20%, but the inter-epoch systematic error has decreased by 95%. Thus, while using equally weighted data incurs a small sensitivity penalty, it benefits significantly through the reduced susceptibility to systematic errors. The fitted distance of 2600 pc is consistent with the NE2001 distance of 2350 pc, as well as HI absorption measurements which imply a lower distance limit of 2000 ± 500 pc (Koribalski et al., 1995). The implications of this distance measurement are discussed in Section 6.2.3.

The use of natural weighting, as opposed to uniform weighting, was investigated but found to produce inferior results. Fitted parameters remained relatively constant but errors on the fitted parameters increased by $\sim 50\%$. This is unsurprising, since the use of natural weighting promotes a larger beamsize due to the concentration of more visibility points at small uv distances. Natural weighting is obviously more likely to prove useful when $E_{\text{therm}} \gg E_{\text{sys}}$, and its use for the weakest target pulsars is shown in Chapter 6.

5.6 Optimal data weighting

From the results shown in Sections 5.5.3 and 5.5.4, it is clear that for PSR J1559–4438 the astrometric error budget is dominated by systematic errors, and that the use of equally weighted visibility points is optimal. However, Table 5.1 shows that this may not be the case for other pulsars in the target sample, as some are orders of magnitude fainter than PSR J1559–4438. Accordingly, the conditions under which sensitivity-weighted visibilities give superior results to equally-weighted visibilities were investigated. This was carried out by adding simulated thermal noise of varying RMS to the existing dataset.

Three “noisy” datasets D_A , D_B , and D_C were constructed by adding zero-mean, gaussian-distributed noise to the real and imaginary visibility components of the original observations. Since the theoretical single epoch SNR for sensitivity-weighted data should be ~ 800 (a factor of 10 greater than the typically obtained SNR), the RMS of the added noise in the three datasets was set to predicted baseline sensitivity scaled by a factor of 20, 40, and 80, which should allow a maximum single-epoch SNR of 40, 20 and 10 respectively. The results of fitting the modified datasets (using the inclusive fit approach only) with and without the use of sensitivity weighting are presented in Tables 5.7 and 5.8 respectively.

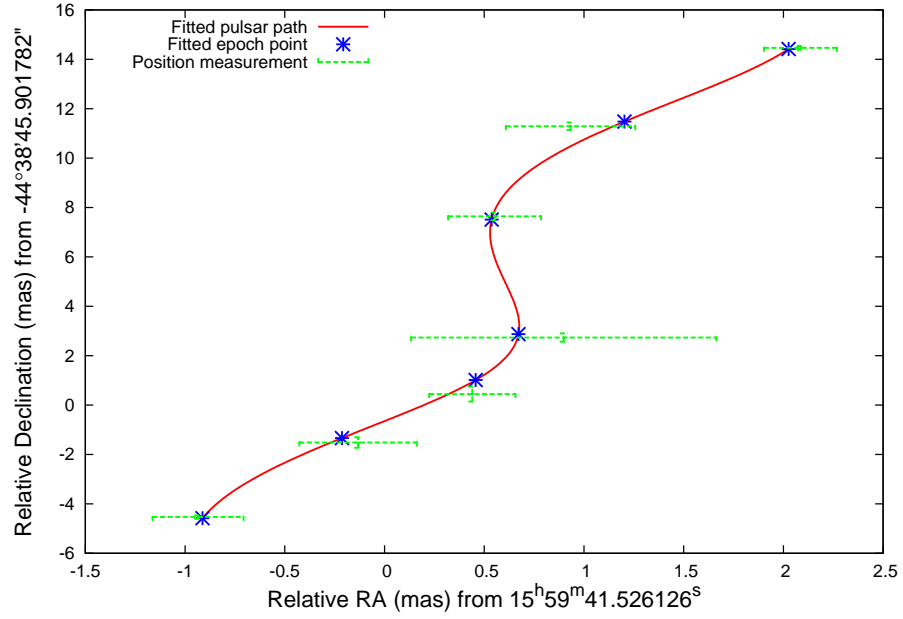

Figure 5.10 Motion of the pulsar in right ascension and declination, with measured positions overlaid on the best fit, with ionospheric corrections reinstated but the first epoch dropped. Equally weighted visibilities were used, mitigating systematic errors and allowing for the first time a significant measurement of the parallax for this pulsar.

Table 5.6. Final results (equally weighted visibilities) for PSR J1559–4438

| Parameter | Naive fit | Bootstrap fit | Inclusive fit |
|--------------------------------------|-----------------------------|-----------------------------|-----------------------------|
| Right ascension (J2000) | 15:59:41.526121 ± 0.000006 | 15:59:35.526121 ± 0.000008 | 15:59:41.526126 ± 0.000008 |
| Declination (J2000) | -44:38:45.901849 ± 0.000020 | -44:38:45.901859 ± 0.000072 | -44:38:45.901778 ± 0.000035 |
| μ_α (mas yr ⁻¹) | 1.62 ± 0.08 | 1.60 ± 0.16 | 1.52 ± 0.14 |
| μ_δ (mas yr ⁻¹) | 13.20 ± 0.02 | 13.21 ± 0.08 | 13.15 ± 0.05 |
| π (mas) | 0.280 ± 0.048 | 0.291 ± 0.111 | 0.384 ± 0.081 |
| Nominal distance (pc) | 3570 | 3440 | 2600 |
| Nominal v_t (km s ⁻¹) | 225 | 217 | 164 |
| Reduced chi-squared | 3.6 | | 1.0 |
| Mean epoch fit error (mas) | | | 0.242 |
| Intra-epoch sys. error (mas) | | | 0.259 |
| Inter-epoch sys. error (mas) | | | 0.055 |

Table 5.7. Noise-added fits for PSR J1559–4438, sensitivity-weighted visibilities

| Parameter | D_A | D_B | D_C |
|--------------------------------|---------------------------------|---------------------------------|---------------------------------|
| Right ascension (J2000) | 15:59:41.526163 \pm 0.000027 | 15:59:35.526086 \pm 0.000025 | 15: 59:41.526025 \pm 0.000041 |
| Declination (J2000) | -44:38:45.902054 \pm 0.000154 | -44:38:45.902131 \pm 0.000163 | -44:38:45.901760 \pm 0.000258 |
| μ_α (mas yr $^{-1}$) | 2.03 \pm 0.46 | 1.44 \pm 0.59 | 2.83 \pm 0.79 |
| μ_δ (mas yr $^{-1}$) | 13.39 \pm 0.24 | 13.40 \pm 0.21 | 13.00 \pm 0.44 |
| π (mas) | 0.109 \pm 0.278 | 0.270 \pm 0.373 | 0.621 \pm 0.579 |
| Nominal distance (pc) | 9200 | 3700 | 1610 |
| Nominal v_t (km s $^{-1}$) | 590 | 237 | 102 |
| Reduced chi-squared | 1.0 | 1.0 | 0.5 |
| Mean epoch fit error(mas) | 0.441 | 0.904 | 1.308 |
| Intra-epoch sys. error (mas) | 0.504 | 1.412 | 0.863 |
| Inter-epoch sys. error (mas) | 0.769 | 0.315 | 0.0 |
| Average single-epoch SNR | 33 | 17 | 9 |

Table 5.8. Noise-added fits for PSR J1559–4438, equally weighted visibilities

| Parameter | D_A | D_B | D_C |
|--------------------------------|---------------------------------|---------------------------------|---------------------------------|
| Right ascension (J2000) | 15:59:41.526142 \pm 0.000026 | 15:59:35.526115 \pm 0.000042 | 15:59:41.526268 \pm 0.000084 |
| Declination (J2000) | -44:38:45.901745 \pm 0.000076 | -44:38:45.902220 \pm 0.000234 | -44:38:45.901798 \pm 0.000420 |
| μ_α (mas yr $^{-1}$) | 0.91 \pm 0.38 | 0.22 \pm 0.99 | -0.04 \pm 1.20 |
| μ_δ (mas yr $^{-1}$) | 13.18 \pm 0.10 | 13.56 \pm 0.32 | 12.65 \pm 0.65 |
| π (mas) | 0.544 \pm 0.235 | 0.760 \pm 0.597 | 2.092 \pm 0.787 |
| Nominal distance (pc) | 1840 | 1320 | 480 |
| Nominal v_t (km s $^{-1}$) | 115 | 85 | 29 |
| Reduced chi-squared | 0.8 | 1.0 | 0.9 |
| Mean epoch fit error(mas) | 0.618 | 0.937 | 1.853 |
| Intra-epoch sys. error (mas) | 0.791 | 1.433 | 1.531 |
| Inter-epoch sys. error (mas) | 0.000 | 0.380 | 0.000 |
| Average single-epoch SNR | 20 | 10 | 5 |

Tables 5.7 and 5.8 show that while the equally weighted dataset performs better for D_A , when the average epoch SNR is still high, its performance rapidly deteriorates as the epoch SNR decreases. In D_C , the pulsar was not detected in several epochs using equally-weighted data. The reduction in performance is less marked for the weighted datasets, although they are clearly still affected by systematic errors. However, if the pulsar was closer and the parallax larger, these systematics would be less dominant, and weighted datasets would allow measurement of a parallax when equally weighted datasets may be overwhelmed by thermal errors, to the point of not detecting the pulsar in a single epoch.

As noted in Section 5.5.3, the use of weighted visibility points would always be optimal if the weights could include an estimate of the systematic error contribution to that visibility. In the absence of such an estimate, the results obtained in this investigation lead to the guideline that for the LBA (with typical observing conditions and calibrator throws), the transition region from systematic to thermal error dominated astrometry occurs when the single-epoch detection SNR falls to approximately 10 for equally-weighted visibilities. This is shown by the similarity of result quality for D_B , where the average epoch SNR was approximately 10 for the equally-weighted visibilities. Alternatively, both

weighting regimes can be used and average total single-epoch error (formal + systematic) can be compared to estimate the optimal weighting scheme. Again, this is borne out in the simulated datasets, where a transition from systematic errors dominating to epoch fit errors dominating is seen as more noise is added. These guidelines have been applied to the results obtained in Chapter 6.

5.7 Contributions to systematic error

The major contributions to systematic error in VLBI astrometry include geometric model errors (station/source position, Earth Orientation Parameters), residual ionospheric and tropospheric errors, variable phase reference source structure, and image wander due to refractive scintillation. Of these, at 1650 MHz residual ionospheric errors would be expected to dominate, despite the a priori ionospheric calibration employed (e.g. Brisken et al., 2002).

It is difficult to estimate the magnitude of the potential correlation between epochs of the residual ionospheric errors, due to the model-dependence of the ionospheric correction. Whilst some correlation is likely, it is unlikely to dominate, due to the significant variability inherent in the ionosphere. Residual tropospheric errors also have the potential for some correlation from epoch to epoch, for example due to imperfect modeling of seasonal atmospheric variations. Residual tropospheric errors, however, should be considerably smaller than the ionospheric errors.

Geometric model errors cause relative astrometric errors which increase with calibrator throw. Earth Orientation Parameters (EOPs) are well determined by geodetic observations and make minimal contributions to astrometric errors (Pradel et al., 2006). Similarly, the mean position of well-determined calibrators makes a minimal contribution. Some LBA stations, however, have position uncertainties of several cm, which could make a several hundred μas contribution to systematic error. The magnitude of the error depends on the source declination and the calibrator-target separation. Given similar uv coverage at different epochs, however, the offset will be largely constant with time and is absorbed into the reference position of the target. Future planned geodetic observations will continue to improve LBA station positions, and reduce this systematic contribution. Additionally, as noted in Section 5.3.2, small station position errors can be corrected post-correlation, which offers the potential to further improve previous position fits.

Refractive image wander is caused by large-scale fluctuations in the ISM, and can be estimated based on the strength of the pulsar scattering and the scattering disk size (e.g. Rickett, 1990). For strong scattering, which includes PSR J1559-4438, the image wander

is less than the scattering disk size, if Kolmogorov turbulence is assumed for the scattering material (Rickett, 1990). Thus, since Table 5.3 shows that scattering disk of PSR J1559–4438 is estimated to be only $133 \mu\text{as}$ at 1650 MHz, the maximum refractive image wander is $\ll 100 \mu\text{as}$, and can be discounted as a source of systematic error. Table 5.3 shows that refractive scintillation is unlikely to be significant for any of the pulsars targeted in this thesis.

The variability of calibrator structure with time depends on the source chosen, but all compact extragalactic radio sources are expected to show some variability, with typical RMS values of $100 \mu\text{as}$ (Fomalont, 2005). This image wander may be correlated from epoch to epoch over short time periods and absorbed into proper motion fits, but over long times (which could be longer than an astrometric observing program), the mean apparent position will be constant. Some sources, such as B2201+315 and B1739+522 (an “other” and “candidate” member of the ICRF, respectively), have shown apparent motion of many hundreds of mas per year, which can persist for up to several years (Titov, 2007). As detailed long-term information is not available for any of the reference sources used in this work, the impact on proper motion due to source variability is difficult to quantify, but the stability of the fitted models used for amplitude refinement (as discussed in Section 5.3.3) suggests that any reference source variability is likely to be small. As shown in the following chapter, formal errors for proper motion measurements are only accurate to several hundred μas per year for most pulsars, and so the contribution of reference source variability is likely to be minimal in most cases.

The magnitude of observed systematic errors, and the correlation of systematic errors with calibrator structure and angular separation from the target, are investigated further with the full pulsar set in Section 6.4 and used to estimate the astrometric accuracy which can be obtained with present and future VLBI arrays.

6

ASTROMETRIC RESULTS AND INTERPRETATION

The data obtained for each pulsar were processed using the pipeline described in Chapter 5, applying the guidelines developed to minimise the total astrometric error budget. Table 6.1 shows the fitted parameters for each target pulsar, as well as estimates of mean thermal and systematic errors. Unless otherwise stated, all errors are 1σ .

The implications of the measured values are discussed for each pulsar in turn in Sections 6.1 and 6.2 below, with the analysis for PSR J0437–4715 closely following that presented in Deller et al. (2008), the analysis for PSR J0737–3039A/B closely following that presented in Deller et al. (2009a), and the analysis for PSR J1559–4438 closely following that presented in Deller et al. (2009b). In Sections 6.3 and 6.4, the revised distance and velocity measurements for all pulsars are used to estimate the accuracy of pulsar distance and velocity models, and predict the astrometric accuracy that will be achievable with future VLBI observations.

6.1 Binary millisecond pulsars

As discussed in Section 2.2.5, a variety of fascinating physics can be probed using binary millisecond pulsars, such as tests of GR and neutron star formation events. The three binary pulsars targeted in this program were chosen because uncertainty regarding their true distance was limiting the science which could otherwise be achieved with the system. While significant parallaxes were observed for PSR J0437–4715 (120σ) and PSR J0737–3039A/B (6σ), no parallax could be detected for PSR J2145–0750, which had previously been unsuccessfully targeted with the VLBA (Briskin et al., 2002). The implications of the distance and velocity measurements for each pulsar are discussed below.

Table 6.1. Astrometric fits for all target pulsars

| Parameter | PSR J0108-1431 | PSR J0437-4715 | PSR J0630-2834 | PSR J0737-3039 |
|--|------------------------------------|---------------------------------------|-----------------------------------|--------------------------------------|
| Right ascension (J2000) | 01:08:08.347016 ± 0.000088 | 04:37:15.883250 ± 0.000003 | 06:30:49.404393 ± 0.000043 | 07:37:51.248419 ± 0.000026 |
| Declination (J2000) | -14:31:50.187139 ± 0.001069 | -47:15:09.031863 ± 0.000037 | -28:34:42.778813 ± 0.000372 | -30:39:40.714310 ± 0.000099 |
| μ_α (mas yr ⁻¹) | 75.05 ± 2.26 | 121.679 ± 0.05 | -46.30 ± 0.99 | -3.82 ± 0.62 |
| μ_δ (mas yr ⁻¹) | -152.54 ± 1.65 | -71.820 ± 0.09 | 21.26 ± 0.52 | 2.13 ± 0.23 |
| π (mas) | 4.170 ± 1.421 | 6.396 ± 0.054 | 3.009 ± 0.409 | 0.872 ± 0.143 |
| Distance (pc) | 240 ⁺¹²⁴ ₋₆₁ | 156.3 ^{+1.3} _{-1.3} | 332 ⁺⁵² ₋₄₀ | 1150 ⁺²²⁰ ₋₁₆₀ |
| v_t (km s ⁻¹) | 194 ⁺¹⁰⁴ ₋₅₁ | 104.7 ^{+1.0} _{-1.0} | 80 ⁺¹⁵ ₋₁₁ | 24 ⁺⁹ ₋₆ |
| Visibility weighting | Sensitivity | Equal | Equal | Sensitivity |
| Image weighting | Natural | Uniform | Uniform | Natural |
| Average epoch mean fit error (mas) | 1.232 | 0.059 | 0.765 | 0.747 |
| Average intra-epoch systematic error (mas) | 2.477 | 0.068 | 0.839 | 0.939 |
| Average inter-epoch systematic error (mas) | 4.310 | 0.103 | 1.205 | 0.0 |
| Average single-epoch SNR | 8 | 21 | 15 | 17 |

| Parameter | PSR J1559-4438 | PSR J2048-1616 | PSR J2144-3933 | PSR J2145-0750 ^A |
|--|--------------------------------------|-------------------------------------|-----------------------------------|-----------------------------|
| Right ascension (J2000) | 15:59:41.526126 ± 0.000008 | 20:48:35.640637 ± 0.000040 | 12:44:12.060404 ± 0.000045 | 21:45:50.461901 ± 0.000098 |
| Declination (J2000) | -44:38:45.901778 ± 0.000035 | -16:16:44.553501 ± 0.000147 | -39:33:56.885041 ± 0.000316 | -07:50:18.462388 ± 0.000558 |
| μ_α (mas yr ⁻¹) | 1.52 ± 0.14 | 114.24 ± 0.52 | -57.89 ± 0.88 | -15.43 ± 2.07 |
| μ_δ (mas yr ⁻¹) | 13.15 ± 0.05 | -4.03 ± 0.24 | -155.90 ± 0.54 | -7.67 ± 0.81 |
| π (mas) | 0.384 ± 0.081 | 1.712 ± 0.909 | 6.051 ± 0.560 | - |
| Distance (pc) | 2600 ⁺⁶⁹⁰ ₋₄₅₀ | 580 ⁺⁶⁶⁰ ₋₂₀₀ | 165 ⁺¹⁷ ₋₁₄ | - |
| v_t (km s ⁻¹) | 163 ⁺⁴⁴ ₋₂₉ | 317 ⁺³⁶² ₋₁₁₁ | 130 ⁺¹⁴ ₋₁₂ | - |
| Visibility weighting | Equal | Equal | Equal | Sensitivity |
| Image weighting | Uniform | Uniform | Natural | Natural |
| Average epoch mean fit error (mas) | 0.242 | 0.517 | 1.025 | 2.136 |
| Average intra-epoch systematic error (mas) | 0.259 | 1.282 | 1.450 | 0.0 |
| Average inter-epoch systematic error (mas) | 0.055 | 0.105 | 0.875 | 0.0 |
| Average single-epoch SNR | 50 | 23 | 10 | 8 |

^ABased on two detections, with parallax fixed at 0. Variation of the parallax value between 0 and 2 mas results in less than 100 $\mu\text{as yr}^{-1}$ difference in derived proper motion.

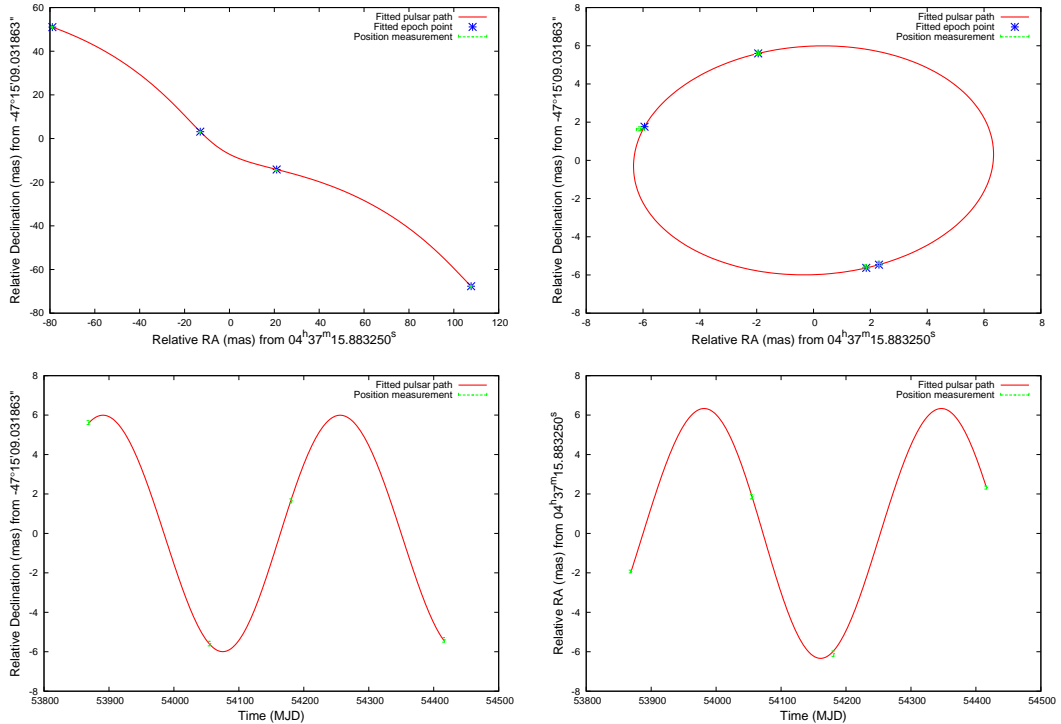

Figure 6.1 Motion of PSR J0437–4715, with measured positions overlaid on the best fit. Clockwise from top left: Motion in declination vs right ascension; as before but with proper motion subtracted; right ascension vs time with proper motion subtracted; and declination vs time with proper motion subtracted.

6.1.1 PSR J0437–4715

PSR J0437–4715 is the brightest and nearest observed millisecond pulsar, and has also been studied in the optical (Bell et al., 1993), ultraviolet (Kargaltsev et al., 2004), and X-ray (Zavlin et al., 2002) bands since its discovery by Johnston et al. (1993). The high rotational stability and close proximity of this pulsar–white dwarf binary system make it an excellent probe of General Relativity (GR) and alternate forms of gravitational theories. The measurement of its Shapiro delay by van Straten et al. (2001) is one such test which has shown consistency with GR predictions. The search for the low frequency stochastic gravitational wave background (GWB) using pulsar timing arrays (e.g. Jenet et al., 2005) is another test of GR which is facilitated in part by timing of PSR J0437–4715.

VLBI results

Figure 6.1 shows the fitted and measured positions for PSR J0437–4715, and the full set of fitted parameters is shown in Table 6.1. The distance of 156.3 ± 1.3 pc derived for PSR

J0437–4715 from these observations is the most accurate distance measurement (in both absolute and fractional distance) for a pulsar to date and approaches the most accurate distance measurements made of objects outside the Solar System (T Tauri, 147.6 ± 0.6 pc: Loinard et al., 2007). Previously, the highest-precision VLBI pulsar distance determinations were those made by Brisken et al. (2002), who measured the distance of PSR J0953+0755 to an accuracy of 5 pc, along with 8 other Northern Hemisphere pulsars. The two previous parallax measurements made using a southern array, of PSR J0835–4510 (Dodson et al., 2003) and PSR J1456–6843 (Bailes et al., 1990), had 1σ distance errors of 19 and 70 pc respectively.

The distance to PSR J0437–4715 estimated from the TC93 model (140 pc) and the NE2001 model (189 pc) is within $\sim 20\%$ of the measured distance of 156.3 ± 1.3 pc in both cases. Previous timing parallaxes of PSR J0437–4715 (Hotan et al., 2006; van Straten et al., 2001; Sandhu et al., 1997) have yielded considerable variation in measured parallax, the cause of which is ascribed to the inaccuracy of earlier Solar System ephemerides (Verbiest et al., 2008). These observations, which are independent of the Solar System ephemeris, provide confirmation that the earlier measurements of timing parallax were inaccurate.

Previous measurements of the transverse speed of PSR J0437–4715 using scintillation observations have also provided widely varying results. Johnston et al. (1998) measured a scintillation speed of 170 km s^{-1} assuming a distance of 180 pc, while Gothoskar and Gupta (2000) measured 231 km s^{-1} , also assuming a distance of 180 pc. Neither of these values are consistent with the well-determined VLBI value of $104.7 \pm 1.0 \text{ km s}^{-1}$. As discussed in Section 6.3.1, errors in scintillation speed estimates of this magnitude are not uncommon, and may often be due to the simplifying assumptions made about the scattering material.

Comparison to timing astrometry

To compare the VLBI and timing positions, the timing data of Verbiest et al. (2008) have been re-fitted to obtain the position of PSR J0437–4715 at the VLBI reference epoch (MJD 54100). Table 6.2 shows that the timing and VLBI positions at MJD 54100 differ by over two mas, many times the formal errors shown. However, the formal errors are negligible compared to the uncertainty in the VLBI phase reference calibrator position (0.8 mas; Ma et al., 1998), and the potential constant offsets due to phase-referencing errors such as station position errors (known to exist at the cm level for the LBA; Deller et al., 2009b). Discrepancies between interferometric and timing positions of even larger magnitudes have been found using the DE200 frame (Bartel et al., 1996), and differences at the mas level still exist for the position PSR J0437–4715 calculated using the newer DE414 solar system

Table 6.2. Fitted VLBI results for PSR J0437–4715 and comparative timing values (positions re-referenced to the VLBI proper motion epoch)

| Parameter | Fitted value and error | Verbiest et al. (2008) timing values |
|--|---|---|
| Right Ascension (J2000) | $04^{\text{h}}37^{\text{m}}15.883250^{\text{s}} \pm 0.000003$ | $04^{\text{h}}37^{\text{m}}15.883185^{\text{s}} \pm 0.000006$ |
| Declination (J2000) | $-47^{\circ}15'09.031863'' \pm 0.000037$ | $-47^{\circ}15'09.034033'' \pm 0.000070$ |
| μ_{α} (mas/yr) | 121.679 ± 0.052 | 121.453 ± 0.010 |
| μ_{δ} (mas/yr) | -71.820 ± 0.086 | -71.457 ± 0.012 |
| Parallax π (mas) | 6.396 ± 0.054 | 6.65 ± 0.51 |
| Distance (pc) | 156.3 ± 1.3 | $157.0 \pm 2.4^{\text{A}}$ |
| Transverse velocity v_{T} (km/s) | 104.71 ± 0.95 | $104.9 \pm 1.6^{\text{A}}$ |
| Reduced chi-squared | 1.0 | |
| Average epoch mean fit error (mas) | 0.059 | |
| Average intra-epoch systematic error (mas) | 0.068 | |
| Average inter-epoch systematic error (mas) | 0.103 | |
| Reference epoch for proper motion (MJD) | 54100.0 | 54100.0 |

^ADerived from the kinematic distance obtained from \dot{P}_{b} , not the less precise parallax values

ephemeris, as compared to the DE405 ephemeris used by Verbiest et al. (2008). Thus, it is concluded that the VLBI and timing position difference is consistent with the uncertainty in the calibrator position and the offset between the solar system frame and the ICRF.

The parallax value obtained from VLBI is consistent with that derived from timing, and yields a distance which is consistent with the kinematic distance of 157.0 ± 2.4 pc derived from the orbital period derivative \dot{P}_{b} . However, the VLBI parallax measurement is an order of magnitude more precise than the timing measurement, and yields a distance which is a factor of two more precise than the kinematic distance.

Finally, the values obtained for proper motion from VLBI differ by $\sim 4\sigma$ in both right ascension and declination from the values estimated from pulsar timing. A likely cause for this discrepancy is small changes in the centroid position of the phase reference source due to intrinsic source variability, which would be absorbed into the astrometric fit. If the centroid position change is roughly linear over the timescale probed, the effects would largely be absorbed into the measured proper motion. Titov (2007) show that some ICRF sources exhibit apparent proper motions of hundreds of $\mu\text{as yr}^{-1}$ for periods of several years. Whilst the calibrator used here (J0439–4522) has not previously been the target of detailed variability studies such as those undertaken by Titov (2007), it is possible to use archival observations to show that centroid position changes are a plausible explanation for the proper motion discrepancy, as shown below.

First, the VLBI data obtained during this thesis on J0439–4522 can be inspected directly for evidence of variability. The model used for J0439–4522 in this thesis consisted of a ~ 1 mas FWHM Gaussian, with two additional delta components within 5 mas of strength 2% and 0.2% of peak flux. There is no gross evidence of variability over the four

observational epochs, as the width and positions of the primary and secondary components remained constant to within $\sim 200 \mu\text{as}$, and secondary fluxes remained constant to $\sim 1 \text{ mJy}$. However, as the source is only barely resolved (the beamsize is $\sim 3 \text{ mas}$) positional variability at the $\sim 100 \mu\text{as}$ level would be difficult to detect. An indirect indicator of the past variability of the source can instead be obtained from calibrator measurements using the ATCA¹. These show that the total flux density on ATCA baselines has declined by a factor of three in a near-linear manner over a four year period from 2004 to 2007. On the shortest timescales probed by this archival data (several months) departures from the linearly decreasing trend on the order of 10% of the total flux are seen.

The commensurate ATCA observations taken simultaneously with VLBI observations during this thesis are unsuited to accurate flux monitoring, due to the compact array configurations used and the lack of ATCA flux calibrator scans, which are unnecessary for VLBI. Thus, the archival ATCA observations provide the best available means for estimating source variability. The steady decrease in flux level is consistent with a near-linear change in the source centroid, which would be absorbed into the proper motion estimate. Smaller non-linear centroid changes are also possible, which would affect not only the proper motion, but also the parallax estimated from the VLBI measurements. However, the limited amount of short-term variability seen is consistent with a mostly linear change in position centroid. Thus, the archival ATCA data supports the theory that centroid changes in the phase reference calibrator are responsible for the difference between the VLBI and timing measurements of proper motion, and indicates that the effect of the reference source variability on parallax is likely to be considerably smaller.

The higher proper motion precision obtained with the timing data (a factor of 5–7 times better than the VLBI results) reflects the fact that the timing data spans a time baseline 7 times longer than the VLBI dataset.

Limits on anomalous accelerations

The newly measured parallax of $\pi = 6.396 \pm 0.054 \text{ mas}$ allows an improved measurement of any anomalous acceleration of either the Solar System or PSR J0437–4715. Specifically, the apparent acceleration due to time variability of Newton’s gravitational constant G and the mass of an undetected trans-Neptunian planet near the line of sight to the pulsar can be limited.

As first described by Damour and Taylor (1991), a precise measurement of a binary pulsar’s orbital period derivative, \dot{P}_b , can be used to constrain a variation of the gravita-

¹<http://www.narrabri.atnf.csiro.au/cgi-bin/Calibrators/calthis.cgi?source=0437-454&band=3cm>

tional constant, G . However, as Bell and Bailes (1996) pointed out, for PSR J0437–4715 a precise distance needs to be known in order to correct \dot{P}_b for the Shklovskii acceleration (Shklovskii, 1970) caused by its proper motion. This analysis has been performed, based exclusively on timing data, by Verbiest et al. (2008), whose limit was dominated by the uncertainty in their parallax measurement. This VLBI parallax value improves their limit by a factor of nearly 10 down to $\dot{G}/G = (-5 \pm 26) \times 10^{-13} \text{ yr}^{-1}$ at 95% certainty. This value compares well to the most stringent limit currently published: $(4 \pm 9) \times 10^{-13} \text{ yr}^{-1}$, derived through Lunar Laser Ranging (LLR; Williams et al., 2004). Since π and \dot{P}_b are now both measured to similar precision, both measurements will have to be improved for a further significant increase in \dot{G} sensitivity. Additional VLBI observations and continued timing could see this limit improve upon the existing LLR limit early in the next decade.

An alternative source of anomalous acceleration is heavy planets in a wide orbit around the Sun or the pulsar. Building upon the initial analysis of Zakamska and Tremaine (2005), this parallax measurement can be combined with the timing results from Verbiest et al. (2008) to derive the following result: $a_{\odot}/c = (3 \pm 16) \times 10^{-20} \text{ s}^{-1}$ at the 2σ level. This improves the limit published in Verbiest et al. (2008) by an order of magnitude and makes PSR J0437–4715 a more sensitive Solar System accelerometer than PSR J1713+0747, the most precise pulsar listed by Zakamska and Tremaine (2005). From this, the limit for 50% of the sky² can be calculated as: $|a_{\odot,50\%sky}/c| \leq 3.9 \times 10^{-19} \text{ s}^{-1}$ (95% certainty). This acceleration limit can be used to exclude massive bodies within a given radius of the Sun; for example, at Kuiper–belt radii (50 AU) it excludes a planet more massive than Uranus over 50% of the sky, while Jupiter–mass planets are excluded within 226 AU over 50% of the sky.

Impact of the stochastic GWB

Using tools recently developed by Hobbs et al. (2008), the effect of a stochastic GWB on the observed value of \dot{P}_b from pulsar timing has been simulated. The characteristic strain spectrum of the GWB was set to that of the best published GWB limit (Jenet et al., 2006), with dimensionless amplitude $A = 1.1 \times 10^{-14}$ at a period of one year and power–law dependence on frequency with exponent $\alpha = -2/3$ (as predicted for a GWB dominated by black hole–black hole mergers). The simulated GWB causes the kinematic distance to be inconsistent with the VLBI parallax distance at the 2σ level in $\sim 50\%$ of trials. Thus, although these observations cannot improve upon the present GWB limit, they are consistent with it. Simulations with a GWB with amplitude of 1.1×10^{-13} show

²within 60° of the line of sight towards and away from PSR J0437–4715

inconsistencies between the kinematic and VLBI distances at the 2σ level in 95% of trials, providing an independent exclusion of a GWB with an amplitude at or above this value.

It is also interesting to note that the precise limit on \dot{G} presented above would be impossible in a Universe with a strong GWB. In the simulations with GWB amplitude 1.1×10^{-13} , the observed \dot{G} value is inconsistent with 0 in 99% of cases, merely due to the GWB-induced corruption of the timing measurements. Thus, the stochastic GWB must eventually limit the accuracy of measurements of \dot{G} in the fashion outlined here.

6.1.2 PSR J0737–3039A/B

The double pulsar system PSR J0737–3039A/B (Burgay et al., 2003; Lyne et al., 2004) is one of only eight known double neutron star (DNS) systems, and the only system in which both neutron stars are visible as pulsars. The discovery of the mildly recycled “A” pulsar was reported by Burgay et al. (2003), but emission from the companion “B” pulsar was not observed at the time, and it was not discovered until follow-up observations some time later (Lyne et al., 2004). PSR J0737–3039A/B is the most relativistic known binary system, with an orbital period of only 2.5 hours and a coalescence time (due to orbital energy loss to gravitational radiation) of 85 Myr. PSR J0737–3039A/B provides the best current tests of General Relativity (GR), with Kramer et al. (2006) recently showing that measurements of the post-Keplerian parameter “s” agreed with the GR prediction to within 0.05%. The discovery of PSR J0737–3039A also led to a marked upward revision in the estimated Galactic merger rate of DNS systems (Kalogera et al., 2004), although merger rate estimates are still very uncertain due to the poor constraints available on the characteristics of the DNS population.

One of the major outstanding uncertainties surrounding PSR J0737–3039A/B is its distance. Kramer et al. (2006) detect a marginally significant timing parallax of 3 ± 2 mas, but this is no more accurate than what is typically assumed for distances estimated from dispersion measures in the NE2001 distance model. The NE2001 DM distance estimate for PSR J0737–3039A/B is 480 pc, while the earlier TC93 model estimates the distance to be 570 pc. Many previous studies (e.g. Kramer et al., 2006; Burgay et al., 2003) have assumed the rounded distance of 500 pc when calculating luminosity and kinematic values. As discussed below, the accurate distance and velocity information for this system presented here enables tests of GR to proceed to greater precision in the future, as well as providing insight into its formation and x-ray emission.

VLBI results

As shown earlier in Table 5.1, PSR J0737–3039A/B was clearly the most challenging target undertaken in this program – with an equivalent gated 1600 MHz flux density³ of 4 mJy, it is almost as faint as PSR J0108–1431, but with a DM distance four times greater, a factor of four greater precision was required to attain an equivalent parallax accuracy. Whilst a very nearby (angular separation ~ 20 arcminutes) calibrator was available (B0736–303), Figure 5.2 shows that it presented a particular challenge, as it was weak (correlated flux density ~ 30 mJy on 1000 km baselines), possessed complicated structure, and its position was not known precisely in the ICRF. As noted in Section 5.4, the position of B0736–303 was refined using a phase-referenced VLBI observation, and finally determined to approximately five mas accuracy by comparison of the VLBI position for PSR J0737–3039A/B with its published timing position (Kramer et al., 2006). Whilst this is a relatively large positional uncertainty, the short calibrator throw means that the resultant differential errors are small.

The complex structure and positional uncertainty in the phase reference source introduces an extra element of model-dependence to the results obtained for PSR J0737–3039A/B. The final result obtained for parallax differed by 2σ from the initial result, which was obtained when the calibrator position was in error by approximately 50 mas. After the calibrator position was updated, several different calibrator models were produced (model A, which used Gaussian model components; model B, which used standard CLEAN components; and model C, which used a combination of the two) and the results compared. In each case, the model was held constant over all epochs. The clean images of the combined dataset for B0736–303 (visibilities from all epochs concatenated into a single file) are shown in Figure 6.2 for models A, B and C (which is the model shown in Figure 5.2, but is shown again here for clarity).

As shown in Figure 6.2, model C gives a significantly better fit to the data, resulting in lower image residuals than model A or model B. The data reduction for PSR J0737–3039A/B was repeated three times using models A, B and C, and the resultant position datasets were fit for parallax and proper motion. The results of this analysis showed that model C gave a significantly better fit ($\pi = 0.87 \pm 0.14$ mas) than model A ($\pi = 1.06 \pm 0.18$ mas) or B ($\pi = 0.76 \pm 0.20$ mas).

Model C was thus clearly the best source model, and was chosen for the final results presented in Table 6.1. Since any residual model-dependent errors are likely to be small (and difficult to quantify in any case, but on the order of the formal errors or smaller)

³Since pulsar A dominates the radio emission, gating was performed using the pulsar A ephemeris only

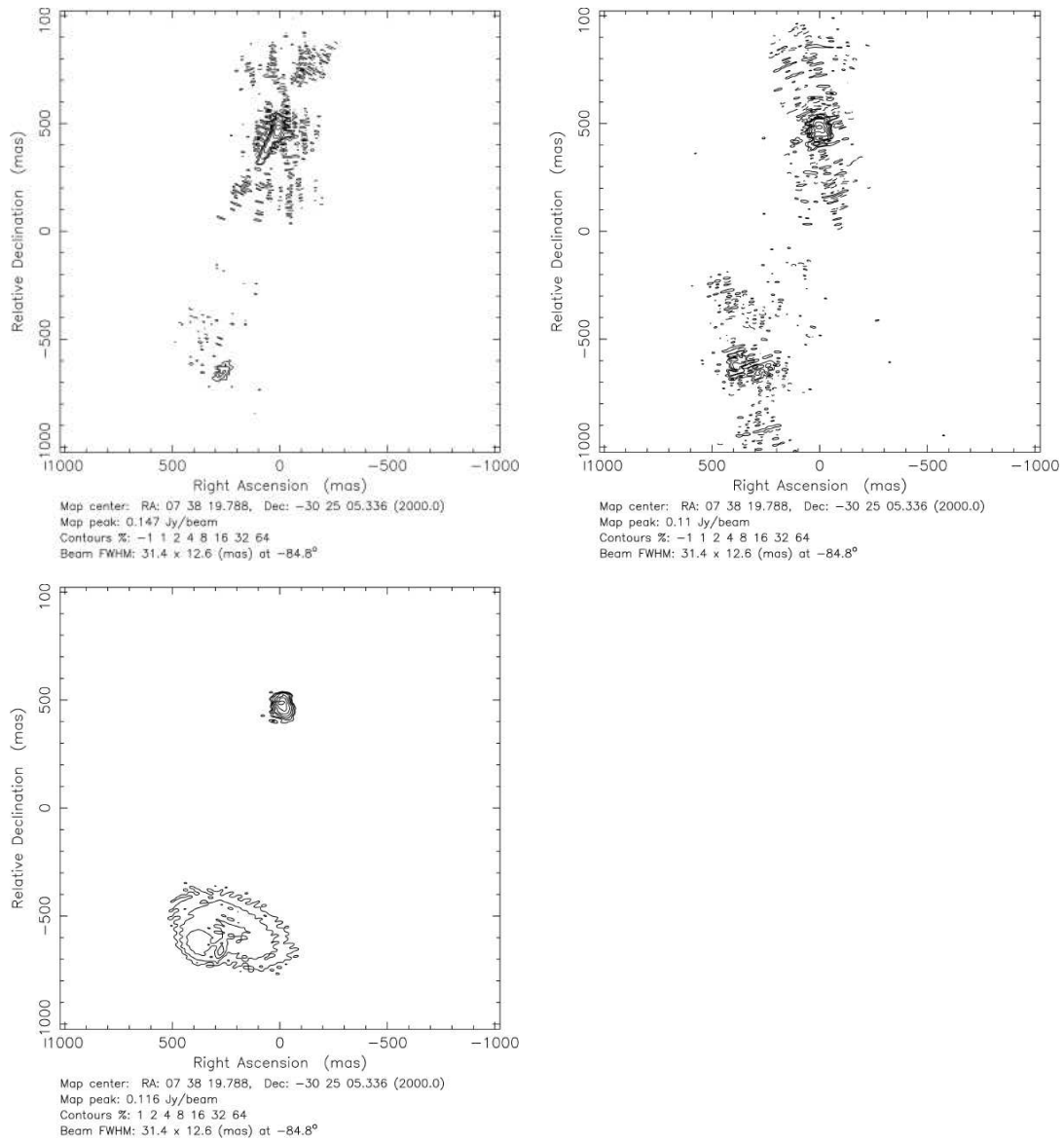

Figure 6.2 Images of B0736-303, using Gaussian model components only (model A, top left), CLEAN components only (model B, top right) and a combination of Gaussian and CLEAN components (model C, bottom left). Images contours are at 1, 2, 4, 8, 16, 32 and 64% of peak flux density in each case. Model C clearly gives the best fit to the data.

the error given for PSR J0737–3039A/B in Table 6.1 and the discussion below is simply the “inclusive” astrometric fit error described in Section 5.4 and does not include the uncertainty due to calibrator structure discussed here. However, it is worth noting that the some uncertainty due to the calibrator source structure remains, and if the model could be improved by additional observations with better uv coverage in the future then the astrometric data could be re-reduced, with the potential for a slightly improved fit.

Figure 6.3 shows the final fitted and measured positions for PSR J0737–3039A/B. The measured parallax for PSR J0737–3039A/B (0.872 ± 0.143 mas) corresponds to a distance of 1150_{-160}^{+220} pc. The successful measurement of parallax and proper motion by this program represents the first significant parallax and proper motion determination for a DNS system. At 95% confidence, the lower limit for the distance is 860 pc – still considerably in excess of the predicted DM distance for the system. The revised value of electron density along the line of sight to PSR J0737–3039A/B is 0.043 cm^{-3} , which suggests the influence of the Gum nebula along this sightline is less than originally thought.

The measured transverse velocity for PSR J0737–3039A/B is $24_{-6}^{+9} \text{ km s}^{-1}$. However, when the best estimates of peculiar motion of the Solar System and Galactic rotation (e.g. Mignard, 2000) are subtracted in order to obtain a velocity in the local standard of rest, the resultant transverse velocity is $9_{-3}^{+6} \text{ km s}^{-1}$. This is well within the range of transverse velocities expected for the massive stars which are progenitors for NS–NS binaries ($\sim 20 \text{ km s}^{-1}$; see e.g. Feast and Shuttleworth, 1965), and such a low value is extremely unlikely unless both kicks imparted on the system by the supernova events which formed the pulsars were extremely small. If the PSR J0737–3039A/B system does have a large velocity, it must be predominantly in the radial direction – a possibility discussed in detail below where possible formation models for the system are considered.

Comparison to timing astrometry

The parallax measurement made through these VLBI observations is consistent with the timing value of 3 ± 2 mas obtained by Kramer et al. (2006), but it is considerably more precise. The values obtained for proper motion ($\mu_\alpha = -3.82 \pm 0.62 \text{ mas yr}^{-1}$, $\mu_\delta = 2.13 \pm 0.23 \text{ mas yr}^{-1}$) are also consistent with those obtained from timing ($\mu_\alpha = -3.3 \pm 0.4 \text{ mas yr}^{-1}$, $\mu_\delta = 2.6 \pm 0.5 \text{ mas yr}^{-1}$).

The measured transverse velocity of $24_{-6}^{+9} \text{ km s}^{-1}$ is over twice that obtained by Kramer et al. (2006), almost entirely due to the distance revision. However, this value is still considerably lower than those obtained through measurements of scintillation velocity by Ransom et al. (2004), who obtained $141 \pm 8 \text{ km s}^{-1}$, and the revised value of Coles et al. (2005), who

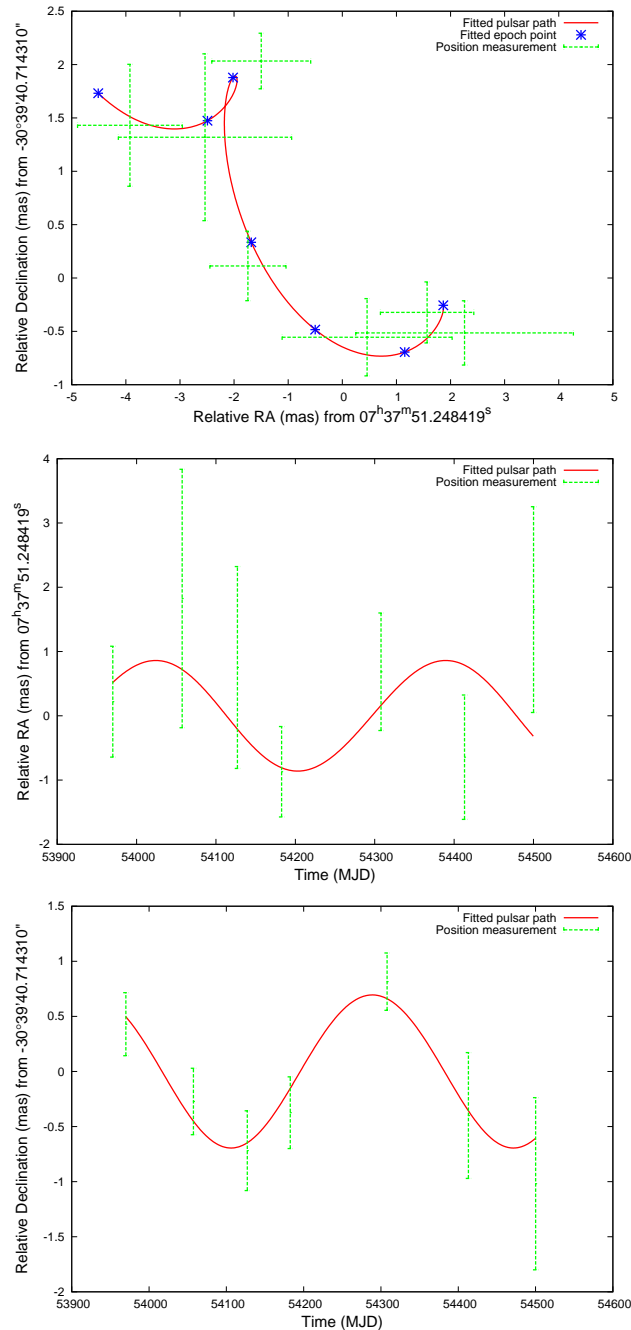

Figure 6.3 Motion of PSR J0737-3039A/B, with measured positions overlaid on the best fit. From top: Motion in declination vs right ascension; right ascension vs time with proper motion subtracted; and declination vs time with proper motion subtracted.

obtained $66 \pm 15 \text{ km s}^{-1}$. Both of these studies assumed a distance to PSR J0737–3039A/B close to the NE2001 value (570 pc). Thus, as noted by Kramer et al. (2006), it is likely that the usual scintillation velocity assumption of a thin scattering screen with an isotropic turbulence distribution is not appropriate in this case. Accounting for anisotropy in the ISM turbulence gives a measurement of scintillation velocity that is lower still, and more consistent with the VLBI transverse velocity (W. Coles et al., in preparation).

Since the timing position of PSR J0737–3039A/B was used to refine the VLBI calibrator position, no meaningful comparison can be made between the timing and VLBI positions. When corrected for proper motion to the same epoch, the timing and VLBI positions have been aligned to approximately one mas, which is the the level of errors due to proper motion uncertainty.

Finally, it is appropriate to note that the continuation of timing observations of PSR J0737–3039A/B should see a determination of parallax and proper motion to equal or greater precision than these VLBI results within the next decade.

Implications for tests of GR

One of the tests of GR possible with the PSR J0737–3039A/B system is the rate of change of orbital period (\dot{P}_b) due to the loss of energy to gravitational radiation. In order to perform this test, the observed \dot{P}_b must be measured as accurately as possible (the current significance is 70σ ; Kramer et al. 2006), and contributing factors to \dot{P}_b other than GR must be estimated as accurately as possible. For PSR J0737–3039A/B, the major contributing factors are differential Galactic rotation (\dot{P}_b^{rot}), acceleration towards the plane of the Galaxy (\dot{P}_b^z), and the apparent acceleration caused by the transverse motion of the system (the Shklovskii effect \dot{P}_b^{Shk} ; Shklovskii 1970). These will collectively be referred to as galactic and kinematic contributions (\dot{P}_b^{gk}). At the newly calculated distance of 1150 pc, the magnitude of these effects can be calculated using Equations 2.12 and 2.28 from Damour and Taylor (1991) as:

$$\frac{\dot{P}_b^{\text{rot}}}{P_b} = -\frac{v_0^2}{c R_0} \times \left(\cos l + \frac{\beta}{\sin^2 l + \beta^2} \right) \quad (6.1)$$

$$\frac{\dot{P}_b^z}{P_b} = -\frac{K_z}{c} \sin b \quad (6.2)$$

$$\frac{\dot{P}_b^{\text{Shk}}}{P_b} = \frac{\mu^2 d}{c} \quad (6.3)$$

where l , b and z are the pulsar's Galactic longitude, latitude and height respectively, d and

μ are pulsar distance and proper motion, v_0 and R_0 are the Galactic speed and radius of the Solar System (taken to be 7.5 kpc and 195 km s⁻¹ respectively; e.g. Dias and Lépine 2005), K_z is the vertical gravitational potential of the Galaxy (taken from Holmberg and Flynn 2004 as 0.45 km² s⁻² pc⁻¹ at the height of PSR J0737–3039A/B) and c is the speed of light. The dominant uncertainties are in d (16%) and μ (15%), and R_0 , v_0 and K_z , whose errors are typically estimated at $\sim 10\%$.

Equations 6.1 – 6.3 give $\dot{P}_b^{\text{rot}}/P_b = (-4.3 \pm 0.7) \times 10^{-20} \text{ s}^{-1}$, $\dot{P}_b^z/P_b = (3.8 \pm 0.8) \times 10^{-21} \text{ s}^{-1}$, and $\dot{P}_b^{\text{Shk}}/P_b = (5.3 \pm 1.8) \times 10^{-20} \text{ s}^{-1}$. Combining these terms gives $\dot{P}_b^{\text{gk}}/P_b = (1.5 \pm 2.1) \times 10^{-20} \text{ s}^{-1}$, and multiplying by the observed orbital period $P_b = 8834.5 \text{ s}$ (Kramer et al., 2006) yields the net effect of these terms on the observed orbital period derivative: $\dot{P}_b^{\text{gk}} = (1.3 \pm 1.8) \times 10^{-16}$.

These contributions to orbital period derivative are four orders of magnitude below the GR contribution, and two orders of magnitude below the current measurement error ($\dot{P}_b^{\text{obs}} = (-1.252 \pm 0.017) \times 10^{-12}$; Kramer et al. 2006). Thus, with the current measurement accuracy of distance and transverse velocity, GR tests with PSR J0737–3039A/B using \dot{P}_b can ultimately be made to the 0.01% level, although of order ten years of continued precision timing will be required to reach this accuracy⁴. As noted by Kramer et al. (2006), measuring \dot{P}_b at this level will place stringent requirements on the class of gravitational theories which predict significant amounts of dipolar, as opposed to quadrupolar, gravitational radiation, exceeding the best solar system tests. Measuring the moment of inertia of pulsar A via a measurement of the spin–orbit coupling of the system, however, would require a further order of magnitude improvement in the measurement precision of \dot{P}_b (Kramer et al., 2006). In the near future, additional VLBI and/or timing measurements can be expected to reduce both the distance and velocity errors to PSR J0737–3039A/B below 10%; however, even with negligible error in these parameters, the existing accuracy of measurements of R_0 , v_0 and K_z would limit the accuracy of \dot{P}_b measurements in this system to 0.004%. To attain the 10^{-5} precision necessary to measure the neutron star moment of inertia, the constants R_0 and v_0 must be measured to a precision approaching 1%. Such measurements may be possible within a decade via continued optical observations of stars near the Galactic center (Ghez et al., 2008), although attaining this precision is likely to be challenging.

⁴since the \dot{P}_b error scales with $t^{-5/2}$, and the current significance of 70σ was reached in 2.5 years (Kramer et al., 2006)

Implications for formation models

As noted in Chapter 2, most neutron stars are believed to receive large kicks at birth. Indeed, the discovery of the first binary pulsar PSR B1913+16 with its large orbital eccentricity ($e = 0.617$) supported this view and led to a “standard model” in which the newly-formed neutron stars in compact binaries received large kicks and were often disrupted by this and the associated mass loss (Bhattacharya and van den Heuvel, 1991)

PSR J0737–3039A/B, however, does not support the standard model. Its low orbital eccentricity of just 0.08 (Kramer et al., 2006) and low transverse velocity suggest that very close binaries might influence the evolution of the progenitor stars and prevent large mass loss and kicks during the supernova events (Podsiadlowski et al., 2005; Stairs et al., 2006). Willems et al. (2006) have argued that the observed properties of PSR J0737–3039A/B can still be explained by large kicks and significant mass loss, however Piran and Shaviv (2005) suggest almost no mass loss took place beyond the binding energy. The refinement of the local transverse velocity of the PSR J0737–3039A/B system presented here allows a comment on the competing formation models for the system.

Since, as shown above, the transverse velocity of PSR J0737–3039A/B is no greater than the likely peculiar velocity of its progenitor system, if the PSR J0737–3039A/B system received a large velocity kick, it must possess a large radial velocity. However, in a DNS system there are no observational methods available to determine the radial velocity. Due to the accurate measurement of its Shapiro delay, PSR J0737–3039A/B is known to lie edge-on (Kramer et al., 2006), and if the only kick provided to the system was provided by the loss of binding energy during the supernova explosion, the resultant 3D space velocity should be on the order of $\sim 50 \text{ km s}^{-1}$, estimated from the system’s observed eccentricity and orbital velocity (e.g. Blaauw, 1961). This velocity would be constrained to the plane of the orbit and simple geometry allows the estimation of the probability of observing a transverse velocity less than 10 km s^{-1} to be about one in eight, which is small, but not unreasonable.

Conversely, if the double pulsar had received a large kick (e.g. Willems et al., 2006), then the odds of observing such a low transverse velocity become increasingly remote. Not only would the radial velocity have to be increasingly large, but the inclination angle of the system must not be altered by the kick. Hence, the transverse velocity results shown here reinforce those of Kramer et al. (2006) and strongly favour the interpretation of Piran and Shaviv (2005), who argue for almost no mass loss and kick in the case of PSR J0737–3039A/B.

An intriguing aside to the implication of low kick velocities in PSR J0737–3039A/B–

like systems is the possible, albeit speculative, explanation this offers to the formation of the newly-discovered binary pulsar PSR J1903+0327, a fast, heavy, and highly recycled millisecond pulsar (mass 1.8 solar masses, period 2.15 ms) with a one solar mass main sequence companion (Champion et al., 2008). The formation of this system has confounded existing models, since it possesses an intermediate orbital eccentricity of $e = 0.44$, and the orbit of a highly recycled pulsar such as PSR J1903+0327 should have been circularised during the mass-transfer phase to a very high degree (Alpar et al., 1982).

If the progenitor system to PSR J0737–3039A/B had originally possessed a solar mass companion in a wide orbit as part of a triple system, then the kicks due to the PSR J0737–3039A/B supernovae would not have been sufficient to disrupt the triple system. In such a situation, PSR J0737–3039A and B would coalesce in 85 Myr due to the emission of gravitational radiation, creating either a heavy millisecond pulsar or a black hole that continues to orbit the companion star. van den Heuvel and Bonsema (1984) proposed such a merger mechanism for the creation of the first millisecond pulsar shortly after its discovery. In this scenario, the majority of the binding energy of the relativistic binary will be lost in just a few seconds, and the resultant heavy millisecond pulsar or a black hole is left in an eccentric orbit with the remaining main sequence star. The eccentricity would be determined by the amount of matter lost.

Such a system would strongly resemble PSR J1903+0327, but only if the coalescing neutron stars formed a millisecond pulsar with a low magnetic field, and approximately one solar mass was lost from the coalescing system in much less than an orbital period of the outer star. The PSR J0737–3039A/B system possesses ample angular momentum to form a fast millisecond pulsar, but the enormous energy lost as the neutron stars are disrupted may help regenerate the magnetic field of the resultant heavy neutron star. Nonetheless, the low space velocity of the PSR J0737–3039A/B system implies that such a formation pathway is realistic, and that it could potentially explain the PSR J1903+0327 system.

Implications for DNS merger rates

The size of the Galactic population of DNS systems, and hence DNS merger rate estimates, depends upon a host of assumptions including the luminosity functions and beaming fractions of recycled pulsars. As already noted, the poor constraints on the characteristics of recycled pulsars mean that the merger rate estimates remain uncertain. In many recent merger rate studies (e.g. Kalogera et al., 2004) the luminosity function of recycled pulsars (and in particular, its faint tail) has been inferred from the entire pulsar population, avoiding the small-number problem which would be inherent in attempting to model the faint

end of the recycled pulsar luminosity function directly. However, this approach would not be valid if the luminosity function of recycled pulsars differs significantly from that of the general pulsar population. Typically, multiple population models have been considered, leading to the widely varying merger rate estimates.

The distributions of beaming fraction and pulse shape for recycled pulsars are known to differ considerably from those for slower pulsars (e.g Kramer et al., 1998), and hence it is plausible that their luminosity distribution also differs markedly. The observational constraints on the luminosity functions for normal and recycled pulsars are presented in Lorimer (2008), which highlights the considerable extrapolation from the small observed sample of faint recycled pulsars. The revised distance presented here shows that the radio luminosity of PSR J0737–3039A/B is considerably greater (by a factor of five) than previously assumed. If this revision were to markedly influence the assumed luminosity distribution for recycled pulsars in DNS systems, then the assumed space density of DNS systems would be reduced, since there must be fewer systems in the Galaxy to match the number of observed systems. This would demand that estimates of the Galactic DNS merger rate and corresponding detection rates for LIGO and Advanced LIGO such as those presented in Kalogera et al. (2004) also be reduced. However, it is infeasible to make conclusive statements on the basis of the single measurement presented here, and the true recycled pulsar luminosity function is likely to remain the object of intense study for some time to come.

Implications for x-ray production

A final area in which this distance determination can contribute to understanding of the PSR J0737–3039A/B system is its x-ray emission. PSR J0737–3039A/B has been observed intensively in x-rays (McLaughlin et al., 2004; Chatterjee et al., 2007; Possenti et al., 2008; Pellizzoni et al., 2008), with the x-ray luminosity measured at $(2.3 - 2.4) \times 10^{30} \text{ erg s}^{-1}$, assuming the DM distance of 500 pc. The newly measured VLBI distance of 1150 pc means this luminosity is revised upwards to $1.2 \times 10^{31} \text{ erg s}^{-1}$. The majority of the x-ray emission is seen to be modulated at the spin period of the A pulsar (Chatterjee et al., 2007). However, there has been considerable debate over where and how the observed x-rays are generated, given the small binary separation and interaction of the pulsar wind of the A pulsar with the magnetosphere of the B pulsar (see e.g. Lyutikov, 2004) which provide alternate x-ray generation mechanisms to the commonly assumed magnetospheric and thermal origins (e.g. Becker, 2000). Generation of x-rays due to such wind–magnetosphere interactions would be expected to show orbital modulations, but

no such orbital modulation had been seen until a tentative detection by Pellizzoni et al. (2008) of x-ray emission modulated at the period of the B pulsar over part of the orbit.

Magnetospheric x-ray emission is believed to occur in many pulsars that display non-thermal x-ray spectra (Becker and Trümper, 1999), and there is no reason to believe that magnetospheric x-ray emission should not be generated in the PSR J0737–3039A/B system. Since pulsar A has a spin-down luminosity orders of magnitude higher than pulsar B (5.9×10^{33} erg s⁻¹, compared to 1.7×10^{30} erg s⁻¹) it would be expected to dominate any magnetospheric emission. Possenti et al. (2008) state that if the x-ray luminosity of the PSR J0737–3039A/B system is dominated by magnetospheric emission from pulsar A, the predicted x-ray luminosity (based on relation $L_X \propto \dot{E}^{1.1}$ from Grindlay et al. 2002) is 5×10^{30} erg s⁻¹. Given the typical scatter of an order of magnitude about the $L_X - \dot{E}$ relation, they concluded that this is consistent with the then-presumed x-ray luminosity of 2.3×10^{30} erg s⁻¹. Counting against the magnetospheric origin, on the other hand, was the fact that at the DM distance of 500 pc, the neutral hydrogen column density calculated from the absorbed fit ($N_H \sim 1.5 \times 10^{21}$ cm⁻²) was higher than expected from the pulsar’s presumed location in the Gum nebula (a nearby, large HII region which is modeled at a distance of ~ 500 pc with a depth of several hundred pc in the NE2001 model).

However, as noted by Possenti et al. (2008), the value of N_H is consistent with the usual average of 10 neutral hydrogen atoms for every free electron along the line of sight. The revised distance estimate presented here places PSR J0737–3039A/B beyond the Gum nebula, making the N_H measurements consistent with expectations. The revised value of x-ray luminosity (1.2×10^{31} erg s⁻¹) is approximately a factor of two from the predicted value, which is no more discrepant than the original estimate. Hence, this revised distance measure strongly supports a power-law model of magnetospheric origin (from pulsar A) for the bulk of the x-ray emission from the PSR J0737–3039A/B system.

Whilst the original spin-down luminosity to x-ray luminosity conversion efficiency of 0.04% was consistent with expectations, the revised conversion efficiency of 0.2% implied by this new VLBI distance is the highest amongst observed millisecond pulsars (see e.g. Zavlin, 2006). There is considerable scatter in the observed values of x-ray conversion efficiency amongst millisecond pulsars, however, and so this is not taken as evidence of an unusual x-ray production mechanism. It is also worth noting that at the 95% confidence lower limit of distance (860 pc) the x-ray conversion efficiency would be 0.12%, less than PSR B1937+21 and PSR J0218+4232 (Zavlin, 2006).

6.1.3 PSR J2145–0750

PSR J2145–0750 is a binary pulsar with spin period 16.05 ms and orbital period 6.84 days, which was discovered by Bailes et al. (1994). Optical observations by Bell et al. (1995) tentatively identified the expected white dwarf companion to PSR J2145–0750, which was confirmed by Lundgren et al. (1996). The scintillation velocity of PSR J2145–0750 was measured to be $31 \pm 25 \text{ km s}^{-1}$ by Nicastro and Johnston (1995), and a revised value of 51 km s^{-1} (no error given) was published by Johnston et al. (1998). Scintillation observations by Gothoskar and Gupta (2000) suggested a considerably higher transverse velocity of 113 km s^{-1} , but this was based on a single observation and may have been biased by refractive scintillation effects. All scintillation studies used the TC93 distance of 500 pc for this pulsar.

Timing astrometry using a 10 year dataset by Löhmer et al. (2004) measured a parallax of $2.0 \pm 0.6 \text{ mas}$, and a proper motion of $14.1 \pm 0.4 \text{ mas yr}^{-1}$, corresponding to a transverse velocity of $33 \pm 9 \text{ km s}^{-1}$. The implied distance of $500_{-115}^{+215} \text{ pc}$ is consistent with the DM -based estimates of 500 pc (TC93) and 566 pc (NE2001). However, Hotan et al. (2006) reported no detection of parallax and an upper limit of 0.9 mas, at 95% confidence, albeit with a shorter (2.5 year) dataset, in addition to a proper motion measurement of $13.5 \pm 6.0 \text{ mas yr}^{-1}$. A previous attempt has been made to measure the VLBI parallax of this system by Brisken et al. (2002) using the VLBA, but the pulsar was not detected and dropped from the observing program. Accordingly, the distance to this system is still controversial and confirmation of a previous result is keenly sought.

From the four observations made of PSR J2145–0750 during this observing program, significant detections were made on only two occasions. As was the case for the VLBA program of Brisken et al. (2002), it is believed that refractive scintillation is the major cause of the non-detections, as the pulsar’s flux varies significantly over long timescales. Although measurement of the parallax of PSR J2145–0750 was thus not possible, by holding parallax fixed at zero mas it was possible to measure a proper motion of $\mu_{\alpha} = -15.4 \pm 2.1 \text{ mas yr}^{-1}$, $\mu_{\delta} = -7.7 \pm 0.80 \text{ mas yr}^{-1}$. Assuming a distance of 500 pc (both the TC93 estimate and the Löhmer et al. (2004) timing parallax measurement), this corresponds to a transverse velocity of 40 km s^{-1} , 20% higher than the result given by the Löhmer et al. (2004) timing. Varying the parallax between zero and two mas results in a change in proper motion of less than 0.1 mas yr^{-1} , much smaller than the formal errors. As the proper motion and position have been derived from only two measurements, there are no degrees of freedom to the fit and no estimate of systematic errors, and so the result should be treated with some caution. The fitted and measured positions of PSR J2145–0750 are

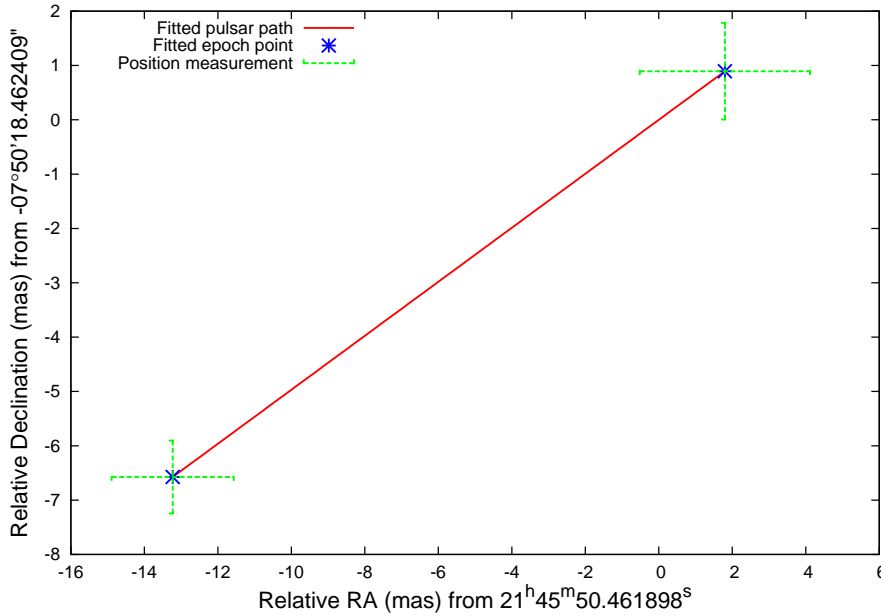

Figure 6.4 Motion of PSR J2145–0750, with measured positions overlaid on the best fit. Since only two significant measurements were made, the parallax of the pulsar was held fixed at zero, and the fit to position and proper motion has no free parameters. Variation of the parallax between zero and two mas (corresponding to a distance ≥ 500 pc) made an insignificant ($\lesssim 100 \mu\text{as yr}^{-1}$) difference to fitted proper motion.

shown in Figure 6.4.

The observed total proper motion of $17.2 \pm 2.2 \text{ mas yr}^{-1}$ is consistent with the value of $13.5 \pm 6.0 \text{ mas yr}^{-1}$ obtained by Hotan et al. (2006), but only consistent at the 2σ level with the value of $14.1 \pm 0.4 \text{ mas yr}^{-1}$ obtained by Löhmer et al. (2004)⁵. As these VLBI results are derived from only two measurements, and there is no way of quantifying the systematic error, it is likely that the timing results are more reliable for this pulsar.

6.2 Isolated pulsars

Whilst isolated pulsars do not generally allow the tests of GR which can be made using binary pulsars, many are interesting for other reasons. Apart from providing more (and generally easier) targets for studying the accuracy of DM distance models, as discussed in Section 2.3.1, isolated pulsars can also be used to investigate the accuracy of scintillation

⁵since PSR J2145–0750 lies close to the ecliptic, timing observations obtain large covariances between proper motion in right ascension and declination, and so the comparison of total proper motion is more useful

velocity measurements and the alignment of velocity and rotation vectors in the general pulsar population, as described by Johnston et al. (2005). Another comparison that can be made is that of “kinematic age” (the time it would have taken the pulsar to reach its present Galactic latitude, given its present proper motion) to characteristic age, which can yield some insight into the birth location and/or spin period of pulsars. However, apart from the “technique check” pulsars PSR J1559–4438 and PSR J2048–1616, the pulsars included in this sample were chosen primarily for their unusual luminosity characteristics. In each case, an error in the assumed DM distance measurement could have potentially explained these unusual luminosities, and these VLBI observations offered a mechanism to remove this uncertainty.

At the outset of this analysis, it is appropriate to note the importance of geometric considerations in determining pulsar luminosities, particularly in the radio. The extremely anisotropic nature of pulsar radio emission, due to the (non–uniform) beamed emission over a finite solid angle, makes direct comparison between pulsars problematic. For any given pulsar, the emission beam may sweep directly over the observer, or the edge of the beam may only graze the line of sight, with an obvious impact on the apparent luminosity. Pulsar apparent luminosities are generally quoted in mJy kpc^2 , where the pulsar flux is simply scaled by distance squared, and no attempt is made to account for beaming effects. Whilst beaming effects make radio luminosity analyses problematic for individual pulsars, studies of pulsar radio luminosity functions are nevertheless extremely important as the pulsar luminosity function is an essential component of pulsar simulations.

The results obtained for each isolated pulsar observed in this program are discussed in turn below.

6.2.1 PSR J0108–1431

PSR J0108–1431 was first reported by Tauris et al. (1994), and was postulated to be the nearest observed radio pulsar – its DM of 2.38 remains the lowest of any known pulsar. In the TC93 Galactic electron model, PSR J0108–1431 was predicted to lie 130 pc from Earth – in the newer NE2001 model (Cordes and Lazio, 2002), the distance was revised to 184 pc, which if correct would double the apparent radio luminosity, to a value of $300 \mu\text{Jy kpc}^2$ at 400 MHz (the lowest known value is that of PSR J0006+1834, which at a DM –derived distance of 700 pc has an apparent 400 MHz luminosity of $100 \mu\text{Jy kpc}^2$).

Figure 6.5 shows the fitted and measured positions for PSR J0108–1431. As shown in Table 6.1, the measured distance of 240_{-61}^{+124} pc is consistent with the NE2001 distance, but inconsistent at 95% confidence with the earlier TC93 distance. It confirms that PSR

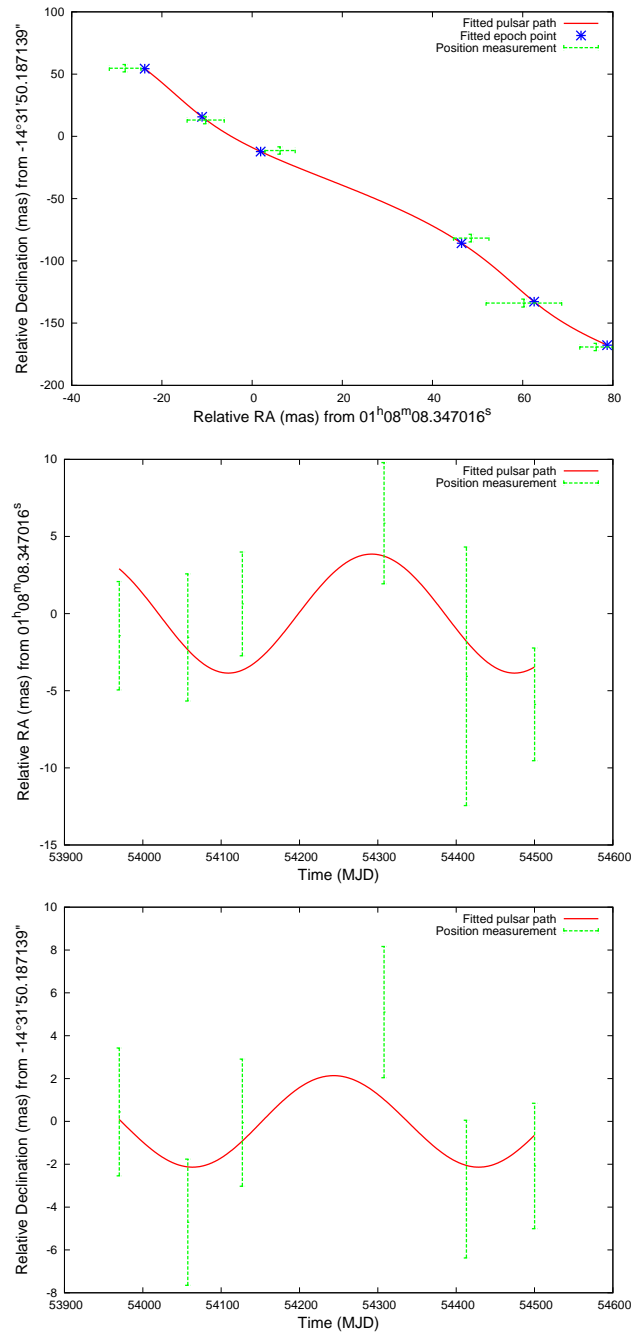

Figure 6.5 Motion of PSR J0108-1431, with measured positions overlaid on the best fit. From top: Motion in declination vs right ascension; right ascension vs time with proper motion subtracted; and declination vs time with proper motion subtracted.

J0108–1431 is more distant than originally suspected, and while its apparent radio luminosity is still low, it is no longer remarkably so. In fact, 5 other pulsars (PSR J0006+1834, PSR J1829+2456, PSR J1918+1541, PSR J2015+2524, and PSR J2307+2225) have lower 400 MHz luminosities than the revised value of $510 \mu\text{Jy kpc}^2$ for PSR J0108–1431. Of course, none of these pulsars have an independent distance measure, so it is possible that one or more of them may also be more distant than the model predictions, and hence also have greater luminosities. In addition, as noted above, beaming effects mean that these measured apparent luminosities may differ considerably from the true luminosities for these pulsars.

This higher distance, however, does imply an even lower value of electron density than that predicted by the NE2001 model: 0.0099 cm^{-3} . This is amongst the lowest values amongst pulsars within one kpc of the Solar System, and is the lowest value for pulsars nearer than 500 pc.

The detection of a parallax and proper motion enables for the first time a calculation of the Shklovskii correction for PSR J0108–1431, as shown:

$$\begin{aligned} \frac{\dot{P}_{\text{Shk}}}{P} &= \frac{\mu^2 D}{c} & (6.4) \\ &= \frac{170^2 \times 240}{2.998 \times 10^8} \text{ mas}^2 \text{ yr}^{-2} \text{ pc s m}^{-1} \\ &= 2.31 \times 10^{-2} \times 7.28 \times 10^{-16} \text{ s}^{-1} \\ &= 1.68 \times 10^{-17} \text{ s}^{-1} \\ \dot{P}_{\text{Shk}} &= 0.808 \times 1.68 \times 10^{-17} = 1.37 \times 10^{-17} & (6.5) \end{aligned}$$

where D is the pulsar distance, μ is the total pulsar proper motion and c is the speed of light.

Since the measured \dot{P} for PSR J0108–1431 is 7.704×10^{-17} (Hobbs et al., 2004), the Shklovskii term contributes 18% of the observed rate of change of spin period for this pulsar. The consequent downward revision to the intrinsic spin–down luminosity of PSR J0108–1431 is important in the interpretation of the optical and x–ray conversion efficiency for PSR J0108–1431, as shown below. Additionally, the characteristic age of PSR J0108–1431 is revised upwards from $166 \times 10^6 \text{ yr}$ to $200 \times 10^6 \text{ yr}$.

PSR J0108–1431 was recently detected in x–rays by Pavlov et al. (2008), who found that the observed emission was compatible with a magnetospheric origin, but that a thermal component from heated polar caps could not be excluded. The spin–down luminosity

to x-ray luminosity conversion efficiency was 0.4% when assuming a distance of 130 pc. This value is much larger than for young pulsars (typically 10^{-5} to 10^{-4} , Pavlov et al. 2008 and references therein), but comparable to most other old, nonrecycled pulsars. At the best-fit distance for PSR J0108–1431, the increased x-ray luminosity coupled with the downward revision to spin-down luminosity increases the conversion efficiency to 1.7%. This would make PSR J0108–1431 the most efficient known pulsar in terms of converting spin-down luminosity into x-ray luminosity, as the distance to the previously most efficient pulsar, PSR J0630–2834, has been revised dramatically downwards by the measurements of this thesis. PSR J0630–2834 is discussed further in Section 6.2.2 below. However, at the 95% confidence lower distance estimate (143 pc) the x-ray conversion efficiency estimate is little changed at 0.5%. A improvement on the parallax measurement would allow more useful constraints to be placed on the x-ray conversion efficiency.

Deep optical searches for PSR J0108–1431 have been made using the VLT (Mignani et al., 2003) and while the pulsar was not detected in the original observation, a reanalysis based on the x-ray detection of Pavlov et al. (2008) produced a viable candidate (Mignani et al., 2008). Extrapolating the VLBI position and proper motion back to the date of the optical data (July/August 2000) provides further confirmation of the optical detection (VLBI position: RA 01:08:08.311(1), dec $-14:31:49.12(1)$; optical position: RA 01:08:08.301(26), dec $-14:31:49.15(27)$). Mignani et al. (2008) show that the measured optical emission is compatible with purely thermal emission from the bulk of the neutron star, with a surface temperature of $(7 - 10) \times 10^4$ K, assuming a distance of 130 pc and a neutron star radius of 13 km. They note, however, that a determination of the actual neutron star surface temperature is dependent on an accurate distance measurement. Taking the lower limit of 7×10^4 K from above, and combining with the 95% confidence lower limit for distance to PSR J0108–1431 (143 pc), a simple re-scaling shows that these VLBI measurements imply that the temperature of PSR J0108–1431 must be greater than 8.5×10^4 K. At the best-fit distance of 240 pc, the implied temperature is in the range $(2.4 - 3.4) \times 10^5$ K.

Since the temperature of a neutron star with the age of PSR J0108–1431 (Shklovskii-corrected characteristic age 200×10^6 yr) should be less than 3×10^4 K if it had cooled according to standard models without any internal reheating (see Figure 3 of Schaab et al., 1999), these results imply that some reheating of isolated, slowly rotating neutron stars must occur. While PSR J0108–1431 could be younger than its characteristic age, assuming standard cooling to a temperature at or higher than the 95% confidence lower limit (8.5×10^4 K) implies an age less than 10×10^6 yr, which is extremely unlikely. More accurate temperature measurements for a number of pulsars would be required to differentiate the

possible reheating models (see Schaab et al., 1999, for a review of reheating models) but for PSR J0108–1431 most reheating processes do not have sufficient efficiency. Alternate models based on neutron star interiors composed of quark matter suggest a slower cooling rate and higher temperatures for old neutron stars (Alford et al., 2005), but the surface temperature implied by these PSR J0108–1431 observations is challenging to explain even in that framework. Alternatively, as noted in Mignani et al. (2008), a component of the optical emission may be non-thermal, although in this case the efficiency of the non-thermal process would be higher than in other optically-detected neutron stars such as PSR B0950+08 (Zharikov et al., 2004).

The predicted velocity of 194 km s^{-1} is unremarkable, and the pulsar’s high Galactic latitude of -76.8° makes it difficult to place good constraints on the true vertical component of velocity. This renders a comparison of characteristic to kinematic age impossible for PSR J0108–1431, but as the pulsar would likely have already completed more than one oscillation through the Galactic disk, such a comparison is not useful in any event. The proper motion is compatible with, but much more significant, than the value of $\mu_\alpha = 92 \pm 44$, $\mu_\delta = 176 \pm 70 \text{ mas yr}^{-1}$ derived by Pavlov et al. (2008).

6.2.2 PSR J0630–2834

PSR J0630–2834 is a middle-aged pulsar which has been observed extensively as part of scintillation studies (see e.g. Cordes, 1986; Bhat et al., 1999), and would be undistinguished if not for its remarkable apparent luminosity in x-rays. Becker et al. (2005) observed PSR J0630–2834 with XMM–Newton and found an x-ray luminosity of $8.4 \times 10^{30} \text{ erg s}^{-1}$, based on the NE2001 distance of 1.45 kpc. This implied that the pulsar was converting $\sim 16\%$ of its spin-down luminosity into x-rays – an order of magnitude more than any other old or middle-aged pulsar. They suggest that the most likely explanation is that the distance to the pulsar is over-estimated, a theory which has been proven correct by these VLBI observations.

The measured and fitted positions of PSR J0630–2834 are shown in Figure 6.6. The measured distance of $332_{-40}^{+52} \text{ pc}$, as shown in Table 6.1, means that the actual x-ray conversion efficiency is a much less surprising 0.8%. This is within the 1σ error bars of the efficiency derived for PSR J0108–1431 in Section 6.2.1 above. The best-fit distance of 332 pc is less than a quarter of the DM -derived distance in the NE2001 model, and a factor of seven smaller than the distance predicted by the TC93 model (2150 pc). This large discrepancy is discussed further in Section 6.3.

The proper motion of PSR J0630–2834 has previously been measured using the VLA

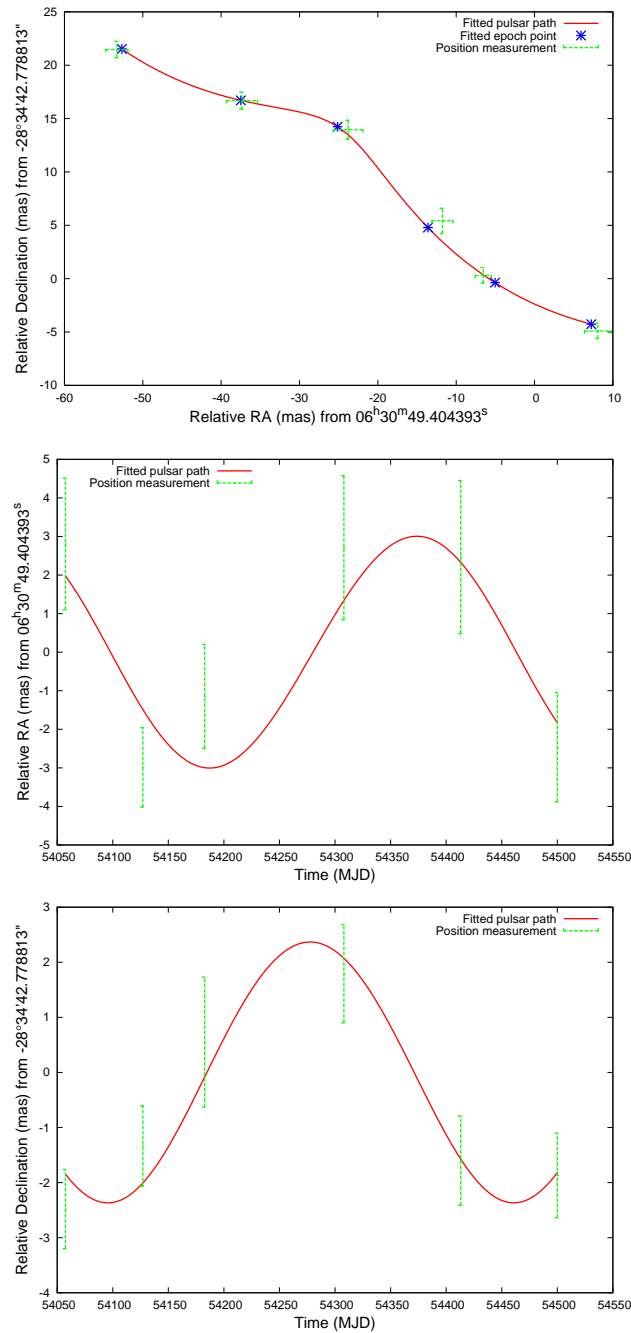

Figure 6.6 Motion of PSR J0630-2834, with measured positions overlaid on the best fit. From top: Motion in declination vs right ascension; right ascension vs time with proper motion subtracted; and declination vs time with proper motion subtracted.

by Brisken et al. (2003), and the measured values from this work ($\mu_\alpha = -46.3 \pm 0.99$ mas yr⁻¹, $\mu_\delta = 21.26 \pm 0.52$ mas yr⁻¹) are consistent with, but marginally more precise, than the VLA results ($\mu_\alpha = -44.6 \pm 0.9$ mas yr⁻¹, $\mu_\delta = 19.5 \pm 2.2$ mas yr⁻¹). The resultant Shklovskii correction is less than 0.04% of the observed period derivative (7.12×10^{-15}). The improved proper motion accuracy makes a marginal impact on the measurement of the alignment of the rotation and velocity vectors by Johnston et al. (2005), reducing the uncertainty in velocity position angle from 3° to 1°. This halves the error in the position angle difference measurement and confirms that the velocity and rotation vectors of PSR J0630–2834 appear to be very highly aligned.

Bhat et al. (1999) measured the scintillation velocity of PSR J0630–2834 to be 170 ± 15 km s⁻¹, considerably higher than the earlier measurement of 60 ± 13 km s⁻¹ by Cordes (1986). However, the estimated distance used by Bhat et al. (1999) was the TC93 distance (2150 pc), which considerably biases the estimated velocity. Cordes (1986) uses a pre-TC93 distance estimate of 1240 pc. When recalculated using the VLBI distance of 332 pc, the Bhat et al. (1999) and Cordes (1986) speeds are revised to 67 ± 6 km s⁻¹ and 31 ± 7 km s⁻¹ respectively. The transverse velocity of 80_{-11}^{+15} km s⁻¹ obtained from these VLBI measurements is thus consistent with the Bhat et al. (1999) measurements, but inconsistent with the earlier Cordes (1986) measurement.

The characteristic age of PSR J0630–2834 is 2.77×10^6 years, while its kinematic age can be calculated from its Galactic latitude $b = -16.758^\circ$ and proper motion in Galactic latitude $\mu_b = -34.8$ mas yr⁻¹ as 1.73×10^6 years. At the best-fit distance of 332 pc, the Galactic height of PSR J0630–2834 is -96 pc, and thus the characteristic and kinematic ages are consistent, and imply that the progenitor for PSR J0630–2834 resided within 60 pc of the plane.

6.2.3 PSR J1559–4438

PSR J1559–4438 is a relatively unremarkable, middle-aged, isolated pulsar, which was included in this observing program as the primary “technique check” source. Being relatively bright and a strong scintillator, it provided an excellent opportunity to check the data reduction tools developed in this thesis in a relatively high SNR regime. However, as it has been well studied in the past due to its relative proximity to the Solar System and brightness, a number of interesting comparisons to previous studies can be made. Although plots of the fitted and measured positions of PSR J1559–4438 have been shown previously in Chapter 5, they are shown here again in Figure 6.7 for completeness.

The measured distance of 2600_{-450}^{+690} pc is consistent with the NE2001 prediction (2350

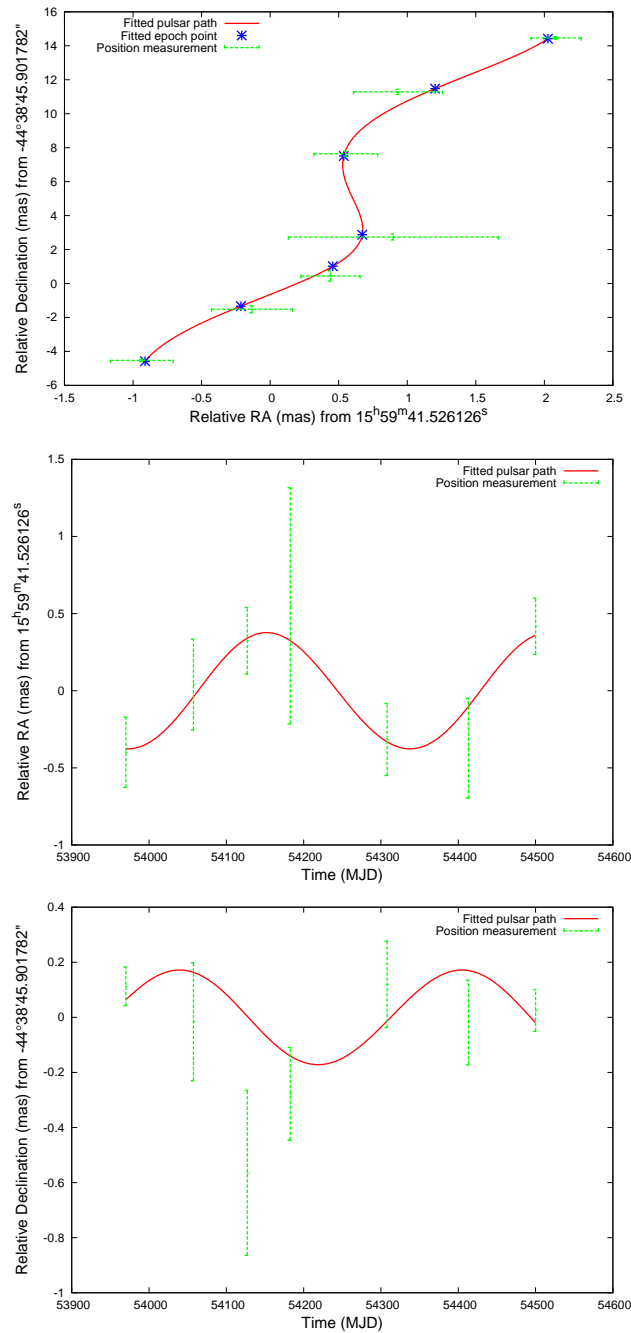

Figure 6.7 Motion of PSR J1559-4438, with measured positions overlaid on the best fit. From top: Motion in declination vs right ascension; right ascension vs time with proper motion subtracted; and declination vs time with proper motion subtracted.

pc Cordes and Lazio, 2002), which differed considerably from the earlier TC93 distance estimate of 1580 pc. It is also consistent with the lower distance estimate of 2.0 ± 0.5 kpc made using HI line absorptions by Koribalski et al. (1995). The measured values of proper motion ($\mu_\alpha = 1.52 \pm 0.14$ mas yr $^{-1}$, $\mu_\delta = 13.15 \pm 0.05$ mas yr $^{-1}$) are consistent with the VLA observations of Fomalont et al. (1997), who measured $\mu_\alpha = 1 \pm 6$ mas yr $^{-1}$, $\mu_\delta = 14 \pm 11$ mas yr $^{-1}$. Neglecting acceleration from the Galactic potential, the kinematic age of the pulsar can be estimated from its Galactic latitude $b = 6.367^\circ$ and proper motion perpendicular to the Galactic plane $\mu_b = 8.93$ mas yr $^{-1}$ as 2.57 ± 1.02 Myr, assuming a birth location within 100 pc of the plane (Faucher-Giguère and Kaspi, 2006). Under the standard assumption of a braking index of 3, the observed period $P = 257$ ms and period derivative $\dot{P} = 1.01916 \times 10^{-15}$ (Siegman et al., 1993) imply a birth period P_0 between 35 and 151 ms – longer than is often assumed for normal pulsars (see e.g. Migliazzo et al., 2002), but similar to the calculated value of $P_0 = 139.6$ ms for PSR J0538+2817 (Kramer et al., 2003). The correction to the observed \dot{P} due to the Shklovskii effect is only 0.03% of the observed value.

The transverse velocity measured for PSR J1559–4438 (164 km s $^{-1}$, 95% confidence upper limit of 287 km s $^{-1}$) is inconsistent with the 400 km s $^{-1}$ estimated from scintillation by Johnston et al. (1998), who assumed a 2 kpc distance to PSR J1559–4438 and a scattering screen midway to the pulsar. If this discrepancy is interpreted as an error in the scattering screen location, then the scattering screen must reside considerably closer to the pulsar than to the solar system. Alternatively, the distribution of turbulence in the scattering disk may be anisotropic, as appears to be the case for PSR J0737–3039A/B.

With an accurate proper motion now calculated, the position angle of the proper motion for PSR J1559–4438 can be compared to the position angle of the emission polarisation, which tests the alignment of the rotation and velocity vector, as described by Johnston et al. (2007). If the pulsar emits predominantly parallel or perpendicular to the magnetic field lines, then the angle between the velocity and polarisation position angles is expected to be 0° or 90° respectively. Johnston et al. (2007) found plausible alignment in 7/14 pulsars of similar ages to PSR J1559–4438. From Table 6.1, it is easy to calculate the velocity position angle as $\text{PA}_v = 6.6 \pm 0.6^\circ$. The polarisation position angle for PSR J1559–4438 given in Johnston et al. (2007) is 71 ± 3 , and so there does not appear to be a strong case for alignment of the velocity and rotation axes for PSR J1559–4438. However, the polarisation profile of PSR J1559–4438 (as shown in Figure 5 of Johnston et al. 2007) is complicated, and it is possible that the original determination of the magnetic field orientation from the polarisation position angle was incorrect. Thus, the alignment of the

rotation and velocity vectors for PSR J1559–4438 cannot be excluded, and more detailed polarisation studies are required.

6.2.4 PSR J2048–1616

PSR J2048–1616 was the second “technique check” source included in the observing program, after PSR J1559–4438. It is less bright than PSR J1559–4438, but was predicted to be somewhat closer (640 pc in the TC93 model, 560 pc in the NE2001 model). As shown in Table 6.1, whilst a measurement of parallax was made for PSR J2048–1616, it was not significant (1.9σ). Nevertheless, the best-fit distance of 580 pc is consistent with the DM -based distance estimates, and an accurate measurement of proper motion was made. Figure 6.8 shows the fitted and measured positions of PSR J2048–1616.

It is apparent from Figure 6.8 that the large position error of the third epoch (MJD 54182) is the primary reason for the poorly constrained fit. Equipment failure at the Mopra telescope and limited time on the Tidbinbilla telescope during this epoch reduced the number of telescopes on-source during observations of PSR J2048–1616 to three, and thus the large errors are unsurprising. The covariance between proper motion and parallax was the largest for PSR J2048–1616, and hence adding even a single future position measurement at the appropriate parallax extrema would almost certainly allow a significantly improved measurement of parallax.

The measured proper motion of $\mu_\alpha = 114.24 \pm 0.52 \text{ mas yr}^{-1}$, $\mu_\delta = -4.03 \pm 0.24 \text{ mas yr}^{-1}$ is consistent with but considerably more precise than the VLA measurement of Fomalont et al. (1997), which was $\mu_\alpha = 117 \pm 5 \text{ mas yr}^{-1}$, $\mu_\delta = -5 \pm 5 \text{ mas yr}^{-1}$. This allows an improved measurement of the transverse velocity vector position angle of $92.0 \pm 0.15^\circ$. Since the error in the alignment of polarisation and velocity position angle calculated by Johnston et al. (2007) was dominated by the error in polarisation position angle (5°), this improvement is not currently useful, although future improvements in polarisation measurements will allow a more precise measurement of the position angle difference and hence the alignment of the rotation and velocity vectors. The Shklovskii component of \dot{P} for PSR J2048–1616 can be calculated from the proper motion and best-fit distance to be 3.5×10^{-17} , or less than 0.4% of the observed value of $\dot{P} = 1.0958 \times 10^{-14}$.

Bhat et al. (1999) measured the scintillation velocity of PSR J2048–1616 to be $501 \pm 29 \text{ km s}^{-1}$ assuming the TC93 distance of 640 pc, which cannot currently be ruled out due to the distance uncertainty. However, if PSR J2048–1616 does indeed reside at the best-fit distance of 580 pc (which is consistent with the DM estimates) then, as with PSR J1559–4438, the scintillation velocity has been overestimated by a factor of ~ 2 , and as

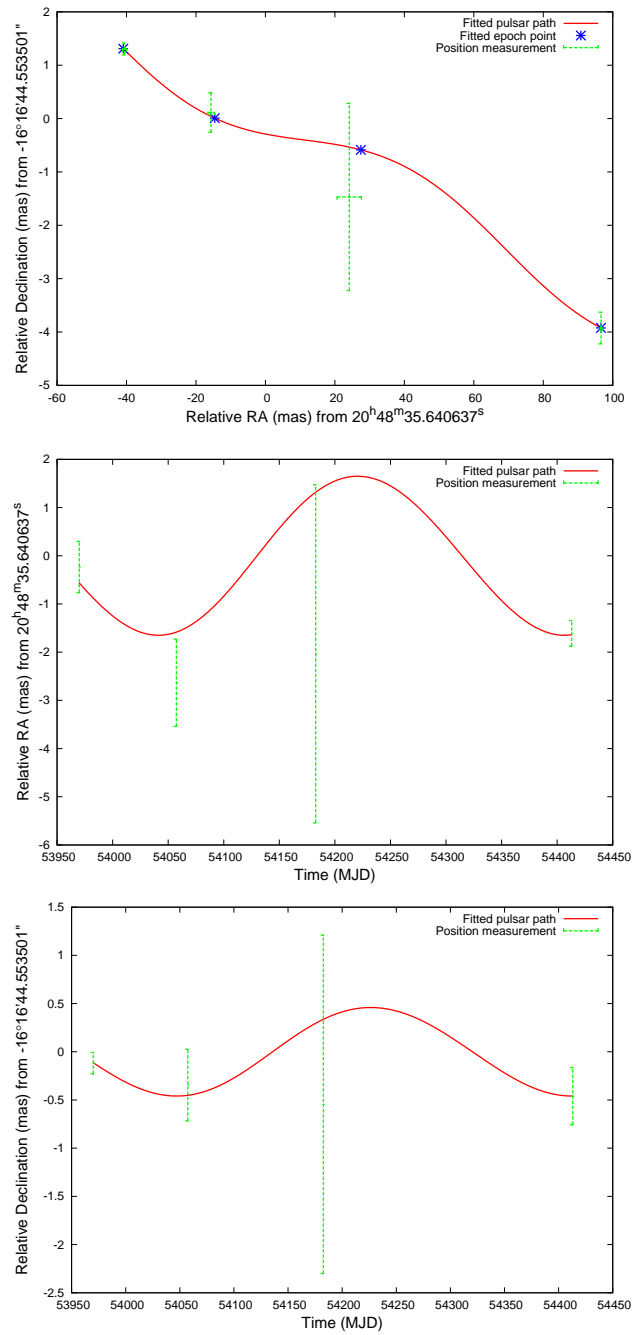

Figure 6.8 Motion of PSR J2048–1616, with measured positions overlaid on the best fit. From top: Motion in declination vs right ascension; right ascension vs time with proper motion subtracted; and declination vs time with proper motion subtracted.

with PSR J1559–4438, this would support the presence of a scattering screen closer to the pulsar than to the solar system.

The characteristic age of PSR J2048–1616 is $2.84 \times 10^6 \text{ yr}^{-1}$, while the kinematic age can be calculated from the Galactic latitude of -33.077° and proper motion in Galactic latitude (-107 mas yr^{-1}) as $1.113 \times 10^6 \text{ yr}$. As with PSR J1559–4438, assuming a braking index of 3 and taking the observed period $P = 1961.6 \text{ ms}$ and period derivative $\dot{P} = 1.0958 \times 10^{-14}$ allows the calculation of birth period $P_0 = 1192 \pm 243 \text{ ms}$, assuming the pulsar progenitor resided within 100 pc of the plane.

Since the distance to PSR J2048–1616 is still quite uncertain from these measurements, the most conservative estimates for P_0 and/or birth height can be obtained by assuming the pulsar distance is the minimum allowed value. At the 95% confidence lower limit of distance (283 pc), the Galactic height of PSR J2048–1616 is 155 pc, and the lower limit upon P_0 , assuming a birth event 100 pc above the plane, becomes 695 ms. Alternately, if the pulsar was born with a negligible spin period, the Galactic height of its progenitor must have been greater than 240 pc (at 95% confidence).

While, as noted in Chapter 2, considerable debate still exists as to the true distribution of initial pulsar spin periods, values greater than half a second are difficult to obtain with standard pulsar birth models. The second alternative, a progenitor residing considerably further above the Galactic plane than usual, is possible but unlikely. The remaining alternative to reconcile the characteristic and kinematic ages of PSR J2048–1616 is that its braking index is greater than the canonical value of 3.0. Substituting the 95% confidence upper bound on kinematic age ($1.83 \times 10^6 \text{ yr}$, assuming the minimum distance to PSR J2048–1616 and a progenitor 100 pc above the plane) into Equation 2.3 and assuming zero initial spin period yields a minimum braking index of 4.1. As noted by Yue et al. (2007), however, none of the six reliable measurements of braking index made to date have been greater than 3.0, which would make such a high value surprising. Clearly, PSR J2048–1616 is somewhat unusual in terms of generally assumed pulsar birth and evolution parameters, and further improvements to the parallax distance to PSR J2048–1616 would be extremely valuable in constraining the birth parameters and spin evolution of this pulsar.

6.2.5 PSR J2144–3933

PSR J2144–3933 was discovered in the Parkes Southern Pulsar Survey (Manchester et al., 1996), and was initially misidentified with a period of 2.83 seconds. Young et al. (1999) reported that the true period is in fact 8.5 seconds, making PSR J2144–3933 the longest period radio pulsar known. PSR J2144–3933 lies below the traditionally assumed pulsar “death line” (see e.g. Chen and Ruderman, 1993), and hence its true luminosity is extremely important for models of pulsar emission and evolution. The discovery of PSR J2144–3933 prompted alternative models of pulsar emission in which long period pulsars such as PSR J2144–3933 could remain luminous in the radio (e.g. Zhang et al., 2000). PSR J2144–3933 possesses a steeper spectral index than average (-2.4), and while several other pulsars appear less luminous at 400 MHz, PSR J2144–3933 is the least luminous pulsar observed at 1400 MHz (apparent luminosity $24 \mu\text{Jy kpc}^2$ at assumed distance of 180 pc; average 1400 MHz flux density of 0.75 mJy calculated from archival Parkes observations).

The fitted and measured positions of PSR J2144–3933 are shown in Figure 6.9. As shown in Table 6.1, a highly significant parallax was detected, corresponding to a distance of 165_{-14}^{+17} pc. Given the generally assumed errors on DM distances, this is consistent with the TC93 value (180 pc), but not the NE2001 value (264 pc). This confirms that the apparent radio luminosity of PSR J2144–3933 is extremely low – 15% lower than the previously assumed value of $24 \mu\text{Jy kpc}^2$.

The proper motion measurement allows for the first time a calculation of the Shklovskii correction for the period derivative of PSR J2144–3933 – the Shklovskii contribution to \dot{P} is 9.4×10^{-17} , or approximately 19% of the observed \dot{P} of 4.96×10^{-16} . The true spin-down luminosity of PSR J2144–3933 is thus further reduced from the assumed value of $3.2 \times 10^{28} \text{ erg s}^{-1}$ to $2.6 \times 10^{28} \text{ erg s}^{-1}$, the smallest known spin-down luminosity of any pulsar. PSR J0343–3000, discovered in the Parkes High-Latitude survey by Burgay et al. (2006), has the next lowest spin-down luminosity, which is a factor of 5 higher than the revised value for PSR J2144–3933. In addition, this revision to the \dot{P} value for PSR J2144–3933 places it even further past the assumed pulsar “death line”.

The correlation between observed pulsar radio luminosities (L) and their spin-down luminosity (\dot{E}) has been the subject of considerable debate. Lyne et al. (1998) argued for a model in which the pulsar luminosity was independent of the other known physical pulsar parameters, but Faucher-Giguère and Kaspi (2006) and Malov and Malov (2006), amongst others, have shown evidence for a correlation with the pulsar’s spin-down luminosity, with a dependence ranging from $L \propto \dot{E}^{1/3}$ to $L \propto \dot{E}^{1/2}$. More general models with a dependence upon P and \dot{P} are considered by Faucher-Giguère and Kaspi (2006) but are

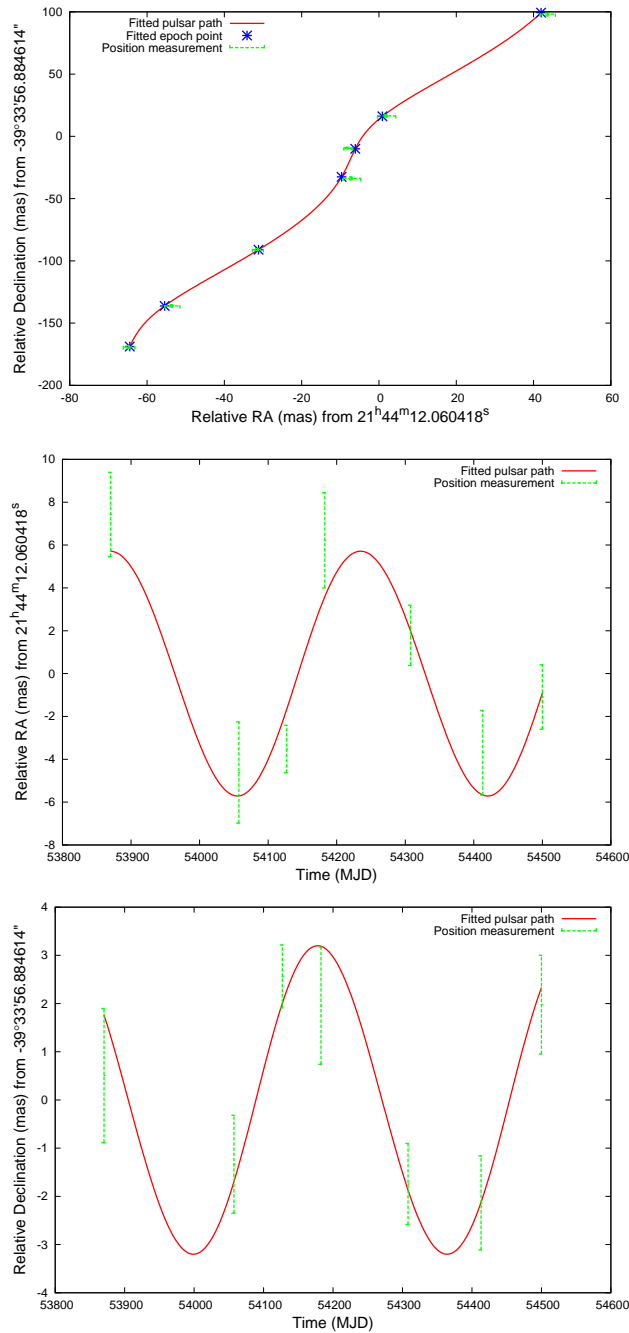

Figure 6.9 Motion of PSR J2144-3933, with measured positions overlaid on the best fit. From top: Motion in declination vs right ascension; right ascension vs time with proper motion subtracted; and declination vs time with proper motion subtracted.

not investigated here. Since the radio luminosity of ordinary pulsars is believed to be powered by their rotational energy, it is logical to assume that the radio and spin-down luminosities are related, but as already noted, complications such as differing beaming geometries make it plausible that this relationship could be difficult to identify observationally. Additionally, since the radio emission of pulsars makes up only a small component of their total emission, there is a potential for a large scatter in any relationship between radio luminosity and spin-down luminosity, and pulsar spectral indices can vary considerably, meaning measurements based on a single frequency introduce a further source of uncertainty. Certainly, spin-down luminosity and observed 1400 MHz radio luminosity appears to be uncorrelated when the entire population of pulsars is considered, as shown in the left panel of Figure 6.10.

However, it is interesting to note that PSR J2144–3933 has both the lowest spin-down luminosity and the lowest apparent 1400 MHz radio luminosity of all known pulsars. Malov and Malov (2006) show that the radio efficiency of old pulsars ($P > 0.1$ s) appears to increase with period, with the conversion efficiency for 2 second pulsars on average being an order of magnitude greater than for pulsars with period 0.2 seconds. PSR J2144–3933 is the longest period pulsar known and challenges standard pulsar emission models (e.g. Zhang et al., 2000), so it is reasonable to investigate the possibility that pulsars with similar characteristics might show a stronger correlation between spin-down luminosity and radio luminosity. The vacuum gap model of pulsar emission (e.g. Bhattacharya et al., 1992) predicts a radio death line given by:

$$B/P^2 < 1.7 \times 10^{11} \text{ G s}^{-2} \quad (6.6)$$

The right panel of Figure 6.10 plots apparent radio luminosity against spin-down luminosity for pulsars that lie near or below this radio death line. Since only 21 pulsars lie below this death line, and 1400 MHz luminosities are available for only 14 of these, the B/P^2 cut-off was chosen to be twice the vacuum gap death line value ($3.4 \times 10^{11} \text{ G s}^{-2}$). This resulted in a sample of 65 pulsars.

As shown in Figure 6.10, the correlation between spin-down luminosity and apparent 1400 MHz radio luminosity is stronger for pulsars that lie near the traditional pulsar death valley, towards the lower right corner of the $P-\dot{P}$ diagram. The line of best fit shown in the right panel of Figure 6.10 was obtained using standard linear regression, and is given by the equation $\log_{10} L = 0.67 \log_{10} \dot{E} - 19.57$. The 95% confidence interval for the power-law exponent is [0.24, 1.1], and the r^2 value of 0.136 is inconsistent with no correlation at greater than 99% confidence for this sample size of 65 pulsars. These results support the

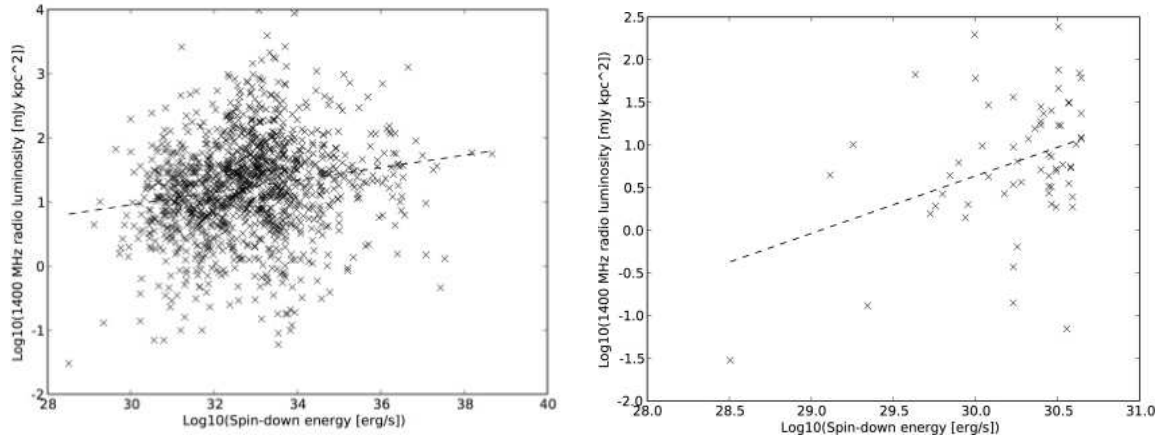

Figure 6.10 Correlation between apparent radio luminosity and spin-down luminosity for all pulsars (left panel), and pulsars with periods near or below the traditional death line ($B/P^2 < 3.4 \times 10^{11} \text{G/s}$; right panel). Whilst neither correlation is particularly strong, the r^2 value is higher for the “death valley” pulsars in the right panel (0.136) compared to the whole population shown in the right panel (0.033).

$L \propto \dot{E}^{0.5}$ model presented by Malov and Malov (2006), but models with a considerably steeper or shallower exponent cannot be excluded.

As already noted, the unknown effect of the beaming geometry for each pulsar is bound to impose a considerable scatter upon the apparent radio luminosities. Furthermore, all spin-down luminosities are uncorrected for the Shklovskii effect and, as discussed further in Section 6.3.2, errors in pulsar distances could be corrupting the radio luminosities and further obscuring a more obvious correlation. The results presented here should not be interpreted as definitive evidence of a correlation between integrated pulsar radio luminosities and spin-down luminosities – rather, they suggest that such a correlation is more likely for pulsars near the death valley, and that more detailed modeling could help confirm or deny the existence of a correlation such as that proposed by Malov and Malov (2006). Such modeling would necessarily include obtaining accurate distances and spectral indices and modeling beam geometries to estimate the integrated radio luminosity, and obtaining proper motions to calculate Shklovskii corrections to spin-down luminosity,

As noted in the discovery paper of PSR J2144–3933 by Young et al. (1999), the low luminosity and narrow beaming fraction (~ 0.01) of PSR J2144–3933 imply that many such objects exist in the Galaxy. The distance measurement provided by this VLBI astrometric program has confirmed and slightly strengthened this hypothesis, since the pulsar is even closer and fainter than previously thought. Assuming the steep spectral index of PSR J2144–3933 is typical for similar long-period, low-luminosity objects, and that the Galac-

tic population of such objects can be estimated from PSR J2144–3933 alone (which yields a population of 100,000 objects; Young et al. 1999), many such objects would be expected to be detected by LOFAR⁶. LOFAR, which is a low-frequency aperture array telescope presently being constructed in the Netherlands, will search for pulsars at frequencies of approximately 120 MHz.

While the spectrum of PSR J2144–3933-like objects may exhibit a turn-over before this point, assuming the measured spectral index of -2.4 continues to 120 MHz yields a 120 MHz radio luminosity of 8 mJy kpc^2 . While the scope of LOFAR has been adjusted several times recently, in pulsar survey mode it is expected to have a point source sensitivity in the 120 MHz band of $\sim 0.2 \text{ mJy}$ ⁷. Thus, LOFAR would be expected to detect objects like PSR J2144–3933 up to distances of several kpc, beyond which distance interstellar scattering is likely to limit detections more than sensitivity. Thus, potentially thousands of PSR J2144–3933-like objects could be expected to be detected with LOFAR. Low-frequency observations of PSR J2144–3933 would resolve the question of a potential spectral turnover, and help refine estimates of LOFAR detection rates.

While this is the first measurement of proper motion for PSR J2144–3933, Johnston et al. (1998) have measured a scintillation velocity of 48 km s^{-1} assuming a distance of 330 pc, considerably lower than the VLBI-derived value of $130_{-12}^{+14} \text{ km s}^{-1}$. Since the scintillation speed was underestimated, despite the fact that the distance to the pulsar was overestimated, a possible explanation is that the scattering screen resides closer to the solar system than the pulsar. Alternatively, the scintillation measurement could have been affected by refractive scintillation, or the thin-screen, isotropic turbulence model may not be applicable in this case.

No detections of PSR J2144–3933 in optical or x-ray wavebands have been published. With a Shklovskii-corrected characteristic age of 336×10^6 years, it is even older than PSR J0108–1431, and might be expected to possess similarly high conversion efficiency from spin-down luminosity to optical and x-ray luminosity. However, even though it is considerably closer than PSR J0108–1431, the fact that its spin-down luminosity is a factor of almost 50 smaller means that it would be challenging to detect in wavebands other than radio. A simple scaling of the optical observations of PSR J0108–1431 to account for the different distance and spin-down luminosity of PSR J2144–3933 reveals that the U band optical magnitude would be 27.7. which would be detectable with large ground-based telescopes, although challenging. The x-ray luminosity, assuming the 1.7% conversion

⁶<http://www.lofar.org/>

⁷assuming a five minute integration, 24 MHz bandwidth, and a 10% pulsar duty cycle – see http://www.lofar.org/p/astronomy_spec.htm

efficiency seen in PSR J0108–1431, would be 5.5×10^{26} erg s⁻¹. Scaling the count rate seen by Pavlov et al. (2008) on PSR J0108–1431 by the relative distance and luminosity of PSR J2144–3933 compared to PSR J0108–1431 yields the extremely low photon count rate of 0.08 counts ks⁻¹, and thus x-ray detection of PSR J2144–3933 is unlikely without an extremely long exposure.

6.3 Analysis of distance and velocity models

Galactic electron distribution models are extremely important for all fields of pulsar research, since their prediction of pulsar distances based on DM has the potential to bias estimates of luminosity, velocity, and various timing terms for the vast majority of pulsars without an independent distance constraint. Hence, continual improvement of these models, and characterisation of errors in the existing models (and the impact of these errors) is a crucial task.

Early attempts to construct simple Galactic electron models for the purpose of estimating pulsar distances were made by Manchester and Taylor (1981) and Lyne et al. (1985), but these were superseded by the more comprehensive TC93 model of Taylor and Cordes (1993). While the much more complex NE2001 model of Cordes and Lazio (2002) is now available, distance estimates based on the TC93 model are still in common usage and both models are considered below.

The six new (and one refined) pulsar parallaxes measured in this thesis make a substantial addition to the 29 published (18 VLBI and 11 timing) pulsar parallaxes⁸ and hence a review of the accuracies of the TC93 and NE2001 models is timely. It is appropriate to note at the outset of this analysis that large distance errors may be over-represented in existing astrometric results. One reason is the selection effect of anomalous pulsars being chosen for study, which is certainly the case for the PSR J0630–2834 system observed during this thesis. Another potential factor is that most astrometric distance determinations to date have been for relatively nearby pulsars, where there is less opportunity for underdensities and overdensities in the ISM along the line of sight to cancel, and hence it is plausible that distance models are on average more reliable for more distant pulsars.

Figure 6.11 plots the TC93 distance for all 35 pulsars against the parallax distance, along with a line of best fit. Figure 6.12 repeats this plot for NE2001 distances. The best fit line was generated by averaging the linear regression results obtained from a 10,000 trial Monte Carlo simulation, where “actual” pulsar distances were calculated for each trial

⁸ Only the most accurate parallax measurement has been considered where multiple measurements exist, and measurements less significant than 1.5σ have been excluded

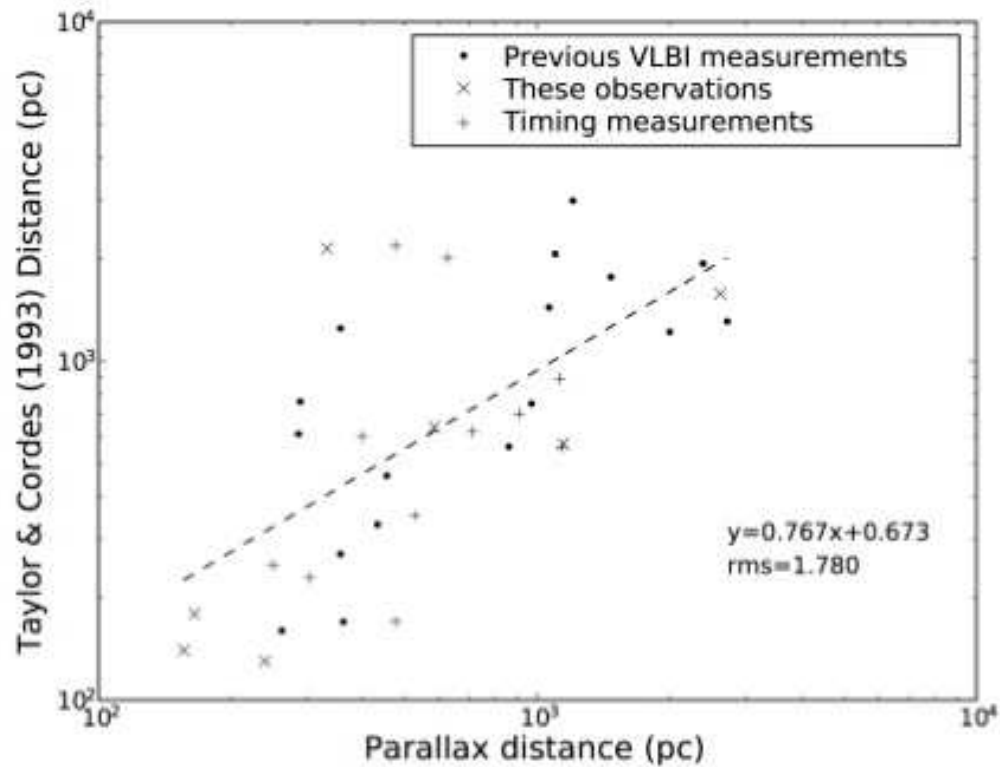

Figure 6.11 Parallax distance versus TC93 distance for all pulsars with a published parallax. The line of best fit was estimated from a Monte Carlo simulation of the true pulsar distances based on parallax measurements and errors, averaging the results obtained from standard linear regression. The TC 93 model is particularly uncertain for nearby pulsars, with underestimates and overestimates by factors of up to six.

based on the observed parallax and parallax error. Throughout this section, errors will be referred to in decibels (dB), which is the most convenient representation for measurements where large underestimates or overestimates are common. The error in dB is defined as $10 \log_{10} \frac{\text{model distance}}{\text{parallax distance}}$, and hence positive values represent overestimates, and negative values represent underestimates.

Figures 6.11 and 6.12 show that the NE2001 model has considerably improved upon the TC93 model, but significant errors are still made for individual pulsars. This can be highlighted more clearly by binning the errors, as shown in Figure 6.13 for the TC93 model and Figure 6.14 for the NE2001 model. Figure 6.13 shows a clear systematic offset in the median error of the TC93 model towards underestimated distances, but the largest errors are seen when distances are overestimated. Figure 6.14 shows that systematic bias has been removed by the NE2001 model, but the distribution of errors still cannot be well approximated by a single Gaussian, with long wings towards large errors. For both the

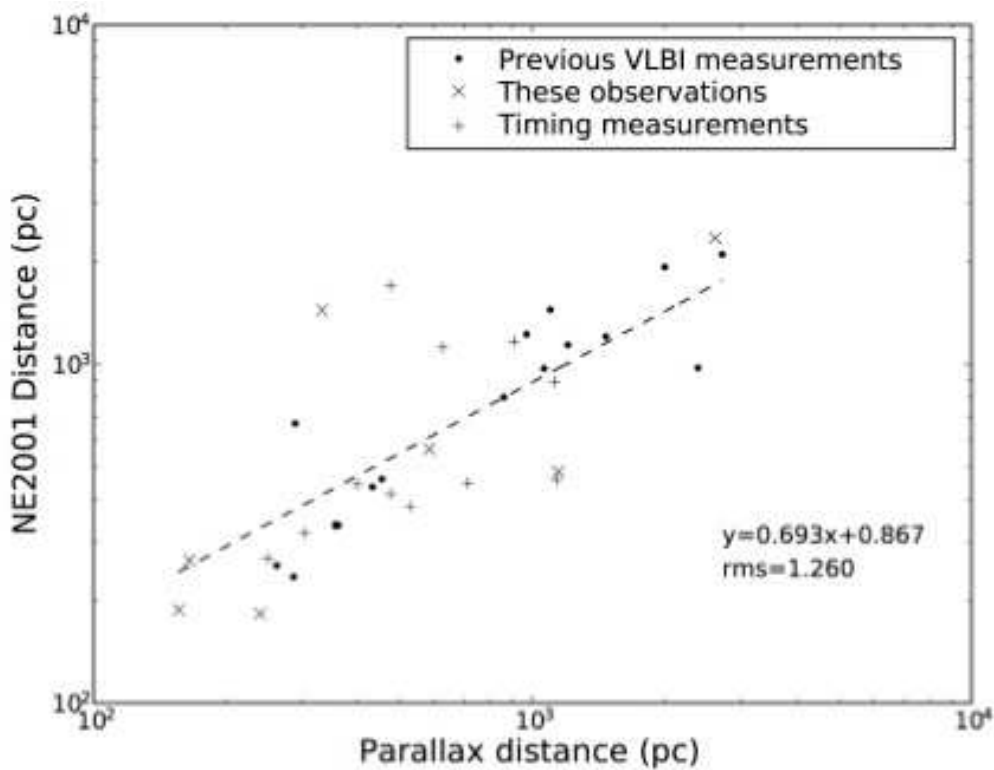

Figure 6.12 Parallax distance versus NE2001 distance for all pulsars with a published parallax. As with Figure 6.11, the line of best fit was estimated using linear regression in a Monte Carlo simulation to account for parallax measurement errors. The RMS error is substantially reduced compared to the TC93 predictions, but as some pulsar distances had been measured prior to 2001 and were used to constrain the NE2001 model, part of the observed improvement must be attributed to this knowledge.

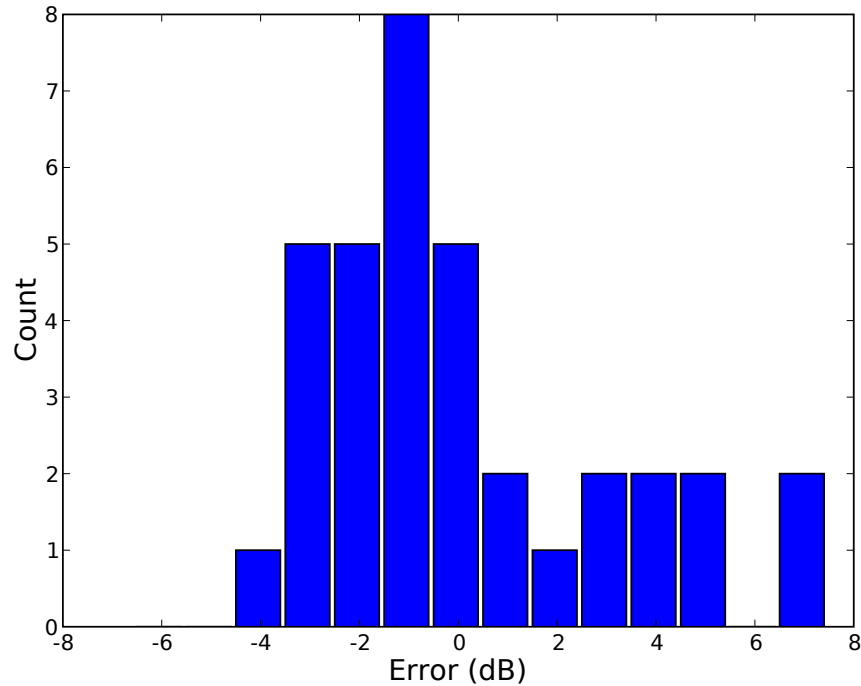

Figure 6.13 Histogram of TC93 errors for pulsars with measured parallaxes, with errors binned in 1 dB increments. Underestimates of distance are more common in this model, but the largest errors are made when the distance is overestimated. The standard deviation of the errors is approximately 3 dB.

TC93 and NE2001 models, the largest errors are seen when the distance is overestimated. The effect of these high-error “outliers” on population studies of neutron stars is considered further in Section 6.3.2.

6.3.1 Analysis of newly-measured pulsars

Table 6.3 shows the measured distances and velocities for the pulsars in this survey, along with previous estimates of their distance from the TC93 and NE2001 electron models, and (where available) estimates of their speed from scintillation studies. PSR J0437–4715 has been excluded from the analysis of DM distance reliability below, since it contributed to the NE2001 model. Since no parallax was detected for PSR J2145–0750, the VLBI velocity is shown assuming the NE2001 distance of 566 pc, but given the consequent uncertainty it is not included in the error analysis of scintillation velocity estimates. Naturally, PSR J2145–0750 cannot contribute to the estimates of DM distance reliability.

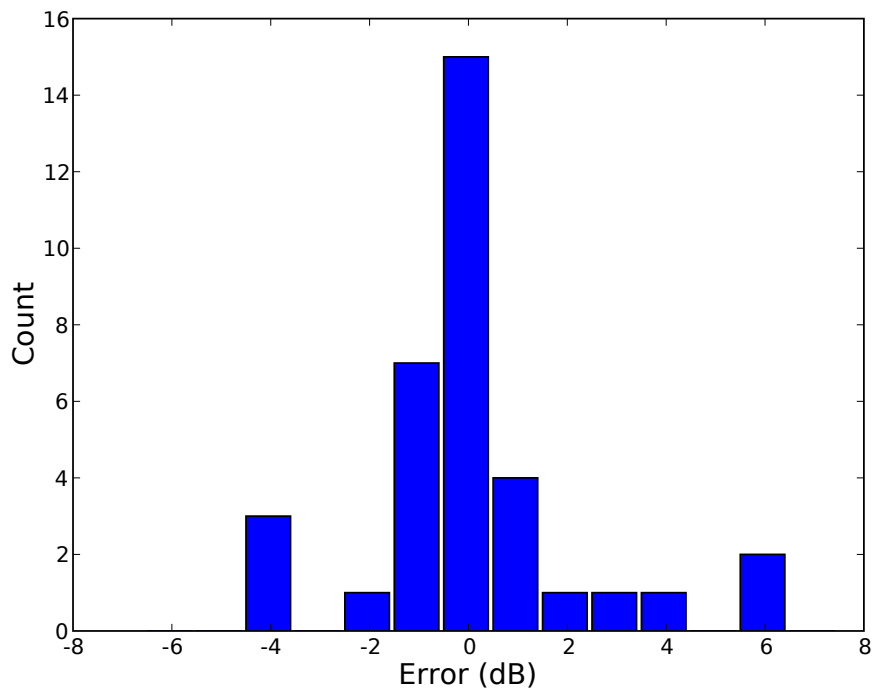

Figure 6.14 Histogram of NE2001 errors for pulsars with measured parallaxes, with errors binned in 1 dB increments. Unlike the TC93 model, there are no discernable systematic errors, but the distribution is still clearly non-Gaussian, with a long tail of errors up to 6 dB. The occurrence of errors with a magnitude greater than 3 dB has been somewhat reduced from the TC93 model (five, compared to eight for TC93). The standard deviation of the errors is approximately 2 dB, compared to the 3 dB seen for TC93.

Table 6.3. Comparison of distance and velocity to non VLBI-derived estimates

| Pulsar | VLBI distance (pc) | VLBI velocity (km s ⁻¹) | TC93 distance (pc) | NE2001 distance (pc) | Scintillation speed (km s ⁻¹) |
|-------------------|---------------------------------------|--|-----------------------|-------------------------|---|
| PSR J0108–1431 | 240 ⁺¹²⁴ ₋₆₁ | 194 ⁺¹⁰⁴ ₋₅₁ | 130 | 184 | – |
| PSR J0437–4715 | 156.3 ^{+1.3} _{-1.3} | 104.7 ^{+1.0} _{-1.0} | 140 | 189 | 170 ^A , 231 ^B |
| PSR J0630–2834 | 332 ⁺⁵² ₋₄₀ | 80 ⁺¹⁵ ₋₁₁ | 2150 | 1444 | 60 ± 13 ^C , 170 ± 15 ^D |
| PSR J0737–3039A/B | 1150 ⁺²²⁰ ₋₁₆₀ | 24 ⁺⁹ ₋₆ | 570 | 483 | 140.9 ± 6.2 ^E , 66 ± 15 ^F |
| PSR J1559–4438 | 2600 ⁺⁶⁹⁰ ₋₄₅₀ | 163 ⁺⁴⁴ ₋₂₉ | 1580 | 2384 | 400 ^A |
| PSR J2048–1616 | 580 ⁺⁶⁶⁰ ₋₂₀₀ | 317 ⁺³⁶² ₋₁₁₁ | 640 | 562 | 501 ± 29 ^D |
| PSR J2144–3933 | 165 ⁺¹⁷ ₋₁₄ | 130 ⁺¹⁴ ₋₁₂ | 180 | 264 | 48 ^A |
| PSR J2145–0750 | – | 46 ⁺⁶ ₋₆ | 500 | 566 | 31 ± 25 ^G , 51 ^A , 113 ^B |

^AJohnston et al. (1998), using TC93 distances, except for PSR J1559–4438 where 2 kpc (HI lower limit) was used and PSR J2144–3933 where 330 pc (unknown source) was used

^BGothoskar and Gupta (2000), using TC93 distances

^CCordes (1986), using a distance of 1240 pc

^DBhat et al. (1999), using TC93 distances

^ERansom et al. (2004), using a distance of 600 pc

^FColes et al. (2005), using a distance of 500 pc

^GNicastro and Johnston (1995), using the TC93 distance

Table 6.3 shows that for this admittedly limited sample size, the NE2001 model is only slightly improved from the TC93 model, with a mean distance error of 2.1 dB compared to 2.5 dB. This is smaller than is seen for the entire population, where the NE2001 model shows a 1 dB improvement over the TC93 model. This may be partly due to the presence of PSR J0630–2834, which dominates the error budget for both the TC93 and NE2001 models, as the models overestimated the distance to this pulsar by a factor of 6.5 and 4.3 respectively. Clearly, for individual pulsars, DM distances alone cannot be relied upon to provide luminosity, velocity or space density estimates.

Table 6.3 shows that scintillation speed estimates are also generally unreliable for any given system – of the nine estimates available, only two are consistent with the VLBI-derived velocities, and one of those (PSR J2048–1616) is likely to also be inconsistent, but cannot presently be ruled out due to the low significance of the parallax detection. In some cases (such as PSR J0630–2834) the incorrect distance estimate to the pulsar was the main reason for the scintillation speed estimate errors, but for most cases the DM distance error did not significantly contribute to the scintillation speed error. The mean absolute error is 3.8 dB, with the largest error (on PSR J0737–3039A/B) being a factor of 7. Amongst this limited sample, scintillation speeds have consistently overestimated the true transverse speed, on average by a factor of 1.75. This is in contrast to previous authors such as Gupta (1995), who found that scintillation speeds tended to underestimate the proper motion speed, at least for pulsars with a large Galactic height. These findings are

little changed when the scintillation speed estimates are corrected by the VLBI distance measurements – the mean overestimate of speed becomes a factor of 1.5, and the mean absolute error is 4.1 dB.

Most previous studies of scintillation speed have assumed a single, thin, turbulent scattering screen midway between the pulsar and the Solar System. The turbulence within the screen is generally assumed to be isotropic. Recent results from scintillation studies of PSR J0737–3039A/B (W. Coles et al., in preparation) and PSR B0834+06 (W. Brisken et al., in preparation) suggest that anisotropy of ISM turbulence is the norm, rather than the exception. When coupled with the uncertainty of the scattering screen location, this suggests that errors in scintillation speeds have typically been underestimated in the past. Whilst the scintillation speed method remains a valid approach for obtaining *population* velocity measurements (subject to the same caveats highlighted in Section 6.3.2), the natural conclusion is that too many uncertainties exist for the method to be useful for *individual* objects, at least when no information on the location and structure of the scattering material is available.

6.3.2 Impact of DM distance errors

It has already been shown that although there is no evidence for systematic bias in the NE2001 distance model, errors exceeding 4 dB still exist for individual pulsars. Such errors can impact upon population analysis of pulsars, artificially creating tails of extremely high or low values of distance-dependent parameters such as luminosity and velocity. This can affect estimates of the mean values of these quantities, as well as confusing attempts to explain the underlying physics by generating false outliers. As an example, the case of neutron star transverse velocities is considered below.

In order to model the effect of distance errors on transverse velocity estimates, it is necessary to estimate the form of the error distribution shown in Figure 6.14. Since the small number of samples makes an estimation of the true distribution difficult, the error distribution has instead been modeled by binning the errors in increments of 0.1 dB and smoothing with a 2 dB Hanning window. This is shown overlaid on the original binned error distribution in Figure 6.3.2, and is hereafter referred to as the binned error model. As already noted in Section 6.3, large errors are likely to be somewhat over-represented due to selection effects, and thus this model can safely be considered to be a “worst-case” representation of DM distance reliability. Figure 6.3.2 also shows a single Gaussian component model for the error distribution, with a standard deviation of 0.66 dB. In this Gaussian distribution, 75% of errors are smaller than a factor of 1.2, and hence

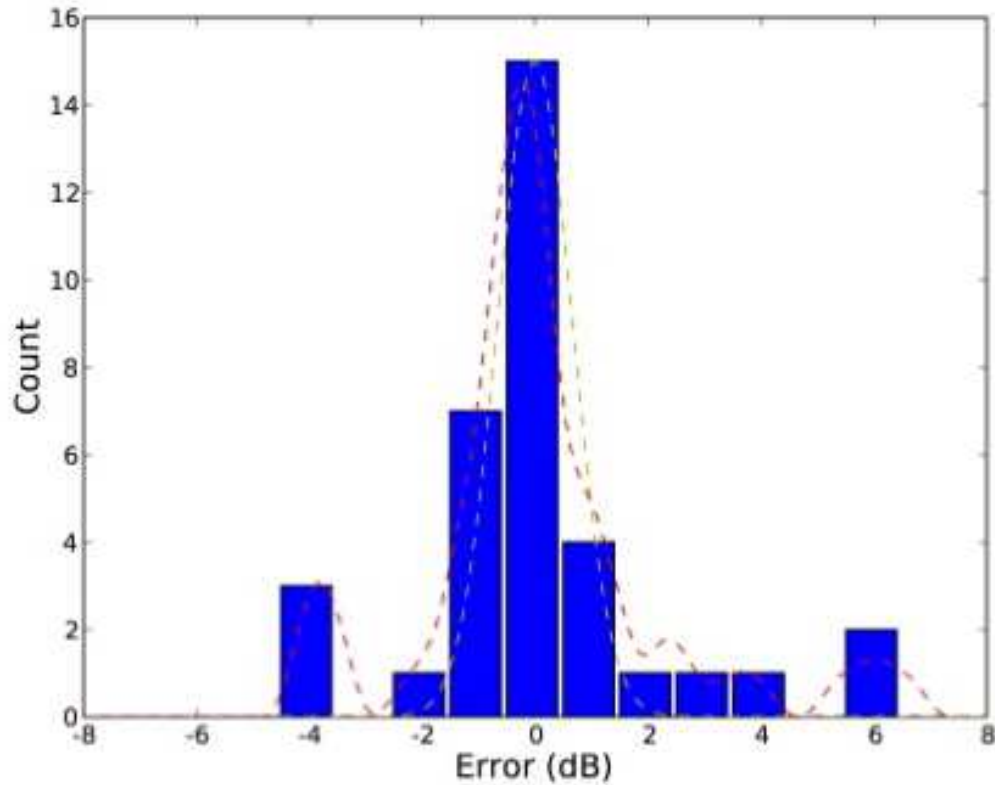

Figure 6.15 Histogram of NE2001 errors for pulsars with measured parallaxes, with error binned in 1 dB increments. The “binned” error model described in the text is shown as a dashed red line, while the single Gaussian “traditional” model which approximates the 20% errors commonly assumed for DM distances is shown as a yellow dashed line.

it approximates the 20% errors typically assumed for DM models. This distribution is hereafter referred to as the traditional error model.

Hobbs et al. (2005) examine a large sample of pulsar proper motions and conclude that the distribution of 3D space velocities of young pulsars (characteristic age < 3 Myr) is well fit by a Maxwellian distribution with mean 431 km s^{-1} and one-dimensional RMS 265 km s^{-1} . This velocity distribution is used as the starting point for the simulations that follow.

A Monte Carlo simulation was performed, creating a synthetic pulsar catalogue of 1 million pulsars, where each pulsar’s actual velocity was drawn from the distribution described above. These are referred to as the unperturbed velocities. The velocities of each pulsar were then perturbed according to the binned error function and the traditional error function described above, and the observed 2D velocity was recorded for each case. The observed 2D velocity distribution for the binned error function and the traditional error

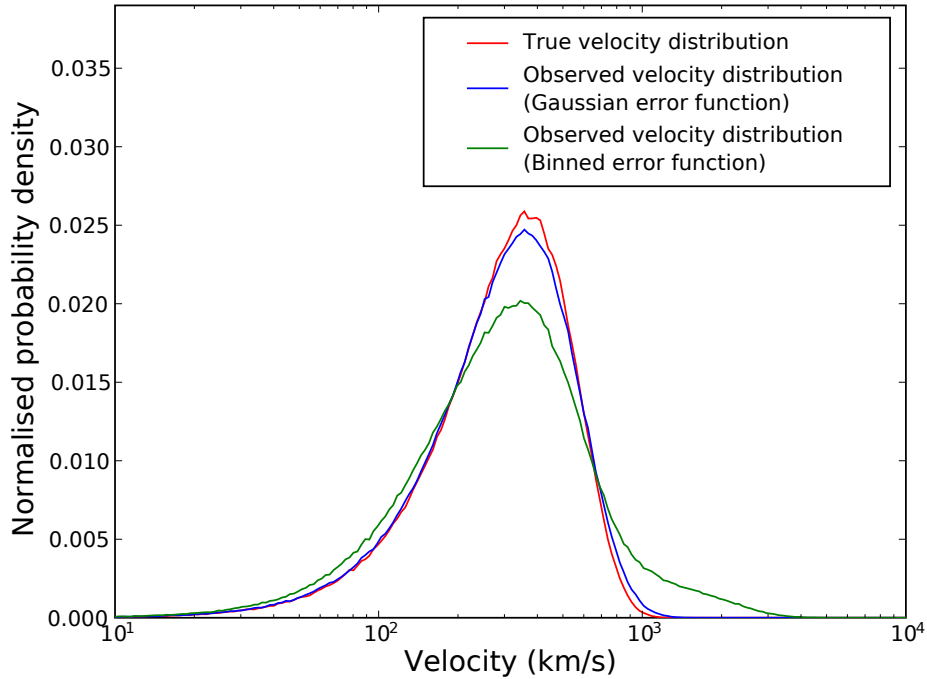

Figure 6.16 2D velocities for a synthetic pulsar population, as observed with no distance error (red), the traditional distance error model (blue) and the binned distance error model described in the text (green). The effect of the binned distance error model is to broaden the observed velocity distribution, particularly at large velocities.

function, along with the unperturbed 2D velocity distribution, is plotted in Figure 6.16.

It is immediately apparent that the broadening of the observed velocity distribution is considerably greater for the binned error model, compared to the traditional error model, which is particularly pronounced at the high end of the velocity distribution. The mean unperturbed 2D velocity is 332 km s^{-1} , which is increased by only 1% to 336 km s^{-1} in the traditional error model, but by 18% to 392 km s^{-1} in the binned error model. This increase exceeds the $\pm 40 \text{ km s}^{-1}$ errors quoted for the mean 2D velocities of young pulsars in Hobbs et al. (2005).

Even more important than the mean effect on pulsar velocities, however, is the effect on the high end of the pulsar velocity distribution. Hobbs et al. (2005) note that distance model inaccuracies could be responsible for the sparse tail of very high velocity pulsars, but conclude that with the small sample size available, the observed high-velocity pulsars are consistent with the tail of continuous velocity distribution. In considering the impact of

distance model errors, it is useful to examine the frequency of occurrence of pulsars with observed transverse speeds greater than 1000 km s^{-1} in the synthetic catalogue. These pulsars will be described as very high velocity (VHV) pulsars. The synthetic catalogue contains only one VHV pulsar in every 1000 in the unperturbed velocity distribution, but the occurrence rises to three in 1000 for the traditional error model, and 50 in 1000 for the binned error model.

Thus, distance model errors can add a significant high-velocity tail to the observed pulsar velocity distribution, an effect which is significantly enhanced when the distance errors “outliers” are accounted for. These results suggest that the mean pulsar 3D space velocity may have been previously overestimated, and that the majority of VHV pulsars may in fact simply be pulsars with incorrect distance estimates. As already stated, the binned error model used here is likely to overestimate the true frequency of large errors, and hence the true impact of DM distance errors is likely to lie somewhere in between the binned error model and the traditional error model. Additionally, there is clear evidence that at least some VHV pulsars are present in the Galaxy, with Chatterjee et al. (2005) using VLBA astrometry to show that the transverse velocity of PSR B1508+55 exceeds 1000 km s^{-1} , and observations of PSR B2224+65 showing scintillation, proper motion and bow shock results consistent with a velocity close to 1000 km s^{-1} (Cordes, 1986; Harrison et al., 1993; Cordes et al., 1993). Nonetheless, the binned error model is useful in illustrating that the largest impact of occasional, rare distance errors is at the high end of the pulsar velocity distribution. A larger, unbiased sample of pulsar distance measurements would enable a more accurate estimation of the true distance error function for NE2001, which in turn would enable the effects of distance errors to be “deconvolved” from the measured pulsar velocity distribution with some confidence.

6.4 Systematic errors and astrometric accuracy

Previous astrometric VLBI programs such as those carried out by Chatterjee et al. (2004) have attempted to estimate the effect of various observing factors on the resultant astrometric accuracy. Two of the most important factors are the brightness of the pulsar, which determines the accuracy to which a centroid position can be estimated within the synthesised beam, and the angular separation of the pulsar from the calibrator (the “calibrator throw”), which determines the extent to which atmospheric and ionospheric gradients contribute to systematic errors. Broadly, these could be considered as dominating the thermal (random) error component, and the systematic (non-random) error component to a position measurement. It is appropriate to note at the outset of this analysis that the

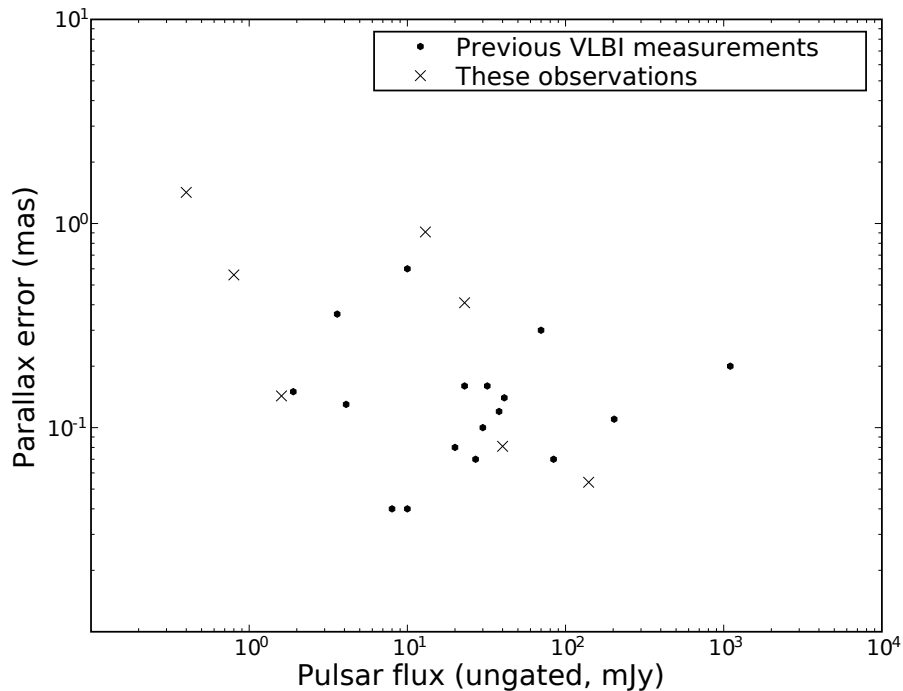

Figure 6.17 Parallax error plotted against ungated pulsar flux density (mJy, 1400 MHz) for all pulsars with a published VLBI parallax. Whilst stronger pulsars typically have smaller errors, there is a large scatter. The three faintest pulsars with measured parallaxes to date were part of this observing program.

small number of measured parallaxes and the potential for selection biases (for example, some “easier” pulsars have been targeted by earlier surveys with less sensitivity, leading to larger errors compared to what might be expected) mean the trends presented here should be interpreted with caution.

Figure 6.17 shows the ungated pulsar flux density (at 1400 MHz) plotted against parallax errors for all pulsars with a published VLBI parallax. No attempt was made to account for the effect of varying calibrator throw. Where several parallax measurements have been made, the most accurate is used. As expected, considerable variation is seen, but there is a general trend towards lower parallax errors for brighter pulsars.

Figure 6.18 shows the parallax errors plotted against calibrator throw for all pulsars with a published VLBI parallax. No attempt was made to correct for pulsar flux. As with Figure 6.17, the most accurate measurement was taken when multiple measurements were available. Where multiple calibrators were used, the shortest calibrator throw was

taken (including in-beam calibrators when used). Surprisingly little trend is seen with decreasing calibrator throw, which differs from predominantly linear decrease seen in the results of Chatterjee et al. (2004), and the simulation predictions of Pradel et al. (2006).

As previously stated, the sample used here consists of measurements made with many different VLBI arrays, at different recording rates and hence sensitivities. This approach differs from previous studies such as Chatterjee et al. (2004), who considered single objects with different calibrators, or multiple objects with different calibrator throws observed with the same array. The in-beam calibrators used also vary considerably in brightness, which may limit the attainable precision to less than the expected value from the spatial interpolation alone. The variation of pulsar flux amongst the different target objects, however, is likely to be the most important factor obscuring the expected correlation of parallax error with calibrator throw. This would imply that the majority of pulsar astrometry programs to date have been sensitivity-limited, rather than being limited by systematic errors.

Ideally, a joint analysis would be made of pulsar flux and calibrator throw on the parallax error, but the current sample size is too small for such an analysis to be meaningful. More tightly controlled and larger samples of parallax measurements will become available in future years, enabling a better analysis of the relative contribution of calibrator throw to parallax error.

The pulsars observed in this thesis varied widely in flux and calibrator throw, and so different limiting factors are seen for the different targets. As shown in Figure 6.17, the three faintest pulsars with measured VLBI parallaxes were observed in this thesis, and the results for these three are partially (PSR J2144–3933) or predominantly (PSR J0108–1431, PSR J0737–3039A/B) sensitivity-limited. PSR J2145–0750, which was only detected in two epochs, was also severely sensitivity limited. Thus, half of the target sample was dominated by thermal, rather than systematic errors. For the remaining four pulsars (PSR J0437–4715, PSR J0630–2834, PSR J1559–4438 and PSR J2048–1616) systematic errors dominated thermal errors and equally weighted visibilities were used to minimise the impact of systematic errors on the fitted positions, as discussed in Section 5.5.3⁹.

The systematic error budget is likely to be dominated by residual ionospheric errors, since as noted in Section 5.3.2, the relatively low density of GPS receivers in the Southern Hemisphere makes the GPS-based ionospheric correction less accurate for the LBA than for the VLBA or EVN. As shown in Section 5.5.2, the median position shift due to the

⁹PSR J2144–3933, which was moderately sensitivity-limited, used equally weighted visibilities, but used natural weighting for imaging to maximise sensitivity, rather than the uniform weighting used for the systematic-dominated pulsars

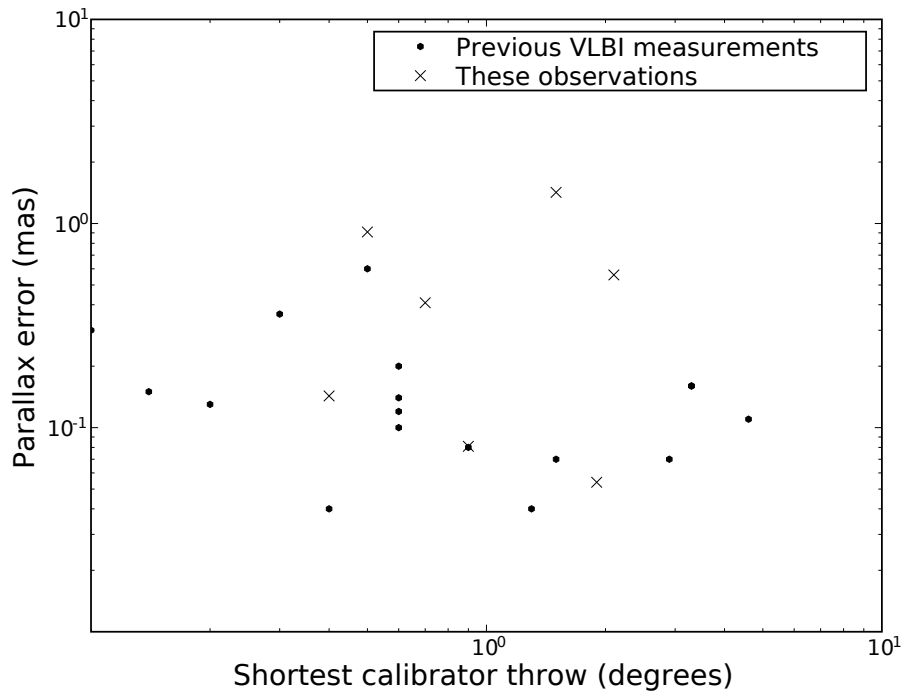

Figure 6.18 Parallax error plotted against calibrator throw in degrees, for all pulsars with a published VLBI parallax. Little trend is apparent with decreasing calibrator throw for both this work and previous surveys, which is surprising given the assumed dependence of systematic errors on calibrator throw.

application of ionospheric correction is approximately 3 mas for PSR J1559–4438. Since the accuracy of GPS–derived TEC maps ranges from 3–10% in the Northern Hemisphere (Sekido et al., 2004), the accuracy in the Southern Hemisphere is presumably $\sim 10\%$ or worse, and hence systematic errors due to residual ionospheric effects would be expected to be hundreds of μas for pulsars observed at 1600 MHz, comparable to the observed systematic error estimates. As discussed in Section 6.1.1, the application of ionospheric corrections made no significant difference for the 8 GHz observations, and residual tropospheric errors are expected to dominate in this case.

6.4.1 The future of pulsar astrometry

Over the next decade, the construction of new radiotelescopes and the upgrading of existing interferometers to larger bandwidths will lead to a revolution in astrometry at radio wavelengths. The most ambitious, and most distant, project is the Square Kilometre Array (SKA¹⁰), which when completed will combine nanoJansky sensitivity with excellent spatial resolution¹¹ of ~ 1 – 10 mas (in the high frequency band). LOFAR, which has already been discussed in Section 6.2.5, should be completed much earlier than the SKA and will offer excellent sensitivity at low frequencies, providing astrometric capabilities for faint, nearby objects, especially steep-spectrum pulsars. Given its low observing frequencies, LOFAR will suffer from relatively low resolution and increased ionospheric effects. For the faintest steep-spectrum objects, however, LOFAR will enable astrometry that would not otherwise have been possible.

In addition to these new facilities, large-scale bandwidth upgrades to the VLA¹², MERLIN¹³, and VLBA¹⁴ instruments are bringing μ Jy sensitivity to instruments with baselines of tens, hundreds and thousands of kilometres respectively. Due to its shorter baselines, the VLA is unlikely to be able to compete in terms of astrometric accuracy generally, but may be useful for high frequency observations of flat-spectrum sources.

The increased sensitivity of these instruments will allow fainter pulsars to be targeted, but will not improve astrometric accuracy for brighter pulsars beyond what can presently be obtained unless improved calibration methods can be applied. As shown in Section 6.1.1 for PSR J0437–4715, systematic errors already dominate the error budget with existing instrumentation for the brightest pulsars, even with the comparatively modest sensitivity of the existing LBA, and at frequencies where the influence of the ionosphere are minimal.

One approach which has already been successfully demonstrated is the use of wide bandwidths to measure the quadratically dependent (upon frequency) component of visibility phase induced by the ionosphere, using self-calibration on the target source (Brisken et al., 2002). Whilst this technique is likely to be particularly valuable for pulsar astrometry with future instruments, it cannot account for tropospheric errors and will still not be feasible for the faintest pulsars. Thus, new methods of calibration will be required.

Ideally, calibration will minimise the error in the estimated path delay and complex gain in the direction of the target source at all times, across the entire observing band-

¹⁰<http://www.skatelescope.org/>

¹¹in its current specification, which includes baselines to 3000 km

¹²<http://www.vla.nrao.edu/>

¹³<http://www.merlin.ac.uk/>

¹⁴<http://www.vlba.nrao.edu/>

width. This removal of the temporal and spatial interpolation which has traditionally been required in VLBI phase-referencing experiments is possible using a technique which is commonly known as “field calibration”, which is analogous to the technique of adaptive optics in optical astronomy. Whilst the coherence time is much longer at radio wavelengths than optical, the density of strong radio sources is much lower than optical sources, meaning that this technique could not be applied to the narrow-field, low sensitivity VLBI arrays which have been available to date. The advent of wide-bandwidth systems will provide the sensitivity required to make this technique possible on the planned and upgraded facilities mentioned above. Bhatnagar et al. (2008) give an overview of the algorithms used for field calibration.

Thus, for astrometric purposes, the availability of more calibrator sources is potentially the largest advantage of the improved sensitivity of new and upgraded instruments. Of the instruments listed above, the upgraded MERLIN (eMERLIN) is unique in that it is a heterogeneous array – all of the other arrays are composed of identical elements. The presence of several large telescopes in the eMERLIN array will make the field calibration described above more difficult, since the field of view of the array is limited by these large telescopes. Thus, it will be difficult for eMERLIN to reach the limiting accuracies that should be possible with the upgraded VLBA.

Since field-based calibration routines have not yet been tested in detail, it is difficult to predict the limiting accuracy that can be attained. Ultimately, the ability to model the (time-variable) structure of each source used as an in-beam calibrator is likely to determine the precision achieved. Fomalont and Reid (2004) estimate that the SKA can obtain single-epoch accuracies of several μas for mJy targets, meaning sub- μas parallax accuracies should be attainable. However, as noted in Fomalont and Reid (2004), the final specification of the SKA instrument, in particular the amount of collecting area devoted to long baseline stations, could significantly impact these estimates. The upgraded VLBA, unlike the SKA, will still be sensitivity limited for mJy sources – nevertheless, μas parallax accuracies should be attainable, at least for some sources.

The accuracies for these radio interferometers can be contrasted with the next generation of optical instrumentation. The dedicated orbiting astrometric telescope GAIA¹⁵, scheduled to launch in 2011, will derive accurate positions for over a billion stars. The astrometric accuracy will depend on target brightness, but is expected to range from $\sim 7 \mu\text{as}$ for bright stars, to $\sim 25 \mu\text{as}$ for 15th magnitude stars, and sub-mas parallaxes for 20th magnitude stars (Lindegren et al., 2008). This will allow significant distance determina-

¹⁵www.esa.int/science/gaia

tion for these stars at distances as great as the Galactic centre. Clearly, GAIA will allow the measurement of a much greater number of sources than will be possible with VLBI, even in the SKA era. However, the most accurate determination of individual objects is almost certain to still be achieved using VLBI.

Since GAIA will be limited to objects much brighter than pulsars, it will not be able to contribute to pulsar astrometry specifically except for binary pulsars with an optically visible companion, such as PSR B1259-63 (Johnston et al., 1994). While many pulsar companions are faint white dwarf stars that would be challenging targets for optical astrometry, the detection of even a few of the brightest optical pulsar companions would enable an improved frame tie between the optical reference frame and the ICRF. Since the frame tie between the Solar System frame and the ICRF is already good, thanks to comparisons of VLBI and timing astrometry, this would also serve to enhance the compatibility of the optical and Solar System frames.

7

CONCLUSIONS

As described in Chapter 1, this thesis aimed to develop the tools necessary to enable high-sensitivity pulsar observations with the Australian Long Baseline Array, allowing the largest pulsar astrometry program in the Southern Hemisphere to date to be undertaken. These tools included a general purpose software correlator (DiFX) and a flexible astrometric data reduction pipeline which implements several novel techniques for pulsar VLBI astrometry. DiFX has been extensively tested against three existing hardware correlators and is now used full-time for the LBA National Facility; it is also presently being adopted by other VLBI arrays, including the VLBA. The astrometry project has been successfully concluded with the measurement of seven pulsar parallaxes, more than tripling the number of Southern Hemisphere pulsars with a VLBI-measured parallax. Thus, the twin goals set at the outset of the thesis have been satisfactorily accomplished. The contributions of this thesis to, and possible future directions of, the main thesis areas of VLBI instrumentation and VLBI pulsar astrometry are considered in more detail below.

7.1 VLBI instrumentation

The DiFX software correlator developed during this thesis continues to expand in capability and scope, and is expected to become the primary correlator for a minimum of two additional arrays (the VLBA and the new Australian/NZ geodetic array funded under AuScope) during 2009. Unique experiments such as extremely high spectral resolution pulsar scintillation studies, using high sensitivity VLBI, have been correlated using DiFX. These experiments would not have been feasible using existing correlator infrastructure. The first eVLBI observations within Australia, and the first Australian eVLBI observations incorporating Asian antennas, have been made using DiFX. As more telescopes are connected to high-speed networks, eVLBI offers the possibility of dramatically reducing

operating costs for VLBI networks, by reducing costs associated with maintaining and shipping large quantities of physical storage.

For the LBA, the bandwidth upgrade enabled by DiFX has resulted in a significant increase in the number of proposals to use the instrument. Other substantial improvements have been made to LBA functionality during this thesis, such as reductions in the uncertainty of antenna positions and refinement of the correlator geometric model. These improvements are reflected by the number of ongoing astrometric LBA programs, and the number of current astrometric LBA proposals.

Future developments in DiFX will see the addition of capabilities such as single pass correlation of multiple phase centres, adaptation to new recording and output formats and increased ease of use. These features, coupled with other instrumental improvements such as wide-bandwidth digital backends, will allow existing VLBI arrays such as the LBA and VLBA to begin to conduct SKA-style wide-area, high angular resolution surveys at high sensitivity. As well as dramatically improving knowledge of the radio sky at high resolution, this will help pave the way for SKA observations through development of wide-field imaging techniques and calibration.

As the power and efficiency of digital electronics continue to grow in the future, an ever-larger region of interferometer parameter space will become economic to correlate with software-based, as opposed to hardware-based, solutions. In the three and a half years of this thesis, the computing capacity of the Swinburne supercomputer has increased four-fold, and most correlations are now run using only the CPUs available on the machines which host the storage media. For existing and planned VLBI arrays (excluding the SKA), a software-based solution is feasible now, and will become more so in the future. This offers the potential to continue progress towards the standardisation of VLBI formats, which with attendant improvements to support software and usability will help make VLBI observations accessible to a wider cross-section of the astronomical community.

7.2 VLBI pulsar astrometry

Of eight pulsars observed in this thesis, parallax and proper motion measurements have been made for seven, with a proper motion determination for the final object. This is comparable to the largest published Northern Hemisphere parallax program conducted using the VLBA (Briskin et al., 2002), where nine parallaxes were observed from ten objects. Ironically, the offending pulsar was the same in both instances – PSR J2145–0750.

The ensemble of independent distance and velocity measurements for these seven pulsars has been used along with previously published results to analyse the capabilities and shortcomings of the NE2001 Galactic electron distribution model used to predict pulsar distances, the accuracy of estimates of pulsar transverse velocities using scintillation, and the presence and relative contribution of different sources of systematic error in relative astrometry. This analysis has shown that while the NE2001 distance model offers significant improvements over the previous TC93 distance model, appearing to eliminate the systematic bias seen in the latter, it still possesses a long tail of large distance errors. A simple model of these infrequent, large distance errors shows they systematically bias pulsar velocities derived using the NE2001 model, leading to an 18% increase in the mean observed 2D transverse pulsar velocity and a fifty-fold increase in the number of very fast moving pulsars (transverse velocities greater than 1000 km s^{-1}). However, this simple model is itself likely to be somewhat biased by selection effects in the available independent pulsar distance measurements, and thus these results are almost certainly an upper limit to the errors induced in velocity estimates. An unbiased parallax sample would aid in quantifying the true impact of distance model errors. Scintillation velocity estimates have been shown to be unreliable for individual pulsars under the typical assumptions of a thin scattering screen with an isotropic turbulence distribution.

In addition, the distance and velocity measurements have allowed a number of important conclusions for the individual objects, with the most significant being:

- The radio luminosity of PSR J0108–1431, while low, is a factor of 3.4 higher than previously thought. Interestingly, though, its recently measured x-ray luminosity, coupled with its newly measured distance and proper motion implies that it is the most efficient converter of spin-down luminosity to x-ray luminosity amongst rotation-powered pulsars, and that reheating must occur for isolated neutron stars.
- The most precise pulsar distance determination made to date, for PSR J0437–4715, constrains the time rate of change of Newton’s gravitational constant G to be less than 3 parts in 10^{12} , and precludes the presence of an unseen Jupiter-mass planet within 226 AU of the Sun (within 50% of the sky).
- The parallax of PSR J0630–2834 shows that the pulsar is more than four times closer than predicted by the NE2001 distance model, revising its x-ray luminosity down by a factor of 19 and proving that the system does not require an unusually efficient method of producing x-rays.

- The first significant measurement of the parallax of the double pulsar J0737–3039A/B shows that the system is more than twice as distant as the DM -derived predictions, and enabled calculation of the kinematic terms which contribute to the observed orbital period derivative. The accuracy of the distance and velocity determination from this thesis will permit tests of GR using the double pulsar system to proceed to the 0.01% level. Furthermore, the confirmation of the system’s low transverse velocity supports formation scenarios in which neither pulsar received a large kick at birth. Finally, the revised distance strongly supports a magnetospheric origin for the majority of the x-rays observed in the PSR J0737–3039A/B system.
- PSR J2144–3933 is shown to be even closer than its DM -derived distance of 180 pc, confirming that it is the least luminous pulsar known at 1400 MHz. The revision to its period derivative based on the measurement of distance and proper motion places it even further past the traditionally assumed pulsar “death line”.

The future of VLBI pulsar astrometry is bright, with continual improvement in instrumentation bringing more and more pulsars within reach of the technique. With this work having shown that the measurement of pulsar parallaxes with the LBA is possible out to and beyond two kpc, a large number of southern pulsars are accessible. Several LBA proposals for pulsar astrometry are currently active, and the number of VLBI parallaxes in the south should continue to grow. A proposal has also been submitted for the continuation of astrometry on PSR J0437–4715, which could lead to the most accurate VLBI parallax measurement of any object to date, and allow a limit on the time rate of change of G which surpasses that presently made by Lunar Laser Ranging.

Beyond the LBA, the sensitivity upgrade of the VLBA which is presently underway should deliver 4 Gbps recording capabilities during 2009. This upgrade will deliver instantaneous sensitivity surpassing that of the LBA and approaching that of the EVN, but with a much greater field of view. When combined with the full-time operation and concurrent systematic control available with the VLBA, the upgrade should allow the deepest VLBI-resolution imaging ever made. This will enable almost any known pulsar to be targeted for VLBI astrometry, and allow larger and more complete astrometric surveys to be undertaken. Further in the future, the SKA will integrate VLBI into connected-element observing and make astrometry of pulsars almost routine; it is likely to revolutionise our knowledge of their spatial, velocity and luminosity distributions. The trickle of measured pulsar parallaxes is likely to become a flood over the next decade, and may help astronomers finally gain a solid understanding of the birth, life and death of pulsars.

Bibliography

- Ables, J. G. *Maximum Entropy Spectral Analysis*. A&AS, 15:383, June 1974.
- Alford, M., Jotwani, P., Kouvaris, C., Kundu, J., & Rajagopal, K. *Astrophysical implications of gapless color-flavor locked quark matter: A hot water bottle for aging neutron stars*. Phys. Rev. D, 71(11):114011, June 2005.
- Alpar, M. A., Cheng, A. F., Ruderman, M. A., & Shaham, J. *A new class of radio pulsars*. Nature, 300:728–730, December 1982.
- Avruch, I., Pogrebenko, S. V., & Gurvits, L. I. *VLBI observations of spacecraft*. In *Proceedings of the 8th European VLBI Network Symposium*, 2006.
- Baade, W. & Zwicky, F. *Cosmic Rays from Super-novae*. Proceedings of the National Academy of Science, 20:259–263, 1934.
- Backer, D. C. *Pulsar Nulling Phenomena*. Nature, 228:42, October 1970.
- Bailes, M. *The origin of pulsar velocities and the velocity-magnetic moment correlation*. ApJ, 342:917–927, July 1989.
- Bailes, M., Manchester, R. N., Kesteven, M. J., Norris, R. P., & Reynolds, J. E. *The parallax and proper motion of PSR1451-68*. Nature, 343:240, January 1990.
- Bailes, M., Harrison, P. A., Lorimer, D. R., Johnston, S., Lyne, A. G., Manchester, R. N., D’Amico, N., Nicastro, L., Tauris, T. M., & Robinson, C. *Discovery of three binary millisecond pulsars*. ApJ, 425:L41–L44, April 1994.
- Bare, C., Clark, B. G., Kellermann, K. I., Cohen, M. H., & Jauncey, D. L. *Interferometer Experiment with Independent Local Oscillators*. Science, 157:189–191, July 1967.
- Bartel, N., Chandler, J. F., Ratner, M. I., Shapiro, I. L., Pan, R., & Cappallo, R. J. *Toward a Frame TI via Millisecond Pulsar VLBI*. AJ, 112:1690, October 1996.
- Becker, W. *X-ray Emission Characteristics of Pulsars*. In *Highly Energetic Physical Processes and Mechanisms for Emission from Astrophysical Plasmas*, editors Martens, P. C. H., Tsuruta, S., & Weber, M. A., volume 195 of *IAU Symposium*, page 49, May 2000.
- Becker, W. & Trümper, J. *The X-ray emission properties of millisecond pulsars*. A&A, 341:803–817, January 1999.

- Becker, W., Jessner, A., Kramer, M., Testa, V., & Howaldt, C. *A Multiwavelength Study of PSR B0628-28: The First Overluminous Rotation-powered Pulsar?* ApJ, 633:367–376, November 2005.
- Belczynski, K., Kalogera, V., & Bulik, T. *A Comprehensive Study of Binary Compact Objects as Gravitational Wave Sources: Evolutionary Channels, Rates, and Physical Properties.* ApJ, 572(1):407–431, 2002.
- Bell, J. F. & Bailes, M. *New Method for Obtaining Binary Pulsar Distances and Its Implications for Tests of General Relativity.* ApJ, 456:L33+, January 1996.
- Bell, J. F., Bailes, M., & Bessell, M. S. *Optical detection of the companion of the millisecond pulsar J0437 - 4715.* Nature, 364:603–605, August 1993.
- Bell, J. F., Kulkarni, S. R., Bailes, M., Leitch, E. M., & Lyne, A. G. *Optical Observations of the Binary Millisecond Pulsars J2145-0750 and J0034-0534.* ApJ, 452:L121, October 1995.
- Bhat, N. D. R., Rao, A. P., & Gupta, Y. *Long-Term Scintillation Studies of Pulsars. I. Observations and Basic Results.* ApJS, 121:483–513, April 1999.
- Bhatnagar, S., Cornwell, T. J., Golap, K., & Uson, J. M. *Correcting direction-dependent gains in the deconvolution of radio interferometric images.* ArXiv e-prints, 0805.0834, May 2008.
- Bhattacharya, D. *Evolution of Neutron Star Magnetic Fields.* Journal of Astrophysics and Astronomy, 23:67, June 2002.
- Bhattacharya, D. & van den Heuvel, E. P. J. *Formation and evolution of binary and millisecond radio pulsars.* Phys. Rep., 203:1–124, 1991.
- Bhattacharya, D., Wijers, R. A. M. J., Hartman, J. W., & Verbunt, F. *On the decay of the magnetic fields of single radio pulsars.* A&A, 254:198–212, February 1992.
- Blaauw, A. *On the origin of the O- and B-type stars with high velocities (the "run-away" stars), and some related problems.* Bull. Astron. Inst. Netherlands, 15:265, May 1961.
- Brisken, W. *Pulsar Astrometry with the VLBA.* In *Future Directions in High Resolution Astronomy*, editors Romney, J. & Reid, M., volume 340 of *Astronomical Society of the Pacific Conference Series*, page 489, December 2005.

- Briskin, W. F., Benson, J. M., Goss, W. M., & Thorsett, S. E. *Very Long Baseline Array Measurement of Nine Pulsar Parallaxes*. ApJ, 571:906–917, June 2002.
- Briskin, W. F., Fruchter, A. S., Goss, W. M., Herrnstein, R. M., & Thorsett, S. E. *Proper-Motion Measurements with the VLA. II. Observations of 28 Pulsars*. AJ, 126:3090–3098, December 2003.
- Burgay, M., D’Amico, N., Possenti, A., Manchester, R. N., Lyne, A. G., Joshi, B. C., McLaughlin, M. A., Kramer, M., Sarkissian, J. M., Camilo, F., Kalogera, V., Kim, C., & Lorimer, D. R. *An increased estimate of the merger rate of double neutron stars from observations of a highly relativistic system*. Nature, 426:531–533, December 2003.
- Burgay, M., Joshi, B. C., D’Amico, N., Possenti, A., Lyne, A. G., Manchester, R. N., McLaughlin, M. A., Kramer, M., Camilo, F., & Freire, P. C. C. *The Parkes High-Latitude pulsar survey*. MNRAS, 368:283–292, May 2006.
- Carlson, B. R., Dewdney, P. E., Burgess, T. A., Casorso, R. V., Petrachenko, W. T., & Cannon, W. H. *The S2 VLBI Correlator: A Correlator for Space VLBI and Geodetic Signal Processing*. PASP, 111:1025–1047, August 1999.
- Casse, J. L. *The European VLBI Network MkIV Data Processor*. New Astronomy Review, 43:503–508, November 1999.
- Champion, D. J., Ransom, S. M., Lazarus, P., Camilo, F., Bassa, C., Kaspi, V. M., Nice, D. J., Freire, P. C. C., Stairs, I. H., van Leeuwen, J., Stappers, B. W., Cordes, J. M., Hessels, J. W. T., Lorimer, D. R., Arzoumanian, Z., Backer, D. C., Bhat, N. D. R., Chatterjee, S., Cognard, I., Deneva, J. S., Faucher-Giguère, C.-A., Gaensler, B. M., Han, J., Jenet, F. A., Kasian, L., Kondratiev, V. I., Kramer, M., Lazio, J., McLaughlin, M. A., Venkataraman, A., & Vlemmings, W. *An Eccentric Binary Millisecond Pulsar in the Galactic Plane*. Science, 320:1309, June 2008.
- Chandrasekhar, S. *The Maximum Mass of Ideal White Dwarfs*. ApJ, 74:81, July 1931.
- Chatterjee, S., Cordes, J. M., Lazio, T. J. W., Goss, W. M., Fomalont, E. B., & Benson, J. M. *Parallax and Kinematics of PSR B0919+06 from VLBA Astrometry and Interstellar Scintillometry*. ApJ, 550:287–296, March 2001.
- Chatterjee, S., Cordes, J. M., Vlemmings, W. H. T., Arzoumanian, Z., Goss, W. M., & Lazio, T. J. W. *Pulsar Parallaxes at 5 GHz with the Very Long Baseline Array*. ApJ, 604:339–345, March 2004.

- Chatterjee, S., Vlemmings, W. H. T., Brisken, W. F., Lazio, T. J. W., Cordes, J. M., Goss, W. M., Thorsett, S. E., Fomalont, E. B., Lyne, A. G., & Kramer, M. *Getting Its Kicks: A VLBA Parallax for the Hyperfast Pulsar B1508+55*. ApJ, 630:L61–L64, September 2005.
- Chatterjee, S., Gaensler, B. M., Melatos, A., Brisken, W. F., & Stappers, B. W. *Pulsed X-Ray Emission from Pulsar A in the Double Pulsar System J0737-3039*. ApJ, 670:1301–1306, December 2007.
- Chen, K. & Ruderman, M. *Pulsar death lines and death valley*. ApJ, 402:264–270, January 1993.
- Cheng, K. S., Ho, C., & Ruderman, M. *Energetic radiation from rapidly spinning pulsars. I - Outer magnetosphere gaps. II - VELA and Crab*. ApJ, 300:500–539, January 1986.
- Chiang, J. & Romani, R. W. *An outer gap model of high-energy emission from rotation-powered pulsars*. ApJ, 436:754–761, December 1994.
- Chikada, Y., Ishiguro, M., Hirabayashi, H., Morimoto, M., Morita, K.-I., Kanzawa, T., Iwashita, H., Nakazima, K., Ishikawa, S.-I., Takahashi, T., Handa, K., Kasuga, T., Okumura, S., Miyazawa, T., Nakazuru, T., Miura, K., & Nagasawa, S. *A 6×320 -MHz 1024-channel FFT cross-spectrum analyzer for radio astronomy*. IEEE Proceedings, 75:1203–1210, 1987.
- Clark, B. G., Cohen, M. H., & Jauncey, D. L. *Angular Size of 3C 273B*. ApJ, 149:L151, September 1967.
- Cocke, W. J., Disney, M. J., & Taylor, D. J. *Discovery of Optical Signals from Pulsar NP 0532*. Nature, 221:525, 1969.
- Coles, W. A., McLaughlin, M. A., Rickett, B. J., Lyne, A. G., & Bhat, N. D. R. *Probing the Eclipse of J0737-3039A with Scintillation*. ApJ, 623:392–397, April 2005.
- Cooley, J. W. & Tukey, J. W. *An Algorithm for the Machine Calculation of Complex Fourier Series*. Mathematics of Computation, 19(90):297–301, 1965.
- Cooper, B. F. C. *Correlators with two-bit quantization*. Australian Journal of Physics, 23:521, August 1970.
- Cordes, J. M. *Space velocities of radio pulsars from interstellar scintillations*. ApJ, 311:183–196, December 1986.

- Cordes, J. M. & Chernoff, D. F. *Neutron Star Population Dynamics. II. Three-dimensional Space Velocities of Young Pulsars*. ApJ, 505:315–338, September 1998.
- Cordes, J. M. & Lazio, T. J. W. *NE2001.I. A New Model for the Galactic Distribution of Free Electrons and its Fluctuations*. ArXiv e-prints, 0207156, July 2002.
- Cordes, J. M. & Rickett, B. J. *Diffraction Interstellar Scintillation Timescales and Velocities*. ApJ, 507:846–860, November 1998.
- Cordes, J. M., Pidwerbetsky, A., & Lovelace, R. V. E. *Refractive and diffractive scattering in the interstellar medium*. ApJ, 310:737–767, November 1986.
- Cordes, J. M., Romani, R. W., & Lundgren, S. C. *The Guitar nebula - A bow shock from a slow-spin, high-velocity neutron star*. Nature, 362:133–135, March 1993.
- Cordes, J. M., Rickett, B. J., Stinebring, D. R., & Coles, W. A. *Theory of Parabolic Arcs in Interstellar Scintillation Spectra*. ApJ, 637:346–365, January 2006.
- Cornwell, T. & Fomalont, E. B. *Self-Calibration*. In *Synthesis Imaging in Radio Astronomy II*, editors Taylor, G. B., Carilli, C. L., & Perley, R. A., volume 180 of *Astronomical Society of the Pacific Conference Series*, page 187, 1999.
- Damour, T. & Taylor, J. H. *On the orbital period change of the binary pulsar PSR 1913 + 16*. ApJ, 366:501–511, January 1991.
- Daugherty, J. K. & Harding, A. K. *Electromagnetic cascades in pulsars*. ApJ, 252:337–347, January 1982.
- Deller, A. T., Tingay, S. J., Bailes, M., & West, C. *DiFX: A Software Correlator for Very Long Baseline Interferometry Using Multiprocessor Computing Environments*. PASP, 119:318–336, March 2007.
- Deller, A. T., Verbiest, J. P. W., Tingay, S. J., & Bailes, M. *Extremely High Precision VLBI Astrometry of PSR J0437-4715 and Implications for Theories of Gravity*. ApJ, 685:L67–L70, September 2008.
- Deller, A. T., Bailes, M., & Tingay, S. J. *Implications of a VLBI distance to the double pulsar J0737-3039A/B*. Science, (10.1126/science.1167969), February 2009a.
- Deller, A. T., Tingay, S. J., & Brisken, W. *Precision Southern Hemisphere pulsar VLBI astrometry: Techniques and results for PSR J1559-4438*. ApJ, 690(1):198–209, 2009b.

- Dewey, R. J. & Cordes, J. M. *Monte Carlo simulations of radio pulsars and their progenitors*. ApJ, 321:780–798, October 1987.
- Dias, W. S. & Lépine, J. R. D. *Direct Determination of the Spiral Pattern Rotation Speed of the Galaxy*. ApJ, 629:825–831, August 2005.
- Dodson, R., Legge, D., Reynolds, J. E., & McCulloch, P. M. *The Vela Pulsar’s Proper Motion and Parallax Derived from VLBI Observations*. ApJ, 596:1137–1141, October 2003.
- Ekers, R. D. *Error Recognition*. In *Synthesis Imaging in Radio Astronomy II*, editors Taylor, G. B., Carilli, C. L., & Perley, R. A., volume 180 of *Astronomical Society of the Pacific Conference Series*, page 321, 1999.
- Faucher-Giguère, C.-A. & Kaspi, V. M. *Birth and Evolution of Isolated Radio Pulsars*. ApJ, 643:332–355, May 2006.
- Fazio, G. G., Helmken, H. F., O’Mongain, E., & Weekes, T. C. *Detection of High-Energy Gamma Rays from the Crab Nebula*. ApJ, 175:L117, August 1972.
- Feast, M. W. & Shuttlesworth, M. *The kinematics of B stars, cepheids, galactic clusters and interstellar gas in the Galaxy*. MNRAS, 130:245, 1965.
- Fey, A. L., Ma, C., Arias, E. F., Charlot, P., Feissel-Vernier, M., Gontier, A.-M., Jacobs, C. S., Li, J., & MacMillan, D. S. *The Second Extension of the International Celestial Reference Frame: ICRF-EXT.1*. AJ, 127:3587–3608, June 2004.
- Fomalont, E. & Reid, M. *Microarcsecond astrometry using the SKA*. New Astronomy Review, 48:1473–1482, December 2004.
- Fomalont, E. B. *From reference frames to relativistic experiments: Absolute and relative radio astrometry*. In *EAS Publications Series*, editors Gurvits, L. I., Frey, S., & Rawlings, S., volume 15 of *EAS Publications Series*, pages 131–155, 2005.
- Fomalont, E. B. *Astrometry and Geodesy*. In *Synthesis Imaging in Radio Astronomy II*, editors Taylor, G. B., Carilli, C. L., & Perley, R. A., volume 180 of *Astronomical Society of the Pacific Conference Series*, page 463, 1999.
- Fomalont, E. B., Goss, W. M., Manchester, R. N., & Lyne, A. G. *Improved proper motions for pulsars from VLA observations*. MNRAS, 286:81–84, March 1997.

- Foster, R. S. & Cordes, J. M. *Interstellar propagation effects and the precision of pulsar timing*. ApJ, 364:123–135, November 1990.
- Fricke, W., Schwan, H., Lederle, T., Bastian, U., Bien, R., Burkhardt, G., Du Mont, B., Hering, R., Jährling, R., Jahrei, H., Rser, S., Schwerdtfeger, H.-M., & Walter, H. G. *Fifth fundamental catalogue (FK5). Part 1: The basic fundamental stars*. Veröffentlichungen des Astronomischen Rechen-Instituts Heidelberg, 32:1–106, 1988.
- Fritz, G., Henry, R. C., Meekins, J. F., Chubb, T. A., & Friedman, H. *X-ray Pulsar in the Crab Nebula*. Science, 164:709–712, May 1969.
- Fryer, C. L. *Neutron Star Kicks from Asymmetric Collapse*. ApJ, 601:L175–L178, February 2004.
- Fryer, C. L. & Warren, M. S. *Modeling Core-Collapse Supernovae in Three Dimensions*. ApJ, 574:L65–L68, July 2002.
- Gaensler, B. M., Arons, J., Kaspi, V. M., Pivovarov, M. J., Kawai, N., & Tamura, K. *Chandra Imaging of the X-Ray Nebula Powered by Pulsar B1509-58*. ApJ, 569:878–893, April 2002.
- Ghez, A. M., Salim, S., Weinberg, N. N., Lu, J. R., Do, T., Dunn, J. K., Matthews, K., Morris, M. R., Yelda, S., Becklin, E. E., Kremenek, T., Milosavljevic, M., & Naiman, J. *Measuring Distance and Properties of the Milky Way’s Central Supermassive Black Hole with Stellar Orbits*. ApJ, 689:1044–1062, December 2008.
- Gold, T. *Rotating Neutron Stars as the Origin of the Pulsating Radio Sources*. Nature, 218:731–+, May 1968.
- Goldreich, P. & Julian, W. H. *Pulsar Electrodynamics*. ApJ, 157:869, August 1969.
- Goldreich, P. & Reisenegger, A. *Magnetic field decay in isolated neutron stars*. ApJ, 395: 250–258, August 1992.
- Gontier, A.-M., Le Bail, K., Feissel, M., & Eubanks, T. M. *Stability of the extragalactic VLBI reference frame*. A&A, 375:661–669, August 2001.
- Gothoskar, P. & Gupta, Y. *Scintillation Velocities of Five Millisecond Pulsars*. ApJ, 531: 345–349, March 2000.

- Grindlay, J. E., Camilo, F., Heinke, C. O., Edmonds, P. D., Cohn, H., & Lugger, P. *Chandra Study of a Complete Sample of Millisecond Pulsars in 47 Tucanae and NGC 6397*. ApJ, 581:470–484, December 2002.
- Gupta, Y. *On the Correlation between Proper Motion Velocities and Scintillation Velocities of Radio Pulsars*. ApJ, 451:717, October 1995.
- Gupta, Y., Rickett, B. J., & Lyne, A. G. *Refractive Interstellar Scintillation in Pulsar Dynamic Spectra*. MNRAS, 269:1035, August 1994.
- Hankins, T. H. & Rickett, B. J. *Pulsar signal processing*. Methods in Computational Physics, 14:55–129, 1975.
- Harrison, P. A., Lyne, A. G., & Anderson, B. *New determinations of the proper motions of 44 pulsars*. MNRAS, 261:113–124, March 1993.
- Helfand, D. J., Gotthelf, E. V., & Halpern, J. P. *Vela Pulsar and Its Synchrotron Nebula*. ApJ, 556:380–391, July 2001.
- Hessels, J. W. T., Ransom, S. M., Stairs, I. H., Freire, P. C. C., Kaspi, V. M., & Camilo, F. *A Radio Pulsar Spinning at 716 Hz*. Science, 311:1901–1904, March 2006.
- Hewish, A., Bell, S. J., Pilkington, J. D., Scott, P. F., & Collins, R. A. *Observation of a Rapidly Pulsating Radio Source*. Nature, 217:709, February 1968.
- Hobbs, G., Lyne, A. G., Kramer, M., Martin, C. E., & Jordan, C. *Long-term timing observations of 374 pulsars*. MNRAS, 353:1311–1344, October 2004.
- Hobbs, G., Lorimer, D. R., Lyne, A. G., & Kramer, M. *A statistical study of 233 pulsar proper motions*. MNRAS, 360:974–992, July 2005.
- Hobbs, G. B., Edwards, R. T., & Manchester, R. N. *TEMPO2, a new pulsar-timing package - I. An overview*. MNRAS, 369:655–672, June 2006.
- Hobbs, G. B., Jenet, F. A., Lee, K. J., Verbiest, J. P. W., Yardley, D., Manchester, R. N., Lommen, A., Coles, W. A., Edwards, R. T., & Shettigara, C. *TEMPO2, a new pulsar-timing package - III. Gravitational wave simulations*. MNRAS, submitted, 2008.
- Högbom, J. A. *Aperture Synthesis with a Non-Regular Distribution of Interferometer Baselines*. A&AS, 15:417, June 1974.
- Holmberg, J. & Flynn, C. *The local surface density of disc matter mapped by Hipparcos*. MNRAS, 352:440–446, August 2004.

- Horiuchi, S., Kameno, S., Nan, R., Shibata, K., Inoue, M., Kobayashi, H., Murata, Y., Formont, E., & Carlson, B. *Imaging Capability of the Mitaka VSOP Correlator*. *Advances in Space Research*, 26:625–628, 2000.
- Hotan, A. W., Bailes, M., & Ord, S. M. *PSR J1022+1001: profile stability and precision timing*. *MNRAS*, 355:941–949, December 2004.
- Hotan, A. W., Bailes, M., & Ord, S. M. *Geodetic Precession in PSR J1141-6545*. *ApJ*, 624:906–913, May 2005.
- Hotan, A. W., Bailes, M., & Ord, S. M. *High-precision baseband timing of 15 millisecond pulsars*. *MNRAS*, 369:1502–1520, July 2006.
- Iguchi, S., Kkurayama, T., Kawaguchi, N., & Kawakami, K. *Gigabit Digital Filter Bank: Digital Backend Subsystem in the VERA Data-Acquisition System*. *PASJ*, 57:259–271, February 2005.
- Iwamoto, K., Mazzali, P. A., Nomoto, K., Umeda, H., Nakamura, T., Patat, F., Danziger, I. J., Young, T. R., Suzuki, T., Shigeyama, T., Augusteijn, T., Doublier, V., Gonzalez, J.-F., Boehnhardt, H., Brewer, J., Hainaut, O. R., Lidman, C., Leibundgut, B., Cappellaro, E., Turatto, M., Galama, T. J., Vreeswijk, P. M., Kouveliotou, C., van Paradijs, J., Pian, E., Palazzi, E., & Frontera, F. *A hypernova model for the supernova associated with the γ -ray burst of 25 April 1998*. *Nature*, 395:672–674, October 1998.
- Jansky, K. G. *Electrical disturbances apparently of extraterrestrial origin*. *Proceedings of the IRE*, 21(10):1387–1396, October 1933.
- Jenet, F. A., Hobbs, G. B., Lee, K. J., & Manchester, R. N. *Detecting the Stochastic Gravitational Wave Background Using Pulsar Timing*. *ApJ*, 625:L123–L126, June 2005.
- Jenet, F. A., Hobbs, G. B., van Straten, W., Manchester, R. N., Bailes, M., Verbiest, J. P. W., Edwards, R. T., Hotan, A. W., Sarkissian, J. M., & Ord, S. M. *Upper Bounds on the Low-Frequency Stochastic Gravitational Wave Background from Pulsar Timing Observations: Current Limits and Future Prospects*. *ApJ*, 653:1571–1576, December 2006.
- Johnston, S., Lorimer, D. R., Harrison, P. A., Bailes, M., Lyne, A. G., Bell, J. F., Kaspi, V. M., Manchester, R. N., D’Amico, N., & Nicastro, L. *Discovery of a very bright, nearby binary millisecond pulsar*. *Nature*, 361:613–615, February 1993.

- Johnston, S., Manchester, R. N., Lyne, A. G., Nicastro, L., & Spyromilio, J. *Radio and Optical Observations of the PSR:B1259-63 / SS:2883 Be-Star Binary System*. MNRAS, 268:430, May 1994.
- Johnston, S., Nicastro, L., & Koribalski, B. *Scintillation parameters for 49 pulsars*. MNRAS, 297:108–116, June 1998.
- Johnston, S., Manchester, R. N., McConnell, D., & Campbell-Wilson, D. *Transient radio emission from the PSR B1259-63 system near periastron*. MNRAS, 302:277–287, January 1999.
- Johnston, S., Hobbs, G., Vigeland, S., Kramer, M., Weisberg, J. M., & Lyne, A. G. *Evidence for alignment of the rotation and velocity vectors in pulsars*. MNRAS, 364:1397–1412, December 2005.
- Johnston, S., Kramer, M., Karastergiou, A., Hobbs, G., Ord, S., & Wallman, J. *Evidence for alignment of the rotation and velocity vectors in pulsars - II. Further data and emission heights*. MNRAS, 381:1625–1637, November 2007.
- Kalogera, V., Kim, C., Lorimer, D. R., Burgay, M., D’Amico, N., Possenti, A., Manchester, R. N., Lyne, A. G., Joshi, B. C., McLaughlin, M. A., Kramer, M., Sarkissian, J. M., & Camilo, F. *The Cosmic Coalescence Rates for Double Neutron Star Binaries*. ApJ, 601:L179–L182, February 2004.
- Kargaltsev, O., Pavlov, G. G., & Romani, R. W. *Ultraviolet Emission from the Millisecond Pulsar J0437-4715*. ApJ, 602:327–335, February 2004.
- Kargaltsev, O., Pavlov, G. G., & Garmire, G. P. *X-Ray Emission from the Nearby PSR B1133+16 and Other Old Pulsars*. ApJ, 636:406–410, January 2006.
- Kellermann, K. I. & Cohen, M. H. *The origin and evolution of the N.R.A.O.-Cornell VLBI system*. JRASC, 82:248–265, October 1988.
- Kellermann, K. I. & Moran, J. M. *The Development of High-Resolution Imaging in Radio Astronomy*. ARA&A, 39:457–509, 2001.
- Kettenis, M., van Langevelde, H. J., Reynolds, C., & Cotton, B. *ParselTongue: AIPS Talking Python*. In *Astronomical Data Analysis Software and Systems XV*, editors Gabriel, C., Arviset, C., Ponz, D., & Enrique, S., volume 351 of *Astronomical Society of the Pacific Conference Series*, page 497, July 2006.

- Kondo, T., Kimura, M., Koyama, Y., & Osaki, H. *Current Status of Software Correlators Developed at Kashima Space Research Center*. In *International VLBI Service for Geodesy and Astrometry 2004 General Meeting Proceedings*, editors Vandenberg, N. R. & Baver, K. D., page 36, June 2004.
- Koribalski, B., Johnston, S., Weisberg, J. M., & Wilson, W. *H I line measurements of eight southern pulsars*. *ApJ*, 441:756–764, March 1995.
- Kovalev, Y. Y., Petrov, L., Fomalont, E. B., & Gordon, D. *The Fifth VLBA Calibrator Survey: VCS5*. *AJ*, 133:1236–1242, April 2007.
- Koyama, Y., Kondo, T., Osaki, H., Hirabaru, M., Takashima, K., Sorai, K., Takaba, H., Fujisawa, K., Lapsley, D., Dudevoir, K., & Whitney, A. *Geodetic VLBI Experiments with the K5 System*. In *International VLBI Service for Geodesy and Astrometry 2004 General Meeting Proceedings*, editors Vandenberg, N. R. & Baver, K. D., page 43, June 2004.
- Kramer, M., Xilouris, K. M., Lorimer, D. R., Doroshenko, O., Jessner, A., Wielebinski, R., Wolszczan, A., & Camilo, F. *The Characteristics of Millisecond Pulsar Emission. I. Spectra, Pulse Shapes, and the Beaming Fraction*. *ApJ*, 501:270, July 1998.
- Kramer, M., Lyne, A. G., Hobbs, G., Löhmer, O., Carr, P., Jordan, C., & Wolszczan, A. *The Proper Motion, Age, and Initial Spin Period of PSR J0538+2817 in S147*. *ApJ*, 593:L31–L34, August 2003.
- Kramer, M., Stairs, I. H., Manchester, R. N., McLaughlin, M. A., Lyne, A. G., Ferdman, R. D., Burgay, M., Lorimer, D. R., Possenti, A., D’Amico, N., Sarkissian, J. M., Hobbs, G. B., Reynolds, J. E., Freire, P. C. C., & Camilo, F. *Tests of General Relativity from Timing the Double Pulsar*. *Science*, 314:97–102, October 2006.
- Lai, D., Chernoff, D. F., & Cordes, J. M. *Pulsar Jets: Implications for Neutron Star Kicks and Initial Spins*. *ApJ*, 549:1111–1118, March 2001.
- Large, M. I., Vaughan, A. E., & Wielebinski, R. *Some Further Pulsar Observations at the Molonglo Radio Observatory*. *Astrophys. Lett.*, 3:123, 1969.
- Larson, M. B. & Link, B. *Simulations of glitches in isolated pulsars*. *MNRAS*, 333:613–622, July 2002.
- Lattimer, J. M. & Prakash, M. *Neutron star observations: Prognosis for equation of state constraints*. *Phys. Rep.*, 442:109–165, April 2007.

- Lee, L. C. & Jokipii, J. R. *Strong scintillations in astrophysics. II - A theory of temporal broadening of pulses*. ApJ, 201:532–543, October 1975.
- Legge, D. *Accurate Astrometry of Southern Pulsars*. PhD thesis, University of Tasmania, 2002.
- Lindgren, L., Babusiaux, C., Bailer-Jones, C., Bastian, U., Brown, A. G. A., Cropper, M., Høg, E., Jordi, C., Katz, D., van Leeuwen, F., Luri, X., Mignard, F., de Bruijne, J. H. J., & Prusti, T. *The Gaia mission: science, organization and present status*. In *IAU Symposium*, volume 248 of *IAU Symposium*, pages 217–223, 2008.
- Liu, Z. Y., Wang, N., Urama, J. O., & Manchester, R. N. *Monitoring of Pulse Intensity and Mode Changing for PSR B0329+54*. Chinese Journal of Astronomy and Astrophysics Supplement, 6(2):020000–67, December 2006.
- Löhmer, O., Kramer, M., Driebe, T., Jessner, A., Mitra, D., & Lyne, A. G. *The parallax, mass and age of the PSR J2145-0750 binary system*. A&A, 426:631–640, November 2004.
- Loinard, L., Torres, R. M., Mioduszewski, A. J., Rodríguez, L. F., González-Lópezlira, R. A., Lachaume, R., Vázquez, V., & González, E. *VLBA Determination of the Distance to Nearby Star-forming Regions. I. The Distance to T Tauri with 0.4% Accuracy*. ApJ, 671:546–554, December 2007.
- Lorimer, D. R. *Binary and Millisecond Pulsars*. Living Reviews in Relativity, 11:8, November 2008.
- Lorimer, D. & Kramer, M. *Handbook of Pulsar Astronomy*, volume 4 of *Cambridge Observing Handbooks for Research Astronomers*. Cambridge University Press, Cambridge, U.K.; New York, U.S.A., 2005.
- Lundgren, S. C., Cordes, J. M., Foster, R. S., Wolszczan, A., & Camilo, F. *Optical Studies of Millisecond Pulsar Companions*. ApJ, 458:L33, February 1996.
- Lyne, A. G. *Mode changing in pulsar radiation*. MNRAS, 153:27P, 1971.
- Lyne, A. G., Manchester, R. N., & Taylor, J. H. *The galactic population of pulsars*. MNRAS, 213:613–639, April 1985.
- Lyne, A. G., Manchester, R. N., Lorimer, D. R., Bailes, M., D’Amico, N., Tauris, T. M., Johnston, S., Bell, J. F., & Nicastro, L. *The Parkes Southern Pulsar Survey - II. Final results and population analysis*. MNRAS, 295:743–755, April 1998.

- Lyne, A. G., Burgay, M., Kramer, M., Possenti, A., Manchester, R. N., Camilo, F., McLaughlin, M. A., Lorimer, D. R., D'Amico, N., Joshi, B. C., Reynolds, J., & Freire, P. C. C. *A Double-Pulsar System: A Rare Laboratory for Relativistic Gravity and Plasma Physics*. *Science*, 303:1153–1157, February 2004.
- Lyutikov, M. *On the nature of eclipses in binary pulsar J0737-3039*. *MNRAS*, 353:1095–1106, October 2004.
- Lyutikov, M., Blandford, R. D., & Machabeli, G. *On the nature of pulsar radio emission*. *MNRAS*, 305:338–352, April 1999.
- Ma, C., Arias, E. F., Eubanks, T. M., Fey, A. L., Gontier, A.-M., Jacobs, C. S., Sovers, O. J., Archinal, B. A., & Charlot, P. *The International Celestial Reference Frame as Realized by Very Long Baseline Interferometry*. *AJ*, 116:516–546, July 1998.
- Malov, I. F. & Malov, O. I. *Integrated radio luminosities of pulsars*. *Astronomy Reports*, 50:483–495, June 2006.
- Manchester, R. N. & Taylor, J. H. *Observed and derived parameters for 330 pulsars*. *AJ*, 86:1953–1973, December 1981.
- Manchester, R. N., Lyne, A. G., D'Amico, N., Bailes, M., Johnston, S., Lorimer, D. R., Harrison, P. A., Nicastro, L., & Bell, J. F. *The Parkes Southern Pulsar Survey. I. Observing and data analysis systems and initial results*. *MNRAS*, 279:1235–1250, April 1996.
- Manchester, R. N., Hobbs, G. B., Teoh, A., & Hobbs, M. *The Australia Telescope National Facility Pulsar Catalogue*. *AJ*, 129:1993–2006, April 2005.
- Maron, O., Kijak, J., Kramer, M., & Wielebinski, R. *Pulsar spectra of radio emission*. *A&AS*, 147:195–203, December 2000.
- McLaughlin, M. A., Camilo, F., Burgay, M., D'Amico, N., Joshi, B. C., Kramer, M., Lorimer, D. R., Lyne, A. G., Manchester, R. N., & Possenti, A. *X-Ray Emission from the Double Pulsar System J0737-3039*. *ApJ*, 605:L41–L44, April 2004.
- McLaughlin, M. A., Lyne, A. G., Lorimer, D. R., Kramer, M., Faulkner, A. J., Manchester, R. N., Cordes, J. M., Camilo, F., Possenti, A., Stairs, I. H., Hobbs, G., D'Amico, N., Burgay, M., & O'Brien, J. T. *Transient radio bursts from rotating neutron stars*. *Nature*, 439:817–820, February 2006.

- Michel, F. C. *Comment on "Self-consistent solution for an axisymmetric pulsar model"* [*Phys. Rev. Lett.*, Vol. 32, p. 1019 - 1022]. *Physical Review Letters*, 33:1521–1523, 1974.
- Middelberg, E. *Automated Editing of Radio Interferometer Data with pieflag*. Publications of the Astronomical Society of Australia, 23:64–68, May 2006.
- Migliazzo, J. M., Gaensler, B. M., Backer, D. C., Stappers, B. W., van der Swaluw, E., & Strom, R. G. *Proper-Motion Measurements of Pulsar B1951+32 in the Supernova Remnant CTB 80*. *ApJ*, 567:L141–L144, March 2002.
- Mignani, R. P., Manchester, R. N., & Pavlov, G. G. *Search for the Optical Counterpart of the Nearby Pulsar PSR J0108-1431*. *ApJ*, 582:978–983, January 2003.
- Mignani, R. P., Pavlov, G. G., & Kargaltsev, O. *A possible optical counterpart to the old nearby pulsar J0108-1431*. ArXiv e-prints, 0805.2586, May 2008.
- Mignard, F. *Local galactic kinematics from Hipparcos proper motions*. *A&A*, 354:522–536, February 2000.
- Moran, J. M., Crowther, P. P., Burke, B. F., Barrett, A. H., Rogers, A. E. E., Ball, J. A., Carter, J. C., & Bare, C. *Spectral Line Interferometry with Independent Time Standards at Stations Separated by 845 Kilometers*. *Science*, 157:676–677, August 1967.
- Napier, P. J., Bagri, D. S., Clark, B. G., Rogers, A. E. E., Romney, J. D., Thompson, A. R., & Walker, R. C. *The Very Long Baseline Array*. *IEEE Proceedings*, 82:658–672, May 1994.
- Nicastro, L. & Johnston, S. *Scintillation velocities for four millisecond pulsars*. *MNRAS*, 273:122–128, March 1995.
- Niell, A., Whitney, A. R., Petrachenko, W. T., Schlüter, W., Vandenberg, N. R., Hase, H., Koyama, Y., Ma, C., Schuh, H., & Tuccari, G. *VLBI2010: Current and Future Requirements for Geodetic VLBI Systems*. In *International VLBI Service for Geodesy and Astrometry 2005 Annual Report*, editors Behrend, D. & Baver, K., June 2005.
- Ott, C. D., Burrows, A., Thompson, T. A., Livne, E., & Walder, R. *The Spin Periods and Rotational Profiles of Neutron Stars at Birth*. *ApJS*, 164:130–155, May 2006.
- Pacini, F. *Rotating Neutron Stars, Pulsars and Supernova Remnants*. *Nature*, 219:145, July 1968.

- Paragi, Z., Kouveliotou, C., Garrett, M. A., Ramirez-Ruiz, E., van Langevelde, H. J., Szomoru, A., & Argo, M. *e-VLBI detection of SN2007gr*. The Astronomer's Telegram, 1215:1, September 2007.
- Pavlov, G. G., Kargaltsev, O., Wong, J. A., & Garmire, G. P. *Detection of X-ray Emission from the Very Old Pulsar J0108-1431*. ArXiv e-prints, 0803.0761, March 2008.
- Pawsey, J. L., Payne-Scott, R., & McCready, L. L. *Radio-Frequency Energy from the Sun*. Nature, 157(3980):158–159, February 1946.
- Pearson, T. J. *Non-Imaging Data Analysis*. In *Synthesis Imaging in Radio Astronomy II*, editors Taylor, G. B., Carilli, C. L., & Perley, R. A., volume 180 of *Astronomical Society of the Pacific Conference Series*, page 335, 1999.
- Pearson, T. J. & Readhead, A. C. S. *Image Formation by Self-Calibration in Radio Astronomy*. ARA&A, 22:97–130, 1984.
- Pellizzoni, A., Tiengo, A., De Luca, A., Esposito, P., & Mereghetti, S. *PSR J0737-3039: Interacting Pulsars in X-Rays*. ApJ, 679:664–674, May 2008.
- Perley, R. A., Napier, P. J., & Butler, B. J. *The Expanded Very Large Array: goals, progress, and plans*. In *Ground-based Telescopes*, editor Oschmann, Jr., J. M., volume 5489 of *Proceedings of the SPIE*, pages 784–795, October 2004.
- Petrov, L., Gordon, D., Gipson, J., MacMillan, D., Ma, C., Fomalont, E., Walker, R. C., & Carabajal, C. *Precise geodesy with the Very Long Baseline Array*. ArXiv e-prints, 0806.0167, June 2008.
- Phillips, C. J., Deller, A., Amy, S. W., Tingay, S. J., Tzioumis, A. K., Reynolds, J. E., Jauncey, D. L., Stevens, J., Ellingsen, S. P., Dickey, J., Fender, R. P., Tudose, V., & Nicolson, G. D. *Detection of compact radio emission from Circinus X-1 with the first Southern hemisphere e-VLBI experiment*. MNRAS, 380:L11–L14, September 2007.
- Piran, T. & Shaviv, N. J. *Origin of the Binary Pulsar J0737-3039B*. Physical Review Letters, 94(5):051102, February 2005.
- Podsiadlowski, P., Pfahl, E., & Rappaport, S. *Neutron-Star Birth Kicks*. In *Binary Radio Pulsars*, editors Rasio, F. A. & Stairs, I. H., volume 328 of *Astronomical Society of the Pacific Conference Series*, page 327, July 2005.

- Possenti, A., Rea, N., McLaughlin, M. A., Camilo, F., Kramer, M., Burgay, M., Joshi, B. C., & Lyne, A. G. *The Very Soft X-Ray Spectrum of the Double Pulsar System J0737-3039*. ApJ, 680:654–663, June 2008.
- Pradel, N., Charlot, P., & Lestrade, J.-F. *Astrometric accuracy of phase-referenced observations with the VLBA and EVN*. A&A, 452:1099–1106, June 2006.
- Prakash, M. *Quark matter and the astrophysics of neutron stars*. Journal of Physics G Nuclear Physics, 34:253, August 2007.
- Press, W. H., Vetterling, W. T., Teukolsky, S. A., & Flannery, B. P. *Numerical Recipes in C++: the art of scientific computing*. Cambridge University Press, 2002. ISBN 0-521-75033-4.
- Rankin, J. M. *Further Evidence for Alignment of the Rotation and Velocity Vectors in Pulsars*. ApJ, 664:443–447, July 2007.
- Ransom, S. M., Kaspi, V. M., Ramachandran, R., Demorest, P., Backer, D. C., Pfahl, E. D., Ghigo, F. D., & Kaplan, D. L. *Green Bank Telescope Measurement of the Systemic Velocity of the Double Pulsar Binary J0737-3039 and Implications for Its Formation*. ApJ, 609:L71–L74, July 2004.
- Rickett, B. J. *Radio propagation through the turbulent interstellar plasma*. ARA&A, 28:561–605, 1990.
- Roberts, P. P. *Calculating quantization correction formulae for digital correlators with digital fringe rotation*. A&AS, 126:379–383, December 1997.
- Romney, J. D. *Cross Correlators*. In *Synthesis Imaging in Radio Astronomy II*, editors Taylor, G. B., Carilli, C. L., & Perley, R. A., volume 180 of *Astronomical Society of the Pacific Conference Series*, page 57, 1999.
- Roy, A., Rottmann, H., Teuber, U., & Keller, R. *Phase correction of VLBI with water vapour radiometry*. In *Proceedings of the 8th European VLBI Network Symposium*, 2006.
- Ruderman, M. A. & Sutherland, P. G. *Theory of pulsars - Polar caps, sparks, and coherent microwave radiation*. ApJ, 196:51–72, February 1975.
- Ryle, M. *A New Radio Interferometer and Its Application to the Observation of Weak Radio Stars*. Royal Society of London Proceedings Series A, 211:351–375, March 1952.

- Ryle, M. & Vonberg, D. D. *Solar Radiation on 175 Mc./s.* Nature, 158(4010):339–340, September 1946.
- Sandhu, J. S., Bailes, M., Manchester, R. N., Navarro, J., Kulkarni, S. R., & Anderson, S. B. *The Proper Motion and Parallax of PSR J0437-4715.* ApJ, 478:L95, April 1997.
- Sandulescu, N., van Giai, N., & Liotta, R. J. *Superfluid properties of the inner crust of neutron stars.* Phys. Rev. C, 69(4):045802, April 2004.
- Sault, R. J., Teuben, P. J., & Wright, M. C. H. *A Retrospective View of MIRIAD.* In *Astronomical Data Analysis Software and Systems IV*, editors Shaw, R. A., Payne, H. E., & Hayes, J. J. E., volume 77 of *Astronomical Society of the Pacific Conference Series*, page 433, 1995.
- Schaab, C., Sedrakian, A., Weber, F., & Weigel, M. K. *Impact of internal heating on the thermal evolution of neutron stars.* A&A, 346:465–480, June 1999.
- Sekido, M., Kondo, T., Kawai, E., & Imae, M. *Evaluation of Global Ionosphere TEC by Comparison with VLBI Data.* In *International VLBI Service for Geodesy and Astrometry 2004 General Meeting Proceedings*, editors Vandenberg, N. R. & Baver, K. D., page 86, June 2004.
- Shapiro, I. I. *Fourth Test of General Relativity.* Physical Review Letters, 13:789–791, December 1964.
- Shepherd, M. C. *Difmap: an Interactive Program for Synthesis Imaging.* In *Astronomical Data Analysis Software and Systems VI*, editors Hunt, G. & Payne, H., volume 125 of *Astronomical Society of the Pacific Conference Series*, page 77, 1997.
- Shklovskii, I. S. *Possible Causes of the Secular Increase in Pulsar Periods.* Soviet Astronomy, 13:562, February 1970.
- Siegmán, B. C., Manchester, R. N., & Durdin, J. M. *Timing parameters for 59 pulsars.* MNRAS, 262:449–455, May 1993.
- Stairs, I. H., Thorsett, S. E., Dewey, R. J., Kramer, M., & McPhee, C. A. *The formation of the double pulsar PSR J0737-3039A/B.* MNRAS, 373:L50–L54, November 2006.
- Tauris, T. M., Nicastro, L., Johnston, S., Manchester, R. N., Bailes, M., Lyne, A. G., Glowacki, J., Lorimer, D. R., & D’Amico, N. *Discovery of PSR J0108-1431: The closest known neutron star?* ApJ, 428:L53–L55, June 1994.

- Taylor, J. H. & Cordes, J. M. *Pulsar distances and the galactic distribution of free electrons*. ApJ, 411:674–684, July 1993.
- Taylor, J. H. & Weisberg, J. M. *Further experimental tests of relativistic gravity using the binary pulsar PSR 1913 + 16*. ApJ, 345:434–450, October 1989.
- Thompson, A. R. *Fundamentals of Radio Interferometry*. In *Synthesis Imaging in Radio Astronomy II*, editors Taylor, G. B., Carilli, C. L., & Perley, R. A., volume 180 of *Astronomical Society of the Pacific Conference Series*, page 11, 1999.
- Thompson, A. R., Moran, J. M., & Swenson, Jr., G. W. *Interferometry and Synthesis in Radio Astronomy*. Wiley, New York, 1994.
- Thompson, C. & Duncan, R. C. *The Soft Gamma Repeaters as Very Strongly Magnetized Neutron Stars. II. Quiescent Neutrino, X-Ray, and Alfvén Wave Emission*. ApJ, 473:322, December 1996.
- Tingay, S. J. *e-VLBI observations of SN1987A with the LBA*. ApJ, submitted, 2008.
- Tingay, S. J., Alef, W., Graham, D., & Deller, A. T. *Geodetic VLBI correlation in software I. Feasibility of using the DiFX software correlator for geodetic VLBI*. Journal of Geodesy, submitted, 2008.
- Titov, O., Tesmer, V., & Boehm, J. *OCCAM v.6.0 Software for VLBI Data Analysis*. In *International VLBI Service for Geodesy and Astrometry 2004 General Meeting Proceedings, Ottawa, Canada.*, editors Vandenberg, N. R. & Baver, K. D., page 53, June 2004.
- Titov, O. A. *Apparent proper motions of radio sources from geodetic VLBI data*. Astronomy Letters, 33:481–487, July 2007.
- Torii, K., Tsunemi, H., Dotani, T., Mitsuda, K., Kawai, N., Kinugasa, K., Saito, Y., & Shibata, S. *Spin-Down of the 65 Millisecond X-Ray Pulsar in the Supernova Remnant G11.2-0.3*. ApJ, 523:L69–L72, September 1999.
- van den Heuvel, E. P. J. *Modes of mass transfer and classes of binary X-ray sources*. ApJ, 198:L109–L112, June 1975.
- van den Heuvel, E. P. J. & Bonsema, P. T. J. *Formation of a single millisecond pulsar by the coalescence of a neutron star and a massive white dwarf*. A&A, 139:L16–L18, October 1984.

- van Straten, W., Bailes, M., Britton, M., Kulkarni, S. R., Anderson, S. B., Manchester, R. N., & Sarkissian, J. *A test of general relativity from the three-dimensional orbital geometry of a binary pulsar*. *Nature*, 412:158–160, July 2001.
- Verbiest, J. P. W., Bailes, M., van Straten, W., Hobbs, G. B., Edwards, R. T., Manchester, R. N., Bhat, N. D. R., Sarkissian, J. M., Jacoby, B. A., & Kulkarni, S. R. *Precision Timing of PSR J0437-4715: An Accurate Pulsar Distance, a High Pulsar Mass, and a Limit on the Variation of Newton’s Gravitational Constant*. *ApJ*, 679:675–680, May 2008.
- Voûte, J. L. L., Kouwenhoven, M. L. A., van Haren, P. C., Langerak, J. J., Stappers, B. W., Driesens, D., Ramachandran, R., & Beijaard, T. D. *PuMa, a digital Pulsar Machine*. *A&A*, 385:733–742, April 2002.
- Walker, M. A. *Interstellar scintillation of compact extragalactic radio sources*. *MNRAS*, 294:307, February 1998.
- Walker, R. C. *Very Long Baseline Interferometry*. In *Synthesis Imaging in Radio Astronomy II*, editors Taylor, G. B., Carilli, C. L., & Perley, R. A., volume 180 of *Astronomical Society of the Pacific Conference Series*, page 433, 1999.
- Wang, N., Manchester, R. N., & Johnston, S. *Pulsar nulling and mode changing*. *MNRAS*, 377:1383–1392, May 2007.
- Weisberg, J. M., Romani, R. W., & Taylor, J. H. *Evidence for geodetic spin precession in the binary pulsar 1913 + 16*. *ApJ*, 347:1030–1033, December 1989.
- West, C. *Development of disk-based baseband recorders and software correlators for radio astronomy*. Master’s thesis, Swinburne University of Technology, 2004.
- Whitney, A. R. *Mark 5 Disk-Based Gbps VLBI Data System*. In *Astronomical Society of the Pacific Conference Series*, editor Minh, Y. C., volume 306 of *Astronomical Society of the Pacific Conference Series*, page 123, 2003.
- Whitney, A. R. *The Mark IV VLBI Data-Acquisition and Correlation System*. In *Developments in Astrometry and their Impact on Astrophysics and Geodynamics*, editors Mueller, I. I. & Kolaczek, B., volume 156 of *IAU Symposium*, pages 151–+, 1993.
- Whitney, A. R., Shapiro, I. I., Rogers, A. E. E., Robertson, D. S., Knight, C. A., Clark, T. A., Goldstein, R. M., Marandino, G. E., & Vandenberg, N. R. *Quasars Revisited:*

- Rapid Time Variations Observed Via Very-Long-Baseline Interferometry.* Science, 173: 225–230, July 1971.
- Willems, B., Kaplan, J., Fragos, T., Kalogera, V., & Belczynski, K. *Formation and progenitor of PSR J0737-3039: New constraints on the supernova explosion forming pulsar B.* Phys. Rev. D, 74(4):043003, August 2006.
- Williams, J. G., Turyshev, S. G., & Boggs, D. H. *Progress in Lunar Laser Ranging Tests of Relativistic Gravity.* Physical Review Letters, 93(26):261101, December 2004.
- Wilson, W., Roberts, P., & Davis, E. *The ATNF S-2 VLBI Correlator.* In *Proceedings of the 4th APT Workshop*, editor King, E., page 16, 1996.
- You, X. P., Hobbs, G., Coles, W. A., Manchester, R. N., Edwards, R., Bailes, M., Sarkissian, J., Verbiest, J. P. W., van Straten, W., Hotan, A., Ord, S., Jenet, F., Bhat, N. D. R., & Teoh, A. *Dispersion measure variations and their effect on precision pulsar timing.* MNRAS, 378:493–506, June 2007.
- Young, M. D., Manchester, R. N., & Johnston, S. *A radio pulsar with an 8.5-second period that challenges emission models.* Nature, 400:848–849, August 1999.
- Yue, Y. L., Xu, R. X., & Zhu, W. W. *What can the braking indices tell us about the nature of pulsars?* Advances in Space Research, 40:1491–1497, 2007.
- Zakamska, N. L. & Tremaine, S. *Constraints on the Acceleration of the Solar System from High-Precision Timing.* AJ, 130:1939–1950, October 2005.
- Zavlin, V. E. *XMM-Newton Observations of Four Millisecond Pulsars.* ApJ, 638:951–962, February 2006.
- Zavlin, V. E., Pavlov, G. G., Sanwal, D., Manchester, R. N., Trümper, J., Halpern, J. P., & Becker, W. *X-Radiation from the Millisecond Pulsar J0437-4715.* ApJ, 569:894–902, April 2002.
- Zhang, B., Harding, A. K., & Muslimov, A. G. *Radio Pulsar Death Line Revisited: Is PSR J2144-3933 Anomalous?* ApJ, 531:L135–L138, March 2000.
- Zharikov, S. V., Shibanov, Y. A., Mennickent, R. E., Komarova, V. N., Koptsevich, A. B., & Tovmassian, G. H. *Multiband optical observations of the old PSR B0950+08.* A&A, 417:1017–1030, April 2004.

Publications linked to this thesis

1. **Deller, A. T.**, Bailes, M. & Tingay, S. J.
Implications of a VLBI distance to the double pulsar J0737–3039A/B
2009, Science (10.1126/science.1167969)
2. **Deller, A. T.**, Tingay, S. J., & Brisken, W. F.
Precision Southern Hemisphere pulsar VLBI astrometry: techniques and results for PSR J1559–4438
2009, ApJ, 690, 198
3. **Deller, A. T.**, Verbiest, J. P. W., Tingay, S. J., & Bailes, M.
Extremely high precision VLBI astrometry of PSR J0437–4715 and implications for theories of gravity
2008, ApJL, 685, L67
4. Tingay, S. J., Alef, W., Graham, D., & **Deller, A. T.**
Geodetic VLBI correlation in software I. Feasibility of using the DiFX software correlator for geodetic VLBI
2008, Journal of Geodesy, submitted
5. Johnston, S. et al.,
Science with the ASKAP: The Australian square-kilometre-array pathfinder
2008, Experimental Astronomy, 22, 151
6. Johnston, S. et al.,
Science with the Australian SKA Pathfinder
2007, PASA, 24, 124

7. Phillips, C. J., **Deller, A.**, Amy, S. W., Tingay, S. J., Tzioumis, A. K., Reynolds, J. E., Jauncey, D. L., Stevens, J., Ellingsen, S. P., Dickey, J., Fender, R. P., Tudose, V. & Nicolson, G. D.

Detection of compact radio emission from Circinus X-1 with the first Southern hemisphere e-VLBI experiment

2007, MNRAS, 380, L11

8. Norris, R. P., Tingay, S. J., Phillips, C. J., Middelberg, E., **Deller, A. T.** & Appleton, P. N.

Very long baseline interferometry detection of an Infrared-Faint Radio Source

2007, MNRAS, 378, 1434

9. **Deller, A. T.**; Tingay, S. J.; Bailes, M. & West, C.

DiFX: A Software Correlator for Very Long Baseline Interferometry Using Multi-processor Environments

2007, PASP, 119, 318

