

On coherence lengths of wave packets II : High energy neutrino

K. Ishikawa and Y. Tobita

October 29, 2018

Department of Physics, Faculty of Science,
Hokkaido University Sapporo 060-0810, Japan

Abstract

In this second paper of the series on the coherence of wave packets, we study neutrinos in high energy experiments where neutrinos are produced by decays of pions or muons which are described using wave packets. The space time position where one neutrino is produced is not fixed to one value but is extended in macroscopic area. Hence the amplitude is defined by a superposition of the amplitudes of different neutrino's production time in the macroscopic region and depends on the absolute value of the neutrino mass.

We analyze neutrino interference based on operator product expansion near the light cone and find a new universal term in the time dependent neutrino probability. This new term has an origin in higher order quantum effect in a similar manner as axial anomaly. Roles of Lorentz invariance and the operator product expansion in the light-cone region are clarified and a possibility of measuring the absolute value of neutrino mass from neutrino interference experiments is pointed out.

1 Introduction

One particle states in nature are described by wave packets in various situations. In this series of papers [1, 2, 3], we study physics and implications of wave packets. By using wave packets, space-time dependent amplitudes and probabilities that are impossible to obtain using standard scattering amplitudes are computed. The time dependent probability thus obtained is shown to give a valuable information on the absolute value of neutrino mass.

Neutrinos are particles that are very light and interact with matters very weakly. Their masses were found to be finite from recent flavour oscillation experiments [4, 5, 6, 7, 8, 9]. The neutrino oscillation experiments using neutrinos from the sun, accelerator, reactors, and atmosphere gave the values of differences of the mass squared. Their values are found to be [10]

$$\Delta m_{21}^2 = m_2^2 - m_1^2 = (0.8 \pm 0.03) \times 10^{-4} [\text{eV}^2/c^4] \quad (1)$$

$$|\Delta m_{32}^2| = |m_3^2 - m_2^2| = 0.19 \text{ to } 0.3 \times 10^{-2} [\text{eV}^2/c^4], \quad (2)$$

with certain uncertainties where m_i ($i = 1-3$) are mass values. The squared-mass differences are extremely small but the absolute values of masses are unknown. Tritium beta decays [11] have been used for determining the absolute value but the existing upper bound for the effective electron neutrino squared-mass is of order $2 (\text{eV}/c^2)^2$ and the mass is $0.2-2 \text{ eV}/c^2$ from cosmological observations [12]. Neutrino masses are far from other particle's masses and are important parameters of physics. Neutrino masses are not affected from standard model of electroweak gauge interactions and it is important to know precise values of neutrino masses.

Neutrinos interact with matter by weak interactions and event rates are very low and neutrino detection is hard. However using its weak interactions with matters, neutrinos can be used as new observational means once the detection method is established [13]. Using neutrinos, several astronomical objects such as sun, moon, and other stars inside of which can not be observed directly by ordinary means such as lights, electrons and protons, would be studied in a future [14]. For these applications, it is necessary to know precise properties of neutrinos. We study wave and particle properties of high energy neutrinos.

A double slit-like interference of a neutrino, which is totally different from the flavour oscillation, is a subject of the present work. Neutrinos are produced by weak decays of particles and propagate finite distance before it

is detected. The distance is not fixed but varies within certain range. So the wave at the detector is a superposition of the neutrino produced at different positions. We study the pion and muon decays and the neutrino detection probability in hadron collisions using wave packets. The scattering amplitude and probability are computed usually using plane waves but the finite time or finite distance behaviors are not known by the standard method and wave packets are suitable means to study these dependences.

When the particles involved in a reaction are wave packets of finite spatial extensions and the particle measurement is made by wave packet, the time and space dependent transition probability can be observed. By using wave packets, the amplitude and probability of the finite time interval are also calculated. The probability obtained by our calculation has an oscillating term in time interval, T , in addition to the normal T -linear term. The normal term is calculable also in the standard S -matrix in the momentum representation, but the anomalous T -oscillating term in the finite time is calculable only using wave packet. The wave packet formalism supplies the space-time dependent informations and we obtain the length dependent probability of finding neutrino. This dependence is generated since the position where the neutrinos are produced in the decay of hadrons is not fixed and extended to macroscopic area. The neutrino amplitude is a superposition of the amplitude of different time and position and shows the interference.

We combine pion dynamics with the weak interaction of the neutrino and find the time dependent amplitude and probability. This amplitude shows neutrino interferences of anomalous behavior that is sensitive to the neutrino mass. The probability oscillates with time in a scale that is much shorter than that of flavour oscillation. The wave length of this oscillation is determined by the energy and mass of neutrino and the interference experiments could be useful for finding the absolute value of the neutrino mass.

We have shown general features of wave packet scattering in [1] and of particle coherence in the previous paper I [2]¹. An important feature of the wave packet of the relativistic particle is that the phase factor of the wave function is determined by the mass and the energy in a relativistic invariant manner. For the neutrino of mass m_ν and energy E_ν the phase factor is expressed by using the differences of two positions $\Delta\vec{x} = \vec{x} - \vec{X}$ and of two times $\Delta t = t - T$, as $\exp(i\phi)$, where the phase ϕ is expressed as $\phi = m_\nu \sqrt{c^2 \Delta t^2 - \Delta x^2}$ and also is written as $\phi = \frac{m_\nu^2}{E_\nu} \times c \Delta t$, where (t, \vec{x}) are

¹The general arguments about the wave packet scattering are in [15, 16, 17].

time and space coordinates of the production point and (T, \vec{X}) are those of the detection point. Consequently the interference due to this phase is also determined by the energy and mass. For the neutrino of very small mass, of order 1 eV or less, this interference is in the large scale.

We investigate the physical problems that are connected with neutrino's wave packets and interferences in high energy regions. Particularly neutrinos from pion decay and muon decay are studied in this paper. Other low energy neutrino processes caused by solar neutrinos, reactor neutrinos, and others are studied in a next work.

This paper is organized in the following manner. In section 2, wave packet sizes of decaying particles are estimated. In section 3, we study neutrino production amplitude and probability in hadron collisions and in section 4 we study neutrinos from real pions decays and those of muon decay in section 5. Summary and prospects are given in section 6.

2 Wave packet sizes

When decaying particles are not exact plane waves but are the wave packets of finite coherence lengths, the produced particles have also these properties of coherence. We estimate coherence lengths of proton first and those of pion and muon next following the methods of our previous works [1] [2].

2.1 Pion wave packets

Pions are produced by the proton collisions with target nucleus. Hence the coherence property of pion is determined by the coherence property of proton and nucleus. The proton has a finite scattering probability with nucleus in the matter and has a finite coherence length and the target nucleus has a microscopic size of order 10^{-15} m and its position is fixed with the uncertainty of atomic distance in crystals. From these values coherence length of proton is determined and using the proton coherence length we estimate the pion coherence length.

2.1.1 Proton mean free path

As was shown in I [2], the coherence length of a particle in dense matter is determined by its mean free path. High energy particles in solid material

interact with atoms frequently and its mean free path is understood well. The mean free path is an average distance for one particle to move freely and maintains particle's coherence. A particle is expressed by one wave function in a finite distance defined by the mean free path. Beyond the mean free path, particles lose coherence and are expressed by a different wave function. Hence this particle state is different from the plane wave. The wave function which expresses this particle has a finite spatial size and finite momentum width.

The mean free path of the charged particle is determined by its scattering with atoms in matter by Coulomb interaction. The energy loss is also determined by the same cross section and is summarized well in particle data summary [10]. In order to estimate a mean free path of the proton of 1 GeV/ c , we use the proton energy loss rate for several metals such as Pb, Fe, and others as,

$$-\frac{dE}{dx} = 1 - 2 \text{ [MeVg}^{-1}\text{cm}^2\text{]}, \quad (3)$$

we have the mean free path of the 1 GeV/ c proton

$$L_{\text{proton}} = \frac{E}{\frac{dE}{dx} \times \rho} = \frac{1 \text{ [GeV]}}{(1 - 2) \times 10 \text{ [MeV g}^{-1}\text{cm}^2\text{g cm}^{-3}\text{]}} = 50 - 100 \text{ [cm]}. \quad (4)$$

At lower energy of 2 MeV/ c , the energy loss rate is about 10 MeVg⁻¹cm² and the mean free path is

$$L_{\text{proton}} = 10 \text{ [cm]}. \quad (5)$$

Actually proton which is accelerated and reaches high energy at the end has a size of wave packet after acceleration, L_{after} ,

$$L_{\text{after}} = L_{\text{before}} \times \frac{v_{\text{after}}}{v_{\text{before}}}, \quad (6)$$

where L_{before} is the size before the acceleration and v_{before} and v_{after} are the velocities before and after the acceleration. The velocity is bounded by the light velocity c , and the ratio for reaching from the above momenta to 10 GeV/ c is from about 1.2 at 1 GeV/ c to five at 0.2 GeV/ c . Hence the proton of 10 GeV/ c has the mean free path

$$L_{\text{proton}} \approx 40 - 100 \text{ [cm]}. \quad (7)$$

2.1.2 Pion mean free path

Pions are produced by a collision of the proton with target nucleus. Coherence lengths of pions which are produced in high energy proton collisions with target nucleus are obtained using the above initial proton coherence size and target size. In relativistic energy region, particles have light velocity. Hence in the pion production, the coherence length of the pion δx_f is given from that of the proton δx_i as,

$$\begin{aligned}\frac{\delta x_i}{v_i} &= \frac{\delta x_f}{v_f}, \\ \delta x_f &= \frac{v_f}{v_i} \delta x_i \approx \delta x_i.\end{aligned}\tag{8}$$

Consequently from Eq.(7), the pion's coherence length of the momentum 1 GeV/c or larger momentum is given by

$$L_{\text{pion}} \approx 40 - 100 \text{ [cm]}.\tag{9}$$

We use these values of Eq. (7) and Eq. (9) in latter sections.

2.2 Muon wave packet

The muon is produced from pion decay. By the decay of pion of finite coherence length, a finite coherence length of produced muon is determined.

2.2.1 Decay of pion

Coherence lengths of the muon is connected with that of the pion by the ratio of velocities,

$$\frac{\delta x_{\text{pion}}}{v_{\text{pion}}} = \frac{\delta x_{\text{muon}}}{v_{\text{muon}}},\tag{10}$$

and is expressed as

$$\delta x_{\text{muon}} = \frac{v_{\text{muon}}}{v_{\text{pion}}} \times \delta x_{\text{pion}}.\tag{11}$$

For the relativistic particles the velocities are light velocity and the velocity ratio is unity.

Since the initial pion has an extension of momentum Δp_{pion} the final muon has also an extension of momentum Δp_{muon} ,

$$\Delta p_{\text{muon}} = \Delta p_{\text{pion}} + O\left(\frac{\hbar}{\delta x_i}\right). \quad (12)$$

2.2.2 Muon coherence length

Combining Eq. (9) and Eq. (11), the coherence length of muon is given by

$$L_{\text{muon}} \approx 40 - 100 \text{ [cm]}. \quad (13)$$

2.3 Neutrino wave packet

The size of wave packet for observed neutrino is determined by the object that neutrino interacts in detectors. Neutrinos interact with nucleus or with electrons in atoms. The nucleus have sizes of order 10^{-15} m and the electron's wave functions have sizes of order 10^{-10} m. We study the neutrinos described by the wave packets of these sizes in many particle processes. In this respect, the neutrino wave packet of the present work is different from some previous works of wave packets that are connected with flavour neutrino oscillations [18, 19, 20, 21, 22, 23, 24], where one particle properties of neutrino at production are studied. It is important to study the neutrino wave packet at the detector to study the interference.

The muon neutrino interactions in detectors are

$$\nu_{\mu} + e^{-} \rightarrow e^{-} + \nu_{\mu} \quad (14)$$

$$\nu_{\mu} + e^{-} \rightarrow \mu^{-} + \nu_e \quad (15)$$

$$\nu_{\mu} + A \rightarrow \mu^{-} + (A + 1) + X \quad (16)$$

$$\nu_{\mu} + A \rightarrow \nu_{\mu} + A + X \quad (17)$$

The neutrino wave packet σ_{ν} in processes (14) and (15) is of order 10^{-10} m and the neutrino wave packet σ_{ν} in processes (16) and (17) is of order 10^{-15} m. In the following sections are discussed the neutrinos in short or intermediate baseline experiments. We will see that the neutrino production amplitudes are unchanged even though the smaller wave packet, 10^{-15} , is used. The reason why the result is unchanged even with such a small wave packet is that the neutrino is so light that its velocity v_{ν} is almost the light velocity. Consequently, the two space time positions of the neutrino are almost on the

light cone where the dominant contribution in the amplitude comes from, as it will be discussed in the next section. In fact the neutrino of energy $1 \text{ GeV}/c^2$ and the mass $1 \text{ eV}/c^2$ has a velocity

$$\begin{aligned} v/c &= 1 - 2\epsilon & (18) \\ \epsilon &= \left(\frac{m_\nu c^2}{E_\nu}\right)^2 = 5 \times 10^{-19}, \end{aligned}$$

hence the neutrino propagates a distance

$$l = l_0(1 - \epsilon) = l_0 - \delta l, \delta l = l_0 \times \delta, \quad (19)$$

when light propagates the distance l_0 . This difference of distance, δl becomes

$$\delta l = 5 \times 10^{-17} \text{ [m]}; l_0 = 100 \text{ [m]} \quad (20)$$

$$\delta l = 5 \times 10^{-16} \text{ [m]}; l_0 = 1000 \text{ [m]}, \quad (21)$$

which are much smaller than the sizes of the above wave packets Eqs. (9) and (13). Hence, the neutrino amplitude at the nuclear target or the atom target should show interference. The geometry of the neutrino interference is shown in Fig. 1

The electron neutrino interactions in detectors are

$$\nu_e + e^- \rightarrow e^- + \nu_e \quad (22)$$

$$\nu_e + A \rightarrow e^- + (A + 1) + X \quad (23)$$

$$\nu_e + A \rightarrow e + A + X. \quad (24)$$

The neutrino wave packet σ_ν in processes (22) is of order 10^{-10} m and the neutrino wave packet σ_ν in processes (23) and (24) is of order 10^{-15} m . They are treated in the same way as the neutrino from the pion decay.

Low energy neutrinos of order MeV from the sun or reactors must be treated separately and will be studied in a next paper.

3 Neutrinos in hadronic collisions

Applying the wave packet formalism, we obtain the space-time dependent neutrino amplitude. From this amplitude we study the transition probability at finite time interval.

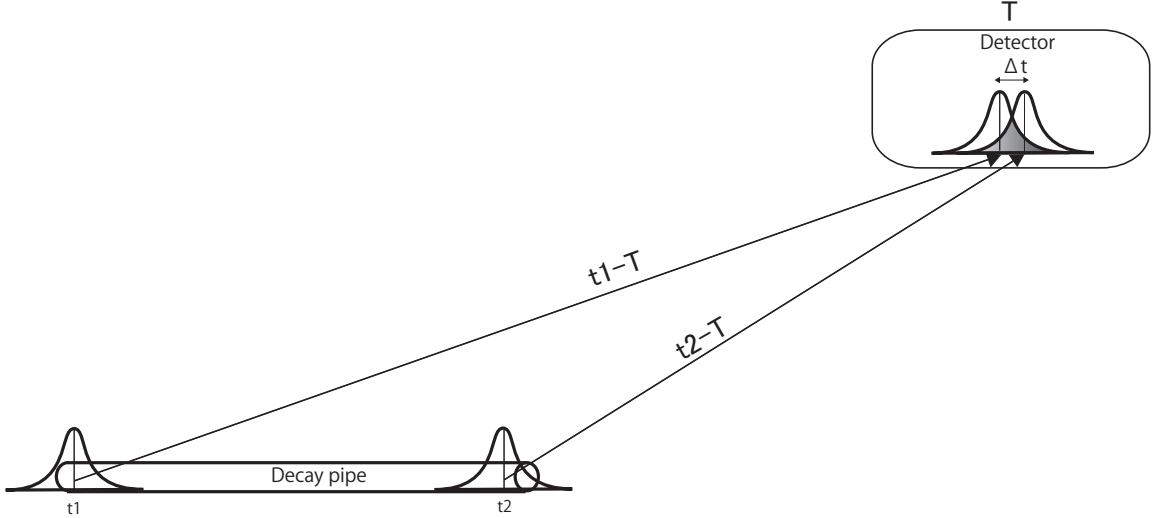

Fig. 1: The geometry of the neutrino interference experiment. The neutrino is observed by the detector at T and produced at t_1 or t_2 .

3.1 Semileptonic weak Hamiltonian and decay amplitude

Semileptonic decay of pion is described by the weak Hamiltonian

$$H_w = g \int d\vec{x} \partial_\mu \phi(x) J_{V-A}^\mu(x) = -igm_\mu \int d\vec{x} \phi(x) J_5(x) \quad (25)$$

$$J_{V-A}^\mu(x) = \bar{\mu}(x) \gamma^\mu (1 - \gamma_5) \nu(x), \quad J_5(x) = \bar{\mu}(x) (1 - \gamma_5) \nu(x), \quad (26)$$

where $\phi(x)$, $\mu(x)$, and $\nu(x)$ are the pion field, muon field, and neutrino field without any ambiguity. In the above equations, g is the coupling strength, $\pi(x)$, $J_{V-A}^\mu(x)$, and $J_5(x)$ are the pion field, leptonic charged vector current, and leptonic pseudoscalar.

3.2 Neutrino production amplitude in hadronic collisions

Neutrino production amplitude from an initial state $|\alpha_i\rangle$ to an final state $|\beta_f\rangle$ which includes the lepton pair is given by

$$T = \int d^4x \langle \beta_f | H_w(x) | \alpha_i \rangle. \quad (27)$$

When the muon is chosen as a plane wave and other states are wave packets specified by central values of momenta, coordinates, and times,

$$|\alpha_i\rangle = |\vec{p}_{\text{proton}}; \text{Nucleus}\rangle \quad (28)$$

$$|\beta_f\rangle = |\mu, \vec{k}; \nu, \vec{k}_\nu, \vec{X}_\nu, T_\nu; \vec{p}_\pi, \vec{X}_\pi, T_\pi, \text{hadrons}\rangle. \quad (29)$$

Expressions of particle states of the pion which ignores the life time and of the neutrino and muon are expressed by one particle's matrix elements

$$\langle 0 | \phi(x) | \vec{p}_{\text{pion}}, \vec{X}_{\text{pion}}, T_{\text{pion}} \rangle \quad (30)$$

$$\begin{aligned} &= N_\pi \int d\vec{p}_\pi e^{-\frac{\sigma_\pi}{2}(\vec{p}_\pi - \vec{p}_{\text{pion}})^2} e^{-iE(\vec{p}_\pi)(t - T_{\text{pion}}) + i\vec{p}_\pi \cdot (\vec{x} - \vec{X}_{\text{pion}})} \\ &\approx N_\pi e^{-\frac{1}{2\sigma_\pi}(\vec{x} - \vec{X}_\pi - \vec{v}_\pi(t - T_\pi))^2} e^{-iE(\vec{p}_{\text{pion}})(t - T_{\text{pion}}) + i\vec{p}_{\text{pion}} \cdot (\vec{x} - \vec{X}_{\text{pion}})}, \\ &\langle \mu, \vec{k}; \nu, \vec{k}_\nu, \vec{X}_\nu, T_\nu | \bar{\mu}(x) \gamma_5 \nu(x) | 0 \rangle \quad (31) \\ &= \frac{N_\nu}{(2\pi)^{\frac{3}{2}}} \int d\vec{p}_\nu e^{-\frac{\sigma_\nu}{2}(\vec{p}_\nu - \vec{k}_\nu)^2} \left(\frac{m_\mu}{E(\vec{p}_\mu)} \right)^{1/2} \left(\frac{m_\nu}{E(\vec{p}_\nu)} \right)^{1/2} \bar{u}(\vec{p}_\mu) \gamma_5 \nu(\vec{p}_\nu) \\ &\times e^{i(E(\vec{p}_\mu)t - \vec{p}_\mu \cdot \vec{x})} e^{i(E(\vec{p}_\nu)(t - T_\nu) - \vec{p}_\nu \cdot (\vec{x} - \vec{X}_\nu))}, \\ &N_\pi = \left(\frac{\sigma_\pi}{\pi} \right)^{\frac{3}{4}}, \quad N_\nu = \left(\frac{\sigma_\nu}{\pi} \right)^{\frac{3}{4}}, \end{aligned}$$

where the spinor's normalization is

$$\sum_s (u(p, s) \bar{u}(p, s)) = \frac{\gamma p + m}{2m}. \quad (32)$$

In the above equations, (30) and (31), σ_π, σ_ν are sizes of the pion wave packet of the initial state and of the neutrino wave packet of the final state. To get the final expression of Eq. (30), the pion momentum \vec{p} is integrated and is replaced by the central value \vec{p}_{pion} . The pion wave packet was estimated in the previous section and the neutrino wave packet size is determined by the experimental apparatus. A neutrino interacts with a nucleus in the detector and the collision with nucleus occurs incoherently. Hence the wave packet size of the neutrino should be the nuclear size that is the unit of detector. To study neutrino interferences, we use the nuclear size for σ_ν .

The amplitude T for one pion to decay to the neutrino and muon is

written as,

$$\begin{aligned}
T &= igm_\mu N' \int dt d\vec{x} d\vec{p}_\nu \langle \beta_f | \phi(x) | \alpha_i \rangle \left(\frac{m_\nu}{E(\vec{p}_\nu)} \right)^{\frac{1}{2}} \\
&\quad \times e^{i(E(\vec{p}_\mu)t - \vec{p}_\mu \cdot \vec{x})} \bar{u}(\vec{p}_\mu) \gamma_5 \nu(\vec{p}_\nu) e^{i(E(\vec{p}_\nu)(t - T_\nu) - \vec{p}_\nu \cdot (\vec{x} - \vec{X}_\nu)) - \frac{\sigma_\nu}{2}(\vec{p}_\nu - \vec{k}_\nu)^2}, \\
N' &= \frac{N_\nu}{(2\pi)^{\frac{3}{2}}} \left(\frac{m_\mu}{E(\vec{p}_\mu)} \right)^{\frac{1}{2}}, \\
\langle \beta_f | \phi(x) | \alpha_i \rangle &= \left(\frac{4\pi}{\sigma_\pi} \right)^{\frac{3}{4}} e^{-i(E(\vec{p}_{\text{pion}})(t - T_\pi) - \vec{p}_{\text{pion}} \cdot (\vec{x} - \vec{X}_\pi))} \\
&\quad \times e^{-\frac{1}{2\sigma_\pi}(\vec{x} - \vec{X}_\pi - \vec{v}_\pi(t - T_\pi))^2} T_{\beta'_f, \alpha_i}.
\end{aligned} \tag{33}$$

In Eq. (33), (t, \vec{x}) is the space-time coordinates where interaction takes place and the state β'_f is the hadron state in which one pion is taken away from the state β_f . From the dependence of the phase factor on the momenta of the muon, neutrino, and pion, by using integration by part it is shown that the average value of the energy and momentum is conserved. The integration of the momenta multiplied by the integrand of Eq. (33) satisfies

$$\langle p_{\text{pion}} \rangle = \langle p_\mu + p_\nu \rangle \tag{35}$$

$$\langle p_{\text{pion}}^2 \rangle = \langle (p_\mu + p_\nu)^2 \rangle. \tag{36}$$

We use these relations later.

Due to the coordinate dependence of the wave packets, the amplitude Eq. (33) depends on the space time coordinates. Furthermore, the integrand of Eq. (33) depends upon the space-time coordinate of the weak interaction where the neutrino is produced and is given as

$$T(t, \vec{x}) = igm_\mu N'' \int d\vec{p}_\nu \langle \beta_f | \phi(x) | \alpha_i \rangle \times e^{i(E(\vec{p}_\mu)t - \vec{p}_\mu \cdot \vec{x})} \tag{37}$$

$$\bar{u}(\vec{p}_\mu) \gamma_5 \nu(\vec{p}_\nu) e^{i(E(\vec{p}_\nu)(t - T_\nu) - \vec{p}_\nu \cdot (\vec{x} - \vec{X}_\nu)) - \frac{\sigma_\nu}{2}(\vec{p}_\nu - \vec{k}_\nu)^2}, \tag{38}$$

with a suitable normalization constant N'' . This amplitude depends upon the coordinates (t, \vec{x}) explicitly and is not invariant under the translation. So this satisfies peculiar properties of translational non-invariant amplitude and the states of wide momentum region play the role. Even the infinite momentum states couple with $\phi(x)$ and appears in β_f and gives important

contribution to the probability at two different positions at finite times. This is quite different from the ordinary scattering amplitude where the infinite momentum state decouples from the final state due to the energy momentum conservation. We will study this point in detail later.

3.3 Integration of neutrino momentum

We compute the neutrino momentum integral of Eq. (33) in two methods. Gaussian integral is applied in the first one and stationary phase approximation is applied in the second one. The former method is valid in small time interval and the latter one is valid in large time interval. In both methods, we obtain qualitatively same results. Especially the phase of neutrino wave function has a particular form that is proportional to the square of the mass and inversely proportional to the neutrino energy.

3.3.1 Gaussian integral

For not so large $t - T_\nu$, the neutrino momentum \vec{p}_ν integration of Eq. (33) is made by Gaussian integral around the central momentum \vec{k}_ν . The amplitude becomes then,

$$T = igm_\mu \tilde{N} \int dt d\vec{x} \langle \beta_f | \phi(x) | \alpha_i \rangle e^{i(E(\vec{p}_\mu)t - \vec{p}_\mu \cdot \vec{x})} \bar{u}(\vec{p}_\mu) \gamma_5 \nu(\vec{k}_\nu) e^{i\phi} \\ \times \left(\frac{m_\nu}{E(\vec{k}_\nu)} \right)^{1/2} e^{-\frac{1}{2\sigma_\nu} (\vec{x} - \vec{X}_\nu - \vec{v}_\nu(t - T_\nu))^2}, \quad (39)$$

where \tilde{N} is the normalization factor, v_ν^i is the i -th component of the neutrino velocity, and ϕ is the phase of neutrino wave function. They are given by

$$\tilde{N} = \left(\frac{1}{2\pi} \right)^{\frac{3}{2}} \left(\frac{4\pi}{\sigma_\nu} \right)^{\frac{3}{4}} \left(\frac{m_\mu}{E(\vec{p}_\mu)} \right)^{1/2} \quad (40)$$

$$v_\nu^i = \frac{k_\nu^i}{E_\nu(\vec{k}_\nu)}, \quad \phi = E(\vec{k}_\nu)(t - T_\nu) - \vec{k}_\nu \cdot (\vec{x} - \vec{X}_\nu). \quad (41)$$

The phase factor of the neutrino wave function, ϕ , is rewritten by substituting the central value \vec{x} of neutrino's Gaussian function

$$\vec{x} = \vec{X}_\nu + \vec{v}_\nu(t - T_\nu). \quad (42)$$

We have the phase

$$\begin{aligned}
\phi &= E(\vec{k}_\nu)(t - T_\nu) - \vec{k}_\nu \cdot (\vec{x} - \vec{X}_\nu) \\
&= E(\vec{k}_\nu)(t - T_\nu) - \vec{k}_\nu \cdot \vec{v}_\nu(t - T_\nu) \\
&= \frac{E_\nu^2(\vec{k}_\nu) - \vec{k}_\nu^2}{E_\nu(\vec{k}_\nu)}(t - T_\nu) = \frac{m_\nu^2}{E_\nu(\vec{k}_\nu)}(t - T_\nu),
\end{aligned} \tag{43}$$

which has a typical form of the relativistic particle. The phase becomes proportional to the neutrino mass squared and inversely proportional to the neutrino energy.

3.3.2 stationary phase approximation

Integration on the neutrino momentum \vec{p}_ν in the amplitude at macroscopic time difference $t - T_\nu$ is made by stationary phase method. The stationary momentum is obtained from the stationary condition,

$$\frac{\partial}{\partial p_\nu^i} \phi(\vec{p}_\nu) = 0. \tag{44}$$

The equation for the stationary phase Eq. (44) is written as,

$$\left. \frac{p_\nu^i}{E(p_\nu)} \right|_{\vec{p}_\nu = \vec{p}_\nu^{(0)}} (t - T_\nu) - (x - X)^i = 0. \tag{45}$$

The square of the above equation leads

$$\left. \frac{\vec{p}_\nu^2}{E^2(p_\nu)} \right|_{\vec{p}_\nu = \vec{p}_\nu^{(0)}} (t - T_\nu)^2 - (\vec{x} - \vec{X})^2 = 0 \tag{46}$$

$$1 + \left. \frac{m^2}{\vec{p}_\nu^2} \right|_{\vec{p}_\nu = \vec{p}_\nu^{(0)}} = \frac{(t - T_\nu)^2}{(\vec{x} - \vec{X})^2}. \tag{47}$$

Hence the phase factor at the stationary point is given by,

$$\begin{aligned}
\phi(\vec{p}_\nu^0) \Big|_{\vec{p}_\nu = \vec{p}_\nu^{(0)}} &= m \left((t - T_\nu)^2 - (\vec{x} - \vec{X}_\nu)^2 \right)^{1/2} \\
&= \left. \frac{m^2}{E_\nu(\vec{p}_\nu)} \right|_{\vec{p}_\nu = \vec{p}_\nu^{(0)}} (t - T_\nu).
\end{aligned} \tag{48}$$

This phase agrees to Eq. (43) obtained by the Gaussian integral method.

Hereafter we use \vec{p}_ν instead $\vec{p}_\nu^{(0)}$ and we understand that the \vec{p}_μ in the following equations stands for $\vec{p}_\nu^{(0)}$ which is a function of time and space coordinate. The decay amplitude becomes

$$T = igm_\mu \tilde{N} \int dt d\vec{x} \langle \beta_f | \phi(x) | \alpha_i \rangle e^{i(E(\vec{p}_\mu)t - \vec{p}_\mu \cdot \vec{x})} \bar{u}(\vec{p}_\mu) \gamma_5 \nu(\vec{p}_\nu) \\ \times \left(\frac{m_\nu}{E(\vec{k}_\nu)} \right)^{1/2} e^{i \frac{m_\nu^2}{E_\nu} (t - T_\nu) - \frac{\sigma_\nu}{2} (\vec{p}_\nu - \vec{k}_\nu)^2}, \quad (49)$$

$$\tilde{N} = \frac{1}{(2\pi)^{\frac{3}{2}}} \left(\frac{4\pi}{\sigma_\nu} \right)^{\frac{3}{4}} \left(\frac{m_\mu}{E(\vec{p}_\mu)} \right)^{1/2}. \quad (50)$$

When the space time coordinates (x_0, \vec{x}) are integrated, the delta function of the energy and momentum conservation appears. The scattering amplitude with this delta function has final states that have the same energy and momentum with the initial states. On the other hand, the space and time dependent amplitude $T(t, \vec{x})$ is not invariant under the translation and has no delta function. So the energy and momentum of the final state is not necessary the same as the initial state. The states which do not satisfy the total energy and momentum conservation should be included to get consistent results from the completeness. This scattering amplitude shows the space and time dependent behavior, which is a new information. So by interchanging the order of the integration, we are able to obtain the probability and other informations at the finite time interval.

3.4 Decay probability and interference

We find the probability of observing neutrino at certain finite distance. Due to the finite distance effect or finite time interval effect, the probability at the finite time interval is not invariant under the translation. So special care is needed due to the non-standard nature of the non-invariant probability. The integration over the momentum should be made with special care for the translational non-invariant probability. The infinite momentum states should be included from the completeness of the physical space unless energy momentum conservation restrict. We will see that the state of infinite momentum actually contribute in a manner that is almost equivalent to virtual state. These pseudo-virtual states of the infinite momentum are actually important for the probability of finite time to get the consistent result. We

compute the probability with two different methods which are applied in previous subsection.

3.4.1 Gaussian integral

Transition probability is a square of the above amplitude and is given by

$$\begin{aligned}
|T|^2 &= g^2 m_\mu^2 \left(\frac{4\pi}{\sigma_\pi} \right)^{\frac{3}{2}} |\tilde{N}|^2 \int d^4 x_1 d^4 x_2 \left| T_{\beta'_f, \alpha_i} \right|^2 S_5(s_1, s_2) \frac{m_\nu}{E(\vec{k}_\nu)} \\
&\times e^{i \frac{m_\nu^2}{E_\nu} (t^1 - T_\nu)} e^{-i \frac{m_\nu^2}{E_\nu} (t^2 - T_\nu)} e^{-\frac{1}{2\sigma_\nu} (\vec{x}^1 - \vec{X}_\nu - \vec{v}_\nu (t^1 - T_\nu))^2} e^{-\frac{1}{2\sigma_\nu} (\vec{x}^2 - \vec{X}_\nu - \vec{v}_\nu (t^2 - T_\nu))^2} \\
&\times e^{-i(E(\vec{p}_{\text{pion}})(t^1 - T_\pi) - \vec{p}_{\text{pion}} \cdot (\vec{x}^1 - \vec{X}_\pi))} \times e^{i(E(\vec{p}_{\text{pion}})(t^2 - T_\pi) - \vec{p}_{\text{pion}} \cdot (\vec{x}^2 - \vec{X}_\pi))} \\
&\times e^{i(E(\vec{p}_\mu)t^1 - \vec{p}_\mu \cdot \vec{x}^1)} \times e^{-i(E(\vec{p}_\mu)t^2 - \vec{p}_\mu \cdot \vec{x}^2)} \\
&\times e^{-\frac{1}{2\sigma_\pi} (\vec{x}^1 - \vec{X}_\pi - \vec{v}_\pi (t^1 - T_\pi))^2} e^{-\frac{1}{2\sigma_\pi} (\vec{x}^2 - \vec{X}_\pi - \vec{v}_\pi (t^2 - T_\pi))^2}, \tag{51}
\end{aligned}$$

where $S_5(s_1, s_2)$ stands for the products of Dirac spinors and their complex conjugates,

$$S_5(s_1, s_2) = (\bar{u}(\vec{p}_\mu)(1 - \gamma_5)\nu(\vec{p}_\nu)) (\bar{u}(\vec{p}_\mu)(1 - \gamma_5)\nu(\vec{p}_\nu))^*, \tag{52}$$

and its spin summation is

$$\begin{aligned}
S^5 &= \sum_{s_1, s_2} S^5(s_1, s_2) \\
&= \frac{1}{m_\nu m_\mu} 2(p_\mu \cdot p_\nu). \tag{53}
\end{aligned}$$

We use the relation Eq. (36) and write S_5 as

$$S^5 = \frac{1}{m_\nu m_\mu} (m_{\text{pion}}^2 - m_\mu^2). \tag{54}$$

3.4.2 Muon momentum integration

When the muon in the final state is not observed, the muon momentum, \vec{p}_μ , is integrated. Since integral on coordinates (t, \vec{x}) is made later, the energy-momentum conservation does not hold for (t, \vec{x}) dependent quantity. Hence the integration region of \vec{p}_μ is whole momentum region from the completeness of the state. The muon of the infinite momentum is produced as a real state

but the time dependent amplitude should include this momentum region. Otherwise Lorentz invariance does not hold and meaningful result is not obtained.

Let the following function be Δ_μ

$$\Delta_\mu(\delta t, \delta \vec{x}) = \frac{1}{(2\pi)^3} \int_{-\infty}^{\infty} \frac{d\vec{p}_\mu}{E(\vec{p}_\mu)} e^{i(E(\vec{p}_\mu)\delta t - \vec{p}_\mu \cdot \delta \vec{x})} \quad (55)$$

$$\delta t = t^1 - t^2, \delta \vec{x} = \vec{x}^1 - \vec{x}^2,$$

where time and space coordinates are fixed and so the four dimensional momentum p_μ is not restricted from the energy momentum conservation. The integration region includes the infinite momentum where the velocity becomes the light velocity. Consequently this function has a singular function near the light cone as

$$\Delta_\mu(\delta t, \delta \vec{x}) = \frac{1}{4\pi} \delta(\lambda) \epsilon(\delta t) - i \frac{m_\mu}{8\pi\sqrt{\lambda}} \theta(\lambda) \left[N_1(m_\mu\sqrt{\lambda}) - i\epsilon(\delta t) J_1(m_\mu\sqrt{\lambda}) \right] + i\theta(-\lambda) \frac{m_\mu}{4\pi^2\sqrt{-\lambda}} K_1(m_\mu\sqrt{-\lambda}) \quad (56)$$

$$\lambda = (\delta t)^2 - (\delta \vec{x})^2, \quad (57)$$

$$\epsilon(\delta t) = \theta(\delta t) - \theta(-\delta t) = \begin{cases} +1 & \text{for } \delta t > 0 \\ -1 & \text{for } \delta t < 0 \end{cases} \quad (58)$$

and gives the most important contribution to certain probability. We investigate the effects of this most singular term later, which becomes most important in high energy limit and in loop amplitudes where the infinite momentum states give finite contribution. Actually Δ_μ has several less singular terms and oscillating terms. These terms are not important and we ignore in the present work.

The probability for not so large $t - T_\nu$ is computed from the amplitude

Eq. (33) and is given by

$$\begin{aligned}
& \int d\vec{p}_{\text{muon}} \sum_{s_1, s_2} |T|^2 \tag{59} \\
&= g^2 m_\mu^2 |N_{\pi\nu}|^2 \int d^4 x_1 d^4 x_2 |T_{\beta_f, \alpha_i}|^2 \frac{1}{E_\nu} e^{-\frac{1}{2\sigma_\nu} (\vec{x}^1 - \vec{X}_\nu - \vec{v}_0 (t^1 - T_\nu))^2} e^{-\frac{1}{2\sigma_\nu} (\vec{x}^2 - \vec{X}_\nu - \vec{v}_0 (t^2 - T_\nu))^2} \\
&\quad \times \Delta_\mu(\delta t, \delta \vec{x}) e^{i \frac{m_\nu^2}{E_\nu} \delta t} e^{-i(E(\vec{p}_{\text{pion}})\delta t - \vec{p}_{\text{pion}} \cdot \delta \vec{x})} \times e^{-\frac{1}{2\sigma_\pi} (\vec{x}^1 - \vec{X}_\pi - \vec{v}_\pi (t^1 - T_\pi))^2} \\
&\quad \times e^{-\frac{1}{2\sigma_\pi} (\vec{x}^2 - \vec{X}_\pi - \vec{v}_\pi (t^2 - T_\pi))^2} \\
& N_{\pi\nu} = \left(\frac{4\pi}{\sigma_\pi}\right)^{\frac{3}{4}} \left(\frac{4\pi}{\sigma_\nu}\right)^{\frac{3}{4}}, \quad \delta t = t_1 - t_2, \quad \delta \vec{x} = \vec{x}_1 - \vec{x}_2. \tag{60}
\end{aligned}$$

3.4.3 Integration of the interaction position

Next we integrate the coordinates \vec{x}_1 and \vec{x}_2 . Integration on coordinates \vec{x}_1 and \vec{x}_2 are made by the Gaussian integral on the neutrino wave packet and the $\Delta_\mu(\delta t, \delta \vec{x})$,

$$I_0 = \int d\vec{x}_1 d\vec{x}_2 e^{-\frac{1}{2\sigma_\nu} (\vec{x}^1 - \vec{X}_\nu - \vec{v}_0 (t^1 - T_\nu))^2} e^{-\frac{1}{2\sigma_\nu} (\vec{x}^2 - \vec{X}_\nu - \vec{v}_0 (t^2 - T_\nu))^2} \Delta_\mu(\delta t, \delta \vec{x}). \tag{61}$$

By changing the variables \vec{x}_1 and \vec{x}_2 to $\vec{X} = \frac{\vec{x}_1 + \vec{x}_2}{2}$, $\vec{x} = \frac{\vec{x}_1 - \vec{x}_2}{2}$, the above integration is made easily, and we have

$$I_0 = \frac{2\pi\sigma_\nu}{4\pi|t_1 - t_2|} \epsilon(t_1 - t_2). \tag{62}$$

Finally the total probability is written as

$$\begin{aligned}
& \int d\vec{p}_{\text{muon}} \sum_{s_1, s_2} |T|^2 \tag{63} \\
&= g^2 m_\mu^2 |N_{\pi\nu}|^2 \int dt_1 dt_2 \frac{1}{E_\nu} \frac{\sigma_\nu}{2} e^{-i(E(\vec{p}_{\text{pion}})\delta t - \vec{p}_{\text{pion}} \cdot \delta \vec{x})} \times \frac{e^{i \frac{m_\nu^2}{E_\nu} (t_1 - t_2)}}{|t_1 - t_2|} \epsilon(t_1 - t_2) \\
&\quad \times e^{-\frac{1}{2\sigma_\pi} (\vec{X}_\nu - \vec{X}_\pi + (\vec{v}_\nu - \vec{v}_\pi)(t^1 - T_\nu) + \vec{v}_\pi(T_\pi - T_\nu))^2} e^{-\frac{1}{2\sigma_\pi} (\vec{X}_\nu - \vec{X}_\pi + (\vec{v}_\nu - \vec{v}_\pi)(t^2 - T_\nu) + \vec{v}_\pi(T_\pi - T_\nu))^2}.
\end{aligned}$$

From the pion coherence length obtained in the previous section, the pion Gaussian parts are regarded as

$$e^{-\frac{1}{2\sigma_\pi}(\vec{X}_\nu - \vec{X}_\pi + (\vec{v}_\nu - \vec{v}_\pi)(t^1 - T_\nu) + \vec{v}_\pi(T_\pi - T_\nu))^2} \approx 1 \quad (64)$$

$$e^{-\frac{1}{2\sigma_\pi}(\vec{X}_\nu - \vec{X}_\pi + (\vec{v}_\nu - \vec{v}_\pi)(t^2 - T_\nu) + \vec{v}_\pi(T_\pi - T_\nu))^2} \approx 1 \quad (65)$$

in a distance of our interest which is of order few 100 m. In a larger distance, this condition is not satisfied and the interference disappears then. This condition is that the neutrinos produced in the different decay area overlap each other. Other situations where this condition is not met, the interference pattern becomes different.

3.4.4 Pion momentum integration

It is convenient to classify the diagram for the fixed values of x_1 and x_2 of the Eq. (51) into two types. In the first one, the correlation function of two pions of coordinates x_1 and x_2 is composed of those of finite momenta of on mass shell and we write this as Fig. 2. In the second one, the pion correlation function is composed of those of infinite momentum and we write this as Fig. 3. Because the coordinates x_1 and x_2 are fixed, momentum and energy flows at these points can have arbitrary values in these amplitude, which is a peculiar property of position dependent amplitude. The infinite momentum flow from the x_1 to the hadron part make some states in the final state β to have infinite momentum. Hence the final state of the space-time dependent amplitude, i.e., amplitude of fixed coordinates x_1 and x_2 , should include the infinite momentum states from the completeness of the particle states. This infinite momentum states contribute only to (t, \vec{x}) dependent quantities and to the probability at the finite time. This states do not contribute to the standard scattering amplitude defined as the overlap between the states at $t = \pm\infty$. Hence this contribution is similar to higher order quantum effect or one-loop effect where virtual states of the infinite momentum give a finite contribution. We will see that this term gives the important contribution to the interference term at finite time. If the integration over the space time (t, \vec{x}) is made first as in the ordinary scattering amplitude, the probability has no dependence on the space and time and these states of infinite momentum decouple from the integrated total amplitude at the infinite time.

Pion in Fig. 2 is constrained by the initial states α and the final states β of the hadronic part and has the maximum momentum allowed from the

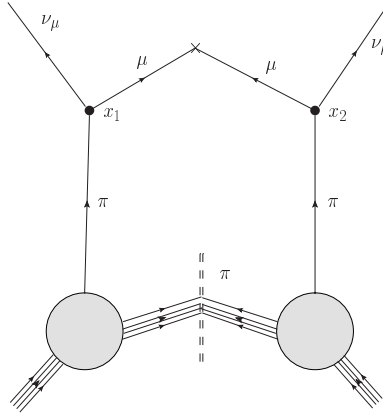

Fig. 2: Diagram of the normal term of transition probability for observing the neutrino produced at x_1 or x_2 . All hadrons have finite energy and momentum.

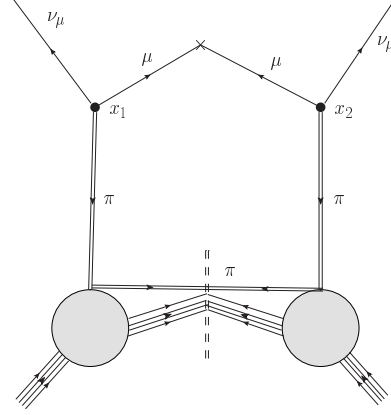

Fig. 3: Diagram of the anomalous term of transition probability for observing the neutrino produced at x_1 or x_2 . One pion along one line has the infinite energy and momentum.

energy and momentum conservation of the final state. The pion in Fig. 3, however, is not constrained and can have infinite momentum. Thus the two diagrams are different each others. However there is no way to separate directly two components using the observables. In stead of a direct separation of two components, the probability at the finite time is decomposed into two components, one is the T-linear term and another is T-oscillating term. Fig. 2 contributes to the the T-linear term and Fig. 3 contributes to the both terms. Consequently the T-oscillating term from Fig. 3 is uniquely computed from our formulation and we study this term. The pion momentum is taken in whole momentum region from the completeness of the states. The result gives a Lorentz invariant term of the variable $\lambda = (x_1 - x_2)^2$.

The pion correlation function of space time coordinates is obtained by integrating the pion momentum and has two terms,

$$\begin{aligned} \Delta_{\text{pion}}(\delta t, \delta \vec{x}) &= \langle \beta_f | \phi(x_1) | \alpha_i \rangle \langle \alpha_i | \phi(x_2)^\dagger | \beta_f \rangle \\ &= F_{\text{universal}}(\lambda) + F_{\text{nomral}}(\delta t, \delta \vec{x}), \end{aligned} \quad (66)$$

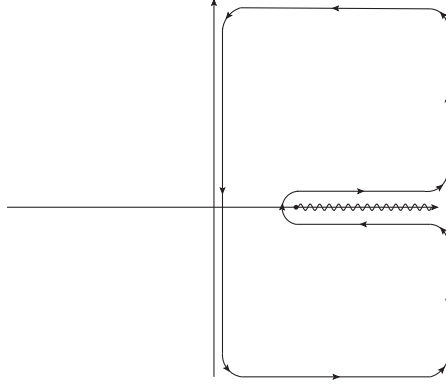

Fig. 4: The energy contour in the integration along the real axis is changed into that along the imaginary axis by Wick rotation.

where the non-invariant term is given by

$$F_{\text{normal}} = \sum_{\vec{p}_\pi} P(\vec{p}_\pi) e^{-i(E(\vec{p}_{\text{pion}})\delta t^1 - \vec{p}_{\text{pion}} \cdot \delta \vec{x}^1)}, \quad (67)$$

where the momentum in the above equation is that of the original pion momentum but not the momentum of the center of wave packet and is in the finite range allowed by the energy and momentum conservation. This correlation function is a function of the combination $\delta x_\mu P_{\text{initial}}^\mu$ and is not invariant under Lorentz transformation of δx only. The first one is manifestly invariant under Lorentz transformation of δx and a function of $\lambda = (\delta x)^2$.

First term in the right-hand side of Eq. (66) is due to Fig. 3 where the intermediate pion has the infinite momentum and the second term is due to Fig. 2 where the intermediate pion has finite momenta allowed from the energy and momentum conservation. We argue further on the $\Delta_{\text{pion}}(\delta t, \delta \vec{x})$ and $\Delta_{\text{muon}}(\delta t, \delta \vec{x})$ from operator product expansions [25] in Appendix B. Particularly the magnitude of $F_{\text{universal}}(\lambda)$ is estimated based on the Euclidean metric integration which is obtained by deforming integration path of the the intermediate energy along the real axis into the one along the imaginary axis by Wick rotation as in Fig. 4. The integrand has a cut along the real axis due to infrared divergence and the integral thus defined is Lorentz invariant and would be valid as a regularized value. We estimated the integral in the Euclidean metric and found a finite value. We use this value in this paper.

The non-invariant part comes from real pion decays where the pion momentum has an upper bound. The invariant part comes from interference

terms where the pion momentum reaches infinity. We see that the amplitude from the non-invariant term oscillates with time as

$$F_{\text{normal}}(\delta t, \delta \vec{x}) = f_{\text{normal}} e^{i\omega_\pi \delta t}, \quad (68)$$

of a frequency determined by the pion energy as

$$\omega_\pi = \frac{m_\pi^2}{E_\pi}. \quad (69)$$

This frequency is a magnitude of a microscopic angular velocity that is much larger than $\frac{m_\nu^2}{E_\nu}$.

The invariant term at $\lambda = 0$, $F_{\text{universal}}(0)$ gives a dominant contribution at the light cone region. Hence, we substitute

$$\Delta_{\text{pion}}(\delta t, \delta \vec{x}) = F_{\text{universal}}(0) + f_{\text{normal}} e^{i\omega_\pi \delta t}, \quad (70)$$

in the following calculations.

3.5 Probability

3.5.1 Interference term

Using the correlation function we have the final expression of the probability of observing neutrino at the time T or at the distance $L = cT$,

$$\begin{aligned} \int d\vec{p}_{\text{muon}} \sum_{s_1, s_2} |T|^2 &= N \int_0^T dt_1 dt_2 \frac{e^{i\frac{m_\nu^2}{E_\nu}(t_1 - t_2)}}{(t_1 - t_2)} (1 + f_{\text{normal}} e^{i\omega_\pi(t_1 - t_2)}) \quad (71) \\ &= \frac{\tilde{N}_{\text{prob}}}{E_\nu} [F_{\text{universal}}(0) \times g(T, \omega_\nu) + f_{\text{normal}} \times g(T, \omega_\pi + \omega_\nu)] \end{aligned}$$

$$\begin{aligned} \tilde{N}_{\text{prob}} &= (2\sqrt{2}\pi)^3 \sigma_\nu f_\mu, \quad f_\mu = g^2 m_\mu^2 (m_\pi^2 - m_\mu^2), \\ g(T, \omega) &= T \int_0^T dX \frac{\sin(\omega X)}{X} + \frac{1}{\omega} \{\cos(\omega T) - 1\}, \quad (72) \\ \omega_\nu &= \frac{m_\nu^2}{E_\nu}, \quad \omega_\pi = \frac{m_\pi^2}{E_\pi}, \quad L = cT, \end{aligned}$$

where L is the length of decay region. Eq. (71) depends on the neutrino wave packet size σ_ν and the pion multiplicity but the number of neutrino

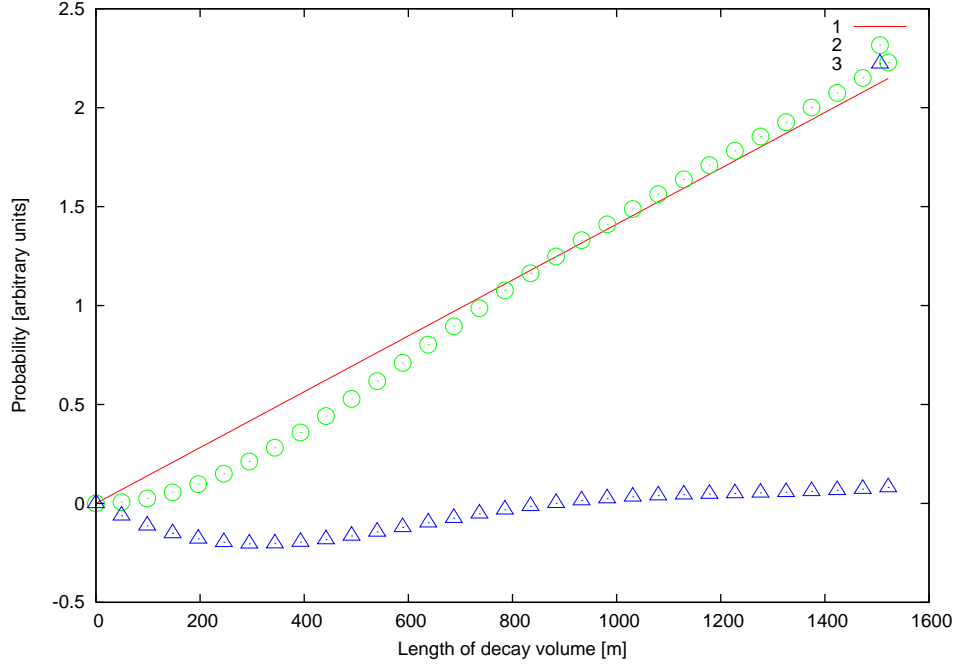

Fig. 5: The universal term of the neutrino probability at a finite distance is given by circles and those that subtracted the T-linear term shown by a solid line is given by triangles. The horizontal axis shows the distance in [m] and the probability is of arbitrary unit. The neutrino mass is $m_\nu = 1 \text{ eV}/c^2$.

events in the experiment is proportional to the initial energy, the neutrino reaction rate, the detector efficiency, and other parameters of the experiment in addition to Eq. (71). We combine them to one constant N_{exp} , then the event number of neutrinos at the distance L is proportional to

$$\frac{N_{\text{exp}}}{E_\nu} (F_{\text{universal}}(0) \times g(T, \omega_\nu) + f_{\text{normal}} \times g(T, \omega_\pi + \omega_\nu)). \quad (73)$$

Eq. (72) has a slowly oscillating term and rapidly oscillating term. The latter term oscillates so rapidly that in the ordinary experiments only its average is seen. Hence, this term is regarded as a linear function of T ,

$$f_{\text{normal}} \times g(T, \omega_\pi + \omega_\nu) = f_{\text{normal}} \times T. \quad (74)$$

and we have the probability

$$\int d\vec{p}_{\text{muon}} \sum_{s_1, s_2} |T|^2 = \frac{\tilde{N}_{\text{prob}}}{E_\nu} [F_{\text{universal}}(0) \times g(T, \omega_\nu) + f_{\text{normal}} \times T]. \quad (75)$$

The probability of observing the neutrino at the time T is plotted in Fig. 5 for $m_\nu = 1\text{eV}/c^2$. From this figure we see that it consists of the T -linear term and the small and slow oscillation term on top of the T -linear term. The T -linear term comes from the invariant term and also from the non-invariant term. So the relative magnitude of oscillation term is not definite but from the calculation presented in Appendix B, we expect that the magnitude of the universal term is about the same as the the non-universal term. Because the probability at the time T has a linear term and the universal slow oscillation term, the universal term is extracted by subtracting the T -linear term from the total probability. The slowly oscillating term thus obtained is given in Fig. 6. This shows the slow oscillation of showing small neutrino mass. Thus we find the final form of the probability which has the oscillating term with the frequency determined by the neutrino's mass and the energy and T -linear term which comes from the Lorentz non-invariant term in Eq. (66).

The slowly oscillating term is determined by the Lorentz invariant term in Eq. (66). A typical oscillation length L_0 is

$$L_0 [\text{m}] = \frac{E_\nu \hbar c}{m_\nu^2} = 200 \frac{E_\nu [\text{GeV}/c^2]}{m_\nu [\text{eV}/c^2]^2}. \quad (76)$$

This length is quite interesting value for the observational point. We use $m_\nu = 1\text{eV}/c^2$ throughout this paper.

The oscillating probability depends upon the energy E_ν and time T and its signature is observed also in the energy dependence of the probability at a fixed T . This total probability multiplied by the neutrino energy is plotted in Fig. 7 and the the probability obtained by subtracting the smooth background from the total probability is given in Fig. 8. The slow oscillation due to the universal term is seen clearly.

3.5.2 muon in pion decays

When the muon is observed in the same processes, the anomalous oscillation is determined by the muon mass and energy as $\frac{m_\mu^2}{E_\mu}$ and the muon mass is larger than the neutrino mass by 10^8 . Hence the oscillation length is smaller

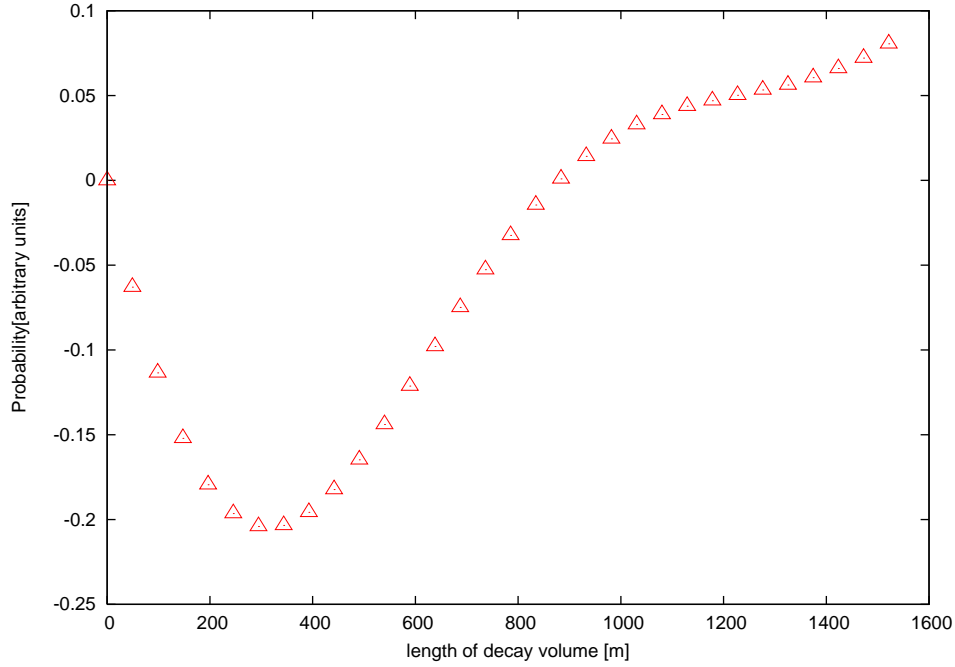

Fig. 6: After the T-linear term is subtracted, the probability shows clear oscillation. The horizontal axis shows the distance in [m] and the probability is of arbitrary unit. The neutrino mass is $m_\nu = 1 \text{ eV}/c^2$

than that of the neutrino by 10^{16} . For the muon of energy one GeV/c , the oscillation length is order 10^{-12} m. This value is too small to observe in experiments.

Since it is hard to see anomalous oscillation of this length, it is meaningful to study an average probability. The total muon flux includes the effect of the anomalous term and is written as

$$F_{\text{muon}} = F_{1n} + F_{1a} \quad (77)$$

$$F_{1n} = C \langle n_\pi \rangle \quad (78)$$

$$F_{1a} = C' \langle n_\pi \rangle, \quad (79)$$

where F_{1n} is due to naive decay of pions without interference effect and so is proportional to pion number, whereas F_{1a} is due to the interference term that gives the anomalous oscillation of the neutrino. Because we ignored the

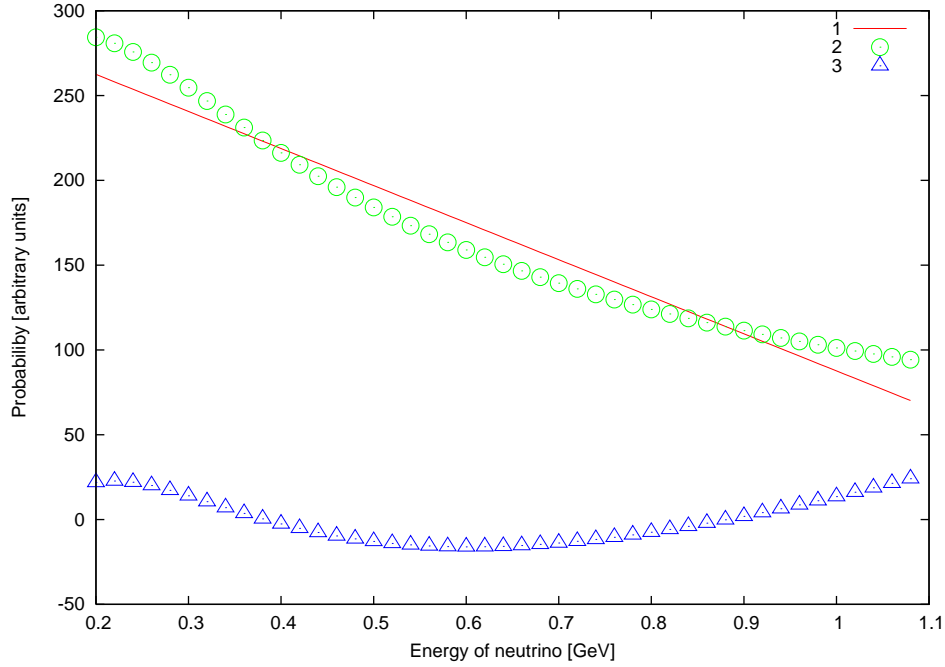

Fig. 7: The energy dependence of the neutrino probability is plotted. The probability at T is given by circles and those that subtracted the T-linear term shown by the solid line is given by triangles. The horizontal axis shows the neutrino energy in [GeV] and the vertical axis shows the neutrino probability in the arbitrary unit. The neutrino mass is $m_\nu = 1 \text{ eV}/c^2$. The distance is 200 m

non-singular term in Eq. (56), it is hard to know the magnitude of rapid oscillation term and the total flux. We expect that the F_{1a} has a same magnitude as F_{1n} from the calculation of Appendix B.

3.5.3 Stationary phase approximation

So far the calculation is based on the Gaussian integration on the neutrino momentum. The result is the same in another calculational method of using the stationary phase approximation.

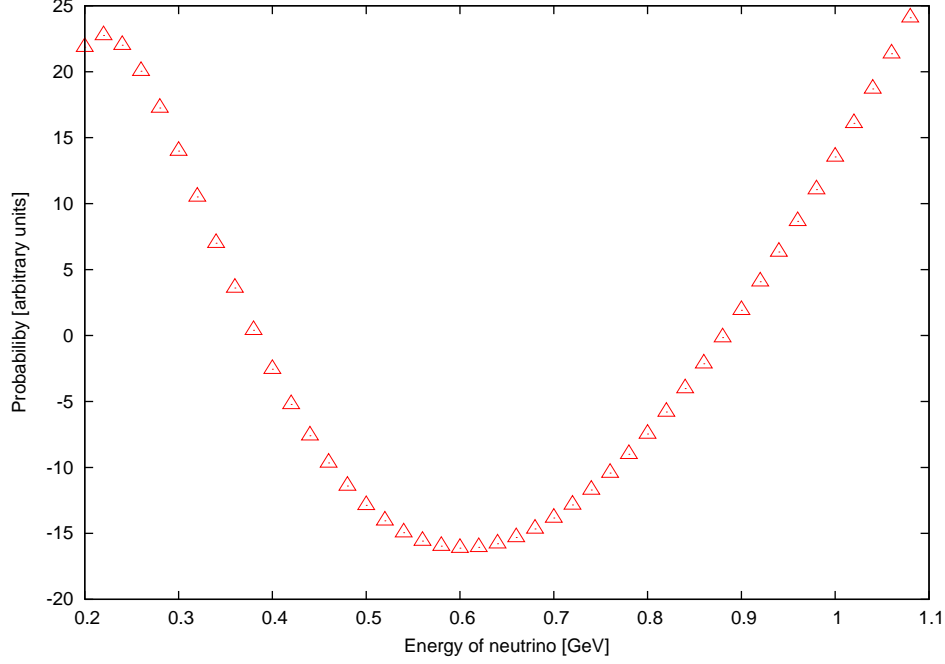

Fig. 8: The energy dependence of the oscillating neutrino probability that is subtracted the background term from the total probability is plotted. The horizontal axis shows the neutrino energy in [GeV] and the vertical axis shows the probability in the arbitrary unit. The neutrino mass is $m_\nu = 1 \text{ eV}/c^2$. The distance is 200 m

The transition probability is a square of the Eq. 49 and is given by

$$\begin{aligned}
|T|^2 &= \left(\frac{4\pi}{\sigma_\pi}\right)^{\frac{3}{2}} |\tilde{N}|^2 \int d^4x_1 d^4x_2 \left|T_{\beta_f', \alpha_i}\right|^2 S_5(s_1, s_2) \left(\frac{m_\nu}{E_\nu^1 E_\nu^2}\right)^{\frac{1}{2}} \\
&\times e^{i\frac{m_\nu^2}{E_\nu}(t^1 - T_\nu)} e^{-i\frac{m_\nu^2}{E_\nu}(t^2 - T_\nu)} e^{-\frac{\sigma_\nu}{2}((\vec{p}_\nu^1 - \vec{k}_\nu)^2 + (\vec{p}_\nu^2 - \vec{k}_\nu)^2)} \\
&\times e^{-i(E(\vec{p}_{\text{pion}})(t^1 - T_\pi) - \vec{p}_{\text{pion}} \cdot (\vec{x}^1 - \vec{X}_\pi))} \times e^{i(E(\vec{p}_{\text{pion}})(t^2 - T_\pi) - \vec{p}_{\text{pion}} \cdot (\vec{x}^2 - \vec{X}_\pi))} \\
&\times e^{i(E(\vec{p}_\mu)t^1 - \vec{p}_\mu \cdot \vec{x}^1)} \times e^{-i(E(\vec{p}_\mu)t^2 - \vec{p}_\mu \cdot \vec{x}^2)} \\
&\times e^{-\frac{1}{2\sigma_\pi}(\vec{x}^1 - \vec{X}_\pi - \vec{v}_\pi(t^1 - T_\pi))^2} e^{-\frac{1}{2\sigma_\pi}(\vec{x}^2 - \vec{X}_\pi - \vec{v}_\pi(t^2 - T_\pi))^2}, \tag{80}
\end{aligned}$$

where $S_5(s_1, s_2)$ stands for the products of Dirac spinors and their complex conjugates defined in Eq. (52) and its spin summation of Eq. (54). The products of S_5 with pion momentum is computed similarly and the probability

for the unseen muon in which muon momentum is integrated is

$$\begin{aligned}
& \int d\vec{p}_{muon} \sum_{s_1, s_2} |T|^2 \tag{81} \\
&= |N_{\pi\nu}|^2 \int d^4x_1 d^4x_2 \left| T_{\beta_f', \alpha_i} \right|^2 \left(\frac{1}{E_\nu^1 E_\nu^2} \right)^{\frac{1}{2}} e^{-\frac{\sigma_\nu}{2} ((\vec{p}_\nu^1 - \vec{k}_\nu)^2 + (\vec{p}_\nu^2 - \vec{k}_\nu)^2)} e^{-i(E(\vec{p}_{pion})\delta t - \vec{p}_{pion} \cdot \delta \vec{x})} \\
&\quad \times \Delta(\delta t, \delta \vec{x}) e^{i\frac{m_\nu^2}{E_\nu^1}(t^1 - T_\nu)} e^{-i\frac{m_\nu^2}{E_\nu^2}(t^2 - T_\nu)} e^{-\frac{1}{2\sigma_\pi} (\vec{x}^1 - \vec{X}_\pi - \vec{v}_\pi(t^1 - T_\pi))^2} e^{-\frac{1}{2\sigma_\pi} (\vec{x}^2 - \vec{X}_\pi - \vec{v}_\pi(t^2 - T_\pi))^2}.
\end{aligned}$$

The final expression has a simple form and is the same as the Gaussian integral methods.

4 Neutrino in real pion decay

So far the initial state are the proton and nucleus and the pion is unidentified and is equivalent to intermediate state.

We study the case where the pion is identified and is in the initial state of the scattering. Let the momentum of the pion is q_{pion} , then the decay amplitude of the pion is given as

$$\begin{aligned}
T &= gm_\mu \int d^4x \langle 0 | \phi(x) | q_{pion} \rangle \langle p_\mu, \nu(x) | J_5(x) | 0 \rangle \tag{82} \\
&= gm_\mu \int d^4x e^{-i(q_{pion} - p_\nu) \cdot x} \langle p_\mu | \mu(x) | 0 \rangle (1 - \gamma_5) u(\vec{p}_\nu)
\end{aligned}$$

After the integration of the momentum, the total probability becomes

$$\begin{aligned}
& \int d\vec{p}_{muon} |T|^2 \tag{83} \\
&= g^2 m_\mu^2 \int d^4x_1 d^4x_2 e^{-i(q_{pion} - p_\nu) \cdot (x_1 - x_2)} \Delta_\mu(x_1 - x_2) S_5
\end{aligned}$$

In the above result, the oscillation is so rapid that can not be observed and the time average is found as

$$\begin{aligned}
& \int d\vec{p}_{muon} |T|^2 \tag{84} \\
&= g^2 m_\mu^2 (m_\pi^2 - m_\mu^2) \int d^4x_1 d^4x_2 e^{-i(q_{pion} - p_\nu) \cdot (x_1 - x_2)} \Delta_\mu(x_1 - x_2)
\end{aligned}$$

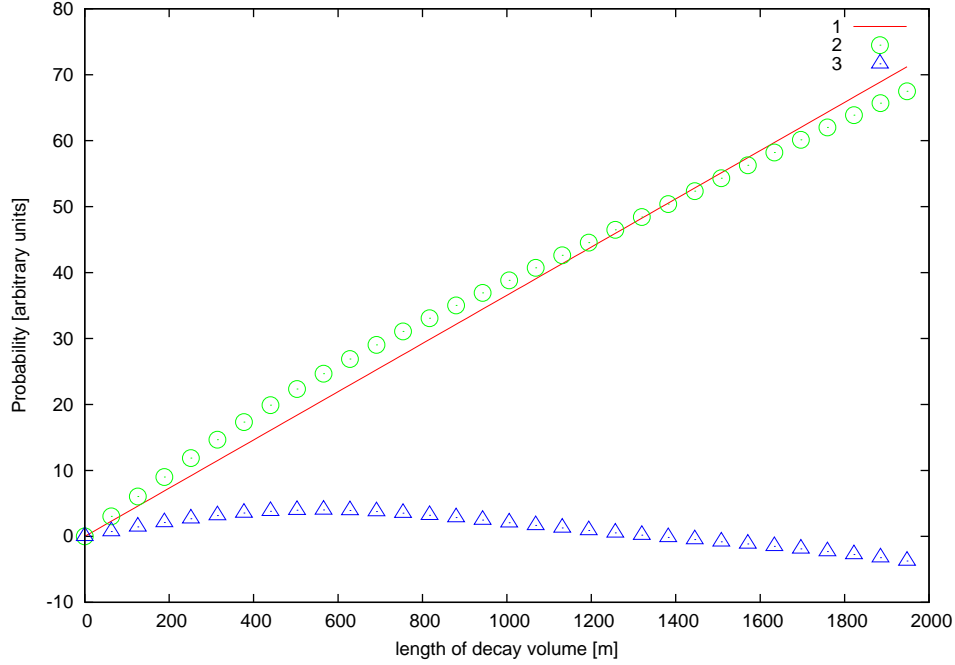

Fig. 9: The neutrino probability of the anomalous term is shown by circles and those that subtracted the T-linear term (solid line) is shown by triangles. The horizontal axis shows the distance in [m] and the magnitude is of arbitrary unit. The small oscillation is seen. The neutrino mass is $m_\nu = 1\text{eV}/c^2$.

The above neutrino probability has the same property as the normal term Eq. (68) and shows no long distance interference.

In higher order effect, the momentum of the intermediate state includes infinitely large value, so the light cone behavior is modified. Consequently it is expected that the long distance interference is generated. The lowest higher order correction is given by the pion exchange term. In this case the external pion momentum is included in the momentum of the intermediate pion and its effect remains in the final result,

$$\begin{aligned} & \int d\vec{p}_{\text{muon}} |T|^2 \\ &= g^2 g_{\pi\pi}^2 \int d^4x_1 d^4x_2 \Delta_\mu(x_1 - x_2) \Delta_\pi(p_{\text{pion}}, x_1 - x_2) S_5 e^{ip_\nu \cdot (x_1 - x_2)}, \end{aligned} \quad (85)$$

where the correlation function $\Delta_\pi(p_{\text{pion}}, x_1 - x_2)$ depends on the external pion

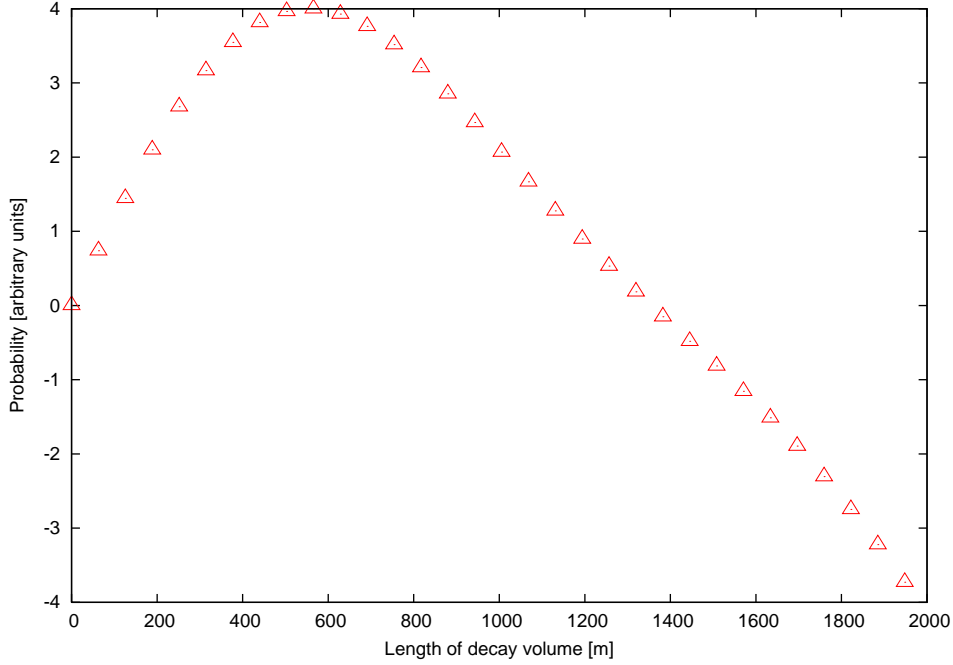

Fig. 10: The length dependence of the oscillating neutrino probability that is obtained subtracting the T -linear term from the total probability. The horizontal axis shows the distance in [m] and the magnitude is of arbitrary unit. The neutrino mass is $m_\nu = 1\text{eV}/c^2$.

momentum and is not a function of λ . $\Delta_\pi(p_{\text{pion}}, x_1 - x_2)$ is computed in the Appendix B and becomes

$$\begin{aligned} & \Delta_\pi(p_{\text{pion}}, x_1 - x_2) & (86) \\ & = \frac{1}{p_{\text{pion}}(x_1 - x_2)} \frac{1}{64\pi^2} \frac{1}{m^2}. \end{aligned}$$

The probability of observing the neutrino in the real pion decay is given in Fig. (9), which is composed of the T linear term and the oscillating term. Because it is hard to know the relative size of the one loop amplitude with the tree amplitude, the relative magnitude of the oscillation term is arbitrary. It is known that the non-universal terms from the tree level and the one-loop level behaves like the T -linear term and the universal term oscillates. Hence the oscillating term is obtained by subtracting the T -linear term from the total probability. The result is plotted in Fig. (10) as a slow oscillation.

5 Neutrinos from muon decay

5.1 Leptonic weak Hamiltonian and three body decay amplitude

Muon decays to an electron and two neutrinos. One is an electron neutrino and the other is a muon neutrino. We study the flux of each neutrino at a certain distance L in high energy region.

Leptonic decay of muon is described by the leptonic weak Hamiltonian

$$H_w = \frac{G_F}{\sqrt{2}} \int d\vec{x} J_{V-A\alpha} J_{V-A}^\alpha \dagger(x) \quad (87)$$

$$J_{V-A}^\alpha(x) = \bar{\mu}(x)\gamma^\alpha(1 - \gamma_5)\nu_\mu(x) + \bar{e}(x)\gamma^\alpha(1 - \gamma_5)\nu_e(x) \quad (88)$$

without any ambiguity. In the above equations, G_F is the Fermi coupling constant, $\mu(x)$ is the muon field, $e(x)$ is the electron field, $\nu_\mu(x)$ is the muon neutrino field, and $\nu_e(x)$ is the electron neutrino field. $J_{V-A}^\alpha(x)$ is the leptonic charged current.

5.2 Neutrinos from muon three body decay

Muon decay is treated in a similar manner as the previous pion decay. Here we assume that the muon correlation function has two components. First one is a function of $\lambda = \delta x^2$ and is invariant under Lorentz transformation of the coordinates δx . Second one is a function of the product $\delta x_\mu P_{\text{muon}}^\mu$ and has the same property as the normal term of the pion decay.

So the decay amplitude and decay probability are computed in Gaussian integral method. We integrate unseen particle's momenta and average over the initial muon momentum.

Leading term of expectation value of the weak leptonic currents at the light cone is

$$\begin{aligned} & \langle 0 | J_{\mu_1}(x_1) J^{\mu_2}(x_2) \dagger | 0 \rangle \\ & = 8(-\partial^2 g_{\mu_1\mu_2} + \partial_{\mu_1} \partial_{\mu_2}) i \epsilon((x_1^0 - x_2^0)) \delta'(\lambda). \end{aligned} \quad (89)$$

Because the electron and one unseen neutrino are not observed and their momenta are integrated in the infinite regions and the above correlation (89) is more singular than the previous one particle case.

The normal term gives the rapid oscillation term and its time average is proportional to the time T . The one loop term is generated by QED correction. As is discussed in the Appendix B, the fully invariant term does not exist in QED one loop correction but the non-oscillating power correction term which becomes roughly α times the magnitude of the normal term,

$$f_{\text{universal}} = \alpha \frac{1}{p_{\mu}(x_1 - x_2)} \times |f_{\text{normal}}| \quad (90)$$

do exist. This term gives an oscillation of the frequency determined by the neutrino mass and energy.

Finally we have the similar expression for the decay probability as the previous pion decay,

$$\int d\vec{p}_{\text{electron}} d\vec{p}_{\nu'} \sum_{s_1, s_2} |T|^2 = \tilde{N}_{\mu} \{g_1(T, \omega_{\nu}) + g_2(T, \omega_{\nu})\} + \tilde{f}_{\mu, \text{normal}}, \quad (91)$$

$$g_1(T, \omega) = T \int_0^T dX \frac{\sin(\omega X)}{X^2}, \quad g_2(T, \omega) = \int_0^T dX \frac{\sin(\omega X)}{X}.$$

Although the oscillating term that is due to the invariant term is much smaller than the ordinary term, the observation of this term may be possible.

In muon decay one muon neutrino and one electron neutrino are produced. They are linear combination of three mass eigenstates and a unitary MNS matrix combines flavour eigenstates with mass eigenstates.

5.2.1 Electron from muon decay

If the electron is measured and two neutrinos are unseen we have the probability of the electron at the distance L ,

$$\int d\vec{p}_{\nu} d\vec{p}_{\nu'} \sum_{s_1, s_2} |T|^2 = \tilde{N}_e \{g_1(T, \omega_e) + g_2(T, \omega_e)\} + \tilde{f}_{e, \text{normal}}, \quad (92)$$

$$\omega_e = \frac{m_e^2}{E_e}, \quad (93)$$

where the oscillation length is given by

$$L_0^e = \frac{E_e \hbar c}{m_e^2}. \quad (94)$$

The oscillation length of the electron is given by

$$L_0^e = 10^{-8}[\text{m}] \times (E_e/\text{GeV}) \quad (95)$$

and is too small if the energy is a few GeV. In the ultra-relativistic energy region, this oscillation may become observable.

6 Summary and implications

In this paper, we showed that one particle states of decaying particles that produce neutrinos are described using wave packets of finite coherence lengths and studied its implications to the neutrino interferences.

The wave packet size was determined either from particle production processes and detection processes. In the former, a finite mean free path in matter is the origin of the wave packet. The finite mean free path makes one particle to have a finite spatial extension and a finite momentum uncertainty. The state of a finite mean free path is a non-stationary state and is varied with time and space. In the latter, a finite size of the unit of detector is the origin of the wave packets. The wave packet sizes of the proton, pion, muon, and the neutrino were estimated and were used in analyzing high energy neutrino reactions.

Since the overall phase of wave packet during propagation is determined by the time component that is proportional to the energy and the space component that is proportional to the momentum and the space position and the time position are connected each others, both effects are taken into account simultaneously. Due to the relativistic invariance in the energy and momentum and in the time and space position, both terms in the total phase are almost cancelled and the total phase becomes small number that is proportional to the mass squared and inversely proportional to the energy. Consequently when the neutrino is described by the wave packet, the space-time dependent probability of the neutrino is found and the above overall phase or its difference becomes observable. We showed that the time dependent interference of the neutrino in the processes of the decays of pion or muon reveals this phase.

The time dependent probability of observing the neutrino at finite distance was calculated for high energy collisions and the anomalous oscillating term was found. This term has the origin in the higher order quantum effects where the infinite momentum virtual states play the important role. The new

universal term is manifestly invariant under the Lorentz transformation of the coordinates and gives the most important contribution in the operator product near the light cone region. Because the neutrino's velocity is almost the light velocity, the time dependent probability of finding the neutrino is determined by this universal term. The probability of finding the neutrino at finite medium time is oscillating with the slow angular velocity in Eq. (75). Since the angular velocity is determined by the neutrino mass and energy, the absolute value of the neutrino mass would be found from the neutrino interference oscillations.

Due to the relativistic invariance, the correlation function Δ_μ and others become functions of the Lorentz invariant combination λ . The space-time points that satisfies $\lambda = 0$ are on the light-cone surface and infinite number of points are on the surface. This is a feature of a relativistic invariant system and is a reason why the interference of the present work occurs. For a non-relativistic system, in a stationary state of the same calculation of the space coordinates is made by,

$$\int d\vec{k} \langle \vec{x}_1 | \vec{k} \rangle \langle \vec{k} | \vec{x}_2 \rangle = \delta(\vec{x}_1 - \vec{x}_2), \quad (96)$$

and the only one point $\delta\vec{x} = 0$ satisfies the condition and the probability get a contribution from only the point $\delta\vec{x} = 0$. The rotational invariant three dimensional space is compact but the Lorentz invariant four dimensional space is non-compact. This difference is important for the reason why the relativistic system has a peculiar property of the interference.

It is worthwhile to clarify the difference of the space-time dependent probability of the present work with the normal scattering probability defined at $t = \pm\infty$ here. The normal scattering amplitude is defined from the overlap between the in-state at $t = -\infty$ and out-state at $t = \infty$, and the space and time coordinates are integrated from $-\infty$ to ∞ and the energy and momentum of the final state is the same as that of the initial state. Hence the momentum of the muon or the pion in the final state of the ordinary scattering experiments are bounded due to the energy momentum conservation. So the infinite momentum is not included in the muon or pion of the final state. However the amplitude and probability at the finite time and their behaviors at the finite time are not computable in the ordinary S-matrix.

In our method it is possible to compute the amplitude and probability at the finite time and space. The energy and momentum conservation does not hold for these quantities and the infinite momentum state of the muon

and pion are included. These states of the infinite momentum give the finite contribution to the time dependent probability but do not contribute to the cross section measured at infinite distance. The important informations are obtained from the wave packet formalism that are not calculable in the standard scattering amplitude. Hence our calculation does not contradict with the ordinary calculation of the S-matrix in momentum representation but has the advantage of giving new informations.

In our calculation, Lorentz invariance is one important ingredient.

The characteristic small phase of the relativistic wave packet shows macroscopic interference of the neutrino. Although this result should be applied in high energy region, it would be interesting to see if this effect is found in ground experiments and others. Depending on the mass value, the phenomenon we have discussed in this paper may be relevant to short base line experiments, long base line experiments, and atmospheric neutrino experiments and others.

The oscillation phenomenon of the present work is sensitive to small mass, hence the same mechanism would work if there exists a very light particle. A possible candidate of light particle is axion. Axion might show a peculiar oscillation if it exist.

In this paper we ignored the effects of the pion life time and the pion mean free path in studying the higher order quantum effects. We will study these problems and other large scale physical phenomena of low energy neutrinos in subsequent papers.

Acknowledgements

One of the authors (K.I) thanks Dr. Nishikawa for useful discussions on the near detector of T2K experiment, Dr. Asai, Dr. Mori, and Dr. Yamada for useful discussions on interferences. This work was partially supported by a Grant-in-Aid for Scientific Research(Grant No. 19540253) provided by the Ministry of Education, Science, Sports and Culture,and a Grant-in-Aid for Scientific Research on Priority Area (Progress in Elementary Particle Physics of the 21st Century through Discoveries of Higgs Boson and Supersymmetry, Grant No. 16081201) provided by the Ministry of Education, Science, Sports and Culture, Japan.

References

- [1] K. Ishikawa and T. Shimomura, Prog. Theor. Physics. **114**, (2005), 1201-1234.
- [2] K. Ishikawa and Y. Tobita, Prog. Theor. Physics. **122**, (2009), 1111-1136. [arXiv : 0906.3938 [quant-ph]]
- [3] K. Ishikawa and Y. Tobita , “ Coherence length of cosmic background radiation enlarges the attenuation length of the ultra-high energy proton ” Hokkaido University preprint (2008). [arXiv : 0801.3124 [hep-ph]]; “ Neutrino mass and mixing ” in the 10th Inter. Symp. on “ Origin of Matter and Evolution of Galaxies ” AIP Conf. proc. 1016, P.329(2008).
- [4] J. Hosaka, et al, Phys. Rev. Vol. D**74**, 032002, (2006).
- [5] The Super-Kamiokande Collaboration. Phys. Lett. B**539**, 179, (2002).
- [6] S. N. Ahmed, et al. Phys. Rev. Lett. **92**, 181301 (2004).
- [7] T. Araki, et al. Phys. Rev. Lett. **94**, 081801 (2005).
- [8] E. A. Litvinovich. Phys. Atom. Nucl. **72**, 522–528 (2009).
- [9] E. Aliu, et al. Phys. Rev. Lett. **94**, 081802 (2005).
- [10] C. Amsler et al. [Particle Data Group], Phys. Lett. B**667**, 1 (2005).
- [11] C. Weinheimer, et al. Phys. Lett. B**460**, 219–226 (1999).
- [12] E. Komatsu, et al. Astrophys. J. Suppl. **180**, 330–376 (2009).
- [13] T. Araki, et al. Nature, **436**, 499–503 (2005).
- [14] K. Ishikawa and T. Shimomura , “ Coherent lunar effect on solar neutrino ” Hokkaido University preprint (2005)
- [15] M. L. Goldberger and Kenneth M. Watson, *Collision Theory* (John Wiley & Sons, Inc. New York, 1965).
- [16] R. G. Newton, *Scattering Theory of Waves and Particles* (Springer-Verlag, New York, 1982).

- [17] T. Sasakawa, Prog. Theor. Physics. **Suppl.11**, 69(1959).
- [18] B. Kayser, Phys. Rev. **D24**, 110(1981); Nucl.Phys. **B19** (Proc.Suppl), 177(1991).
- [19] C. Giunti, C. W. Kim, and U. W. Lee, Phys. Rev. **D44**, 3635(1991)
- [20] S. Nussinov, Phys. Lett. **B63**, 201(1976)
- [21] K. Kiers, N. Nussinov and N. Weisis, Phys. Rev. **D53**, 537(1996).
- [22] L. Stodolsky, Phys. Rev. **D58**, 036006(1998).
- [23] H. J. Lipkin, Phys. Lett. **B642**, 366(2006).
- [24] A. Asahara, K. Ishikawa, T. Shimomura, and T. Yabuki, Prog. Theor. Phys. **113**, 385(2005); T. Yabuki and K. Ishikawa, Prog. Theor. Phys. **108**, 347(2002).
- [25] K. Wilson, in Proceedings of the Fifth International Symposium on Electron and Photon Interactions at High Energies, Ithaca, New York, 1971, p.115 (1971).

Appendix A Formula for neutrinos of three flavour

There are three eigenstates of neutrinos and their mass difference squared are known and mixing parameters are also known partly from flavour oscillations. The wave packets have been studied in flavour oscillations in [18, 19, 20, 21, 22, 23, 24]. We studied neutrino spatial interference in this paper, which is unrelated directly with these flavour oscillations. A unified treatment of neutrino phenomena is possible and will be presented in a next paper.

For the wave packets to overlap at the detector, two components of mass eigenstates should arrive to the detector same time and should have the same energy within wave packet uncertainties. Hereafter we assume that these conditions are satisfied and study the amplitude for three neutrinos. General finite time amplitude for each flavour combination is expressed using amplitudes of three mass eigenstates, $T(i, t_1, \vec{x}_1)$ as

$$T_{\alpha,\beta} = \int_{T_0}^T dt_1 d\vec{x}_1 \sum_i U_{\alpha i} T(i, t_1, \vec{x}_1) U_{i\beta}^\dagger, \quad (97)$$

where $U_{i\alpha}$ is a unitary matrix which connects flavour eigenstate α to the mass eigenstate i . Time dependent neutrino production amplitude $T(i, t_1, \vec{x}_1)$ was given before and is substituted into the finite time probability. We have, after the coordinates and other variables are integrated,

$$|T_{\alpha,\beta}|^2 = U_{\alpha i_1}(U_{\alpha i_2})^* \int_{T_0}^T dt_1 dt_2 T(i_1, t_1) T(i_2, t_2)^* U_{i_1 \beta}^\dagger (U_{i_2 \beta}^\dagger)^*, \quad (98)$$

$$T(i_1, t_1) T(i_2, t_2)^* = N e^{i \frac{m_{i_1}^2}{E(\vec{p})}(t_1 - T_0) - i \frac{m_{i_2}^2}{E(\vec{p})}(t_2 - T_0)} \frac{1}{t_1 - t_2}, \quad (99)$$

where N is a constant.

Appendix B Operator product expansion and new universal term

B-I Pion decay

Neutrino detection amplitude and probability we have discussed is understood from operator product expansions at the light cone region $(x_1 - x_2)^2 \approx 0$ [25].

In Eq.(51), the total probability is given by the integral of the space time coordinates of the weak Hamiltonian and is invariant under the translation of space and time. Due to the translational invariance, the energy and momentum of the final state are the same as those of the initial state. Now we interchange the order of the summation of the coordinates and final states and obtain the time dependent probability. The time dependent probability which is obtained by summing the final state first is given in Eq.(71). This probability has two components, invariant term and non-invariant term under the translation in time. The former is the T-linear term and the latter is the T-oscillating term.

The translational invariant term gets the contribution from the final states that has the same energy as the that of the initial state. But the energy of the final states that contributes to the latter is not necessary be the same as that of the initial state. Hence the states of the infinite momentum could appear in the intermediate state for the T-oscillating term and give the finite contribution to the probability at the finite time although they do not contribute

to the probability at the infinite time. The states of infinite momentum contributes only to T-oscillating term and we estimate its magnitude based on the operator product expansion at the light cone region.

The functions $\Delta_{\text{muon}}(\delta t, \delta \vec{x})$ and $\Delta_{\text{pion}}(\delta t, \delta \vec{x})$ at the light cone region,

$$\lambda = (\delta t)^2 - (\delta \vec{x})^2 = 0 \quad (100)$$

are the expectation values of the products of the muon field and the expectation value of the pion field

$$\langle 0 | \mu(x_1) \bar{\mu}(x_2) | 0 \rangle, \quad (101)$$

$$\langle \alpha_{\text{in}}, \beta_{\text{out}} | \phi_{\pi}(x_1) \phi_{\pi}(x_2) | \alpha_{\text{in}}, \beta_{\text{out}} \rangle, \quad (102)$$

where α_{in} includes the proton and the target state and β_{out} includes many pions and other particles in the final state.

The muon correlation function was studied in Eq. (56).

B-I.1 the normal term

Hereafter we study the pion correlation function. The pion correlation function from Fig. 2 gives the neutrino production probability that is determined by incoherent decay of produced pions and interference among the pions are negligible. The time dependence is given by $e^{i \frac{m_{\pi}^2}{E_{\pi}}(t_1 - t_2)}$ and the angular velocity is too large to observe the oscillation. The correlation function becomes

$$\Delta_{\text{pion}}(\delta t, \delta \vec{x}) = \int d\vec{p} P(\vec{p}) e^{i \frac{m_{\pi}^2}{E_{\pi}}(t_1 - t_2)} \quad (103)$$

$$= \langle |N_{\pi}| \rangle e^{i \frac{m_{\pi}^2}{\langle E_{\pi} \rangle} (t_1 - t_2)}, \quad (104)$$

and in the ordinary pion energy of about 10 GeV/c², the angular velocity of this term corresponds to the oscillation length

$$L_0 = \frac{E_{\pi} \hbar c}{m_{\pi}^2}, \quad (105)$$

which is too short for observation. The average of this term contributes to the T-linear probability.

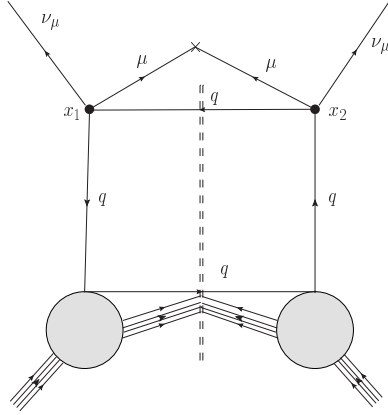

Fig. 11: The Feynman diagram of the anomalous term of the neutrino probability using quark fields is given.

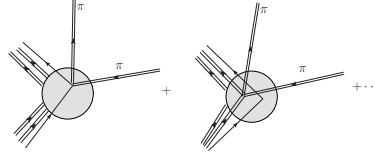

Fig. 12: In the anomalous term of the neutrino probability, the hard pion couples either with the pion or the proton in the hadronic parts.

B-I.2 a new universal term

The energy of the final state β in the T-oscillating term is not necessary the same as that of the initial state and infinite momentum states can couple and gives finite contribution to the pion correlation function. We estimate the effects of the infinite momentum hereafter.

We study the pion correlation function that includes infinite momentum states in β . They are almost equivalent to Fig. 2 except that pions have infinite momenta and we write the infinite momentum pion explicitly as Fig. 3. We will see that this gives a manifestly invariant term $F(\lambda)$ of Eq.(66).

This correlation function is calculated with quark fields as in the Feynman diagram of Fig. 11 or with pion fields as in Fig. 3. In the former, QCD is applied. The amplitudes in QCD has severe infrared divergence in time-like region and quark propagator has no simple pole and has a cut at real energy axis as in QED discussed next. We replace the integration on the energy in Minkowski metric to the Euclidean four momentum integration. This Wick rotation is allowed if the amplitude is analytic except cut along real axis. We assume that this holds and compute the integral in Euclidean metric. In Euclidean metric there are no infrared divergence and quark dynamics are

effectively described by meson dynamics. So we compute the pion correlation functions using pion propagators as in Eq.(66).

Now we estimate the amplitude.

$$\begin{aligned}
& F((x_1 - x_2)) \tag{106} \\
&= \int d^4p e^{-ip \cdot (x_1 - x_2)} \frac{1}{p^2 - m^2 - i\epsilon} \frac{1}{p^2 - m^2 + i\epsilon} \delta((p + p_f)^2 - m^2) |T_{\text{hadron}}^1|^2 \\
&= \int d^4p e^{-ip \cdot (x_1 - x_2)} \frac{1}{p^2 - m^2 - i\epsilon} \frac{1}{p^2 - m^2 + i\epsilon} \frac{1}{2i\pi} \\
&\times \left(\frac{1}{(p + p_f)^2 - m^2 - i\epsilon} - \frac{1}{(p + p_f)^2 - m^2 + i\epsilon} \right) |T_{\text{hadron}}^1|^2,
\end{aligned}$$

where $p_f = p_\alpha - p_\beta$. The momentum of the pion which connect the coordinates x_1 and x_2 must be taken from $-\infty$ to ∞ . The integral is reduced to

$$\begin{aligned}
& F((x_1 - x_2)) \tag{107} \\
&= |T_{\text{hadron}}^1|^2 \frac{1}{p_f(x_1 - x_2)} \frac{1}{64\pi^2} \frac{1}{m^2} + O\left(\frac{1}{\{p_f(x_1 - x_2)\}^2}\right),
\end{aligned}$$

for $p_f \neq 0$ in the Euclidean metric space calculation. The infinite momentum state of the pion at the coordinate x_1 enters the hadronic part T_{hadron}^1 and interacts with the one of pions or proton and the pion of the infinite momentum goes out because other particles in the hadronic part have finite momentum as Fig. 12.

For $p_f = 0$, the invariant term is computed as

$$\begin{aligned}
& F((x_1 - x_2)^2) \tag{108} \\
&= g^2 \int \frac{d^4p_E}{(2\pi)^4} e^{ip_E(x_1 - x_2)} \left(\frac{1}{p_E^2 + m^2} \right)^3 |T_{\text{hadron}}^1|^2.
\end{aligned}$$

The integral in the right-hand side

$$D((x_1 - x_2)^2) = \int \frac{d^4p_E}{(2\pi)^4} e^{ip_E(x_1 - x_2)} \left(\frac{1}{p_E^2 + m^2} \right)^3 \tag{109}$$

is invariant under the Lorentz transformation of $x_1 - x_2$ and is a function of λ . Hence we have

$$D(0) = \int \frac{d^4p_E}{(2\pi)^4} \left(\frac{1}{p_E^2 + m^2} \right)^3 = \frac{1}{64\pi^2} \frac{1}{m^2}, \tag{110}$$

and

$$\begin{aligned}
F(0) & \tag{111} \\
&= g^2 \int \frac{d^4 p_E}{(2\pi)^4} \left(\frac{1}{p_E^2 + m^2} \right)^3 |T_{\text{hadron}}^1|^2 \\
&= \frac{g^2}{64\pi^2} \frac{1}{m^2} |T_{\text{hadron}}^1|^2.
\end{aligned}$$

Actually because two pion couples with the proton or pions and the total number of the pions N_π is larger than the number of the proton. Hence the pion correlation function becomes

$$F(0) = \frac{g_{\pi N}^2 + N_\pi g_{\pi\pi}^2}{64\pi^2} \frac{1}{m^2} |T_{\text{hadron}}^1|^2, \tag{112}$$

where $g_{\pi N}$ is the pion Nucleon coupling strength and $g_{\pi\pi}$ is the pion pion coupling strength,

B-II Real pion decay

When the real pion of the momentum p_{pion} is an initial state, one loop correction to the pion correlation function is given by the following integral,

$$\begin{aligned}
& \Delta_\pi(p_{\text{pion}}, x_1 - x_2) \tag{113} \\
&= \int d^4 q e^{-iq \cdot (x_1 - x_2)} \frac{1}{p^2 - m^2 - i\epsilon} \frac{1}{p^2 - m^2 + i\epsilon} \delta((p + q_{\text{pion}})^2) \\
&= \int d^4 q e^{-iq \cdot (x_1 - x_2)} \frac{1}{p^2 - m^2 - i\epsilon} \frac{1}{p^2 - m^2 + i\epsilon} \frac{1}{2i\pi} \\
&\times \left(\frac{1}{(p + q_{\text{pion}})^2 - m^2 - i\epsilon} - \frac{1}{(p + q_{\text{pion}})^2 - m^2 + i\epsilon} \right). \tag{114}
\end{aligned}$$

When the higher order correction is added and the infrared divergence is avoided, the propagator becomes not to have a simple pole but a cut along the real axis. Although it is a difficult problem to find out the dynamics of infrared divergence, we simply make Wick rotation and compute the Lorentz invariant term.

This integration is made in Euclidean metric space. We have then,

$$\begin{aligned}
& \Delta_\pi(p_{\text{pion}}, x_1 - x_2) \tag{115} \\
&= \frac{1}{p_{\text{pion}}(x_1 - x_2)} \frac{1}{64\pi^2} \frac{1}{m^2} + O\left(\frac{1}{\{p_{\text{pion}}(x_1 - x_2)\}^2} \right),
\end{aligned}$$

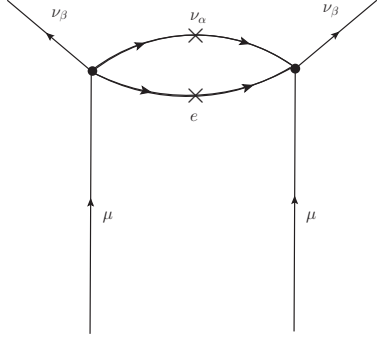

Fig. 13: The diagram of the normal order in the neutrino probability in the muon decay.

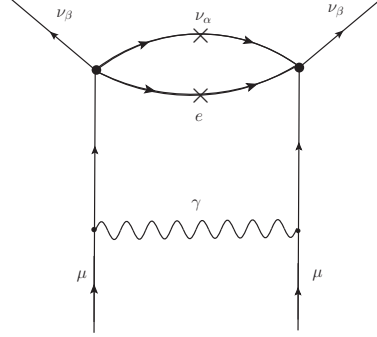

Fig. 14: The diagram of the lowest order correction in the neutrino probability in the muon decay.

which has a power term.

B-III III muon decay

For the muon decays, higher order corrections are generated from QED and the hard photon exchange term of Fig. 14 would give the invariant term. This diagram has the infra-red divergence that is avoided by redefining one particle charged state in the initial and final state in such way that is dressed by soft photon. Charged field becomes not to have simple pole but cut. So integration of the large momentum in Fig. 14 becomes equivalent to that of the Euclidean metric. We estimate the Lorentz invariant amplitude from the integration in the Euclidean metric integration and we have then

$$\begin{aligned}
 & F_{\text{muon}}(x_1 - x_2) \tag{116} \\
 &= e^2 \int \frac{d^4 p_E}{(2\pi)^4} e^{ip_E(x_1 - x_2)} \left(\frac{1}{p_E^2 + m_\mu^2} \right)^2 \frac{1}{(p_E + q)^2} |T_{\text{muon}}^1|^2 \\
 &= \frac{e^2}{64\pi^2} \frac{1}{q(x_1 - x_2)} \frac{1}{m_\mu^2} |T_{\text{muon}}^1|^2 + O\left(\frac{1}{(q(x_1 - x_2))^2}\right),
 \end{aligned}$$

where q is the momentum of muon. Thus higher order correction has a power correction term that is inversely proportional to the variable $q(x_1 - x_2)$ but not a function of λ . This term gives also the oscillation of the frequency $\frac{m_\nu^2}{E_\nu}$. However because of the factor $\frac{1}{q(x_1 - x_2)}$ this oscillation appears in the time derivative of the probability.