

# Soliton and Periodic Solutions of the Short Pulse Model Equation

Yoshimasa Matsuno\*

*Division of Applied Mathematical Science, Graduate School of Science  
and Engineering, Yamaguchi University, Ube, Yamaguchi 755-8611, Japan*

## ABSTRACT

The short pulse (SP) equation is a novel model equation describing the propagation of ultra-short optical pulses in nonlinear media. This article reviews some recent results about the SP equation. In particular, we focus our attention on its exact solutions. By using a newly developed method of solution, we derive multisoliton solutions as well as 1-and 2-phase periodic solutions and investigate their properties.

## 1 INTRODUCTION

In this article, we address the following short pulse (SP) model equation

$$u_{xt} = u + \frac{1}{6}(u^3)_{xx}, \quad (1.1)$$

where  $u = u(x, t)$  represents the magnitude of the electric field and subscripts  $x$  and  $t$  appended to  $u$  denote partial differentiation. The SP equation was proposed as a model nonlinear equation describing the propagation of ultra-short optical pulses in nonlinear media [1]. It is an alternative model equation to the cubic nonlinear Schrödinger (NLS) equation. The basic assumption in deriving the NLS equation is a slowly varying amplitude approximation. Hence, as discussed in the context of self-focusing of ultra-short pulses in nonlinear media [2, 3], its validity would be violated if the pulse width becomes very short. A recent numerical analysis reveals that as the pulse length shortens, the SP equation becomes a better approximation to the solution of the Maxwell equation when compared with the prediction of the nonlinear NLS equation [4]. Although the mathematical structure of the NLS equation has been studied extensively, only a few results are known for the SP equation. Here, we describe some recent results associated with the SP equation. In particular, we focus our attention on an exact method of solution, soliton and periodic solutions and their properties.

---

\*E-mail address: matsuno@yamaguchi-u.ac.jp

This article is organized as follows: In Sec. 2, we derive the SP equation starting with Maxwell equations for the electric and magnetic fields. In Sec. 3, an exact method of solution is developed for the SP equation which transforms the SP equation to the integrable sine-Gordon (sG) equation through a hodograph transformation. In Sec. 4, the soliton solutions are constructed which include the multiloop soliton and multibreather solutions. Subsequently, the interaction process of solitons is described in detail. In Sec. 5, the exact method is applied to obtaining 1- and 2-phase periodic solutions. Some properties of the solutions are discussed as well as their long-wave limit. In Sec. 6, an alternative method of solution is introduced which enables us to construct a more general class of periodic solutions. Then, the 1- and 2-phase solutions are exemplified. Section 7 is devoted to conclusion.

## 2 SHORT PULSE EQUATION

### 2.1 Basic equations

The electric and magnetic fields  $\mathbf{E}$  and  $\mathbf{H}$  as well as the electric and magnetic flux densities  $\mathbf{D}$  and  $\mathbf{B}$  are governed by the following set of equations

$$\operatorname{div} \mathbf{D} = \rho, \quad \operatorname{div} \mathbf{B} = 0, \quad \operatorname{rot} \mathbf{E} = -\frac{\partial \mathbf{B}}{\partial t}, \quad \operatorname{rot} \mathbf{H} = \mathbf{j} + \frac{\partial \mathbf{D}}{\partial t}, \quad (2.1)$$

where  $\rho$  and  $\mathbf{j}$  are the electric charge and current densities, respectively. We consider the one-dimensional propagation of the wave so that we can put

$$\mathbf{E} = E_3(x, t)\mathbf{e}_3, \quad \mathbf{H} = H_2(x, t)\mathbf{e}_2, \quad (2.2)$$

where  $\mathbf{e}_2$  and  $\mathbf{e}_3$  are unit vectors perpendicular to the  $x$  axis. We also assume the following relations

$$\mathbf{D} = \epsilon_0 \mathbf{E} + \mathbf{P}, \quad \mathbf{B} = \mu_0 \mathbf{H}, \quad (2.3)$$

where  $\mathbf{P}$  is the induced electric polarization,  $\epsilon_0$  is the vacuum permittivity and  $\mu$  is the vacuum permeability. In view of (2.2), Eqs. (2.1) and the first equation of (2.3) are simplified to

$$\frac{\partial H_2}{\partial x} = \frac{\partial D_3}{\partial t}, \quad \frac{\partial E_3}{\partial x} = \mu_0 \frac{\partial H_2}{\partial t}, \quad (2.4)$$

$$D_3 = \epsilon_0 E_3 + P_3, \quad (2.5)$$

respectively. Combining (2.4) and (2.5), we obtain the equation for  $E_3$ . It reads in form

$$E_{xx} - \frac{1}{c^2} E_{tt} = P_{tt}, \quad (2.6)$$

where  $E = E_3$ ,  $P = \mu_0 P_3$  and  $c^2 = (\epsilon_0 \mu_0)^{-1}$ . The polarization  $P$  can be split into the linear part  $P_{\text{lin}}$  and the nonlinear part  $P_{\text{nl}}$  and it may be written in the form

$$P = P_{\text{lin}} + P_{\text{nl}} = \int_{-\infty}^{\infty} \chi^{(1)}(t - \tau) E(x, \tau) d\tau + \int_{-\infty}^{\infty} \int_{-\infty}^{\infty} \int_{-\infty}^{\infty} \chi^{(3)}(t - \tau_1, t - \tau_2, t - \tau_3) E(x, \tau_1) E(x, \tau_2) E(x, \tau_3) d\tau_1 d\tau_2 d\tau_3, \quad (2.7)$$

where  $\chi^{(1)}$  and  $\chi^{(3)}$  are the susceptibilities. If we consider the propagation of light with the wavelength between 1600nm and 3000nm, then the Fourier transform  $\hat{\chi}^{(1)}$  of  $\chi^{(1)}$  is found to be well approximated by the relation  $\hat{\chi}^{(1)} \simeq \hat{\chi}_0^{(1)} - \hat{\chi}_2^{(1)} \lambda^2$  [1]. It follows from this and the relation  $\omega = 2\pi c/\lambda$  that the linear equation for (2.6) written in Fourier transformed form becomes

$$\hat{E}_{xx} + \frac{1 + \hat{\chi}_0^{(1)}}{c^2} \omega^2 \hat{E} - (2\pi)^2 \hat{\chi}_2^{(1)} \hat{E} = 0. \quad (2.8)$$

As for the nonlinear term in Eq. (2.6), we assume that the instantaneous contribution is dominant for the short and small amplitude pulses. Under this situation, we can set  $\chi^{(3)}(t - \tau_1, t - \tau_2, t - \tau_3) = \chi_3 \delta(t - \tau_1) \delta(t - \tau_2) \delta(t - \tau_3)$  where  $\chi_3$  is a constant. If we introduce this relation into the nonlinear term on the right-hand side of (2.7), we obtain  $P_{\text{nl}} = \chi_3 E^3$ , which combined with (2.8), yields a single nonlinear wave equation for  $E$

$$E_{xx} - \frac{1}{c_1^2} E_{tt} = \frac{1}{c_2^2} E + \chi_3 (E^3)_{tt}, \quad (2.9)$$

where  $c_1 = c/\sqrt{1 + \hat{\chi}_0^{(1)}}$  and  $c_2 = 1/(2\pi\sqrt{\hat{\chi}_2^{(1)}})$ .

## 2.2 Perturbation analysis

Equation (2.9) describes the interactions between the left and right moving pulses. Since the pulses are very short, the interaction between them would give rise to a higher-order effect on the evolution of the waves. Consequently, we may address only the right moving pulses, for instance. We use the multiple scale method to derive the approximate equation by expanding  $E$  as

$$E(x, t) = \epsilon E_0(\phi, X) + \epsilon^2 E_1(\phi, X) + \dots, \quad (2.10)$$

where  $\epsilon$  is a small parameter which measures the shortness of the pulse relative to the time scale determined by the resonance, and  $\phi$  and  $X$  are the scaled

variables defined by

$$\phi = \frac{t - \frac{x}{c_1}}{\epsilon}, \quad X = \epsilon x. \quad (2.11)$$

If we introduce (2.10) with (2.11) into Eq. (2.9), we obtain, at the order  $O(\epsilon)$ , the following partial differential equation (PDE) for  $E_0$ :

$$-\frac{2}{c_1} \frac{\partial^2 E_0}{\partial \phi \partial X} = \frac{1}{c_2^2} E_0 + \chi^3 \frac{\partial^2 E_0^3}{\partial \phi^2}. \quad (2.12)$$

After an appropriate change of the variables, we arrive at the normalized form of the SP equation (1.1).

### 2.3 Remarks

1. The SP equation has been derived for the first time in an attempt to construct integrable differential equations associated with pseudospherical surfaces [5]. Schäfer and Wayne rederived it starting from Maxwell's equations of electric field in the fiber as described in this section. See also a prior work due to Alterman and Rauch who discuss the breakdown of the slowly varying envelope approximation and perform an asymptotic analysis for a new type of nonlinear evolution equation [6].
2. The integrability of the SP equation has been established from various mathematical points of view [5, 7-10].
3. There exist several analogous equations to the SP equation which have been proven to be completely integrable. We write one of them in the form

$$u_{xt} = \alpha u + \frac{1}{2}(1 - \beta)u_x^2 - uu_{xx}. \quad (2.13)$$

When  $\beta = 2$ , Eq. (2.13) becomes the short-wave model for the Camassa-Holm equation while when  $\beta = 4$ , it reduces to the the short-wave model for the Degasperis-Procesi equation and the Vakhnenko equation. The general multisoliton solutions of these equations have been obtained in parametric forms [11].

## 3 METHOD OF EXACT SOLUTION

### 3.1 Reduction to the sine-Gordon equation

Here we develop an analytical method for solving the SP equation which employs the hodograph transformation to reduce it to the completely integrable sG equation [12]. We first introduce the new dependent variable  $r$

$$r^2 = 1 + u_x^2, \quad (3.1)$$

to transform the SP equation (1.1) into the form of conservation law

$$r_t = \left( \frac{1}{2} u^2 r \right)_x. \quad (3.2)$$

We then define the hodograph transformation  $(x, t) \rightarrow (y, \tau)$  by means of

$$dy = r dx + \frac{1}{2} u^2 r dt, \quad d\tau = dt, \quad (3.3a)$$

or equivalently

$$\frac{\partial}{\partial x} = r \frac{\partial}{\partial y}, \quad \frac{\partial}{\partial t} = \frac{\partial}{\partial \tau} + \frac{1}{2} u^2 r \frac{\partial}{\partial y}. \quad (3.3b)$$

In terms of the new variables  $y$  and  $\tau$ , (3.1) and (3.2) are recast into

$$r^2 = 1 + r^2 u_y^2, \quad (3.4)$$

$$r_\tau = r^2 u u_y, \quad (3.5)$$

respectively. Furthermore, we define the variable  $\phi$  by

$$u_y = \sin \phi, \quad \phi = \phi(y, \tau). \quad (3.6)$$

Inserting (3.6) into (3.4) gives

$$\frac{1}{r} = \cos \phi. \quad (3.7)$$

It follows from (3.5)-(3.7) that

$$u = \phi_\tau. \quad (3.8)$$

Finally, if we substitute (3.8) into (3.6), we find that  $\phi$  obeys the following sG equation

$$\phi_{y\tau} = \sin \phi. \quad (3.9)$$

This form of the sG equation will be used to construct soliton solutions of the SP equation. For the periodic solutions, it is appropriate to introduce the two independent phase variables  $\xi$  and  $\eta$  according to

$$\xi = ay + \frac{\tau}{a} + \xi_0, \quad (3.10a)$$

$$\eta = ay - \frac{\tau}{a} + \eta_0, \quad (3.10b)$$

where  $a(\neq 0)$ ,  $\xi_0$  and  $\eta_0$  are arbitrary constants. In terms of the new variables, the sG equation (3.9) is transformed to

$$\phi_{\xi\xi} - \phi_{\eta\eta} = \sin \phi, \quad \phi = \phi(\xi, \eta). \quad (3.11)$$

### 3.2 Parametric representation of the solution

The solution  $u$  has a parametric representation given by (3.8). To be more specific

$$u(y, \tau) = \phi_\tau. \quad (3.12)$$

To obtain the parametric representation of the coordinate  $x$ , we note from (3.3b) that the inverse mapping  $(y, \tau) \rightarrow (x, t)$  is governed by the system of linear PDE for  $x = x(y, \tau)$

$$x_y = \frac{1}{r}, \quad x_\tau = -\frac{1}{2}u^2. \quad (3.13)$$

Since the integrability of the above system of equations is assured automatically by Eq. (3.5), we are able to integrate (3.13) immediately to obtain

$$x(y, \tau) = \int \cos \phi \, dy + c, \quad (3.14)$$

where  $c$  is an integration constant.

### 3.3 Criterion for the single-valued solutions

As will be demonstrated later, most of the parametric solutions (3.12) and (3.14) become multivalued functions for both the soliton and periodic solutions. The single-valued functions are particularly useful in application to the real physical problem such as the propagation of nonlinear short pulses in an optical fiber. A criterion for single-valued functions may be obtained simply by requiring that  $u_x$  exhibits no singularities. It follows from (3.3b), (3.6) and (3.7) that  $u_x = \tan \phi$ . Thus, if

$$-\frac{\pi}{2} < \phi < \frac{\pi}{2}, \quad (\text{mod } \pi), \quad (-\sqrt{2} + 1 < \tan \frac{\phi}{4} < \sqrt{2} - 1). \quad (3.15)$$

then the parametric solutions (3.12) and (3.14) would become single-valued functions for all values of  $x$  and  $t$ .

### 3.4 Remark

The reduction of the SP equation to the sG equation has also been established through the chain of transformations [8].

## 4 SOLITON SOLUTIONS

### 4.1 Parametric representation of the $N$ -soliton solution

In the context of the sG model, the soliton solutions are called kinks or breathers. These solutions are reduced from the soliton solutions by specifying the parameters such as the amplitude and the phase. Here we present the parametric representation for the  $N$ -soliton solution of the SP equation [12].

The general  $N$ -soliton solution of the sG equation can be written in a compact form as [13]

$$\phi = 2i \ln \frac{f'}{f}, \quad (4.1)$$

with

$$f = \sum_{\mu=0,1} \exp \left[ \sum_{j=1}^N \mu_j \left( \xi_j + \frac{\pi}{2} i \right) + \sum_{1 \leq j < k \leq N} \mu_j \mu_k \gamma_{jk} \right], \quad (4.2a)$$

$$f' = \sum_{\mu=0,1} \exp \left[ \sum_{j=1}^N \mu_j \left( \xi_j - \frac{\pi}{2} i \right) + \sum_{1 \leq j < k \leq N} \mu_j \mu_k \gamma_{jk} \right], \quad (4.2b)$$

$$\xi_j = p_j y + \frac{1}{p_j} t + \xi_{j0}, \quad (j = 1, 2, \dots, N), \quad (4.2c)$$

$$e^{\gamma_{jk}} = \left( \frac{p_j - p_k}{p_j + p_k} \right)^2, \quad (j, k = 1, 2, \dots, N; j \neq k). \quad (4.2d)$$

Here,  $p_j$  and  $\xi_{j0}$  are arbitrary complex parameters satisfying the conditions  $p_j \neq \pm p_k$  for  $j \neq k$ ,  $i = \sqrt{-1}$  and  $N$  is an arbitrary positive integer. The notation  $\sum_{\mu=0,1}$  implies the summation over all possible combination of  $\mu_1 = 0, 1, \mu_2 = 0, 1, \dots, \mu_N = 0, 1$ . Note in (4.2c) that the variable  $\tau$  is replaced by  $t$  taking into account (3.3a). This convention will be used in the following. The  $\tau$ -functions  $f$  and  $f'$  play an essential role in constructing soliton solutions, as will be seen below. They satisfy the following system of bilinear equations

$$f f_{yt} - f_y f_t = \frac{1}{4} (f^2 - f'^2), \quad (4.3a)$$

$$f' f'_{yt} - f'_y f'_t = \frac{1}{4} (f'^2 - f^2). \quad (4.3b)$$

We obtain from (4.1) and (4.3) the important relation

$$\cos \phi = 1 - 2(\ln f'f)_{yt}. \quad (4.4)$$

Introducing (4.4) into (3.14) and integrating with respect to  $y$  yield the parametric form of the coordinate  $x$

$$x(y, t) = y - 2(\ln f'f)_t + c, \quad (4.5)$$

where  $c$  is an integration constant depending generally on  $t$ . It also follows from (3.12) and (4.1) that

$$u(y, t) = 2i \left( \ln \frac{f'}{f} \right)_t, \quad (4.6)$$

which, combined with (4.6), gives the parametric representation of the  $N$ -soliton solution of the SP equation. To complete the solution, one must determine the time dependence of  $c$ . To this end, we substitute (4.5) and (4.6) into the second equation of (3.13) and obtain the bilinear equation for  $f$  and  $f'$

$$f f'_{tt} - 2f'_t f_t + f' f_{tt} = \frac{1}{2} c'(t) f' f. \quad (4.7)$$

One can show that the  $\tau$ -functions  $f$  and  $f'$  from (4.2) vanish the left-hand side of (4.7). Consequently,  $c'(t) = 0$ . Thus, in the case of soliton solutions, the constant  $c$  does not depend on  $t$ . In the following discussion, we consider real  $u$  so that we take  $f' = f^*$  (complex conjugate of  $f$ ). As will be seen later, this restriction imposes certain conditions on the parameters  $p_j$  and  $\xi_{j0}$  ( $j = 1, 2, \dots, N$ ). The loop soliton and breather solutions of the SP equation are special classes of the general  $N$ -soliton solutions given by (4.5) and (4.6).

If we use (4.1) with  $f' = f^*$  and the formula  $i \ln(f^*/f) = 2 \tan^{-1}(\text{Im } f / \text{Re } f)$ , the criterion (3.15) for the single-valued solutions can be rewritten as

$$-\sqrt{2} + 1 < \frac{\text{Im } f}{\text{Re } f} < \sqrt{2} - 1. \quad (4.8)$$

## 4.2 Loop soliton solutions

### 4.2.1 1-loop soliton solution

Various solutions can be obtained for the SP equation by specifying the parameters  $p_j$  and  $\xi_{j0}$  ( $j = 1, 2, \dots, N$ ) in (4.2). The loop (antiloop) soliton solutions arise from the kink (antikink) solutions of the sG equation. Let  $m$  and  $N - m$  be the number of positive and negative  $p_j$ , respectively. Then,



the corresponding soliton solution would describe the interaction of the  $m$  loop solitons and  $N - m$  antiloop solitons. Here we address the simplest 1-loop soliton solution which is of fundamental importance in discussing the properties of the general  $N$ -loop soliton solution. In this case, (4.2) is written as

$$f = 1 + ie^{\xi_1}, \quad \xi_1 = p_1 y + \frac{1}{p_1} t + \xi_{10}, \quad (4.9)$$

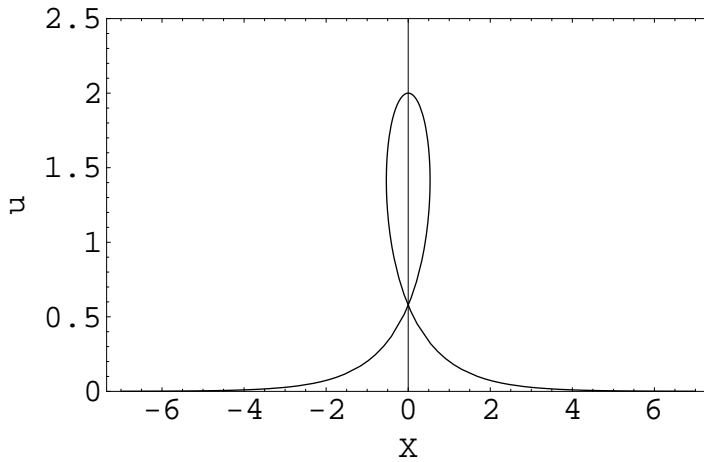

**Fig. 1:** A typical profile of the 1-loop soliton solution.

and  $f' = f^*$ . Substituting (4.9) into (4.5) and (4.6), we obtain

$$u(y, t) = \frac{2}{p_1} \operatorname{sech} \xi_1, \quad (4.10a)$$

$$x(y, t) = y - \frac{2}{p_1} \tanh \xi_1 + d_1, \quad (4.10b)$$

where  $d_1 = c - (2/p_1)$ ,  $p_1 > 0$  and  $\xi_{10}$  is a real constant. If we introduce a new variable  $X \equiv x + c_1 t - x_{10}$  with  $c_1 = 1/p_1^2$  and  $x_{10} = -\xi_{10}/p_1$ , then we can parameterize  $x(y, t)$  by a single variable  $\xi_1$ . To be more specific, it reads

$$X = \frac{\xi_1}{p_1} - \frac{2}{p_1} \tanh \xi_1 + d_1. \quad (4.11)$$

It follows from (4.10a) and (4.11) that

$$\frac{du}{dX} = \frac{\sinh \xi_1}{2 - \cosh^2 \xi_1}. \quad (4.12)$$

We see from (4.12) that  $du/dX$  changes sign three times and goes infinity at  $\xi_1 = \pm \cosh^{-1} 2$ . Thus, the parametric soliton exhibits singularities which has a form of single loop. The multi-valued feature of the solution is also confirmed by applying the criterion (4.8). In fact, it follows from (4.9) that  $\text{Re } f = 1$  and  $\text{Im } f = e^{\xi_1}$  and hence (4.8) cannot be satisfied for arbitrary values of  $y$  and  $t$ . Figure 1 shows a typical profile of the 1-loop soliton solution with the parameters  $p_1 = 1, d_1 = 0$ . The loop soliton propagates to the left (i.e., negative  $x$  direction) at a constant velocity  $c_1$ . If we define the amplitude  $A_1$  of the loop soliton by  $2/p_1$  (maximum value of  $u$ ), then  $c_1 = A_1^2/4$ . Thus, the large loop soliton moves more rapidly than the small loop soliton, indicating the typical solitonic behavior.

#### 4.2.2 $N$ -loop soliton solution

The general  $N$ -loop soliton solution of the SP equation arises from (4.5) and (4.6) by taking the parameters  $p_j (j = 1, 2, \dots, N)$  positive and  $\xi_{j0} (j = 1, 2, \dots, N)$  real. We first investigate the asymptotic behavior of the solution for large time and show that it is represented by a superposition of  $N$ -loop solitons. The procedure for deriving the large time asymptotics can be performed straightforwardly by investigating the behavior of the  $\tau$ -functions given by (4.2). Hence, we omit the detail and describe only the result. To this end, we put  $c_j = 1/p_j^2$  and order the magnitude of the velocity of each loop soliton as  $c_1 > c_2 > \dots > c_N$ . We observe the interaction of  $N$  loop solitons in a moving frame with a constant velocity  $c_n$ . We take the limit  $t \rightarrow -\infty$  with the phase variable  $\xi_n$  being fixed. We then find the following asymptotic form of  $u$  and  $x$ :

$$u \sim \frac{2}{p_n} \text{sech} (\xi_n + \delta_n^{(-)}), \quad (4.13a)$$

$$x \sim y - \frac{2}{p_n} \tanh (\xi_n + \delta_n^{(-)}) - 4 \sum_{j=n+1}^N \frac{1}{p_j} - \frac{2}{p_n} + c. \quad (4.13b)$$

where

$$\delta_n^{(-)} = \sum_{j=n+1}^N \ln \left( \frac{p_n - p_j}{p_n + p_j} \right)^2. \quad (4.13c)$$

The corresponding asymptotic forms for  $t \rightarrow +\infty$  are given by

$$u \sim \frac{2}{p_n} \text{sech} (\xi_n + \delta_n^{(+)}), \quad (4.14a)$$

$$x \sim y - \frac{2}{p_n} \tanh (\xi_n + \delta_n^{(+)}) - 4 \sum_{j=1}^{n-1} \frac{1}{p_j} - \frac{2}{p_n} + c, \quad (4.14b)$$

with

$$\delta_n^{(+)} = \sum_{j=1}^{n-1} \ln \left( \frac{p_n - p_j}{p_n + p_j} \right)^2. \quad (4.14c)$$

Let  $x_c$  be the center position of the  $n$ th loop soliton in the  $(x, t)$  coordinate system. It then follows from (4.13) and (4.14) that

$$x_c + c_n t - x_{n0} \sim -\frac{\delta_n^{(-)}}{p_n} - 4 \sum_{j=n+1}^N \frac{1}{p_j} + d_n, \quad (t \rightarrow -\infty) \quad (4.15a)$$

$$x_c + c_n t - x_{n0} \sim -\frac{\delta_n^{(+)}}{p_n} - 4 \sum_{j=1}^{n-1} \frac{1}{p_j} + d_n, \quad (t \rightarrow +\infty), \quad (4.15b)$$

where  $x_{n0} = -\xi_{n0}/p_n$  and  $d_n = c - 2/p_n$  are phase constants. In view of the fact that all the loop solitons propagate to the left, we can define the phase shift of the  $n$ th loop soliton as

$$\Delta_n = x_c(t \rightarrow -\infty) - x_c(t \rightarrow +\infty). \quad (4.16)$$

This quantity is evaluated using (4.13c), (4.14c) and (4.15) to give

$$\begin{aligned} \Delta_n = & \frac{1}{p_n} \left\{ \sum_{j=1}^{n-1} \ln \left( \frac{p_n - p_j}{p_n + p_j} \right)^2 - \sum_{j=n+1}^N \ln \left( \frac{p_n - p_j}{p_n + p_j} \right)^2 \right\} \\ & + 4 \left( \sum_{j=1}^{n-1} \frac{1}{p_j} - \sum_{j=n+1}^N \frac{1}{p_j} \right), \quad (n = 1, 2, \dots, N). \end{aligned} \quad (4.17)$$

Note that the first term on the right-hand side of (4.17) coincides with the formula for the phase shift arising from the interaction of  $N$  kinks of the sG equation. On the other hand, the second term arises due to the coordinate transformation (3.3). The latter changes the characteristics of the interaction process of loop solitons substantially when compared with those of the sG kinks.

### 4.2.3 2-loop soliton solution

The  $\tau$ -functions  $f$  and  $f'$  for the 2-loop soliton solution are written as

$$f = 1 + ie^{\xi_1} + ie^{\xi_2} - \gamma e^{\xi_1 + \xi_2}, \quad (4.18a)$$

and  $f' = f^*$  with

$$\gamma = \left( \frac{p_1 - p_2}{p_1 + p_2} \right)^2. \quad (4.18b)$$

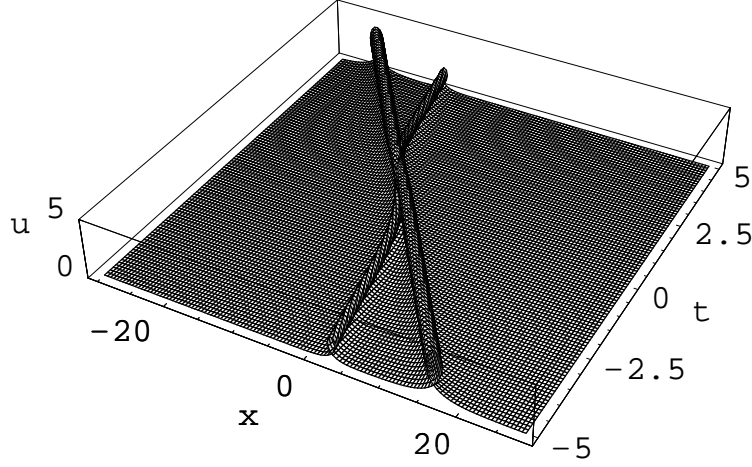

**Fig. 2:** The interaction of two loop solitons.

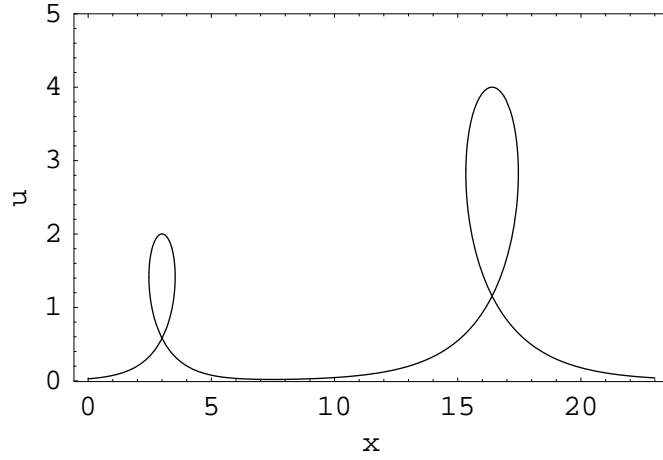

**Fig. 3:** The profile of the 2-loop soliton solution.

The parametric representation of the solution is then given by (4.5), (4.6) and (4.18). It reads

$$u(y, t) = \frac{2\sqrt{\gamma} (p_1 + p_2) \cosh \psi_1 \cosh \psi_2 + (p_1 - p_2) \sinh \psi_1 \sinh \psi_2}{p_1 p_2 \cosh^2 \psi_1 + \gamma \sinh^2 \psi_2}, \quad (4.19a)$$

$$x(y, t) = y + \frac{1}{p_1 p_2} \frac{(p_1 - p_2) \sinh 2\psi_1 - \gamma (p_1 + p_2) \sinh 2\psi_2}{\cosh^2 \psi_1 + \gamma \sinh^2 \psi_2} - \frac{2(p_1 + p_2)}{p_1 p_2} + c, \quad (4.19b)$$

where we have put

$$\psi_1 = \frac{1}{2}(\xi_1 - \xi_2), \quad \psi_2 = \frac{1}{2}(\xi_1 + \xi_2) + \frac{1}{2} \ln \gamma, \quad (4.19c)$$

for simplicity. The positive parameters  $p_1$  and  $p_2$  are assumed to satisfy the condition  $p_2 > p_1$ . Figure 2 shows the interaction of two loop solitons with the parameters given by  $p_1 = 0.5, p_2 = 1.0, c = \xi_{10} = \xi_{20} = 0$ .

Figure 3 shows the profile of the 2-loop soliton solution at  $t = -5$  with the same parameters as those of Fig. 2. For the 2-loop soliton case, formulas (4.17) for the phase shift are written as

$$\Delta_1 = -\frac{1}{p_1} \ln \left( \frac{p_1 - p_2}{p_1 + p_2} \right)^2 - \frac{4}{p_2}, \quad (4.20a)$$

$$\Delta_2 = \frac{1}{p_2} \ln \left( \frac{p_1 - p_2}{p_1 + p_2} \right)^2 + \frac{4}{p_1}. \quad (4.20b)$$

Figure 4 plots  $p_1\Delta_1$  and  $p_1\Delta_2$  as a function of  $s(\equiv p_1/p_2)$ . Thus, the large loop soliton always exhibits a positive phase shift whereas the small one exhibits a positive phase shift for  $0 < s < s_c$  and a negative phase shift for  $s_c < s < 1$  where  $s_c$  is a solution of the transcendental equation  $\Delta_2 = 0$  and is given by  $s_c = 0.834$ .

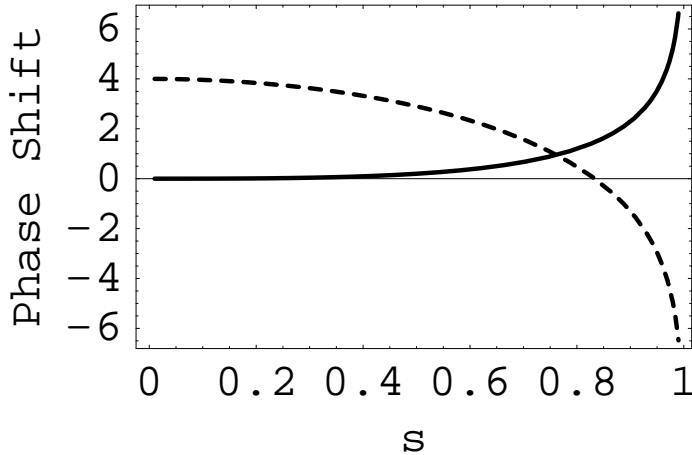

**Fig. 4:** The phase shift  $p_1\Delta_1$  and  $p_1\Delta_2$  as a function of  $s$ . The solid (broken) line represents the phase shift of the large (small) loop soliton.

#### 4.2.4 Loop-antiloop soliton solution

The solution representing the interaction of a loop soliton and an antiloop soliton arises if we choose  $p_1 > 0$  and  $p_2 < 0$  with  $p_1 < |p_2|$  in the 2-soliton  $\tau$ -function (4.2). The parametric solution takes exactly the same form as that of the 2-loop soliton solution (4.19).

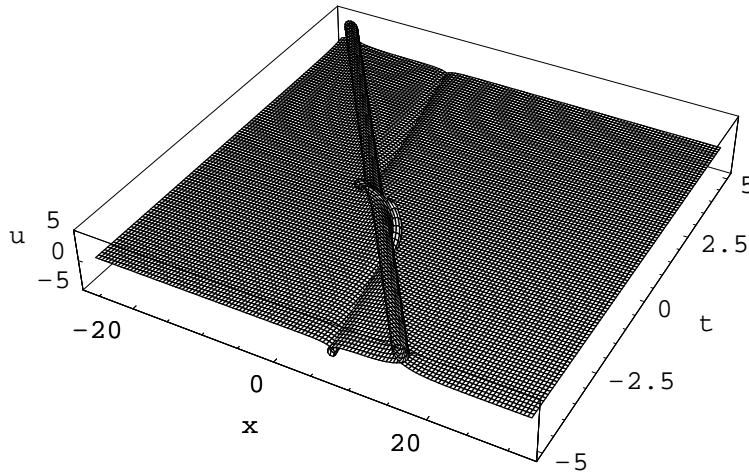

**Fig. 5:** The interaction of a loop soliton and an antiloop soliton.

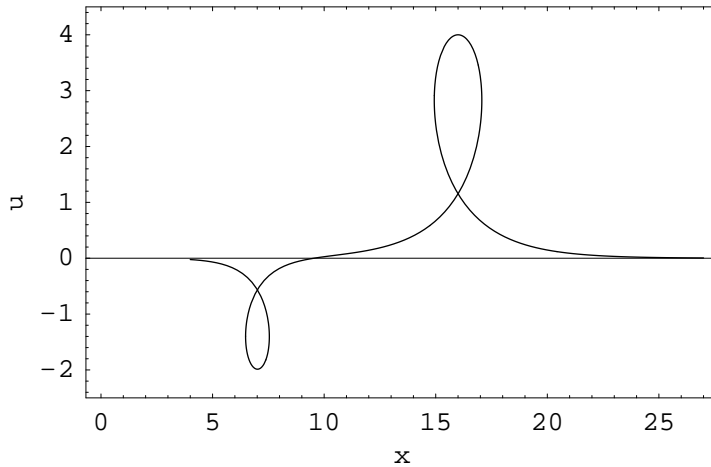

**Fig. 6:** The profile of the loop-antiloop soliton solution.

The formulas for the phase shift are given by

$$\Delta_1 = \frac{1}{p_1} \ln \left( \frac{p_1 - p_2}{p_1 + p_2} \right)^2 + \frac{4}{p_2}, \quad (4.21a)$$

$$\Delta_2 = \frac{1}{p_2} \ln \left( \frac{p_1 - p_2}{p_1 + p_2} \right)^2 + \frac{4}{p_1}. \quad (4.21b)$$

Notice that the formula for  $\Delta_1$  is altered when compared with (4.20a). Figure 5 shows the interaction of a loop soliton and an antiloop soliton with the parameters given by  $p_1 = 0.5, p_2 = -1.0, c = \xi_{10} = \xi_{20} = 0$  and Figure 6 shows the profile of the solution at  $t = -5$ .

### 4.3 Breather solutions

#### 4.3.1 1-breather solution

The breather solution of the sG equation is the bound state of the kink and antikink solutions. Under certain condition, the breather solution is shown to yield a nonsingular oscillating pulse solution of the SP equation, which we shall term the breather solution as well. The 1-breather solution of the SP equation is derived if we put  $N = 2$  in (4.2) and specify the parameters as

$$p_1 = a + ib, \quad p_2 = a - ib, \quad (4.22a)$$

$$\xi_{10} = \lambda + i\mu, \quad \xi_{20} = \lambda - i\mu, \quad (4.22b)$$

where  $a$  and  $b$  are positive constants and  $\lambda$  and  $\mu$  are real constants. Then, (4.2) gives

$$f = 1 + ie^{\xi_1} + ie^{\xi_1^*} + \left( \frac{b}{a} \right)^2 e^{\xi_1 + \xi_1^*}, \quad (4.23a)$$

and  $f' = f^*$  where  $\xi_1 = \theta + i\chi$  with

$$\theta = a \left( y + \frac{1}{a^2 + b^2} t \right) + \lambda, \quad (4.23b)$$

$$\chi = b \left( y - \frac{1}{a^2 + b^2} t \right) + \mu. \quad (4.23c)$$

Substituting (4.23) into (4.5) and (4.6), we obtain the following parametric representation of the solution

$$u(y, t) = \frac{4ab}{a^2 + b^2} \frac{b \sin \chi \cosh \left( \theta + \ln \frac{b}{a} \right) - a \cos \chi \sinh \left( \theta + \ln \frac{b}{a} \right)}{b^2 \cosh^2 \left( \theta + \ln \frac{b}{a} \right) + a^2 \cos^2 \chi}, \quad (4.24a)$$

$$x(y, t) = y - \frac{2ab}{a^2 + b^2} \frac{a \sin 2\chi + b \sinh 2\left(\theta + \ln \frac{b}{a}\right)}{b^2 \cosh^2\left(\theta + \ln \frac{b}{a}\right) + a^2 \cos^2 \chi} - \frac{4a}{a^2 + b^2} + c. \quad (4.24b)$$

Note that  $u$  has two different phase variables  $\theta$  and  $\chi$ . The phase  $\theta$  characterizes the envelope of the breather whereas the phase  $\chi$  governs the internal oscillation. In general, the solution (4.24) would exhibit singularities. Unlike the loop soliton solutions, the solution becomes a nonsingular function of  $x$  and  $t$  if we impose a condition for the parameters  $a$  and  $b$ . To see this, we apply the criterion (4.8) to the  $\tau$ -function (4.2) to obtain

$$-\sqrt{2} + 1 < \frac{a}{b} \frac{\cos \chi}{\cosh\left(\theta + \ln \frac{b}{a}\right)} < \sqrt{2} - 1. \quad (4.25a)$$

This inequality must be satisfied for any value of  $\theta$  and  $\chi$ . Since  $a > 0$  and  $b > 0$ , we see from (4.25) that the condition imposed on the parameters turns out to be

$$0 < a/b < \sqrt{2} - 1. \quad (4.25b)$$

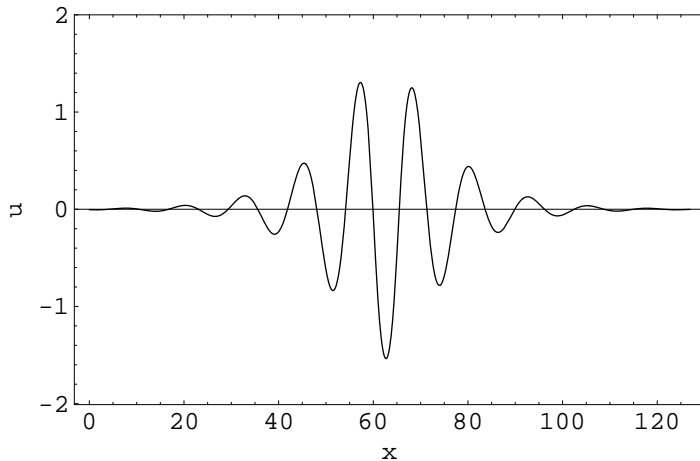

**Fig. 7:** The profile of the nonsingular 1-breather solution.

Figure 7 shows a profile of the 1-breather solution at  $t = 0$  with the parameters  $a = 0.1, b = 0.5, c = 80, \lambda = \mu = 0$ . In this example,  $a/b = 0.2$  so that there appear no singularities as expected from the criterion (4.25b). For completeness, it will be instructive to present a singular breather solution. Figure 8 shows an example of the singular solution with the parameters  $a = 0.4, b = 0.5, c = 20, \lambda = \mu = 0$ . Obviously, the criterion for the nonsingular solution is violated.



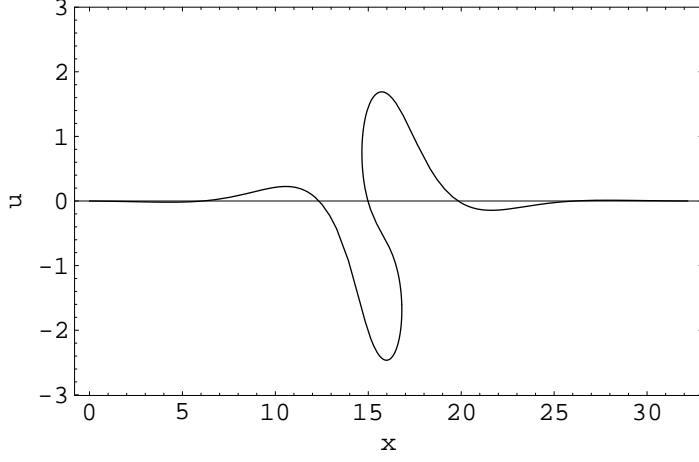

**Fig. 8:** The profile of the singular 1-breather solution.

### 4.3.2 $M$ -breather solution

The general  $M$ -breather solution is constructed from the  $M$ -breather solution of the sG equation (4.1) and (4.2) with  $N = 2M$ . Specifically, we set

$$p_{2j-1} = p_{2j}^* \equiv a_j + ib_j, \quad a_j > 0, \quad b_j > 0, \quad (j = 1, 2, \dots, M), \quad (4.26a)$$

$$\xi_{2j-1,0} = \xi_{2j,0}^* \equiv \lambda_j + i\mu_j, \quad (j = 1, 2, \dots, M), \quad (4.26b)$$

and write the phase variables  $\xi_{2j-1}$  and  $\xi_{2j}$  as

$$\xi_{2j-1} = \theta_j + i\chi_j, \quad (j = 1, 2, \dots, M), \quad (4.27a)$$

$$\xi_{2j} = \theta_j - i\chi_j, \quad (j = 1, 2, \dots, M), \quad (4.27b)$$

with

$$\theta_j = a_j(y + c_j t) + \lambda_j, \quad (j = 1, 2, \dots, M), \quad (4.27c)$$

$$\chi_j = b_j(y - c_j t) + \mu_j, \quad (j = 1, 2, \dots, M), \quad (4.27d)$$

$$c_j = \frac{1}{a_j^2 + b_j^2}, \quad (j = 1, 2, \dots, M). \quad (4.27e)$$

The parametric solution (4.5) and (4.6) with (4.26) and (4.27) describes multiple collisions of  $M$  breathers provided that certain condition is imposed on the parameters  $a_j$  and  $b_j$  ( $j = 1, 2, \dots, M$ ). In the present  $M$ -breather case, the simple inequality like (4.25b) is still difficult to obtain. However, as shown below,

the  $M$ -breather solution splits into  $M$  single breathers as  $t \rightarrow \pm\infty$ . Hence, one can expect that the condition corresponding to (4.25b) would become

$$0 < \sum_{j=1}^M \frac{a_j}{b_j} < \sqrt{2} - 1. \quad (4.28)$$

It will be demonstrated later that the 2-breather solution exists whose parameters indeed satisfy the inequality (4.28).

Let us now investigate the structure of the  $M$ -breather solution by focusing on the asymptotic behavior for large time. To this end, we order the magnitude of the velocity of each breather as  $c_1 > c_2 > \dots > c_M$ . We take the limit  $t \rightarrow -\infty$  with  $\theta_n$  being fixed. Then, we see that  $u$  and  $x$  have the leading-order asymptotics

$$u(y, t) \sim \frac{4a_n b_n}{a_n^2 + b_n^2} \frac{G_n}{F_n}, \quad (4.29a)$$

$$x(y, t) \sim y - \frac{2a_n b_n}{a_n^2 + b_n^2} \frac{H_n}{F_n} - \frac{4a_n}{a_n^2 + b_n^2} + d, \quad (4.29b)$$

with

$$F_n = b_n^2 \cosh^2 \left( \theta_n + \alpha_n^{(-)} + \ln \frac{b_n}{a_n} \right) + a_n^2 \cos^2 (\chi_n + \beta_n^{(-)}), \quad (4.29c)$$

$$\begin{aligned} G_n &= b_n \sin (\chi_n + \beta_n^{(-)}) \cosh \left( \theta_n + \alpha_n^{(-)} + \ln \frac{b_n}{a_n} \right) \\ &\quad - a_n \cos (\chi_n + \beta_n^{(-)}) \sinh \left( \theta_n + \alpha_n^{(-)} + \ln \frac{b_n}{a_n} \right), \end{aligned} \quad (4.29d)$$

$$H_n = a_n \sin 2 (\chi_n + \beta_n^{(-)}) + b_n \sinh 2 \left( \theta_n + \alpha_n^{(-)} + \ln \frac{b_n}{a_n} \right), \quad (4.29e)$$

where the real parameters  $\alpha_n^{(-)}$  and  $\beta_n^{(-)}$  are defined by the relation

$$\sum_{j=2n+1}^{2M} \ln \left( \frac{p_{2n-1} - p_j}{p_{2n-1} + p_j} \right)^2 = \alpha_n^{(-)} + i\beta_n^{(-)}. \quad (4.30a)$$

The explicit expressions of  $\alpha_n^{(-)}$  and  $\beta_n^{(-)}$  in terms of  $a_j$  and  $b_j$  are calculated using (4.26a). They read

$$\alpha_n^{(-)} = \sum_{j=n+1}^M \ln \frac{\{(a_n - a_j)^2 + (b_n - b_j)^2\} \{(a_n - a_j)^2 + (b_n + b_j)^2\}}{\{(a_n + a_j)^2 + (b_n + b_j)^2\} \{(a_n + a_j)^2 + (b_n - b_j)^2\}}, \quad (4.30b)$$

$$\beta_n^{(-)} = 2 \sum_{j=n+1}^M \left( \tan^{-1} \frac{b_n - b_j}{a_n - a_j} + \tan^{-1} \frac{b_n + b_j}{a_n - a_j} - \tan^{-1} \frac{b_n + b_j}{a_n + a_j} - \tan^{-1} \frac{b_n - b_j}{a_n + a_j} \right). \quad (4.30c)$$

As  $t \rightarrow +\infty$ ,  $u$  and  $x$  take the same asymptotic forms as (4.29) with  $\alpha_n^{(-)}$  and  $\beta_n^{(-)}$  replaced by  $\alpha_n^{(+)}$  and  $\beta_n^{(+)}$ , respectively where

$$\sum_{j=1}^{2n-2} \ln \left( \frac{p_{2n-1} - p_j}{p_{2n-1} + p_j} \right)^2 = \alpha_n^{(+)} + i\beta_n^{(+)}. \quad (4.31)$$

The expressions of  $\alpha_n^{(+)}$  and  $\beta_n^{(+)}$  corresponding to (4.30b,c) follow if one replaces the sum  $\sum_{j=n+1}^M$  by  $\sum_{j=1}^{n-1}$  in (4.30b,c). Observing the asymptotic behavior of the solution in the rest frame of reference, we see that it represents a superposition of  $M$  breathers, each has a form given by (4.24a). The effect of the interaction is the phase shift given by the sum of the quantities  $\alpha_n^{(\pm)}$  and  $\beta_n^{(\pm)}$  which is caused by the pair wise collisions of  $M$  breathers and a term due to the coordinate transformation.

The formula for the total phase shift will not be defined definitely since the solution takes the form of wave packets. If we consider the small-amplitude limit, however, the oscillating part and the envelope are shown to be separated completely so that one can obtain the formula like (4.17) for the  $N$ -loop soliton solution. Actually, in the small-amplitude limit  $a_n \rightarrow 0$  ( $n = 1, 2, \dots, M$ ), expressions (4.29) and (4.30) are approximated by

$$u(y, t) \sim \frac{4a_n}{b_n^2} \frac{\sin \left( \chi_n + \beta_n^{(-)} \right)}{\cosh \left( \theta_n + \alpha_n^{(-)} + \ln \frac{b_n}{a_n} \right)}, \quad (4.32a)$$

$$x(y, t) \sim y - \frac{4a_n}{b_n^2} \tanh \left( \theta_n + \alpha_n^{(-)} + \ln \frac{b_n}{a_n} \right) - \frac{4a_n}{b_n^2} + c, \quad (4.32b)$$

$$\alpha_n^{(-)} \sim - \sum_{j=n+1}^M \frac{8(b_n^2 + b_j^2)a_j a_n}{(b_n^2 - b_j^2)^2}, \quad (4.33a)$$

$$\beta_n^{(-)} \sim \sum_{j=n+1}^M \frac{8a_j b_n}{b_n^2 - b_j^2}. \quad (4.33b)$$

Let  $\bar{\Delta}_n$  be the phase shift of the center position ( a point corresponding to the maximum amplitude) of the envelope for the  $n$ th breather. By performing the asymptotic analysis similar to that for the  $N$ -loop soliton case, we find that

$$\bar{\Delta}_n = \sum_{j=n+1}^M \frac{8(b_n^2 + b_j^2)a_j}{(b_n^2 - b_j^2)^2} - \sum_{j=1}^{n-1} \frac{8(b_n^2 + b_j^2)a_j}{(b_n^2 - b_j^2)^2}, \quad (n = 1, 2, \dots, M). \quad (4.34)$$

### 4.3.3 2-breather solution

The solution describing the interaction of two breathers is parameterized by (4.26) and (4.27) with  $M = 2$ . Since the parametric solution has a lengthy expression, it is not appropriate to write it down here. Instead, we show the time evolution of the solution graphically and demonstrate its solitonic behavior. Fig. 9 depicts the profile of the two-breather solution for three different times (a)  $t = -40$ , (b)  $t = -5$ , (c)  $t = 35$ . The values of the parameters are chosen as  $a_1 = 0.1, b_1 = 0.5, a_2 = 0.16, b_2 = 0.8, \lambda_1 = \lambda_2 = 0, \mu_1 = \mu_2 = 0$ . The velocity of the large breather is 3.85 while that of the small breather is 1.50 (see (4.27e)). Note in this example  $\sum_{j=1}^2 (a_j/b_j) = 0.4$  so that the inequality (4.28) is satisfied. For large negative time, the solution behaves like two independent breathers, each has a form given by (4.24) and propagates to the left. As time goes, both breathers merge and then they separate each other with leaving the original wave profiles. Apparently, the present example exhibits a typical feature common to the interaction of two-soliton solutions.

(a)

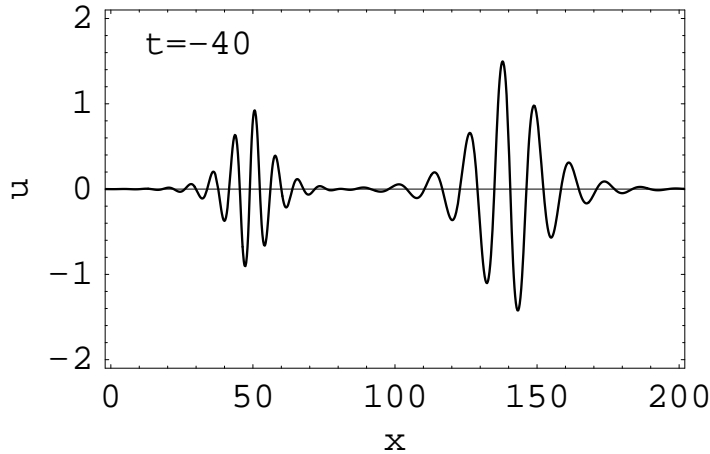

(b)

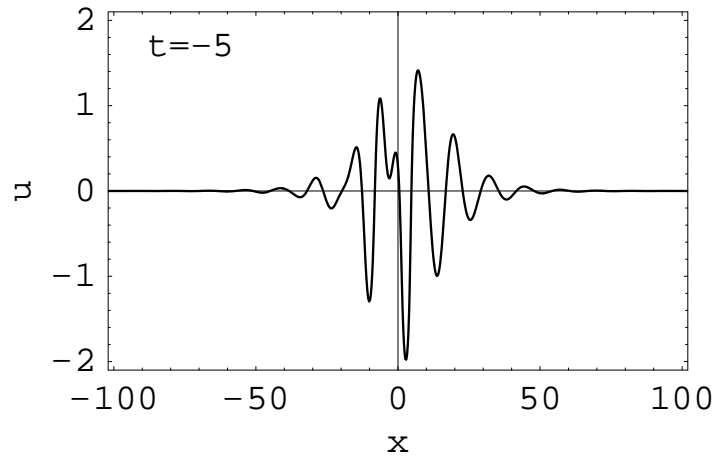

(c)

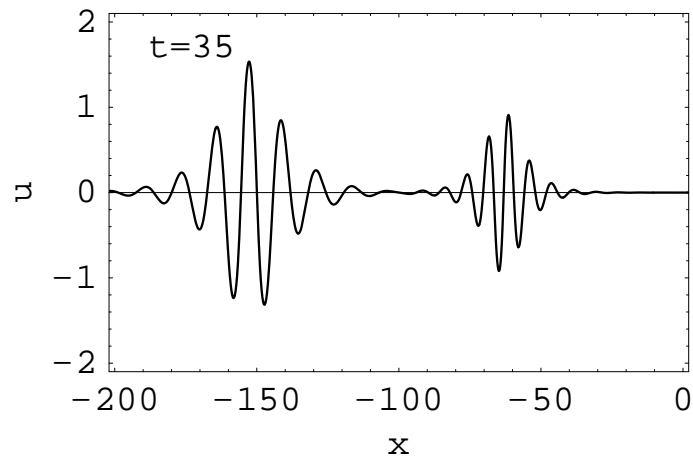

**Fig. 9:** The profile of the 2-breather solution for (a)  $t = -40$ , (b)  $t = -5$ , and (c)  $t = 35$ .

#### 4.4 Remark

The 1- and 2-loop soliton solutions as well as the 1-breather solution have been obtained by different methods [14, 15].

## 5 PERIODIC SOLUTIONS

### 5.1 1-phase solutions

The periodic solutions of the SP equation can be constructed by using an exact method of solution described in Sec. 3 [16]. Here, we deal with solutions which depend on the single variable  $\eta$ . Then, the sG equation (3.11) reduces to an ODE for  $\phi$

$$\phi'' = -\sin \phi, \quad (5.1)$$

where the prime appended to  $\phi$  denotes the differentiation with respect to  $\eta$ . There exist several particular solutions of Eq. (5.1). Among them, we look for solutions expressed by Jacobi's elliptic functions. Correspondingly, these solutions yield the 1-phase solutions of the SP equation. We investigate the properties of the solutions by the following two examples.

### 5.1.1 Example 1

The first example of the solution of Eq. (5.1) is given by Jacobi's sn function. Explicitly

$$\phi = -2 \sin^{-1} \operatorname{sn} \left( \frac{\eta}{k}, k \right), \quad (5.2)$$

where the parameter  $k$  is the modulus of the elliptic function. Substituting (5.2) into (3.12) gives the parametric representation of  $u$

$$u = \frac{2}{ka} \operatorname{dn} \left( \frac{\eta}{k}, k \right), \quad (5.3)$$

where  $\operatorname{dn}(u, k)$  is Jacobi's dn function. If we introduce the relation  $\cos \phi = 1 - 2 \operatorname{sn}^2 \left( \frac{\eta}{k}, k \right)$  which is derived from (5.2) into (3.14), we obtain

$$x = y - 2 \int \operatorname{sn}^2 \left( \frac{\eta}{k}, k \right) dy + c. \quad (5.4)$$

One can see that the integration constant depends on  $t$  whose time evolution is determined by the second equation of (3.13) with  $u$  given by (5.3). Indeed, using the identity

$$k^2 \operatorname{sn}^2 \left( \frac{\eta}{k}, k \right) + \operatorname{dn}^2 \left( \frac{\eta}{k}, k \right) = 1, \quad (5.5)$$

we obtain an ODE for  $c$ ,  $c'(t) = -2/(ka)^2$ . This equation can be integrated immediately to give

$$c(t) = -\frac{2}{(ka)^2}t + d, \quad (5.6)$$

where  $d$  is an integration constant. Substituting (5.5) and (5.6) into (5.4) and rearranging terms, we find a parametric representation of  $x$

$$x + \frac{2 - k^2}{(ak)^2}t - x_0 = \frac{1}{ak} \left\{ -\frac{1}{k}(2 - k^2)\eta + 2E \left( \frac{\eta}{k}, k \right) \right\} + d, \quad (5.7)$$

where  $x_0 = -\eta_0/a$  and  $E(u, k)$  is the elliptic integral of the second kind defined by [17]

$$E(u, k) = \int_0^u \text{dn}^2 v \, dv = \int_0^\tau \sqrt{\frac{1 - k^2 t^2}{1 - t^2}} dt, \quad (t = \text{sn } v, \tau = \text{sn } u). \quad (5.8)$$

Thus, (5.3) and (5.7) give the parametric solution of the 1-phase solution. This solution becomes a multi-valued function. In fact, applying the criterion (3.15) to (5.2), we see that  $u_x$  exhibits singularity when  $\text{sn}(\eta/k, k) = \pm 1/\sqrt{2}$ . To investigate the properties of the solution, it is convenient to take the amplitude and the modulus as independent parameters. The amplitude  $A$  of the wave may be defined by the relation  $A = (u_{\max} - u_{\min})/2$  where  $u_{\max}$  and  $u_{\min}$  are the maximum and minimum values of  $u$ , respectively. In the present example, it follows from (5.3) that

$$A = \frac{1 - \sqrt{1 - k^2}}{ka}, \quad (5.9)$$

which enables us to express the parameter  $a$  in terms of  $A$  and  $k$ . The velocity  $V$  and the wavelength  $\Lambda$  of the wave are then given respectively by

$$V = \frac{2 - k^2}{(ak)^2} = \frac{(2 - k^2)A^2}{(1 - \sqrt{1 - k^2})^2}, \quad (5.10)$$

$$\Lambda = \frac{2A}{1 - \sqrt{1 - k^2}} \{(2 - k^2)K(k) - 2E(k)\}, \quad (5.11)$$

where  $K(k)$  and  $E(k)$  are the complete elliptic integrals of the first and second kinds, respectively. In deriving (5.11), we have used (5.7) and the periodicity relation

$$E(u + 2K(k), k) = E(u, k) + 2E(k). \quad (5.12)$$

The wavenumber  $K$  (which should not be confused with  $K(k)$ ) and the angular frequency  $W$  are defined respectively by  $K = 2\pi/\Lambda$  and  $W = VK$ . The limiting forms of these wave parameters for  $k \rightarrow 0$  and  $k \rightarrow 1$  are given respectively by

$$K \sim \frac{8}{Ak^2}, \quad V \sim \frac{8A^2}{k^4}, \quad W \sim \frac{64A^2}{k^6}, \quad (k \rightarrow 0), \quad (5.13a)$$

$$K \sim \frac{2\pi}{A} \frac{1}{\ln \frac{8}{1-k}}, \quad V \sim A^2, \quad W \sim \frac{2\pi A}{\ln \frac{8}{1-k}}, \quad (k \rightarrow 1). \quad (5.13b)$$

It follows from (5.13) that

$$W \sim A^2 K \quad (K \rightarrow 0), \quad (5.14a)$$

$$W \sim A^5 K^3 / 8 \quad (K \rightarrow \infty). \quad (5.14b)$$

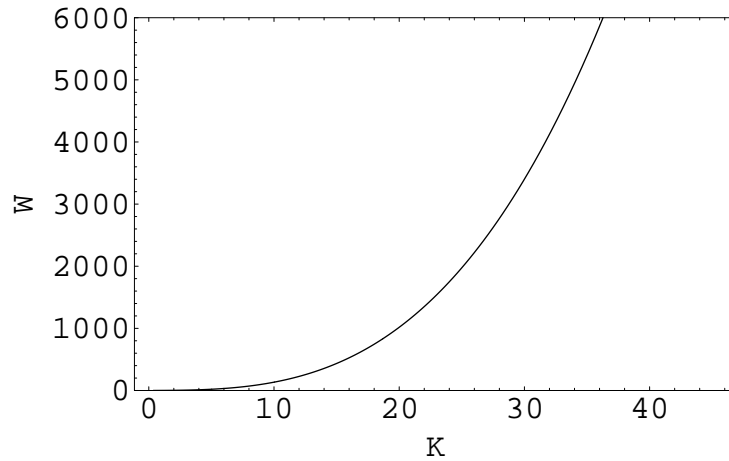

**Fig. 10:** The dispersion relation  $W = W(K, A)$  with  $A = 1.0$  for Example 1 as a function of  $K$ .

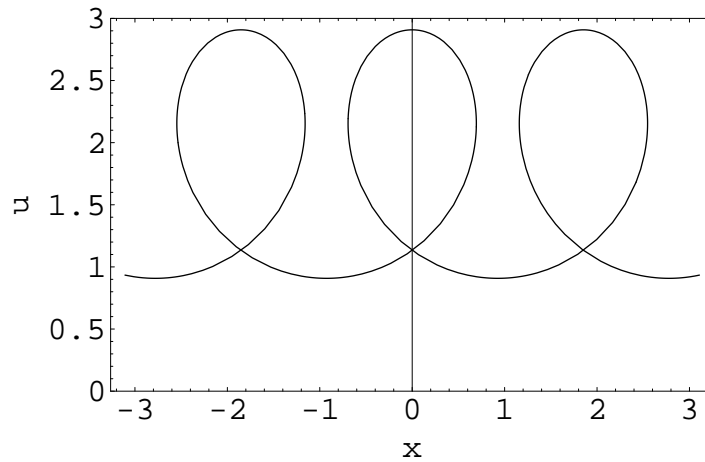

**Fig. 11:** A typical profile of the periodic solution for Example 1.

The dispersion relation  $W = W(K, A)$  with  $A = 1.0$  is plotted in Fig. 10 as a function of  $K$ . Figure 11 illustrates the typical profile of the periodic



solution represented by (5.3) and (5.7) where the parameters are chosen as  $A = 1.0, k = 0.95, x_0 = d = \eta_0 = 0$  and the time  $t$  is set to zero. In this example, one can see that the period  $\Lambda$  is 1.853. The figure represents a periodic loop traveling to the left at a constant velocity  $V = 2.320$ .

When the wavelength of the periodic wave becomes very long, it degenerates into a single loop soliton, as we shall now demonstrate. As seen from (5.13), the long-wave limit  $\Lambda \rightarrow \infty$  (or  $K \rightarrow 0$ ) is attained when  $k$  tends to 1. Using the relations  $\text{dn}(u, 1) = \text{sech } u$  and  $E(u, 1) = \tanh u$ , the parametric solution represented by (5.3) and (5.7) reduces respectively to

$$u = 2A \text{sech } \eta, \quad (5.15a)$$

$$x + A^2 t + x_0 = -A\eta + 2A \tanh \eta + d, \quad (5.15b)$$

with  $\eta = y/A - At + \eta_0$ . We see from this expression that the limiting solution is essentially the same as that of the 1-loop soliton solution given by (4.10a) and (4.11). See Fig. 1.

### 5.1.2 Example 2

The second example of the solution of Eq. (5.1) is given by Jacobi's dn function

$$\phi = -2 \cos^{-1} \text{dn}(\eta, k). \quad (5.16)$$

The parametric representation of the solution can be written in the form

$$u = \frac{2k}{a} \text{cn}(\eta, k), \quad (5.17a)$$

$$x - \frac{1}{a^2}(1 - 2k^2)t - x_0 = \frac{1}{a} \{-\eta + 2E(\eta, k)\} + d, \quad (5.17b)$$

where  $\text{cn}(\eta, k)$  is Jacobi's cn function. This solution is characterized by the wave parameters

$$A = \frac{2k}{a}, \quad (5.18)$$

$$V = \frac{1}{a^2}(1 - 2k^2) = \frac{A^2}{4k^2}(1 - 2k^2), \quad (5.19)$$

$$\Lambda = \frac{2A}{k} | -K(k) + 2E(k) |. \quad (5.20)$$

Figure 12 shows the dispersion relation  $W = W(K, A)$  with  $A = 1.0$ .

The dispersion curve has two branches depending on the value of  $k$ . The upper branch plotted by the solid line corresponds to the dispersion relation

for  $0 \leq k \leq k_c$  whereas the lower one (broken line) represents the dispersion relation for  $k_c < k \leq 1$  where  $k_c (= 0.9089)$  is a solution of the transcendental equation  $K(k) = 2E(k)$ . Note that the wavelength  $\Lambda$  becomes zero when  $k = k_c$ .

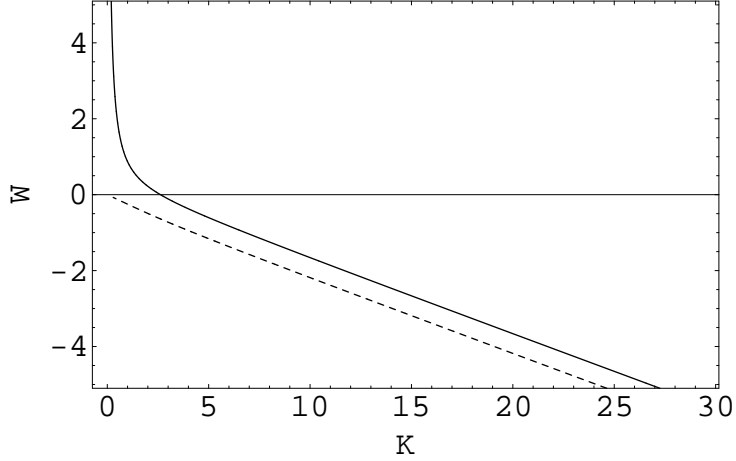

**Fig. 12:** The dispersion relation  $W = W(K, A)$  with  $A = 1.0$  for Example 2 as a function of  $K$ .

The limiting forms of the wave parameters for both  $k \rightarrow 0$  and  $k \rightarrow 1$  are given respectively by

$$K \sim \frac{2k}{A}, \quad V \sim \frac{A^2}{4k^2}, \quad W \sim \frac{A}{2k}, \quad (k \rightarrow 0). \quad (5.21a)$$

$$K \sim \frac{2\pi}{A} \frac{1}{\ln \frac{8}{1-k}}, \quad V \sim -\frac{A^2}{4}, \quad W \sim -\frac{\pi A}{2 \ln \frac{8}{1-k}}, \quad (k \rightarrow 1). \quad (5.21b)$$

We see from (5.21) that  $W \sim 1/K$  ( $K \rightarrow 0$ ) for the upper branch and  $K \sim -A^2 K/4$  ( $K \rightarrow 0$ ) for the lower branch. As  $K \rightarrow \infty$ , both branches approach a straight line  $W = -V_c K$  with  $V_c = (2k_c^2 - 1)A^2/(4k_c^2) \simeq 0.1974A^2$ . It is easy to see that the parametric solution (5.17) becomes a single-valued function when  $k$  lies in the range  $0 < k < 1/\sqrt{2}$ . Note that the upper limit of this inequality coincides with the value of the modulus  $k$  for which the velocity given by (5.19) becomes zero. Figure 13 illustrates the profile of the nonsingular periodic solution at  $t = 0$  with the parameters  $A = 1.0, k = 0.65, x_0 = d = \eta_0 = 0$ . In this example,  $\Lambda = 3.027$ . It represents a periodic wavetrain traveling to the right at a constant velocity  $V = 0.0917$ .

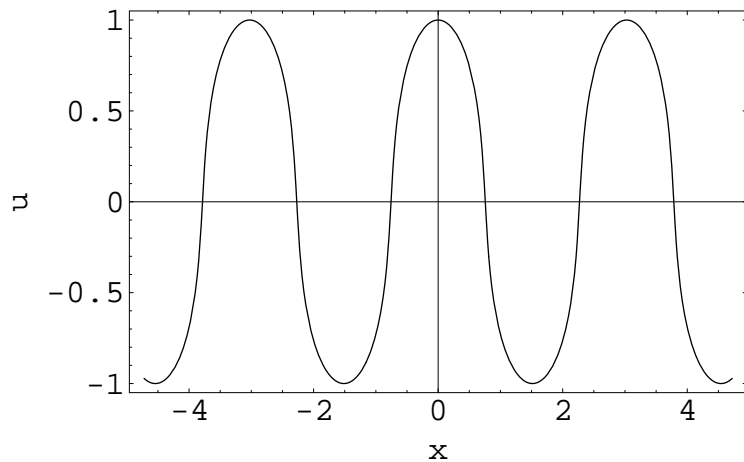

**Fig. 13:** A typical profile of the nonsingular periodic solution for Example 2.

If the parameter  $k$  lies in the range  $1/\sqrt{2} < k < 1$ , the solution exhibits singularities. Figure 14 illustrates the profile of the nonsingular periodic solution at  $t = 0$  with the parameters  $A = 1.0, k = 0.8, x_0 = d = \eta_0 = 0$ . In this example,  $\Lambda = 1.394$ . It represents a periodic wavetrain traveling to the left at a constant velocity  $V = 0.1094$ .

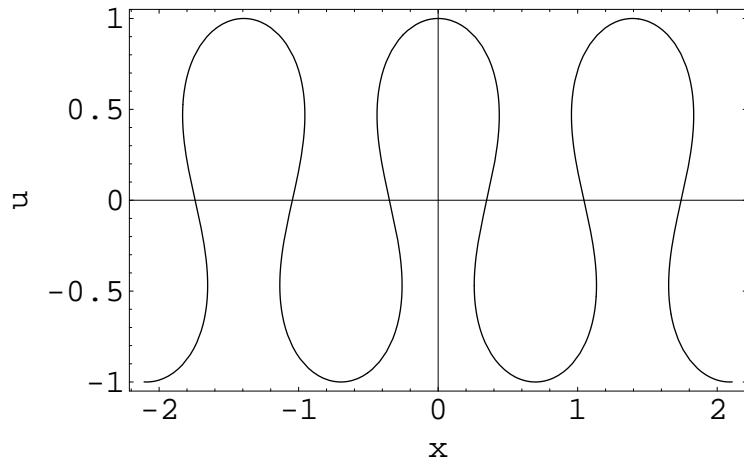

**Fig. 14:** A typical profile of the singular periodic solution for Example 2.

In conclusion, it will be worthwhile to consider the small amplitude limit of the solution. As suggested by the asymptotic relations (5.21a), the appropriate

limiting procedure is taken by the limit  $k \rightarrow 0$  while keeping the values of  $K, V$  and  $W$  finite. It turns out that the magnitude of the amplitude  $A$  is of order  $k$ . If we substitute the relations  $\text{cn}(\eta, 0) = \cos \eta$  and  $E(\eta, 0) = \eta$  into (5.17), the limiting form of the solution can be written as

$$u = A \cos \left( ax - \frac{t}{a} - b \right), \quad (5.22)$$

where  $b = a(x_0 + d)$  is a phase constant. The dispersion relation of this linear wave is given by  $W = 1/K$  as is consistent with the asymptotics (5.21a). We also remark that (5.22) satisfies the linearized SP equation  $u_{xt} = u$ .

## 5.2 2-phase solutions

### 5.2.1 Separation of variables

The general  $N$ -phase solution is now available for the sG equation. See [18], for instance. However, it will be difficult to perform the integral in (3.14) even for the 2-phase solution. An alternative approach for constructing the general  $N$ -phase solutions will be discussed in Sec. 6. Here, we address the following specific form introduced by Lamb [19, 20]

$$\phi = 4 \tan^{-1} \left[ \frac{f(\xi)}{g(\eta)} \right]. \quad (5.23)$$

We substitute (5.23) into the sG equation (3.11) and see that the variables  $\xi$  and  $\eta$  can be separated if  $f$  and  $g$  satisfy the following nonlinear ODEs

$$f'^2 = -\kappa f^4 + \mu f^2 + \nu, \quad (5.24a)$$

$$g'^2 = \kappa g^4 + (\mu - 1)g^2 - \nu, \quad (5.24b)$$

where  $\kappa, \mu$  and  $\nu$  are arbitrary constants. For special choice of these parameters, one can obtain solutions for  $f$  and  $g$  which are expressed in terms of elliptic functions.

If we substitute (5.23) into (3.12), we immediately obtain the parametric representation of  $u$

$$u = \frac{4 f' g + f g'}{a (f^2 + g^2)}. \quad (5.25)$$

On the other hand, it follows from (5.23) by an elementary calculation using formulas of trigonometric functions that

$$\cos \phi = 1 - \frac{8 f^2 g^2}{(f^2 + g^2)^2}. \quad (5.26)$$

The right-hand side of (5.26) can be modified in such a way that the integral in (3.14) can be performed analytically. To this end, we introduce the function  $Y = Y(\xi, \eta)$

$$Y = \frac{c_1(f^2)' + c_2(g^2)'}{f^2 + g^2}, \quad (5.27)$$

where  $c_1$  and  $c_2$  are constants to be determined later. Note that  $Y$  depends on the variables  $y$  and  $t$  through the relation (3.10). Now, we differentiate  $Y$  by  $y$  and use (5.24) to simplify the resultant expression. After some calculations, we obtain

$$Y_y = \frac{a}{(f^2 + g^2)^2} \left[ -2\kappa(c_1 f^6 + 3c_1 f^4 g^2 - 3c_2 f^2 g^4 - c_2 g^6) - 4c_2 f^2 g^2 + 2(c_1 + c_2) \{-2fgf'g' + 2\mu f^2 g^2 - \nu(f^2 - g^2)\} \right]. \quad (5.28)$$

We set  $c_1 + c_2 = 0$  and  $c_1 = -2/a$  to reduce (5.28) in the form

$$Y_y = 4\kappa(f^2 + g^2) - \frac{8f^2 g^2}{(f^2 + g^2)^2}. \quad (5.29)$$

Comparing (5.26) and (5.29), we find that

$$\cos \phi = 1 + Y_y - 4\kappa(f^2 + g^2). \quad (5.30)$$

Finally, we substitute (5.30) into (3.14) and take account of (5.27) with  $c_1 = -c_2 = -2/a$ . Then, the integration with respect to  $y$  can be performed trivially to give the expression of  $x$  in terms of  $f$  and  $g$

$$x = y - \frac{4}{a} \frac{ff' - gg'}{f^2 + g^2} - 4\kappa \int (f^2 + g^2) dy + c. \quad (5.31)$$

The time dependence of  $c$  can be determined by the second equation of (3.13) with  $u$  and  $x$  given respectively by (5.25) and (5.31). It turns out that  $c'(t) = 0$  so that  $c = d(=\text{const.})$ . The expressions (5.25) and (5.31) provide the parametric representation of the the two-phase periodic solutions of the SP equation.

We can obtain several 2-phase periodic solutions depending on the choice of the functions  $f$  and  $g$ . Here, we exemplify three solutions which reduce, in the long-wave limit, to breather solution (Example 1), 2-loop soliton solution (Example 2) and loop-antiloop soliton solution (Example 3).

### 5.2.2 Example 1

The first example of  $f$  and  $g$  assumes the form

$$f(\xi) = A \operatorname{cn}(\beta\xi, k_f), \quad g(\eta) = \frac{1}{\operatorname{cn}(\Omega\eta, k_g)}, \quad (5.32)$$

where  $A$ ,  $\beta$  and  $\Omega$  are positive parameters and  $k_f$  and  $k_g$  are moduli of the elliptic function. If we substitute (5.32) into (5.24), we can determine the parameters  $\kappa$ ,  $\mu$  and  $\nu$  as well as  $k_f$ ,  $k_g$  and  $\Omega$  in terms of  $A$  and  $\beta$ . In particular,

$$k_f^2 = \frac{A^2}{1+A^2} \left( 1 + \frac{1}{\beta^2(1+A^2)} \right), \quad (5.33a)$$

$$k_g^2 = \frac{A^2}{1+A^2} \left( 1 - \frac{1}{\Omega^2(1+A^2)} \right), \quad (5.33b)$$

$$\Omega^2 = \beta^2 + \frac{1-A^2}{1+A^2}, \quad (5.33c)$$

$$\kappa = \frac{\beta^2 k_f^2}{A^2}, \quad \mu = \beta^2(2k_f^2 - 1), \quad \nu = \beta^2 A^2(1 - k_f^2). \quad (5.33d)$$

Note from (5.33) and the inequality  $0 \leq k_f \leq 1$  that the parameter  $\beta$  must be restricted by the condition

$$\frac{A}{\sqrt{1+A^2}} \leq \beta, \quad (5.34)$$

with arbitrary positive  $A$ .

Now, the parametric representation of  $u$  follows from (3.12), (5.23) and (5.32). It reads

$$u = \frac{4A - \beta \operatorname{sn}(\beta\xi, k_f) \operatorname{dn}(\beta\xi, k_f) \operatorname{cn}(\Omega\eta, k_g) + \Omega \operatorname{cn}(\beta\xi, k_f) \operatorname{sn}(\Omega\eta, k_g) \operatorname{dn}(\Omega\eta, k_g)}{a \frac{A^2 \operatorname{cn}^2(\beta\xi, k_f) \operatorname{cn}^2(\Omega\eta, k_g) + 1}{A^2 \operatorname{cn}^2(\beta\xi, k_f) \operatorname{cn}^2(\Omega\eta, k_g) + 1}}. \quad (5.35)$$

The expression of  $x$  is derived by substituting (5.32) into (5.31) as

$$\begin{aligned} x = y + \frac{4\beta}{a} \frac{\operatorname{cn}(\beta\xi, k_f) \operatorname{cn}(\Omega\eta, k_g)}{A^2 \operatorname{cn}^2(\beta\xi, k_f) \operatorname{cn}^2(\Omega\eta, k_g) + 1} & \left\{ A^2 \operatorname{sn}(\beta\xi, k_f) \operatorname{dn}(\beta\xi, k_f) \operatorname{cn}(\Omega\eta, k_g) \right. \\ & \left. - \frac{\beta k_f^2}{\Omega k_g'^2} \operatorname{cn}(\beta\xi, k_f) \operatorname{sn}(\Omega\eta, k_g) \operatorname{dn}(\Omega\eta, k_g) \right\} \\ - \frac{4\beta}{a} \left[ E(\beta\xi, k_f) - k_f'^2 \beta\xi - \frac{\beta k_f^2}{A^2 \Omega k_g'^2} \left\{ E(\Omega\eta, k_g) - k_g'^2 \Omega\eta \right\} \right] + d. \quad (5.36) \end{aligned}$$

Here we have used the following integral formulas for the Jacobi cn function in performing the integral in (5.51)

$$\int \text{cn}^2(u, k) du = \frac{1}{k^2} \left\{ E(u, k) - k'^2 u \right\}, \quad (5.37a)$$

$$\int \frac{1}{\text{cn}^2(u, k)} du = \frac{1}{k'^2} \left\{ \frac{\text{sn}(u, k) \text{dn}(u, k)}{\text{cn}(u, k)} - E(u, k) + k'^2 u \right\}, \quad (5.37b)$$

where  $k' = \sqrt{1 - k^2}$ . Note that  $\int (f^2 + g^2) dy = a^{-1} \int f^2(\xi) d\xi + a^{-1} \int g^2(\eta) d\eta$  by virtue of (3.10).

Let us now describe some properties of the parametric solution given by (5.35) and (5.36). In general,  $u$  is a multiply periodic function of  $x$  for fixed  $t$ . Under certain condition, however, it becomes a simply periodic function. To see this, we define the two parameters  $L_\xi$  and  $L_\eta$  by  $L_\xi \equiv 4K(k_f)/\beta$  and  $L_\eta \equiv 4K(k_g)/\Omega$ . In view of the periodicity of Jacobi's elliptic functions like  $\text{sn}(u + 4K(k), k) = \text{sn}(u, k)$ ,  $L_\xi(L_\eta)$  is the period of  $u$  with respect to  $\xi(\eta)$ . In accordance with the value of  $A$ , there arise two possible cases for the period of  $u$ . When  $0 < A \leq A_c$  ( $A_c \simeq 2.1797$ ), one can show with use of (5.33) that the inequality  $L_\eta < L_\xi$  holds for arbitrary positive values of  $\beta$ , and at fixed  $A$ , both  $L_\xi$  and  $L_\eta$  are monotonically decreasing functions of  $\beta$  and vanish as  $\beta \rightarrow \infty$ . If the ratio of both periods becomes a rational number, i.e.,  $L_\xi/L_\eta = m_\eta/m_\xi$  with  $(m_\xi, m_\eta) = 1$  and  $m_\xi < m_\eta$ , then  $u$  has a period  $L$  with respect to  $y$  given by

$$L = \frac{1}{a} m_\xi L_\xi = \frac{1}{a} m_\eta L_\eta. \quad (5.38)$$

With use of the relation (5.38), the period  $\Lambda$  with respect to  $x$  is determined from (5.36). Indeed, using the periodicity of the elliptic integral of the second kind  $E(u + 2mK(k), k) = E(u, k) + 2mE(k)$  ( $m$  : integer) as well as (5.33) and (5.38), the spatial period is found to be as

$$\Lambda = L \left[ 1 - 4\beta^2 \left\{ \frac{E(k_f)}{K(k_f)} - \frac{k_f^2}{A^2(1 - k_g^2)} \frac{E(k_g)}{K(k_g)} + \frac{1}{\beta^2(1 + A^2)} \right\} \right]. \quad (5.39)$$

When  $A_c < A$ , on the other hand, the equation  $L_\xi = L_\eta$  has a unique solution for  $\beta$  and the corresponding expression of the period is also given by (5.39).

We remark that the solution presented here becomes a single-valued function when the parameter lies in the rang  $0 < A < \sqrt{2} - 1$ . This follows from (4.8) and (5.32) with the aid of the inequality  $|\text{cn}(\beta\xi, k_f)\text{cn}(\Omega\eta, k_g)| \leq 1$ .

Figure 15 depicts a profile of  $u$  at  $t = 0$ . The parameters chosen here are  $A = 0.2, m_\xi = 1, m_\eta = 2, a = 1.0, d = \xi_0 = \eta_0 = 0$ . Solving (5.38) for  $\beta$ , one obtains  $\beta = 0.5832$  so that  $\Omega = 1.124, k_f = 0.3837, k_g = 0.0958, L = 11.21$ . Substituting these values into (5.39), the period  $\Lambda$  is found to be 10.37.

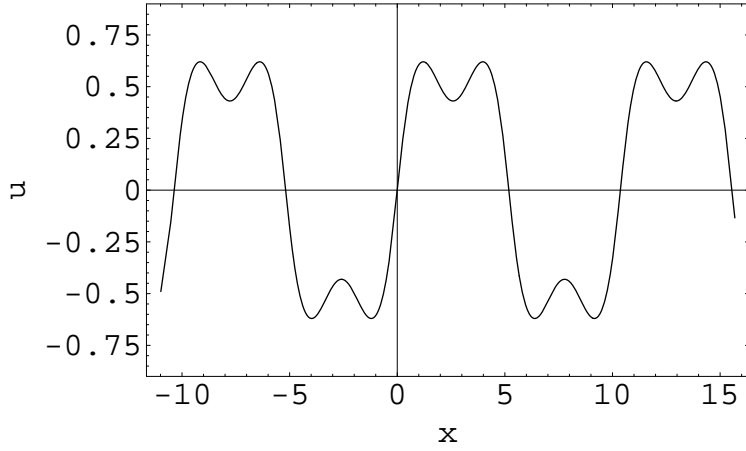

**Fig. 15:** A typical profile of the periodic solution for Example 1.

We now consider the limiting profile of the periodic solution when the period  $\Lambda$  tends to infinity. To be more specific, we take the limits  $k_f \rightarrow 1$  and  $k_g \rightarrow 0$ . It then turns out from (5.33) that  $\beta \rightarrow A/\sqrt{1+A^2}$  and  $\Omega \rightarrow 1/\sqrt{1+A^2}$ . The limiting value of  $\beta$  corresponds to the lower limit of the inequality (5.34). Using the relations

$$\operatorname{sn}(u, 0) = \sin u, \operatorname{cn}(u, 0) = \cos u, \operatorname{dn}(u, 0) = 1, \quad (5.40a)$$

$$\operatorname{sn}(u, 1) = \tanh u, \operatorname{cn}(u, 1) = \operatorname{sech} u, \operatorname{dn}(u, 1) = \operatorname{sech} u, \quad (5.40b)$$

$$E(u, 1) = \tanh u, E(u, 0) = u, \quad (5.40c)$$

(5.35) and (5.36) reduces respectively to

$$u \sim \frac{4A\Omega}{a} \frac{-A \sinh \beta\xi \cos \Omega\eta + \cosh \beta\xi \sin \Omega\eta}{\cosh^2 \beta\xi + A^2 \cos^2 \Omega\eta}. \quad (5.41a)$$

$$x \sim y - \frac{2\Omega \sinh 2\beta\xi + A \sin 2\Omega\eta}{a \cosh^2 \beta\xi + A^2 \cos^2 \Omega\eta} + d. \quad (5.41b)$$



This parametric solution is essentially the same as the breather solution already given by (4.24). See Fig. 7.

### 5.2.3 Example 2

The second example is given by the following  $f$  and  $g$

$$f(\xi) = A \frac{\operatorname{sn}(\beta\xi, k_f)}{\operatorname{cn}(\beta\xi, k_f)}, \quad g(\eta) = \frac{1}{\operatorname{dn}(\Omega\eta, k_g)}, \quad (5.42)$$

where

$$k_f^2 = 1 - A^2 + \frac{A^2}{\beta^2(1 - A^2)}, \quad (5.43a)$$

$$k_g^2 = 1 - \frac{1}{A^2} + \frac{1}{\Omega^2(1 - A^2)}, \quad (5.43b)$$

$$\Omega = \beta A, \quad (5.43c)$$

$$\kappa = -\frac{\beta^2(1 - k_f^2)}{A^2}, \quad \mu = \beta^2(2 - k_f^2), \quad \nu = \beta^2 A^2. \quad (5.43d)$$

The inequalities  $0 \leq k_f \leq 1$  and  $0 \leq k_g \leq 1$  impose the condition for  $\beta$

$$\frac{1}{\sqrt{1 - A^2}} \leq \beta \leq \frac{1}{1 - A^2}, \quad (5.44)$$

with  $A$  in the range  $0 < A < 1$ . The expressions of  $u$  and  $x$  follows from (5.25), (5.31) and (5.42) with use of the formulas

$$\int \frac{\operatorname{sn}^2(u, k)}{\operatorname{cn}^2(u, k)} du = \frac{1}{k'^2} \left( \frac{\operatorname{dn}(u, k) \operatorname{sn}(u, k)}{\operatorname{cn}(u, k)} - \int \operatorname{dn}^2(u, k) du \right), \quad (5.45a)$$

$$\int \frac{1}{\operatorname{dn}^2(u, k)} du = \frac{1}{k'^2} \left( -k^2 \frac{\operatorname{sn}(u, k) \operatorname{cn}(u, k)}{\operatorname{dn}(u, k)} + \int \operatorname{dn}^2(u, k) du \right). \quad (5.45b)$$

The resulting parametric solution reads in the form

$$u = \frac{4A}{a} \frac{\beta \operatorname{dn}(\beta\xi, k_f) \operatorname{dn}(\Omega\eta, k_g) + k_g^2 \Omega \operatorname{sn}(\beta\xi, k_f) \operatorname{cn}(\beta\xi, k_f) \operatorname{sn}(\Omega\eta, k_g) \operatorname{cn}(\Omega\eta, k_g)}{A^2 \operatorname{sn}^2(\beta\xi, k_f) \operatorname{dn}^2(\Omega\eta, k_g) + \operatorname{cn}^2(\beta\xi, k_f)}. \quad (5.46)$$

$$x = y - \frac{4\beta}{a} \frac{1}{A^2 \operatorname{sn}^2(\beta\xi, k_f) \operatorname{dn}^2(\Omega\eta, k_g) + \operatorname{cn}^2(\beta\xi, k_f)} \times \\ \times \left[ (A^2 \operatorname{dn}^2(\Omega\eta, k_g) - 1) \operatorname{sn}(\beta\xi, k_f) \operatorname{cn}(\beta\xi, k_f) \operatorname{dn}(\beta\xi, k_f) \right]$$

$$\begin{aligned}
& +k_g^2 A^3 \text{sn}^2(\beta\xi, k_f) \text{sn}(\Omega\eta, k_g) \text{cn}(\Omega\eta, k_g) \text{dn}(\Omega\eta, k_g) \Big] \\
& + \frac{4\beta}{a} (-E(\beta\xi, k_f) + AE(\Omega\eta, k_g)) + d. \tag{5.47}
\end{aligned}$$

Although the solution given above is a multiply periodic function, it has a single period if the condition

$$L = \frac{1}{2a} m_\xi L_\xi = \frac{1}{2a} m_\eta L_\eta, \tag{5.48}$$

is satisfied. Using the relation  $(1 - k_f^2)/k_g'^2 = A^4$  which follows from (5.43), the spatial period is found to be as

$$\Lambda = L \left[ 1 - 4\beta^2 \left\{ \frac{E(k_f)}{K(k_f)} - A^2 \frac{E(k_g)}{K(k_g)} \right\} \right]. \tag{5.49}$$

Unlike Example 1, the solution always exhibit singularities as confirmed easily from (4.8) and (5.42).

Figure 16 plots a profile of  $u$  at  $t = 5$ . The parameters are chosen as  $A = 0.2, m_\xi = 2, m_\eta = 1, a = 1.0, d = \xi_0 = \eta_0 = 0$ . In this example,  $\beta = 1.027, \Omega = 0.2053, k_f = 0.9998, k_g = 0.8421, L = 20.35, \Lambda = 5.938$ .

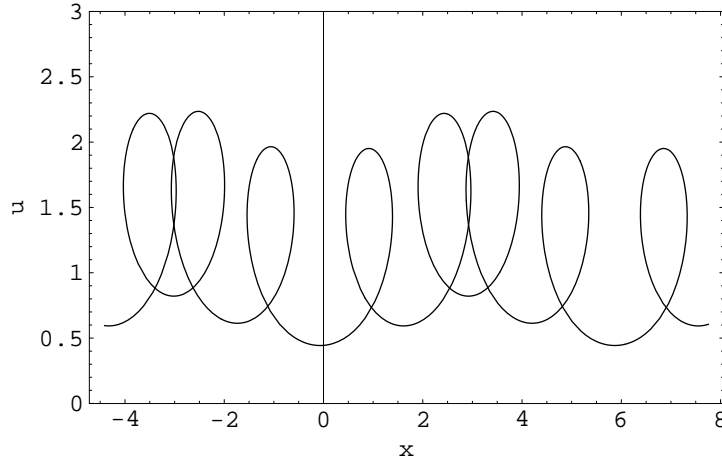

**Fig. 16:** A typical profile of the periodic solution for Example 2.

In considering the limiting profiles, there arise two cases according to the inequality (5.44). The upper limit of the inequality for  $\beta$  is attained when

$k_g \rightarrow 0$ . In this limit, one has the limiting forms

$$\Omega \sim \frac{A}{1-A^2}, \quad k_f^2 \sim 1-A^4, \quad f \sim A \frac{\text{sn}(\beta\xi, k_f)}{\text{cn}(\beta\xi, k_f)}, \quad g \sim 1. \quad (5.50)$$

The expressions (5.46) and (5.47) then reduce respectively to

$$u \sim \frac{4}{a} \frac{\beta A \text{dn}(\beta\xi, k_f)}{A^2 \text{sn}^2(\beta\xi, k_f) + \text{cn}^2(\beta\xi, k_f)} = \frac{4}{a} \frac{\beta A (1+A^2) \text{dn}(\beta\xi, k_f)}{\text{dn}^2(\beta\xi, k_f) + A^2}, \quad (5.51)$$

$$x \sim y + \frac{4}{a} \frac{(1+A^2) \text{sn}(\beta\xi, k_f) \text{cn}(\beta\xi, k_f) \text{dn}(\beta\xi, k_f)}{\text{dn}^2(\beta\xi, k_f) + A^2} + \frac{4\beta}{a} (-E(\beta\xi, k_f) + A\Omega\eta) + d, \quad (5.52)$$

Using (3.10), (5.52) is modified in the form

$$x + Vt - x_0 = \frac{1}{a} (1 + 4\beta^2 A^2) \xi + \frac{4}{a} \frac{(1+A^2) \text{sn}(\beta\xi, k_f) \text{cn}(\beta\xi, k_f) \text{dn}(\beta\xi, k_f)}{\text{dn}^2(\beta\xi, k_f) + A^2} - \frac{4\beta}{a} E(\beta\xi, k_f) + d, \quad (5.53a)$$

with

$$V = \frac{1 + 6A^2 + A^4}{[a(1-A^2)]^2}, \quad x_0 = \frac{1}{a} \{ (1 + 4\beta^2 A^2) \xi_0 - 4\beta^2 A^2 \eta_0 \}. \quad (5.53b)$$

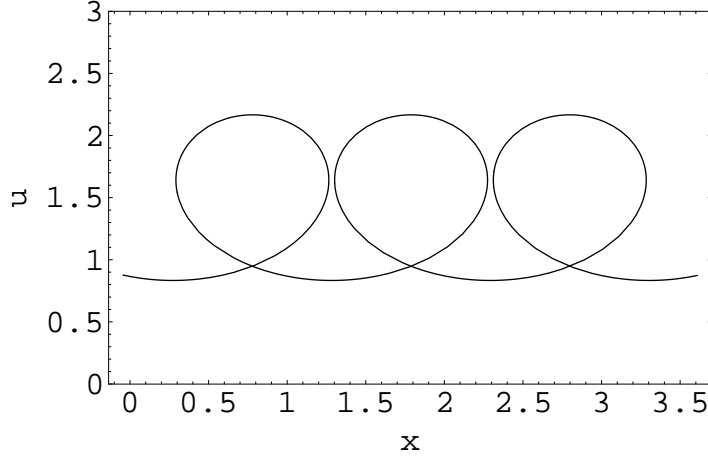

**Fig. 17:** Periodic loop arising from the limit  $k_g \rightarrow 0$  of the periodic solution depicted in Fig. 16.

Since the parametric solution (5.51) and (5.53) depends only on the single variable  $\xi$ , it becomes a 1-phase periodic function. Indeed, as shown in Fig. 17, it represents a periodic train of loops propagating to the left at a constant velocity  $V$ . See also Fig. 1 which illustrates a typical profile of a 1-loop soliton solution. The maximum and minimum values of  $u$  are evaluated from (5.48). They read as  $u_{\max} = 2(1 + A^2)/[a(1 - A^2)]$  (at  $\text{dn}(\beta\xi, k_f) = A$ ) and  $u_{\min} = 4A/[a(1 - A^2)]$  (at  $\text{dn}(\beta\xi, k_f) = A^2, 1$ ). The spatial period  $\Lambda$  is given by (5.49) with  $L = K(k_f)/(a\beta)$ . In this example,  $u_{\max} = 2.167, u_{\min} = 0.833, \beta = 1.042, \Omega = 0.2083, k_f = 0.9992, L = 4.442, \Lambda = 1.010, V = 1.347$ .

The lower limit of  $\beta$  in (5.44) is realized when  $k_f \rightarrow 1, k_g \rightarrow 1$ , which leads to the asymptotics

$$\Omega \sim \frac{A}{\sqrt{1 - A^2}}, \quad f \sim A \sinh \beta\xi, \quad g \sim \cosh \Omega\eta. \quad (5.54)$$

Then, the parametric solution becomes

$$u \sim \frac{4\beta A \cosh \beta\xi \cosh \Omega\eta + A \sinh \beta\xi \sinh \Omega\eta}{a \frac{A^2 \sinh^2 \beta\xi + \cosh^2 \Omega\eta}{A^2 \sinh^2 \beta\xi + \cosh^2 \Omega\eta}}, \quad (5.55a)$$

$$x \sim y - \frac{2\beta A^2 \sinh 2\beta\xi - A \sinh 2\Omega\eta}{a \frac{A^2 \sinh^2 \beta\xi + \cosh^2 \Omega\eta}{A^2 \sinh^2 \beta\xi + \cosh^2 \Omega\eta}} + d. \quad (5.55b)$$

This expression coincides with the parametric form of the 2-loop soliton solution given by (4.19). See Fig. 3.

### 5.2.4 Example 3

The third example of  $f$  and  $g$  takes the form

$$f(\xi) = A \text{dn}(\beta\xi, k_f), \quad g(\eta) = \frac{\text{cn}(\Omega\eta, k_g)}{\text{sn}(\Omega\eta, k_g)}, \quad (5.56)$$

where

$$k_f^2 = 1 - \frac{1}{A^2} + \frac{1}{\beta^2(A^2 - 1)}, \quad (5.57a)$$

$$k_g^2 = 1 - A^2 + \frac{A^2}{\Omega^2(A^2 - 1)}, \quad (5.57b)$$

$$\Omega = \frac{\beta}{A}, \quad (5.57c)$$

$$\kappa = \frac{\beta^2}{A^2}, \quad \mu = \beta^2(2 - k_f^2), \quad \nu = \beta^2 A^2(k_f^2 - 1). \quad (5.57d)$$

The inequalities  $0 \leq k_f \leq 1$  and  $0 \leq k_g \leq 1$  require that the parameter  $\beta$  always must lie in the range

$$\frac{A}{\sqrt{A^2 - 1}} \leq \beta \leq \frac{A^2}{A^2 - 1}, \quad (5.58)$$

with  $A > 1$ . Using (5.25), (5.31) and (5.56), the parametric representation of the solution can be found to be as

$$u = -\frac{4A}{a} \frac{\Omega \operatorname{dn}(\beta\xi, k_f) \operatorname{dn}(\Omega\eta, k_g) + \beta k_f^2 \operatorname{sn}(\beta\xi, k_f) \operatorname{cn}(\beta\xi, k_f) \operatorname{sn}(\Omega\eta, k_g) \operatorname{cn}(\Omega\eta, k_g)}{A^2 \operatorname{dn}^2(\beta\xi, k_f) \operatorname{sn}^2(\Omega\eta, k_g) + \operatorname{cn}^2(\Omega\eta, k_g)}, \quad (5.59a)$$

$$\begin{aligned} x = y - \frac{4\beta}{a} \frac{1}{A^2 \operatorname{dn}^2(\beta\xi, k_f) \operatorname{sn}^2(\Omega\eta, k_g) + \operatorname{cn}^2(\Omega\eta, k_g)} \times \\ \times \left[ \frac{1}{A} (1 - A^2 \operatorname{dn}^2(\beta\xi, k_f)) \operatorname{sn}(\Omega\eta, k_g) \operatorname{cn}(\Omega\eta, k_g) \operatorname{dn}(\Omega\eta, k_g) \right. \\ \left. - k_f^2 A^2 \operatorname{sn}(\beta\xi, k_f) \operatorname{cn}(\beta\xi, k_f) \operatorname{dn}(\beta\xi, k_f) \operatorname{sn}^2(\Omega\eta, k_g) \right] \\ - \frac{4\beta}{a} \left( E(\beta\xi, k_f) - \frac{1}{A} E(\Omega\eta, k_g) \right) + d. \quad (5.59b) \end{aligned}$$

As demonstrated readily by using (4.8) and (5.56), this solution always becomes a multi-valued function.

A spatial period of the above solution can be found if there exist integers  $m_\xi$  and  $m_\eta$  satisfying the relation (5.48). Since in the present case  $K(k_f)/\beta < K(k_g)/\Omega$ , one must impose the condition  $m_\eta < m_\xi$ ,  $(m_\xi, m_\eta) = 1$ . The expression of the spatial period is now given by

$$\Lambda = L \left[ 1 - 4\beta^2 \left\{ \frac{E(k_f)}{K(k_f)} - \frac{1}{A^2} \frac{E(k_g)}{K(k_g)} \right\} \right]. \quad (5.60)$$

Figure 18 plots the profile of  $u$  at  $t = 5$ . The parameters are chosen as  $A = 5, m_\xi = 2, m_\eta = 1, a = 1.0, d = 12, \xi_0 = \eta_0 = 0$ . In this example,  $\beta = 1.027, \Omega = 0.2053, k_f = 0.9998, k_g = 0.8421, L = 20.35, \Lambda = 5.938$ .

Last, we consider two limiting cases. When  $k_g \rightarrow 0$ ,  $\beta$  attains the upper limit of (5.58) and other parameters behave like

$$\Omega \sim \frac{A}{A^2 - 1}, \quad k_f \sim \frac{\sqrt{A^4 - 1}}{A^2}, \quad f \sim A \operatorname{dn}(\beta\xi, k_f), \quad g \sim \cot \Omega\eta. \quad (5.61)$$

The solution (5.59) reduces to

$$u \sim -\frac{4A}{a} \frac{\Omega \operatorname{dn}(\beta\xi, k_f) + \beta k_f^2 \operatorname{sn}(\beta\xi, k_f) \operatorname{cn}(\beta\xi, k_f) \sin\Omega\eta \cos\Omega\eta}{A^2 \operatorname{dn}^2(\beta\xi, k_f) \sin^2\Omega\eta + \cos^2\Omega\eta}, \quad (5.62a)$$

$$x \sim y - \frac{4\beta}{a} \frac{1}{A^2 \operatorname{dn}^2(\beta\xi, k_f) \sin^2\Omega\eta + \cos^2\Omega\eta} \left[ \frac{1}{A} (1 - A^2 \operatorname{dn}^2(\beta\xi, k_f)) \sin\Omega\eta \cos\Omega\eta - k_f^2 A^2 \operatorname{sn}(\beta\xi, k_f) \operatorname{cn}(\beta\xi, k_f) \operatorname{dn}(\beta\xi, k_f) \sin^2\Omega\eta \right] - \frac{4\beta}{a} \left( E(\beta\xi, k_f) - \frac{1}{A} \Omega\eta \right) + d. \quad (5.62b)$$

In the case of  $m_\xi = 2$  and  $m_\eta = 1$ , the relation (5.48) determines  $A$  uniquely as  $A = 6.553$  so that  $\beta = 1.024$ ,  $\Omega = 0.1562$ ,  $k_f = 0.9997$ ,  $L = 20.11$ ,  $\Lambda = 5.669$ . The solution (5.62) exhibits a profile similar to that depicted in Fig. 18.

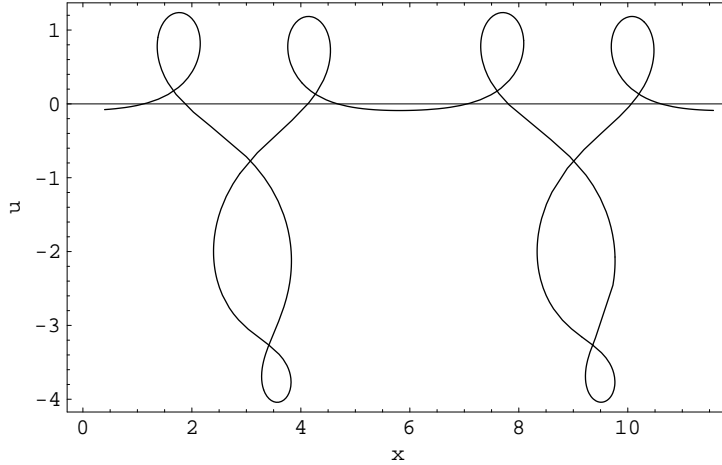

**Fig. 18:** A typical profile of the periodic solution for Example 3.

The lower limit of  $\beta$  in (5.58) is established when  $k_f \rightarrow 1$  and  $k_g \rightarrow 1$ . Consequently, one has

$$\Omega \sim \frac{1}{\sqrt{A^2 - 1}}, \quad f \sim A \operatorname{sech} \beta\xi, \quad g \sim \operatorname{cosech} \Omega\eta. \quad (5.63)$$

The solution then becomes

$$u \sim -\frac{4\beta \cosh \beta\xi \cosh \Omega\eta + A \sinh \beta\xi \sinh \Omega\eta}{a \cosh^2 \beta\xi + A^2 \sinh^2 \Omega\eta}, \quad (5.64a)$$

$$x \sim y - \frac{2\beta \sinh 2\beta\xi - A \sinh 2\Omega\eta}{a \cosh^2 \beta\xi + A^2 \sinh^2 \Omega\eta} + d. \quad (5.64b)$$

It represents the interaction between a loop soliton and an antiloop soliton. See Fig. 3.

### 5.3 Remarks

1. An elementary method for obtaining 1-phase solutions is available which reduces the SP equation to a tractable ODE by assuming solution of traveling type [21].
2. The solutions (5.32), (5.42) and (5.56) have been derived in the context of a finite-length sG system [22]. See also [23, 24] for analogous works.

## 6 ALTERNATIVE METHOD OF SOLUTION

### 6.1 Bilinear transformation method

The bilinear transformation method enables us to construct particular solutions of nonlinear evolution equations [25-28]. Although this method has been employed to obtain soliton solutions of the sG equation (see Sec. 4), it is applicable to periodic solutions as well. Indeed, Nakamura developed a systematic procedure for constructing periodic solutions of various types of soliton equations [29, 30]. Here, we shall use his method to obtain periodic solutions of the sG equation. As already demonstrated in Sec. 4 for constructing soliton solutions, the  $\tau$ -functions play an essential role in the bilinear formalism. In the periodic problem, we introduce the same dependent variable transformation as (4.1)

$$\phi = 2i \ln \frac{f'}{f}. \quad (6.1)$$

Then, we can transform the sG equation (3.9) to the the following system of bilinear equations for the  $\tau$ -functions  $f$  and  $f'$

$$f f_{yt} - f_y f_t - \frac{1}{4}(f^2 - f'^2) = \lambda f^2, \quad (6.2a)$$

$$f' f'_{yt} - f'_y f'_t - \frac{1}{4}(f'^2 - f^2) = \lambda f'^2, \quad (6.2b)$$

where  $\lambda$  is a complex parameter to be determined later and the variable  $\tau$  has been replaced by the variable  $t$  by virtue of (3.3a). The parametric representation of  $u$  follows immediately from (3.8) and (6.1)

$$u(y, t) = 2i \left( \ln \frac{f'}{f} \right)_t. \quad (6.3)$$

We then use (6.1) and (6.2) to derive the relation

$$\cos \phi = 1 + 4\lambda - 2(\ln f' f)_{yt}. \quad (6.4)$$

Introducing (6.4) into (3.14) and integrating with respect to  $y$  yield the parametric representation of the coordinate  $x$

$$x(y, t) = (1 + 4\lambda)y - 2(\ln f' f)_t + c. \quad (6.5)$$

Comparing (6.5) with (4.6), one sees that a new parameter  $\lambda$  comes in the periodic solution which would disappear in the long-wave (or soliton) limit. Thus, if we can solve the bilinear equations (6.2), then we can obtain solutions of the SP equation through the parametric representation (6.3) and (6.5). It should be remarked that unlike the soliton solutions, the constant  $c$  in (6.5) depends on  $t$ . This constant can be determined by using (4.7).

## 6.2 Method of solution

In accordance with Nakamura's procedure, we construct periodic solutions of the bilinear equations (6.2). To this end, we first introduce the  $N$ -dimensional theta function

$$\theta(\mathbf{z}|\tau) = \sum_{n_1, n_2, \dots, n_N = -\infty}^{\infty} \exp \left( 2\pi i \sum_{j=1}^N n_j z_j + \pi i \sum_{j,k=1}^N n_j \tau_{jk} n_k \right), \quad (6.6)$$

where  $\mathbf{z} = (z_1, z_2, \dots, z_N)$  is an  $N$ -dimensional vector and  $\tau = (\tau_{jk})_{1 \leq j, k \leq N}$  is an  $N \times N$  symmetric matrix. First, we seek solution of the bilinear equation (6.2a) in terms of the theta functions as

$$f = \theta \left( \mathbf{z} + \frac{\mathbf{d}}{4} \middle| \tau \right), \quad (6.7a)$$

$$f' = \theta \left( \mathbf{z} - \frac{\mathbf{d}}{4} \middle| \tau \right), \quad (6.7b)$$

where  $\mathbf{d} = (1, 1, \dots, 1)$  is an  $N$ -dimensional vector whose entries are all unity and  $z_j$  ( $j = 1, 2, \dots, N$ ) are phase variables defined by

$$z_j = k_j y + \omega_j t + z_{j0}, \quad (j = 1, 2, \dots, N). \quad (6.7c)$$

Here,  $k_j, \omega_j$  and  $z_{j0}$  are complex parameters. Substituting (6.7) into (6.2a), we find that the bilinear equation can be transformed to the form

$$\sum_{m_1, m_2, \dots, m_N = -\infty}^{\infty} F(m_1, m_2, \dots, m_N) \exp \left( 2\pi i \sum_{j=1}^N m_j z_j \right) = 0, \quad (6.8a)$$



where

$$\begin{aligned}
& F(m_1, m_2, \dots, m_N) \\
&= \sum_{n_1, n_2, \dots, n_N = -\infty}^{\infty} \left[ -2\pi^2 \left\{ \sum_{j=1}^N (2n_j - m_j) k_j \right\} \left\{ \sum_{l=1}^N (2n_l - m_l) \omega_l \right\} \right. \\
&\quad \left. - \frac{1}{4} \left\{ 1 + 4\lambda - (-1)^{\sum_{j=1}^N m_j} \right\} \right] \times \\
&\times \exp \left[ \pi i \left\{ \sum_{j,k=1}^N n_j \tau_{jk} n_k + \sum_{j,k=1}^N (m_j - n_j) \tau_{jk} (m_k - n_k) \right\} + \frac{\pi}{2} i \sum_{j=1}^N m_j \right]. \quad (6.8b)
\end{aligned}$$

By shifting the  $s$ th summation index  $n_s$  as  $n_s + 1$  in (6.8b), we see that

$$\begin{aligned}
F(m_1, m_2, \dots, m_N) &= -F(m_1, \dots, m_{s-1}, m_s - 2, m_{s+1}, \dots, m_N) \times \\
&\times \exp \left[ 2\pi i \left( \sum_{l=1}^N \tau_{sl} m_l - \tau_{ss} \right) \right]. \quad (6.9)
\end{aligned}$$

Thus, if the relations

$$F(m_1, m_2, \dots, m_N) = 0, \quad (6.10)$$

hold for all possible combinations of  $m_1 = 0, 1, m_2 = 0, 1, \dots, m_N = 0, 1$ , then all  $F$ 's become zero for arbitrary integer values of  $m_1, m_2, \dots, m_N$ , implying that Eq. (6.8) holds identically. Consequently, the  $\tau$ -functions (6.7) satisfy the bilinear equation (6.2a).

A similar analysis shows that the bilinear equation (6.2b) reduces to Eq. (6.8a) where the function  $F$  has the same form as (6.8b) except that the factor  $\frac{\pi}{2} i \sum_{j=1}^N m_j$  in the exponential function is replaced simply by  $-\frac{\pi}{2} i \sum_{j=1}^N m_j$ . It turns out that the relations (6.10) assure that the  $\tau$ -functions (6.7) satisfy the bilinear equation (6.2b) as well. Thus, if we can determine parameters such that relations (6.10) are satisfied, then we obtain periodic solutions of the sG equation. We can regard (6.10) as a system of  $2^N$  nonlinear equations for the unknown parameters  $\omega_j (j = 1, 2, \dots, N)$ ,  $\tau_{jk} (1 \leq j < k \leq N)$  and  $\lambda$  with given values of  $k_j$  and  $\tau_{jj} (j = 1, 2, \dots, N)$ . The total number of unknowns is  $N(N-1)/2 + N + 1 = N(N+1)/2 + 1$ . For  $N = 1, 2$ , the total number of equations is equal to the total number of unknown parameters. Hence, we have 1- and 2-phase solutions in terms of the theta functions. For  $N \geq 3$ , on the other hand, the total number of equations always exceeds that of unknowns.

In this case, Eqs. (6.10) become an overdetermined system and we need a separate consideration as for the existence of the solution.

### 6.3 1-phase solutions

Here, we derive a 1-phase solution of the sG equation by means of the method described above. For  $N = 1$ , the relations (6.10) become

$$F(m) = \sum_{n=-\infty}^{\infty} \left[ -2\pi^2(2n-m)^2 k\omega - \frac{1}{4} \{1 + 4\lambda - (-1)^m\} \right] \times \\ \times \exp \left[ \pi i \{(n-m)^2 + n^2\} \tau + \frac{\pi}{2} i m \right] = 0, \quad (m = 0, 1), \quad (6.11)$$

where we have put  $k = k_1, \omega = \omega_1, \tau = \tau_{11}, m = m_1, n = n_1$  for simplicity. Explicitly, these read

$$\sum_{n=-\infty}^{\infty} (8\pi^2 n^2 k\omega + \lambda) e^{2\pi i n^2 \tau} = 0, \quad (6.12a)$$

$$\sum_{n=-\infty}^{\infty} \left\{ 2\pi^2 (2n-1)^2 k\omega + \frac{1}{2} (1 + 2\lambda) \right\} e^{\pi i \{(n-1)^2 + n^2\} \tau} = 0. \quad (6.12b)$$

We can rewrite (6.12) in terms of the following 1-dimensional theta functions

$$\theta_1(z|\tau) = -i \sum_{n=-\infty}^{\infty} (-1)^n \exp \left[ \pi i (2n+1)z + \pi i \left( n + \frac{1}{2} \right)^2 \tau \right], \quad (6.13a)$$

$$\theta_2(z|\tau) = \sum_{n=-\infty}^{\infty} \exp \left[ \pi i (2n+1)z + \pi i \left( n + \frac{1}{2} \right)^2 \tau \right], \quad (6.13b)$$

$$\theta_3(z|\tau) = \sum_{n=-\infty}^{\infty} \exp [2\pi i n z + \pi i n^2 \tau], \quad (6.13c)$$

$$\theta_4(z|\tau) = \sum_{n=-\infty}^{\infty} (-1)^n \exp [2\pi i n z + \pi i n^2 \tau]. \quad (6.13d)$$

Before proceeding, it is convenient to introduce a new parameter  $q$  by

$$q = e^{\pi i \tau}, \quad (6.14)$$

and write the above four theta functions as

$$\theta_j(z|\tau) = \theta_j(z, q), \quad (j = 1, 2, 3, 4). \quad (6.15)$$

Thus, the relation  $\theta_j(z|n\tau) = \theta_j(z, q^n)$  holds for any integer  $n$ . This notation will be used in the following.

Now, using (6.15), Eqs. (6.12) can be recast into the following system of linear algebraic equation for the two unknowns  $k\omega$  and  $\lambda$

$$2\theta_3''(0, q^2)k\omega - \theta_3(0, q^2)\lambda = 0, \quad (6.16a)$$

$$2\theta_2''(0, q^2)k\omega - \frac{1}{2}\theta_2(0, q^2)(1 + 2\lambda) = 0, \quad (6.16b)$$

where  $\theta_j''(0, q^2) = d^2\theta_j(z, q^2)/dz^2|_{z=0}$ , ( $j = 2, 3$ ). Solving this system, we obtain

$$k\omega = -\frac{1}{4} \frac{\theta_2(0, q^2)\theta_3(0, q^2)}{\theta_2(0, q^2)\theta_3''(0, q^2) - \theta_2''(0, q^2)\theta_3(0, q^2)}, \quad (6.17a)$$

$$\lambda = -\frac{1}{2} \frac{\theta_2(0, q^2)\theta_3''(0, q^2)}{\theta_2(0, q^2)\theta_3''(0, q^2) - \theta_2''(0, q^2)\theta_3(0, q^2)}. \quad (6.17b)$$

If we use the identity

$$\frac{\theta_3''(0, q^2)}{\theta_3(0, q^2)} - \frac{\theta_2''(0, q^2)}{\theta_2(0, q^2)} = \pi^2\theta_4^4(0, q^2), \quad (6.18)$$

we can recast (6.17) to the compact expressions

$$k\omega = -\frac{1}{4\pi^2\theta_4^4(0, q^2)}, \quad (6.19a)$$

$$\lambda = -\frac{\theta_3''(0, q^2)}{2\pi^2\theta_3(0, q^2)\theta_4^4(0, q^2)}. \quad (6.19b)$$

Now, the  $\tau$ -functions  $f$  and  $f'$  can be expressed in the form

$$f = \theta\left(z + \frac{1}{4} \middle| \tau\right) = \sum_{n=-\infty}^{\infty} \exp\left[2\pi in\left(z + \frac{1}{4}\right) + \pi in^2\tau\right], \quad (6.20a)$$

$$f' = \theta\left(z - \frac{1}{4} \middle| \tau\right) = \sum_{n=-\infty}^{\infty} \exp\left[2\pi in\left(z - \frac{1}{4}\right) + \pi in^2\tau\right], \quad (6.20b)$$

with

$$z = ky + \omega t + z_0. \quad (6.20c)$$

In order to obtain a real periodic solution, we introduce the new real quantities with tilde by

$$k = -\frac{i}{2\pi}\tilde{k}, \quad \omega = -\frac{i}{2\pi}\tilde{\omega}, \quad z_0 = -\frac{i}{2\pi}\tilde{z}_0, \quad (6.21a)$$

$$z = -\frac{i}{2\pi}\tilde{z} = -\frac{i}{2\pi}(\tilde{k}y + \tilde{\omega}t + \tilde{z}_0), \quad (6.21b)$$

and put

$$\tau = ib, \quad (b > 0), \quad (6.21c)$$

to assure the convergence of the series (6.20). Then,  $f$  and  $f'$  are rewritten as

$$f = \sum_{n=-\infty}^{\infty} \exp \left[ n \left( \tilde{z} + \frac{\pi i}{2} \right) - \pi n^2 b \right], \quad (6.22a)$$

$$f' = \sum_{n=-\infty}^{\infty} \exp \left[ n \left( \tilde{z} - \frac{\pi i}{2} \right) - \pi n^2 b \right], \quad (6.22b)$$

with

$$\tilde{z} = \tilde{k}y + \tilde{\omega}t + \tilde{z}_0. \quad (6.22c)$$

In terms of the new parameters  $\tilde{\omega}$  and  $\tilde{k}$ , the dispersion relation (6.19a) becomes

$$\tilde{\omega} = \frac{1}{\theta_4^4(0, q^2)\tilde{k}}, \quad (q = e^{-\pi b}). \quad (6.23)$$

Obviously,  $f' = f^*$  and  $\lambda$  is real. Hence, the parametric solution given by (6.3) and (6.5) yields a real 1-phase periodic solution of the SP equation. For computing  $u$  from (6.3), we rewrite  $f$  in terms of the theta functions  $\theta_1$  and  $\theta_4$  as

$$f = \theta_4 \left( \frac{\tilde{z}}{\pi i}, q^4 \right) + i \left\{ i\theta_1 \left( \frac{\tilde{z}}{\pi i}, q^4 \right) \right\}. \quad (6.24a)$$

Note that  $\theta_4(\tilde{z}/\pi i, q^4)$  and  $i\theta_1(\tilde{z}/\pi i, q^4)$  are real functions of  $\tilde{z}$ . The  $\tau$ -function  $f'$  is given by the complex conjugate of  $f$ . It reads

$$f' = \theta_4 \left( \frac{\tilde{z}}{\pi i}, q^4 \right) - i \left\{ i\theta_1 \left( \frac{\tilde{z}}{\pi i}, q^4 \right) \right\}. \quad (6.24b)$$

It follows from (6.24a) and the definition of the sn function in terms of the theta functions that

$$\frac{\operatorname{Im} f}{\operatorname{Re} f} = \frac{i\theta_1\left(\frac{\tilde{z}}{\pi i}, q^4\right)}{\theta_4\left(\frac{\tilde{z}}{\pi i}, q^4\right)} = i \frac{\theta_2(0, q^4)}{\theta_3(0, q^4)} \operatorname{sn}(v, \kappa), \quad (6.25a)$$

where

$$v = -i\theta_3^2(0, q^4)\tilde{z}, \quad \kappa = \frac{\theta_2^2(0, q^4)}{\theta_3^2(0, q^4)}. \quad (6.25b)$$

Furthermore, using the formula

$$\operatorname{sn}(iv, \kappa) = i \frac{\operatorname{sn}(v, \kappa')}{\operatorname{cn}(v, \kappa')}, \quad \kappa' = \sqrt{1 - \kappa^2} = \frac{\theta_4^2(0, q^4)}{\theta_3^2(0, q^4)}, \quad (6.26)$$

(6.25) becomes

$$\frac{\operatorname{Im} f}{\operatorname{Re} f} = \frac{\theta_2(0, q^4)}{\theta_3(0, q^4)} \frac{\operatorname{sn}(\theta_3^2(0, q^4)\tilde{z}, \kappa')}{\operatorname{cn}(\theta_3^2(0, q^4)\tilde{z}, \kappa')}. \quad (6.27)$$

The relation  $f' = f^*$  makes it possible to write (6.3) as  $u = 4[\tan^{-1}(\operatorname{Im} f/\operatorname{Re} f)]_t$ . Substitution of (6.27) into this expression yields  $u$  given by (5.51) with the identification among the parameters

$$A = \frac{\theta_2(0, q^4)}{\theta_3(0, q^4)}, \quad a = \theta_4^2(0, q^2)\tilde{k}, \quad \beta = \frac{\theta_2^2(0, q^4)}{\theta_4^2(0, q^2)}, \quad \kappa' = \sqrt{1 - A^4}. \quad (6.28)$$

To derive the expression of  $x$  from (6.5), on the other hand, one needs the time dependence of  $c$  which can be determined from (6.24) and (4.7). After some calculations using the identities of the theta functions, we find

$$c(t) = -\frac{4\tilde{\omega}^2}{\pi^2} \left[ \frac{\theta_4''(0, q^4)}{\theta_4(0, q^4)} + \pi^2\theta_2^2(0, q^4)\theta_3^2(0, q^4) \right] t + d, \quad (6.29)$$

where  $d$  is an arbitrary real constant. It can be demonstrated by substituting (6.24) and (6.29) into (6.5) that the expression (6.5) coincides with (5.52). Indeed, a straightforward calculation using (6.5), (6.20), (6.28) and some formulas for the theta functions and Jacobi elliptic functions leads to the expression of  $x$ . We write it in the form

$$x = y + \frac{4(1 + A^2)}{a} \frac{\operatorname{sn}(\beta\xi, k_f)\operatorname{cn}(\beta\xi, k_f)\operatorname{dn}(\beta\xi, k_f)}{\operatorname{dn}^2(\beta\xi, k_f) + A^2} + \frac{4\beta}{a} \left( -E(\beta\xi, k_f) + \frac{\theta_4''(0, q^4)}{\pi^2\theta_3^2(0, q^4)\theta_4(0, q^4)} \tilde{z} \right) + 4\lambda y + c(t). \quad (6.30)$$

Note from (3.10a), (6.22c), (6.23) and (6.28) that  $\tilde{z} = \beta\xi/\theta_3(0, q^4)$  and from (3.10) that the last two terms on the right-hand side of (6.30) can be expressed in terms of  $\xi$  and  $\eta$ . With these facts in mind, we then use the formulas

$$\frac{\theta_3''(0, q^2)}{\theta_3^2(0, q^2)} = \frac{2\theta_4(0, q^4)\theta_4''(0, q^4)}{\theta_3(0, q^2)\theta_4(0, q^2)} - \frac{\pi^2}{2}\theta_2^4(0, q^2), \quad (6.31a)$$

$$\theta_2(0, q^4)\theta_3(0, q^4) = \frac{1}{2}\theta_2^2(0, q^2), \quad (6.31b)$$

and see that (6.30) coincides perfectly with the expression of  $x$  given by (5.52).

Last, we consider the soliton limit. To this end, we first shift the phase constant  $\tilde{z}_0$  as  $\tilde{z}_0 \rightarrow \tilde{z}_0 + \pi b$  and take the limit  $b \rightarrow \infty$  (or  $q \rightarrow 0$ ). In this limit, the theta functions  $\theta_3$  and  $\theta_4$  have the power series expansions

$$\theta_3(0, q) = 1 + 2q + O(q^4), \quad (6.32a)$$

$$\theta_4(0, q) = 1 - 2q + O(q^4). \quad (6.32b)$$

Then, the asymptotic form of  $\lambda$  from (6.17b) and that of  $\tilde{\omega}$  from (6.23) become

$$\lambda \sim 0, \quad \tilde{\omega} \sim \frac{1}{k}. \quad (6.33)$$

The  $\tau$ -function from (6.22a) behaves like

$$f \sim 1 + ie^{\tilde{z}}, \quad \tilde{z} = \tilde{k}y + \frac{1}{k}t + \tilde{z}_0. \quad (6.34)$$

This coincides with the  $\tau$ -function (4.9) for the 1-loop soliton solution.

Another type of real 1-phase solutions can be constructed by a similar procedure to that described above. We list two of them for reference. If we replace  $z$  by  $z + \frac{1}{4}$  and put  $\tau = \frac{1}{2} + ib$  in (6.20), the  $\tau$ -functions  $f$  and  $f'$  turn out to be

$$f = \sum_{n=-\infty}^{\infty} \exp \left[ 2\pi in z - \frac{\pi i}{2} n^2 - \pi in^2 \tau \right], \quad (6.35a)$$

$$f' = \sum_{n=-\infty}^{\infty} \exp \left[ 2\pi in z + \frac{\pi i}{2} n^2 - \pi in^2 \tau \right], \quad (6.35b)$$

where we have used the formula  $e^{\pi in(n+1)} = 1$ . In view of the formulas  $\theta_3(z|\tau + 1) = \theta_4(z, \tau)$ ,  $\theta_4(z|\tau + 1) = \theta_3(z, \tau)$ , the relations (6.19) then become

$$k\omega = -\frac{1}{4\pi^2\theta_3^4(0, q^2)}, \quad (6.36a)$$

$$\lambda = -\frac{\theta_4''(0, q^2)}{2\pi^2\theta_4(0, q^2)\theta_3^4(0, q^2)}. \quad (6.36b)$$

Using (6.35a), we find

$$\frac{\operatorname{Im} f}{\operatorname{Re} f} = -A \frac{\operatorname{cn}(w, \kappa)}{\operatorname{dn}(w, \kappa)}, \quad (6.37a)$$

where

$$w = 2\pi^2\theta_3^2(0, q^4)(ky + \omega t + z_0), \quad A = \frac{\theta_2(0, q^4)}{\theta_3(0, q^4)}, \quad \kappa = A^2, \quad q = e^{-\pi b}. \quad (6.37b)$$

By replacing  $z$  by  $iz$  in (6.35), we obtain

$$\frac{\operatorname{Im} f}{\operatorname{Re} f} = -\frac{A}{\operatorname{dn}(w, \kappa')}, \quad (6.38)$$

with  $\kappa' = \sqrt{1 - \kappa^2}$ , where the expressions (6.36) remain the same forms. The expressions (6.37) and (6.38) give rise to the 1-phase solutions of the sG equation.

#### 6.4 2-phase solutions

In order to construct 2-phase solutions of the sG equation, we first solve the system of equations (6.10). Given values of  $k_1, k_2, \tau_{11}$  and  $\tau_{22}$ , this system can be solved in principle for the unknown parameters  $\omega_1, \omega_2, \tau_{12}$  and  $\lambda$ . Because of the transcendental nature of the system of equations, however, it is very difficult to obtain analytical solution. Under a few special situations in which the 2-dimensional theta function is expressed by a finite sum of 1-dimensional theta functions, the system can be solved algebraically. Indeed, there exist several examples to realize the situation mentioned above [31]. Among them, we consider the particularly important case

$$\tau_{11} = \tau_{22}. \quad (6.39)$$

It turns out that the 2-dimensional theta function (6.6) has the representation [31]

$$\theta(\mathbf{z}|\tau) = \frac{1}{2} \left\{ \theta_3 \left( z_+ + \frac{1}{2} \middle| \tau_+ \right) \theta_3 \left( z_- + \frac{1}{2} \middle| \tau_- \right) + \theta_3(z_+|\tau_+) \theta_3(z_-|\tau_-) \right\}, \quad (6.40a)$$

where

$$z_{\pm} = \frac{1}{2}(z_1 \pm z_2), \quad (6.40b)$$

$$\tau_{\pm} = \frac{1}{2}(\tau_{11} \pm \tau_{12}), \quad (\text{Im } \tau_{\pm} > 0). \quad (6.40c)$$

It follows from (6.7) and (6.40) that

$$f = \theta_3 \left( z_+ - \frac{1}{4} \middle| \tau_+ \right) \theta_3 \left( z_- + \frac{1}{2} \middle| \tau_- \right) + \theta_3 \left( z_+ + \frac{1}{4} \middle| \tau_+ \right) \theta_3 (z_- | \tau_-), \quad (6.41a)$$

$$f' = \theta_3 \left( z_+ + \frac{1}{4} \middle| \tau_+ \right) \theta_3 \left( z_- + \frac{1}{2} \middle| \tau_- \right) + \theta_3 \left( z_+ - \frac{1}{4} \middle| \tau_+ \right) \theta_3 (z_- | \tau_-). \quad (6.41b)$$

Invoking the definition of the dn function, the solution  $\phi$  of the sG equation can be written in the form

$$\begin{aligned} \tan \frac{\phi}{4} &= \frac{1}{i} \frac{f - f'}{f + f'} \\ &= \frac{\sqrt{k'_+} - \text{dn}(u_+ + \delta_+, k_+) \sqrt{k'_-} - \text{dn}(u_-, k_-)}{\sqrt{k'_+} + \text{dn}(u_+ + \delta_+, k_+) \sqrt{k'_-} + \text{dn}(u_-, k_-)}, \end{aligned} \quad (6.42a)$$

where

$$u_{\pm} = \pi \theta_3^2(0 | \tau_{\pm}) z_{\pm}, \quad (6.42b)$$

$$k_{\pm} = \sqrt{1 - k'_{\pm}{}^2}, \quad k'_{\pm} = \frac{\theta_4^2(0 | \tau_{\pm})}{\theta_3^2(0 | \tau_{\pm})}, \quad (6.42c)$$

$$\delta_+ = \frac{\pi}{4} \theta_3^2(0 | \tau_+). \quad (6.42d)$$

Thus, the above solution has a form similar to (5.23) in which the variables  $u_+$  and  $u_-$  are separated completely.

The next step is to solve the system of equations (6.10) with  $N = 2$ . We observe under the condition (6.39) that

$$n_1^2 \tau_{11} + 2n_1 n_2 \tau_{12} + n_2^2 \tau_{22} = (n_1 + n_2)^2 \tau_+ + (n_1 - n_2)^2 \tau_-. \quad (6.43)$$

Using (6.43), Eqs. (6.10) can be solved analytically. The calculation involved is straightforward but somewhat tedious. Hence, we outline only the main steps. It follows from the equations  $F(1, 0) = 0$  and  $F(0, 1) = 0$  that

$$k_1 \omega_1 = k_2 \omega_2. \quad (6.44)$$

Substituting  $\omega_2$  from (6.44) into the equations  $F(0, 0) = 0$  and  $F(1, 1) = 0$ , one obtains a homogeneous system of linear equations for  $\omega_1$  and  $\lambda$ . The solvability of this system yields the relation

$$[\theta_2''(0, q_+^8) \theta_3(0, q_+^8) - \theta_2(0, q_+^8) \theta_3''(0, q_+^8)][\theta_2^2(0, q_-^8) - \theta_3^2(0, q_-^8)]$$



$$= \alpha[\theta_2''(0, q_-^8)\theta_3(0, q_-^8) - \theta_2(0, q_-^8)\theta_3''(0, q_-^8)][\theta_2^2(0, q_+^8) - \theta_3^2(0, q_+^8)], \quad (6.45a)$$

where

$$q_{\pm} = e^{\pi i \tau_{\pm}} = e^{\pi i (\tau_{11} \pm \tau_{12})/2}, \quad (6.45b)$$

$$\alpha = \left( \frac{k_1 - k_2}{k_1 + k_2} \right)^2. \quad (6.45c)$$

Through a sequence of transformations using various formulas of the theta functions, one can simplify (6.45) to the form

$$\theta_2^4(0, q_+^2) = \alpha \theta_2^4(0, q_-^2). \quad (6.46)$$

This is a transcendental equation which determines  $q_+$  for given  $q_-$  and  $\alpha$ . Once  $q_+$  is obtained, the parameter  $\tau_{12}$  is found from the relation

$$e^{\pi i \tau_{12}} = \frac{q_+}{q_-}, \quad (6.47)$$

which follows from (6.45b). The parameters  $\omega_1$  and  $\lambda$  are then determined from the equations  $F(0, 0) = 0$  and  $F(1, 0) = 0$  as well as the relation (6.44), the explicit forms of which are not written down here. Thus, we have completed the construction of a 2-phase solution of the bilinear equation (6.2a). The corresponding solution of the SP equation can be obtained from (6.1) and (6.5). As in the case of 1-phase solutions discussed in Sec. 6.3, various 2-phase solutions of the SP equation arise by specifying the parameters  $k_1, k_2$ , and  $\tau_{11}(= \tau_{22})$ . The explicit solutions are not presented here and will be reported elsewhere.

## 6.5 Remarks

1. The starting point of our discussion is the condition (6.39) which makes it possible to perform all the calculations algebraically. The resulting solution of  $\phi$  has a separable form with respect to the independent variables  $u_+$  and  $u_-$  (see (6.42)). This expression should be compared with the separable solution introduced in (5.23). Thus, we can expect that the method developed here would reproduce all solutions constructed by a different method described in Sec. 5.2.
2. Unless the condition (6.39) is imposed, we would be able to obtain a broader class of 2-phase solutions. The structure of solutions is worth studying in a future work.
3. The general  $N$ -phase solution of the sG equation has been constructed by means of the method of algebraic geometry [18]. It has a form given by

(6.1) in terms of the  $N$ -dimensional theta functions. However, whether the corresponding  $\tau$ -functions satisfy a system of bilinear equations (6.2) or not is an open problem to be resolved in a different context. On the other hand, our method first looks for the solution of (6.2) so that the expression of  $x$  follows immediately from (6.5). As already mentioned, however, the construction of the  $N$ -phase solutions with  $N \geq 3$  is a difficult task in the context of the bilinear formalism. Nevertheless, it is undoubtedly a challenging problem.

## 7 CONCLUSION

We have presented soliton and periodic solutions of the SP equation by means of a new method of solution. The most difficult technical problem in constructing solutions was how to integrate the PDE which governs the inverse mapping to the original coordinate system (see (3.13) and (3.14)). In the case of soliton solutions, the explicit form of the coordinate  $x$  was obtained in terms of the  $\tau$ -functions  $f$  and  $f'$  as shown by (4.5). In the case of periodic solutions, on the other hand, the special ansatz leads to the explicit form of  $x$  in terms of Jacobi's elliptic functions. Specifically, for 1-phase solutions, assuming the dependence of single variable, the sG equation becomes a tractable ODE (5.1) so that a number of special solutions are available. For 2-phase solutions, under the ansatz (5.23), we were able to reduce the representation of  $x$  to single integrals which are easily integrated (see (5.31)). It should be remarked, however, that the resulting solutions of the SP equation are special class of real 2-phase solutions. An alternative method employing the bilinear transformation method described in Sec. 6 enables us to construct a broader class of solutions than the solutions obtained in Sec. 5. At present, the most interesting issue will be the construction of the general  $N$ -phase solution which is reduced to the  $N$ -soliton solution (4.5) and (4.6) in the long-wave limit.

## REFERENCES

- [1] T. Schäfer and C.E. Wayne, *Propagation of ultra-short optical pulses in cubic nonlinear media*, Physica **D 196** (2004) 90-105.
- [2] J.E. Rothenberg, *Space-time focusing: breakdown of the slowly varying envelope approximation in the self-focusing of femtosecond pulses*, Opt. Lett. **17** (1992) 1340-1342.
- [3] J.K. Ranka and A.L. Gaeta, *Breakdown of the slowly varying envelope approximation in the self-focusing of ultrashort pulses*, Opt. Lett. **23** (1988) 534-536.

- [4] Y. Chung, C.K.R. Jones, T. Schäfer and C.E. Wayne, *Ultra-short pulses in linear and nonlinear media*, Nonlinearity, **18** (2005) 1351-1374.
- [5] M.L. Rabelo. *On equations which describe pseudospherical surfaces*, Stud. Appl. Math. **81** (1989) 221-248.
- [6] D. Alterman and J. Rauch, *Diffraction short pulse asymptotics for nonlinear wave equations*, Phys. Lett. **A 264** (2000) 390-395.
- [7] R. Beals, M. Rabelo and K. Tenenblat, *Bäcklund transformations and inverse scattering solutions for some pseudospherical surface equations*, Stud. Appl. Math. **81** (1989) 121-151.
- [8] A. Sakovich and S. Sakovich, *The short pulse equation is integrable*, J. Phys. Soc. Jpn. **74** (2005) 239-241.
- [9] J.C. Brunelli, *The short pulse hierarchy*, J. Math. Phys. **46** (2005) 123507(1-9).
- [10] J.C. Brunelli, *The bi-Hamiltonian structure of the short pulse equation*, Phys. Lett. **A 353** (2006) 475-478.
- [11] Y. Matsuno, *Cusp and loop soliton solutions of short-wave models for the Camassa-Holm and Degasperis-Procesi equations*, Phys. Lett. **A 359** (2006) 451-457.
- [12] Y. Matsuno, *Multisoliton and multibreather solutions of the short pulse model equation*, J. Phys. Soc. Jpn. **76** (2007) 084003(1-6).
- [13] R. Hitota, *Exact solution of the sine-Gordon equation for multiple collisions of solitons*, J. Phys. Soc. Jpn. **33** (1972) 1459-1463.
- [14] A. Sakovich and S. Sakovich, *Solitary wave solutions of the short pulse equation*, J. Phys. A: Math. Gen. **39** (2006) L361-L367.
- [15] V.K. Kuetche, T.B. Bouetou and T.C. Kofane, *On two-loop soliton solution of the Schäfer-Wayne short-pulse equation using Hirota's method and Hodnett-Moloney approach*, J. Phys. Soc. Jpn. **76** (2007) 024004(1-7).
- [16] Y. Matsuno, *Periodic solutions of the short pulse model equation*, J. Math. Phys. **49** (2008) 073508 (1-18).

- [17] D.F. Lawden, *Elliptic Functions and Applications* (Springer, New York, 1989).
- [18] E.D. Belokolos, A.I. Bobenko, V.Z. Enol'skii, A.R. Its and V.B. Matveev, *Algebro-Geometric Approach to Nonlinear Integrable Equations* (Springer, New York, 1994).
- [19] G.L. Lamb, Jr., *Analytical descriptions of ultrashort optical pulse propagation in a resonant medium*, Rev. Mod. Phys. **43** (1971) 99-124.
- [20] G.L. Lamb, Jr., *Elements of Soliton Theory* (Wiley, New York, 1980).
- [21] E.J. Parkes, *Some periodic and solitary travelling-wave solutions of the short-pulse equation*, Chaos, Solitons and Fractals **38** (2008) 154-159.
- [22] G. Costabile, R.D. Parmentier, B. Savo, D.W. McLaughlin and A.C. Scott, *Exact solutions of the sine-Gordon equation describing oscillations in a long (but finite) Josephson junction*, Appl. Phys. Lett. **32** (1978) 587-589.
- [23] R.M. DeLeonardis and S.E. Trullinger, *Theory of boundary effects on sine-Gordon solitons*, J. Appl. Phys. **51** (1980) 1211-1226.
- [24] R.M. DeLeonardis, S.E. Trullinger and R.F. Wallis, *Classical excitation energies for a finite-length sine-Gordon system*, J. Appl. Phys. **53** (1982) 699-702.
- [25] R. Hirota, *Exact solution of the Korteweg-de Vries equation for multiple collision of solitons*, Phys. Rev. Lett. **27** (1971) 1192-1194.
- [26] R. Hirota, *Direct Method in Soliton Theory*, in *Solitons*, R.K. Bullough and P.J. Caudrey eds. (Springer, New York, 1980) 157-176.
- [27] Y. Matsuno, *Bilinear Transformation Method* (Academic Press, New York, 1984).
- [28] R. Hirota, *Direct Method in Soliton Theory* (Cambridge University Press, Cambridge, 2004).
- [29] A. Nakamura, *A direct method of calculating periodic wave solutions to nonlinear evolution equations. I. Exact two-periodic wave solution*, J. Phys. Soc. Jpn. **47** (1979) 1701-1705.

- [30] A. Nakamura, *A direct method of calculating periodic wave solutions to nonlinear evolution equations. II. Exact one- and two-periodic wave solution of the coupled bilinear equations*, J. Phys. Soc. Jpn. **48** (1980) 1365-1370.
- [31] J. Zagrodziński, *Dispersion equations and a comparison of different quasi-periodic solutions of the sine-Gordon equation*, J. Phys. A: Math. Gen. **15** (1982) 3109-3118.