

DEGENERATIONS OF TRIPLE COVERINGS AND THOMAE'S FORMULA

KEIJI MATSUMOTO AND TOMOHIDE TERASOMA

Dedicated to Professor Toshiyuki Katsura on his 60th birthday

ABSTRACT. In this paper, we prove Thomae's formula for triple coverings of the complex projective line \mathbf{P}^1 and give the absolute constant in this formula for a specific choice of symplectic bases. This formula gives a relation between theta constants, the products of the determinant of a period matrix and difference products of branch points. To specify symplectic bases of them, we use the combinatorics of binary trees on \mathbf{P}^1 . These symplectic bases behave so well for degenerations that we reduce the formula to a special case treated in [BR], [N].

1. INTRODUCTION

Let $E : y^2 = x(1-x)(1-\lambda x)$ be an elliptic curve and τ be the normalized period matrix of E . Then we have Jacobi's formula for an elliptic curve E :

$$\vartheta(\tau)[0, 0]^2 = \frac{1}{\pi} \int_0^1 \frac{1}{\sqrt{x(1-x)(1-\lambda x)}} dx,$$

where $\vartheta(\tau)[\alpha, \beta]$ is defined in (2.1).

In 1870, Thomae ([T]) generalized this formula to those for hyperelliptic curves of arbitrary genus. He showed that the squares of theta constants at the normalized period matrix of a hyperelliptic curve are equal to the products of the determinant of a period matrix and certain difference products of branch points up to an easy constant multiple. Bershadsky-Radul and Nakayashiki [BR],[N] independently proved an analogous formula for cyclic coverings of the projective line \mathbb{P}^1 with special branching indices, which is called Thomae's formula for cyclic coverings. They prove a power of a theta constant with characteristic Λ is the product of the determinant of a period matrix, a certain difference product and a constant κ_Λ , and show that the constant κ_Λ depends only on the genus, a choice of symplectic basis of the covering and the theta characteristic Λ . This result is generalized to arbitrary branching indices and covering degrees by [K].

For hyperelliptic curves, Fey computed the absolute constants κ_Λ in Thomae's formula using degeneration arguments in his book [F]. In this paper, we give a closed formula for the absolute constants κ_Λ for triple coverings of arbitrary

1991 *Mathematics Subject Classification.* Primary 14H42; Secondary 32G20.

Key words and phrases. theta constant, Thomae's formula, binary tree.

branching indices. To formulate the exact statement of Thomae's formula, we construct symplectic bases of a family of triple coverings using the combinatorics of binary trees on \mathbf{P}^1 . This family is extended to stable curves with trivial monodromy action and each of its special fibers is the union of two triple coverings of \mathbf{P}^1 's. By this degeneration, a binary tree decomposes to two trees and according to this decomposition, the symplectic bases are extended to the union of symplectic bases of two irreducible components. We use this property for the study of the absolute constant κ_Λ .

The contents of this paper are as follows. In Section 2, we recall results of Bershadsky-Radul and Nakayashiki. In Section 3, we define a specific choice of symplectic basis $\{A_1, \dots, A_g, B_1, \dots, B_g\}$ associated to a planar binary tree. We study the combinatorial process of degenerations. In Section 4, we study stable degenerations of algebraic curves associated to the decomposition of binary trees. In Section 5, we prove Thomae's formula (Theorem 6.2) for triple coverings of \mathbb{P}^1 and compute the absolute constants for arbitrary branching indices using degeneration argument. The proof is based on results of Bershadsky-Radul and Nakayashiki and the formula (5.2), which is a variant of the Chowla-Selberg formula. Our method is different from that of [K].

Acknowledgment After finishing this work, we are pointed out about the references [A], [K] by Y. Kopeliovich. The authors would like to express their thanks to him.

2. RESULT OF BERSHADSKY-RADUL-NAKAYASHIKI

In this section, we recall results of Bershadsky-Radul and Nakayashiki. Let $n \geq 2$ be an integer, \mathbb{P}^1 be the projective line with a coordinate x , and $\Sigma = \{\lambda_1, \dots, \lambda_{3n}\}$ be a set of distinct $3n$ points in \mathbb{P}^1 different from $x = \infty$. The values of x at $\lambda_1, \dots, \lambda_{3n}$ are also denoted by the same letter. Let C be the cyclic triple covering of \mathbb{P}^1 defined by

$$y^3 = (x - \lambda_1) \cdots (x - \lambda_{3n}).$$

By Hurwitz's formula, the genus $g = g(C)$ of C is equal to $3n - 2$ and a basis of the space of holomorphic differential forms on C is given by $\{\omega_1, \dots, \omega_{3n-2}\}$, where

$$\begin{aligned} \omega_i &= \frac{x^{n-1-i} dx}{y} && \text{for } i = 1, \dots, n-1, \\ \omega_{i+n-1} &= \frac{x^{2n-1-i} dx}{y^2} && \text{for } i = 1, \dots, 2n-1. \end{aligned}$$

We fix a symplectic basis $\{A_i, B_i\}_{i=1, \dots, 3n-2}$ of $H_1(C, \mathbb{Z})$. The period matrices P_A and P_B are defined as

$$P_A = \left(\int_{A_i} \omega_j \right)_{i,j=1, \dots, 3n-2}, \quad P_B = \left(\int_{B_i} \omega_j \right)_{i,j=1, \dots, 3n-2}.$$

The normalized period matrix τ is defined by $\tau = P_A P_B^{-1}$. For vectors $\alpha, \beta \in \mathbb{Q}^g$, we define the theta function as follows:

$$(2.1) \quad \vartheta(\tau)[\alpha, \beta](z) = \sum_{m \in \mathbb{Z}^g} \mathbf{e}\left(\frac{1}{2}(m + \alpha)\tau^t(m + \alpha) + (m + \alpha)^t(z + \beta)\right).$$

Here, we use the notation $\mathbf{e}(x) = \exp(2\pi\sqrt{-1}x)$. The value of the theta function at $z = 0$ is called the theta constant and denoted by $\vartheta(\tau)[\alpha + a, \beta + b]$. Note that if $\alpha, \beta \in \frac{1}{6}\mathbb{Z}^g$, then the sixth power of the theta constant is periodic with respect to α and β , that is

$$\vartheta(\tau)[\alpha, \beta]^6 = \vartheta(\tau)[\alpha + a, \beta + b]^6$$

for $a, b \in \mathbb{Z}^g$. By the isomorphism

$$(2.2) \quad \mathbb{Q}^g \oplus \mathbb{Q}^g \rightarrow H_1(C, \mathbb{Q}) : (a_1, \dots, a_g, b_1, \dots, b_g) \mapsto \sum_i a_i A_i + \sum_i b_i B_i,$$

the theta constant $\vartheta(\tau)[\alpha, \beta]^6$ is a function on the set of 6-torsion points $H_1(C, \mathbb{Q}/\mathbb{Z})_6$ of $H_1(C, \mathbb{Q}/\mathbb{Z})$. The value at $\lambda \in H_1(C, \mathbb{Q}/\mathbb{Z})_6$ is denoted by $\vartheta(\tau)[\lambda]$.

Let $\rho : C \rightarrow C$ be the automorphism of the curve C defined by $(x, y) \mapsto (x, \omega y)$, where $\omega = \frac{-1 + \sqrt{-3}}{2}$. The induced homomorphism on $H_1(C, \mathbb{Z})$ is also denoted by ρ . We give a description of the group of $(1 - \rho)$ torsion part $H_1(C, \mathbb{Q}/\mathbb{Z})_{(1-\rho)}$ of $H_1(C, \mathbb{Q}/\mathbb{Z})$ as a \mathbb{F}_3 -vector space.

Let b be a base point in $\mathbb{P}^1 - \Sigma$. A path connecting b and small anti-clockwise circle around λ_i defines a path $\tilde{\gamma}_i$ in $\mathbb{P}^1 - \Sigma$. We choose a base point \tilde{b} in C over the base point b . Then the path $\tilde{\gamma}_i$ is lifted uniquely beginning from \tilde{b} , and its end point is $\rho(\tilde{b})$. If any paths $\gamma_i - \{\tilde{b}, \rho(\tilde{b})\}$ are disjoint to one other, then we may assume that paths $\gamma_1, \dots, \gamma_{3n}$ are arranged in the anti-clockwise order by renumbering the paths $\gamma_1, \dots, \gamma_{3n}$. Then the cycle

$$\gamma_1 + \rho\gamma_2 + \rho^2\gamma_3 + \dots + \rho^{3n-1}\gamma_{3n}$$

is homologous to zero. For $i = 1, \dots, 3n - 1$, the path $\gamma_i - \gamma_{3n}$ defines an element of $H_1(C, \mathbb{Z})$. Therefore $\delta_i = \frac{1}{3}(1 - \rho)(\gamma_i - \gamma_{3n})$ defines an element of $H_1(C, \mathbb{Q}/\mathbb{Z})_{(1-\rho)}$. By the above relation, the cycle $\delta_1 + \rho\delta_2 + \dots + \rho^{3n-2}\delta_{3n-1}$ is homologous to zero. Let \mathbf{V} be the \mathbb{F}_3 -vector space $\bigoplus_{i=1}^{3n} \mathbb{F}_3 e_i$ generated by e_1, \dots, e_{3n} . We define the map Π and Δ by

$$\Pi : \mathbf{V} \ni \sum_i a_i e_i \mapsto \sum_i a_i \in \mathbb{F}_3,$$

$$\text{Diag} : \mathbb{F}_3 \ni a \mapsto a \sum_{i=1}^{3n} e_i \in \mathbf{V}.$$

Then we have an isomorphism

$$H_1(C, \mathbb{Q}/\mathbb{Z})_{(1-\rho)} \simeq \text{Ker}(\Pi) / \text{Im}(\text{Diag})$$

by assigning δ_i to $e_i - e_{3n}$.

We are ready to state Thomae's formula for the curve C ($[N],[BR]$). Let $\tilde{\Lambda} = \sum_i a_i e_i$ be a representative in \mathbf{V} of an element Λ of $H_1(C, \mathbb{Q}/\mathbb{Z})_{(1-\rho)}$. We define a subset $\tilde{\Lambda}_i$ of $\{1, \dots, 3n\}$ for $i = 0, 1, 2$ by

$$\tilde{\Lambda}_i = \{p \in \{1, \dots, 3n\} \mid a_p \equiv i \pmod{3}\}.$$

The difference product $(\tilde{\Lambda}_i \tilde{\Lambda}_j)$ is defined by

$$(\tilde{\Lambda}_i \tilde{\Lambda}_j) = \begin{cases} \prod_{a \in \tilde{\Lambda}_i, b \in \tilde{\Lambda}_j} (\lambda_a - \lambda_b) & \text{if } i \neq j, \\ \prod_{a, b \in \tilde{\Lambda}_i, a < b} (\lambda_a - \lambda_b) & \text{if } i = j. \end{cases}$$

Then it is defined up to sign. We define the difference product $\Delta(\Lambda)$ attached to $\Lambda \in H_1(C, \mathbb{Q}/\mathbb{Z})_{(1-\rho)}$ by

$$\Delta(\Lambda) = \prod_{i=0}^2 (\tilde{\Lambda}_i \tilde{\Lambda}_i)^3 \prod_{0 \leq i < j \leq 2} (\tilde{\Lambda}_i \tilde{\Lambda}_j)$$

for a representative $\tilde{\Lambda}$ of Λ . It does not depend on the choice of the representative up to sign.

Theorem 2.1. *Let Λ be an element $H_1(C, \mathbb{Q}/\mathbb{Z})_{(1-\rho)}$ and $\tilde{\Lambda}$ be a representative of Λ in \mathbf{V} . Suppose that*

$$(2.3) \quad \#\tilde{\Lambda}_0 = \#\tilde{\Lambda}_1 = \#\tilde{\Lambda}_2 = n.$$

Then we have

$$\vartheta(\tau)[\Lambda + \varrho]^6 = \kappa_\Lambda \det(P_B)^3 \cdot \Delta(\Lambda).$$

Here ϱ is the Riemann constant and κ_Λ is a constant independent of $\lambda_1, \dots, \lambda_{3n}$. Moreover κ_Λ^6 is independent of Λ .

Definition 2.2. *The absolute constant κ_Λ^6 is called Thomae's constant for the symplectic basis $\{A_i, B_i\}_i$.*

3. BINARY TREES AND SYMPLECTIC BASES

3.1. Symplectic basis associated to a marked binary tree. In this section, we define a symplectic basis associated to a binary tree and study its properties. For general terminology on trees, refer to [S] and [D].

Definition 3.1. (1) *A vertex of a tree Γ is called an inner vertex if it is adjacent to more than one edges. The set of inner vertices of Γ is denoted by $V(\Gamma)$. A vertex of Γ is a terminal if it is not a inner vertex.*

(2) *A tree is called a trivalent tree if the valency of any inner vertex is three.*

(3) *A planar trivalent tree Γ with two colors, white and black, on its vertices is called a binary tree if two ends of any edge are differently colored.*

- (4) Let (Γ, \mathcal{C}) be a binary tree. A marking of (Γ, \mathcal{C}) is to specify choices of one edge adjacent to each inner vertex. A binary tree (Γ, \mathcal{C}) with a marking M is called a marked binary tree and denoted by (Γ, \mathcal{C}, M) . We connect the rest of edges by a small arc to illustrate the marking. (See Figure 1 for an example of marked binary tree.)

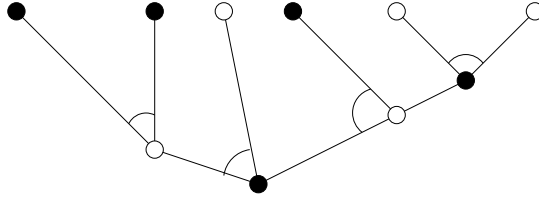

FIGURE 1. Marked binary tree

Let $\lambda_1, \dots, \lambda_m$ be points in \mathbb{P}^1 and set $\Sigma = \{\lambda_1, \dots, \lambda_m\}$. We choose a base point b in $\mathbb{P}^1 - \Sigma$ and a coordinate t so that the base point b corresponds to the infinity. Let (Γ, \mathcal{C}) be a binary tree on \mathbb{P}^1 , whose set of terminals is equal to $\{\lambda_1, \dots, \lambda_m\}$. We construct a cyclic triple covering C^0 of $\mathbb{P}^1 - \Sigma$ associated to the binary tree (Γ, \mathcal{C}) . We prepare three copies $C^{(0)}, C^{(1)}, C^{(2)}$ of $\mathbb{P}^1 - \Gamma$. We patch them according to the following rule. (See Figure 2.)

- (1) If a point moves across an edge of Γ looking white vertex left, we change the sheet as $C^{(0)} \rightarrow C^{(1)} \rightarrow C^{(2)} \rightarrow C^{(0)}$.
- (2) If a point moves across an edge of Γ looking white vertex right, we change the sheet as $C^{(0)} \rightarrow C^{(2)} \rightarrow C^{(1)} \rightarrow C^{(0)}$.

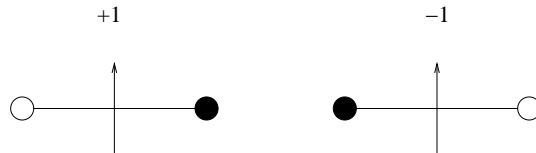

FIGURE 2. Patching of sheets

In this way, we get a compact Riemann surface C . Since the tree Γ is trivalent, the covering $C \rightarrow \mathbb{P}^1$ is not branching at any point v in $V(\Gamma)$, and the branching index $a_i/3$ of λ_i in Σ is equal to $1/3$ or $2/3$ if the color of the vertex λ_i is white or black, respectively. Then the Riemann surface C is isomorphic to the compactification of the Kummer covering of \mathbb{P}^1 :

$$y^3 = \prod_{i=1}^m (x - \lambda_i)^{a_i}.$$

The automorphism ρ defined by $(x, y) \mapsto (x, \omega y)$ corresponds to the change of sheets $C^{(0)} \rightarrow C^{(1)} \rightarrow C^{(2)} \rightarrow C^{(0)}$.

Lemma 3.2. *The genus $g = g(C)$ is equal to the number $\#V(\Gamma)$ of $V(\Gamma)$.*

Proof. Since the tree is trivalent, the number of edges is equal to $(3\#V(\Gamma) + \#\Sigma)/2$. Therefore the number of the vertices is

$$(3\#V(\Gamma) + \#\Sigma)/2 + 1 = \#V + \#\Sigma.$$

Therefore we have $\#V(\Gamma) + 2 = \#\Sigma$ and $g = \#\Sigma - 2 = \#V(\Gamma)$. \square

For a marking M of the binary tree (Γ, \mathcal{C}) , we define a symplectic basis $\{A_v, B_v\}_{v \in V(\Gamma)}$ as follows. We define cycles A_v and B_v as follows. By deleting a small neighborhood of v from the tree Γ , we decompose it into three blocks **B1**, **B2** and **B3** as in Figure 3. We define a cycle A_v by the path in Figure 3.

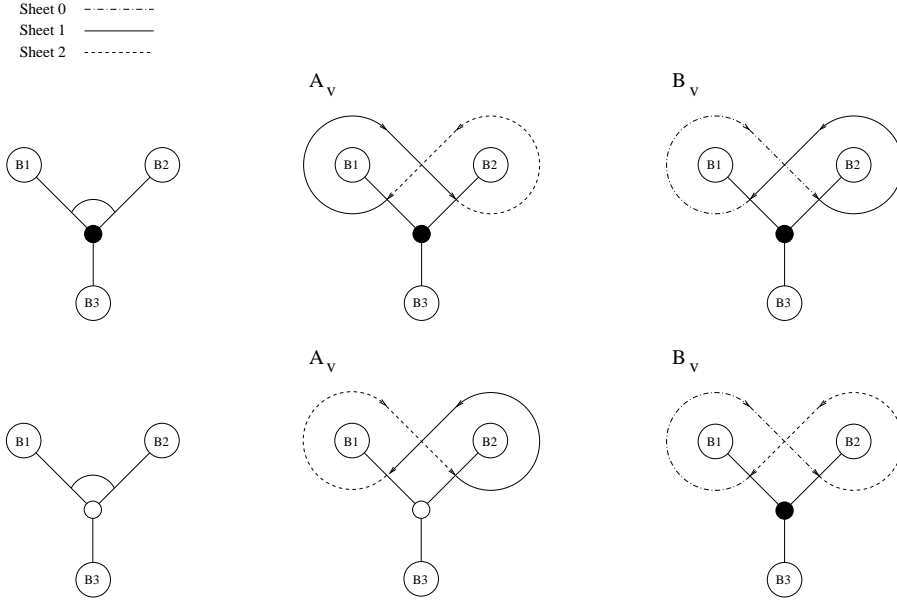

FIGURE 3. Cycles

If the vertex v is white (resp. black), we define B_v by $B_v = \rho^2(A_v)$ (resp. $B_v = \rho(A_v)$). It is easy to see the following proposition.

Proposition 3.3. *The set of cycles $\{A_v, B_v\}_{v \in V(\Gamma)}$ forms a symplectic basis. That is*

$$(A_v, A_w) = (B_v, B_w) = 0, \quad (A_v, B_w) = -\delta(v, w)$$

for $v, w \in V(\Gamma)$.

3.2. Riemann constants. In this subsection, we describe the Riemann constant of the curve C with the symplectic basis $\{A_v, B_v\}_{v \in V(\Gamma)}$ constructed in the last subsection. Let τ be the normalized period matrix with respect to $\{A_v, B_v\}_{v \in V(\Gamma)}$ and p_0 be one of the branched points of the covering $C \rightarrow \mathbf{P}^1$. Let $S^{g-1}(C)$ be the $(g-1)$ -th symmetric product of C , $Q = \sum_{i=1}^{g-1} q_i$ be an element in S^{g-1} and $\text{sym}_Q^{g-1} : S^{g-1}(C) \rightarrow \text{Jac}(X)$ be the map defined by

$$S^{g-1}(C) \ni \sum_{i=1}^{g-1} p_i \mapsto \sum_{i=1}^{g-1} (p_i) - (q_i) \in \text{Pic}(C).$$

We assume that q_i are branch points and $2Q = K_C$. We define the theta zero divisor by

$$(\vartheta(\tau)[0,0](\tau, z))_0 = \{[z] \in Jac(X) \mid \vartheta(\tau)[0,0](\tau, z) = 0\}.$$

Then by Riemann's theorem, there is a point $\varrho(p_0, \{A_i, B_i\})$ in $Jac(X)$ such that

$$(\vartheta(\tau)[0,0](\tau, z))_0 = \varrho(Q, \{A_i, B_i\}) - sym_Q^{g-1}(S^{g-1}(C)).$$

The point ϱ is called the Riemann constant. By [Mu], I, Cor. 3.1.1, p.166, we have $2\varrho(Q, \{A_i, B_i\}) = 0$ in $Jac(C)$. Let τ' be the normalized period matrix with respect to the symplectic basis $\{\rho(A_i), \rho(B_i)\}$. By the theta transformation formula, we have

$$(\vartheta(\tau)[0,0](\tau, z))_0 - (\vartheta(\tau)[0,0](\tau', z))_0 = m$$

where

$$m = \sum_{v \in \text{black vertex}} \frac{1}{2} B_i + \sum_{v \in \text{white vertex}} \frac{1}{2} A_i.$$

Thus, we have

$$m = \varrho(Q, \{A_i, B_i\}) - \varrho(Q, \{\rho(A_i), \rho(B_i)\}) = (1 - \rho)\varrho(Q, \{A_i, B_i\}).$$

Therefore in the group of two torsion points in $Jac(X)$, we have

$$\varrho(Q, \{A_i, B_i\}) = (1 - \rho^2)m = \sum_v \frac{1}{2}(A_i + B_i).$$

3.3. Description of $(1 - \rho)$ torsion cycles. We use the same notation as in the last subsection. We fix a numbering $\lambda_1, \dots, \lambda_m$ compatible with the cyclic ordering on the set of the terminals of the binary tree Γ . Let $\bar{\gamma}_i$ be a loop in $\mathbb{P}^1 - \Sigma$ starting the base point $b \in \mathbb{P}^1$ which turns around λ_i once anti-clockwise. The point in $C^{(i)}$ over the point b is denoted by $b(i)$ for $i = 0, 1, 2$. The lift of $\bar{\gamma}_i$ starting from $b(1)$ (resp. $b(2)$) is denoted by γ_i if the color of the vertex λ_i is white (resp. black). Then the path γ_i end at the point $b(2)$ (resp. $b(1)$) if the color of the vertex λ_i is white (resp. black).

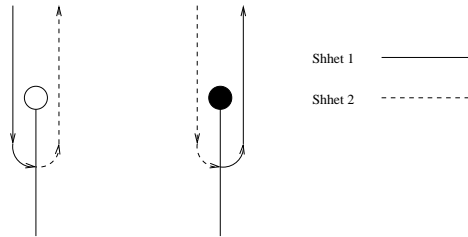

FIGURE 4. Path γ_i

Then by choosing suitable integers k_1, \dots, k_m , we have a relation

$$(3.1) \quad \rho^{k_1} \gamma_1 + \rho^{k_2} \gamma_2 + \dots + \rho^{k_m} \gamma_m = 0$$

in the group $H_1(C, \mathbb{Z})$.

The sign ϵ_i of a terminal λ_i is assigned as 1 or -1 if its color is white or black, respectively. Then the boundary of the chain $\epsilon_i \gamma_i$ is equal to $b(2) - b(1)$. We define cycles $\delta_1, \dots, \delta_{m-1}$ by

$$\delta_i = \epsilon_i \gamma_i - \epsilon_m \gamma_m.$$

By the equation (3.1), we have

$$(3.2) \quad \rho^{k_1} \epsilon_1 \delta_1 + \rho^{k_2} \epsilon_2 \delta_2 + \dots + \rho^{k_{m-1}} \epsilon_{m-1} \delta_{m-1} = 0.$$

The element in $H_1(C, \mathbb{Q}/\mathbb{Z})_{(1-\rho)}$ represented by $\frac{1}{3}(1-\rho)\delta_i$ is denoted by $\overline{\delta}_i$.

Here we give a combinatorial description of the group $H_1(C, \mathbb{Q}/\mathbb{Z})_{(1-\rho)}$. Let \mathbf{V} be the \mathbb{F}_3 -vector space $\bigoplus_{i=1}^m e_i \mathbb{F}_3$ generated by e_1, \dots, e_m . We define homomorphisms Π and Diag by

$$(3.3) \quad \begin{aligned} \Pi : \mathbf{V} &\ni \sum_i k_i e_i \mapsto \sum_i \epsilon_i k_i \in \mathbb{F}_3, \\ \text{Diag} : \mathbb{F}_3 &\ni a \mapsto a \sum_i e_i \in \mathbf{V}. \end{aligned}$$

Then the set $\{\epsilon_i e_i - \epsilon_m e_m\}_{i=1, \dots, m-1}$ is a basis of $\text{Ker}(\Pi)$. By assigning the class of $\overline{\delta}_i$ in $H^1(C, \mathbb{Q}/\mathbb{Z})_{(1-\rho)}$ to $\epsilon_i e_i - \epsilon_m e_m$, we have a map $\text{Ker}(\Pi) \rightarrow H^1(C, \mathbb{Q}/\mathbb{Z})_{(1-\rho)}$ and as a consequence, we have an isomorphism

$$(3.4) \quad \text{Ker}(\Pi)/\text{Im}(\text{Diag}) \xrightarrow{\cong} H^1(C, \mathbb{Q}/\mathbb{Z})_{(1-\rho)}.$$

They are $(m-2)$ -dimensional vector spaces.

Definition 3.4. *The quotient space $\text{Ker}(\Pi)/\text{Im}(\text{Diag})$ is obtained from the information of the binary tree (Γ, \mathcal{C}) . It is denoted by $H(\Gamma, \mathcal{C})$.*

3.4. Combinatorial computation of $\frac{1-\rho}{3}A_v$. In this subsection, we give a combinatorial rule to compute the class \overline{A}_v of $\frac{1-\rho}{3}A_v$ in $H_1(C, \mathbb{Q}/\mathbb{Z})_{(1-\rho)}$. We illustrate an element $\Lambda = \sum_i k_i e_i$ by writing k_i to each terminal λ_i in the tree Γ . (For example, see Figure 5.)

First, we consider the simplest case: $m = 3$ and the color of λ_i is white for $i = 1, 2, 3$. There is only one inner black vertex. We assume that λ_3 is marked. Then we have $A_v = \gamma_2 - \gamma_1$ as in Figure 5. Via the isomorphism

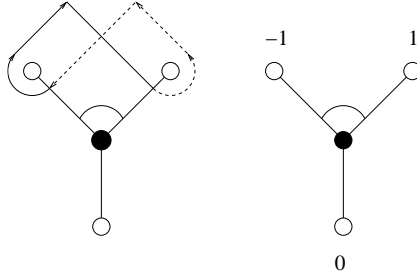

FIGURE 5. Simplest case

(3.4), we have $\overline{A}_v = e_2 - e_1$. Similarly we can compute the image of \overline{A}_v

in the case: $m = 3$ and the color of λ_i is black. In this case, we also have $\overline{A_v} = e_2 - e_1$. Note that the class of $\rho(\frac{1-\rho}{3}A_v)$ is equal to $\overline{A_v}$ in each case.

Next, we consider a general situation. Let v be a black vertex connected to three blocks $\mathbf{B}_1, \mathbf{B}_2, \mathbf{B}_3$. (A block may be one point.) Recall that the cycle A_v is given in Figure 6. We reduce the computation $\overline{A_v}$ to the following

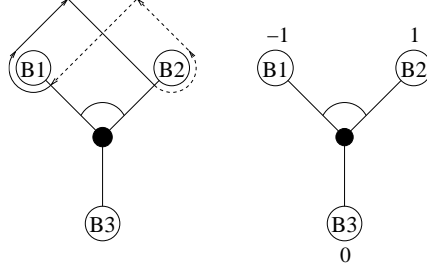

FIGURE 6. General case

“local deformation rule”. Figure 7 is a local picture contained in \mathbf{B}_2 . The blocks connected to an inner vertex p are denoted by $\mathbf{C}_1, \mathbf{C}_2$ and \mathbf{C}_3 . Let γ be a path starting from $b(2)$ ending at $b(1)$ turning around \mathbf{C}_1 and \mathbf{C}_2 as in Figure 7. Note that the path γ is homotopic to $\rho(\gamma_{\mathbf{C}_1}) + \rho^2(\gamma_{\mathbf{C}_2})$, where $\gamma_{\mathbf{C}_i}$ is a path turning around the block \mathbf{C}_i anti-clockwise. Similarly, if p is a white vertex, γ is homotopic to $\rho^2(\gamma_{\mathbf{C}_1}) + \rho(\gamma_{\mathbf{C}_2})$. By this local deformation rule,

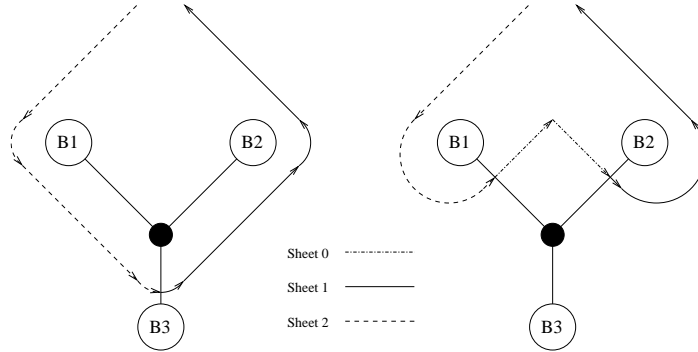

FIGURE 7. Local deformation

the coefficient of e_i in $\overline{A_v}$ is equal to $-1, 1$ and 0 if the terminal λ_i belongs to $\mathbf{B}_1, \mathbf{B}_2$ and \mathbf{B}_3 , respectively.

Finally, we have the following proposition.

Proposition 3.5. (1) *The class $\overline{A_v} \in H_1(C, \mathbb{Q}/\mathbb{Z})_{(1-\rho)}$ of $\frac{1}{3}(1-\rho)A_v$ is equal to the element*

$$-\sum_{\lambda_i \in \mathbf{B}_1 \cap \Sigma} e_i + \sum_{\lambda_i \in \mathbf{B}_2 \cap \Sigma} e_i = -\sum_{\lambda_i \in \mathbf{B}_2 \cap \Sigma} e_i + \sum_{\lambda_i \in \mathbf{B}_3 \cap \Sigma} e_i = -\sum_{\lambda_i \in \mathbf{B}_3 \cap \Sigma} e_i + \sum_{\lambda_i \in \mathbf{B}_1 \cap \Sigma} e_i$$

via the isomorphism (3.4).

- (2) If v is a black vertex (resp. a white vertex), then $\overline{A_v} \equiv \frac{1}{3}(-A_v + B_v) \pmod{H_1(C, \mathbb{Z})}$ (resp. $\overline{A_v} \equiv \frac{1}{3}(A_v - B_v) \pmod{H_1(C, \mathbb{Z})}$).
- (3) The set $\{\overline{A_v}\}_{v \in V(\Gamma)}$ forms a basis of $H_1(C, \mathbb{Q}/\mathbb{Z})_{(1-\rho)}$.

3.5. A decomposition of a marked binary tree. In this subsection, we consider a decomposition of a marked tree. Let (Γ, \mathcal{C}, M) be a marked binary tree and E be its edge. Let p and q be white and black vertices adjacent to E , respectively. Let \mathbf{C}_p and \mathbf{C}_q be two blocks containing p and q , respectively. We define subspaces H_p and H_q of $H(\Gamma, \mathcal{C})$ by

$$H_p = \left\{ \sum_{v \in \Sigma} a_v e_v \in H(\Gamma, \mathcal{C}) \mid a_v = a_{v'} \text{ for } v, v' \in \mathbf{C}_q \cap \Sigma \right\},$$

$$H_q = \left\{ \sum_{v \in \Sigma} a_v e_v \in H(\Gamma, \mathcal{C}) \mid a_v = a_{v'} \text{ for } v, v' \in \mathbf{C}_p \cap \Sigma \right\}.$$

We remark that the condition in the definition of H_p and H_q does not depend on the representative modulo $Im(\text{Diag})$. By cutting the edge E of tree and inserting black and white vertices to \mathbf{C}_p and \mathbf{C}_q , we get marked binary trees $(\Gamma_p, \mathcal{C}_p, M_p)$ and $(\Gamma_q, \mathcal{C}_q, M_q)$ as in the following picture.

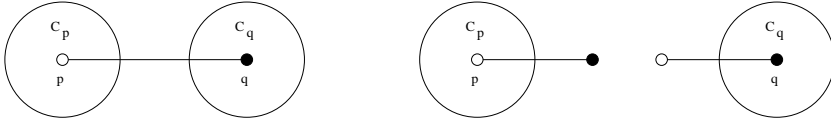

FIGURE 8. Decomposition of a marked binary tree

It is easy to see the following lemma.

- Lemma 3.6.** (1) The element $\overline{A_v}$ belongs to the space H_p and H_q if v belongs to \mathbf{C}_p and \mathbf{C}_q , respectively.
- (2) The space $H_1(C, \mathbb{Q}/\mathbb{Z})_{(1-\rho)}$ is the direct sum of H_p and H_q . The sets $\{\overline{A_v}\}_{v \in V(\Gamma_p)}$ and $\{\overline{A_v}\}_{v \in V(\Gamma_q)}$ form bases of H_p and H_q , respectively.
- (3) The vector spaces H_p and H_q are naturally isomorphic to $H(\Gamma_p, \mathcal{C}_p)$ and $H(\Gamma_q, \mathcal{C}_q)$, respectively.

4. STABLE DEGENERATION OF TRIPLE COVERINGS OF \mathbb{P}^1

In this section, we compare a decomposition of a marked binary tree and a stable degeneration of triple coverings of \mathbb{P}^1 .

Let $\lambda_1, \dots, \lambda_m$ be points in $\mathbb{C} - \{0\}$. Let (Γ, \mathcal{C}, M) be a marked binary tree whose set of terminals is $\{\lambda_1, \dots, \lambda_m\}$. The branching indices of $\lambda_1, \dots, \lambda_m$ are written as $a_1/3, \dots, a_m/3$. We choose an edge E and obtain two blocks $\mathbf{C}_p, \mathbf{C}_q$ by cutting E as in the last section. By renumbering the set of terminals, we can assume that $\mathbf{C}_p \cap \Sigma = \{\lambda_1, \dots, \lambda_l\}$ and $\mathbf{C}_q \cap \Sigma = \{\lambda_{l+1}, \dots, \lambda_m\}$ and that the cyclic order of the terminals is equal to $\lambda_1, \dots, \lambda_m$. We consider a deformation of the set of terminals parametrized by t as

$$\lambda_i(t) = t\lambda_i \quad (i = 1, \dots, l), \quad \lambda_i(t) = \lambda_i \quad (i = l+1, \dots, m).$$

Suppose that $\lambda_1, \dots, \lambda_l$ are sufficiently close to 0. We consider a family of triple coverings $C(t)$ of \mathbb{P}^1 parametrized by $t \in \Delta^*(t) = \{t \in \mathbb{C} \mid 0 < |t| < 1\}$ as

$$(4.1) \quad y^3 = \prod_{i=1}^m (x - \lambda_i(t))^{a_i}.$$

This family extends to a stable model by the base change $\varepsilon^3 = t$. We write down an affine birational model as follows. Let \mathcal{X} be a submanifold of $\mathbb{C}^1 \times \mathbb{C}^1 \times \Delta(\varepsilon)$ defined by

$$\mathcal{X} = \{(x, \xi, \varepsilon) \in \mathbb{P}^1 \times \mathbb{P}^1 \times \Delta \mid x\xi = \varepsilon^3\}.$$

Let a, b be elements in $\{1, 2\}$ satisfying $\sum_{i=1}^l a_i \equiv a \pmod{3}$ and $\sum_{i=l+1}^m a_i \equiv b \pmod{3}$. Let \mathcal{Y} be the triple covering of \mathcal{X} defined by new coordinates y_1, y_2 satisfying

$$(4.2) \quad y_1^3 = x^a \prod_{i=1}^l (1 - \lambda_i \xi)^{a_i} \prod_{i=l+1}^m (x - \lambda_i)^{a_i},$$

$$(4.3) \quad y_2^3 = \xi^b \prod_{i=1}^l (1 - \lambda_i \xi)^{a_i} \prod_{i=l+1}^m (x - \lambda_i)^{a_i},$$

with $\xi y_1 = \varepsilon^a y_2, x y_2 = \varepsilon^b y_1$. Then $\varphi : \mathcal{Y} \rightarrow \Delta(\varepsilon)$ is a family of affine curves over $\Delta(\varepsilon)$. The fiber of \mathcal{Y} at the origin $\tau = 0$ is the union of two triple coverings of \mathbb{P}^1 connected at one point. One component is the restriction of (4.2) to $\xi = 0$ and the other is that of (4.3) to $x = 0$.

We define a family of marked binary trees $(\Gamma_p, \mathcal{C}_p, M_p)(t) \amalg (\Gamma_q, \mathcal{C}_q, M_q)(t)$ with two components parametrized by t . We set $(\Gamma_q, \mathcal{C}_q, M_q)(t)$ as a constant family, since $\mathcal{C}_q \cap \Sigma = \{\lambda_{l+1}, \dots, \lambda_m\}$. We set the tree $\Gamma_p(t)$ as the multiplication of the original tree by t for $t \in \Delta^*$ since $\mathcal{C}_p \cap \Sigma = \{\lambda_1, \dots, \lambda_l\}$. Its coloring and marking are naturally defined by the multiplication by t . By using the coordinate ξ , we see that this tree is continued to $\varepsilon = 0$.

Proposition 4.1. *The monodromy around $\varepsilon = 0$ acts trivially on the family of the relative homology $R_1 \varphi_* \mathbb{Z}$.*

Proof. For a point $t = 1$, the symplectic basis $\{A_v, B_v\}_{v \in V(\Gamma)}$ associated to (Γ, \mathcal{C}, M) is equal to the union of those associated to $(\Gamma_p, \mathcal{C}_p, M_p)$ and $(\Gamma_q, \mathcal{C}_q, M_q)$. They are extended continuously to $\varepsilon = 0$. \square

Remark 4.2. *Repeating this degeneration process, any triple covering of \mathbb{P}^1 degenerates to the union of elliptic curves E_v ($v \in V(\Gamma)$) with complex multiplication with $\mathbb{Z}[\omega]$, which is called a totally degenerated curve. The binary tree is equal to the dual graph of the totally degenerated curve. The color of an inner vertex v corresponds to the eigen value of the action of ρ on $H^0(E_v, \Omega^1)$.*

5. DEGENERATIONS OF PERIOD INTEGRALS AND THEIR DETERMINANTS

5.1. Deformation of period integrals. In this section, we study degenerations of period integrals for the simplest case. We use the same notations $\lambda_1, \dots, \lambda_m$ for branch points, $a_1/3, \dots, a_m/3$ for branching indices and a marked binary tree (Γ, \mathcal{C}, M) . Therefore the color of a vertex λ_i is white if and only if $a_i = 1$. In this section, we assume that λ_i and λ_{i+1} is adjacent to a common inner vertex p . Thus the colors of λ_i and λ_{i+1} are same. The third vertex adjacent to p is denoted by q . Moreover we assume that the edge to q is marked for the vertex p . If the vertices λ_i and λ_{i+1} are white, the situation is illustrated in Figure 9.

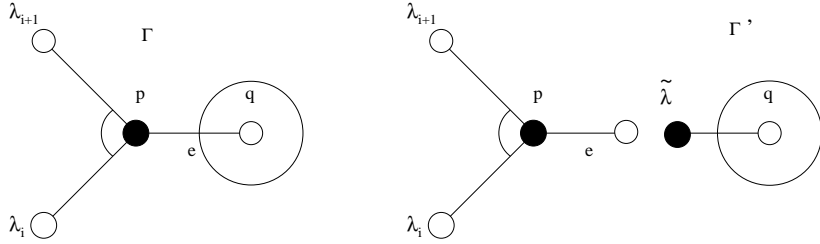

FIGURE 9. Simple degeneration

Let $\{A_v, B_v\}$ be the symplectic basis of $H_1(C, \mathbb{Z})$. Let $\tilde{\lambda}$ be a point different from λ_j for $j \neq i, i+1$ and consider the family of points $\lambda_j(t)$ defined by $\lambda_j(t) = \lambda_j$ for $j \neq i, i+1$ and $\lambda_k(t) = \tilde{\lambda} + t(\lambda_k - \tilde{\lambda})$ for $k = i, i+1$. We consider the family of curves (4.1) branched at $\Sigma(t) = \{\lambda_1(t), \dots, \lambda_m(t)\}$. By changing parameter t to ε defined as $t = \varepsilon^3$, we get a stable degeneration associated to the above decomposition of the binary tree as in the last section. The tree containing the vertex q obtained by this decomposition is denoted by $(\Gamma', \mathcal{C}', M')$.

Let y_1 and y_2 be rational functions on C defined by

$$y_1^3 = \prod_{j=1}^m (x - \lambda_j(t))^{a_j},$$

$$y_2^3 = \prod_{j=1}^m (x - \lambda_j(t))^{b_j},$$

where $b_j = 3 - a_j$. Let $d_1 = \sum_j a_j - 1$ and $d_2 = \sum_j b_j - 1$. We define a family of differential forms $\eta_j(t)$ for $j = 1, \dots, d_1 + d_2$ by

$$\eta_j = \frac{x^{j-1} dx}{y_1} \quad \text{for } j = 1, \dots, d_1,$$

$$\eta_{j+d_1} = \frac{x^{j-1} dx}{y_2} \quad \text{for } j = 1, \dots, d_2.$$

Then $\{\eta_1, \dots, \eta_{d_1+d_2}\}$ is a basis of $H^0(X, \Omega^1)$.

Proposition 5.1. *Assume that the colors of λ_i and λ_{i+1} are white. We set*

$$\widetilde{\eta}_{j+d_1} = \frac{(x - \tilde{\lambda})^{j-1} dx}{y_1} \quad \text{for } j = 1, \dots, d_2.$$

(1) *We have*

$$\begin{aligned} \lim_{t \rightarrow 0} \int_{B_p} \eta_j(t) &= 0 \quad \text{for } j = 1, \dots, d_1, \\ \lim_{t \rightarrow 0} \int_{B_p} \widetilde{\eta}_j(t) &= 0 \quad \text{for } j = d_1 + 2, \dots, d_1 + d_2, \end{aligned}$$

and

$$\lim_{t \rightarrow 0} t \cdot (\lambda_i - \lambda_{i+1}) \left(\int_{B_p} \widetilde{\eta}_{d_1+1}(t) \right)^3 = B^* \left(\frac{1}{3}, \frac{1}{3} \right)^3 \prod_{k \neq i, i+1} (\tilde{\lambda} - \lambda_k)^{-b_k}.$$

Here we set $B^* \left(\frac{1}{3}, \frac{1}{3} \right) = (\omega - 1) B \left(\frac{1}{3}, \frac{1}{3} \right)$.

(2) *The limit*

$$\lim_{t \rightarrow 0} \int_{B_v} \widetilde{\eta}_{d_1+1}(t)$$

is finite for $v \neq p$.

(3) *We set*

$$\begin{aligned} \overline{\eta}_j &= \frac{x^{j-1} dx}{y_1} \quad \text{for } j = 1, \dots, d_1, \\ \overline{\eta}_{j+d_1} &= \frac{(x - \tilde{\lambda})^{j-1} dx}{\overline{y}_2} \quad \text{for } j = 1, \dots, d_2 - 1, \end{aligned}$$

where

$$\begin{aligned} \overline{y}_1^3 &= (x - \tilde{\lambda})^2 \prod_{k \neq i, i+1}^m (x - \lambda_k)^{a_k}, \\ \overline{y}_2^3 &= (x - \tilde{\lambda}) \prod_{k \neq i, i+1}^m (x - \lambda_k)^{b_k}. \end{aligned}$$

Then we have

$$\begin{aligned} \lim_{t \rightarrow 0} \int_{B_v} \eta_j(t) &= \int_{B_v} \overline{\eta}_j \quad \text{for } j = 1, \dots, d_1, \\ \lim_{t \rightarrow 0} \int_{B_v} \widetilde{\eta}_j(t) &= \int_{B_v} \overline{\eta}_{j-1} \quad \text{for } j = d_1 + 2, \dots, d_1 + d_2, \end{aligned}$$

for $v \neq p$.

Proof. We prove (1). We compute the integral

$$\int_{B_p} \frac{dx}{y_2(t)} = \omega^i (1 - \omega) \int_{\lambda_i(t)}^{\lambda_{i+1}(t)} \frac{dx}{(x - \lambda_i(t))^{2/3} (x - \lambda_{i+1}(t))^{2/3} \prod_{k \neq i, i+1} (x - \lambda_k)^{b_k/3}}$$

by the variable change $x = \tilde{\lambda} + t(\xi - \tilde{\lambda})$. Since $x - \lambda_i(t) = t(\xi - \lambda_i)$, ξ varies $\lambda_i < \xi < \lambda_{i+1}$. Using $x - \lambda_k = \tilde{\lambda} - \lambda_k + t(\xi - \tilde{\lambda})$, we have

$$\begin{aligned} \lim_{t \rightarrow 0} t^{1/3} \int_{B_p} \frac{dx}{y_2(t)} &= \frac{\omega^i(1-\omega)}{\prod_{k \neq i, i+1} (\tilde{\lambda} - \lambda_k)^{b_k/3}} \int_{\lambda_i}^{\lambda_{i+1}} \frac{d\xi}{(\xi - \lambda_i)^{2/3}(\xi - \lambda_{i+1})^{2/3}} \\ &= \frac{-\omega^{i'}(1-\omega)}{(\lambda_i - \lambda_{i+1})^{1/3} \prod_{k \neq i, i+1} (\tilde{\lambda} - \lambda_k)^{b_k/3}} B\left(\frac{1}{3}, \frac{1}{3}\right). \end{aligned}$$

We can similarly prove the rests. \square

5.2. Deformation of period matrices. We define the period matrices $P_A = P_A(\Sigma, \Gamma, \mathcal{C}, M)$ and $P_B = P_B(\Sigma, \Gamma, \mathcal{C}, M)$ associated to the configuration of points $\Sigma = \{\lambda_1, \dots, \lambda_m\}$ and a marked binary tree (Γ, \mathcal{C}, M) by

$$\begin{aligned} P_A(\Sigma, \Gamma, \mathcal{C}, M) &= \left(\int_{A_v} \eta_1 \quad \dots \quad \int_{A_v} \eta_{d_1+d_2-2} \right)_{v \in V(\Gamma)}, \\ P_B(\Sigma, \Gamma, \mathcal{C}, M) &= \left(\int_{B_v} \eta_1 \quad \dots \quad \int_{B_v} \eta_{d_1+d_2-2} \right)_{v \in V(\Gamma)}. \end{aligned}$$

We consider a family of configuration $\Sigma(t)$ defined in the last subsection. Then we have a family of period matrices $P_B(\Sigma(t), \Gamma, \mathcal{C}, M)$. We set

$$\Sigma' = \{\lambda_1, \dots, \lambda_{i-1}, \tilde{\lambda}, \lambda_{i+2}, \dots, \lambda_m\}.$$

Then we have the following proposition.

Proposition 5.2. *We have*

$$\begin{aligned} &\lim_{t \rightarrow 0} t(\lambda_i - \lambda_{i+1}) \det(P_B(\Sigma(t), \Gamma, \mathcal{C}, M))^3 \\ &= B^*\left(\frac{1}{3}, \frac{1}{3}\right)^3 \prod_{k \neq i, i+1} (\tilde{\lambda} - \lambda_k)^{-b_k} \cdot \det(P_B(\Sigma', \Gamma', \mathcal{C}', M'))^3, \end{aligned}$$

where the marked binary tree $(\Gamma', \mathcal{C}', M')$ is obtained by the decomposition of the marked binary tree of (Γ, \mathcal{C}, M) illustrated in Figure 9.

5.3. Equi-distributed characteristics and theta constants. Let $\lambda_1, \dots, \lambda_m$ be a configuration of points in \mathbb{P}^1 , $a_1/3, \dots, a_m/3$ be the branching index of $\lambda_1, \dots, \lambda_m$ and (Γ, \mathcal{C}, M) be a marked binary tree as in the beginning of this section. Let Σ and $\bar{\Sigma}$ be sets given by

$$\Sigma = \{\lambda_i \mid a_i = 1\}, \quad \bar{\Sigma} = \{\lambda_i \mid a_i = 2\}.$$

Let $\Lambda = \sum_i k_i e_i$ be an element in $\oplus_{i=1}^m \mathbb{F}_3 e_i$. We set $\Lambda_i, \bar{\Lambda}_i$ for $i = 0, 1, 2$ by

$$\Lambda_i = \{\lambda_j \in \Sigma \mid k_j = i\}, \quad \bar{\Lambda}_i = \{\lambda_j \in \bar{\Sigma} \mid k_j = i\}.$$

The element Λ is in the kernel of $\Pi : \oplus_{i=1}^m \mathbb{F}_3 e_i \rightarrow \mathbb{F}_3$ defined in (3.3) if and only if

$$(5.1) \quad \#\Lambda_1 - \#\bar{\Lambda}_1 + 2(\#\Lambda_2 - \#\bar{\Lambda}_2) \equiv 0 \pmod{3}.$$

An element Λ is said to be equi-distributed if and only if

$$\#\Lambda_0 - \#\bar{\Lambda}_0 = \#\Lambda_1 - \#\bar{\Lambda}_1 = \#\Lambda_2 - \#\bar{\Lambda}_2.$$

By (5.1), an equi-distributed element Λ gives an element in $H_1(C, \mathbb{Q}/\mathbb{Z})_{(1-\rho)}$. If the colors of all terminals are white, an element $\Lambda \in \mathbf{V}$ is equi-distributed if and only if it satisfies the condition (2.3).

We consider the decomposition of the marked binary tree as in Figure 9. For an element $\Lambda = \sum_j k_j e_j \in H(\Gamma, \mathcal{C})$, we define an element $\Lambda' \in H(\Gamma', \mathcal{C}')$ by $\Lambda' = -(k_i + k_{i+1})e_{\tilde{\lambda}} + \sum_{j \neq i, i+1} k_j e_j$. The following lemma is easy to see.

Lemma 5.3. *Let Λ be an equi-distributed element in $\oplus_i \mathbb{F}_3 e_i$. Suppose that $k_i \neq k_{i+1}$. Then Λ' is also equi-distributed.*

We consider the limit of the normalized period matrix. The fiber of the stable curve at $\varepsilon = 0$ becomes the union of C_1 and C_2 , where

$$\begin{aligned} C_1 : y^3 &= (x - \lambda_i)(x - \lambda_{i+1}), \\ C_2 : \eta^3 &= (\xi - \tilde{\lambda})^2 \prod_{j \neq i, i+1} (\xi - \lambda_j)^{a_j}, \end{aligned}$$

as in the last section. Since the variation of Hodge structure is smooth, we can compute the limit by considering logarithmic differentials. We consider a continuous extension of the symplectic basis $\{A_v, B_v\}_{v \in V(\Gamma)}$. Then $\{A_p, B_p\}$ is a symplectic basis of C_1 and $\{A_v, B_v\}_{v \in V(\Gamma')}$ is that of C_2 in Figure 9. Let τ_i be the normalized period matrix of C_i for $i = 1, 2$. Then we have

$$\lim_{\varepsilon \rightarrow 0} \tau = \begin{pmatrix} \tau_1 & 0 \\ 0 & \tau_2 \end{pmatrix}.$$

Under the above notations, we have the following proposition, by the computation of Riemann constants in §3.2.

Proposition 5.4. *Let ϱ , ϱ_1 and ϱ_2 be the Riemann constants for symplectic bases $\{A_v, B_v\}_{v \in V(\Gamma)}$, $\{A_p, B_p\}$ and $\{A_v, B_v\}_{v \in V(\Gamma')}$. Then we have*

$$\lim_{\varepsilon \rightarrow 0} \vartheta(\tau(\varepsilon)) [\Lambda + \varrho]^6 = \vartheta(\tau_1) \left[\frac{1-\varrho}{3} A_p + \varrho_1 \right]^6 \cdot \vartheta(\tau_2) [\Lambda' + \varrho_2]^6.$$

Here, we use the identification (2.2) and the remark just after it. Moreover, we have

$$\vartheta(\tau_1) \left[\frac{1-\varrho}{3} A_p + \varrho_1 \right]^6 = \frac{3^{9/4}}{(2\pi)^6} \Gamma(1/3)^9 \exp\left(\frac{-5\pi i}{12}\right).$$

Proof. As for the last statement, we use the formula (c.f. [MTY]):

$$(5.2) \quad \vartheta(\omega) \left[\frac{1}{6}, \frac{-1}{6} \right]^6 = \frac{3^{9/4}}{(2\pi)^6} \Gamma(1/3)^9 \exp\left(\frac{-5\pi i}{12}\right).$$

□

6. THOMAE'S FORMULA AND THOMAE'S CONSTANT FOR ARBITRARY BRANCHING INDICES

Now we are ready to give the statement of Thomae's theorem for arbitrary indices. By the inductive structure, we also evaluate the constants appeared in Thomae's theorem.

Let $C \rightarrow \mathbb{P}^1$ be the cyclic triple covering branching at a set $\Sigma = \{\lambda_1, \dots, \lambda_m\}$ of \mathbb{P}^1 and $a_1/3, \dots, a_m/3$ be branching indices at $\lambda_1, \dots, \lambda_m$, respectively. Let (Γ, \mathcal{C}, M) be a marked binary tree whose set of terminals is Σ , $\{A_v, B_v\}$ be the associated symplectic basis, and Λ be an equi-distributed element in $H(\Gamma, \mathcal{C})$. We set $\Lambda_i, \overline{\Lambda}_i$ as in the last section.

Definition 6.1. (1) Let A_1, A_2 be Λ_i or $\overline{\Lambda}_i$ ($i = 0, 1, 2$) and $A_1 \neq A_2$. We define (A_1, A_2) by

$$(A_1, A_2) = \prod_{\lambda \in A_1, \mu \in A_2} (\lambda - \mu),$$

and (A_1, A_1) by

$$(A_1, A_1) = \prod_{i < j, \lambda_i, \lambda_j \in A_1} (\lambda_i - \lambda_j).$$

(2) The difference product $\Delta(\Sigma, \Lambda)$ of an equi-distributed characteristic Λ is defined by

$$\Delta(\Sigma, \Lambda) = \prod_{i=0}^2 (\Lambda_i \Lambda_i)^3 (\overline{\Lambda}_i \overline{\Lambda}_i)^3 \cdot \prod_{0 \leq i < j \leq 2} (\Lambda_i \Lambda_j) (\overline{\Lambda}_i \overline{\Lambda}_j) \cdot \prod_{0 \leq i \neq j \leq 2} (\Lambda_i \overline{\Lambda}_j)^2.$$

Theorem 6.2. (1) Under the above notations, we have

$$\vartheta(\tau) [\Lambda + \varrho]^6 = \pm \kappa_\Lambda \cdot \Delta(\Sigma, \Lambda) \cdot \det(P_B(\Sigma, \Gamma, \mathcal{C}, M))^3,$$

where κ_Λ is an absolute constant depending only on Λ . Moreover κ_Λ^6 does not depend on the choice of Λ .

(2) The constant κ_Λ^6 is equal to $\kappa^{6(v_1+v_2)}$, where

$$(6.1) \quad \kappa = ((2\pi)^3 3^{3/4} \exp(\frac{11\pi i}{12}))^{-1}$$

and v_1 and v_2 are the numbers of white and black inner vertices, respectively.

Let us prove the above theorem. We consider the degeneration studied in Section 5. We use the notations $\Gamma', \mathcal{C}', \Sigma'$ and Λ' as in the last section. Let $\Lambda = \sum_i k_i e_i$ be an equi-distributed element in $H(\Gamma, \mathcal{C})$. We prove the case: $k_i = 2, k_{i+1} = 1$ and $a_i = a_{i+1} = 1$. The other cases can be similarly proved. We prepare Lemma 6.3 and Proposition 6.4.

Lemma 6.3. We have

$$\frac{1}{\prod_i (\tilde{\lambda} - \lambda_i)^{b_i}} \cdot \lim_{\epsilon \rightarrow 0} \left[\frac{\Delta(\Sigma(\epsilon), \Lambda)}{t(\lambda_i - \lambda_{i+1})} \right] = \Delta(\Sigma', \Lambda').$$

Proof. We consider a family of the difference product $(\Lambda_i(t), \Lambda_j(t))$ and so on. Then we have

$$\Lambda'_2 = \Lambda_2 - \{\lambda_i\}, \quad \Lambda'_1 = \Lambda_1 - \{\lambda_{i+1}\}, \quad \overline{\Lambda}'_0 = \overline{\Lambda}_0 \cup \{\tilde{\lambda}\}.$$

Therefore, we have

$$\begin{aligned}
\lim_{t \rightarrow 0} (\Lambda_i(t) \Lambda_i(t))^3 &= (\Lambda'_i \Lambda'_i)^3 (\Lambda'_i, \tilde{\lambda})^3 \quad i = 1, 2, \\
\lim_{t \rightarrow 0} (\Lambda_0(t) \Lambda_i(t)) &= (\Lambda_0 \Lambda'_i) (\Lambda_0, \tilde{\lambda}) \quad i = 1, 2, \\
\lim_{t \rightarrow 0} \frac{1}{t} (\Lambda_1(t) \Lambda_2(t)) &= (\Lambda'_1 \Lambda'_2) (\Lambda'_1, \tilde{\lambda}) (\Lambda'_2, \tilde{\lambda}) (\lambda_i - \lambda_{i+1}), \\
\lim_{t \rightarrow 0} (\Lambda_i(t) \overline{\Lambda_0}(t))^2 &= (\Lambda'_i \overline{\Lambda_0}')^2 (\Lambda'_i, \tilde{\lambda})^{-2} (\tilde{\lambda} \overline{\Lambda_0})^2 \quad i = 1, 2, \\
\lim_{t \rightarrow 0} (\Lambda_i(t) \overline{\Lambda_j}(t))^2 &= (\Lambda'_i \overline{\Lambda_j}')^2 (\tilde{\lambda} \overline{\Lambda_j})^2 \quad (i, j) = (1, 2) \text{ or } (2, 1), \\
\lim_{t \rightarrow 0} (\overline{\Lambda_0}(t) \overline{\Lambda_0}(t))^3 &= (\overline{\Lambda_0}' \overline{\Lambda_0}')^3 (\tilde{\lambda} \overline{\Lambda_0})^{-3}, \\
\lim_{t \rightarrow 0} (\overline{\Lambda_0}(t) \overline{\Lambda_i}(t)) &= (\overline{\Lambda_0}' \overline{\Lambda_i}') (\tilde{\lambda} \overline{\Lambda_i})^{-1} \quad i = 1, 2.
\end{aligned}$$

Since

$$\prod_{k \neq i, i+1} (\tilde{\lambda} - \lambda_i)^{b_i} = (\Lambda'_1, \tilde{\lambda})^2 (\Lambda'_2, \tilde{\lambda})^2 (\Lambda_0, \tilde{\lambda})^2 (\overline{\Lambda_0}, \tilde{\lambda}) (\overline{\Lambda_1}, \tilde{\lambda}) (\overline{\Lambda_2}, \tilde{\lambda}),$$

we have the lemma. \square

Proposition 6.4. (1) *The statement (1) of Theorem 6.2 for (Γ, \mathcal{C}, M) implies the same statement for $(\Gamma', \mathcal{C}', M')$.*
(2) *Suppose that the statement (1) of Theorem 6.2 holds for Γ and Γ' . Then we have the recursive relation*

$$\kappa_\Lambda = \pm \kappa_{\Lambda'} \kappa,$$

where κ is defined in (6.1)

Proof. (1) We assume that the statement holds for the set of terminals $\Sigma(\epsilon)$ of (Γ, \mathcal{C}, M) with $\epsilon \neq 0$. We consider the following limit:

$$\begin{aligned}
(6.2) \quad \vartheta(\tau_1)[\Lambda_1 + \varrho_1]^6 \vartheta(\tau')[\Lambda' + \varrho']^6 \\
&= \lim_{\epsilon \rightarrow 0} \vartheta(\tau(\epsilon))[\Lambda + \varrho]^6 \\
&= \pm \kappa_\Lambda \lim_{\epsilon \rightarrow 0} \left[\Delta(\Sigma(\epsilon), \Lambda) \cdot \det(P_B(\Sigma(\epsilon), \Gamma, \mathcal{C}, M))^3 \right] \\
&= \pm \kappa_\Lambda \lim_{\epsilon \rightarrow 0} \left[t(\lambda_i - \lambda_{i+1}) \det(P_B(\Sigma(\epsilon), \Gamma, \mathcal{C}, M))^3 \right] \cdot \lim_{\epsilon \rightarrow 0} \left[\frac{\Delta(\Sigma(\epsilon), \Lambda)}{t(\lambda_i - \lambda_{i+1})} \right] \\
&= \pm \frac{B^*(\frac{1}{3}, \frac{1}{3})^3 \kappa_\Lambda}{\prod_i (\tilde{\lambda} - \lambda_i)^{b_i}} \cdot \lim_{\epsilon \rightarrow 0} \left[\frac{\Delta(\Sigma(\epsilon), \Lambda)}{t(\lambda_i - \lambda_{i+1})} \right] \cdot \det(P_B(\Sigma', \Gamma', \mathcal{C}', M'))^3.
\end{aligned}$$

By Lemma 6.3 and the equality (6.2), we have

$$\vartheta(\tau')[\Lambda']^6 = \pm \kappa_{\Lambda'} \Delta(\Sigma', \Lambda') \cdot \det(P_B(\Sigma', \Gamma', \mathcal{C}', M'))^3,$$

where

$$\begin{aligned}
\kappa_{\Lambda'} &= \pm \vartheta(\tau_1) [\Lambda_1]^{-6} B^* \left(\frac{1}{3}, \frac{1}{3} \right)^3 \kappa_{\Lambda} \\
&= \pm \frac{(2\pi)^6}{3^{9/4}} \exp\left(\frac{5\pi i}{12}\right) (\omega - 1)^3 \frac{3^{3/2}}{(2\pi)^3} \kappa_{\Lambda} \\
&= \pm (2\pi)^3 3^{3/4} \exp\left(\frac{11\pi i}{12}\right) \kappa_{\Lambda}.
\end{aligned}$$

□

Proof of Theorem 6.2. We consider the case there exists a procedure of degenerations

$$(6.3) \quad \Lambda \rightarrow \Lambda_1 + \Lambda^{(1)} \rightarrow \Lambda_1 + \Lambda_2 + \Lambda^{(2)} \rightarrow \cdots \rightarrow \Lambda_1 + \cdots + \Lambda_g,$$

with $\kappa_{\Lambda_i} \neq 0$. In this case, by applying Proposition 6.4, we have the theorem.

If all terminals are white, since we know that κ_{Λ}^6 is independent of the choice of Λ , we have the theorem once we know the existence of Λ and the procedure of degenerations (6.3). Actually we can choose such Λ and procedure (6.3).

Now we prove the general case. For any marked binary graph and any equi-distributed element Λ , we can choose procedure

$$\bar{\Lambda} \rightarrow \Lambda_1 + \Lambda^{(1)} \rightarrow \Lambda_1 + \Lambda_2 + \Lambda^{(2)} \rightarrow \cdots \Lambda_1 + \cdots + \Lambda_k + \Lambda,$$

where $\kappa_{\Lambda_i} \neq 0$ and $\bar{\Lambda}$ is a equi-distributed element for a marked binary graph whose terminals are white. Since we know the theorem on $\bar{\Lambda}$, we have the theorem for Λ . □

7. AN EXAMPLE

We consider the following marked binary tree in Figure 10 and an equi-distributed element $-e_1 + e_2 + e_3 - e_4 \in H(\Gamma, \mathcal{C})$. We assume that $\lambda_1 < \lambda_2 < \lambda_3 < \lambda_4 \in \mathbb{R}$ to fix a branch of the third roots.

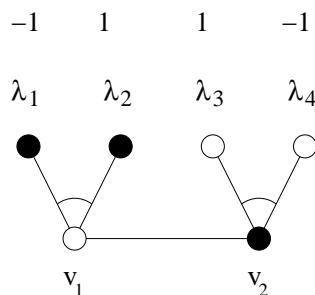

FIGURE 10. Example

Then the branches of y_1, y_2 are given in Figure 11. Thus we have $A =$

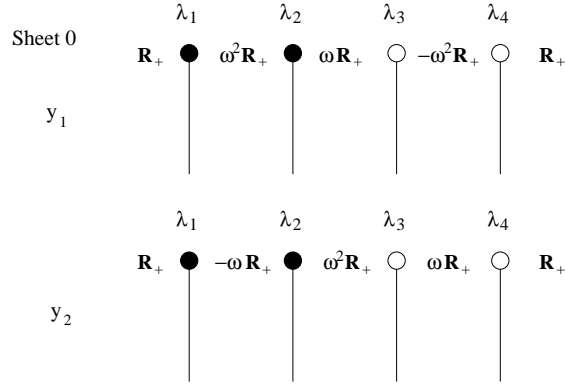

FIGURE 11. Values on branches

$(a_{ij}), B = (b_{ij})$ with

$$a_{11} = \int_{A_1} \frac{dx}{y_1} = (\omega^2 - 1) \int_{\lambda_1}^{\lambda_2} \frac{dx}{\sqrt[3]{(x - \lambda_1)^2(\lambda_2 - x)^2(\lambda_3 - x)(\lambda_4 - x)}},$$

$$a_{21} = \int_{A_2} \frac{dx}{y_1} = (\omega^2 - 1) \int_{\lambda_3}^{\lambda_4} \frac{dx}{\sqrt[3]{(x - \lambda_1)^2(x - \lambda_2)^2(x - \lambda_3)(\lambda_4 - x)}},$$

$$a_{12} = \int_{A_2} \frac{dx}{y_2} = (1 - \omega) \int_{\lambda_3}^{\lambda_4} \frac{dx}{\sqrt[3]{(x - \lambda_1)(x - \lambda_2)(x - \lambda_3)^2(\lambda_4 - x)^2}},$$

$$a_{22} = \int_{A_1} \frac{dx}{y_2} = (1 - \omega) \int_{\lambda_1}^{\lambda_2} \frac{dx}{\sqrt[3]{(x - \lambda_1)(\lambda_2 - x)(\lambda_3 - x)^2(\lambda_4 - x)^2}},$$

$$b_{11} = \int_{B_1} \frac{dx}{y_1} = \omega^2 \int_{A_1} \frac{dx}{y_1}, \quad b_{21} = \int_{B_2} \frac{dx}{y_1} = \omega \int_{A_2} \frac{dx}{y_1},$$

$$b_{12} = \int_{B_1} \frac{dx}{y_2} = \omega \int_{A_1} \frac{dx}{y_2}, \quad b_{22} = \int_{B_2} \frac{dx}{y_2} = \omega^2 \int_{A_2} \frac{dx}{y_2}.$$

The above equi-distributed element is $\overline{A_1} - \overline{A_2} = \frac{1}{3}(A_1 + A_2 - B_1 - B_2)$ and we have

$$\vartheta(\tau)[5/6, 5/6, 1/6, 1/6]^6 = \frac{1}{3\sqrt{3}(2\pi)^6} \det(B)^3 \exp\left(\frac{\pi i}{6}\right) (\lambda_2 - \lambda_1)(\lambda_4 - \lambda_3)(\lambda_3 - \lambda_1)^2(\lambda_4 - \lambda_2)^2.$$

REFERENCES

- [A] Accola, R., On cyclic Trigonal Riemann surfaces, *Trans. AMS.* **283-2**, (1984), pp. 423–449.
- [BR] Bershadsky, M. and Radul, A., Conformal field theories with additional Z_N symmetry, *Int. J. Mod. Phys.*, **A2-1** (1987), 165–178.
- [D] Diestel, R., *Graph theory*, Third edition. Graduate Texts in Mathematics, 173. Springer-Verlag, Berlin, 2005.

- [F] Fay, J., *Theta functions on Riemann surfaces*, Lecture Notes in Mathematics, Vol. 352, Springer-Verlag, Berlin-New York, 1973.
- [H] Hattori, R., On the Thomae formula of the refined form for triple coverings, *preprint* 2010.
- [K] Kopeliovich, Y., Non vanishing divisors for general cyclic covers and their Thomae formula, in arXiv:0909.4965.
- [N] Nakayashiki, A., On the Thomae formula for Z_N curves, *Publ. Res. Inst. Math. Sci.* **33** (1997), 987–1015.
- [Ma] Matsumoto, K., Theta constants associated with the cyclic triple coverings of the complex projective line branching at six points, *Publ. Res. Inst. Math. Sci.* **37** (2001), 419–440.
- [Mu] Mumford, D., *Tata lectures on theta I, II*, Progress in Mathematics 28, 43, Birkhäuser, Boston-Basel-Stuttgart, 1983, 1984.
- [MTY] Matsumoto, K., Terasoma, T. and Yamazaki, S., Thomae’s formula for Hesse cubic curves, to appear in *Acta Mathematica Vietnamica*, Proceedings of the Conference Complex Geometry Jan. 11-17 2009, Hanoi National University of Education.
- [S] Serre, J.P., *Trees*, Springer-Verlag, Berlin, 2003.
- [Sh] Shiga, H., On the representation of the Picard modular function by θ constants I-II, *Publ. Res. Inst. Math. Sci.* **24** (1988), 311–360.
- [T] Thomae, J., Beitrag zur Bestimmung von $\theta(0, 0, \dots, 0)$ durch die Klassenmoduln algebraischer Funktionen, *J. Reine Angew. Math.* **71** (1870), 201–222.