

Random Spin-Orbit Coupling in Spin Triplet Superconductors: Stacking Faults in Sr_2RuO_4 and CePt_3Si

Youichi YANASE*

Department of Physics, Niigata University, Niigata 950-2181, Japan

(Received Today 2010)

The random spin-orbit coupling in multicomponent superconductors is investigated focusing on the non-centrosymmetric superconductor CePt_3Si and the spin triplet superconductor Sr_2RuO_4 . We find novel manifestations of the random spin-orbit coupling in the multicomponent superconductors with directional disorders, such as stacking faults. The presence of stacking faults is indicated for the disordered phase of CePt_3Si and Sr_2RuO_4 . It is shown that the d -vector of spin triplet pairing is locked to be $\vec{d} = k_y\hat{x} - k_x\hat{y}$ with the anisotropy $\Delta T_c/T_{c0} \sim \bar{\alpha}^2/T_{c0}W_z$, where $\bar{\alpha}$, T_{c0} , and W_z are the mean square root of random spin-orbit coupling, the transition temperature in the clean limit, and the kinetic energy along the c -axis, respectively. This anisotropy is much larger (smaller) than that in the clean bulk Sr_2RuO_4 (CePt_3Si). These results indicate that the helical pairing state $\vec{d} = k_y\hat{x} - k_x\hat{y}$ in the eutectic crystal of $\text{Sr}_2\text{RuO}_4\text{-Sr}_3\text{Ru}_2\text{O}_7$ is stabilized in contrast to the chiral state $\vec{d} = (k_x \pm ik_y)\hat{z}$ in the bulk Sr_2RuO_4 . The unusual variation of T_c in CePt_3Si is resolved by taking into account the weak pair-breaking effect arising from the uniform and random spin-orbit couplings. These superconductors provide a basis for discussing recent topics on Majorana fermions and non-Abelian statistics.

KEYWORDS: spin triplet superconductor, spin-orbit coupling, stacking fault, CePt_3Si , Sr_2RuO_4

1. Introduction

Spin triplet superconductivity and superfluidity have attracted much interest since the discovery of multicomponent order parameters in superfluid $^3\text{He}^{1)}$ and heavy fermion superconductors.²⁻⁸⁾ Recent studies have shown that Sr_2RuO_4 ⁹⁾ and non-centrosymmetric CePt_3Si ^{10,11)} are other candidate spin triplet superconductors. The former is considered to be a P -wave superconductor.^{12,13)} The mixed-parity $s+P$ -wave state seems to be realized in the latter¹⁴⁻¹⁸⁾ since the crystal structure of CePt_3Si lacks the inversion symmetry.¹⁹⁻²²⁾

Spin triplet superconductor/superfluid has multicomponent order parameters described by the d -vector.^{1,3)} The structure of the d -vector is determined by the spin-orbit coupling that breaks the spin $\text{SU}(2)$ symmetry. The d -vector in the heavy fermion superconductors UPt_3 and URu_2Si_2 has been investigated on the basis of the phenomenological Ginzburg-Landau theory.^{3,6-8)} Nevertheless, many issues, for instance, the anisotropy of the d -vector, are still subjects of controversy.

Triggered by the discovery of superconductivity in Sr_2RuO_4 , the microscopic theory of the d -vector has been developed. On the basis of the multi-orbital Hubbard model with spin-orbit coupling (so-called L - S coupling), several microscopic rules for the d -vector have been obtained, which will be summarized in §2.^{23,24)} According to the microscopic theory, the symmetry-breaking interaction, which leads to the anisotropy of the d -vector, is very small in many cases. This finding has been confirmed by the nuclear magnetic resonance (NMR) measurement of Sr_2RuO_4 .^{25,26)} The small symmetry-breaking interaction due to the L - S coupling indicates that another source of spin $\text{SU}(2)$ symmetry breaking may play an important role in determining the

structure of the d -vector. The purpose of this study is to investigate the roles of the disorder that gives the random spin-orbit coupling. We show that directional disorders such as stacking faults significantly affect the d -vector in spin triplet superconductors.

The idea is based on the recent studies on non-centrosymmetric superconductors that lack inversion symmetry in their crystal structures.^{10,11,14-20)} It has been shown that antisymmetric spin-orbit coupling plays a major role in such systems.^{21,22)} Although the antisymmetric spin-orbit coupling has the same microscopic origin as the L - S coupling,¹⁸⁾ the effects on the spin triplet superconductivity are considerably different. The effect of the antisymmetric spin-orbit coupling is much larger than that of the L - S coupling, since the splitting of Fermi surfaces is induced by the former. Thus, we are led to the idea that the antisymmetric spin-orbit coupling may also play an important role in the *globally* centrosymmetric system with a broken *local* inversion symmetry. We show that this is the case for a spin triplet superconductor in the presence of directional disorders.

The presence of stacking faults in the eutectic crystal of $\text{Sr}_2\text{RuO}_4\text{-Sr}_3\text{Ru}_2\text{O}_7$ ²⁷⁻²⁹⁾ as well as in the disordered phase of CePt_3Si has been pointed out.³⁰⁾ The former is regarded to be a disordered phase of the centrosymmetric superconductor Sr_2RuO_4 , while the latter is a disordered phase of the non-centrosymmetric superconductor.^{11,31,32)} The local inversion symmetry is broken in these materials, while the global inversion symmetry is recovered by the randomness. We investigate the superconductivity in these systems by assuming the random spin-orbit coupling and random scalar potential arising from stacking faults.

We show that the d -vector in $\text{Sr}_2\text{RuO}_4\text{-Sr}_3\text{Ru}_2\text{O}_7$ is

different from the chiral state in the bulk Sr_2RuO_4 .¹²⁾ The eutectic $\text{Sr}_2\text{RuO}_4\text{-Sr}_3\text{Ru}_2\text{O}_7$ is a time-reversal invariant spin-triplet superconductor that attracts much attention in terms of Majorana fermions, non-Abelian statistics and their relationship with topological properties.^{33–38)}

In this study, we also resolve the seemingly controversial issue of the non-centrosymmetric superconductor CePt_3Si . The T_c of the disordered CePt_3Si is higher than that of the clean CePt_3Si .^{11, 30–32)} This variation of T_c is incompatible with the usual pair-breaking effect in non- s -wave superconductors. We show that this unusual variation of T_c is attributed to the pair-breaking effect arising from the antisymmetric spin-orbit coupling.

The paper is organized as follows. In §2, we summarize the results obtained using the microscopic theory for the d -vector in clean spin triplet superconductors. The effects of the *uniform* spin-orbit coupling are discussed for both centrosymmetric and non-centrosymmetric systems. In §3, we formulate the *random* spin-orbit coupling arising from stacking faults. The eutectic $\text{Sr}_2\text{RuO}_4\text{-Sr}_3\text{Ru}_2\text{O}_7$ and the disordered CePt_3Si are modeled in a unified way. The effects of the random spin-orbit coupling as well as the random scalar potential are investigated on the basis of the self-consistent Born approximation. The results for the d -vector and the pair-breaking effects are shown in §4. The breakdown of the Born approximation in the highly two-dimensional system is pointed out in §4.3, where the results expected in the two-dimensional limit are shown. The superconductivities in CePt_3Si and Sr_2RuO_4 are discussed in §5.1 and §5.2, respectively. The d -vectors in the spin triplet superconductors are summarized in §6. A discussion is given in §7.

2. D -vector in Clean Spin Triplet Superconductors

The discovery of superconductivity in Sr_2RuO_4 ⁹⁾ led to a breakthrough in the microscopic theory of spin triplet superconductivity, since the simple electronic structure of Sr_2RuO_4 made it possible to study the d -vector on the basis of microscopic models, such as the multi-orbital Hubbard model^{23, 39)} and multi-orbital d - p model.^{39, 40)}

One of the achievements of the microscopic theory is the formulation of rules for the d -vector in d -electron systems such as Sr_2RuO_4 ²³⁾ and $\text{NaCoO}_2 \cdot y\text{H}_2\text{O}$,²⁴⁾ which are summarized in Table I. Since these superconductors have inversion symmetry, the spin-orbit coupling is described by the so-called L - S coupling λ . The relation $T_c \ll \lambda \ll E_F$ holds in the d -electron systems with E_F being the Fermi energy. Since the large parameter λ/T_c is irrelevant in the presence of inversion symmetry, the perturbative treatment with respect to the small parameter λ/E_F is justified.²³⁾ On the basis of this fact, we classified the structures of the d -vector shown in Table I.

We found that the d -vector is determined in many cases solely by the symmetries of the crystal structure (first row), local electron orbital (second row), and superconductivity (third row). The direction and anisotropy of the d -vector are shown in the fourth and fifth rows, respectively. Here, the anisotropy is defined as $\Delta T_c/T_c =$

Tetragonal		Hexagonal		
d_{xy}	d_{xz}, d_{yz}	E_g		A_{1g}
P-wave		P-wave	F-wave	P- or F-wave
$\vec{d} \parallel c$	$\vec{d} \parallel ab$	$\vec{d} \parallel ab$	both	both
$O(\lambda^2/E_F^2)$	$O(\lambda/E_F)$	$O(\lambda/E_F)$	$O(\lambda^2/E_F^2)$	$O(\lambda^2/E_F^2)$

Table I. Summary of the d -vector in the clean centrosymmetric spin triplet superconductors.^{23, 24)} The direction (fourth row) and anisotropy (fifth row) of the d -vector are determined by the symmetries of the crystal structure (first row), local electron orbital (second row), and superconductivity (third row). See the text for details.

$(T_c - T_c^*)/T_c$ with T_c and T_c^* being the transition temperatures for the most and second most stable pairing states, respectively. Most of these results are exact in the sense that they are independent of the details of the Fermi surface and electron correlation. This is because the selection rules due to the symmetries solely determine the effect of spin-orbit coupling in the lowest order of $O(\lambda/E_F)$.²⁴⁾

As an exceptional case, the direction of the d -vector is not exactly determined when the lowest order term of λ/E_F vanishes. In such a case, the anisotropy is as small as $O(\lambda^2/E_F^2)$. This is the case for Sr_2RuO_4 , where the superconductivity is mainly induced by the d_{xy} -orbital electrons. We determined the d -vector for the d_{xy} -orbital electrons in the tetragonal lattice on the basis of the perturbation theory for the three-orbital Hubbard model.²³⁾ Then, we found that the d -vector indeed depends on microscopic details such as the Fermi surface and electron correlation. We assume the band structure of Sr_2RuO_4 obtained by the band calculation and show our result in the corresponding part of Table I.

We here give two additional comments on Table I. First, the symmetries of the crystal structure and superconductivity are taken into account in the phenomenological Ginzburg-Landau theory,³⁾ while the microscopic theory is needed to take advantage of the symmetry of the local electron orbital. In other words, the local orbital plays an essential role in obtaining the results summarized in Table I.

Second and more importantly, the anisotropy of the d -vector is generally small when the spin-orbit coupling is smaller than the Fermi energy $\lambda < E_F$.²³⁾ This is true even when the spin-orbit coupling is much larger than T_c . This means that the d -vector is rotated by a small applied magnetic field parallel to the d -vector, as confirmed by NMR measurements of Sr_2RuO_4 .^{25, 26)}

Another category of spin triplet superconductors is the non-centrosymmetric superconductors. The order parameter of such superconductors cannot be classified into even parity or odd parity because of the broken inversion symmetry. Then, an admixture of spin singlet and spin triplet Cooper pairs occurs, and therefore the order parameter of spin triplet pairing is always finite.²¹⁾ The theory of the d -vector for such systems is rather simple since the splitting of Fermi surfaces is induced by the antisymmetric spin-orbit coupling. It has been shown that the d -vector is parallel to the g -vector that characterizes the antisymmetric spin-orbit coupling.¹⁹⁾ Since the

symmetry of the g -vector is determined by the crystal structure, the d -vector is determined solely by the crystal symmetry. In the case of the P_{4mm} space group of CePt_3Si , the g -vector is of the Rashba-type⁴¹⁾ and then, the d -vector is $\vec{d}(\vec{k}) = k_y\hat{x} - k_x\hat{y}$.

The coupling constant of the antisymmetric spin-orbit coupling α satisfies the relation $T_c \ll \alpha \ll E_F$ in most non-centrosymmetric superconductors, including heavy fermion systems such as CePt_3Si , CeRhSi_3 , and CeIrSi_3 . This relation is similar to that for the L - S coupling λ for the centrosymmetric d -electron systems. However, the antisymmetric spin-orbit coupling gives rise to much larger anisotropy of the d -vector than the L - S coupling, because the large parameter α/T_c is relevant for the superconductivity. This means that the antisymmetric spin-orbit coupling plays a major role in the spin triplet superconductivity even when its coupling constant is much smaller than the L - S coupling. This is the reason why we focus on the *random antisymmetric spin-orbit coupling* in the disordered system and ignore the L - S coupling in this paper.

3. Random Spin-Orbit Coupling in Stacking Fault Model

3.1 Stacking fault model

We first formulate the random spin-orbit coupling and random scalar potential arising from stacking faults. Assuming the stacking fault model for disordered CePt_3Si ³⁰⁾ and eutectic Sr_2RuO_4 - $\text{Sr}_3\text{Ru}_2\text{O}_7$,^{27–29)} the crystal structures of these materials are schematically shown in Fig. 1. CePt_3Si lacks the inversion symmetry in the clean limit, but the global inversion symmetry is restored by stacking faults while keeping the broken local inversion symmetry [Fig. 1(a)]. On the other hand, clean Sr_2RuO_4 has the inversion symmetry, while stacking faults lead to local inversion symmetry breaking while keeping the global inversion symmetry [Fig. 1(b)]. Thus, CePt_3Si and Sr_2RuO_4 are contrasting examples and can be investigated in a unified way.

To focus on stacking faults in the spin triplet superconductors, we assume a three-dimensional model in which each two-dimensional layer is clean but the stacking along the c -axis is disordered as in Fig. 1. The model is described as

$$H = \sum_{\vec{k},s} \varepsilon(\vec{k}) c_{\vec{k},s}^\dagger c_{\vec{k},s} + \sum_{\gamma=1}^6 g_\gamma \lambda_\gamma^\dagger \lambda_\gamma + \sum_{\vec{r},i} u_i n_{\vec{r},i} + \sum_{\vec{k}_{2d},i} \alpha_i \vec{g}(\vec{k}_{2d}) \cdot \vec{S}_i(\vec{k}_{2d}), \quad (1)$$

where $\vec{k} = (k_x, k_y, k_z)$ and $\vec{k}_{2d} = (k_x, k_y)$ represent the three- and two-dimensional momenta, respectively. We denote the index of each layer as i and the spin as s . We denote $\vec{S}_i(\vec{k}_{2d}) = \sum_{s,s'} \vec{\sigma}_{ss'} c_{\vec{k}_{2d},i,s}^\dagger c_{\vec{k}_{2d},i,s'}$, with $\vec{\sigma}$ being the vector representation of the Pauli matrix. $n_{\vec{r},i}$ is the electron number at the site (\vec{r}, i) . The creation operators of spin triplet Cooper pairs are described as $\lambda_\gamma^\dagger = \sum_{\vec{k},s,s'} \vec{d}_\gamma(\vec{k}) (i\vec{\sigma} \sigma_y)_{ss'} c_{\vec{k},s}^\dagger c_{-\vec{k},s'}$, where $\vec{d}_{1,2}(\vec{k}) = \frac{1}{\sqrt{2}}(\phi_x(\vec{k}), \pm \phi_y(\vec{k}), 0)$, $\vec{d}_{3,4}(\vec{k}) = \frac{1}{\sqrt{2}}(\phi_y(\vec{k}), \pm \phi_x(\vec{k}), 0)$,

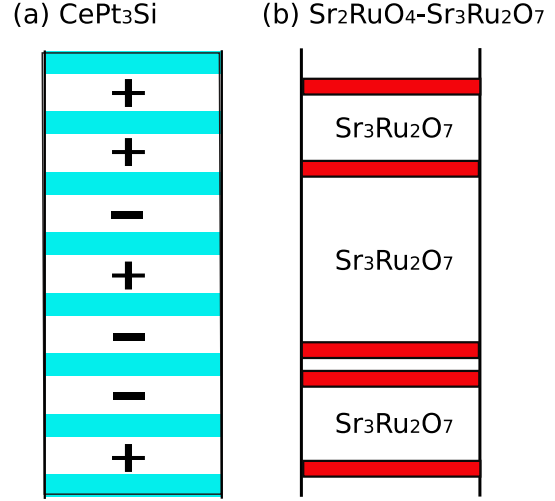

Fig. 1. (Color online) Schematic figures of the stacking faults in (a) CePt_3Si and (b) Sr_2RuO_4 - $\text{Sr}_3\text{Ru}_2\text{O}_7$. (a) Filled boxes show the layers of Ce atoms. The Si and Pt atoms fill the space between the layers. The two possible positions of Si atoms are described by + and -. The randomness is induced by the random distribution of + and - blocks. (b) Filled boxes show the RuO_2 layers in which the superconductivity occurs. Most of the spatial region is filled by the metamagnet $\text{Sr}_3\text{Ru}_2\text{O}_7$. The randomness arises from the random distribution of RuO_2 layers.

and $\vec{d}_{5,6}(\vec{k}) = \frac{1}{\sqrt{2}}(0, 0, \phi_x(\vec{k}) \pm i\phi_y(\vec{k}))$ are the irreducible representations of the order parameter in the tetragonal lattice.³⁾ We denote the d -vectors of these states $\vec{d} = k_x\hat{x} \pm k_y\hat{y}$, $\vec{d} = k_y\hat{x} \pm k_x\hat{y}$, and $\vec{d} = (k_x \pm ik_y)\hat{z}$, respectively. Although the effect of L - S coupling is included in the differences of pairing interactions g_γ for each pairing state ($\gamma = 1 - 6$), we here assume $g_\gamma = g$ for simplicity. This means that the effect of L - S coupling is ignored. This simplification is valid when the effect of L - S coupling is small as mentioned earlier.

The random scalar potential and random spin-orbit coupling at layer i are represented by u_i and α_i in the third and fourth terms in eq. (1), respectively. The random variables u_i and α_i are independent of the two-dimensional coordinate \vec{r} in the stacking fault model. The random spin-orbit coupling α_i arises from the local mirror symmetry breaking with respect to the two-dimensional plane. We assume the random averages, $\langle u_i \rangle = \langle \alpha_i \rangle = 0$, $\langle u_i u_j \rangle = \bar{u}^2 \delta_{i,j}$, $\langle \alpha_i \alpha_j \rangle = \bar{\alpha}^2 \delta_{i,j}$, and $\langle u_i \alpha_j \rangle = 0$.

3.2 Born approximation

We solve the model given by eq. (1) on the basis of the Born approximation by assuming $\bar{u}, \bar{\alpha} \ll W_z$, with W_z being the kinetic energy along the c -axis. The diagrammatic representations of the self-energy and the vertex correction to the irreducible susceptibility are shown in Figs. 2(a) and 2(b), respectively.

The Green function and self-energy are obtained as

$$G(\vec{k}, \omega_n)^{-1} = G^0(\vec{k}, \omega_n)^{-1} - \Sigma(\vec{k}_{2d}, \omega_n), \quad (2)$$

$$\Sigma(\vec{k}_{2d}, \omega_n) = (\bar{u}^2 + \bar{\alpha}^2 |\vec{g}(\vec{k}_{2d})|^2) \sum_{k_z} G(\vec{k}, \omega_n), \quad (3)$$

respectively. The undressed Green function is given as

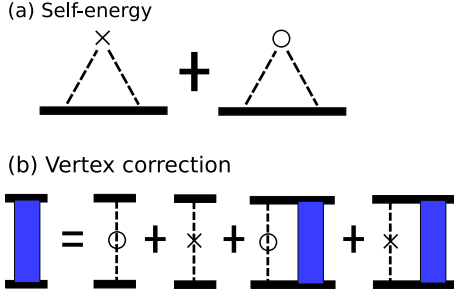

Fig. 2. (Color online) Diagrammatic representations of (a) self-energy and (b) vertex correction to the irreducible susceptibility in the Born approximation. The crosses and circles represent the scattering due to the random scalar potential and random spin-orbit coupling, respectively.

$G^0(\vec{k}, \omega_n) = (i\omega_n - \varepsilon(\vec{k}))^{-1}$, where $\omega_n = (2n + 1)\pi T$ is the Matsubara frequency and T is the temperature.

The irreducible susceptibility is divided into the contributions from the intralayer and interlayer pairings,

$$\chi_{\text{sc}} = T \sum_{\vec{k}_{2d}, \omega_n} [T^{2d}(\vec{k}_{2d}, \omega_n) + T^{3d}(\vec{k}_{2d}, \omega_n)], \quad (4)$$

where

$$\begin{aligned} T^{2d}(\vec{k}_{2d}, \omega_n) &= |\vec{d}_{2d}(\vec{k}_{2d}, \omega_n)|^2 \{ |\hat{d}_{2d}(\vec{k}_{2d}, \omega_n) \cdot \hat{g}(\vec{k}_{2d})|^2 \\ &\quad \times 1/[t(\vec{k}_{2d}, \omega_n)^{-1} - (\bar{u}^2 + \bar{\alpha}^2 |\vec{g}(\vec{k}_{2d})|^2)] \\ &\quad + (1 - |\hat{d}_{2d}(\vec{k}_{2d}, \omega_n) \cdot \hat{g}(\vec{k}_{2d})|^2) \\ &\quad \times 1/[t(\vec{k}_{2d}, \omega_n)^{-1} - (\bar{u}^2 - \bar{\alpha}^2 |\vec{g}(\vec{k}_{2d})|^2)] \}, \quad (5) \end{aligned}$$

$$T^{3d}(\vec{k}_{2d}, \omega_n) = \sum_{k_z} |\vec{d}_{3d}(\vec{k}, \omega_n)|^2 |G(\vec{k}, \omega_n)|^2, \quad (6)$$

and $t(\vec{k}_{2d}, \omega_n) = \sum_{k_z} |G(\vec{k}, \omega_n)|^2$. We denote the unit vectors as $\hat{a} = \vec{a}/|\vec{a}|$. We separate the d -vector into the wave functions of the intralayer and interlayer Cooper pairings as $\vec{d}(\vec{k}) = \vec{d}_{2d}(\vec{k}_{2d}, \omega_n) + \vec{d}_{3d}(\vec{k}, \omega_n)$ so as to satisfy the following relations;

$$\vec{d}_{2d}(\vec{k}_{2d}, \omega_n) \sum_{k_z} |G^0(\vec{k}, \omega_n)|^2 = \sum_{k_z} \vec{d}(\vec{k}) |G^0(\vec{k}, \omega_n)|^2, \quad (7)$$

$$\sum_{k_z} \vec{d}_{3d}(\vec{k}, \omega_n) |G^0(\vec{k}, \omega_n)|^2 = 0. \quad (8)$$

When the d -vector is k_z -independent, the three-dimensional component of the d -vector vanishes as $\vec{d}_{3d}(\vec{k}, \omega_n) = 0$. When the d -vector is k_z -dependent and even with respect to k_z , namely, $\vec{d}(\vec{k}_{2d}, k_z) = \vec{d}(\vec{k}_{2d}, -k_z)$, the three-dimensional component of the d -vector $\vec{d}_{3d}(\vec{k}, \omega_n)$ changes its sign at a finite k_z . When the d -vector is odd with respect to k_z , the two-dimensional component of the d -vector vanishes as $\vec{d}_{2d}(\vec{k}_{2d}, \omega_n) = 0$, and therefore $\vec{d}_{3d}(\vec{k}, \omega_n) = \vec{d}(\vec{k})$. We focus on the d -vector having even k_z dependence in the following part, and give a brief comment on the odd d -vector with respect to k_z in §4.1 and §4.2.

T_c is determined by the criterion

$$\chi_{\text{sc}}(T = T_c, \bar{u}, \bar{\alpha}) = \chi_{\text{sc}}(T = T_{c0}, \bar{u} = 0, \bar{\alpha} = 0), \quad (9)$$

where T_{c0} is the transition temperature in the clean limit ($\bar{u} = 0$ and $\bar{\alpha} = 0$).

3.3 Weak-coupling theory

In this subsection, we solve eqs. (2)-(9) on the basis of weak-coupling theory. Assuming $(\bar{u}^2 + \bar{\alpha}^2)/W_z \ll E_F$, the self-energy is obtained as

$$\Sigma(\vec{k}_{2d}, \omega_n) = -i(\Gamma^u(\vec{k}_{2d}) + \Gamma^\alpha(\vec{k}_{2d})), \quad (10)$$

$$\Gamma^u(\vec{k}_{2d}) = \pi \bar{u}^2 \rho^z(\vec{k}_{2d}), \quad (11)$$

$$\Gamma^\alpha(\vec{k}_{2d}) = \pi \bar{\alpha}^2 |\vec{g}(\vec{k}_{2d})|^2 \rho^z(\vec{k}_{2d}), \quad (12)$$

where $\rho^z(\vec{k}_{2d}) = \sum_{k_z} \delta(\varepsilon(\vec{k}))$.

Using $G(\vec{k}, \omega_n)^{-1} = i\bar{\omega}_n(\vec{k}_{2d}) - \varepsilon(\vec{k})$ with $\bar{\omega}_n(\vec{k}_{2d}) = \omega_n + \Gamma^u(\vec{k}_{2d}) + \Gamma^\alpha(\vec{k}_{2d})$, we obtain $t(\vec{k}_{2d}, \omega_n) = \pi \rho^z(\vec{k}_{2d})/\bar{\omega}_n(\vec{k}_{2d})$, and therefore,

$$\begin{aligned} T^{2d}(\vec{k}_{2d}, \omega_n) &= |\vec{d}_{2d}(\vec{k}_{2d})|^2 [|\hat{d}_{2d}(\vec{k}_{2d}) \cdot \hat{g}(\vec{k}_{2d})|^2 \pi \rho^z(\vec{k}_{2d})/\omega_n \\ &\quad + (1 - |\hat{d}_{2d}(\vec{k}_{2d}) \cdot \hat{g}(\vec{k}_{2d})|^2) \pi \rho^z(\vec{k}_{2d})/\bar{\omega}_n^1(\vec{k}_{2d})], \quad (13) \end{aligned}$$

$$T^{3d}(\vec{k}_{2d}, \omega_n) = \sum_{k_z} |\vec{d}_{3d}(\vec{k})|^2 \pi \delta(\varepsilon(\vec{k}))/\bar{\omega}_n(\vec{k}_{2d}), \quad (14)$$

where $\vec{d}_{2d,3d}(\vec{k}_{2d}) = \vec{d}_{2d,3d}(\vec{k}_{2d}, \omega_n)|_{\omega_n \rightarrow 0}$ and $\bar{\omega}_n^1(\vec{k}_{2d}) = \omega_n + 2\Gamma^\alpha(\vec{k}_{2d})$. Following eq. (4), we obtain the irreducible susceptibility for the superconductivity,

$$\begin{aligned} \chi_{\text{sc}} - \chi_{\text{sc}}(\bar{u} = 0, \bar{\alpha} = 0) &= \sum_{\vec{k}} |\vec{d}_{3d}(\vec{k})|^2 \delta(\varepsilon(\vec{k})) \\ &\quad \times [\psi(\frac{1}{2}) - \psi(\frac{1}{2} + \frac{\Gamma^u(\vec{k}_{2d}) + \Gamma^\alpha(\vec{k}_{2d})}{2\pi T})] \\ &\quad + \sum_{\vec{k}_{2d}} |\vec{d}_{2d}(\vec{k}_{2d})|^2 (1 - |\hat{d}_{2d}(\vec{k}_{2d}) \cdot \hat{g}(\vec{k}_{2d})|^2) \rho^z(\vec{k}_{2d}) \\ &\quad \times [\psi(\frac{1}{2}) - \psi(\frac{1}{2} + \frac{2\Gamma^\alpha(\vec{k}_{2d})}{2\pi T})], \quad (15) \end{aligned}$$

where $\psi(x)$ is the digamma function.

According to eq. (9), the transition temperature is determined as

$$\begin{aligned} \rho_t \log \frac{T_c}{T_{c0}} &= \sum_{\vec{k}} |\vec{d}_{3d}(\vec{k})|^2 \delta(\varepsilon(\vec{k})) [\psi(\frac{1}{2}) - \psi(\frac{1}{2} + \frac{\Gamma^u(\vec{k}_{2d}) + \Gamma^\alpha(\vec{k}_{2d})}{2\pi T_c})] \\ &\quad + \sum_{\vec{k}_{2d}} |\vec{d}_{2d}(\vec{k}_{2d})|^2 (1 - |\hat{d}_{2d}(\vec{k}_{2d}) \cdot \hat{g}(\vec{k}_{2d})|^2) \rho^z(\vec{k}_{2d}) \\ &\quad \times [\psi(\frac{1}{2}) - \psi(\frac{1}{2} + \frac{2\Gamma^\alpha(\vec{k}_{2d})}{2\pi T_c})], \quad (16) \end{aligned}$$

where $\rho_t = \sum_{\vec{k}} |\vec{d}(\vec{k})|^2 \delta(\varepsilon(\vec{k}))$.

Using a similar analysis, we obtain the equation of T_c for the spin singlet pairing state as

$$\begin{aligned} \rho_s \log \frac{T_c}{T_{c0}} &= \sum_{\vec{k}} |\phi_{3d}^s(\vec{k})|^2 \delta(\varepsilon(\vec{k})) [\psi(\frac{1}{2}) - \psi(\frac{1}{2} + \frac{\Gamma^u(\vec{k}_{2d}) + \Gamma^\alpha(\vec{k}_{2d})}{2\pi T_c})], \end{aligned}$$

(17)

where $\rho_s = \sum_{\vec{k}} |\phi^s(\vec{k})|^2 \delta(\varepsilon(\vec{k}))$. The scalar order parameter of the spin singlet superconductivity is denoted as $\phi^s(\vec{k}) = \phi^s(-\vec{k})$ and its interlayer component $\phi_{3d}^s(\vec{k})$ is defined in the same way as in eqs. (7) and (8).

4. D-vector and Pair-Breaking Effect

In this section, we investigate the effects of random spin-orbit coupling and random scalar potential on the spin triplet superconductors. The effects on the d -vector are clarified in §4.1 and the pair-breaking effect is investigated in §4.2.

4.1 D-vector

First, we discuss the d -vector in the presence of random spin-orbit coupling. The pair-breaking effect arising from the random spin-orbit coupling leads to the anisotropy of the d -vector through the second term on the right-hand side of eq. (16). We see that the anisotropy originates from the intralayer Cooper pairing represented by $\vec{d}_{2d}(\vec{k}_{2d})$. The interlayer Cooper pairs are suppressed by disorders independent of the spin degree of freedom. Since the scalar disorder does not give rise to the anisotropy of the d -vector, we focus on the random spin-orbit coupling in this subsection.

Because the second term in eq. (16) vanishes for the d -vector parallel to the g -vector, the spin triplet superconducting state with $\vec{d}(\vec{k}) \parallel \vec{g}(\vec{k}_{2d})$ is robust against the random spin-orbit coupling. The other spin triplet pairing states are destabilized by the random spin-orbit coupling. The d -vector $\vec{d} = k_y \hat{x} - k_x \hat{y}$ is favored when the random spin-orbit coupling is of the Rashba type. This is the same pairing state as that in clean non-centrosymmetric superconductors having the spatially uniform Rashba spin-orbit coupling.¹⁹⁾ On the other hand, the anisotropy of the d -vector is significantly different between the clean and disordered systems. The pair-breaking effect on the spin triplet pairing state with $\vec{d}(\vec{k}) \not\parallel \vec{g}(\vec{k}_{2d})$ is represented by the parameter Γ^α/T_{c0} . The phase relaxation rate Γ^α is obtained as $\Gamma^\alpha \sim \alpha$ in the clean non-centrosymmetric superconductors,¹⁹⁾ while $\Gamma^\alpha \sim \pi \bar{\alpha}^2/W_z$ in the stacking fault model. The anisotropy arising from the antisymmetric spin-orbit coupling is significantly decreased by stacking faults when the relation $\bar{\alpha} \ll W_z$ is satisfied, as in most non-centrosymmetric superconductors. This is one of the manifestations of the global inversion symmetry recovered by the disorders.

Figure 3 shows the T_c values of various spin triplet pairing states for the simple dispersion relation

$$\varepsilon(\vec{k}) = 2t(\cos k_x + \cos k_y) + 2t_z \cos k_z - \mu, \quad (18)$$

and the g -vector $\vec{g}(\vec{k}) = (-\sin k_y, \sin k_x, 0)/\langle |\vec{g}(\vec{k})| \rangle_F$, where the bracket $\langle \rangle_F$ means the average on the Fermi surface. We numerically solve eqs. (2)-(9) without using the weak-coupling approximation in §3.3, although we have confirmed that the weak-coupling approximation leading to eq. (16) is quantitatively valid. We choose the unit of energy as $t = 1$ and assume $t_z = 0.2$. The chemical potential μ is determined so that the electron density per site is $n = 0.5$. The wave functions of Cooper pairs

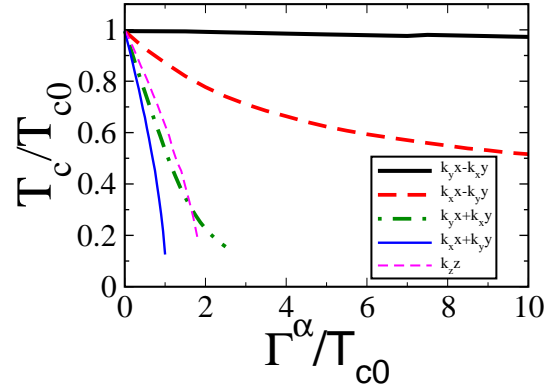

Fig. 3. (Color online) T_c values of various spin triplet pairing states in the presence of random spin-orbit coupling. We plot the normalized quantity T_c/T_{c0} for the dimensionless parameter $\Gamma^\alpha/T_{c0} = \bar{\alpha}^2/T_{c0}t_z$. We assume $T_{c0} = 0.0256$. The thick solid, thick dashed, dash-dotted, and thin solid lines show the T_c values of the pairing states $\vec{d} = k_y \hat{x} - k_x \hat{y}$, $\vec{d} = k_x \hat{x} - k_y \hat{y}$, $\vec{d} = k_y \hat{x} + k_x \hat{y}$, and $\vec{d} = k_x \hat{x} + k_y \hat{y}$, respectively. The T_c of the chiral state $\vec{d} = (k_x \pm ik_y)\hat{z}$ is the same as that of $\vec{d} = k_x \hat{x} + k_y \hat{y}$. The scalar disorder with $\Gamma^u/T_{c0} = \bar{u}^2/T_{c0}t_z = 5$ is taken into account, but its effect on T_c is negligible. We also show the T_c of the pairing state $\vec{d} = k_z \hat{z}$ for $\Gamma^u/T_{c0} = 0$ (thin dashed line).

are assumed to be $(\phi_x(\vec{k}), \phi_y(\vec{k})) = (\sin k_x, \sin k_y)$. For this model, $\vec{d}_{3d}(\vec{k}) = 0$, and therefore, the first term of eq. (16) vanishes.

We see that the spin triplet pairing state $\vec{d} = k_y \hat{x} - k_x \hat{y}$ is stable in accordance with the analytic solution of eq. (16), while the other pairing states are destabilized. The anisotropy of the d -vector defined as $\Delta T_c/T_c$, is on the order of $O(1)$ for the realistic spin-orbit coupling $\bar{\alpha}^2/T_{c0}t_z \sim 10$. This means that the d -vector is strongly pinned by the random spin-orbit coupling. Note that this anisotropy is much larger than that in the clean centrosymmetric superconductors. For example, we obtained a small anisotropy $\Delta T_c/T_c < 0.01$ for the clean bulk Sr_2RuO_4 ,^{23,42)} which has been confirmed experimentally.^{25,26,43)}

Here, we comment on the d -vector that is odd with respect to k_z , namely, $\vec{d}(\vec{k}_{2d}, k_z) = -\vec{d}(\vec{k}_{2d}, -k_z)$. In this case, the intralayer Cooper pairing vanishes as $\vec{d}_{2d}(\vec{k}_{2d}) = 0$, and therefore, $\vec{d}_{3d}(\vec{k}) = \vec{d}(\vec{k})$. Then, stacking faults give rise to a strong pair-breaking effect through the first term of eq. (16), independent of the spin degree of freedom. (See the thin dashed line in Fig. 3.) This means that the pairing states $\vec{d} = k_z \hat{x}$ and $\vec{d} = k_z \hat{z}$ proposed by Hasegawa and Taniguchi⁴⁴⁾ are unlikely to be realized in CePt₃Si if stacking faults exist there. We assume that the d -vector is even with respect to k_z in the following part, unless we mention otherwise.

4.2 Pair-breaking effect for $\vec{d} = k_y \hat{x} - k_x \hat{y}$

Next, we investigate the pair-breaking effect on the most stable pairing state $\vec{d} = k_y \hat{x} - k_x \hat{y}$. When we assume a momentum dependence of the d -vector so that $\vec{d}(\vec{k}) \propto \vec{g}(\vec{k})$ and $\vec{d}_{3d}(\vec{k}) = 0$, as in §4.1, the T_c of the spin triplet pairing state $\vec{d} = k_y \hat{x} - k_x \hat{y}$ is not decreased by stacking faults. On the other hand, a weak pair-breaking effect is

induced for $\vec{d} = k_y\hat{x} - k_x\hat{y}$ through the first and second terms in eq. (16) when the momentum dependences of the d - and g -vectors are more complicated. We discuss the following contributions; (I) the first term of eq. (16), which arises from the interlayer Cooper pairing, and (II) the second term, which originates from the mismatch of the d - and g -vectors.

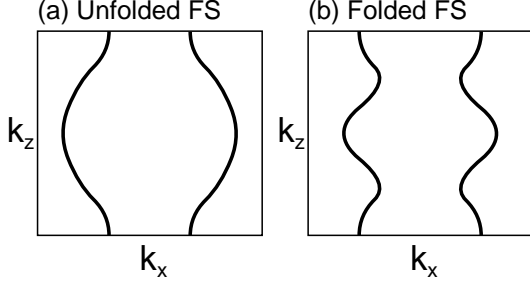

Fig. 4. Examples of (a) unfolded and (b) folded Fermi surfaces along the k_z -axis. The cross-sections on the k_x - k_z plane are shown.

(I) According to eq. (16), both random scalar potential and random spin-orbit coupling lead to the pair-breaking of interlayer Cooper pairs represented by $\vec{d}_{3d}(\vec{k})$. However, this pair-breaking effect vanishes for the simple band structure when the Fermi surface is not folded along the k_z -axis. Examples of the unfolded and folded Fermi surfaces are shown in Figs. 4(a) and 4(b), respectively. We explain this nontrivial result on the basis of the weak-coupling theory. Since T_c is determined by the Cooper pairs on the Fermi surface in the weak-coupling limit, we replace eq. (8) with,

$$\sum_{j=1,\pm}^l \vec{d}_{3d}(\vec{k}_{2d}, \pm k_z^j) / |v_z(\vec{k}_{2d}, \pm k_z^j)| = 0, \quad (19)$$

where the momentum on the Fermi surface are described by $(\vec{k}_{2d}, \pm k_z^j)$. For unfolded Fermi surfaces $l = 1$ for all \vec{k}_{2d} . This is the case for eq. (18). According to eq. (19), the three-dimensional component $\vec{d}_{3d}(\vec{k})$ vanishes on the Fermi surface when the order parameter is even with respect to k_z and $\vec{d}(\vec{k}_{2d}, k_z) = \vec{d}(\vec{k}_{2d}, -k_z)$. Then, the pair-breaking effect through the first term in eq. (16) vanishes. In other words, the spin triplet pairing state $\vec{d} = k_y\hat{x} - k_x\hat{y}$ is robust against stacking faults even for the three-dimensional order parameter and/or three-dimensional band structure when the Fermi surface is unfolded. This is viewed as an extension of Anderson's theorem⁴⁵⁾ for the non- s -wave superconductors.

For a folded Fermi surface with $l \geq 2$ [Fig. 4(b)], pair-breaking occurs for $\vec{d} = k_y\hat{x} - k_x\hat{y}$ through the interlayer pairing $\vec{d}_{3d}(\vec{k})$. This effect is quantitatively important when the d -vector $\vec{d}(\vec{k})$ changes its sign along the k_z -axis. In such a case, the horizontal line node (or a tiny gap) appears in the superconducting gap $\Delta(\vec{k}) \propto \sqrt{\phi_x(\vec{k})^2 + \phi_y(\vec{k})^2}$ if the nodes of $\phi_x(\vec{k})$ and $\phi_y(\vec{k})$ are close to each other.

Parity for k_z	Even		Odd
Gap structure	Full gap or Vertical	Horizontal	Horizontal
Unfolded FS	×	×	○
Folded FS	×	○	○

Table II. Summary of the pair-breaking effect on the most stable spin triplet pairing state $\vec{d} = k_y\hat{x} - k_x\hat{y}$ through the interlayer Cooper pairing. The second row indicates the gap structure. “Vertical” and “Horizontal” denote the vertical and horizontal line nodes in the superconducting gap, respectively. The third and fourth rows describe the folded and unfolded Fermi surfaces, respectively. The symbols ○ and × show the presence and absence of the pair-breaking effect, respectively. The fourth column shows the pair-breaking effect for the pairing state having odd parity with respect to k_z .

The presence or absence of the pair-breaking effect due to the interlayer Cooper pairing is summarized in Table II. The case of the odd d -vector with respect to k_z is also shown in Table II. We see that pair-breaking occurs only for the folded Fermi surface with horizontal line nodes of the superconducting gap when the order parameter is even with respect to k_z .

(II) The pair-breaking effect arises from the intralayer Cooper pairs when the momentum dependences of the d -vector and g -vector are mismatched. Although short-range Cooper pairing leads to the simple momentum dependence of the d -vector, the g -vector may have a complicated momentum dependence.¹⁸⁾ Then, the d -vector cannot be parallel to the g -vector in the whole Brillouin zone.^{16, 18, 46, 47)} In such a case, T_c is decreased even for the most stable pairing state $\vec{d} = k_y\hat{x} - k_x\hat{y}$ through the second term of eq. (16). This is similar to the case of clean non-centrosymmetric superconductors,^{16, 18)} but the amplitude of the pair-breaking effect is reduced. The pair-breaking effect due to the random spin-orbit coupling is quadratic in $\bar{\alpha}$, while it is linear in α in a clean non-centrosymmetric system. In §5.1, we show that this quantitative difference resolves the unusual variation of T_c in CePt₃Si.

4.3 Highly two-dimensional system

We here comment on the breakdown of the Born approximation in highly two-dimensional systems. The parameter space for the c -axis kinetic energy W_z is divided into the following three regimes: (A) Three-dimensional regime $\bar{\alpha}^2/E_F < W_z$ where the Born approximation is valid. Because the phase relaxation rate is inversely proportional to W_z , the pair-breaking effect increases with decreasing W_z by enhancing the two-dimensionality. (B) Two-dimensional regime $T_{c0} < W_z < \bar{\alpha}^2/E_F$ where the Born approximation breaks down. The effects of the randomness tend to be saturated with decreasing W_z . A higher-order theory, such as the self-consistent T-matrix approximation, is needed for a quantitative estimation. (C) Highly two-dimensional regime $W_z < T_{c0}$ where the spatial inhomogeneity plays an important role like in short coherence length superconductors⁴⁸⁻⁵⁰⁾ In this regime the spatial average (replica symmetry) taken in the Born approximation as well as in the self-consistent T-matrix approximation is not justified. In the limit of

two-dimensionality $W_z/T_{c0} \rightarrow 0$, the layers are independent of each other. Then, the pair-breaking effect on T_c vanishes, because T_c is determined by the layer with $\alpha_i = 0$. Summarizing this discussion, we show the schematic figure in Fig. 5, where the pair-breaking effect is shown for regimes (A), (B), and (C).

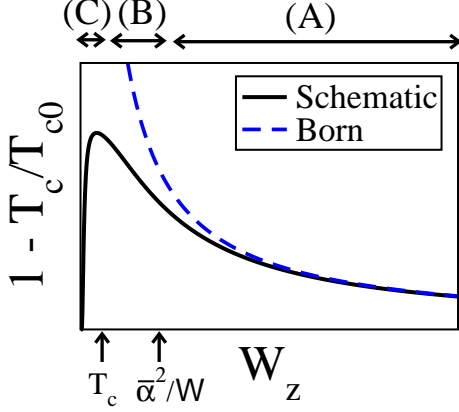

Fig. 5. (Color online) Schematic figure of the pair-breaking effect due to stacking faults (solid line). We show the three-dimensional regime (A), two-dimensional regime (B), and highly two-dimensional regime (C). The dashed line shows the result of the Born approximation, which is valid in regime (C). The details are explained in the text.

5. CePt₃Si and Sr₂RuO₄

We here turn to examples of possible spin triplet superconductors. CePt₃Si and Sr₂RuO₄ are discussed in §5.1 and §5.2, respectively.

5.1 CePt₃Si

First, we show that an unresolved issue in CePt₃Si is resolved by taking into account the randomness in the spin-orbit coupling. After the discovery of superconductivity with $T_c \sim 0.7$ K by Bauer *et al.*,¹⁰ another superconducting phase with $T_c \sim 0.45$ K was found.^{31,32} Several experimental results show that the high- T_c phase is more disordered than the low- T_c phase.^{31,32} This variation of T_c is unusual since the heavy fermion superconductor CePt₃Si is considered to be a non-*s*-wave superconductor. We here resolve this problem by assuming the presence of stacking faults in the high- T_c phase, as proposed in ref. 30.

One of the important consequences of §4 is the extended Anderson's theorem for stacking faults. The non-*s*-wave superconductivity is robust against stacking faults in many cases, as summarized in Table II. In particular, the pair-breaking effects due to the random scalar potential and the random spin-orbit coupling can be substantially avoided for the spin triplet pairing state with $\vec{d} = k_y \hat{x} - k_x \hat{y}$.

Another point is the weak but finite pair-breaking effect for $\vec{d} = k_y \hat{x} - k_x \hat{y}$ arising from both the uniform and random spin-orbit couplings. Since our formulation does not include the uniform spin-orbit coupling, we cannot interpolate between the clean and random systems.

However, we can compare T_c in the clean limit with that in the highly disordered system since T_c in the clean non-centrosymmetric superconductor is obtained by replacing $\Gamma^\alpha(\vec{k}_{2d}) = \pi \bar{\alpha}^2 |\vec{g}(\vec{k}_{2d})|^2 \rho^z(\vec{k}_{2d})$ in eq. (16) with $\Gamma^\alpha(\vec{k}_{2d}) = \alpha |\vec{g}(\vec{k}_{2d})|$.¹⁹ Because the relations $\bar{\alpha}/W_z \ll 1$ and $\bar{\alpha} \leq \alpha$ are satisfied in CePt₃Si, the pair-breaking effect is larger in the clean CePt₃Si than in the disordered CePt₃Si. In other words, T_c is increased by stacking faults by recovering the global inversion symmetry. This is consistent with the seemingly unusual variation of T_c in CePt₃Si.^{31,32}

In order to examine this proposal quantitatively, we take into account the band structure of CePt₃Si and numerically solve eqs. (2)-(9) for the following dispersion relation:

$$\begin{aligned} \varepsilon(\vec{k}) = & 2t_1(\cos k_x + \cos k_y) + 4t_2 \cos k_x \cos k_y \\ & + 2t_3(\cos 2k_x + \cos 2k_y) + [2t_4 + 4t_5(\cos k_x + \cos k_y) \\ & + 4t_6(\cos 2k_x + \cos 2k_y)] \cos k_z + 2t_7 \cos 2k_z - \mu. \end{aligned} \quad (20)$$

By choosing the parameters as $(t_1, t_2, t_3, t_4, t_5, t_6, t_7, n) = (1, -0.15, -0.5, -0.3, -0.1, -0.09, -0.2, 1.75)$, eq. (20) reproduces the β -band of CePt₃Si.¹⁶ Although CePt₃Si has several Fermi surfaces,⁵¹⁻⁵³ it is expected that the superconductivity is mainly induced by the β -band since the β -band has a substantial Ce 4*f*-electron character⁵² and the largest density of states.⁵¹ The Fermi surface obtained from eq. (20) (see Fig. 1 of ref. 16) is folded along the k_z -axis for a part of \vec{k}_{2d} . Therefore, not only the random spin-orbit coupling but also the random scalar potential can decrease T_c .

We assume the *g*-vector

$$\begin{aligned} \vec{g}(\vec{k}) = & (-\sin k_y(1 - G \sin k_x^2), \sin k_x(1 - G \sin k_y^2), 0) \\ & / < |\vec{g}(\vec{k})| >_F, \end{aligned} \quad (21)$$

while the *d*-vector is assumed to be $\vec{d}(\vec{k}) = \frac{1}{\sqrt{2}}(\phi_y(\vec{k}), -\phi_x(\vec{k}), 0)$ with

$$(\phi_x(\vec{k}), \phi_y(\vec{k})) = (1 + D \cos k_z) \times (\sin k_x, \sin k_y). \quad (22)$$

The parameter *G* represents the complexity of the *g*-vector, while the parameter *D* represents the weight of interlayer Cooper pairing.

We show the variation of T_c with respect to *D* and *G* in Fig. 6, where the randomness is fixed to be $\bar{u}^2/T_{c0}|t_4| = \bar{\alpha}^2/T_{c0}|t_4| = 5$. It is shown that T_c is significantly decreased with increasing *G* at approximately $G = 1$. This is because nontrivial topological defects appear in the *g*-vector for $G > 1$. Thus, the T_c of spin triplet superconductivity with $\vec{d} = k_y \hat{x} - k_x \hat{y}$ is substantially decreased by the random spin-orbit coupling when the topological properties are different between the *d*-vector and *g*-vector. Another effect of the topological defects in the *g*-vector, such as the topologically protected line node of the superconducting gap, has been pointed out.^{16,18} For the dependence on *D*, we see a substantial decrease in T_c for $D \geq 1$. This is because the superconducting gap has horizontal line nodes for $D \geq 1$, and then the superconductivity is suppressed by stacking faults in accordance with Table II.

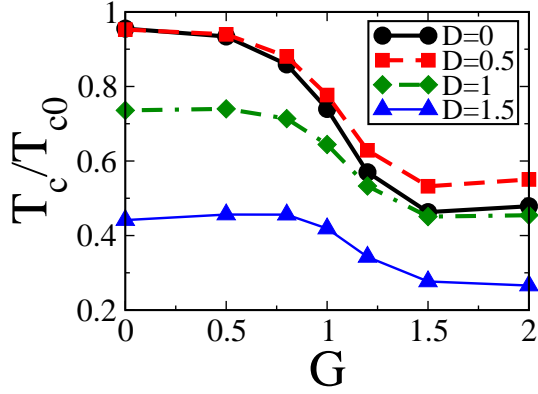

Fig. 6. (Color online) T_c values of the spin triplet pairing state $\vec{d} = k_y\hat{x} - k_x\hat{y}$ for various values of G and D . The circles, squares, diamonds, and triangles show the G dependences for $D = 0, 0.5, 1,$ and 1.5 , respectively. The dispersion relation in eq. (20) is assumed. We fix the randomness $\Gamma^u/T_{c0} = \Gamma^\alpha/T_{c0} = 5$ with $\Gamma^u = \bar{u}^2/|t_4|$ and $\Gamma^\alpha = \bar{\alpha}^2/|t_4|$. T_c in the clean limit without spin-orbit coupling is assumed to be $T_{c0} = 0.0064$.

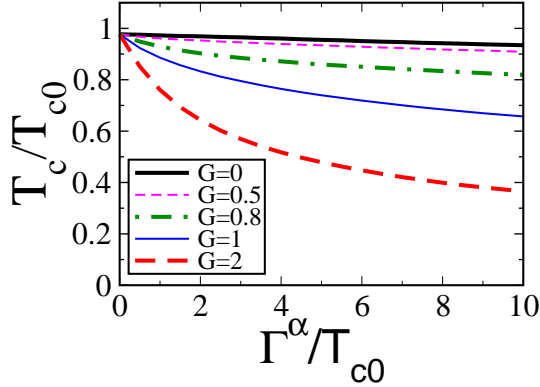

Fig. 7. (Color online) The T_c of the spin triplet pairing state $\vec{d} = k_y\hat{x} - k_x\hat{y}$ for various values of G and Γ^α . The thick solid, thin solid, dash-dotted, thin solid, and thick dashed lines show the Γ^α -dependence of T_c for $G = 0, 0.5, 0.8, 1,$ and 2 , respectively. We here assume $D = 0$. The other parameters are the same as in Fig. 6.

For a quantitative comparison with experiments, we discuss the realistic parameters for CePt₃Si. According to the microscopic analysis based on the random phase approximation, the interlayer Cooper pairing is negligible in the $s+P$ -wave state of CePt₃Si.^{16,18)} This is the dominantly spin triplet pairing state consistent with the experimental results.¹⁴⁾ Thus, the small parameter $D \ll 1$ is indicated in CePt₃Si. On the other hand, it is difficult to determine the parameter G since the momentum dependence of the g -vector has not been extracted from the data of band calculation.^{51–53)} Therefore, we assume $D = 0$ and show the $\bar{\alpha}$ dependence of T_c for various G in Fig. 7.

We here assume $\alpha/T_{c0} = 100$ and $\alpha/|t_4| = 0.2$, where α is the spin-orbit coupling in the clean limit and the T_{c0} is the fictitious transition temperature for $\alpha = 0$. For the disordered phase of CePt₃Si, we assume $\bar{\alpha} = \alpha/2$, and then we obtain $\Gamma^\alpha/T_{c0} = 5$. T_c in the clean limit of CePt₃Si is roughly estimated by replacing Γ^α/T_{c0} in

Fig. 7 with α/T_{c0} . When we assume a moderately complicated g -vector with $G = 1$, we obtain $T_c/T_{c0} = 0.74$ for the disordered phase and $T_c/T_{c0} = 0.32$ in the clean limit. This rough estimation is in reasonable agreement with the high T_c of the disordered CePt₃Si ($T_c = 0.7$ K) and the low T_c of the clean CePt₃Si ($T_c = 0.45$ K). Thus, the seemingly unusual variation of T_c in CePt₃Si is understood by taking into account the spin-orbit coupling and assuming the d -vector $\vec{d} = k_y\hat{x} - k_x\hat{y}$. We stress again that T_c is increased in the disordered phase by recovering the global inversion symmetry.

5.2 Sr₂RuO₄

Next, we discuss the superconductivity in bulk Sr₂RuO₄ and the eutectic crystal Sr₂RuO₄-Sr₃Ru₂O₇. The superconductivity in bulk Sr₂RuO₄ with $T_c = 1.5$ K was discovered in 1994.⁹⁾ Recently, a new superconducting material has been fabricated in the eutectic crystal Sr₂RuO₄-Sr₃Ru₂O₇.^{27–29)} It has been indicated that the superconductivity occurs in the thin Sr₂RuO₄ layers included in the Sr₃Ru₂O₇ region.^{28,29)} The disorder in the two-dimensional layer is expected to be negligible because the T_c of Sr₂RuO₄-Sr₃Ru₂O₇ is similar to that of bulk Sr₂RuO₄. Therefore, Sr₂RuO₄-Sr₃Ru₂O₇ can be regarded as a layered ruthenate with many stacking faults, as shown in Fig. 1(b).

For the bulk Sr₂RuO₄, the d -vector has been theoretically investigated on the basis of the multi-orbital Hubbard model^{23,39)} and multi-orbital d - p model.^{39,40)} Using these microscopic theories it is found that the anisotropy of the d -vector is very small, $\Delta T_c/T_c < 0.01$. This is because the effect of the spin-orbit coupling (L - S coupling) λ on the superconductivity in the active γ -band is on the order of λ^2/E_F^2 .²³⁾ Such a small anisotropy is consistent with the NMR measurements^{25,26)} and results in multiple phase transitions in the magnetic field.^{42,54)}

According to the results in §4, the structure of the d -vector in Sr₂RuO₄-Sr₃Ru₂O₇ is considerably different from that in the bulk Sr₂RuO₄. Several pieces of experimental evidence have been obtained for the chiral spin triplet pairing state $\vec{d} = (k_x \pm ik_y)\hat{z}$ in the bulk Sr₂RuO₄.¹²⁾ On the other hand, the stable pairing state is expected to be $\vec{d} = k_y\hat{x} - k_x\hat{y}$ in Sr₂RuO₄-Sr₃Ru₂O₇ owing to the random spin-orbit coupling arising from stacking faults.

A weak anisotropy due to the L - S coupling $\Delta T_c/T_c < 0.01$ is compensated for by the very small random antisymmetric spin-orbit coupling $\bar{\alpha}$ with $\bar{\alpha}^2/W_z T_{c0} < 0.02$ according to Fig. 3. When we assume $W_z = 100$ K and $T_{c0} = 1.5$ K, the pairing state $\vec{d} = k_y\hat{x} - k_x\hat{y}$ is more stable than the chiral state for $\bar{\alpha} > 2$ K. Since $\bar{\alpha} = 2$ K is much smaller than the typical antisymmetric spin-orbit coupling (> 100 K), the d -vector $\vec{d} = k_y\hat{x} - k_x\hat{y}$ is likely to be realized in Sr₂RuO₄-Sr₃Ru₂O₇. The anisotropy of the d -vector is expected to be large on the order of $\Delta T_c/T_c = O(1)$, since the relation $\bar{\alpha}^2/W_z T_{c0} > 1$ is expected. This means that the spin triplet pairing state $\vec{d} = k_y\hat{x} - k_x\hat{y}$ with conserved time-reversal symmetry is very robust in the eutectic crystal Sr₂RuO₄-Sr₃Ru₂O₇.

The Born approximation may break down in Sr₂RuO₄-Sr₃Ru₂O₇, as discussed in §4.3, because the Sr₂RuO₄

Non-centrosymmetric	Directional disorder
$\vec{d} \parallel \vec{g}$	
$\min[O(1), O(\alpha/T_{c0})]$	$\min[O(1), O(\bar{\alpha}^2/W_z T_{c0})]$

Table III. Summary of d -vector in the non-centrosymmetric superconductors (first column) and disordered superconductors (second column). The d -vector (second row) is determined solely by the crystal structure that gives rise to the uniform and random antisymmetric spin-orbit coupling. The third row shows the anisotropy of the d -vector. See the text for details.

layers are dilute in the superconducting region of interest. However, these results for the d -vector are qualitatively valid beyond the Born approximation.

We here give a brief comment on the 3 K superconducting phase of Sr_2RuO_4 , which is realized near the interface with the Ru metal.⁵⁵⁾ The antisymmetric spin-orbit coupling should play an important role in such inhomogeneous spin triplet superconductors because the local inversion symmetry is broken. In particular, the spatial dependence of the d -vector is determined by the shape of the Ru metal. Then, novel topological defects should appear for some structures of interfaces. We leave such an interesting texture of a spin triplet order parameter as a future issue.

6. Summary of D -vector in Spin Triplet Superconductors

Combining this study on disordered superconductors with the previous studies on clean bulk superconductors, we summarize the structures of the d -vector in spin triplet superconductors.

The d -vector in the clean centrosymmetric superconductors is determined by the symmetries of the crystal structure, local electron orbital, and superconductivity in accordance with the selection rules summarized in Table I.^{23,24)} We stress again that these results are exact in the lowest order of λ/E_F . We also mentioned the cases where the higher-order terms with respect to λ/E_F determine the d -vector. It is expected that similar selection rules will also be obtained for the f -electron systems in which the other limit $\lambda/E_F \gg 1$ is appropriate, although the microscopic study of heavy fermions remains a future work.

The d -vector in the clean non-centrosymmetric superconductors and disordered superconductors are summarized in Table III. In these cases, the d -vector is determined solely by the crystal structure through the g -vector of antisymmetric spin-orbit coupling. The anisotropy of the d -vector $\Delta T_c/T_c$ is estimated to be $\min[O(1), O(\alpha/T_{c0})]$ and $\min[O(1), O(\bar{\alpha}^2/E_F T_{c0})]$ for the non-centrosymmetric superconductors and disordered superconductors, respectively. Although the role of the antisymmetric spin-orbit coupling is reduced by the randomness, it is still much larger than the effect of the symmetric L - S coupling. This means that we have to be careful in discussing the d -vector of centrosymmetric spin triplet superconductors because it is affected by a small amount of directional disorders. Tables I and III show a complete set of theoretical results on the structures of the d -vector.

7. Summary and Discussion

We investigated the roles of random spin-orbit coupling in spin triplet superconductors. The random antisymmetric spin-orbit coupling induced by stacking faults in CePt_3Si and Sr_2RuO_4 - $\text{Sr}_3\text{Ru}_2\text{O}_7$ has been studied as a typical example. It is shown that the d -vector parallel to the g -vector is stabilized by the spin-orbit coupling similarly to that in the non-centrosymmetric superconductors. In the cases of CePt_3Si and Sr_2RuO_4 - $\text{Sr}_3\text{Ru}_2\text{O}_7$, the pairing state $\vec{d} = k_y \hat{x} - k_x \hat{y}$ is stabilized. The anisotropy of the d -vector is represented by the parameter $\bar{\alpha}^2/W_z T_{c0}$, which is much smaller than that in the clean non-centrosymmetric superconductors by the factor $\bar{\alpha}/W_z$, but much larger than that in the clean centrosymmetric superconductors.

The superconducting state of CePt_3Si and Sr_2RuO_4 - $\text{Sr}_3\text{Ru}_2\text{O}_7$ was discussed on the basis of the stacking fault model. A seemingly controversial issue of CePt_3Si , namely, the high T_c of the disordered phase, has been resolved. This unusual variation of T_c is attributed to the restoration of the global inversion symmetry by disorders while keeping the broken local inversion symmetry.

Stacking faults have more interesting effects on Sr_2RuO_4 - $\text{Sr}_3\text{Ru}_2\text{O}_7$. While the chiral state $\vec{d} = (k_x \pm ik_y)\hat{z}$ with broken time-reversal symmetry is considered to be realized in the bulk Sr_2RuO_4 , the pairing state $\vec{d} = k_y \hat{x} - k_x \hat{y}$ with time-reversal symmetry is likely to be stabilized in Sr_2RuO_4 - $\text{Sr}_3\text{Ru}_2\text{O}_7$. Therefore, several properties of the superconducting state are considerably different between the eutectic crystal Sr_2RuO_4 - $\text{Sr}_3\text{Ru}_2\text{O}_7$ and the bulk Sr_2RuO_4 . The comparison of these related materials provides an opportunity to study the multicomponent order parameters of Sr_2RuO_4 . For example, the multiple phase transitions observed in the bulk Sr_2RuO_4 ^{54,56)} should disappear in Sr_2RuO_4 - $\text{Sr}_3\text{Ru}_2\text{O}_7$.

Since the g -vector of antisymmetric spin-orbit coupling is a real vector, the time-reversal symmetry is generally conserved in the spin triplet superconductors with directional disorders. This is a means to realize topological superconductors having the time-reversal symmetry, whose nontrivial properties such as Majorana fermions and non-Abelian statistics are attracting growing attention.³⁵⁻³⁸⁾

The directional disorders generally play an important role in the spin triplet superconductors, as discussed in this paper. In particular, the random spin-orbit coupling due to the local inversion symmetry breaking can alter the pairing state in the centrosymmetric systems. This is the first study pointing out that not only the broken *global* inversion symmetry but also the broken *local* inversion symmetry plays essential roles. Although we focused on a particular example, that is, stacking faults, it is straightforward to extend this study to other cases such as the bilayer structure and pyrochlore structure. Our study indicates that it is not difficult to study the d -vector from the theoretical point of view, because it is determined solely by the crystal structure in many cases.

Acknowledgements

The authors are grateful to S. Fujimoto, Y. Kitaoka, S. Kittaka, G. Motoyama, Y. Maeno, H. Mukuda, T. Nomura, Y. Onuki, M. Sigrist, R. Shindou, H. Yaguchi, and M. Yogi for fruitful discussions. This work was supported by a Grant-in-Aid for Scientific Research on Priority Area “Superclean Materials” (No. 20029008) and a Grant-in-Aid for Scientific Research on Innovative Areas “Heavy Electrons” (No. 21102506) from MEXT, Japan. It was also supported by a Grant-in-Aid for Young Scientists (B) (No. 20740187) from JSPS. Numerical computation in this work was carried out at the Yukawa Institute Computer Facility.

- 1) A. J. Leggett: *Rev. Mod. Phys.* **47** (1975) 331.
- 2) R. A. Fisher, S. Kim, B. F. Woodfield, N. E. Phillips, L. Taillefer, K. Hasselbach, J. Flouquet, A. L. Giorgi, and J. L. Smith: *Phys. Rev. Lett.* **62** (1989) 1411.
- 3) M. Sigrist and K. Ueda: *Rev. Mod. Phys.* **63** (1991) 239.
- 4) H. Tou, Y. Kitaoka, K. Ishida, K. Asayama, N. Kimura, Y. Onuki, E. Yamamoto, Y. Haga, and K. Maezawa: *Phys. Rev. Lett.* **80** (1998) 3129.
- 5) H. Tou, Y. Kitaoka, K. Asayama, N. Kimura, Y. Onuki, E. Yamamoto, and K. Maezawa: *Phys. Rev. Lett.* **77** (1996) 1374.
- 6) K. Machida, T. Nishira, and T. Ohmi: *J. Phys. Soc. Jpn.* **68** (1999) 3364.
- 7) J. A. Sauls: *Adv. Phys.* **43** (1994) 113.
- 8) R. Joynt and L. Taillefer: *Rev. Mod. Phys.* **74** (2002) 235.
- 9) Y. Maeno, H. Hashimoto, K. Yoshida, S. Nishizaki, T. Fujita, J. G. Bednorz, and F. Lichtenberg: *Nature* **372** (1994) 532.
- 10) E. Bauer, G. Hilscher, H. Michor, C. Paul, E. W. Scheidt, A. Griбанov, Y. Seropegin, H. Noël, M. Sigrist, and P. Rogl: *Phys. Rev. Lett.* **92** (2004) 027003.
- 11) E. Bauer, H. Kaldarar, A. Prokofiev, E. Royanian, A. Amato, J. Sereni, W. Brämer-Escamilla, and I. Bonalde: *J. Phys. Soc. Jpn.* **76** (2007) 051009.
- 12) A. P. Mackenzie and Y. Maeno: *Rev. Mod. Phys.* **75** (2003) 657.
- 13) M. Sigrist: *Prog. Theor. Phys. Suppl.* **160** (2005) 1.
- 14) M. Sigrist, D. F. Agterberg, P. A. Frigeri, N. Hayashi, R. P. Kaur, A. Koga, I. Milat, K. Wakabayashi, and Y. Yanase: *J. Magn. Magn. Mater.* **310** (2007) 536.
- 15) N. Hayashi, K. Wakabayashi, P. A. Frigeri, and M. Sigrist: *Phys. Rev. B* **73** (2006) 024504.
- 16) Y. Yanase and M. Sigrist: *J. Phys. Soc. Jpn.* **76** (2007) 043712.
- 17) Y. Yanase and M. Sigrist: *J. Phys. Soc. Jpn.* **76** (2007) 124709.
- 18) Y. Yanase and M. Sigrist: *J. Phys. Soc. Jpn.* **77** (2008) 124711.
- 19) P. A. Frigeri, D. F. Agterberg, A. Koga, and M. Sigrist: *Phys. Rev. Lett.* **92** (2004) 097001.
- 20) S. Fujimoto: *J. Phys. Soc. Jpn.* **76** (2007) 051008.
- 21) V. M. Edélshtein: *Sov. Phys. JETP* **68** (1989) 1244.
- 22) L. P. Gor’kov and E. I. Rashba: *Phys. Rev. Lett.* **87** (2001) 037004.
- 23) Y. Yanase and M. Ogata: *J. Phys. Soc. Jpn.* **72** (2003) 673.
- 24) Y. Yanase, M. Mochizuki, and M. Ogata: *J. Phys. Soc. Jpn.* **74** (2005) 2568.
- 25) H. Murakawa, K. Ishida, K. Kitagawa, H. Ikeda, Z. Q. Mao, and Y. Maeno: *J. Phys. Soc. Jpn.* **76** (2007) 024716.
- 26) H. Murakawa, K. Ishida, K. Kitagawa, Z. Q. Mao, and Y. Maeno: *Phys. Rev. Lett.* **93** (2004) 167004.
- 27) S. Kittaka, S. Fusanobori, S. Yonezawa, H. Yaguchi, Y. Maeno, R. Fittipaldi, and A. Vecchione: *Phys. Rev. B* **77** (2008) 214511.
- 28) S. Kittaka, S. Yonezawa, H. Yaguchi, Y. Maeno, R. Fittipaldi, A. Vecchione, J. F. Mercure, A. Gibbs, R. S. Perry, and A. P. Mackenzie: *J. Phys.: Conf. Ser.* **150** (2009) 052113.
- 29) R. Fittipaldi, A. Vecchione, R. Ciancio, S. Pace, M. Cuomo, D. Stornaiuolo, D. Born, F. Tafuri, E. Olsson, S. Kittaka, H. Yaguchi, and Y. Maeno: *Europhys. Lett.* **83** (2008) 27007.
- 30) H. Mukuda, S. Nishide, A. Harada, K. Iwasaki, M. Yogi, M. Yashima, Y. Kitaoka, M. Tsujino, T. Takeuchi, R. Settai, Y. Onuki, E. Bauer, K. M. Itoh, and E. E. Haller: *J. Phys. Soc. Jpn.* **78** (2009) 014705.
- 31) T. Takeuchi, T. Yasuda, M. Tsujino, H. Shishido, R. Settai, H. Harima, and Y. Onuki: *J. Phys. Soc. Jpn.* **76** (2007) 014702.
- 32) G. Motoyama, K. Maeda, and Y. Oda: *J. Phys. Soc. Jpn.* **77** (2008) 044710.
- 33) N. Read and D. Green: *Phys. Rev. B* **61** (2000) 10267.
- 34) D. A. Ivanov: *Phys. Rev. Lett.* **86** (2001) 268.
- 35) A. P. Schnyder, S. Ryu, A. Furusaki, and A. W. W. Ludwig: *Phys. Rev. B* **78** (2008) 195125.
- 36) R. Roy: arXiv:0803.2868.
- 37) X.-L. Qi, T. L. Hughes, S. Raghu, and S.-C. Zhang: *Phys. Rev. Lett.* **102** (2009) 187001.
- 38) M. Sato: *Phys. Rev. B* **79** (2009) 214526.
- 39) T. Nomura and H. Ikeda: private communication.
- 40) Y. Yoshioka and K. Miyake: *J. Phys. Soc. Jpn.* **78** (2009) 074701.
- 41) E. I. Rashba: *Sov. Phys. Solid State* **1** (1959) 368.
- 42) M. Udagawa, Y. Yanase, and M. Ogata: *J. Phys. Soc. Jpn.* **74** (2005) 2905.
- 43) K. Ishida, H. Mukuda, Y. Kitaoka, K. Asayama, Z. Q. Mao, Y. Mori, and Y. Maeno: *Nature* **396** (1998) 658.
- 44) Y. Hasegawa and H. Taniguchi: *J. Phys. Soc. Jpn.* **78** (2009) 074717.
- 45) P. W. Anderson: *J. Phys. Chem. Solids* **11** (1959) 26.
- 46) Y. Tada, N. Kawakami, and S. Fujimoto: *New J. Phys.* **11** (2009) 055070.
- 47) K. Yada, S. Onari, Y. Tanaka, and J. Inoue: *Phys. Rev. B* **80** (2009) 140509.
- 48) M. Franz, C. Kallin, A. J. Berlinsky, and M. I. Salkola: *Phys. Rev. B* **56** (1997) 7882.
- 49) A. Ghosal, M. Randeria, and N. Trivedi: *Phys. Rev. B* **63** (2000) 020505.
- 50) Y. Yanase: *J. Phys. Soc. Jpn.* **75** (2006) 124715.
- 51) K. V. Samokhin, E. S. Zijlstra, and S. K. Bose: *Phys. Rev. B* **69** (2004) 094514.
- 52) A. Kozhevnikov and V. Anisimov: private communication.
- 53) S. Hashimoto, T. Yasuda, T. Kubo, H. Shishido, T. Ueda, R. Settai, T. D. Matsuda, Y. Haga, H. Harima, and Y. Onuki: *J. Phys.: Condens. Matter* **16** (2004) L287.
- 54) K. Deguchi, M. A. Tanatar, Z. Mao, T. Ishiguro, and Y. Maeno: *J. Phys. Soc. Jpn.* **71** (2002) 2839.
- 55) Y. Maeno, T. Ando, Y. Mori, E. Ohmichi, S. Ikeda, S. NishiZaki, and S. Nakatsuji: *Phys. Rev. Lett.* **81** (1998) 3765.
- 56) K. Tenya, S. Yasuda, M. Yokoyama, H. Amitsuka, K. Deguchi, and Y. Maeno: *J. Phys. Soc. Jpn.* **75** (2006) 023702.