

The Minimal Representation-Infinite Algebras which are Special Biserial

Claus Michael Ringel

Abstract. Let k be a field. A finite dimensional k -algebra is said to be minimal representation-infinite provided it is representation-infinite and all its proper factor algebras are representation-finite. Our aim is to classify the special biserial algebras which are minimal representation-infinite. The second part describes the corresponding module categories.

2010 Mathematics Subject Classification. Primary 16G20, 16G60. Secondary 16D90, 16G70.

Keywords. Minimal representation-infinite algebras, special biserial algebras. Quiver. Auslander-Reiten quiver. Auslander-Reiten quilt. Sectional paths. Irreducible maps. Gorenstein algebras. Semigroup algebras.

1. Introduction

The study of minimal representation-infinite k -algebras with k an algebraically closed field was one of the central themes of the representation theory around 1984 with contributions by Bautista, Gabriel, Roiter, Salmeron, Bongartz, Fischbacher and many others. Recent investigations of Bongartz [5] provide a new impetus for analyzing the module category of such an algebra and seem to yield a basis for a classification of these algebras. Here is a short summary of this development. First of all, there are algebras with a non-distributive ideal lattice, such algebras have been studied already 1957 by Jans [13]. Second, there are algebras with a good universal cover $\tilde{\Lambda}$ and such that $\tilde{\Lambda}$ has a convex subcategory which is a tame concealed algebra of type $\tilde{\mathbb{D}}_n, \tilde{\mathbb{E}}_6, \tilde{\mathbb{E}}_7$ or $\tilde{\mathbb{E}}_8$; these were the algebras which have been discussed by Bautista, Gabriel, Roiter and Salmeron in [2] (we say that the universal cover is *good* provided it is a Galois cover with free Galois group and is interval-finite). As Bongartz now has shown, the remaining minimal representation-infinite algebras also have a good cover $\tilde{\Lambda}$, but all finite convex subcategories of $\tilde{\Lambda}$ are representation-finite. These are the algebras which will be discussed here. We will show that such an algebra is special biserial and we will provide a full classification of the special biserial algebras which are minimal representation-infinite.

Let us recall the definition: A finite dimensional k -algebra is said to be *special biserial* (see [24]) provided it is Morita equivalent to the path algebra of a quiver Q with relations with the following properties:

(1) Any vertex of Q is endpoint of at most two arrows, and also starting point of at most two arrows.

(2) If two different arrows γ and δ start in the endpoint of the arrow α , then at least one of the paths $\gamma\alpha, \delta\alpha$ is a relation.

(2') If two different arrows α and β end in the starting point of the arrow γ , then at least one of the paths $\gamma\alpha, \gamma\beta$ is a relation.

Note that the composition of an arrow α with endpoint a and an arrow γ with starting point a is here denoted by $\gamma\alpha$, one should visualize the situation as follows:



The definition of a special biserial algebra looks quite technical, but actually there are a lot of natural examples of algebras which turn out to be of this kind. Note that a special biserial algebra is hereditary if and only if it is Morita equivalent to the path algebra of a quiver of type \mathbb{A}_n or $\widehat{\mathbb{A}}_n$, where the cyclic orientation of $\widehat{\mathbb{A}}_n$ has to be excluded in order to get a finite dimensional algebra.

Special biserial algebras were first studied by Gelfand and Ponomarev [11]: they have provided the methods in order to classify all the indecomposable representations of such an algebra. This classification shows that special biserial algebras are always tame (see also [26, 8]) and usually they are of non-polynomial growth. For the structure of the Auslander-Reiten quiver of a special biserial algebra we refer to [7]. The aim of the present paper is to describe the special biserial algebras which are minimal representation-infinite and to exhibit the corresponding module categories.

We can assume that the defining relations of the special biserial algebras to be considered are monomials (since otherwise we will obtain an indecomposable module which is both projective and injective, but minimal representation-infinite algebras do not have indecomposable modules which are both projective and injective).

If Λ is a finite dimensional algebra, a simple module S is said to be a *node* provided S is neither projective nor injective, and such that S does not occur as a composition factor of a module of the form $\text{rad } M / \text{soc } M$, where M is indecomposable and not simple. If Λ is given by a quiver with relations, then the simple module $S(a)$ corresponding to a vertex a is a node if and only if a is neither a sink nor a source and given an arrow α which ends in a and an arrow γ which starts in a , then $\gamma\alpha$ is a relation. There is a well-known procedure [15] to resolve nodes: For any algebra Λ , there is an algebra $\text{nn}(\Lambda)$ without nodes such that Λ and $\text{nn}(\Lambda)$ are stably equivalent: in case Λ is given by a quiver with relations, one just replaces any vertex a with $S(a)$ a node by two vertices a_+, a_- such that a_+ is a sink and a_- a source.

A vertex a of a quiver will be called an *n-vertex* provided a has n neighbors (this means that there are n_1 arrows ending in a and n_2 arrows starting in a and $n = n_1 + n_2$; observe that in this way, the loops at a are counted twice).

Theorem 1.1. *Assume the k -algebra Λ is special biserial and minimal representation-infinite. Then any 4-vertex of the quiver of Λ is a node.*

If we want to classify algebras which are minimal representation-infinite, it is sufficient to deal with algebras without a node, since an algebra Λ is minimal representation-infinite if and only if the node-free algebra $\text{nn}(\Lambda)$ is minimal representation-infinite, see section 7.

A finite dimensional hereditary algebra of type $\tilde{\mathbb{A}}$ will be said to be a *cycle algebra*. The main task of the paper will be to define two classes of finite dimensional algebras, the so-called barbell algebras and wind wheel algebras, see sections 5 and 6, respectively. These algebras are obtained from cycle algebras by a construction which we call barification (see section 4) and adding, if necessary, suitable zero relations.

Theorem 1.2. *The special biserial algebras which are minimal representation-infinite and have no nodes are the cycle algebras, the barbell algebras with non-serial bars and the wind wheel algebras.*

Theorem 1.3. *A minimal representation-infinite algebra is special biserial if and only if its universal cover C is good and any finite convex subcategory of C is representation-finite.*

The first part of these notes is devoted to a proof of theorems 1.1, 1.2 and 1.3.

The second part provides information on the module categories of the minimal representation-infinite special biserial algebras. As we have mentioned already, all special biserial algebras are tame. Dealing with the minimal representation-infinite ones, we encounter both algebras of non-polynomial growth (namely the barbell algebras) as well as domestic ones (the hereditary algebras of type $\tilde{\mathbb{A}}$ as well as all the wind wheel algebras), note that the domestic ones all are even 1-domestic. Here, an algebra is said to be *n-domestic* in case there are precisely n primitive 1-parameter family of indecomposable modules (and additional “isolated” indecomposables).

Not much is known about domestic algebras Λ in general, not even about 1-domestic algebras! The wind wheel algebras W provide new examples of 1-domestic algebras such that the Auslander-Reiten quiver has an arbitrary finite number of non-regular components (12.5) as well as having non-regular components with arbitrary ramification (12.6). Let us stress that the examples which we present all have Loewy length 3.

Also, we will describe in detail the corresponding Auslander-Reiten quilt Γ of a wind wheel, it is obtained from the set of Auslander-Reiten components which contain string modules by inserting suitable infinite dimensional algebraically compact indecomposable modules. We will see that Γ is a connected orientable surface with boundary, its Euler characteristic is $\chi(\Gamma) = -t$, where t is the number of bars.

A further property of the wind wheels W with t bars seems to be of interest: Let M be a primitive homogeneous and absolutely indecomposable W -module, and \underline{E} the factor ring of $\text{End}(M)$ modulo the ideal of endomorphisms with semisimple image, then \underline{E} is of dimension $t + 1$, thus arbitrarily large.

In general, we will show: Let Λ be a k -algebra which is minimal representation-infinite and special biserial. Then any complete sectional path is a mono ray, an

epi coray or the concatenation of an epi coray with a mono ray. This implies in particular the following: If X, Y, Z are indecomposable Λ -modules with an irreducible monomorphism $X \rightarrow Y$ and an irreducible epimorphism $Y \rightarrow Z$, then $X = \tau Z$.

Whereas we present in Part I full proofs for the main results, the discussion in Part II is less complete, several of the (sometimes tedious) combinatorial verifications are left to the reader.

Acknowledgment. The classification of the minimal representation-infinite special biserial algebras was first announced at the Trondheim conference 2007 and then presented in lectures at several places. The author is indebted to various mathematicians for helpful comments. At the ICRA workshop Tokyo 2010, the author gave a sequence of lectures dealing with minimal representation-infinite algebras in general. The following text written for the workshop proceedings restricts the attention again to the special biserial algebras.

Part I. The algebras

2. Preliminaries: Words

Given a quiver Q with vertex set Q_0 and arrow set Q_1 and a set ρ of monomial relations (monomial relations are paths of length at least 2), we consider (usually finite) words using as letters the arrows of the quivers and formal inverses of these arrows, the set of such words will be denoted by $\Omega(Q, \rho)$ (and just by $\Omega(Q)$ if no relations are given). In case the algebra A is given by the quiver Q with relations ρ , we also dare to write $\Omega(A)$ instead of $\Omega(Q, \rho)$ (but this is an abuse of notation).

Here is the proper definition: Let \overline{Q} be the quiver obtained from Q by adding formal inverses of the arrows (given an arrow α with starting point $s(\alpha)$ and terminal point $t(\alpha)$, we denote by α^{-1} a formal inverse of α , with starting point $s(\alpha^{-1}) = t(\alpha)$ and terminal point $t(\alpha^{-1}) = s(\alpha)$; given such a formal inverse $l = \alpha^{-1}$, one writes $l^{-1} = \alpha$). We consider paths in the quiver \overline{Q} , those of length $n \geq 1$ are of the form

$$w = l_1 l_2 \cdots l_n \quad \text{with} \quad s(l_i) = t(l_{i+1}) \quad \text{for all} \quad 1 \leq i < n$$

(one may consider w just as the sequence (l_1, l_2, \dots, l_n) , but it will be convenient, to delete the brackets and the colons). In addition, there are the paths of length zero corresponding to the vertices. By definition, the *inverse* of $w = l_1 \dots l_n$ is $w^{-1} = l_n^{-1} \dots l_1^{-1}$; a subword of w is of the form $l_i l_{i+1} \dots l_{j-1} l_j$ (with $1 \leq i \leq j \leq n$ or else a vertex which is starting or terminal point for some l_i). The elements of $\Omega(Q, \rho)$ are the paths $w = l_1 \dots l_n$ in \overline{Q} which satisfy the following conditions:

- (W1) We have $l_i^{-1} \neq l_{i+1}$, for all $1 \leq i < n$.
- (W2) No subword of w or its inverse belongs to ρ .

The elements of $\Omega(Q, \rho)$ will be called *words* for the quiver Q with the relations ρ , the arrows and their formal inverses will be called the *letters*. A word $w = l_1 \dots l_n$ is said to be *direct* provided all the letters l_i are arrows, and *inverse* provided w^{-1} is direct. A word which is either direct or inverse is said to be *serial*. Two letters l, l' will be said to have the same direction, if both are direct or if both are inverse letters.

We say that a word w is *without repetition* provided no letter appears twice in w . Given a word without repetition and a letter l , then both l and l^{-1} may appear in w ; in this case we will say that the edge $l^\pm = \{l, l^{-1}\}$ occurs twice in w .

Given a word $v = l_1 \dots l_s$ of length $s \geq 1$, we will write $v_1 = l_1$ and $v_\omega = l_s$. Given words v, w such that the starting point of v_ω is the endpoint of w_1 and $v_\omega, (w_1)^{-1}$ are different, but have the same direction, then we will say that the pair (v, w) is *attracting*. Note that for an attracting pair (v, w) , the composition vw is a word again.

Finally, recall that a word w is called *cyclic* provided it contains both direct and inverse letters and such that also $w^2 = ww$ is a word. A cyclic word w is said to be *primitive* provided it is not of the form v^t with $t \geq 2$.

An infinite sequence $l_1 l_2 \dots$ using our letters will be called a \mathbb{N} -word provided all the finite subsequences $l_1 l_2 \dots l_n$ are words. Similarly, a double infinite sequence $\dots l_{-1} l_0 l_1 \dots$ is said to be a \mathbb{Z} -word provided all the finite subsequences $l_{-n} \dots l_{-1} l_0 l_1 \dots l_n$ are words.

This report deals mainly with quivers Q with a set ρ of monomial relations which yield a special biserial algebra A . In this case, the finite dimensional A -modules are easy to construct and to characterize, this classification goes back to Gelfand and Ponomarev [11]. There are two kinds of indecomposable modules, the string modules and the band modules. Starting with any word $w \in \Omega(Q, \rho)$ of length n , there is an indecomposable module $M(w)$ of length $n + 1$, called a string module. In addition, there are one-parameter families of indecomposable A -modules which are constructed starting with a primitive cyclic word w as well as a finite dimensional vector space V with an automorphism ϕ such that the pair (V, ϕ) is indecomposable; the modules $M(w, \phi)$ are called the band modules. If V is one-dimensional and ϕ is the multiplication by $\lambda \in k \setminus \{0\}$, then we write $M(w, \lambda)$ instead of $M(w, \phi)$. For an outline of these constructions we refer to [18].

3. The cycle algebras.

We first describe the hereditary algebras of type \tilde{A} . They also will be used in order to construct the barbell as well as the wind wheel algebras.

We start with a function $\epsilon : \{1, \dots, n\} \rightarrow \{1, -1\}$; if necessary, we call such a function an *orientation sequence* of length n . In order to specify ϵ , we usually will write just the sequence $\epsilon(1)\epsilon(2) \dots \epsilon(n)$, or the corresponding sequence of signs $+$ and $-$. Note that this means that we consider ϵ as a word of length n in the letters $+$ and $-$. This interpretation explains also the following conventions: Assume

there is given an orientation sequence ϵ of length n . We say that ϵ starts with $\epsilon(1)$ and ends with $\epsilon(n)$. We write ϵ^{-1} for the function with $\epsilon^{-1}(i) = -\epsilon(n+1-i)$ for $1 \leq i \leq n$. Given a further orientation sequence ϵ' say of length n' , let $\epsilon\epsilon'$ be the orientation sequence of length $n+n'$ with $\epsilon\epsilon'(i) = \epsilon(i)$ for $1 \leq i \leq n$ and $\epsilon\epsilon'(i) = \epsilon'(i-n)$ for $n+1 \leq i \leq n+n'$.

The orientation sequences which we are interested in will be obtained by starting with a word $w = l_1 \cdots l_s \in \Omega(Q, \rho)$, where Q is a quiver with monomial relations ρ and looking at $\epsilon(w)$ defined by $\epsilon(w)(i) = 1$ if l_i is a direct letter and $\epsilon(w)(i) = -1$ otherwise.

Let ϵ be an orientation sequence. We attach to ϵ the hereditary algebra $H(\epsilon)$ with the following quiver: its vertices are $a_1, a_2, \dots, a_n = a_0$, and there is an arrow $\alpha_i : a_i \rightarrow a_{i-1}$ in case $\epsilon(i) = 1$ and $\alpha_i : a_{i-1} \rightarrow a_i$ in case $\epsilon(i) = -1$. The algebra $H(\epsilon)$ is finite dimensional if and only if ϵ is not constant. The algebras $H(\epsilon)$ with ϵ not constant, will be called the *cycle algebras*.

For example, if $\epsilon = (+ + - + - +)$, then $H(\epsilon)$ is the path algebra

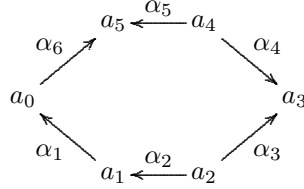

Always $\alpha_1^{\epsilon(1)} \alpha_2^{\epsilon(2)} \cdots \alpha_n^{\epsilon(n)}$ is a primitive cyclic word.

4. Barification.

Starting from a hereditary algebra of type $\tilde{\mathbb{A}}$, the further algebras will be obtained by identifying some subquivers and adding zero relations. The essential part of the construction will be described now.

Let Q be a quiver with relations. Let $a_1, \dots, a_t, a'_1, \dots, a'_t$ be pairwise different 2-vertices such that a_i, a_{i+1} as well as a'_i, a'_{i+1} are neighbors, for all $1 \leq i < t$. Thus there are letters l_i, l'_i for $0 \leq i \leq t$ such that l_{i-1}, l'_{i-1} end in a_i , or a'_i respectively, and l_i, l'_i start in a_i , or a'_i respectively, for $1 \leq i \leq t$. We assume that the letters l_i, l'_i have the same direction, for any $1 \leq i < t$, whereas l_0, l'_0 have different direction, and also l_t, l'_t have different direction. We assume in addition that the letters l_i, l'_i for $1 \leq i < t$ are not involved in any relation.

Let $v = l_1 \cdots l_{t-1}$ and $v' = l'_1 \cdots l'_{t-1}$. The *barification* of v and v' is defined as follows: We identify the vertex a_i with a'_i for $1 \leq i \leq t$, and label the new vertex again a_i ; also, we identify the arrow α_i between a_i, a_{i+1} with the arrow between a'_i, a'_{i+1} and label it again α_i . We add as new relation the compositions $l_0(l'_0)^{-1}$ as well as $(l'_t)^{-1}l_t$. If necessary, we will denote the new quiver with relations by $Q(v, v')$. The subquiver of $Q(v, v')$ given by the identified vertices and arrows is called a *bar* (at least if $t \geq 2$).

If $t = 1$, then we just identify two 2-vertices of Q in order to form a 4-vertex. If $t \geq 2$, then we identify sequences of 2-vertices and obtain from the identification

of a_1 with a'_1 a 3-vertex, then several 2-vertices, and finally as the identification of a_t with a'_t again a 3-vertex.

Note that in case we start with a quiver Q which is special biserial, the new quiver $Q(v, v')$ with relations again will be special biserial.

Here is a schematic example with $t = 5$. We indicate the relevant parts $v = (a_1 \leftarrow a_2 \leftarrow a_3 \rightarrow a_4 \leftarrow a_5)$ and $v' = (a'_1 \leftarrow a'_2 \leftarrow a'_3 \rightarrow a'_4 \leftarrow a'_5)$, but we do not specify what happens further (we just draw a box)

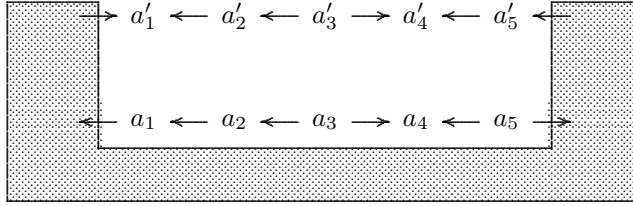

The barification yields a quiver of the following form:

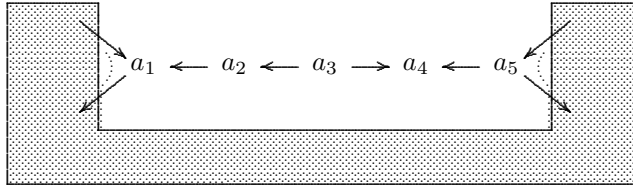

(the box is not changed).

5. The barbell algebras.

Definition: Consider orientation sequences $\epsilon, \eta, \epsilon'$ and assume that both ϵ and ϵ' start and end with $+$. We start with the hereditary algebra $H(\epsilon\eta\epsilon'\eta^{-1})$, and construct the barification using the two copies of η , this will be the *barbell algebra* $B(\epsilon, \eta, \epsilon')$. The subquiver given by (the identified copies of) η will be called its *bar*.

Example 1: Start with $\epsilon = \eta = \epsilon' = (+)$. Then $H(\epsilon\eta\epsilon'\eta^{-1})$ has the following shape:

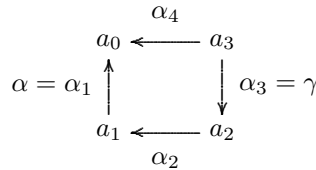

After the identification of α_2 and α_4 , we write β for the identified arrow:

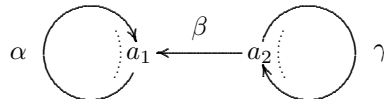

Here, the bar is just one arrow (namely β), thus serial.

Proposition 5.1. *A barbell algebra is minimal representation-infinite if and only if the bar is not serial.*

In case the bar η is direct, there are arrows α, γ such that $\alpha\eta\gamma$ is a word for the barbell algebra. If we add this word as a relation, we obtain an algebra which still is representation-infinite (it is a wind wheel algebras as discussed in the next section, thus 1-domestic). In example 1, the bar was serial, thus this barbell algebra was not minimal representation-infinite. Here is an example of a barbell with non-serial bar:

Example 2. We start with

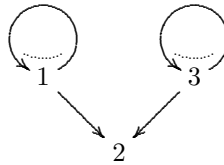

In order to construct this algebra, we can start with $\epsilon = (+)$, $\eta = (-+)$, $\epsilon' = (+)$. Then $H(\epsilon\eta\epsilon\eta^{-1})$ has the following shape:

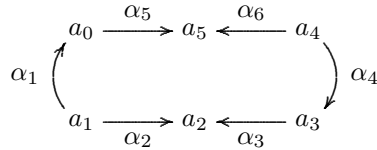

Here the bar (given by the arrows $1 \rightarrow 2 \leftarrow 3$) is not serial, thus the algebra is minimal representation-infinite.

6. The wind wheel algebras.

A *wind wheel algebra* W is given by a cyclic word w without repetition which is of the form

$$w = u_1 v_1 \cdots u_{2t} v_{2t}$$

with words u_i, v_i of length at least 1 and such that there is a (necessarily fixed point free) involution σ on the set $\{1, 2, \dots, 2t\}$ with the following properties:

(WW1) The words v_i are serial and $v_i = v_{\sigma(i)}^{-1}$.

(WW2) The edges appearing in some u_i occur only once in w , those occurring in some v_i occur twice in w (namely in v_i and in $v_{\sigma(i)}$).

(WW3) The pairs (v_i, u_{i+1}) are attracting, the pairs (u_i, v_i) are not attracting (here, $u_{2t+1} = u_1$).

Note that the factorization into the subwords u_i, v_i and the permutation σ are uniquely determined by w , thus we can write $W = W(w)$.

The algebra $W(w)$ is obtained from the $\tilde{\mathbb{A}}$ -algebra $H(\epsilon(w))$ by identifying the path v_i with $v_{\sigma(i)}^{-1}$ ("barification"), for all i , and using additional zero relations as follows: Let v_i be direct, and $v_j = v_i^{-1}$ (thus $j = \sigma(i)$). Then the barification relations are

$$u_{i,\omega}u_{j+1,1}, \quad (u_{i+1,1})^{-1}(u_{j,\omega})^{-1}$$

(recall that for any path u_i , we denote by $u_{i,1}$ its first letter, by $u_{i,\omega}$ the last one). And we take in addition also the paths

$$u_{i,\omega}v_i(u_{j,\omega})^{-1}$$

as relations. Thus, there are $2t$ monomial relations of length 2 as well as t long relations (of length at least 3).

As in the case of a barbell algebra, a subquiver given by (the identified copies of) some v_i will be called a *bar*.

Our example 1 yields the wind wheel algebra for the following word

$$\alpha\beta\gamma^{-1}\beta^{-1} \quad \text{with} \quad u_1 = \alpha, \quad v_1 = \beta, \quad u_2 = \gamma^{-1}, \quad v_2 = \beta^{-1}, \quad \text{and} \quad \sigma = (1, 2),$$

its quiver with relations is as follows:



Further examples are presented at the end of part I.

There is a canonical map $\eta : \Omega(H(\epsilon(w))) \rightarrow \Omega(W(w))$ defined as follows: write $w = l_1 \cdots l_n$ with letters l_i for the quiver of $W(w)$, then l_i may be considered as an arrow of the quiver of $H(\epsilon(w))$. We set $\eta(l_i) = l_i$ and extend this multiplicatively.

Given a bar v of $W(w)$, there are uniquely defined letters l_1, l_2 such that both (l_1, v) and (v, l_2) are attracting pairs. We call $\bar{v} = l_1vl_2$ the *closure* of the bar v .

Proposition 6.1. *A word in $\Omega(W(w))$ does not belong to the image of η if and only if it contains the closure of a bar as a subword.*

Proposition 6.2. *The wind wheel algebra $W = W(w)$ is domestic with only one primitive cyclic word, namely w . If t is the number of bars, then there are precisely t non-periodic (but biperiodic) \mathbb{Z} -words: Write $w = w_1vw_2v^{-1}$, where v is a bar. Then*

$$\infty(w^{-1})w_2^{-1}v^{-1}w_1^{-1}vw_2v^{-1}w^\infty$$

is such a \mathbb{Z} -word.

The \mathbb{Z} -word $\infty(w^{-1})w_2^{-1}v^{-1}w_1^{-1}vw_2v^{-1}w^\infty$ determines uniquely the central part $\bar{v} = l_1vl_2$ where $l_1 = (w_1^{-1})_\omega$ and $l_2 = (w_2)_1$, thus it determines the bar v ; Indeed, this word is the only \mathbb{Z} -word which contains a subword of the form l_1vl_2 such that both (l_1, v) and (v, l_2) are attracting pairs.

Proposition 6.3. *Let $W = W(w)$ be a wind wheel algebra with t bars. Let $\lambda \in k \setminus \{0\}$. Then the endomorphism ring of $M = M(w, \lambda)$ is a radical square zero algebra with radical dimension t , and the only endomorphism of M with semisimple image is the zero endomorphism.*

Thus we see that the wind wheels provide examples of 1-domestic algebras Λ with a primitive homogeneous and absolutely indecomposable Λ -module M such that the factor ring of $\text{End}(M)$ modulo the ideal of endomorphisms with semisimple image is of arbitrarily large dimension.

Proof. Any bar b provides an endomorphism of M with image $M(b)$, these endomorphisms form a basis of the radical of $\text{End}(M)$. \square

7. Proof of theorem 1.1

We want to present the proof of Theorem 1.1.

7.1. Resolving a node. The process of resolving a node a can be visualized as follows:

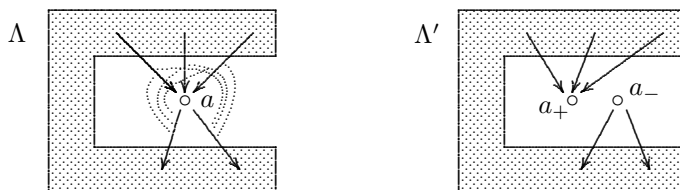

We replace the vertex a by two vertices labeled a_+ and a_- such that a_+ becomes a sink, a_- a source: all arrows of Λ will be kept, however, if an arrow of Λ ends in a , then in Λ' it ends in a_+ , whereas if an arrow of Λ starts in a , then in Λ' it starts in a_- . Since all the paths $\gamma\alpha$ with α ending in a (and therefore γ starting in a) are relations for Λ , there is a minimal set of relations consisting of these paths as well as of a set ρ' of relations which do not pass through a (a relation is a linear combination of paths and we say that the relation passes through a provided at least one of the paths contains a subpath $\gamma\alpha$ with α ending in a). It is the set ρ' which is used as set of relations for Λ' .

The important feature of this construction is the following: There is a canonical functor $\text{mod } \Lambda \rightarrow \text{mod } \Lambda'$ which yields a bijection between the indecomposable Λ -modules and the indecomposable Λ' -modules different from the simple Λ' -module $S(a_-)$.

There is the following quite obvious assertion:

Lemma. *Assume Λ is a finite dimensional algebra with a node a . Let Λ' be obtained from Λ by resolving the node. Then Λ is minimal representation-infinite if and only if Λ' is minimal representation-infinite.*

Thus, if we want to classify algebras which are minimal representation-infinite, it is sufficient to deal with algebras without a node.

7.2. Cyclic words. Recall that a word w which is neither direct nor inverse is called cyclic, provided w^2 is a word.

Lemma. *Let $w = \alpha u \alpha v$ be a cyclic word with α an arrow. Then at least one of the words αu , αv is a cyclic word.*

Proof. First, assume that neither u nor v is direct, write $u = u_1 u_2 u_3$ and $v = v_1 v_2 v_3$ with u_1, u_3, v_1, v_3 all being direct and of maximal possible length. Since w is a cyclic word, both $v_3 \alpha u_1$ and $u_3 \alpha v_1$ are words. Assume that αu is not a cyclic word, then there is a zero relation which is a subword of $u_3 \alpha u_1$. Since no subword of $v_3 \alpha u_1$ is a zero relation, we conclude that $u_3 = u'_3 v_3$ for some word u_3 . With $u_3 \alpha v_1 = u'_3 v_3 \alpha v_1$ also $v_3 \alpha v_1$ is a word. This implies that αv is a cyclic word.

Now assume u is direct. Since w is not direct, we know that v cannot be direct. As above, write $v = v_1 v_2 v_3$ with v_1, v_3 direct and of maximal possible length. Since w is a cyclic word, there is no zero relation which is a subword of $v_3 \alpha u \alpha v_1$. But the direct word $v_3 \alpha v_1$ is a subword of $v_3 \alpha u \alpha v_1$, thus we see that there is no subword of $v_3 \alpha v_1$ is a zero relation, thus αv is a cyclic word. This completes the proof. \square

As a consequence, we see: if w is a cyclic word of minimal length, then any arrow can occur in w at most once as a direct letter, and at most once as an inverse letter. In particular, the length of w is bounded by $2a$, where a is the number of arrows. (A typical example of a cyclic word of minimal length which contains both an arrow as well as its inverse is given by example 1.)

7.3. The 4-vertices. Let a be a 4-vertex, with arrows α, β ending in a and arrows γ, δ starting in a such that the words $\gamma\beta$ and $\delta\alpha$ are relations.

Let w be a cyclic word of smallest possible length. Assume w contains $\gamma\alpha$ as a subword.

Up to rotation, we can assume that w starts with $\gamma\alpha$. Assume w also contains β^{-1} , say $w = \gamma\alpha u \beta^{-1} v$, for some words u, v . Then $\alpha u \beta^{-1}$ is a cyclic word of shorter length, a contradiction. Similarly, if $w = \gamma\alpha u \delta^{-1} v$, for some words u, v , then $\gamma\delta^{-1} v$ is a cyclic word of shorter length.

Now assume that w contains $\delta\beta$ as a subword. Then $w = \gamma u \beta v$ where u, v are words such that u starts with α and ends with δ (it may be that $u = \alpha u' \delta$, or else $\alpha = u = \delta$). Then we consider $w' = \gamma u^{-1} \beta v$. This is again a cyclic word, and it contains neither $\delta\beta$ or its inverse as a subword. Namely, according to Lemma 1, $\delta\beta$ was contained just once as a subword of w , and this composition has been destroyed when we built w' . Also no new composition has been created.

Finally, we have to consider the case that w does not contain $\delta\beta$. Since w has to contain β and δ , it must contain $\alpha^{-1}\beta$ and $\delta\gamma^{-1}$. By Lemma 1, w contains $\gamma\alpha$ only once, and it cannot contain $\alpha^{-1}\gamma^{-1}$, since otherwise we apply the previous considerations to w^{-1} . Let $w = \gamma\alpha u \delta \gamma^{-1} u'$, then the subword $\alpha u \delta$ does not contain $\gamma\alpha$ or its inverse. Similarly, write $w = \gamma\alpha v' \alpha^{-1} \beta v$, then $\beta v \gamma$ is a subword of w^2 and does not contain $\gamma\alpha$ or its inverse. We form the word $\alpha u \delta (\beta v \gamma)^{-1} = \alpha u \delta \gamma^{-1} v^{-1} \beta^{-1}$. This is a cyclic word which does not contain $\gamma\alpha$ or its inverse. This shows that the factor algebra with the added relations $\gamma\alpha$ and $\delta\beta$ is still representation-infinite. This completes the proof.

8. Proof of Theorem 1.2

We can assume that we deal with a special biserial algebra Λ with no 4-vertex. Let w be a cyclic word of minimal length, thus no letter occurs twice. Given an arrow α , we will say that the edge α^\pm occurs once in w if precisely one of the letters α, α^{-1} occurs in w , and that it occurs twice if both occur; these are the only possibilities, since we can assume that any arrow or its inverse occurs in w .

We can assume that all the vertices of Q are 2-vertices or 3-vertices (note that the support of a cyclic word cannot contain a 1-vertex). In case all the vertices are 2-vertices, then we deal with a hereditary algebra of type $\tilde{\mathbb{A}}$. Thus we can assume that there is at least one 3-vertex.

If a is a 3-vertex, there can be only one zero-relation of length two passing through a , since otherwise the word w could not pass through a . Thus, we deal with the following local situation

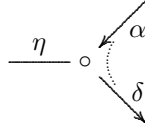

Then η^\pm occurs twice in w whereas α^\pm and δ^\pm occur just once. Proof: Since α^\pm as well as δ^\pm both have to occur at least once, this yields two different subwords of w involving η^\pm . But if α^\pm or δ^\pm would occur twice, we would obtain at least three letters of the form η and η^{-1} , impossible.

In this way, we see that there are edges which occur once, as well as edges which occur twice.

This shows clearly the structure of the word w . Up to rotation, we can assume that w starts in a 3-vertex, and that the inverse of the first letter does not occur in w . Of course, then the last letter yields an edge which occurs twice. We cut w into pieces

$$w = u_1 v_1 \cdots u_m v_m,$$

such that any u_i uses edges which occur only once, whereas the v_i use edges which occur twice. We obtain an involution σ on the set $\{1, 2, \dots, m\}$ with $v_{\sigma(i)} = v_i^{-1}$ (note that in case l is a letter which occurs in some v_i , and l^{-1} occurs in v_j , then necessarily $v_j = v_i^{-1}$, thus we define $\sigma(i) = j$). The involution σ has no fixed point. Namely, $v^{-1} \neq v$ for any word v : in case v has odd length, just consider the middle letter, it cannot be both direct and inverse; in case v has even length, say $v = l_1 \cdots l_{2t}$ with letters l_i , then $l_{t+1} = l_t^{-1}$, which is excluded. This shows that $m = 2n$ is even.

Let us look at the behavior of the compositions $u_i v_i$ and $v_i u_{i+1}$ and compare this with the compositions $u_{\sigma(i)} v_{\sigma(i)}$ and $v_{\sigma(i)} u_{\sigma(i)+1}$, taking into account that $v_{\sigma(i)} = v_i^{-1}$. The composition $u_i v_i$ occurs at the same 3-vertex as $v_{\sigma(i)} u_{\sigma(i)+1}$; thus precisely one of the pairs (u_i, v_i) and $(v_{\sigma(i)}, u_{\sigma(i)+1})$ is attracting. Similarly, precisely one of the pairs (v_i, u_{i+1}) and $(u_{\sigma(i)}, v_{\sigma(i)})$ is attracting.

Claim: *If one of the words v_i is not serial, then $n = 1$.* Let us assume that $n \geq 2$ and that one of the words v_i is not serial, say $v_i = xy$ such that the pair (x, y) is attracting.

Two different cases have to be considered. The first case is the following:

$$\begin{array}{cccccccc} w_1 & & v & & w_2 & & v^{-1} & & w_3 & & xy & & w_4 & & y^{-1}x^{-1} \\ \hline & | & & | & & | & & | & & | & & | & & | & & | \end{array}$$

where all the w_i start and end with edges which occur only once.

We can assume that the pair (w_1, v) is not attracting. Otherwise, (v^{-1}, w_3) is not attracting, and we replace the given word w first by w^{-1} and then by a rotated one in order to obtain a similar situation.

We claim that we can replace w_1 at the beginning by the word by w_3^{-1} , thus dealing with

$$w_3^{-1}vw_2v^{-1}w_3xyw_4y^{-1}x^{-1}.$$

This is a word. Namely, since the pair (w_1, v) is not attracting, the pair (v^{-1}, w_3) is attracting, thus the same is true for the inverse. Also, it is a cyclic word, since the pair (w_3x, y) , thus also $(y^{-1}, x^{-1}w_3)$ is attracting.

It remains to observe that this new cyclic word uses less arrows: all the edges of w_1 which have multiplicity 1 in w have disappeared. This contradicts that Q is minimal representation-infinite.

Let us now discuss the second case, where xy lies in between v and v^{-1} .

$$\begin{array}{cccccccc} w_1 & & v & & w_2 & & xy & & w_3 & & v^{-1} & & w_4 & & y^{-1}x^{-1} \\ \hline & | & & | & & | & & | & & | & & | & & | & & | \end{array}$$

where again all the w_i start and end with edges which occur only once. Again, we can assume that the pair (w_1, v) is not attracting (otherwise, the pair (v^{-1}, w_4) is not attracting and we invert and rotate w).

This time, we claim that

$$vw_2x|yw_4^{-1}$$

is a cyclic word. The first part is a subword of w , the inverse of the second part is also a subword of w . Thus, both words vw_2x and yw_4^{-1} exist and they can be composed, since (x, y) is an attracting pair. Also, it is a cyclic word, since (w_4^{-1}, v) is an attracting pair: By assumption, (w_1, v) is not attracting, thus (v^{-1}, w_4) is an attracting pair, and therefore the same is true for its inverse (w_4^{-1}, v) .

The case $n = 1$ with $v = v_1$ non-serial yields a barbell.

Thus, we now assume that all the words v_i are serial.

Claim: (*) *If (u_1, v_1) is not attracting, then also $(u_{\sigma(1)}, v_{\sigma(1)})$ is not attracting, but (v_1, u_2) is attracting.*

Let $s = \sigma(1)$, and assume that (u_1, v_1) is not attracting, but (u_s, v_s) is attracting. Let $w_2 = u_2v_2 \cdots v_{s-1}u_s$ and $w' = u_{s+1}v_{s+1} \cdots u_mv_m$, thus $w = u_1v_1w_2v_sw'$ and $v_s = v_1^{-1}$. We claim that

$$w'' = u_1v_1w_2^{-1}v_sw'$$

is a cyclic word. Of course, u_1v_1 is a subword of w . Also, $w_2^{-1}v_s = w_2^{-1}v_1^{-1} = (v_1w_2)^{-1}$ is the inverse of a subword of w . Since we assume that $(w_2, v_s) = (w_2, v_1^{-1})$ is attracting, also the inverse (v_1, w_2^{-1}) is attracting, and thus also $(u_1v_1, w_2^{-1}v_s)$ is attracting. Since (u_1, v_1) is not attracting, the pair $(v_s, u_{s+1}) = (v_1^{-1}, u_{s+1})$ is attracting. This shows that the concatenation of v_s with w' or even with $w'u_1v_1$ provides no problem. Therefore we see that w'' is a cyclic word.

Note that w has the serial word $z = u_{1,\omega}v_1u_{2,1}$ as a subword, whereas this is no longer a subword of w'' . This means that we can use z as an additional relation and still have the cyclic word w'' . This contradicts the assumption that we deal with a minimal representation-infinite algebra. This contraction shows that $(u_{\sigma(1)}, v_{\sigma(1)})$ is not attracting, but then (v_1, u_2) has to be attracting.

Claim: *If (u_1, v_1) is not attracting, then also (u_2, v_2) is not attracting.* Thus, let us assume that (u_2, v_2) is attracting, whereas (u_1, v_1) is not. We already have seen in (*) that $(u_{\sigma(1)}, v_{\sigma(1)})$ is not attracting, thus $\sigma(1) \neq 2$.

We know from (*) that (v_1, u_2) is attracting. By assumption, also (u_2, v_2) is attracting.

Consider the case that $\sigma(2) < \sigma(1)$.

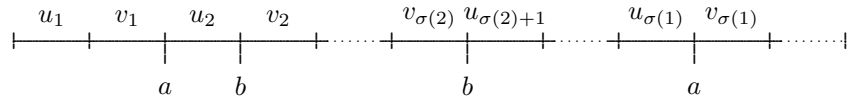

Thus we may replace $u_{\sigma(2)+1} \cdots u_{\sigma(1)}$ by u_2^{-1} and obtain the cyclic word

$$u_1v_1 \cdots v_{\sigma(2)} | u_2^{-1} | v_{\sigma(1)} \cdots v_m.$$

But here we use less arrows: all the arrows in $u_{\sigma(2)+1}$ have disappeared.

Finally, we have to deal with the case that $\sigma(1) < \sigma(2)$.

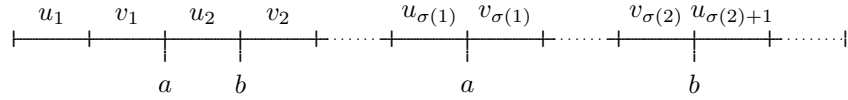

and take the cyclic word

$$v_{\sigma(1)} \cdots v_{\sigma(2)} u_2^{-1}.$$

This exists, since the pairs $(v_1, u_2) = (v_{\sigma(1)}^{-1}, u_2)$ and $(u_2, v_2) = (u_2, v_{\sigma(2)}^{-1})$ both are attracting. In this case, we lose for example all the arrows which occur in u_1 .

Altogether we see that w defines a wind wheel algebra.

9. Proof of Theorem 1.3

Let Λ be special biserial, let Q be its quiver. If Λ is minimal representation-infinite, then the ideal of relations is generated by a set ρ of zero relations, thus the universal cover $\tilde{\Lambda}$ of Λ is given by the universal cover \tilde{Q} of the quiver Q and the set $\tilde{\rho}$ of lifted relations. It follows that $\tilde{\Lambda}$ is special biserial with a quiver which is a tree,

and the indecomposable $\tilde{\Lambda}$ -modules are string modules with support a quiver of type \mathbb{A}_n . It follows that any finite convex subcategory is representation-finite.

Conversely, assume now that Λ is a finite dimensional basic k -algebra which is minimal representation-infinite, that the universal cover $\tilde{\Lambda}$ of Λ is good and that any finite convex subcategory of $\tilde{\Lambda}$ is representation-finite. We want to show that Λ is special biserial.

Let Q be the quiver of Λ and \tilde{Q} the quiver of $\tilde{\Lambda}$. We denote by $\pi : \text{mod } \tilde{\Lambda} \rightarrow \text{mod } \Lambda$ the covering functor (often called push-down functor, or forgetful functor).

For any finite dimensional k -algebra A , let $s(A)$ be the number of (isomorphism classes of) simple A -modules.

Note that $\tilde{\Lambda}$ is not of bounded representation type, since otherwise also Λ would be of bounded, thus finite, representation type. Thus we see that there are indecomposable representations M of $\tilde{\Lambda}$ of arbitrarily large length. Given such a representation M say of length m , its support algebra C is a representation-directed algebra, thus $s(C) \geq \frac{m}{6}$. This shows that there are indecomposable representations M of $\tilde{\Lambda}$ whose support has with arbitrarily large cardinality.

The sincere representation-directed algebras with large support have been classified by Bongartz (see [4] or [17]). Such an algebra C has a convex subalgebra B which is given by a quiver of type \mathbb{A}_n (without any relation), such that $s(B) \geq \frac{1}{3}s(C)$. Thus we see: $\tilde{\Lambda}$ has convex subcategories B which are given by a quiver of type \mathbb{A}_n without relations, where n is arbitrarily large.

Let $p(\Lambda)$ the Loewy length of Λ . Choose a convex subcategory B of $\tilde{\Lambda}$ which is of the form \mathbb{A}_n and without relations, where $n > 4p(\Lambda)s(\Lambda)$ and let M the (unique) simple representation of B . Note that the indecomposable B -modules are string modules, they are given by words using as letters the arrows of the quiver of B . Since $n > 4l(\Lambda)s(\Lambda)$, it follows easily that there is a simple Λ -module S such that $[\text{soc } \pi(M : S)] \geq 3$. But this implies that there is an indecomposable B -module N which is given by a word of the form $w = l_1 l_1 \cdots l_t$, with arrows l_1 and l_t^{-1} such that $\pi(l_1)$ and $\pi(l_t^{-1})$ are different arrows of Q and end in the same vertex of Q (namely the support vertex of S).

We denote by A the support algebra of N , it is given by a quiver of type \mathbb{A}_{t+1} without any relation, and $\pi(N)$ has a one-parameter family of simple submodules U such that the Λ -modules $\pi(N)/U$ are indecomposable and pairwise non-isomorphic. Since Λ is minimal representation-infinite, it follows that $\pi(N)$ is faithful, thus we obtain all the vertices and all the arrows of Q by applying π to the vertices and arrows of A , respectively.

Since we now know that the vertices and the arrows of Q are images under π of vertices and arrows in the support of A , it follows that the support of A contains a fundamental domain for the action of the Galois group on \tilde{Q} . In particular, we see that we can compose the word w with a word w' such that $\pi(w) = \pi(w')$ and so on.

Now assume there is a vertex x of Q with 3 arrows ending in x , say α, β, γ . Looking at the universal cover, we obtain arrows $\tilde{\alpha}, \tilde{\beta}, \tilde{\gamma}$ ending in the same vertex \tilde{x} . But the arrow $\tilde{\alpha}$ is the first letter of a word $w' = l'_1 l'_2 l'_3$ of length 3 which yields a string module for $\tilde{\Lambda}$. Similarly, the arrow $\tilde{\beta}$ is the first letter of a word $w'' = l''_1 l''_2 l''_3$

of length 3 which also yields a string module for $\tilde{\Lambda}$. But the union of the support of the words w', w'' and γ is a subquiver (without any relation) of \tilde{Q} of type $\tilde{\mathbb{E}}_7$. This contradicts the assumption that any finite subcategory of $\tilde{\Lambda}$ is representation-finite.

The dual argument shows that any vertex of Q is starting point of at most two arrows.

Now assume that the vertex x of Q is endpoint of the arrows $\alpha \neq \beta$ and starting point of the arrow γ and that neither $\gamma\alpha$ nor $\gamma\beta$ is a zero relation. We look again at the universal cover, and obtain arrows $\tilde{\alpha}, \tilde{\beta}$ ending in a vertex \tilde{x} , as well as $\tilde{\gamma}$ starting in the vertex \tilde{x} . Since $\gamma\alpha$ is not a zero relation, we see that $\tilde{\gamma}\tilde{\alpha}$ must be a subword of w or w^{-1} , in particular we can prolong it to a word $w' = l'_1 l'_2 l'_3 l'_4$ of length 4 so that we have a corresponding string module $M(w')$. Similarly, we prolong $\tilde{\gamma}\tilde{\beta}$ to a word $w'' = l''_1 l''_2 l''_3 l''_4$ of length 4 with string module $M(w'')$. We consider the union of the support of the words w', w'' ; it is a subquiver (without any relation) of \tilde{Q} , again of type $\tilde{\mathbb{E}}_7$, thus again we obtain a contradiction to the assumption that any finite subcategory of $\tilde{\Lambda}$ is representation-finite.

10. Further examples.

First, we present a second example of a barbell algebras with non-serial bar.

Example 3. Start with $\epsilon = (+), \eta = (+-), \epsilon' = (+ - +)$. Then $H(\epsilon\eta\epsilon'\eta^{-1})$ has the following shape:

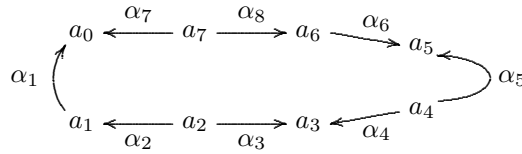

and $B(\epsilon, \eta, \epsilon')$ will be

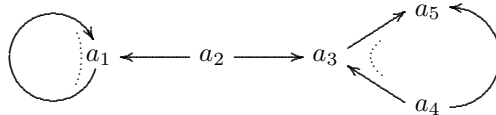

Again, the bar (given by the arrows $a_1 \leftarrow a_2 \rightarrow a_3$) is not serial.

The next examples are wind wheel algebras.

Example 4. The wind wheel algebra for the word w

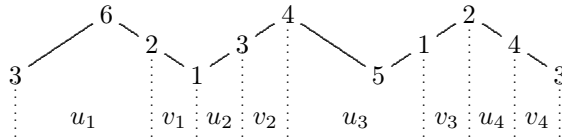

The permutation is $\sigma = (13)(24)$. The short zero relations are

$$\begin{aligned}
 u_{1,\omega}u_{3+1,1} &= 6 - 2 - 4 \\
 u_{2,\omega}u_{4+1,1} &= 1 - 3 - 6 \\
 u_{3,\omega}u_{1+1,1} &= 5 - 1 - 3 \\
 u_{4,\omega}u_{2+1,1} &= 2 - 4 - 5
 \end{aligned}$$

The long zero relations are

$$\begin{aligned}
 u_{1,\omega}v_1u_{3,\omega}^{-1} &= 6 - 2 - 1 - 5 \\
 u_{2,\omega}v_2u_{4,\omega}^{-1} &= 1 - 3 - 4 - 2 \\
 u_{3,\omega}v_3u_{1,\omega}^{-1} &= (u_{1,\omega}v_1u_{3,\omega}^{-1})^{-1} \\
 u_{4,\omega}v_4u_{2,\omega}^{-1} &= (u_{2,\omega}v_2u_{4,\omega}^{-1})^{-1}
 \end{aligned}$$

The corresponding wind wheel algebra $W = W(w)$ is:

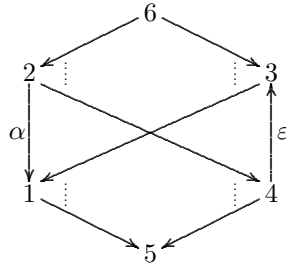

with the further relations $6 \rightarrow 2 \rightarrow 1 \rightarrow 5$ and $2 \rightarrow 4 \rightarrow 3 \rightarrow 1$. There are two bars, they are given by the arrows α and ϵ .

In order to construct W , one starts with the following orientation sequence:

$$\begin{array}{cccccccc}
 \vdots & + & - & \vdots & - & + & \vdots & + & \vdots & - & + & \vdots & + & \vdots & - & \vdots & - & \vdots \\
 & & \epsilon_1 & & & \eta_1 & & \epsilon_2 & & \eta_2 & & \epsilon_3 & & \eta_3 & & \epsilon_4 & & \eta_4 & \\
 \vdots & & & \vdots & & & \vdots & & \vdots & & & \vdots & & & \vdots & & & & \vdots
 \end{array}$$

and constructs the hereditary algebra $H(\epsilon_1\eta_1 \cdots \epsilon_4\eta_4)$:

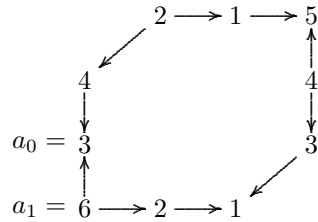

Thus, we start with a quiver which can be drawn either as a zigzag (with arrows pointing downwards), where the left end and the right end have to be identified,

or else as a proper cycle:

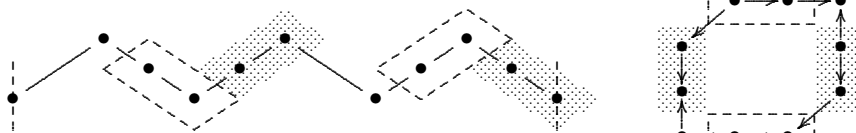

and we barify on the one hand the two subquivers which are enclosed in rectangular boxes, on the other hand also the two subquivers with shaded background.

In both cases, the barification yields an identification of a projective serial module of length 2 with an injective serial module of length 2.

Example 5. We start with the following orientation sequence:

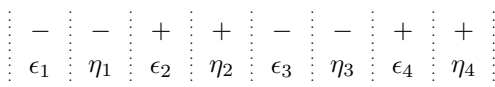

and construct the hereditary algebra $H(\epsilon_1\eta_1 \cdots \epsilon_4\eta_4)$:

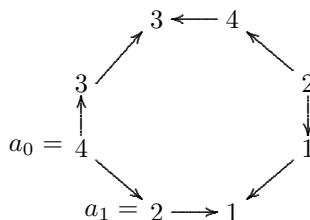

The quiver which we obtain is

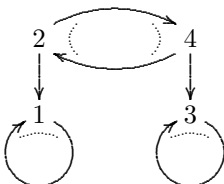

with the additional relations: $4 \rightarrow 2 \rightarrow 1 \rightarrow 1$ and $2 \rightarrow 4 \rightarrow 3 \rightarrow 3$. The bars are given by the arrows $2 \rightarrow 1$ and $4 \rightarrow 3$.

Example 6. As in example 4, consider again

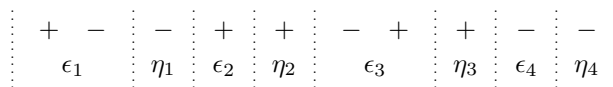

But now we take $\sigma = (12)(34)$

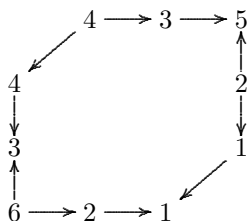

Here is the quiver:

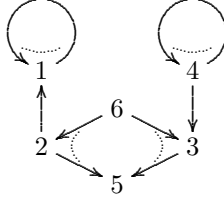

with the additional relations $6 \rightarrow 2 \rightarrow 1 \rightarrow 1$ and $5 \leftarrow 3 \leftarrow 4 \leftarrow 4$. The bars are again the arrows $2 \rightarrow 1$ and $4 \rightarrow 3$.

Part II. The module categories

11. The cycle algebras

We consider the algebras $H = H(\epsilon)$ where ϵ is not constant, so that H is finite dimensional.

11.1. The Auslander-Reiten quiver. The structure of the Auslander-Reiten quiver of H is well-known: there is the preprojective and the preinjective component, the remaining components are regular tubes.

The string modules form four components of the Auslander-Reiten quiver, namely the preprojective component, the preinjective component, and two tubes (we call them *string tubes*); the remaining components (the *band tubes*) are homogeneous. Note that the string tubes may be homogeneous or exceptional!

The Auslander-Reiten quiver of H looks as follows:

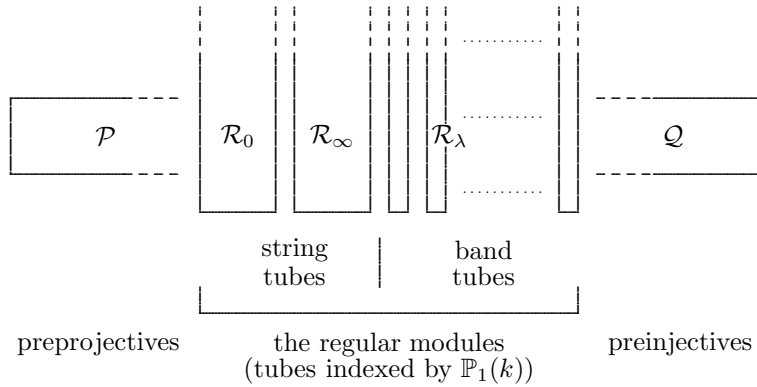

One should stress that in this case all the Auslander-Reiten components are (considered as simplicial complexes, thus as topological spaces) surfaces with boundary; all are homeomorphic to $[0, \infty[\times S^1$.

11.2. An example. We consider $\epsilon = (++++-----)$ and depict here, for later reference, the four components which contain string modules, always we draw two fundamental domains inside the universal cover of the component, they are separated by dashed lines (horizontal ones for the preprojective and the preinjective component, vertical ones for the regular components). Note that instead of arrows, we show edges, the orientation is from left to right.

the preprojective
component \mathcal{P}

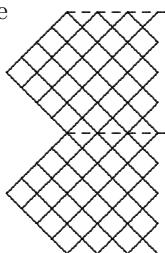

the preinjective
component \mathcal{Q}

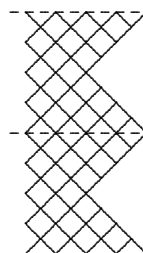

the two exceptional tubes:

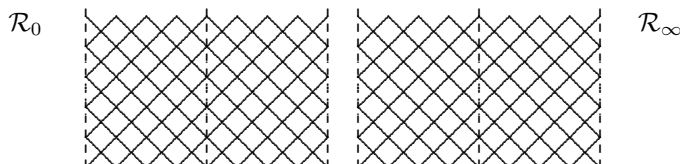

11.3. The serial modules for a cycle algebra. Recall that a module is called *serial* provided it has a unique composition series. We consider the serial H -modules, where H is a cycle algebra. The following assertions are easy to verify:

Lemma. *Any serial H -module M is projective or regular or injective.*

If M is a serial H -module of length at least two, and M is projective, then M/soc belongs to \mathcal{R}_0 or \mathcal{R}_∞ .

If M is a serial H -module of length at least two, and M is injective, then $\text{rad } M$ belongs to \mathcal{R}_0 or \mathcal{R}_∞ .

In the barification process, we barify a projective serial module $M(b)$ of length at least 2 with $M(b)/\text{soc}$ say in \mathcal{R}_0 and an injective serial module $M(b')$ of the same length with $\text{rad } M(b')$ in \mathcal{R}_∞ .

Our convention for distinguishing \mathcal{R}_0 and \mathcal{R}_∞ will be the following: given an indecomposable projective H -module P with radical $\text{rad } P = X \oplus X'$, where X and X' are serial modules, we fix the order X, X' and assume that the module P/X' as well as the composition factors of X'/soc are simple regular objects of \mathcal{R}_0 , whereas the module P/X as well as the composition factors of X/soc are

simple regular objects of \mathcal{R}_∞ :

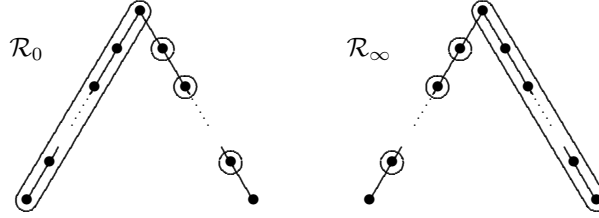

12. The wind wheel algebras.

Let H be hereditary of type \tilde{A} , and $W \subset H$ a corresponding wind wheel algebra. Let us look at the restriction functor $\eta : \text{mod } H \rightarrow \text{mod } W$.

First, let us recall the shape of the category $\text{mod } H$.

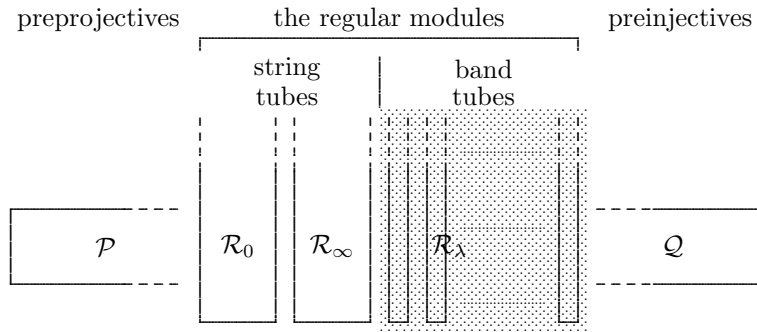

We have shaded the homogeneous tubes: they remain untouched; whereas the other four components are cut (between rays or corays) into pieces and these pieces are embedded (with some overlap) into a component which contain in addition so-called quarters. This cut-and-paste process will now be explained.

12.1. Example. We consider the wind wheel algebra $W(w)$ for the word

$$w = \alpha\beta_1\beta_2\beta_3\gamma^{-1}\beta_3^{-1}\beta_2^{-1}\beta_1^{-1},$$

thus we start with the quiver $H = H(\epsilon(w))$

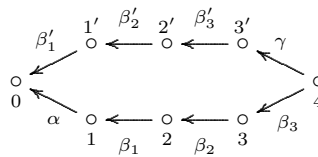

and barify the subquivers $1 \leftarrow 2 \leftarrow 3 \leftarrow 4$ and $0 \leftarrow 1' \leftarrow 2' \leftarrow 3'$.

We obtain in this way the wind wheel algebra $W = W(w)$

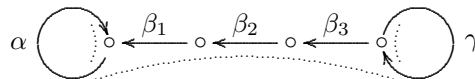

with $\alpha^2 = \gamma^2 = \alpha\beta_1\beta_2\beta_3\gamma = 0$.

Recall that we know: *There is precisely one non-periodic (but bi-periodic) \mathbb{Z} -word, namely*

$$r(b) = \dots(w'') \cdot \alpha^{-1}\beta_1\beta_2\beta_3\gamma^{-1} \cdot (w')^\infty$$

where $w' = \beta_3^{-1}\beta_2^{-1}\beta_1^{-1}\alpha\beta_1\beta_2\beta_3\gamma^{-1}$, and $w'' = \alpha^{-1}\beta_1\beta_2\beta_3\gamma\beta_3^{-1}\beta_2^{-1}\beta_1^{-1}$.

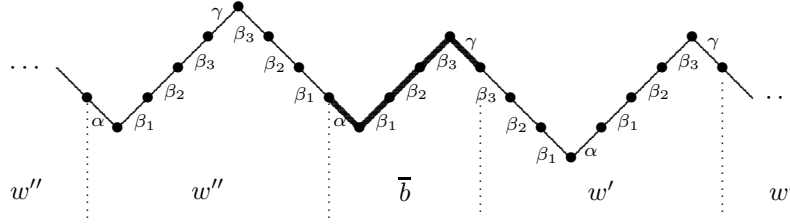

with $b = \beta_1\beta_2\beta_3$ and $\bar{b} = \gamma^{-1}\beta_1\beta_2\beta_3\alpha^{-1}$ (the word w' is obtained from w by rotation, the word w'' by rotation and inversion).

Here we see the reason why we call these algebras the wind wheels: We consider the word $r(b)$ as a pair of opposite "rotor blades".

12.2. Proposition. *The restriction functor*

$$\eta : \text{mod } H \rightarrow \text{mod } W$$

has the following properties:

- (1) *Indecomposable modules are sent to indecomposable modules.*
- (2) *Corresponding modules on the two \mathbb{A}_4 -quivers which yield the bar become isomorphic, otherwise non-isomorphy is preserved.*
- (3) *The indecomposable W -modules which are not in the image of the functor are the string modules for words which contain $\alpha^{-1}\beta_1\beta_2\beta_3\gamma^{-1}$ as a subword.*

Note that $\bar{b} = \alpha^{-1}\beta_1\beta_2\beta_3\gamma^{-1}$ is the closure of the bar $b = \beta_1\beta_2\beta_3$, as defined in section 6.

In order to outline the cut-and-paste process, we start with the Auslander-Reiten components containing string modules, as shown above. We assume that \mathcal{R}_0 is the tube which contains at the boundary the simple H -modules $1, 2, 3$ as well as the serial module with composition factors $0, 1', 2', 3', 4$, whereas \mathcal{R}_∞ is the tube which contains at the boundary the simple H -modules $1', 2', 3'$ and the serial module with composition factors $0, 1, 2, 3, 4$.

Let us look at the full subcategories of $\text{mod } H$ with modules with support in $\{0, 1, 2, 3\}$ on the one hand (see the left picture) as well as those with support in $\{1', 2', 3', 4\}$ on the other hand (the right picture) and describe the role of the

various modules inside $\text{mod } H$:

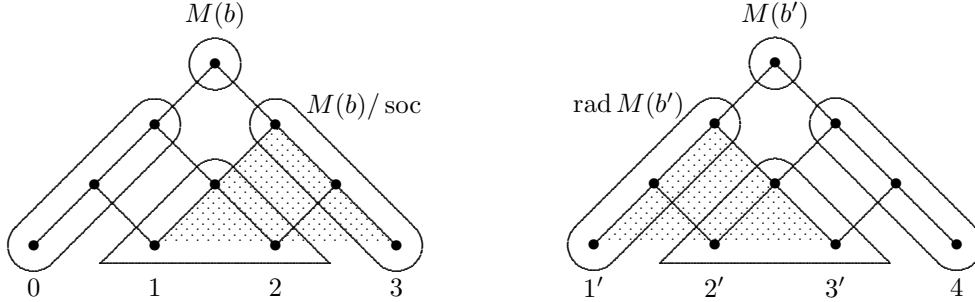

In the left picture, the shaded area marks those modules which belong to \mathcal{R}_0 , whereas the remaining modules (those which form the left boundary) are projective, thus in \mathcal{P} . In the right picture, the shaded area marks those modules which belong to \mathcal{R}_∞ , the remaining ones are injective, thus in \mathcal{Q} . According to property (2), any module of the left triangle is identified under η with the corresponding module of the right triangle.

Let us look at the various components of $\text{mod } H$ which contain string modules. We will add bullets \bullet in order to mark the position of the indecomposables with support contained either in $\{0, 1, 2, 3\}$ or else in $\{1', 2', 3', 4\}$. We are going to cut these components into suitable pieces: these are the dashed areas seen in the pictures.

First, we exhibit the preprojective component (left) and the preinjective component (right):

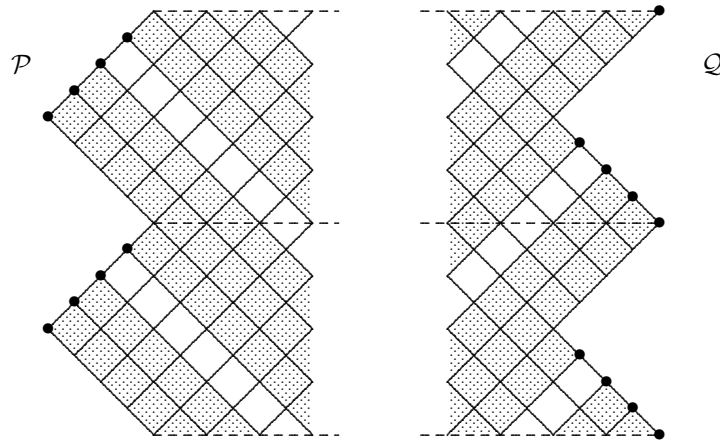

Next, the two regular components (the boundary of any of the two components

contains three simple modules; they are labeled):

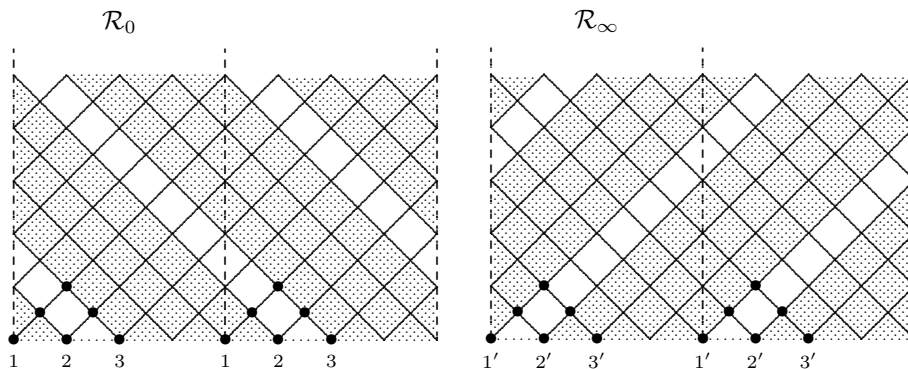

As we have mentioned, under the restriction functor $\eta : \text{mod } H \rightarrow \text{mod } W$, some serial H -modules become isomorphic, namely, the ten H -modules with support in in the subquiver with vertices $\{0, 1, 2, 3\}$ are identified with the corresponding ten H -modules with support in in the subquiver with vertices $\{1', 2', 3', 4\}$. In a first step, we make the identification of the nine pairs consisting of modules of length at most 3. We obtain the following partial translation quiver:

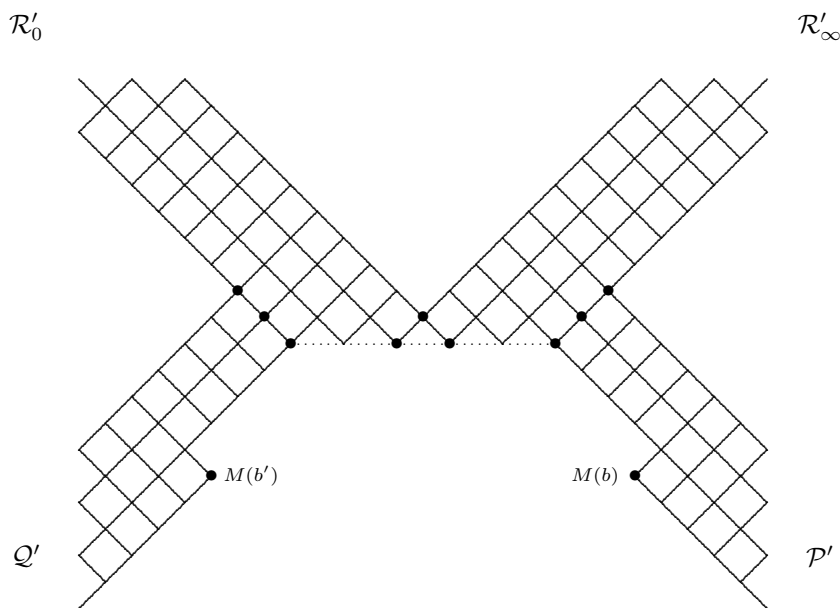

Here we denote by \mathcal{P}' the rays coming from \mathcal{P} , and so on. Note that we did not yet identify the points labeled $M(b)$ and $M(b')$, these are H -modules of length 4 which are identified under the restriction functor.

Now let us make this last identification, and insert the W -modules which are

not in the image of $\eta : \text{mod } H \rightarrow \text{mod } W$.

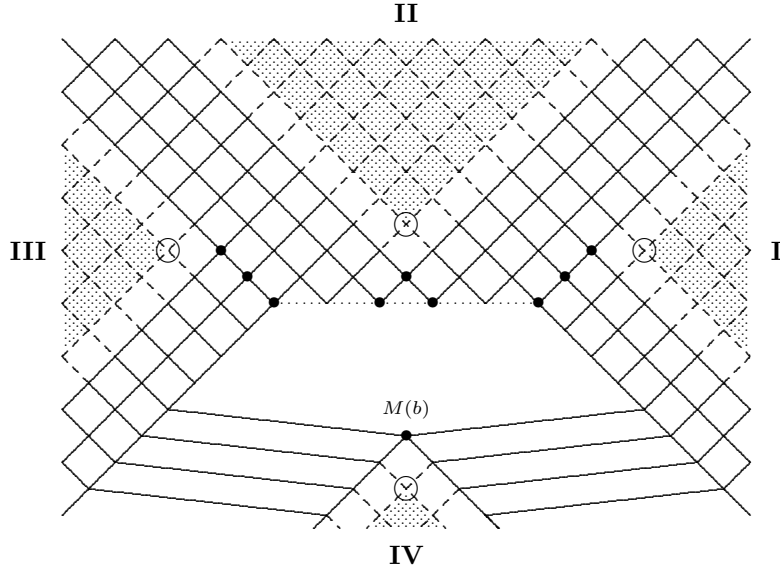

What are the additional modules? These are the string modules for words which contain a completed bar as a subword. These modules form quarters (as introduced in [19]), namely the four shaded areas in the picture above. The four quarters can be rearranged in order to be parts of a tile, similar to those exhibited in [19], p 54f, this will be explained in the next section. Of special interest seem to be the four encircled module, the corner modules for the quarters.

12.3. The corner modules. It may be worthwhile to identify explicitly the four corner modules (in the presentation of this component given above, we have encircled these modules):

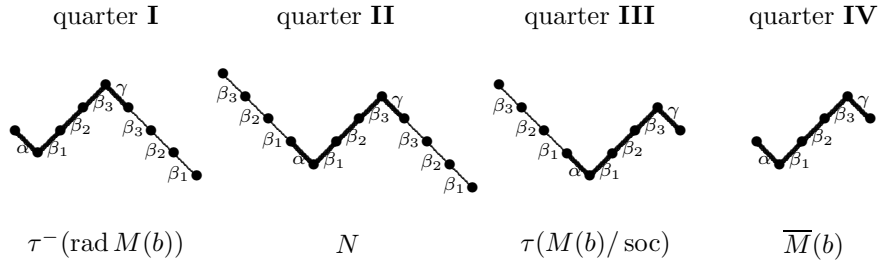

In our example both the socle and the top of all corner modules are of length 2. In general, the corner modules for the quarters I and IV may have a socle of length 3, and dually, the corner modules for the quarter III and IV may have a top of length 3, as the following description shows:

For the quarter I, the corner module $\tau^-(\text{rad } M(b))$ is obtained from $\text{rad } M(b)$ by adding hooks on the left and on the right.

Dually, for the quarter **III**, the corner module $\tau(M(b)/\text{soc})$ is obtained from $M(b)/\text{soc}$ by adding cohooks on the left and on the right.

For the quarter **IV** we obtain the corner module $\overline{M}(b)$ by adding to $M(b)$ a hook on the left, a cohook on the right. In our case we have $\overline{M}(b) = M(\overline{b})$, where \overline{b} is the completion of b .

The corner module for the quarter **II** has been denoted here by $N = N(b)$, in our example, we start with $\text{rad } M(b)/\text{soc}$ and add a cohook on the left and a hook on the right, in order to obtain N — however, this rule makes sense only in case $\text{rad } M(b)/\text{soc}$ is non-zero, thus in case the bar module $M(b)$ is of length at least 3. In general, let N_0 be the boundary module in \mathcal{R}_0 which has the same socle as $M(b)$ and N_∞ the boundary module in \mathcal{R}_∞ which has the same top as $M(b)$. Then N has a filtration $0 \subset N'' \subseteq N' \subset N$ with

$$N'' = \eta(N_0), \quad N'/N_0 = \text{rad } M(b)/\text{soc}, \quad N/N' = \eta(N_\infty).$$

In case $M(b)$ is of length 2, say $b = \beta$ where β is an arrow, then we deal with an exact sequence

$$0 \rightarrow \eta(N_0) \rightarrow N \rightarrow \eta(N_\infty) \rightarrow 0.$$

This is one of the Auslander-Reiten sequences involving string modules and having an indecomposable middle term, namely that corresponding to the arrow β , see [7].

This description of the corner modules shows that all of them are related to the following Auslander-Reiten sequence

$$0 \rightarrow \text{rad } M(b) \rightarrow M(b) \oplus \text{rad } M(b)/\text{soc} \rightarrow M(b)/\text{soc} \rightarrow 0$$

for W/I , where I is the annihilator of $M(b)$. Recall that we have used the Auslander-Reiten quiver of W/I as our gluing device, let us mark the Auslander-Reiten sequence in question:

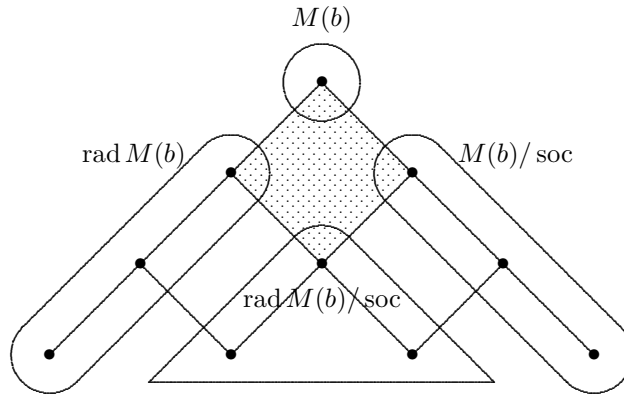

In case $M(b)$ is of length at least 3 we deal with a square, if it is of length 2, then with a triangle. In section 13.2 we will see in which way this square or triangle is enlarged in $\text{mod } W$.

12.4. Wind wheels with several bars. Now we consider the general case of t bars. Any of the components $\mathcal{P}, \mathcal{R}_0, \mathcal{R}_\infty, \mathcal{Q}$ will be cut into t pieces, and always the pieces will be indexed the the set \mathcal{B} of the direct bars.

Write $w = w_1 \cdots w_t$ where all the words w_i start with a direct letter and end with an inverse letter, and such that any w_i ends with an inverse bar, say $(b_i)^{-1}$. We denote by $\lambda : \mathcal{B} \rightarrow \mathcal{B}$ the cyclic permutation with $\lambda(b_i) = b_{i+1}$.

Similar to the case $t = 1$, we remove arrows from the preprojective component, but now we want to retain t connected pieces $\mathcal{P}(b)$ with $b \in \mathcal{B}$. The piece $\mathcal{P}(b)$ is supposed to contain the projective modules starting with $\text{rad } M(b)$ and ending with $M(\lambda b)$. Here is a picture of $\mathcal{P}(b)$:

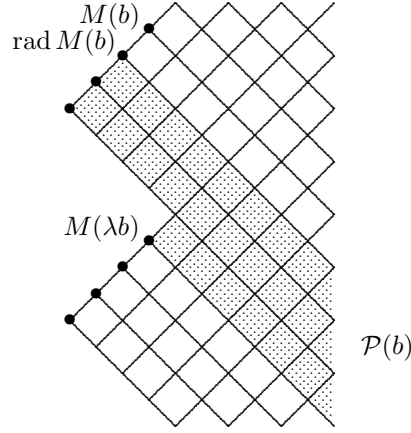

Next, consider the regular component \mathcal{R}_0 ; according to our convention, this is the component which contains the simple modules $T(b) = \text{top } M(b)$. Again, we remove arrows in order to obtain t pieces consisting of full corays; the piece $\mathcal{R}(b)$ with index b shall contain the modules $T(\lambda b), \tau^{-1}T(\lambda b), \tau^{-2}T(\lambda b), \dots$ up to $\tau T(b)$.

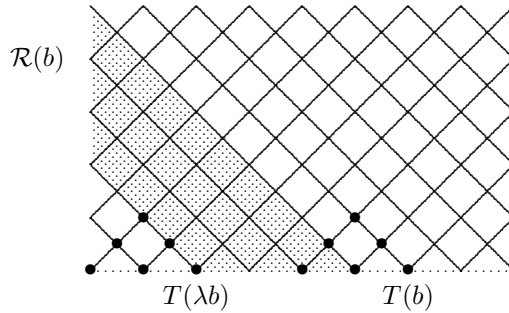

Similarly, we consider a word w' obtained from w by cyclic rotation, such that $w' = w'_1 \cdots w'_t$ where any w'_i starts with an inverse letter and ends with a direct letter, and ends in a (direct) bar, say the bar $b_{\sigma(i)}$ and we denote by $\rho : \mathcal{B} \rightarrow \mathcal{B}$ the permutation which sends $b_{\sigma(i)}$ to $b_{\sigma(i+1)}$.

Now we cut the preinjective component in order to get pieces made up of corays. the piece $\mathcal{Q}(b)$ has to contain $M(b)/\text{soc}$ up to $M(\rho b)$. Here is a picture of $\mathcal{Q}(b)$.

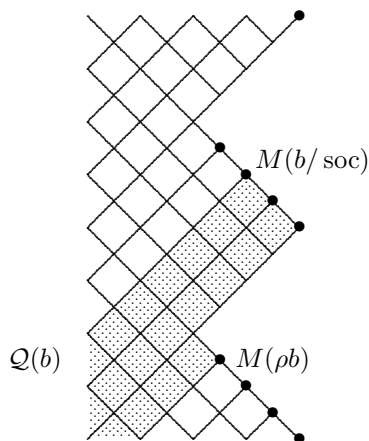

Finally, we consider the regular component which contains the simple modules $S(b) = \text{soc } M(b)$. Again, we remove arrows in order to obtain t pieces consisting now of full rays. The piece $\mathcal{R}_\infty(b)$ indexed by b contains the rays starting at $\tau^{-1}S(b), \tau^{-2}S(b), \dots$, up to $S(\rho b)$.

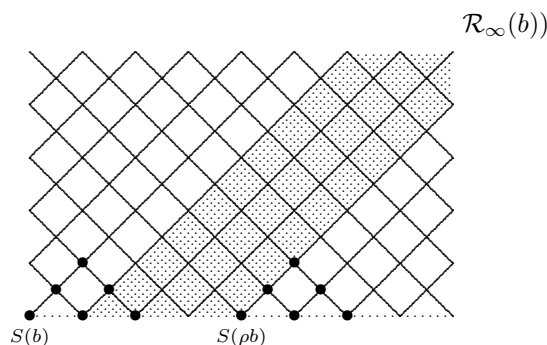

Altogether we have cut the four string components of $\text{mod } H$ into flat pieces: any such component yields t pieces. The gluing of these pieces is done by identifying H -modules which become isomorphic under the restriction functor

$$\text{mod } H \rightarrow \text{mod } W$$

(and finally we will have to add various quarters).

As in the case $t = 1$, we first will look at the proper subfactors of the bars. Identifying the corresponding H -modules, we obtain partial translation quivers which are planar: Any of the components $\mathcal{P}, \mathcal{Q}, \mathcal{R}_0, \mathcal{R}_\infty$ has been cut into t pieces, and the identification process will use one piece of each kind, in order to obtain t

planar partial translation quivers of the following form (**):

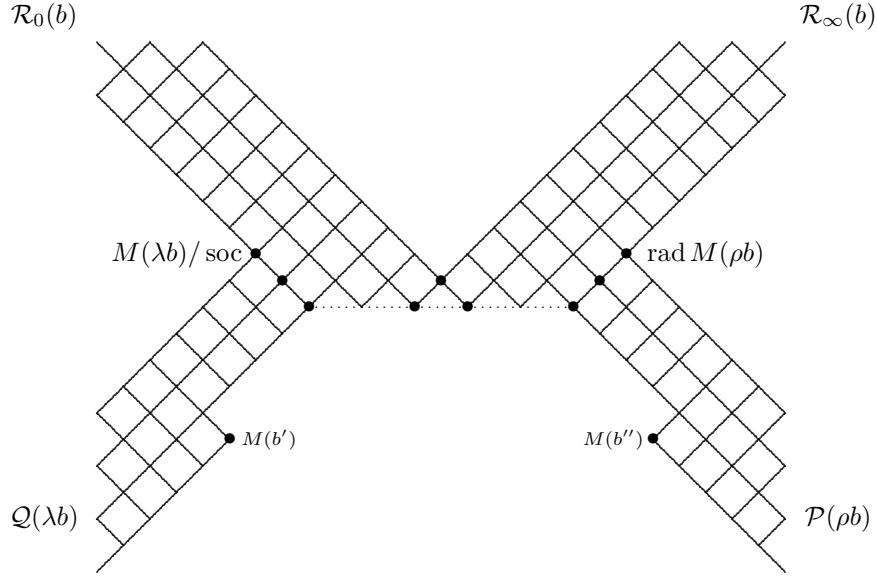

It is important to observe that in contrast to the case $t = 1$, the modules labeled $M(b')$ and $M(b'')$ (corresponding to bars b' and b'') now may be different!

We obtain in this way a permutation π of the bars such that $b'' = \pi(b')$. But we know that $b' = \rho\lambda(b)$ and $b'' = \lambda\rho(b)$. Now $b' = \rho\lambda(b)$ means that $b = \lambda^{-1}\rho^{-1}(b')$, thus

$$\pi(b') = b'' = \lambda\rho(b) = \lambda\rho\lambda^{-1}\rho^{-1}(b') = [\lambda, \rho](b').$$

This shows:

$$\pi = [\lambda, \rho].$$

Of course, as we have mentioned already, we still have to add the indecomposable W -modules which do not belong to the image of η . We know that there are precisely t non-periodic (but biperiodic) \mathbb{Z} -words; they give rise to $4 \cdot t$ quarters which have to be inserted as in the case $t = 1$. Before making the final identifications, let us attach the quarters of type **IV** to the pieces of the form $Q(b)$. In this way, we obtain t partial translation quivers of the form

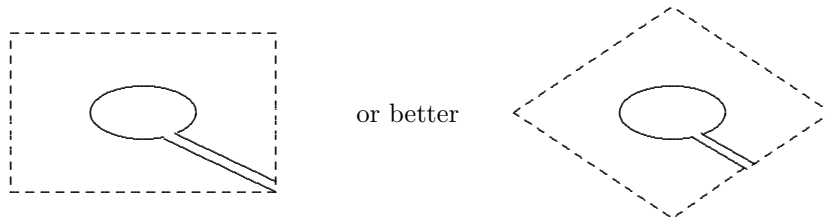

All the non-regular Auslander-Reiten components of this algebra look similar, here is one of these components:

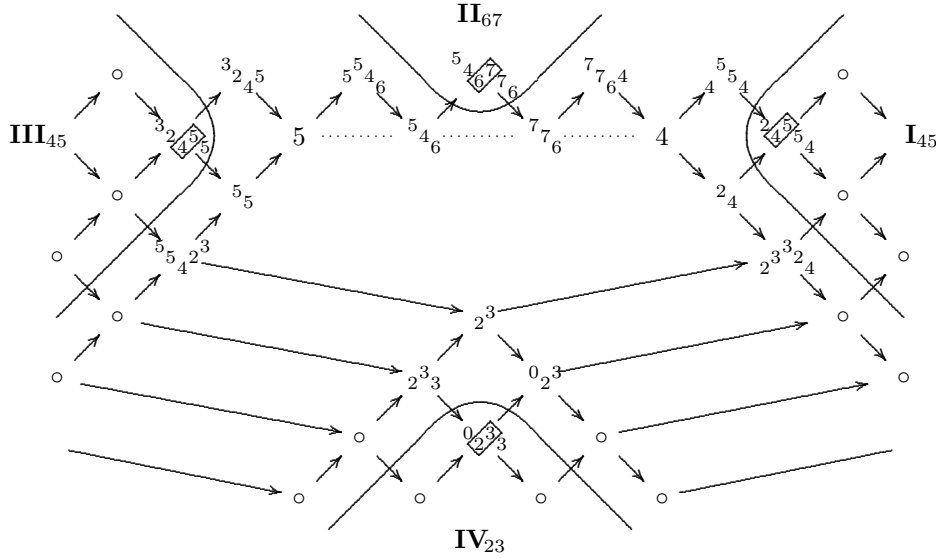

The inserted quarters are labeled **I**, **II**, **III**, **IV**, with a bar b as an index: all the modules in such a quarter are of the form $M(v)$, where v is a word which contains \bar{b} as a subword (such a quarter will later be seen as part of the tile $\mathcal{T}(b)$).

12.6. Wind wheels with non-regular Auslander-Reiten components with arbitrary ramification. First, let us present an example with a 3-ramified component. Here is the quiver with the zero relations of length 2 (in addition all paths of length 3 are zero relations):

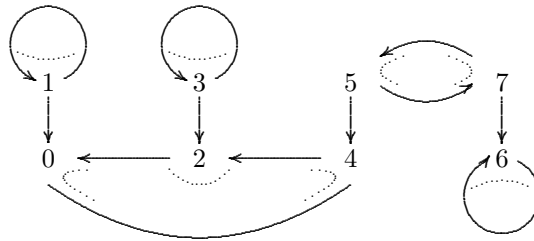

The primitive cyclic word is

$$\begin{array}{cccccccc}
 & 1 & & 3 & & 5 & & 7 \\
 0 & & 1 & 2 & 3 & 4 & 7 & 6 & 5 \\
 4 & & 0 & & 2 & & 6 & & 4
 \end{array}$$

Let us exhibit one part of the 3-ramified Auslander-Reiten component (as before, the inserted quarters are labeled **I**, **II**, **III**, **IV**, with a bar b as an index):

In addition there is a second non-regular Auslander-Reiten component, namely the component containing the module $I(4)$; it is 1-ramified. The boundary looks as follows:

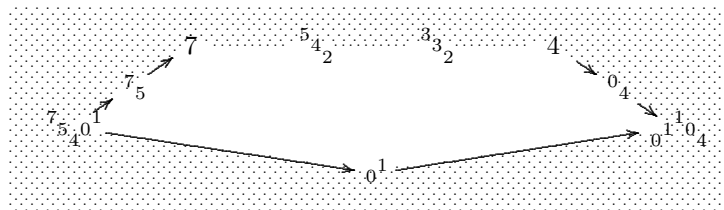

We use Galois coverings of this wind wheel in order to exhibit wind wheels with arbitrary ramification. Let us consider the Galois covering obtained by an s -covering of the cycle of length 2, thus we deal with a wind wheel of the following shape (for $s = 3$, we have to identify the upper left hand arrow with the upper right hand arrow in order to have an arrow $7' \rightarrow '5$):

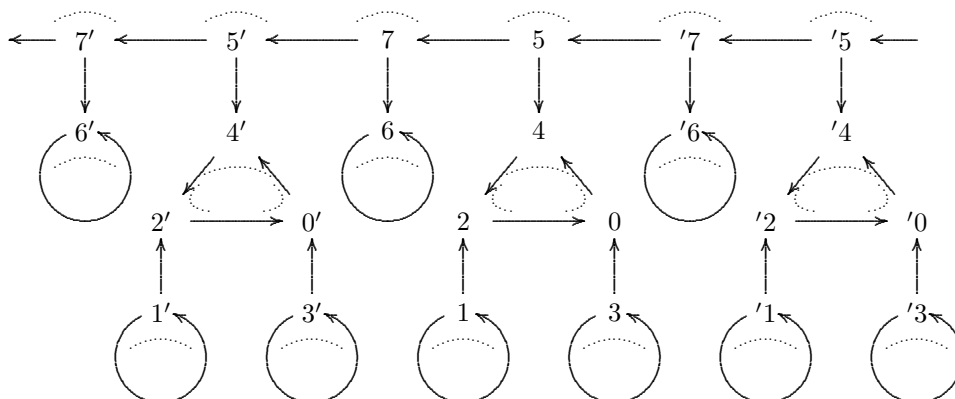

The corresponding primitive cyclic word is

$$\dots \begin{matrix} '5 & '7 & 1 & 3 & 5 & 7 & 1' & 3' & 5' \\ '4 & '7 & '6 & 5 & 0 & 1 & 2 & 3 & 4 & 7 & 6 & 5' & 0' & 1' & 2' & 3' & 4' & 7' & \dots \\ '2 & '6 & 4 & 0 & 2 & 3 & 4 & 7 & 6 & 5' & 0' & 1' & 2' & 3' & 4' & 7' & 6' \end{matrix}$$

Let us show the leaves which contain the modules $I(0), I(6), I(2)$, they are quite similar to those seen above — the only difference occurs on the right hand side of

the upper leaf and in the upper row of the middle leaf:

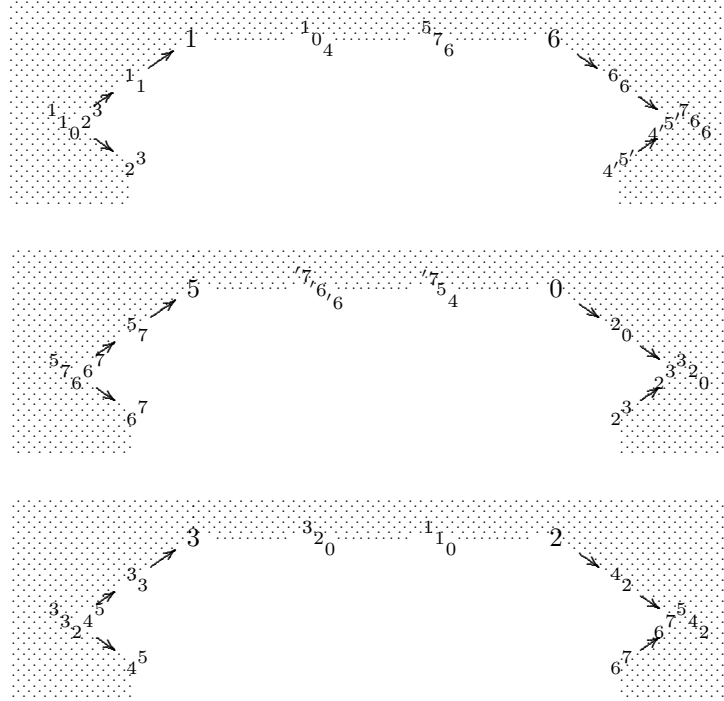

As before, the upper leaf and the middle leaf are sewn together (both contain the module $M(23)$), similarly, the middle leaf and the lower leaf are sewn together (both contain the module $M(67)$). But the change of the right hand side of the upper leaf is important, since it means that the upper leaf and the lower leaf no longer are sewn together (the lower leaf contains the module $M(45)$, the upper one the shifted module $M(4'5')$). It follows that for the s -fold covering $3s$ leaves are sewn together and form a $3s$ -ramified component (this is the Auslander-Reiten component which contains the modules $I(0), I(6), I(4)$ and their shifts under the Galois group).

What happens with the remaining non-regular component (the 1-ramified one)? Thus, let us start to calculate the Auslander-Reiten component which contains the module $P(1)$. Here is the relevant part of the boundary:

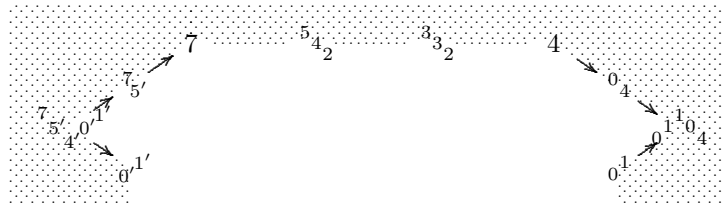

It follows that the Galois shifts of the module $P(1)$ all lie in one component,

and this is a component of type \mathbb{A}_∞^∞ which is s -ramified. This shows that any ramification does occur.

12.7. The ramification sequence of a wind wheel. We have seen above, that the sewing of the leaves is accomplished via the permutation $\pi = [\lambda, \rho]$.

Thus, we see: *All the non-regular components are 1-ramified if and only if the permutations λ and ρ commute* (in particular, this will be the case if these permutations coincide, as in example 12.5).

In general, we see that we do not get all the possible permutations for π . The mathematics behind it, is as follows: In the symmetric group Σ_t , we fix one t -cycle as ρ and form for any t -cycle λ the commutator $\pi = [\lambda, \rho]$: *these are the permutations which arise for the sewing procedure.*

Proposition. *A partition of t is the ramification sequence of a wind wheel if and only if it is the cycle partition for the commutator of two t -cycles.*

(By definition, the cycle partition of a permutation has as parts the lengths of the cycles when written as a product of disjoint cycles.)

For $t = 2$, the group Σ_t is commutative, thus we get as π only the identity. This means: For $t = 2$, we always get two non-regular components, both being 1-ramified.

For $t = 3$, the group Σ_t is no longer commutative, however the 3-cycles commute, thus again the only commutator $\pi = [\sigma, \rho]$ is the identity, thus again we see that we only get 1-ramified components.

The first case where one can obtain an r -ramified component with $r > 1$ is $t = 4$; an explicit example has been discussed in 12.6.

For $t = 4$ one checks easily that the possible ramification sequences are $(3, 1)$ and $(1, 1, 1, 1)$. For $t = 5$, they are (5) , $(3, 1, 1)$ and $(1, 1, 1, 1, 1)$ (for example, the commutator of the permutations (12345) and (12354) has the cycle partition $(3, 1, 1)$, that of (12345) and (12453) has the cycle partition (5)). In particular, we see that for $t \leq 5$, there are no 2-ramified components. For $t = 6$, the commutator of (123456) and (124653) has the cycle partition $(4, 2)$.

It seems that a description of the structure of the commutators $[\lambda, \rho]$, where λ and ρ are t -cycles in Σ_t is not known (but see the related investigations [12, 3]).

13. The Auslander-Reiten quilt of a wind wheel

Auslander-Reiten quilts have been considered until now only for suitable special biserial algebras Λ . A general definition can be given in case Λ is a 1-domestic special biserial algebra, see [19]: The vertices are (finite or infinite) words, and there are arrows, meshes, but also a convergence relation. The Auslander-Reiten quilt considers not only the indecomposable Λ -modules of finite length, but also related indecomposable Λ -modules of infinite length which are algebraically compact. The main objective is to sew together Auslander-Reiten components which contain string modules, using \mathbb{N} -words and \mathbb{Z} -words, the \mathbb{Z} -words yield "tiles".

13.1. Tiles and quarters. We recall from [19] some considerations concerning the Auslander-Reiten quilt of a special biserial algebra.

The poset Σ is the ordered sum of \mathbb{N} and $-\mathbb{N}$; inserting a limit point ω in the middle, we obtain the completion $\bar{\Sigma}$

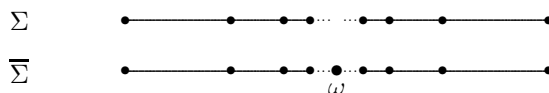

We may consider $\bar{\Sigma}$ as a topological space, namely as a closed interval; correspondingly, we will consider $\mathcal{T} = \bar{\Sigma} \times \bar{\Sigma}$ as a square or better as a lozenge. The center \blacksquare is the vertex (ω, ω) , the vertices on the diagonals (some are marked by \bullet) are the pairs (x, ω) and (ω, x) with $x \in \bar{\Sigma}$. In a rather obvious way, we can consider \mathcal{T} also as a translation quiver and as in [19] we will call it a *tile*, see the following picture on the left:

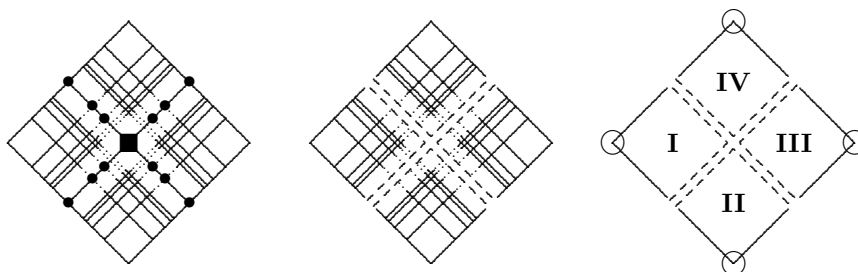

The middle picture presents the translation subquiver $\Sigma \times \Sigma$ obtained from the left picture by deleting the diagonals through the center. It may be considered as the disjoint union of four parts, the *quarters I, II, III, IV*, see the right picture. Here, we also have marked the four *corners* using circles.

Given any bar b , we obtain such a tile by considering all the (finite or infinite) words containing the completed bar \bar{b} , thus by considering all the (finite or infinite) subwords of $r(b)$. The word $r(b)$ itself will be the center of the tile, the infinite words form the diagonals through the center. If we look only at the finite words, we obtain in this way the four quarters.

As we have seen in [19], tiles can occur as hammocks (the bridges in [19] yield such a hammock). Here we encounter a different situation where tiles appear. The tiles which occur when dealing with minimal representation-finite special biserial algebras have the special property that all the irreducible maps in the quarter **I** are monomorphisms, whereas those in the quarter **III** are epimorphisms.

13.2. Return to the example 12.1. There is one bar b , thus one tile $\mathcal{T}(b)$. The finite-dimensional modules in the tile are those which do not lie in the image of the restriction functor $\eta : \text{mod } H \rightarrow \text{mod } W$, thus the string modules $M(v)$ where v is a finite word which contains the completed bar \bar{b} .

Any tile yields four quarters, and we have seen above that the corresponding corner modules are related to the following Auslander-Reiten sequence of W/I ,

where I is the annihilator of $M(b)$ (in case $M(b)$ is of length 2 we deal with a triangle, otherwise with a square):

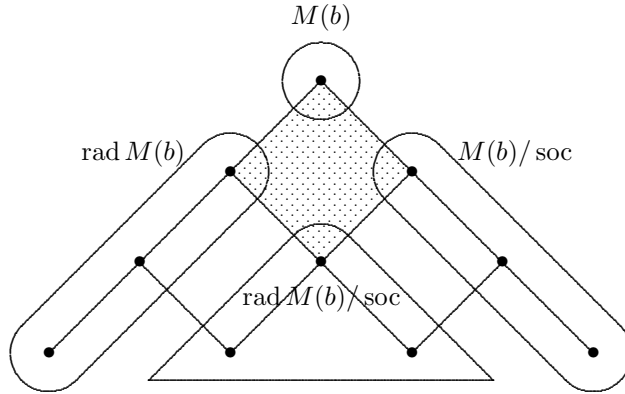

We are going to outline in which way this square or triangle is enlarged in mod W . It is the tile \mathcal{T} which may be considered as being inserted into this square — alternatively, we may say that we add a border to the tile:

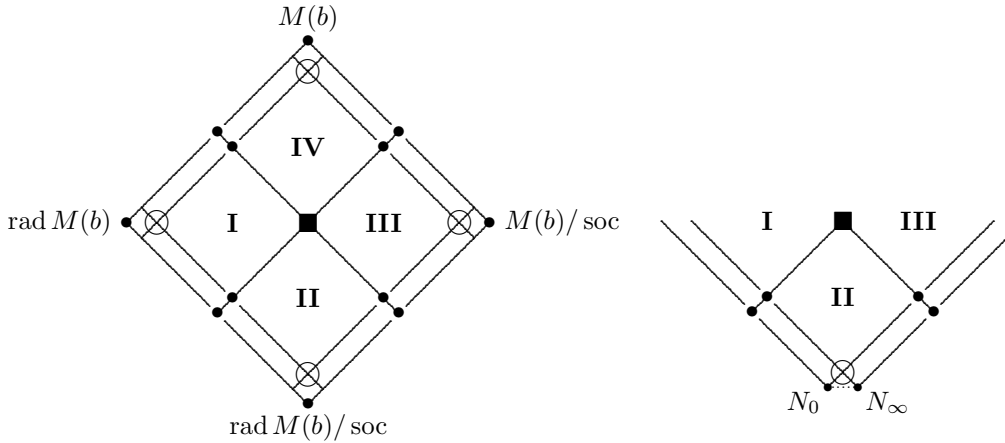

As we have noted above, dealing with the corner of the quarter **II** we have to distinguish whether $\text{rad } M(b)/\text{soc}$ is non-zero (as in the left picture) or zero (the right picture shows the changes); in the zero case we have marked the modules N_0 and N_∞ , where N_0 is the boundary module in \mathcal{R}_0 which has the same socle as $M(b)$, and N_∞ is the boundary module in \mathcal{R}_∞ which has the same top as $M(b)$.

13.3. One tile in detail. We have exhibited in 12.5 a wind wheel with 5 bars, thus there are 5 tiles. Let us present at least one of the tiles, say $\mathcal{T}(4\bar{5})$ in more detail:

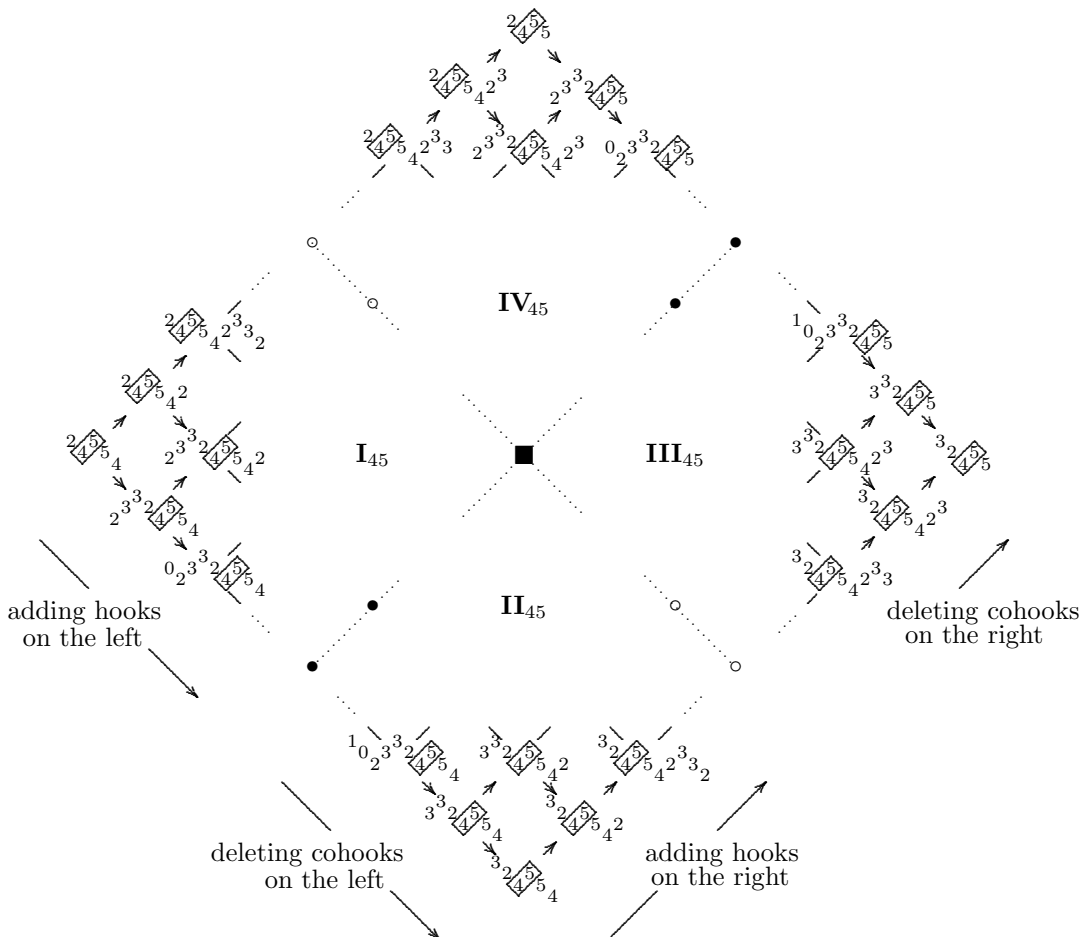

The vertices of such a tile $\mathcal{T}(b)$, with b a bar, are all the (finite or infinite) words which contain the completed bar \bar{b} as a subword. Thus, in our case we deal with the words which contain the word $\bar{4\bar{5}}$ as a subword. There is precisely one \mathbb{Z} -word of this form, namely $r(b)$, it lies in the center and is marked by the black square \blacksquare . There are many \mathbb{N} -words, they lie on the two diagonals through the center. Note that the \mathbb{Z} -word as well as all the \mathbb{N} -words are not periodic, since any word in $\mathcal{T}(b)$ contains \bar{b} only once as a subword. There are two kinds of \mathbb{N} -words: On the northwest-southeast diagonal they are marked by a circle \circ , these are the words of the form

$$x = v\bar{b}(w')^\infty$$

with v a finite word. The maximal periodic subword of x starts with the bar b ; one

easily checks that x is contracting in the sense of [18]. Those on the northeast-southwest diagonal are marked by a bullet \bullet , these are the words of the form

$$y = v\bar{b}^{-1}(w'')^{-\infty}$$

again with v a finite word. Here the maximal periodic subword starts with b^{-1} and y turns out to be expanding.

As we know, the corner modules for the quarters are related to the exact sequence

$$0 \rightarrow \text{rad } M(b) \rightarrow M(b) \oplus \text{rad } M(b)/\text{soc} \rightarrow M(b)/\text{soc} \rightarrow 0,$$

we obtain a border for $\mathcal{T}(b)$:

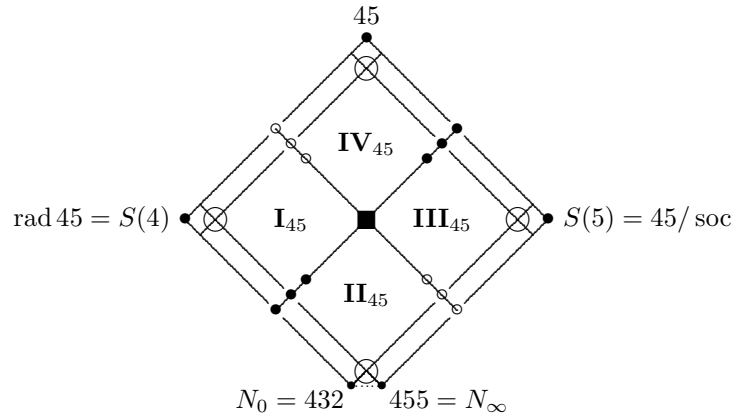

Here, N_0 is the boundary module in \mathcal{R}_0 which has the same socle as $M(45)$ and N_∞ is the boundary module in \mathcal{R}_∞ which has the same top as $M(45)$.

We can further enlarge the picture by adding rays from \mathcal{P} and \mathcal{R}_∞ , as well as corays from \mathcal{R}_0 and \mathcal{Q} . In the case $t = 1$, we obtain in this way the complete module category (of course, opposite edges have to be identified):

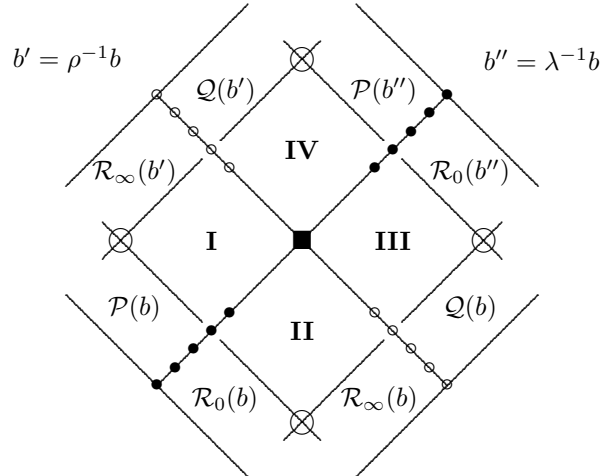

In particular, we get the following neighboring relation for tiles:

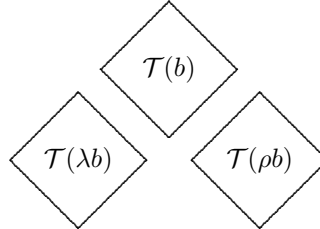

According to [18], for any almost periodic \mathbb{N} -word or biperiodic \mathbb{Z} -word x there exists an indecomposable algebraically compact module $C(x)$. In case x is a contracting \mathbb{N} -word, the module $C(x)$ is the usual string module for x , whereas for x an expanding \mathbb{N} -word, one needs to complete the string module in order to obtain the module $C(x)$. The \mathbb{Z} -words $r(b)$ are mixed words (the right hand side is contracting, the left hand side expanding), thus the module $C(r(b))$ is obtained from the corresponding string module by a partial completion: the left hand side has to be completed, the right hand side not.

Let us observe that for our enlargement by adding rays from \mathcal{P} , \mathcal{R}_∞ and corays from \mathcal{R}_∞ , \mathcal{Q} , we also have to invoke the adic modules for the component \mathcal{R}_0 and the Prüfer modules for the component \mathcal{R}_∞ .

13.4. Example of a quilt. In our example 12.5 with $t = 5$, five non-regular Auslander-Reiten components have been obtained. Using infinite words, thus infinite dimensional representations, we see that these Auslander-Reiten components have to be arranged as follows:

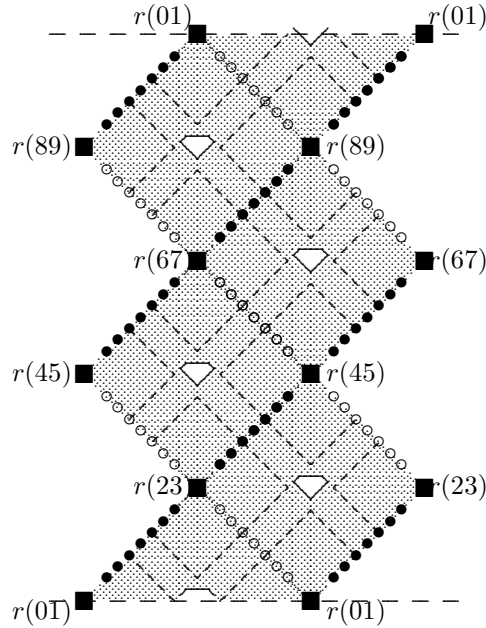

Here, the left boundary has to be identified with the right boundary, and the lower dashed line with the (slightly rotated) upper dashed line. The quilt which we obtain in this way is a torus with 5 holes.

Let us summarize: The picture above presents the quilt of our wind wheel, it exhibits on a surface (finite and infinite) words which give rise to relevant indecomposable algebraically compact modules. The black squares \blacksquare mark the non-periodic \mathbb{Z} -words, the circles \circ and the bullets \bullet mark the \mathbb{N} -words. If we delete the infinite words, we obtain the 5 Auslander-Reiten components which contain string modules, all being shown here as squares with a hole in the middle. On the other hand, for any bar b , we also spot easily the tile $\mathcal{T}(b)$, it is a square with center $r(b)$.

13.5. The indecomposable algebraically compact modules. Let us stress that almost all, but **not all** indecomposable algebraically compact modules are used in the construction of the Auslander-Reiten quilt of a wind wheel. Here is the list of the additional modules:

- (1) The generic module,
- (2) the Prüfer modules for the tube \mathcal{R}_0 , and
- (3) the adic modules for the tube \mathcal{R}_∞ .

13.6. The Euler characteristic. There is the following general observation:

Proposition. *Let Λ be a wind wheel with t bars. The Auslander-Reiten quilt Γ of Λ is a connected surface with boundary, its Euler characteristic is $\chi(\Gamma) = -t$.*

This result can be interpreted as follows: Let h be the number of non-regular Auslander-Reiten components of Λ , thus h is the number of components of the boundary of Γ and we have $h \leq t$. There is a (connected) compact Riemann surface Γ' without boundary and with Euler characteristic $\chi(\Gamma') = -t + h$ such that Γ is obtained from Γ' by inserting h holes. For $h = t$ (as in the examples 12.8), the surface Γ' has Euler characteristic 0, thus it is a torus.

Proof. Our cut-and-paste procedure presents Γ as being obtained from $4t$ pieces of the following form

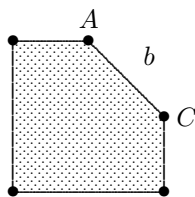

where the edge b will be part of the boundary, whereas the remaining edges have to be identified in pairs. Looking at the vertices, we have to distinguish the endpoints A and C of the boundary edge b and the remaining ones: the endpoints of the boundary edges are identified pairwise, whereas always four of the remaining ones yield a vertex of Γ . Let v, e, f be the number of vertices, edges and faces respectively. There are $f = 4t$ faces, there are $e = 4t + 4t \cdot 4/2$ edges and $v = 4t \cdot 2/2 + 4t \cdot 3/4$ vertices, thus $f - e + v = -t$. \square

13.7. Orientability.

Proposition. *The Auslander-Reiten quilt Γ of any wind wheel is connected and orientable.*

Proof. Compact surfaces are often presented by a polygon with an even number of edges and an identification rule for pairs of the edges, this rule is shown by a word using the edges (and their inverses) as letters, this takes into account the orientation in which the edges are identified.

Let $\overline{\Gamma}$ be obtained from Γ by filling the holes. Clearly, we obtain $\overline{\Gamma}$ by taking t squares (corresponding to the tiles) and identifying pairs of edges. The neighboring relation for the tiles shows in which way we have to identify the edges.

First, we use the permutation λ in order to obtain the following rectangle:

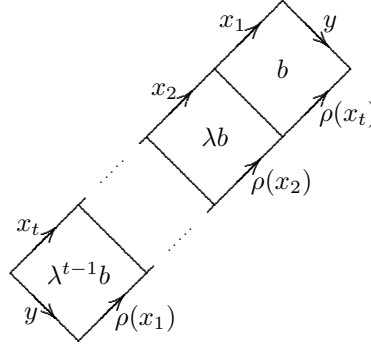

This already shows the connectedness. But we also see that the further identifications are achieved by the word

$$y\rho(x_t)\cdots\rho(x_2)\rho(x_1)y^{-1}x_1^{-1}x_2^{-2}\cdots x_t^{-t}.$$

It is well-known (and easy to see) that we can change the word to a product of commutators, but this means that $\bar{\Gamma}$ is orientable.

□

13.8. Warning concerning the orientability. As we have seen, the Auslander-Reiten quilt of any wind wheel is orientable. For example, in section 13.4, we have exhibited a the quilt of a wind wheel W which is a torus with holes.

But the category $\text{mod } W$ contains as a full subcategory the module category $\text{mod } L$ of the following algebra L , and the Auslander-Reiten quiver of L is obviously (homeomorphic to) a Möbius strip:

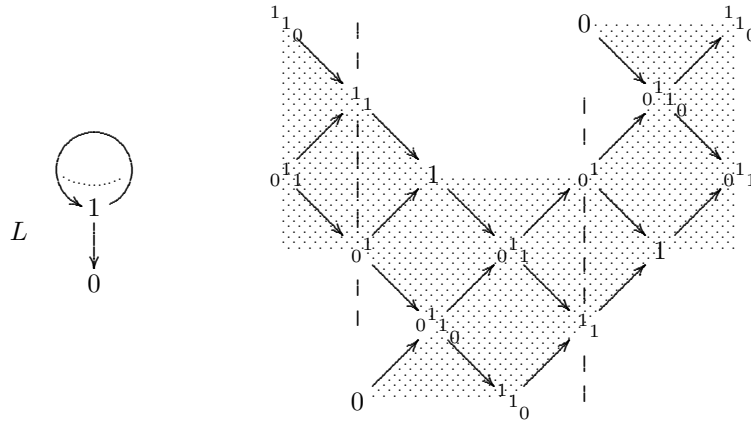

Here, the vertical dashes lines mark a fundamental domain.

Instead of looking at the wind wheel considered in section 12.5, let W now be the smallest possible wind wheel, with two vertices $0, 1$, a loop α at the vertex 0 , a loop γ at the vertex 1 and an arrow $\beta : 1 \rightarrow 0$ (and the relations $\alpha^2 = \gamma^2 = \alpha\beta\gamma = 0$). We want to analyze the embedding of $\text{mod } L$ into $\text{mod } W$.

Some parts of the Auslander-Reiten quiver of L can be identified in the quilt of W without problems:

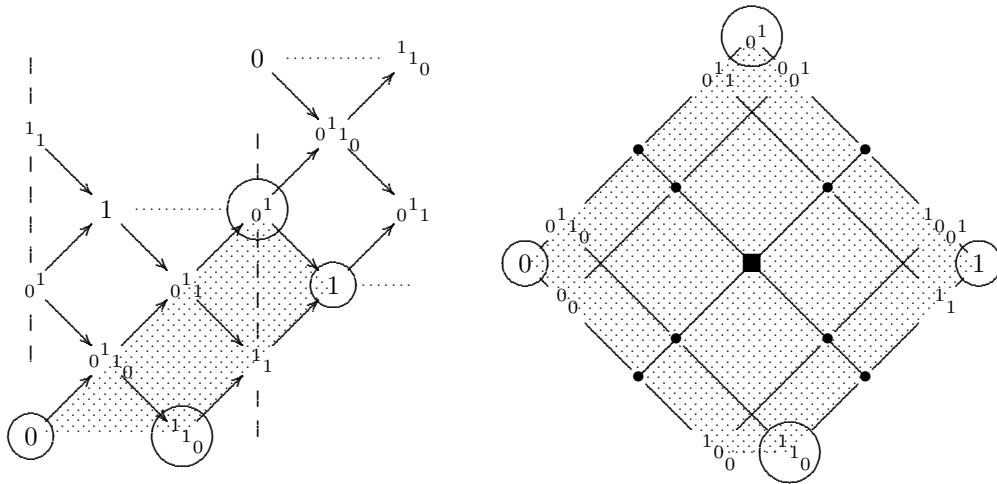

All the maps in the shaded part of $\text{mod } L$ (see the left picture) are nicely factorized in $\text{mod } W$, see the right picture, note that on the right we see the bordered tile for W .

Of course, this concerns also the following shaded part on the left (actually, we deal with the same part of $\text{mod } L$):

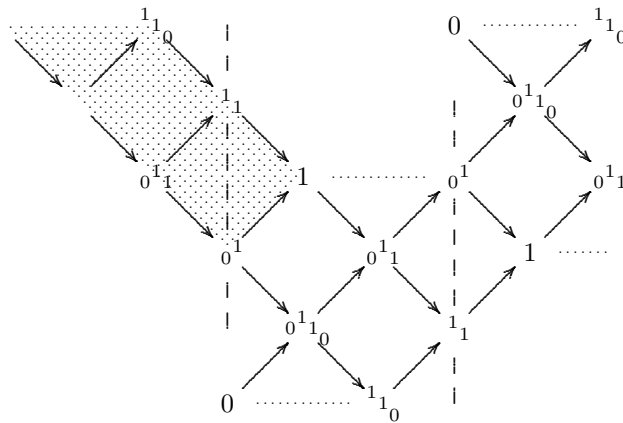

It is the following square in $\text{mod } L$ which is difficult to recover in the Auslander-

Reiten quilt of W :

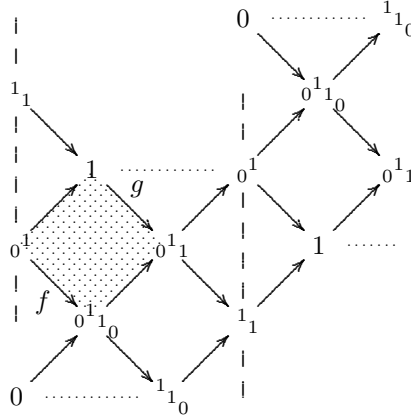

To be more precise: we should distinguish between the maps pointing upwards and those pointing downwards, the maps pointing upwards have already been discussed since they are part of the bordered tile, thus let us concentrate on the maps pointing downwards, they are labeled f and g in the picture. We want to see in which way these maps can be factorized in the category $\text{mod } W$.

First, consider the map $f : 0^1 \rightarrow 0^1 1_0 = 0^1 1^0$. We can factor it as follows (always additions or deletions on the right):

$$0^1 \xrightarrow{f_1} {}_0 1^1_0 \xrightarrow{f_2} {}_0 1^1_0 1 \xrightarrow{f_3} {}_0 1^1_0 1^1_0 \xrightarrow{f_4} \dots \quad \dots \xrightarrow{3f} {}_0 1^1_0 1^1_0 \xrightarrow{2f} {}_0 1^1_0 1^1 \xrightarrow{1f} {}_0 1^1_0$$

Similarly, we look at the map $g : 1 \rightarrow 0^1 1_1 = 1^1_0$ and factor it (again always additions or deletions on the right):

$$1 \xrightarrow{g_1} 1^1_0 \xrightarrow{g_2} 1^1_0 1 \xrightarrow{g_3} 1^1_0 1^1_0 \xrightarrow{g_4} \dots \quad \dots \xrightarrow{3g} 1^1_0 1^1_0 \xrightarrow{2g} 1^1_0 1^1 \xrightarrow{1g} 1^1_0$$

Now if i is odd, then the maps f_i and g_i both are obtained by the addition of a hook, thus they are irreducible, and both ${}_i f$ and ${}_i g$ are obtained by the deletion of a cohook, thus they also are irreducible. But for i even, all the maps $f_i, {}_i f, g_i, {}_i g$ belong to the infinite radical rad^ω (and actually not to $(\text{rad}^\omega)^2$). By definition (see for example [23]), the infinite radical rad^ω is the intersection of the powers rad^d with $d \in \mathbb{N}$. It follows that the maps f, g belong to all powers of the infinite radical, thus to rad^{ω^2} .

The sequences of maps displayed here show that f factors through the adic module given by the (expanding) word $(\beta\gamma\beta^{-1}\alpha^{-1})^\infty$, whereas g factors through the Prüfer module given by the (contracting) word $\gamma\beta^{-1}\alpha^{-1}(\beta)^\infty$. Note that both these modules are indecomposable algebraically compact modules which are not used in the quilt.

Let us try to following the factorization in the quilt. First, we consider again f . Looking at the maps f_i we have noted already that those with odd index are irreducible, they belong to \mathcal{P}' , whereas those with even index factor through an upwards path in the tile \mathcal{T} . Similarly, the maps ${}_i f$ with odd index are irreducible

maps inside \mathcal{R}'_0 , whereas those with even index factor through a downwards path in the tile \mathcal{T} :

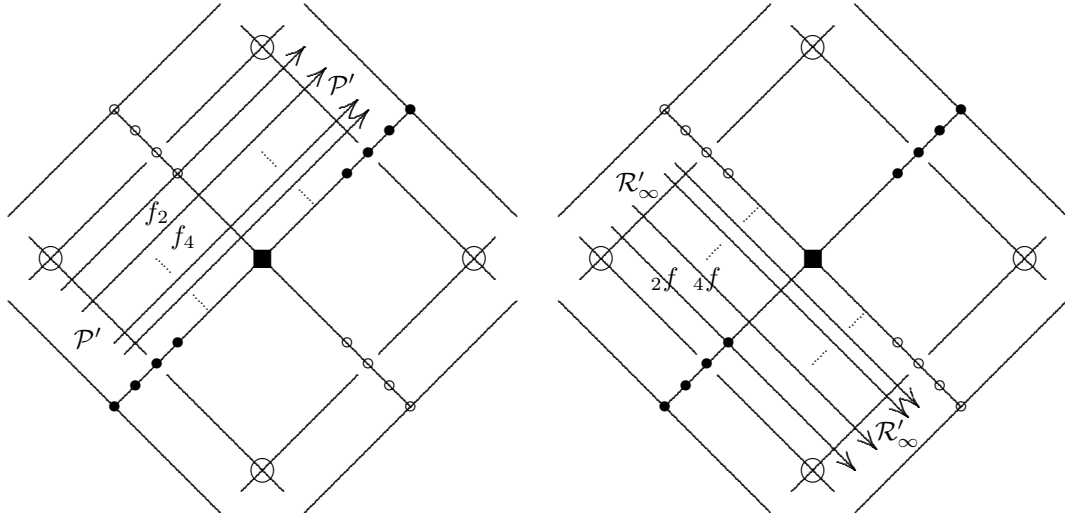

What is of importance is the change of the direction which we encounter: as long as we deal with the maps f_i we work with maps pointing upwards, but after we have passed the adic module (which is hidden) we deal with the maps ${}_i f$ and they point downwards.

There is the similar feature for the map g :

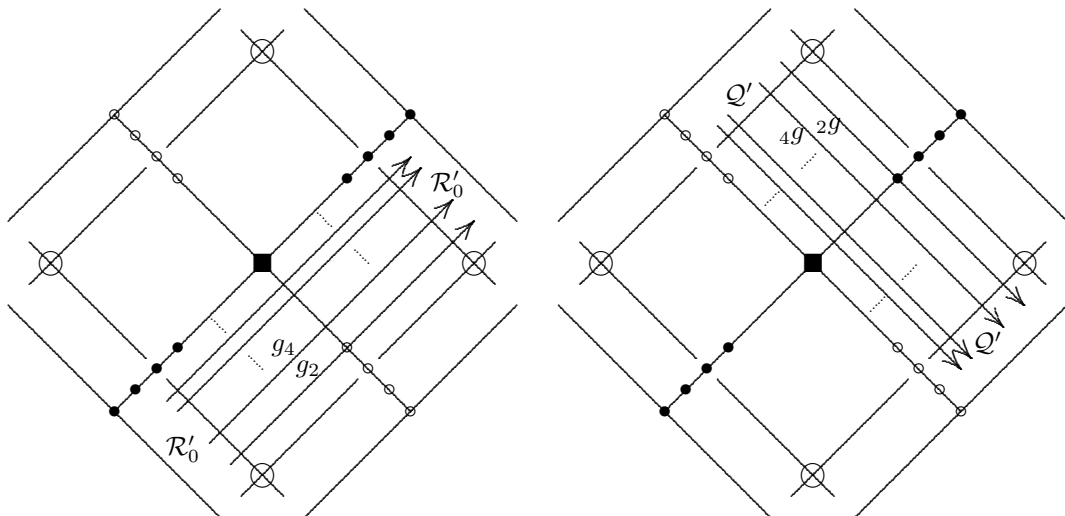

Here we deal first with the maps g_i pointing upwards, and after we have passed the hidden Prüfer module we deal with the maps ${}_i g$ and they point again downwards.

Altogether we may say that the maps f and g are embedded into the quilt of W with a kind of crossing, so that the shaded parts are connected by a square

which is folded over:

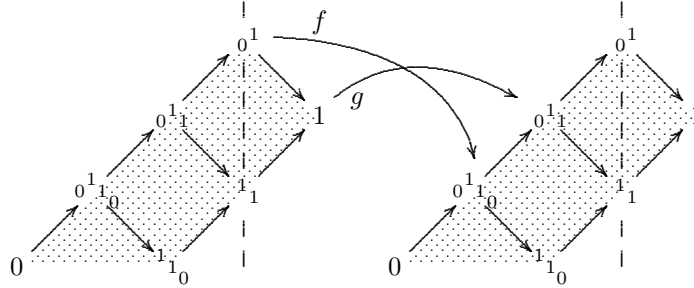

14. The Auslander-Reiten quiver of a barbell.

Proposition 14.1. *Barbell algebras are of non-polynomial growth.*

Proof. Given an arrow α , we denote by $\mathcal{N}(\alpha)$ the set of cyclic words starting with α and ending in an inverse letter (for all the words in $\mathcal{N}(\alpha)$, the last letter is a fixed one, namely the inverse of the only arrow different from α which has the same end point as α). Clearly, $\mathcal{N}(\alpha)$ is a semigroup. Note that the given algebra is non-domestic (and then even of non-polynomial growth) if and only if there exists an arrow α such that $\mathcal{N}(\alpha)$ is non-empty and not cyclic ([R1], Proposition 2 and its proof).

Here we take $\alpha = \alpha_1$. We assume that the length of $\epsilon, \eta, \epsilon'$ is r, s, t , respectively. Let $u = \alpha_1^{\epsilon(1)} \dots \alpha_r^{\epsilon(r)}$, $v = \alpha_{r+1}^{\epsilon(r+1)} \dots \alpha_{r+s}^{\epsilon(r+s)}$ and $w = \alpha_{r+s+1}^{\epsilon(r+s+1)} \dots \alpha_{r+s+t}^{\epsilon(r+s+t)}$. Then both $uvwv^{-1}$ and $uvw-1v^{-1}$ are elements of $\mathcal{N}(\alpha)$. This shows that $B(\epsilon, \eta, \epsilon')$ is of non-polynomial growth. \square

We consider the algebra given in Example 2. The non-regular component looks as follows:

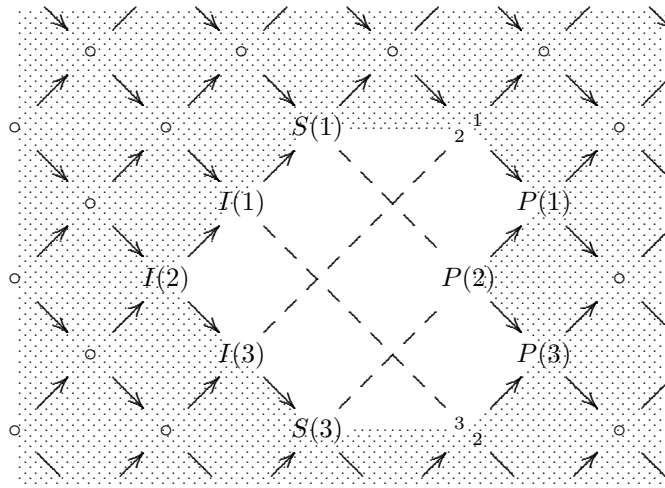

The component contains 10 of the 12 string modules which are boundary modules; the remaining two string modules which are boundary modules are the serial string modules of length 3 (with composition factors going up 2, 1, 1 and 2, 3, 3, respectively). They form the boundary of a stable tube of rank 2; the boundary meshes are those provided by the arrows $1 \rightarrow 2$ and $3 \rightarrow 2$ respectively:

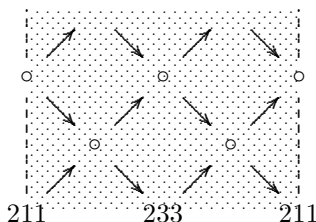

Let us have another look at the non-regular component. The picture shows nicely a phenomenon which has attracted a lot of attention lately, in some other context, namely when dealing with cluster tilted algebras. Let us recall the relevant facts: Given a cluster tilted algebra Λ , the category $\text{mod } \Lambda$ is obtained from the corresponding cluster category by factoring out a cluster tilting object [6]. Looking at a vertex a of the quiver of Λ , the corresponding indecomposable projective Λ -module $P(a)$ and the corresponding indecomposable injective Λ -module $I(a)$ satisfy

$$\tau^2 P(a) = I(a),$$

where τ is the Auslander-Reiten translation in the cluster category (if we denote by τ_Λ the Auslander-Reiten translation in the category $\text{mod } \Lambda$, then $\tau_\Lambda M = \tau M$ for any indecomposable non-projective Λ -module, whereas, of course, $\tau_\Lambda M = 0$ for M indecomposable projective).

As we see in the picture, the non-regular component is a translation quiver which can be considered as part of a regular translation quiver Ξ obtained by adding a new vertex p' for every projective vertex p , such that the translate of p is p' and the translate of p' is an injective vertex. Let us define a function f on the set of vertices of Ξ as follows: if x is an old vertex, let $f(x)$ be the length of the corresponding module, if $x = p'$ is a new vertex, let $f(x) = -1$. Then f satisfies the following property:

$$f(z) + f(\tau z) = \sum f(y), \quad \text{where we sum over all arrows } y \rightarrow z \text{ with } f(y) > 0,$$

for all vertices z of Ξ (one may say that such a function with values in \mathbb{Z} is "cluster-additive", see [22]).

Other similarities with cluster tilted algebras (see [14]) should be mentioned:

Proposition 14.2. *The barbell algebras are Gorenstein algebras of Gorenstein dimension 1 and the stable category of Cohen-Macaulay modules is Calabi-Yau of CY-dimension 3.*

For our example 2, here are the minimal injective resolutions of the indecomposable projective modules:

$$\begin{aligned} 0 \longrightarrow P(1) \longrightarrow I(2) \oplus I(2) \longrightarrow I(1) \oplus I(3) \oplus I(3) \longrightarrow 0 \\ 0 \longrightarrow P(2) \longrightarrow I(2) \longrightarrow I(1) \oplus I(3) \longrightarrow 0 \\ 0 \longrightarrow P(3) \longrightarrow I(2) \oplus I(2) \longrightarrow I(1) \oplus I(1) \oplus I(3) \longrightarrow 0 \end{aligned}$$

Let \mathcal{L} be the full subcategory of all torsionless modules (by definition, a module is torsionless if it can be embedded into a projective module) and \mathcal{P} the full subcategory of all projective modules. We have to calculate the factor category $\underline{\mathcal{L}} = \mathcal{L}/\mathcal{P}$. Since we deal with a 1-Gorenstein algebra, $\underline{\mathcal{L}}$ is a triangulated category with Auslander-Reiten translation.

It is not difficult to check that the only indecomposable modules which are torsionless and not projective are the two serial modules of length 2 with socle $P(2)$, we denote them by $L(1) = \begin{smallmatrix} \frac{1}{2} \end{smallmatrix}$ and $L(3) = \begin{smallmatrix} \frac{3}{2} \end{smallmatrix}$. Thus, \mathcal{L} has the following Auslander-Reiten quiver:

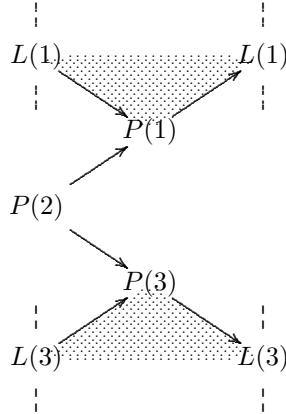

The dashed line indicate that we have to identify vertices of the triangles exhibited: Note that both serial modules $L(1)$ and $L(3)$ are shown twice, these are the vertices which have to be identified.

It follows that the (triangulated) category $\underline{\mathcal{L}}$ has just two indecomposable objects, both being fixed under the suspension functor as well as under the Auslander-Reiten translation functor (so that $\underline{\mathcal{L}}$ is the product of two copies of the stable module category of the algebra $k[\epsilon] = k[T]/\langle T^2 \rangle$ of dual numbers), the Auslander-Reiten quiver of $\underline{\mathcal{L}}$ looks as follows:



Thus, we deal with a triangulated category for which both the suspension functor as well as the Auslander-Reiten translation functor are the identity functor. This means that $\underline{\mathcal{L}}$ is 3-Calabi-Yau, and indeed n -Calabi-Yau for any n .

Since the module category of a barbell algebra shares so many properties with the module category of a cluster tilted algebra, one may wonder whether also for

a barbell algebra Λ the module category $\text{mod } \Lambda$ is obtained from a triangulated category \mathcal{C} by forming $\mathcal{C}/\langle T \rangle$ for some object T in \mathcal{C} . As Idun Reiten has pointed out, this is indeed the case if we deal with a barbell algebra Λ with two loops (as in our running example 2) provided we assume that the characteristic of k is different from 3: such an algebra is 2-CY-tilted (this means: the endomorphism ring of some cluster tilting object of a 2-Calabi-Yau category, [16]). Namely, if Λ is a barbell algebra with two loops α, δ in its quiver Q and if the characteristic of k is different from 3, then Λ is the Jacobian algebra $J(Q, W) = kQ/\langle 3\alpha^2, 3\delta^2 \rangle$, where W is the potential $W = \alpha^3 + \delta^3$, see [9], thus one can apply theorem 3.6 of Amiot [1].

15. Sectional paths

Recall that a (finite or infinite) path $(\cdots \rightarrow X_i \rightarrow X_{i+1} \rightarrow \cdots)$ in the Auslander-Reiten quiver of a finite dimensional algebra is called *sectional* provided τX_{i+1} is not isomorphic to X_{i-1} for all possible i . Such a path will be called *maximal* provided it is not a proper subpath of some sectional path. An infinite sectional path involving only monomorphisms will be called a *mono ray*, an infinite path involving only epimorphisms will be called an *epi coray*; of course, mono rays start with some module, epi corays end in a module.

Note that for Auslander-Reiten components of the form $\mathbb{Z}\mathbb{A}_\infty$ as well as for stable tubes, all maximal sectional paths are mono rays and epi corays.

Theorem 15.1. *Let Λ be a k -algebra which is minimal representation-infinite and special biserial. Then any maximal sectional path is a mono ray, an epi coray or the concatenation of an epi coray with a mono ray.*

Corollary. *Assume that Λ is minimal representation-infinite and special biserial. Let X, Y, Z be indecomposable Λ -modules with an irreducible monomorphism $X \rightarrow Y$ and an irreducible epimorphism $Y \rightarrow Z$. Then $X = \tau Z$.*

Proof. We may assume that there are no nodes: Namely, if all the sectional paths of $\text{nn}(\Lambda)$ are as mentioned, the same has to be true for Λ : the only maximal sectional paths for Λ to be looked at are those passing through the node. Resolving the node we will obtain sectional paths which are not double infinite paths, thus by the assumption on $\text{nn}(\Lambda)$, we will deal with an epi coray ending in the node and a mono ray starting in the node, thus with a concatenation as listed.

If Λ is hereditary of type $\tilde{\mathbb{A}}_n$, thus a cycle algebra, then any maximal sectional path is a mono ray, an epi coray. We only have to look at the preprojective component and the preinjective component. But if $f : X \rightarrow Y$ is a non-zero map between indecomposable preprojective modules, then f has to be always a monomorphism: otherwise, the kernel of f would have negative defect, and since the defect of X is -1 , it would follow that the image of f is a non-zero submodule of Y with non-negative defect, a contradiction. The dual argument shows that the maximal sectional paths in the preinjective component are epi corays.

Next, let us look at the wind wheels: again, only the non-regular components have to be considered. But we know how to construct these components: we use mono rays from the preprojective component and the tube \mathcal{R}_∞ as well as epi corays from the tube \mathcal{R}_0 and from the preinjective component, and in addition rays and corays in the tiles. But all the maximal sectional paths in the four quarters of a tile are mono rays and epi corays (in the quarter **I** we have only mono rays, in **III** only epi corays, whereas **II** and **IV** have both mono rays and epi corays).

Finally, let us look at the barbells. There is only one non-regular component which has to be treated separately. The band modules lie in homogeneous tubes and there will be an additional regular tube containing string modules. What really is of interest are the remaining components \mathcal{C} , they are of the form $\mathbb{Z}\mathbb{A}_\infty^\infty$. Let us look at the example 2 (the general case is similar). Let $M = M(v)$ be the Geiß module ([10]) for \mathcal{C} (it is the unique module in \mathcal{C} of minimal length) and one easily observes that v is a word of the form $1 \rightarrow 2 \cdots 2 \leftarrow 3$. It is easy to see that all the modules $\tau^{-t-1}M$ for $t \geq 0$ are obtained from $\tau^{-t}M$ by adding hooks both on the left and on the right; similarly, all the modules $\tau^{t+1}M$ for $t \geq 0$ are obtained from $\tau^t M$ by adding cohooks both on the left and on the right. But this implies that all the maximal sectional paths in \mathcal{C} are concatenation of an epi coray with a mono ray. \square

It may be helpful to call an indecomposable Λ -module a *valley* module if it is the concatenation vertex for a sectional path which is the concatenation of an epi coray with a mono ray, and to exhibit corresponding pictures: always we encircle the "valleys". First, we present a non-regular component of a wind wheel:

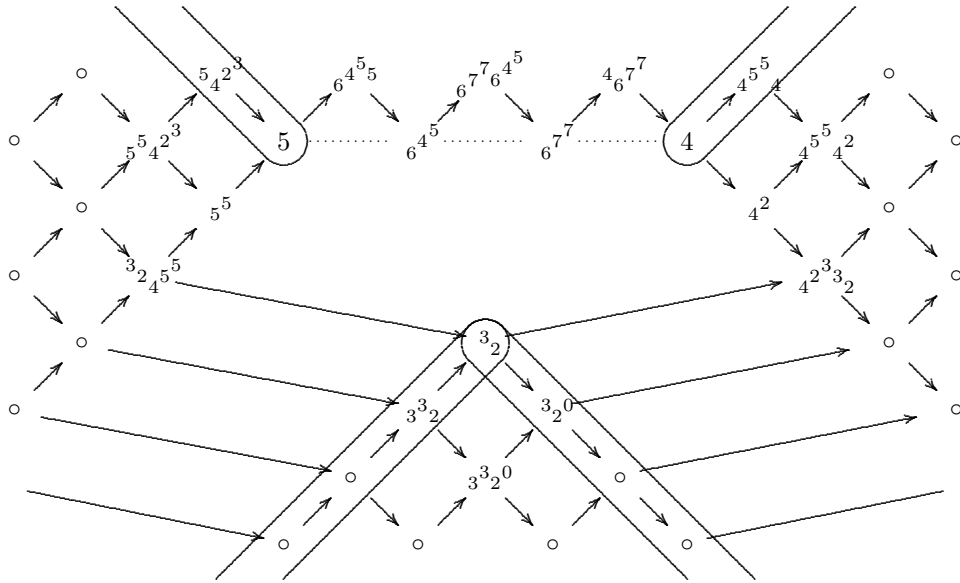

The valleys may be considered as the natural places where to cut such a component into pieces. Of course, in our cut-and-paste process, we followed this rule.

The second example is the non-regular component of the barbell given as example 2:

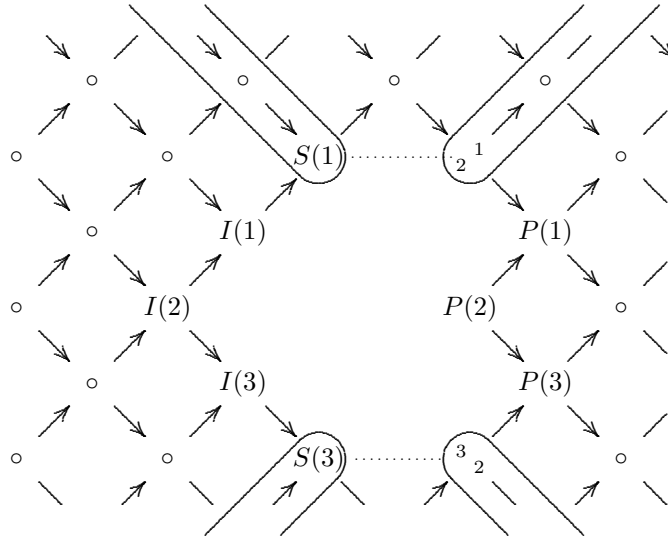

Of course, when dealing with a barbell and look at a regular component \mathcal{C} of string modules, say with Geiß-module M , then the valley modules are precisely those which lie on the sectional paths which contain M .

In all these components, the "valleys" provide a clear division into regions with common growth pattern. For example, in the regions on the left, all irreducible maps are epimorphisms, whereas in the regions on the right, all are monomorphisms.

Part III. Appendix

The appendix collects some remarks related to the investigations presented above. First, we show an example of an algebra which may be considered as a twisted version of a barbell.

16. Further minimal representation-infinite algebras

Consider the following algebra:

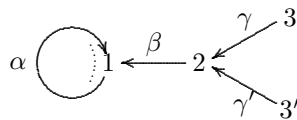

(or, more generally, the corresponding algebras where α and β are replaced by longer paths). Note that the universal covering are the "dancing girls" of Brenner-Butler.

18. Accessible representations

We have mentioned in the introduction that the recent paper [5] of Bongartz has drawn the attention to the minimal representation-infinite algebras which have a good cover $\tilde{\Lambda}$, such that all finite convex subcategories of $\tilde{\Lambda}$ are representation-finite. As we show above, these algebras are special biserial and can be completely classified. The title of the Bongartz paper [5] indicates that his main concern was to prove the following theorem: *Let Λ be a finite dimensional k -algebra where k is an algebraically closed field. If there exists an indecomposable Λ -module of length $n > 1$, then there exists an indecomposable Λ -module of length $n-1$.* Unfortunately, the statement does not assert any relationship between the modules of length n and those of length $n-1$. There is the following open problem: *Given an indecomposable Λ -module M of length $n \geq 2$. Is there an indecomposable submodule or factor module of length $n-1$?* The three subspace quiver shows that this may not be true in case the field k is not algebraically closed, say if it is finite field with few elements.

In [21] we slightly modified the arguments of Bongartz in order to strengthen his assertion. Using induction, one may define *accessible* modules: First, the simple modules are accessible. Second, a module of length $n \geq 2$ is accessible provided it is indecomposable and there is a submodule or a factor module of length $n-1$ which is accessible. The open problem mentioned above can be reformulated as follows: Are all indecomposable representations of a k -algebra Λ , where k is algebraically closed, accessible? This is known to hold in case Λ is representation-finite and the aim of [21] was to show that any representation-infinite algebra over an algebraically closed field has at least accessible modules of arbitrarily large length.

In dealing with special biserial algebras, we do not have to worry about the size of the base field k . The following assertion is valid for k -algebras with k an arbitrary field.

Proposition 18.1. *Any indecomposable representation of a special biserial algebra is accessible.*

Proof. It is obvious that string modules are accessible, thus we only have to consider band modules. It will be sufficient to show the following: *any band module has a maximal submodule which is a string module.* Thus, let M be a band module.

First, let us consider the special case of dealing with the Kronecker algebra, thus $M = (M_1, M_2; \alpha, \beta)$ with vector spaces M_1, M_2 and invertible linear maps $\alpha, \beta : M_1 \rightarrow M_2$. Let M' be a submodule of M which is a band module and of smallest possible dimension. Note that M' is uniquely determined and is contained in any non-zero regular submodule of M . Let $0 \neq x \in M'_1$ and choose a direct complement $U \subset M_1$ for kx . Then $N = (U, M_2; \alpha|_U, \beta|_U)$ is a submodule of M , and of course a maximal one. We claim that N is a string module. As a submodule of a regular Kronecker module, we can write $N = N' \oplus N''$ with N' preprojective and N'' regular. But N'' has to be zero, since otherwise $M' \subseteq N''$, thus $x \in N''_1 \subseteq U$, a contradiction. This shows that N is a direct sum of say t indecomposable preprojective Kronecker modules. Since $\dim N_1 - \dim N_2 = -1$, it

follows that $t = 1$. This shows that N is an indecomposable preprojective Kronecker module and thus a string module.

Now consider an arbitrary special biserial algebra Λ with quiver Q . There is a primitive cyclic word $w \in \Omega(\Lambda)$ and an indecomposable vector space automorphism $\phi : V \rightarrow V$ such that $M = M(w, \phi)$. Let $w = l_1 \cdots l_n$ with letters l_i ; we can assume that l_{n-1} is a direct letter, whereas l_n is an inverse letter. Denote by x_{i-1} the terminal point of l_i , for $1 \leq i \leq n$. Then M is given by t copies V_i of V , indexed by $0 \leq i \leq n-1$, such that the arrows of Q operate as follows: if $l_i = \alpha$ is a direct letter (thus an arrow), then α is the identity map $V_i \rightarrow V_{i-1}$, if l_i is an inverse letter, say $l_i = \alpha^{-1}$ for some arrow α , then α is the identity map $V_{i-1} \rightarrow V_i$ for $i \neq n$ and the map $\phi : V_{n-1} \rightarrow V_0$ for $i = n$. Note that $(V, V; 1, \phi)$ is a band module for the Kronecker quiver, thus, as we have seen already, it has a maximal submodule $(U, V; 1|U, \phi|U)$ which is a string module. We obtain a submodule N of $M = \bigoplus_{i=0}^{n-1} V_i$ by taking the subspace $N = \bigoplus_{i=0}^{n-2} V_i \oplus U$, where U is considered as a subspace of V_{n-1} . Since $(U, V; 1|U, \phi|U)$ is a string module for the Kronecker algebra, it follows that N is a string Λ -module. \square

19. Semigroup algebras

It should be mentioned that algebras defined by a quiver, commutativity relations and zero relations can be considered as factor algebras of a semigroup algebra $k[S]$ modulo a one-dimensional ideal generated by a central idempotent e , thus the paper may be seen as dealing with a class of minimal representation-infinite semigroups.

Let S be a semigroup (a set with an associative binary operation). An element z of S is called a *zero* element provided $sz = z = zs$ for all $s \in S$. Of course, if there is a zero element, then it is uniquely determined. Let S be a semigroup with zero element z , we want to consider the semigroup algebra $k[S]$. Obviously, the element z considered as an element of $k[S]$ is a central idempotent and the ideal $\langle z \rangle$ generated by z is one-dimensional, thus z is a primitive idempotent. With z also $1 - z$ is a central idempotent, and we obtain a direct decomposition of $k[S]$ as a product of k -algebras

$$k[S] = \langle z \rangle \times \langle 1 - z \rangle = kz \times k[S](1 - z).$$

One may call $k[S](1 - z) = k[S]/\langle z \rangle$ the *reduced* semigroup algebra of S . It follows that the modules for the reduced semigroup algebra of S are precisely the $k[S]$ modules M with $zM = 0$.

The product decomposition of the semigroup algebra $k[S]$ shows that there is a unique simple (one-dimensional) $k[S]$ -module which is not annihilated by z , all other indecomposable $k[S]$ -modules are annihilated by z and thus are modules over the reduced semigroup-algebra.

Given a quiver Q , let $S(Q)$ be obtained from the set of all paths (including the paths of length 0) by adding an element z (it will become the zero element). As in the definition of the path algebra kQ of a quiver, define the product of two

paths to be the concatenation, if it exist, and to be z otherwise. In this way, $S(Q)$ becomes a semigroup with zero element z , and *the reduced semigroup algebra of $S(Q)$ can be identified with the path algebra $k[Q]$ of the quiver Q .*

Of course, if we deal with a set ρ of commutativity relations and zero relations, then we may consider the factor semigroup $S(Q, \rho) = S(Q)/\langle \rho \rangle$, this is again a semigroup with zero, and its reduced semigroup algebra is just the algebra defined by the quiver Q and the relations ρ .

References

- [1] Amiot, C.: Cluster categories for algebras of global dimension 2 and quivers with potential. arXiv:0805.1035, to appear in Annales de l'Institut Fourier.
- [2] Bautista, R., Gabriel, P., Roiter, A.V., Sameron, L.: Representation-finite algebras and multiplicative bases. *Inventiones mathematicae* 81 (1985), 217-285.
- [3] Bertram, E.: Even permutations as a product of two conjugate cycles. *J. of Combinatorial Theory (A)* 12 (1972), 368-380.
- [4] Bongartz, K.: Treue einfach zusammenhängende Algebren I. *Commentarii mathematici Helvetici* 57 (1982), 282-330.
- [5] Bongartz, K.: Indecomposables live in all smaller lengths. Preprint. arXiv:0904.4609
- [6] Buan, A., Marsh, R., Reiten, I.: Cluster-tilted algebras. *Transactions Amer. Math. Soc.* 359 (2007), 323-332.
- [7] Butler, M.C.R., Ringel, C.M.: Auslander-Reiten sequences with few middle terms and applications to string algebras. *Comm. Alg.* 15 (1987), 145-179.
- [8] Dowbor, P., Skowroński, A.: Galois coverings of representation-infinite algebras, *Comment. Math. Helv.* 62 (1987), 311-337.
- [9] Derksen, H., Weyman, J., Zelevinsky, A.: Quivers with potentials and their representations I: Mutations. arXiv:0704.0649v4, to appear in *Selecta Math.*
- [10] Geiß, Chr.: On components of type $\mathbb{Z}\mathbb{A}_\infty$ for string algebras. *Comm. Alg.* 26 (1998), 749- 758.
- [11] Gelfand, I.M., Ponomarev, V.A.: Indecomposable representations of the Lorentz group. *Russian Math. Surveys* 23 (1968), 1-58.
- [12] Husemoller, D. H.: Ramified coverings of Riemann surfaces. *Duke Math. J.* 29 (1962), 167-174.
- [13] Jans, J. P.: On the indecomposable representations of algebras. *Annals of Mathematics* 66 (1957), 418-429.
- [14] Keller, B., Reiten, I.: Cluster-tilted algebras are Gorenstein and stably Calabi-Yau. *Advances in Mathematics* 213 (2007), 140-164.
- [15] Martinez-Villa, R.: Algebras stably equivalent to l-hereditary. In: *Representation theory II*, Springer LNM 832 (1980), 396-431.
- [16] Reiten, I.: Homological properties of cluster tilted algebras. Talk at the workshop: *Cluster Algebras and Cluster Tilted Algebras*. Bielefeld 2006.
- [17] Ringel, C.M.: Tame algebras and integral quadratic forms. Springer LNM 1099 (1984).

- [18] Ringel, C.M.: Some algebraically compact modules I. In: Abelian Groups and Modules (ed. A. Facchini and C. Menini). Kluwer (1995), 419-439.
- [19] Ringel, C.M.: Infinite length modules. Some examples as introduction. In: Infinite Length Modules (ed. Krause, Ringel), Birkhäuser Verlag, Basel (2000), p.1-73.
- [20] Ringel, C.M.: On generic modules for string algebras. Bol. Soc. Mat. Mexicana (3) 7 (2001), 85-97.
- [21] Ringel, C.M.: Indecomposables live in all smaller lengths. Bull. London Math. Soc (to appear).
- [22] Ringel, C.M.: Cluster-additive functions on stable translation quivers. In preparation.
- [23] Schröer, J.: On the infinite radical of a module category. Proc. London Math. Soc. (3) 81 (2000), 651-674.
- [24] Skowronski, A., Waschbüsch, J.: Representation-finite biserial algebras, J. Reine Angew. Math. 345 (1983), 172-181.
- [25] Thiele, C.: The topological structure of Auslander-Reiten quivers of special string algebras. Comm. Algebra 21 (1993), 2507.2526.
- [26] Wald, B, Waschbüsch, J., Tame biserial algebras, J.Algebra 95 (1985), 480-500

Claus Michael Ringel
Fakultät für Mathematik, Universität Bielefeld
PO Box 100 131
D-33501 Bielefeld, Germany
E-mail: ringel@math.uni-bielefeld.de