

**COMPLETE SYSTEM OF ANALYTIC INVARIANTS FOR
UNFOLDED DIFFERENTIAL LINEAR SYSTEMS WITH AN
IRREGULAR SINGULARITY OF POINCARÉ RANK 1**

CAROLINE LAMBERT, CHRISTIANE ROUSSEAU

ABSTRACT. In this paper, we give a complete system of analytic invariants for the unfoldings of nonresonant linear differential systems with an irregular singularity of Poincaré rank 1 at the origin over a fixed neighborhood \mathbb{D}_r . The unfolding parameter ϵ is taken in a sector S pointed at the origin of opening larger than 2π in the complex plane, thus covering a whole neighborhood of the origin. For each parameter value $\epsilon \in S$, we cover \mathbb{D}_r with two sectors and, over each sector, we construct a well chosen basis of solutions of the unfolded linear differential systems. This basis is used to find the analytic invariants linked to the monodromy of the chosen basis around the singular points. The analytic invariants give a complete geometric interpretation to the well-known Stokes matrices at $\epsilon = 0$: this includes the link (existing at least for the generic cases) between the divergence of the solutions at $\epsilon = 0$ and the presence of logarithmic terms in the solutions for resonance values of the unfolding parameter. Finally, we give a realization theorem for a given complete system of analytic invariants satisfying a necessary and sufficient condition, thus identifying the set of modules.

1. INTRODUCTION

In this paper, we are interested in the unfolding of linear differential systems written as

$$(1) \quad y' = \frac{A(x)}{x^{k+1}} y,$$

with A a matrix of germs of analytic functions in x at the origin such that $A(0)$ has distinct eigenvalues (nonresonant case), $x \in (\mathbb{C}, 0)$, $y \in \mathbb{C}^n$, and k is a strictly positive integer called the Poincaré rank. We investigate the case of Poincaré rank $k = 1$, but a prenormal form, from which formal invariants can be calculated, is obtained in the general case $k \in \mathbb{N}^*$ (Section 3).

Most of the time, the formal solutions of the differential systems (1) at the irregular singular point $x = 0$ are divergent and the Stokes phenomenon is observed. To understand this phenomenon, the irregular singular point can be split into regular singular points by a deformation depending on a parameter ϵ . A. Glutsyuk [3] showed that the Stokes multipliers related to the system (1) can be obtained from the limits of transition operators of a perturbed system. In the generic deformations of the system (1) he considered, the parameter ϵ is taken in sectors that do

Date: November 19, 2018.

Key words and phrases. Stokes phenomenon, irregular singularity, unfolding, confluence, divergent series, monodromy, Riccati matrix differential equation, analytic classification, summability, realization.

Research supported by NSERC in Canada.

not cover a whole neighborhood of $\epsilon = 0$. In particular, he restricts his study to parameter values for which the bases of solutions of the perturbed system around the regular singular points never contain logarithmic terms. In our previous paper [6], we studied the confluence of two regular singular points of the hypergeometric equation into an irregular one. Our approach allowed us to cover a full neighborhood of the origin in the parameter space, the occurrence of logarithmic terms being embedded into a continuous phenomenon. Our description of the geometry however was not uniform in the parameter space. In this paper, we use the same approach for the unfolding of the systems (1): a whole neighborhood of $\epsilon = 0$ is covered, in a ramified way.

One of the main questions of the field is the equivalence problem for systems of the form (1): under which conditions does there exist an invertible matrix of germs of analytic functions at the origin, $P(x)$, giving an equivalence between two arbitrary systems of the form (1) with $y_1 = P(x)y_2$? The complete system of invariants for this equivalence relation contains formal invariants and an equivalence class of Stokes matrices. Many people have worked on it, and a final statement can be found in the paper of W. Balsler, W.B. Jurkat and D.A. Lutz [1]. In this paper, we give the analog of this complete system of invariants for 1-parameter families of systems that unfold generically the systems (1), with $k = 1$. Over a fixed neighborhood \mathbb{D}_r in x -space, the complete system of invariants for the unfolded systems consists of formal and analytic invariants. Formal invariants are obtained from the polynomial part of degree k of a prenormal form. The system composed of this polynomial part is a formal normal form which we call the "model system". When ϵ tends to 0, it converges to the usual polynomial formal normal form. \mathbb{D}_r is covered with two sectorial domains converging to sectors when $\epsilon \rightarrow 0$. These sectorial domains are chosen so that, on their intersection, solutions of the model have the same behavior when x tends to the singular points as solutions of the formal normal form at $\epsilon = 0$. Analytic invariants are given by an equivalence class of unfolded Stokes matrices (defined in Section 4.7), obtained from the monodromy of a well chosen basis of solutions that is the unique basis having the same asymptotic behavior, over the intersection of the sectorial domains and near the singular points, as the "diagonal" basis of the model system. In dimension $n = 2$ and $k = 1$, the well chosen basis corresponds to a "mixed basis" composed of two solutions that are eigenvectors of the monodromy operator at the two different singular points.

Furthermore, we give a geometric interpretation to the Stokes matrices in the unfolded systems: in particular, we link the Stokes matrices to the presence of logarithmic terms in the general solution of the unfolded system for resonance values of the parameter. We also relate these analytic invariants to the monodromy of first integrals of associated Riccati systems. Unfolded Stokes matrices depend analytically on $\hat{\epsilon}$ over a ramified sector around the origin and we show that there exists a representative in their equivalence class which is $\frac{1}{2}$ -summable in ϵ .

Finally, we describe the moduli space. We give a necessary and sufficient condition for a given set of invariants to be realizable as the modulus of an equivalence class of differential systems.

The paper is organized as follows. In Section 2, we recall the known results for $\epsilon = 0$ and $k = 1$. In Section 3, we define the genericity of the unfoldings of the systems we consider. We then state the equivalence relations under which we classify these unfoldings (Definition 3.3) and we obtain the prenormal form (Theorem 3.4) from

which the formal invariants can be calculated. Section 3 is the only section where the results are given for the general codimension $k \in \mathbb{N}^*$ case instead of $k = 1$. Section 4 contains the proof of the theorem of analytic classification of the unfolded systems (Theorem 4.62). We begin with the identification of the formal invariants in Theorem 4.4. Sections 4.2 to 4.4 contain a description of the sectorial domains in x and ϵ spaces. We then give, in Theorem 4.22, the well chosen fundamental matrix of solutions of the unfolded systems, which is valid over the domains previously defined. The definition of the unfolded Stokes matrices and their equivalence classes is given in Theorem 4.25 and Definition 4.28. In Sections 4.8 to 4.12, we obtain: the relation between the analytic invariants and the number of independent solutions that are eigenvectors of the monodromy (Theorem 4.34); the monodromy of first integrals of the associated Riccati systems (Theorem 4.39); the auto-intersection relation (Definition 4.52); the existence of a representative in the equivalence class of unfolded Stokes matrices that is $\frac{1}{2}$ -summable in ϵ (Theorem 4.54); the analytic equivalence to a simpler form for systems characterized by unfolded Stokes matrices in a (possibly permuted) block diagonal form (Theorem 4.57) or with identically zero (nondiagonal) entries in a column or row (Theorems 4.59 and 4.61). Finally, Section 5 contains the proof of the realization theorem (Theorem 5.2).

2. THE STOKES PHENOMENON AND INVARIANTS, $\epsilon = 0$

We consider the system (1) and we denote by $\lambda_{1,0}, \dots, \lambda_{n,0}$ the distinct eigenvalues of the matrix $A(0)$ that we can assume diagonal after a constant linear change of coordinates in the y variable. There exists a formal transformation $\hat{H}(x)$ such that $\hat{H}(0) = I$ and such that $y = \hat{H}(x)z$ conjugates (1) with its *formal normal form*

$$(2) \quad z' = \frac{\Lambda_0 + \Lambda_1 x + \dots + \Lambda_k x^k}{x^{k+1}} z,$$

with

$$(3) \quad \Lambda_q = \text{diag}\{\lambda_{1,q}, \dots, \lambda_{n,q}\}, \quad q = 0, 1, \dots, k.$$

Generally, elements of the matrix $\hat{H}(x)$ are not analytic around $x = 0$. But, there exists a covering of a punctured neighborhood of the origin in x -space by $2k$ sectors Ω_s such that on each of them there exists a unique invertible analytic transformation $H_s(x)$ conjugating (1) with (2) and having the asymptotic series $\hat{H}(x)$ in Ω_s . The comparison of these transformations on the intersections of the sectors Ω_s leads to the analytic invariants of the system (1). In this section, we recall these known results (for instance [5] pp. 351–372) in the case $k = 1$, since they will organize our study of the unfolding.

Let us take the system (1) and its formal normal form (2) which are written in the case $k = 1$ as

$$(4) \quad y' = \frac{A(x)}{x^2} y$$

and

$$(5) \quad z' = \frac{\Lambda_0 + \Lambda_1 x}{x^2} z,$$

with the above assumptions on $A(0)$. We permute the coordinates of $y \in \mathbb{C}^n$ in order to have

$$(6) \quad \Re(\lambda_{1,0}) \geq \Re(\lambda_{2,0}) \geq \dots \geq \Re(\lambda_{n,0})$$

and, if $\Re(\lambda_{q,0}) = \Re(\lambda_{j,0})$,

$$(7) \quad \Im(\lambda_{q,0}) < \Im(\lambda_{j,0}), \quad q < j.$$

Then, we have $\arg(\lambda_{q,0} - \lambda_{j,0}) \in]-\frac{\pi}{2}, \frac{\pi}{2}]$ for $q < j$. We rotate slightly the x -plane in the positive direction such that

$$(8) \quad \Re(\lambda_{q,0} - \lambda_{j,0}) > 0, \quad q < j.$$

From now on, the order of the coordinates of y and the x -coordinate (for $\epsilon = 0$) are fixed. We are now ready to choose the covering sectors in x using the notion of separation rays.

Definition 2.1. When $k = 1$, the *separation rays* in the x -plane corresponding to $\lambda_{q,0}, \lambda_{j,0} \in \mathbb{C}$, $\lambda_{q,0} \neq \lambda_{j,0}$, are the two rays such that

$$(9) \quad \Re\left(\frac{\lambda_{q,0} - \lambda_{j,0}}{x}\right) = 0.$$

Definition 2.2. We define two open sectors Ω_D and Ω_U as

$$(10) \quad \begin{aligned} \Omega_D &= \{x \in \mathbb{C} : |x| < r, -(\pi + \delta) < \arg(x) < \delta\}, \\ \Omega_U &= \{x \in \mathbb{C} : |x| < r, -\delta < \arg(x) < \pi + \delta\}, \end{aligned}$$

with $\delta > 0$ chosen sufficiently small so that the closure of Ω_D (respectively Ω_U) does not contain any separation rays located in the upper (respectively lower) half plane. Several restrictions on the radius of these sectors will be discussed later. The sectors are illustrated in Figure 1 with their intersection $\Omega_L \cap \Omega_R$.

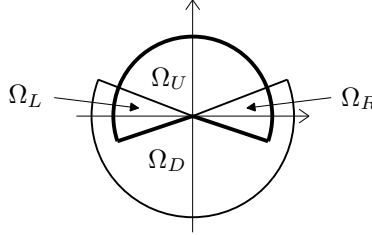

FIGURE 1. Sectors Ω_D and Ω_U and their intersection $\Omega_L \cup \Omega_R$.

By the sectorial normalization theorem of Y. Sibuya [10] (p. 144), if r is chosen sufficiently small, there exists over each sector Ω_s ($s = D, U$) a unique invertible matrix of analytic functions $H_s(x)$, asymptotic at the origin in Ω_s to a power series $\hat{H}(x)$ independent of s , such that $y = H_s(x)z$ conjugates (4) with its formal normal form (5).

The Stokes phenomenon appears when considering the intersection of the sectors Ω_U and Ω_D . Let $F(x)$ be the diagonal fundamental matrix solution of the formal normal form (5) in the ramified domain $\{x \in \mathbb{C} : -(\pi + \delta) < \arg(x) < \pi + \delta\}$ given by

$$(11) \quad F(x) = x^{\Lambda_1} e^{-\frac{1}{x}\Lambda_0}.$$

Let $F_s(x)$ be the restriction of $F(x)$ to Ω_s , $s = D, U$. On each connected component of the intersection $\Omega_D \cap \Omega_U$ (Figure 1), we have two bases of solutions of (4) given by $H_D(x)F_D(x)$ and $H_U(x)F_U(x)$, with

$$(12) \quad F_U(x) = \begin{cases} F_D(x), & \text{on } \Omega_R, \\ F_D(x)e^{2\pi i\Lambda_1}, & \text{on } \Omega_L. \end{cases}$$

Each element of one basis may be expressed as a linear combination of elements of the other basis, giving the existence of matrices C_R and C_L , such that

$$(13) \quad H_D(x)^{-1}H_U(x) = \begin{cases} F_D(x)C_R(F_D(x))^{-1}, & \text{on } \Omega_R, \\ F_D(x)C_L(F_D(x))^{-1}, & \text{on } \Omega_L. \end{cases}$$

The matrices C_R and C_L are unipotent, respectively upper and lower triangular, and they are called the *Stokes matrices*. The *Stokes phenomenon* occurs when at least one of these Stokes matrices is different from the identity matrix and it reflects the divergence of the formal transformation $\hat{H}(x)$.

As $F(x)K$ is also a fundamental matrix of the normal system (5) for any nonsingular constant diagonal matrix K , two *Stokes collections* $\{C_R, C_L\}$ and $\{C'_R, C'_L\}$ are said to be *equivalent* if there exists a nonsingular constant diagonal matrix K such that

$$(14) \quad C'_l = KC_lK^{-1}, \quad l = L, R.$$

The equivalence classes of Stokes collections are analytic invariants for the classification of the systems (4). The next two theorems are now standard in the literature.

Definition 2.3. Two systems are locally *analytically equivalent* if there exists an invertible matrix P of germs of analytic functions in x at the origin such that the substitution $y_1 = P(x)y_2$ transforms the system $y'_1 = A_1(x)y_1$ into $y'_2 = A_2(x)y_2$.

Theorem 2.4. *Two systems (4) with the same formal normal form (5) are locally analytically equivalent in the neighborhood of $x = 0$ if and only if their Stokes collections are equivalent in the sense (14).*

Related to a system (4), we thus have formal invariants, which are the coefficients of the matrices Λ_0 and Λ_1 in the formal normal form (5), and analytic invariants, given by the equivalence class of the Stokes collections. The moduli space corresponding to these invariants has been completely described:

Theorem 2.5. *Any collection consisting of two unipotent matrices, an upper triangular one and a lower triangular one, can be realized as the Stokes collection of a nonresonant irregular singularity with a preassigned formal normal form.*

Where do these invariants come from? What do they mean? The answer appears when unfolding.

3. THE PRENORMAL FORM, $k \in \mathbb{N}^*$

In this section, we unfold the systems (1), with $k \in \mathbb{N}^*$, and introduce a prenormal form in which formal invariants can be calculated from a polynomial part. The transformation from a system (1) to its prenormal form is analytic.

3.1. Generic unfolding. We consider an unfolding of a system (1) of the form

$$(15) \quad f(\eta, x)y' = A(\eta, x)y,$$

where $\eta = (\eta_0, \dots, \eta_{k-1}) \in \mathbb{C}^k$, $f(\eta, x)$ are germs of analytic functions at the origin such that $f(0, x) = x^{k+1}$ and A is a matrix of germs of analytic functions at the origin satisfying $A(0, x) = A(x)$. We will restrict ourselves to functions $f(\eta, x)$ such that the unfolding is *generic*. To define this term, we need the following proposition.

Proposition 3.1. *After a translation $X = x + b(\eta)$, with b a germ of analytic map such that $b(0) = 0$, any linear differential system (15) may be written as*

$$(16) \quad q^*(\eta, X)y' = A^*(\eta, X)y,$$

with A^* a matrix of germs of analytic functions in (η, X) at the origin satisfying $A^*(0, X) = A(0, x)$ and with $q^*(\eta, X) = X^{k+1} + \epsilon_{k-1}(\eta)X^{k-1} + \epsilon_{k-2}(\eta)X^{k-2} \dots + \epsilon_0(\eta)$, where $\epsilon_j(\eta)$ are germs of holomorphic functions at the origin such that $\epsilon_j(0) = 0$, $j = 0, 1, \dots, k-1$.

Proof. Given a particular $f(\eta, x)$, there exist, from Weierstrass preparation theorem, a unique invertible germ of analytic functions at the origin $u(\eta, x)$ and a unique Weierstrass polynomial $q(\eta, x) = x^{k+1} + \alpha_k(\eta)x^k + \alpha_{k-1}(\eta)x^{k-1} \dots + \alpha_0(\eta)$ such that $f(\eta, x) = u(\eta, x)q(\eta, x)$, where $\alpha_j(\eta)$ are germs of analytic functions at the origin satisfying $\alpha_j(0) = 0$ for $j = 0, 1, \dots, k$. This yields the system

$$(17) \quad q(\eta, x)y' = \frac{A(\eta, x)}{u(\eta, x)}y.$$

The change of variable $X = x + \frac{\alpha_k(\eta)}{k+1}$ yields the result. \square

Definition 3.2. An unfolding is *generic* if the germ of analytic map

$$(18) \quad \eta = (\eta_0, \dots, \eta_{k-1}) \mapsto \epsilon = (\epsilon_0(\eta), \dots, \epsilon_{k-1}(\eta))$$

defined in Proposition 3.1 is invertible.

We restrict our study to generic unfoldings of systems (1). From the equation (16), the genericity condition allows us to take $\epsilon = (\epsilon_0, \dots, \epsilon_{k-1})$ as our new parameter. Let us change the notation of the variable X by x and from now on we do not make any more coordinate change on x . We write the generic unfoldings of the differential linear systems (1) as

$$(19) \quad p(\epsilon, x)y' = B(\epsilon, x)y,$$

with

$$(20) \quad p(\epsilon, x) = x^{k+1} + \epsilon_{k-1}x^{k-1} + \dots + \epsilon_0,$$

$\epsilon = (\epsilon_0, \dots, \epsilon_{k-1}) \in \mathbb{C}^k$ and $B(\epsilon, x)$ a matrix of germs of analytic functions at the origin satisfying $B(0, x) = A(x)$ as in (1).

3.2. Equivalence classes of generic families of linear systems unfolding

(1). In this paper, we are interested in equivalence classes of systems (19). We use the same terminology as the one used for the classification of the systems (1), since it agrees with it when $\epsilon = 0$:

Definition 3.3. Two systems $y' = A(\epsilon, x)y$ and $z' = B(\epsilon, x)z$ are locally *analytically equivalent* (respectively *formally equivalent*) if there exists an invertible matrix P of germs of analytic functions of (ϵ, x) at the origin (respectively an invertible matrix of formal series in (ϵ, x)) such that the substitution $y = P(\epsilon, x)z$ transforms one system into the other.

We search for a complete system of analytic invariants for the systems (19) under analytic equivalence. First, we choose a representative of each equivalence class called the *prenormal form*.

3.3. Prenormal form. The families of systems (19) have singularities at $x = x_l$, for x_l such that $p(\epsilon, x_l) = 0$. When looking at solutions around these singularities, we need to evaluate the eigenvalues of $B(\epsilon, x_l)$. With the next theorem, we express them as the values at x_l of polynomials of degree less than or equal to k .

Theorem 3.4. *The family of systems (19) is analytically equivalent to a family in the prenormal form*

$$(21) \quad p(\epsilon, x)y' = B(\epsilon, x)y,$$

where

$$(22) \quad B(\epsilon, x) = \Lambda(\epsilon, x) + p(\epsilon, x)R(\epsilon, x),$$

$$(23) \quad \Lambda(\epsilon, x) = \text{diag}\{\lambda_1(\epsilon, x), \dots, \lambda_n(\epsilon, x)\},$$

$$(24) \quad \lambda_i(\epsilon, x) = \lambda_{i,0}(\epsilon) + \lambda_{i,1}(\epsilon)x + \dots + \lambda_{i,k}(\epsilon)x^k,$$

$\lambda_{j,q}$ are germs of analytic functions in ϵ at the origin, $p(\epsilon, x)$ is given by (20) and $R(\epsilon, x)$ is a matrix of germs of analytic functions at the origin.

Proof. As $A(0)$ in (1) is a diagonal matrix, $B(0, 0) = A(0)$ is also diagonal with distinct eigenvalues. We take x in a neighborhood \mathbb{D}_r of the origin such that the eigenvalues of $A(x)$ are distinct. Let us prove that there exists $P(\epsilon, x)$ a matrix of germs of analytic functions at the origin that diagonalizes $B(\epsilon, x)$ for $x \in \mathbb{D}_r$ and for ϵ sufficiently small. $P(0, 0)$ can be any nonsingular diagonal matrix, let us take $P(0, 0) = I$. For ϵ small and $x \in \mathbb{D}_r$, the eigenvalues of $B(\epsilon, x)$ are distinct and are analytic functions $\nu_i(\epsilon, x)$ of (ϵ, x) by the implicit function theorem. Also, there exists a unique analytic eigenvector $v_i(\epsilon, x)$ relative to the eigenvalue $\nu_i(\epsilon, x)$ having the i^{th} component equal to one (this is obtained with the implicit function theorem, taking $F_i(w, \epsilon, x) = 0$, where $F_i(w, \epsilon, x) = B_i(\epsilon, x)v_i$, $w = (w_1, \dots, w_{n-1})$, $v_i = (w_1, \dots, w_{i-1}, 1, w_i, \dots, w_{n-1})$ and where $B_i(\epsilon, x)$ is the matrix obtained by removing the i^{th} line of $(B(\epsilon, x) - \nu_i(\epsilon, x)I)$). We then take the i^{th} column of $P(\epsilon, x)$ equal to $v_i(\epsilon, x)$.

Finally, by taking $z = P(\epsilon, x)^{-1}y$, the new system $p(\epsilon, x)z' = B^*(\epsilon, x)z$ satisfies $B^*(\epsilon, x) = \text{diag}\{\nu_1(\epsilon, x), \dots, \nu_n(\epsilon, x)\} + p(\epsilon, x)P(\epsilon, x)^{-1}\frac{\partial P(\epsilon, x)}{\partial x}$ and is analytically equivalent to the original system. Dividing $\nu_i(\epsilon, x)$ by $p(\epsilon, x)$, we get $\nu_i(\epsilon, x) = c_i(\epsilon, x)p(\epsilon, x) + \lambda_{i,0}(\epsilon) + \lambda_{i,1}(\epsilon)x + \dots + \lambda_{i,k}(\epsilon)x^k$, from which the result follows. \square

Remark 3.5. *The polynomial part $\Lambda(\epsilon, x)$ of the prenormal form is completely characterized by $n(k+1)$ quantities $\lambda_{j,q}(\epsilon)$ (with $q = 0, 1, \dots, k$ and $j = 1, 2, \dots, n$). For ϵ fixed such that the singular points are nonresonant, the collection of the well-known formal invariants at all singular points contains also $n(k+1)$ elements (for*

instance the collection of the eigenvalues of the residue matrices if the singular points are all distinct).

For the rest of the paper, we only discuss systems in prenormal form (21).

4. COMPLETE SYSTEM OF INVARIANTS IN THE CASE $k = 1$

This section leads to the complete description of the analytic equivalence classes of generic families of systems in the prenormal form (21), limiting ourselves to the case $k = 1$. Let us write these systems as

$$(25) \quad (x^2 - \epsilon)y' = B(\epsilon, x)y,$$

where

$$(26) \quad B(\epsilon, x) = \Lambda(\epsilon, x) + (x^2 - \epsilon)R(\epsilon, x),$$

with

$$(27) \quad \begin{aligned} \Lambda(\epsilon, x) &= \text{diag}\{\lambda_1(\epsilon, x), \dots, \lambda_n(\epsilon, x)\}, \\ &= \Lambda_0(\epsilon) + \Lambda_1(\epsilon)x, \end{aligned}$$

and

$$(28) \quad \Lambda_q(\epsilon) = \text{diag}\{\lambda_{1,q}(\epsilon), \dots, \lambda_{n,q}(\epsilon)\}, \quad q = 0, 1.$$

The quantity $\lambda_{j,0}(0) = \lambda_j(0, 0)$ correspond to $\lambda_{j,0}$ defined in Section 2. Hence, relation (8) may be written as

$$(29) \quad \Re(\lambda_q(0, 0) - \lambda_j(0, 0)) > 0, \quad q < j.$$

This ordering on the eigenvalues of $\Lambda(\epsilon, x)$ at $(\epsilon, x) = 0$ will be kept for $\epsilon \neq 0$ and $|x| \leq \sqrt{|\epsilon|}$ by taking ϵ sufficiently small (see Remark 4.9).

We like to call

$$(30) \quad (x^2 - \epsilon)z' = \Lambda(\epsilon, x)z$$

the *model system*. When $\epsilon = 0$, it corresponds to the formal normal form.

In the systems (25) and (30), the irregular singular point at $\epsilon = 0$ splits into two regular singular points when $\epsilon \neq 0$ (in the present context, these points are Fuchsian).

Notation 4.1. We denote the zeros of $x^2 - \epsilon$ by

$$(31) \quad x_L = \sqrt{\epsilon} \quad \text{and} \quad x_R = -\sqrt{\epsilon}.$$

These points are respectively at the left and at the right of the origin when $\sqrt{\epsilon} \in \mathbb{R}_-$ (this will make sense with Definition 4.10).

The model system has a fundamental matrix of solutions given by

$$(32) \quad F(\epsilon, x) = \text{diag}\{f_1(\epsilon, x), \dots, f_n(\epsilon, x)\} = \begin{cases} (x - x_R)^{\mathcal{U}_R} (x - x_L)^{\mathcal{U}_L}, & \epsilon \neq 0, \\ x^{\Lambda_1(0)} \exp\left(-\frac{\Lambda_0(0)}{x}\right), & \epsilon = 0, \end{cases}$$

with

$$(33) \quad \mathcal{U}_l = \frac{1}{2x_l} \Lambda(\epsilon, x_l) = \frac{1}{2x_l} \Lambda_0(\epsilon) + \frac{1}{2} \Lambda_1(\epsilon) = \text{diag}\{\mu_{1,l}, \dots, \mu_{n,l}\}, \quad l = L, R.$$

The functions $f_j(\epsilon, x)$ will be at the core of the construction of the sectorial domains in the x -space done in Section 4.4.

Remark 4.2. *The solutions $f_j(\epsilon, x)$ of the model system given by (32) are analytic in (ϵ, x) for ϵ in a punctured neighborhood of $\epsilon = 0$ and for x in a simply connected domain that does not contain any singular point $x = x_l$, for $l = L, R$. These functions converge uniformly on simply connected compact sets of the punctured disc \mathbb{D}_r^* of radius r to $f_j(0, x)$ when $\epsilon \rightarrow 0$.*

Let us immediately state notations related to formal invariants that we will frequently use in this paper.

Notation 4.3. We define

$$(34) \quad D_R = e^{-2\pi i \mathcal{U}_R}, \quad D_L = e^{2\pi i \mathcal{U}_L}.$$

and

$$(35) \quad \begin{aligned} \Delta_{sj,l} &= (D_l)_{ss} (D_l^{-1})_{jj}, \quad l = L, R, \\ &= \begin{cases} e^{2\pi i(\mu_{s,l} - \mu_{j,l})}, & l = L, \\ e^{2\pi i(\mu_{j,l} - \mu_{s,l})}, & l = R, \end{cases} \end{aligned}$$

with U_l and $\mu_{j,l}$ given by (33). We have

$$(36) \quad D_R^{-1} D_L = e^{2\pi i \Lambda_1(\epsilon)},$$

with $\Lambda_1(\epsilon)$ given by (28). We will see that D_L (respectively D_R) is the matrix representing the monodromy around $x = x_L$ in the positive direction (respectively around $x = x_R$ in the negative direction) when acting on the fundamental matrix of solutions (32) of the model system. $e^{2\pi i \Lambda_1(\epsilon)}$ represents the monodromy around both singular points, in the positive direction.

The model system (30) corresponding to a system (25) contains all the information on the formal invariants:

Theorem 4.4. *Two systems (25) are formally equivalent if and only if they have the same model system. Hence, the complete system of formal invariants of the systems (25) is given by the n (degree 1) polynomials $\lambda_i(\epsilon, x)$ in the polynomial part of the prenormal form.*

Proof. By the Poincaré-Dulac Theorem (see [5] p. 45) applied to the nonlinear system

$$(37) \quad \begin{cases} \dot{y} = B(\epsilon, x)y, \\ \dot{x} = x^2 - \epsilon, \\ \dot{\epsilon} = 0, \end{cases}$$

there exists an invertible formal transformation $Y = T(\epsilon, x)y$ at $(\epsilon, x) = (0, 0)$ eliminating nondiagonal terms in (25) and yielding a diagonal $R(\epsilon, x)$ in (26). Then, the transformation $z = e^{-\int_0^x R(\epsilon, x) dx} Y$ leads to the model. Hence, letting $J(\epsilon, x) = e^{-\int_0^x R(\epsilon, x) dx} T(\epsilon, x)$, the invertible transformation $z = J(\epsilon, x)y$ conjugates formally a system (25) to its model.

Let us take two systems of the form (25) with the same model system, each of them formally conjugated to the model with $J^i(\epsilon, x)$. The transformation $\mathcal{Q}(\epsilon, x) = (J^1(\epsilon, x))^{-1} J^2(\epsilon, x)$ leads a formal equivalence between the two systems.

On the other hand, let us suppose that two systems $(x^2 - \epsilon)y'_1 = B^1(\epsilon, x)y_1$ and $(x^2 - \epsilon)y'_2 = B^2(\epsilon, x)y_2$, with $B^i(\epsilon, x) = \Lambda^i(\epsilon, x) + (x^2 - \epsilon)R^i(\epsilon, x)$, are formally equivalent via $y_1 = \mathcal{Q}(\epsilon, x)y_2$, each of them formally conjugated to its model with

$z_i = J^i(\epsilon, x)y_i$. We obtain that $P(\epsilon, x) = J^1(\epsilon, x)\mathcal{Q}(\epsilon, x)(J^2(\epsilon, x))^{-1}$ is an invertible formal transformation from the second model system $(x^2 - \epsilon)z'_2 = \Lambda^2(\epsilon, x)z_2$ to the first model system $(x^2 - \epsilon)z'_1 = \Lambda^1(\epsilon, x)z_1$. Formally, we thus have

$$(38) \quad (x^2 - \epsilon)\frac{\partial}{\partial x}P(\epsilon, x) + P(\epsilon, x)\Lambda^2(\epsilon, x) = \Lambda^1(\epsilon, x)P(\epsilon, x).$$

By considering this equality for each power of $\epsilon^p x^q$, we obtain that $\Lambda^1(\epsilon, x) = \Lambda^2(\epsilon, x)$ (and that $P(\epsilon, x)$ is a diagonal matrix depending only on ϵ). Hence, the two systems have the same model system. \square

Around each singular point, the system (25) has a well-known basis of solutions (given by eigenvectors of the monodromy operator) that we present in Theorem 4.34, but the problem with this basis is that it is not defined for an infinite set of resonance values of ϵ which accumulate at $\epsilon = 0$. We want to give a unified treatment which highlights the fact that the Stokes phenomenon at $\epsilon = 0$ organizes, in the unfolding, the form of solutions at the resonance values of the parameter. Thus, we rather use a new basis that is defined for all parameter values in a sector of opening greater than 2π in the universal covering of the ϵ -space punctured at $\epsilon = 0$. To find this particular basis, we choose to consider the solutions of the linear systems in the complex projective space.

4.1. The projective space. The system (25) is invariant under $y \rightarrow cy$, with $c \in \mathbb{C}^*$. Taking charts in the complex projective space, it gives n particular Riccati matrix differential equations. We introduce t by $\frac{dx}{dt} = \dot{x} = x^2 - \epsilon$ and replace them by n systems of ordinary differential equations (indexed by j)

$$(39) \quad \begin{cases} \frac{dx}{dt} &= x^2 - \epsilon, \\ \frac{d}{dt} \frac{(y)_q}{(y)_j} &= (\lambda_q(\epsilon, x) - \lambda_j(\epsilon, x)) \frac{(y)_q}{(y)_j} \\ &+ (x^2 - \epsilon) \sum_{i=1}^n \frac{(y)_i}{(y)_j} \left((R(\epsilon, x))_{qi} - (R(\epsilon, x))_{ji} \frac{(y)_q}{(y)_j} \right), \quad q \neq j, \end{cases}$$

that we call the *Riccati systems*.

Notation 4.5. Let v be a n -dimensional column vector. We define

$$(40) \quad [v]_j = \left(-\frac{(v)_1}{(v)_j}, \dots, -\frac{(v)_{j-1}}{(v)_j}, -\widehat{\frac{(v)_j}{(v)_j}}, -\frac{(v)_{j+1}}{(v)_j}, \dots, -\frac{(v)_n}{(v)_j} \right)^T,$$

where $(v)_i$ is the i^{th} component of the column vector v and where the hat denotes omission.

Remark 4.6. Following Notation 4.5, the j^{th} Riccati system associated to the linear system (25) may be written as

$$(41) \quad \begin{cases} \frac{d}{dt}x &= x^2 - \epsilon, \\ \frac{d}{dt}[y]_j &= -B_j^0(\epsilon, x) + B_j^1(\epsilon, x)[y]_j + (B_j^2(\epsilon, x)[y]_j)[y]_j, \end{cases}$$

with, denoting I the $(n-1) \times (n-1)$ identity matrix,

$$(42) \quad \begin{aligned} B_j^0(\epsilon, x) &: j^{\text{th}} \text{ column of } B(\epsilon, x) \text{ except } (B(\epsilon, x))_{jj}; \\ B_j^1(\epsilon, x) &: (B(\epsilon, x) \text{ without } j^{\text{th}} \text{ column and } j^{\text{th}} \text{ line}) - (B(\epsilon, x))_{jj} I; \\ B_j^2(\epsilon, x) &: j^{\text{th}} \text{ line of } B(\epsilon, x) \text{ except } (B(\epsilon, x))_{jj}. \end{aligned}$$

4.2. Radius of the sectors in the x -space when $\epsilon = 0$. In order to obtain a basis of solutions of the linear system (25), we will find in Section 4.5 particular solutions (defined for ϵ in a ramified sector and for x in sectorial domains) of the Riccati systems (41). To ensure that these solutions will converge uniformly on compact sets to solutions $[y]_j = G_{j,s}(0, x)$ (defined over the sectors Ω_s given by (10) for $s = D, U$), we choose in this section the radius of Ω_s .

Let us first define the solution $[y]_j = G_{j,s}(0, x)$. When $\epsilon = 0$, if the radius r of Ω_s is chosen sufficiently small, there exists a unique fundamental matrix of solutions of the system (25) that can be written as

$$(43) \quad W_s(0, x) = H_s(0, x)F_s(0, x), \quad \text{on } \Omega_s, s = D, U,$$

where $F_s(0, x)$ is the restriction of $F(0, x)$ given by (32) to the sectorial domain Ω_s , and where $H_s(0, x)$ is an invertible matrix of functions which are analytic on Ω_s and continuous on its closure, satisfying $H_s(0, 0) = I$. $H_s(0, x)$ links the system to its formal normal form and is obtained by the sectorial normalization theorem of Y. Sibuya [10] (p. 144), as mentioned in Section 2.

Notation 4.7. The solution corresponding to the j^{th} column of $W_s(0, x)$ in the j^{th} Riccati system passes through $(x, [y]_j) = (0, 0)$ and is tangent to the x direction, we denote it as $[y]_j = G_{j,s}(0, x)$.

Let us now specify how we restrict the radius of Ω_s .

Proposition 4.8. *Let us define the region*

$$(44) \quad \mathcal{V}^j = \left\{ (x, [y]_j) \in \mathbb{C} \times \mathbb{C}\mathbb{P}^{n-1} : \left| \frac{(y)_i}{(y)_j} \right| \leq |x|, \forall i \in \{1, \dots, n\} \setminus \{j\} \right\}.$$

The boundary of \mathcal{V}^j is $\bigcup_{\substack{i=1 \\ i \neq j}}^n \mathcal{V}_i^j$, with

$$(45) \quad \mathcal{V}_i^j = \left\{ (x, [y]_j) \in \mathbb{C} \times \mathbb{C}\mathbb{P}^{n-1} : \left| \frac{(y)_i}{(y)_j} \right| = |x|, \left| \frac{(y)_k}{(y)_j} \right| \leq |x| \text{ if } k \neq i, j \right\}, \quad i \neq j.$$

The radius r of Ω_s , $s = D, U$, can be chosen sufficiently small so that the graph $[y]_j = G_{j,s}(0, x)$ is confined inside \mathcal{V}^j , for all $j \in \{1, \dots, n\}$.

Proof. We consider (39) for $\epsilon = 0$. We have

$$(46) \quad \left| \frac{d}{dt} |x| \right| = \frac{|\Re(\bar{x}\dot{x})|}{|x|} = \frac{|\Re(\bar{x}x^2)|}{|x|} \leq |x|^2$$

and

$$(47) \quad \frac{1}{|x|} \left| \frac{d}{dt} \left| \frac{(y)_i}{(y)_j} \right| \right| \geq |\Re(\lambda_{i,0}(0) - \lambda_{j,0}(0))| - v_{ij}(x),$$

with

$$(48) \quad v_{ij}(x) = |\lambda_{i,1}(0) - \lambda_{j,1}(0)| |x| + |x|^2 \sum_{\substack{k=1 \\ k \neq j}}^n |(R(0, x))_{ik}| \\ + |x| \left(|(R(0, x))_{ij}| + |x|^2 \sum_{\substack{k=1 \\ k \neq j}}^n |(R(0, x))_{jk}| + |x| |(R(0, x))_{jj}| \right).$$

Let us choose $0 < \eta < 1$. As $|\Re(\lambda_{i,0}(0) - \lambda_{j,0}(0))| > 0$, we can take the radius r of Ω_D and Ω_U sufficiently small so that

$$(49) \quad v_{ij}(x) + |x| < (1 - \eta) |\Re(\lambda_{i,0}(0) - \lambda_{j,0}(0))|, \quad x \in \Omega_D \cup \Omega_U, i, j \in \{1, \dots, n\}, i \neq j.$$

This implies

$$(50) \quad \left| \frac{d}{dt} |x| \right| < \left| \frac{d}{dt} \left| \frac{(y)_i}{(y)_j} \right| \right|, \quad \text{for } \begin{cases} (x, [y]_j) \in \mathcal{V}_i^j, \\ x \in \Omega_s, & s = D, U, \\ i, j \in \{1, \dots, n\}, & i \neq j. \end{cases}$$

Since the graph $[y]_j = G_{j,s}(0, x)$ contains the point $(x, [y]_j) = (0, 0)$ and is tangent to the x -plane, it is confined inside \mathcal{V}^j (if a solution parametrized by a curve in complex time living on the graph $[y]_j = G_{j,s}(0, x)$ were to intersect a boundary component of \mathcal{V}^j , then (50) would not be satisfied). We introduced the parameter η in order to have in the unfolding a similar property (see Proposition 4.16). \square

4.3. Sector in the parameter space. Let us specify the sector on the universal covering of the ϵ -space punctured at the origin with which we will work.

Remark 4.9. We take ϵ sufficiently small in order to have:

$$(51) \quad \Re(\lambda_q(\epsilon, x) - \lambda_j(\epsilon, x)) > 0, \quad |x| \leq \sqrt{|\epsilon|}, \quad q < j.$$

Hence, we have the same ordering of the eigenvalues of $\Lambda(\epsilon, x_l)$ as the one for $\Lambda(0, 0)$ given by (29).

Definition 4.10. We define the sector S , of opening larger than 2π and covering completely a punctured neighborhood of $\epsilon = 0$, as

$$(52) \quad S = \{\hat{\epsilon} \in \mathbb{C} : 0 < |\hat{\epsilon}| < \rho, \arg(\hat{\epsilon}) \in (\pi - 2\gamma, 3\pi + 2\gamma)\}$$

(see Figure 2). In (52), any $\gamma > 0$ such that $\gamma(1 + 2\frac{\gamma}{\pi}) < \theta_0$ can be chosen, with θ_0

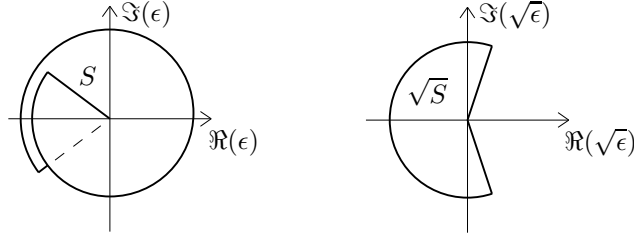

FIGURE 2. Sector S in terms of the parameters ϵ and $\sqrt{\epsilon}$.

the maximum angle in $(0, \frac{\pi}{2})$ such that

$$(53) \quad \Re(e^{\pm i\theta_0}(\lambda_q(0, 0) - \lambda_j(0, 0))) \geq 0, \quad q < j,$$

with $\lambda_j(\epsilon, x)$ as in (27) (θ_0 exists because of (29)). Once γ is chosen, the radius ρ is chosen to ensure that there exists $C > 0$ for which

$$(54) \quad \Re(e^{\pm i\gamma(1+2\frac{\gamma}{\pi})}(\lambda_q(\epsilon, \hat{x}_l) - \lambda_j(\epsilon, \hat{x}_l))) > C > 0, \quad q < j, \quad l = L, R, \quad \hat{\epsilon} \in S.$$

We will restrict a few other times the value of ρ (in particular, to construct the sectorial domains in the x -variable in Section 4.4 and to ensure that Proposition 4.16 is true).

Remark 4.11. We did not include the real values of the parameter such that $\arg(\hat{\epsilon}) = 0$ into S , but rather the values of the parameter such that $\arg(\hat{\epsilon}) = 2\pi$. This results from defining first the sector in terms of $\sqrt{\epsilon}$ in order to avoid decreasing resonance values of the parameter (see Definition 4.14) that are approaching the ray $\arg(\sqrt{\epsilon}) = \arg(\lambda_{q,0}(0) - \lambda_{j,0}(0))$ for $q < j$ (and to include those approaching it for $q > j$). By a change of parameter (see Remark 4.15), we can choose to include values such that $\arg(\hat{\epsilon}) = 0$ into S .

Notation 4.12. We denote the auto-intersection of S as S_\cap . For values of the parameter in S_\cap , we denote

$$(55) \quad \tilde{\epsilon} = \bar{\epsilon}e^{2\pi i} \in S_\cap$$

(see Figure 3).

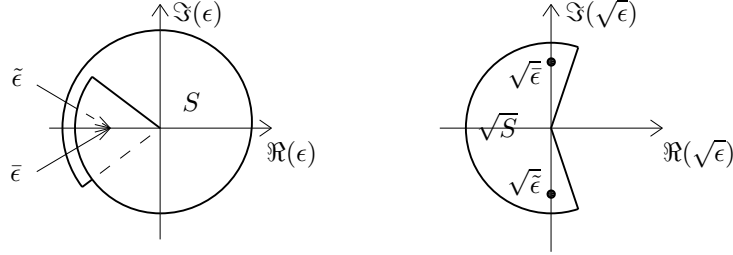

FIGURE 3. Example of values of $\bar{\epsilon}$ and $\tilde{\epsilon}$ in S_\cap (in terms of ϵ and $\sqrt{\epsilon}$).

Notation 4.13. We will write the hat symbol over quantities that depend on $\hat{\epsilon} \in S$ (for example \hat{x}_L). We will write the symbols \sim (respectively $\bar{}$) over quantities that depend on $\tilde{\epsilon} \in S_\cap$ (respectively $\bar{\epsilon} \in S_\cap$). When we use the hat symbol for values of the parameter in S_\cap , we mean that $\hat{\epsilon}$ could either be $\bar{\epsilon}$ or $\tilde{\epsilon}$.

4.4. Sectorial domains in x . For the rest of Section 4, x belongs to a disk of radius r determined by Proposition 4.8. Let us now explain the construction of the sectorial domains in the complex plane for the x -variable. The boundary of these domains will be defined from solutions of the equation

$$(56) \quad \dot{x} = (x^2 - \epsilon),$$

allowing complex time. More precisely, passing to the t -variable, we have

$$(57) \quad t(x) = \begin{cases} \frac{1}{2\sqrt{\epsilon}} \log\left(\frac{x-\sqrt{\epsilon}}{x+\sqrt{\epsilon}}\right), & \epsilon \neq 0, \\ -\frac{1}{x}, & \epsilon = 0. \end{cases}$$

For $\epsilon = 0$, we cover the disk of radius r with two sectorial domains Ω_D^0 and Ω_U^0 (see Figure 4) included respectively inside the sectors Ω_D and Ω_U defined by (10). The sectorial domains Ω_D^0 and Ω_U^0 correspond respectively, in the t -variable, to the sectorial domains Γ_D^0 and Γ_U^0 illustrated in Figure 5.

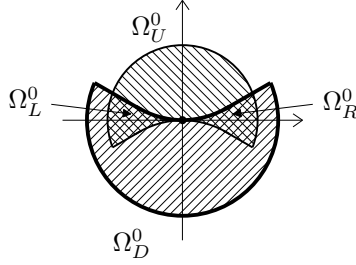

FIGURE 4. Sectorial domains in the x -variable when $\epsilon = 0$.

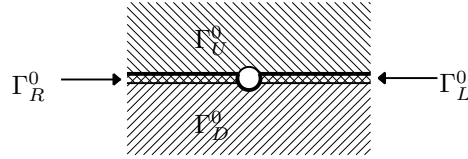

FIGURE 5. Sectorial domains in the t -variable when $\epsilon = 0$.

When $\epsilon \neq 0$, as the function $t(x)$ given by (57) is multivalued, its inverse function $x(t)$ is periodic of period $p = \frac{\pi i}{\sqrt{\epsilon}}$. Hence, the disk of radius r is sent to the exterior of a sequence of deformed circles (of initial radius r^{-1} for $\epsilon = 0$) repeated with period p . To cover the disk, we take two strips (Γ_D^ϵ and Γ_U^ϵ , see Figure 6) in the direction of p of width larger than $\frac{p}{2}$, such that their union is a strip (with a hole) of width w , $p < w < 2p$, containing $\frac{\pm \pi i}{2\sqrt{\epsilon}}$. The singular points in the t -variable are located at infinity in the direction perpendicular to the line of holes. The intersection of the two domains Γ_D^ϵ and Γ_U^ϵ consists of three connected sets: Γ_L^ϵ and Γ_R^ϵ linking a part of the boundary to a singular point, and Γ_C^ϵ linking the two singular points (coming from the periodicity).

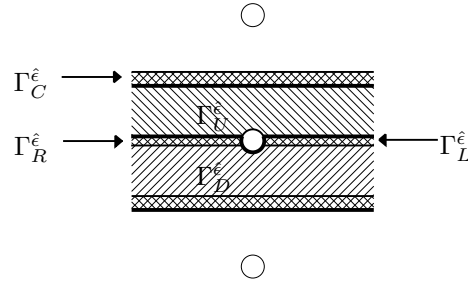

FIGURE 6. Sectorial domains in the t -variable when $\sqrt{\epsilon} \in \mathbb{R}^*$.

For most values of $\hat{\epsilon} \in S$, the line of holes is slanted and we need to slant the strips. If we take pure slanted strips as in Figure 7, we get domains that do not converge when $\hat{\epsilon} \rightarrow 0$ to the sectorial domains at $\epsilon = 0$ (Figure 5). Hence, we take a part of the boundary horizontal on a length $\frac{c}{\sqrt{|\epsilon|}}$ for some fixed $c > 0$ independent of $\hat{\epsilon}$, as illustrated in Figure 8.

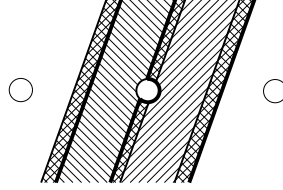

FIGURE 7. Incorrectly slanted sectorial domains in the t -variable.

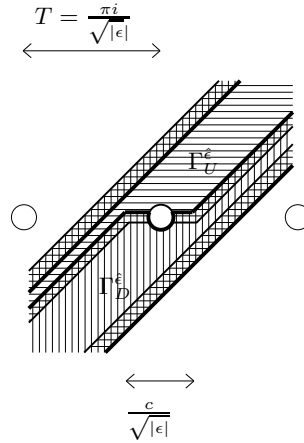

FIGURE 8. Correctly slanted sectorial domains in the t -variable.

Then, we define the sectorial domain $\Omega_s^{\hat{\epsilon}}$ in the x -variable as the one corresponding, via (57), to the sectorial domain in the t -variable $\Gamma_s^{\hat{\epsilon}}$, $s \in \{U, D, L, R, C\}$ (Figures 10 and 11). The points \hat{x}_R and \hat{x}_L are not in the sectorial domains $\Omega_s^{\hat{\epsilon}}$ but in their closure. The region $\Omega_L^{\hat{\epsilon}}$ (respectively $\Omega_R^{\hat{\epsilon}}$) has the singular point \hat{x}_L (respectively \hat{x}_R) in its closure and $\Omega_C^{\hat{\epsilon}}$ has both (Figure 11). Note that the point $x = 0$ belongs to $\Omega_C^{\hat{\epsilon}}$.

In the x -variable, the difference between $\Omega_s^{\hat{\epsilon}}$ and Ω_s^0 ($s = D, U$) is mainly located inside a disk of radius $c'\sqrt{|\epsilon|}$ (Figure 12), due to the non-horizontal part of the boundary of the sectorial domains in the t -variable. Indeed, a slanted half-line going to infinity in the t -variable corresponds to logarithmic spirals approaching a singular point in the x -variable. Quantitative details and proofs can be found in [9]. The construction is possible for all $\hat{\epsilon} \in S$, provided the radius ρ of S is sufficiently small. Indeed, reducing ρ amounts to increase the distance between the holes.

The angle of the slope is chosen as follows. We take

$$(58) \quad \hat{\theta} = \frac{2\gamma}{\pi}(\pi - \arg(\sqrt{\hat{\epsilon}})),$$

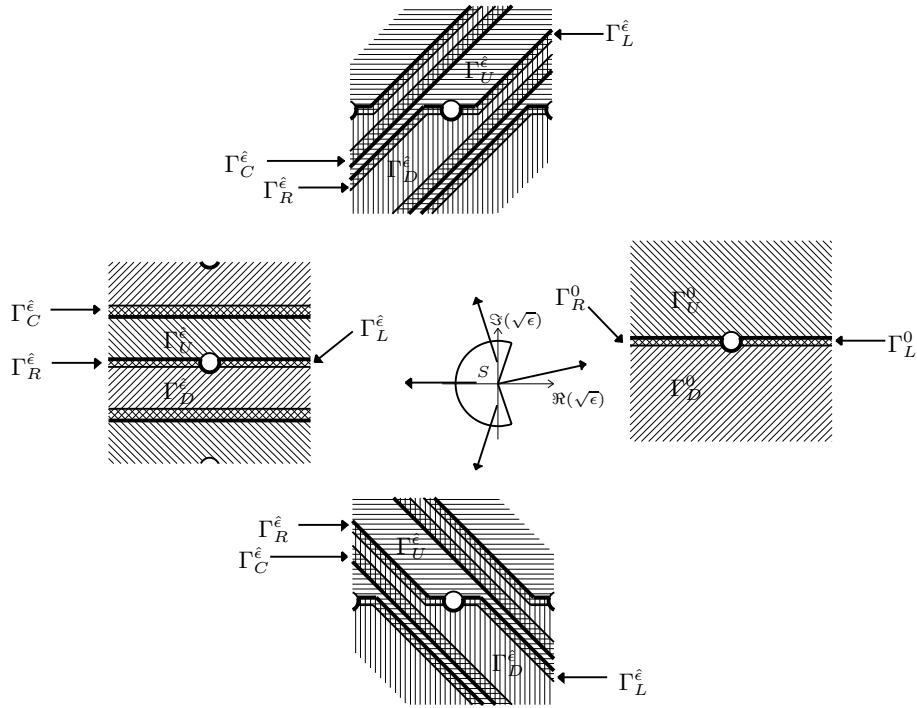

FIGURE 9. Sectorial domains in the t -variable for some values of $\hat{\epsilon} \in S \cup \{0\}$, with $\gamma = \frac{\pi}{4}$.

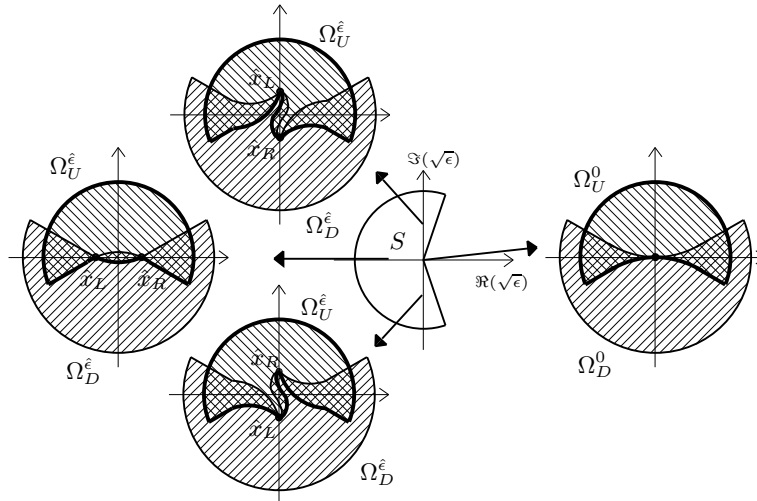

FIGURE 10. Sectorial domains in the x -variable for some values of $\hat{\epsilon} \in S \cup \{0\}$.

with γ as chosen in Definition 4.10. Then, on the trajectories in the x -plane corresponding to $t = Ce^{i\hat{\theta}} + C'$ near the singular points, with $C' \in \mathbb{C}$ fixed for each

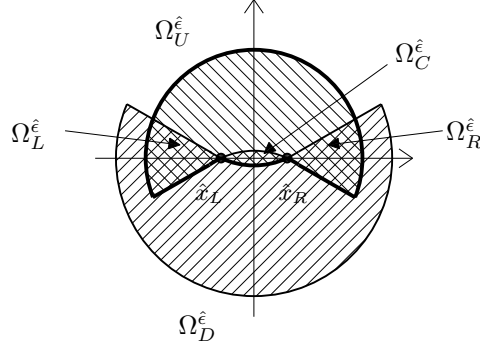

FIGURE 11. The connected components of the intersection of the sectorial domains Ω_D^ϵ and Ω_U^ϵ , case $\sqrt{\epsilon} \in \mathbb{R}_-^*$.

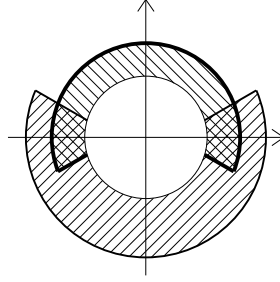

FIGURE 12. Difference between the sectorial domains Ω_s^ϵ and Ω_s^0 mainly located inside a small disk of radius $c'\sqrt{|\epsilon|}$.

trajectory and $C \in \mathbb{R}$, we have

$$(59) \quad \lim_{\substack{x(t) \rightarrow \hat{x}_l \\ t = Ce^{i\theta} + C'}} (x - \hat{x}_R)^{\hat{\mu}_{j,R} - \hat{\mu}_{q,R}} (x - \hat{x}_L)^{\hat{\mu}_{j,L} - \hat{\mu}_{q,L}} = 0, \quad \text{for } \begin{cases} q > j, & \text{if } l = R, \\ q < j, & \text{if } l = L, \end{cases}$$

(this is obtained from the fact that $\Re(e^{i\theta}\sqrt{\epsilon}) < 0$ and that $|\hat{\theta}| < \gamma(1 + 2\frac{\gamma}{\pi})$ with γ satisfying (54)). The limits (59) yield, with $f_j(\epsilon, x)$ given by (32),

$$(60) \quad \lim_{\substack{x \rightarrow \hat{x}_l \\ x \in \Omega_s^\epsilon}} \frac{f_j(\epsilon, x)}{f_q(\epsilon, x)} = 0, \quad \text{for } \begin{cases} q > j, & \text{if } l = R, \\ q < j, & \text{if } l = L. \end{cases}$$

Note that we have a similar behavior when $\epsilon = 0$:

$$(61) \quad \lim_{\substack{x \rightarrow 0 \\ x \in \Omega_l^0}} \frac{f_j(0, x)}{f_q(0, x)} = 0, \quad \text{for } \begin{cases} q > j, & \text{if } l = R, \\ q < j, & \text{if } l = L. \end{cases}$$

4.5. Invariant manifolds in the projective space. In this section, we find an invariant manifold $[y]_j = G_{j,s}(\hat{\epsilon}, x)$ of the j^{th} Riccati system (41) that converges when $\hat{\epsilon} \rightarrow 0$ (in S) to the invariant manifold $[y]_j = G_{j,s}(0, x)$ (Notation 4.7).

The Jacobian of the j^{th} Riccati system at the singular point $(\hat{x}_l, 0)$, $l = L, R$, has eigenvalues

$$(62) \quad 2\hat{x}_l; \lambda_1(\epsilon, \hat{x}_l) - \lambda_j(\epsilon, \hat{x}_l); \dots; (\lambda_j(\epsilon, \hat{x}_l) - \widehat{\lambda_j(\epsilon, \hat{x}_l)}); \dots; \lambda_n(\epsilon, \hat{x}_l) - \lambda_j(\epsilon, \hat{x}_l).$$

For $q \neq j$, the quotient of the eigenvalue in $-\frac{(y)_q}{(y)_j}$ (see Notation 4.5) over the one in x gives $\hat{\mu}_{q,l} - \hat{\mu}_{j,l}$, with $\hat{\mu}_{j,l}$ given by (33).

Definition 4.14. We define the *resonance values* of $\hat{\epsilon}$ as those for which $\hat{\mu}_{q,l} - \hat{\mu}_{j,l} \in \mathbb{N}^*$ for $q \neq j$, $l = L, R$. These are true resonances of the nonlinear Riccati system: they are exactly the values for which there is an obstruction to eliminate the terms $(y)_j(x - \hat{x}_l)^m \frac{\partial}{\partial (y)_q}$ in (25) when localizing the system at $x = \hat{x}_l$. The parameter $\hat{\epsilon}$ has been taken inside a sector which avoids half of these resonances.

Remark 4.15. *All resonance values of the unfolding parameter ϵ can be integrated in a continuous study: the consideration of half of them on the sector S is sufficient since the change of parameter $\hat{\epsilon} = \hat{\epsilon}e^{-2\pi i}$, under which the unfolded systems are invariant, gives the new parameter $\hat{\epsilon}$ in a sector including the other half of the resonance values.*

When $\hat{\epsilon} \in S$, the eigenvalues of the Jacobian, listed in (62), are separated in two distinct groups by a real line passing through the origin. In the proof of Theorem 4.17, we will see that this separation of eigenvalues gives, locally, the existence of invariant manifolds that are tangent to the invariant subspaces of the linearization operator of the vector field at the singular points $(\hat{x}_l, 0)$. We will need the following proposition to extend these local invariant manifolds.

Proposition 4.16. *For $\hat{\epsilon} \in S$, let us define the region*

$$(63) \quad \mathcal{V}_{\hat{\epsilon}}^j = \mathcal{V}_{\hat{\epsilon},+}^j \cap \mathcal{V}_{\hat{\epsilon},-}^j,$$

with

$$(64) \quad \mathcal{V}_{\hat{\epsilon},\pm}^j = \left\{ (x, [y]_j) \in \mathbb{C} \times \mathbb{C}\mathbb{P}^{n-1} : \left| \frac{(y)_i}{(y)_j} \right| \leq |x \pm \sqrt{\hat{\epsilon}}|, i \in \{1, 2, \dots, n\} \setminus \{j\} \right\}.$$

The boundary of $\mathcal{V}_{\hat{\epsilon},\pm}^j$ is $\bigcup_{\substack{i=1 \\ i \neq j}}^n \mathcal{V}_{\hat{\epsilon},\pm,i}^j$, with, for $i \neq j$,

$$(65) \quad \mathcal{V}_{\hat{\epsilon},\pm,i}^j = \left\{ (x, [y]_j) \in \mathbb{C} \times \mathbb{C}\mathbb{P}^{n-1} : \left| \frac{(y)_i}{(y)_j} \right| = |x \pm \sqrt{\hat{\epsilon}}|, \left| \frac{(y)_k}{(y)_j} \right| \leq |x \pm \sqrt{\hat{\epsilon}}| \text{ if } k \neq i, j \right\}.$$

We can take the radius of S sufficiently small so that

$$(66) \quad \left| \frac{d}{dt} |x \pm \sqrt{\hat{\epsilon}}|^2 \right| < \left| \frac{d}{dt} \left| \frac{(y)_i}{(y)_j} \right|^2 \right|, \quad \text{for } \begin{cases} (x, [y]_j) \in \mathcal{V}_{\hat{\epsilon},\pm,i}^j, \\ x \in \Omega_s^{\hat{\epsilon}}, & s = D, U, \\ \hat{\epsilon} \in S, \\ i, j \in \{1, \dots, n\}, & i \neq j. \end{cases}$$

Proof. Similarly to the proof of Proposition 4.8, we consider (39) and we have, either with the upper or the lower sign,

$$(67) \quad \left| \frac{1}{2} \frac{d}{dt} |x \pm \sqrt{\hat{\epsilon}}|^2 \right| \leq |x \pm \sqrt{\hat{\epsilon}}|^2 |x \mp \sqrt{\hat{\epsilon}}|.$$

On $\mathcal{V}_{\hat{\epsilon}, \pm, i}^j$, we have

$$(68) \quad \frac{1}{2|x \pm \sqrt{\hat{\epsilon}}|^2} \left| \frac{d}{dt} \left| \frac{(y)_i}{(y)_j} \right|^2 \right| \geq |\Re(\lambda_{i,0}(\epsilon) - \lambda_{j,0}(\epsilon))| - v_{ij}^{\pm}(\hat{\epsilon}, x),$$

with

$$(69) \quad v_{ij}^{\pm}(\hat{\epsilon}, x) = |\lambda_{i,1}(\epsilon) - \lambda_{j,1}(\epsilon)||x| + |x \mp \sqrt{\hat{\epsilon}}| |(R(\epsilon, x))_{ij}| \\ + |x^2 - \epsilon| \left(|(R(\epsilon, x))_{jj}| + \sum_{\substack{k=1 \\ k \neq j}}^n (|(R(\epsilon, x))_{ik}| + |x \pm \sqrt{\hat{\epsilon}}| |(R(\epsilon, x))_{jk}|) \right).$$

Let us take α such that

$$(70) \quad \alpha \leq \eta |\Re(\lambda_{i,0}(0) - \lambda_{j,0}(0))|, \quad \forall i \neq j,$$

with η as chosen in Proposition 4.8. We restrict the radius of S to $\rho > 0$ such that

$$(71) \quad \left| |\Re(\lambda_{i,0}(\epsilon) - \lambda_{j,0}(\epsilon))| - |\Re(\lambda_{i,0}(0) - \lambda_{j,0}(0))| \right| < \frac{\alpha}{2}$$

and such that

$$(72) \quad |v_{ij}^{\pm}(\hat{\epsilon}, x) + |x \mp \sqrt{\hat{\epsilon}}| - |x| - v_{ij}(0, x)| < \frac{\alpha}{2}, \quad \forall i \neq j,$$

implying

$$(73) \quad v_{ij}^{\pm}(\hat{\epsilon}, x) + |x \mp \sqrt{\hat{\epsilon}}| < |\Re(\lambda_{i,0}(\epsilon) - \lambda_{j,0}(\epsilon))|, \quad \forall \hat{\epsilon} \in S, \quad \forall i \neq j.$$

This yields (66). \square

Using Proposition 4.16, we now define the graph $x \mapsto G_{j,s}(\hat{\epsilon}, x)$ as consisting of the union of all solutions, parametrized by curves in complex time of the j^{th} Riccati system, that are confined inside the region $\mathcal{V}_{\hat{\epsilon}}^j$ when restricted to the sectors $\Omega_s^{\hat{\epsilon}}$:

Theorem 4.17. *In the j^{th} Riccati system, there exists, for $\hat{\epsilon} \in S$, a unique one-dimensional invariant manifold $[y]_j = \hat{G}_{j,s}(x) = G_{j,s}(\hat{\epsilon}, x)$, given as the graph of an analytic function $\hat{G}_{j,s}(x)$ with a continuous extension at $(\hat{x}_l, 0)$, $l = L, R$, passing through the two singular points $(x, [y]_j) = (\hat{x}_l, 0)$, $l = L, R$, and located inside the region $\mathcal{V}_{\hat{\epsilon}}^j$ over the sector $\Omega_s^{\hat{\epsilon}}$. $G_{j,s}(\hat{\epsilon}, x)$ depends analytically on $(\hat{\epsilon}, x)$ for $\hat{\epsilon} \in S$ and $x \in \Omega_s^{\hat{\epsilon}}$.*

Proof. We always take x inside the sectorial domain $\Omega_s^{\hat{\epsilon}}$ and we omit the lower index s within the proof : we write simply $G_j(\hat{\epsilon}, x)$.

Let us take the first Riccati system and fix $\epsilon_0 \in S$. The choice of S allows to separate, by a real line passing through the origin, the eigenvalue $2\hat{x}_R$ from the other eigenvalues at $(\hat{x}_R, 0)$ given by (62). From the Hadamard-Perron theorem for holomorphic flows (see [5] p. 106), there exist holomorphic invariant manifolds $\mathcal{W}_{\hat{x}_R, 1}^+$ and $\mathcal{W}_{\hat{x}_R, 1}^-$ tangent to the invariant subspaces of the linearization operator of the vector field at $(\hat{x}_R, 0)$. We denote by $[y]_1 = G_1(\epsilon_0, x)$ the unique one-dimensional invariant manifold $\mathcal{W}_{\hat{x}_R, 1}^+$. Near $x = \hat{x}_R$, it is the unique invariant manifold contained inside the region $\mathcal{V}_{\epsilon_0}^j$ (defined by (63)) and its extension cannot escape from $\mathcal{V}_{\epsilon_0}^j$, by Proposition 4.16.

Similarly, in the n^{th} Riccati system, we take $[y]_n = G_n(\epsilon_0, x)$ as the extension of the unique holomorphic one-dimensional invariant manifold $\mathcal{W}_{\hat{x}_L, n}^-$ passing through $(\hat{x}_L, 0)$.

Now, let us take the j^{th} Riccati system, with $1 < j < n$. Around $x = \hat{x}_R$ (respectively $x = \hat{x}_L$), we have two invariant manifolds $\mathcal{W}_{\hat{x}_R,j}^+$ and $\mathcal{W}_{\hat{x}_R,j}^-$ of dimension j and $n - j$ (respectively $\mathcal{W}_{\hat{x}_L,j}^+$ and $\mathcal{W}_{\hat{x}_L,j}^-$ of dimension $j - 1$ and $n - j + 1$) tangent to the corresponding invariant subspaces of the linearization operator of the vector field. We analytically extend the invariant manifold $\mathcal{W}_{\hat{x}_R,j}^+$ tangent to $(x, \frac{(y)_1}{(y)_j}, \dots, \frac{(y)_{j-1}}{(y)_j})$ at $(\hat{x}_R, 0)$ towards the singular point $x = \hat{x}_L$. Proposition 4.16 implies that any solution (with complex time) of this extended invariant manifold cannot exit $\mathcal{V}_{\epsilon_0}^j$ by the part of its boundary consisting of the $\mathcal{V}_{\epsilon_0,\pm,i}^j$ for $i \geq j + 1$. Near $x = \hat{x}_L$, the extension of $\mathcal{W}_{\hat{x}_R,j}^+$ must then intersect the invariant manifold $\mathcal{W}_{\hat{x}_L,j}^-$, which is tangent to $(x, \frac{(y)_{j+1}}{(y)_j}, \dots, \frac{(y)_n}{(y)_j})$. From the form of the manifolds as graphs, the intersection is transversal, and hence a one-dimensional invariant manifold denoted $[y]_j = G_j(\epsilon_0, x)$ passing through the singular points and nonsingular outside the singular points.

In each Riccati system, we thus have one-dimensional invariant manifolds $[y]_j = G_j(\epsilon_0, x)$ confined inside $\mathcal{V}_{\epsilon_0}^j$. Near $\epsilon_0 \neq 0$, $\mathcal{W}_{\hat{x}_L,j}^\pm$ depends analytically on ϵ , implying that the unique solution $[y]_j = G_j(\hat{\epsilon}, x)$ is analytic in $\hat{\epsilon}$ for $\hat{\epsilon} \in S$. \square

Remark 4.18. *The invariant manifolds $[y]_1 = G_{1,s}(\hat{\epsilon}, x)$ and $[y]_n = G_{n,s}(\hat{\epsilon}, x)$ are uniform respectively near \hat{x}_R and near \hat{x}_L , whereas $[y]_j = G_{j,s}(\hat{\epsilon}, x)$ is ramified at the two singular points. More precisely, $G_{j,U}(\hat{\epsilon}, x) = G_{j,D}(\hat{\epsilon}, x)$ over Ω_C^ϵ (Figure 11) for $j = 1, 2, \dots, n$, $G_{1,U}(\hat{\epsilon}, x) = G_{1,D}(\hat{\epsilon}, x)$ over Ω_R^ϵ and $G_{n,U}(\hat{\epsilon}, x) = G_{n,D}(\hat{\epsilon}, x)$ over Ω_L^ϵ .*

Solutions in the invariant manifold $[y]_j = G_{j,s}(\hat{\epsilon}, x)$ behave differently from the other solutions of the j^{th} Riccati system, since they are the only ones that are bounded when $x \rightarrow \hat{x}_R$ and $x \rightarrow \hat{x}_L$ over Ω_s^ϵ . The fact that an invariant manifold $[y]_j = G_{j,s}(\hat{\epsilon}, x)$ is bounded over the region \mathcal{V}_ϵ^j leads to its uniform convergence on compact sets of Ω_s^0 :

Theorem 4.19. *The invariant manifold $[y]_j = G_{j,s}(\hat{\epsilon}, x)$ converges uniformly on compact subsets of Ω_s^0 , when $\hat{\epsilon} \rightarrow 0$, $\hat{\epsilon} \in S$, to the invariant manifold at $\epsilon = 0$ $[y]_j = G_{j,s}(0, x)$ (see Notation 4.7), for $s = D, U$.*

Proof. Let us take a simply connected compact subset of Ω_s^0 . For $|\epsilon|$ sufficiently small, it does not contain neither \hat{x}_R nor \hat{x}_L , nor the spiraling part of Ω_s^ϵ . Proposition 4.16 implies that the invariant manifold $[y]_j = G_{j,s}(\hat{\epsilon}, x)$ satisfies

$$(74) \quad |(G_{j,s}(\hat{\epsilon}, x))_i| < \min\{|x - \hat{x}_R|, |x - \hat{x}_L|\}, \quad \text{with} \quad \begin{cases} x \in \Omega_s^\epsilon, & s = D, U, \\ \hat{\epsilon} \in S, \\ i = 1, 2, \dots, n - 1. \end{cases}$$

This implies the desired convergence to a bounded solution of the system for $\epsilon = 0$ that can only be $[y]_j = G_{j,s}(x, 0)$. \square

4.6. Basis of the linear system (25). In this section, we establish the correspondence between the invariant manifold $[y]_j = G_{j,s}(\hat{\epsilon}, x)$ of the j^{th} Riccati system (41) and multiples (by a complex constant) of a particular solution of the linear system (25). We show that these n particular solutions form a basis of solutions of the linear system which is valid for all values of $\hat{\epsilon} \in S$ and $x \in \Omega_s^\epsilon$.

Notation 4.20. Let $F_D(\hat{\epsilon}, x)$ be the restriction to $\Omega_D^{\hat{\epsilon}}$ of the fundamental matrix of solutions of the model system $F(\epsilon, x)$ (given by (32)), and let $F_U(\hat{\epsilon}, x)$ be its analytic continuation to $\Omega_U^{\hat{\epsilon}}$, passing through $\Omega_R^{\hat{\epsilon}}$.

Remark 4.21. *The matrix $F_s(\hat{\epsilon}, x)$ is uniform over $\Omega_s^{\hat{\epsilon}}$, $s = D, U$, and according to Notation 4.20, we have*

$$(75) \quad F_U(\hat{\epsilon}, x) = \begin{cases} F_D(\hat{\epsilon}, x), & \text{on } \Omega_R^{\hat{\epsilon}}, \\ F_D(\hat{\epsilon}, x)e^{2\pi i\Lambda_1(\epsilon)}, & \text{on } \Omega_L^{\hat{\epsilon}}, \\ F_D(\hat{\epsilon}, x)\hat{D}_R^{-1}, & \text{on } \Omega_C^{\hat{\epsilon}}, \end{cases}$$

with \hat{D}_R given by (34) and $\Lambda_1(\epsilon)$ by (28), satisfying (36).

Theorem 4.22. *Let $s = D, U$. There exists a fundamental matrix of solutions of (25) that can be written as*

$$(76) \quad W_s(\hat{\epsilon}, x) = H_s(\hat{\epsilon}, x)F_s(\hat{\epsilon}, x), \quad (\hat{\epsilon}, x) \in S \times \Omega_s^{\hat{\epsilon}},$$

with H_s analytic in $(\hat{\epsilon}, x)$ on $S \times \Omega_s^{\hat{\epsilon}}$, satisfying

$$(77) \quad |H_s(\bar{\epsilon}, 0) - H_s(\tilde{\epsilon}, 0)| \leq c|\bar{\epsilon}|, \quad \text{for some } c \in \mathbb{R}_+, \quad \bar{\epsilon}, \tilde{\epsilon} = \bar{\epsilon}e^{2\pi i} \in S_{\cap} \cup \{0\},$$

$$(78) \quad |H_s(\hat{\epsilon}, 0)| \text{ and } |H_s(\hat{\epsilon}, 0)^{-1}| \text{ are bounded, } \quad \hat{\epsilon} \in S_{\cap},$$

and

$$(79) \quad \lim_{\substack{x \rightarrow \hat{x}_l \\ x \in \Omega_s^{\hat{\epsilon}}}} H_s(\hat{\epsilon}, x) = \hat{K}_l, \quad \hat{\epsilon} \in S, l = L, R,$$

where \hat{K}_l is an invertible diagonal matrix depending analytically on $\hat{\epsilon} \in S$ with a nonsingular limit at $\epsilon = 0$ (independent of s).

Proof. The proof is valid for $s = D$ or $s = U$. For our needs, we write $[y]_j = G_{j,s}(\hat{\epsilon}, x)$ on $\Omega_s^{\hat{\epsilon}}$ as

$$(80) \quad \begin{cases} \frac{-(y)_k}{(y)_j} & = g_{kj,s}(\hat{\epsilon}, x), \\ -1 & = g_{jj,s}(\hat{\epsilon}, x). \end{cases}$$

With (25), we can write

$$(81) \quad (y')_j = \frac{\lambda_j(\epsilon, x)}{x^2 - \epsilon}(y)_j + \sum_{k=1}^n (R(\epsilon, x))_{jk}(y)_k.$$

Dividing by $(y)_j$, the known solutions of the j^{th} Riccati system appear in the right hand side:

$$(82) \quad \frac{(y')_j}{(y)_j} = -\frac{\lambda_j(\epsilon, x)}{x^2 - \epsilon}g_{jj,s}(\hat{\epsilon}, x) - \sum_{k=1}^n (R(\epsilon, x))_{jk}g_{kj,s}(\hat{\epsilon}, x).$$

The integration of equation (82) allows to recover $(y)_j$ and relation (80) leads to the other $(y)_k$, thus yielding a solution $w_{j,s}(\hat{\epsilon}, x)$ of the linear system (25) (and all its multiples by a complex constant) that can be written as

$$(83) \quad w_{j,s}(\hat{\epsilon}, x) = f_{j,s}(\hat{\epsilon}, x)h_{j,s}(\hat{\epsilon}, x),$$

with $f_{j,s}(\hat{\epsilon}, x)$ the j^{th} diagonal element of $F_s(\hat{\epsilon}, x)$ (see Notation 4.20), and with

$$(84) \quad (h_{j,s}(\hat{\epsilon}, x))_k = -e^{-\int_0^x \sum_{p=1}^n (R(\epsilon, x))_{jp}g_{pj,s}(\hat{\epsilon}, x)dx} g_{kj,s}(\hat{\epsilon}, x),$$

where the integration path is taken inside $\Omega_s^{\hat{\epsilon}}$. Such a path can be found in the t -variable (see Section 4.4) since $t(0) \in \Gamma_C^{\hat{\epsilon}}$. With the n Riccati systems, we obtain in this way n solutions $w_{j,s}(\hat{\epsilon}, x)$ of the linear system (25) defined for $\hat{\epsilon} \in S$ and $x \in \Omega_s^{\hat{\epsilon}}$. We take

$$(85) \quad W_s(\hat{\epsilon}, x) = [w_{1,s}(\hat{\epsilon}, x) \dots w_{n,s}(\hat{\epsilon}, x)]$$

and

$$(86) \quad H_s(\hat{\epsilon}, x) = [h_{1,s}(\hat{\epsilon}, x) \dots h_{n,s}(\hat{\epsilon}, x)]$$

to obtain (76) from (83). The limit (79) follows from

$$(87) \quad \lim_{\substack{x \rightarrow \hat{x}_l \\ x \in \Omega_s^{\hat{\epsilon}}}} g_{kj,s}(\hat{\epsilon}, x) = 0, \quad k \neq j, \quad l = L, R,$$

and

$$(88) \quad (\hat{\mathcal{K}}_l)_{jj} = \lim_{x \rightarrow \hat{x}_l} (h_{j,s}(\hat{\epsilon}, x))_j = e^{-\int_0^{\hat{x}_l} \sum_{p=1}^n (R(\epsilon, x))_{jp} g_{pj,s}(\hat{\epsilon}, x) dx},$$

which is independent of s since the integration path in (88) may be taken inside $\Omega_C^{\hat{\epsilon}}$ (see Remark 4.18).

The solutions $w_{1,s}(\hat{\epsilon}, x), \dots, w_{n,s}(\hat{\epsilon}, x)$ form a basis of solutions since the columns of $F_s(\hat{\epsilon}, x)$ are linearly independent and since $\hat{\mathcal{K}}_l$ in (79) is invertible.

The property (78) comes from (74) and (88). Let us now prove (77). From its definition, $H_s(\hat{\epsilon}, 0)F_s(\hat{\epsilon}, 0)$ is a solution of (25) at $x = 0$, so

$$(89) \quad \Lambda(\epsilon, 0)H_s(\hat{\epsilon}, 0) - H_s(\hat{\epsilon}, 0)\Lambda(\epsilon, 0) = -\epsilon(H'_s(\hat{\epsilon}, 0) - R(\epsilon, 0)H_s(\hat{\epsilon}, 0)).$$

With $\bar{\epsilon}$ and $\tilde{\epsilon}$ in S_\cap (see Notation 4.12), we thus have

$$(90) \quad \begin{aligned} & \Lambda(\epsilon, 0)(H_s(\bar{\epsilon}, 0) - H_s(\tilde{\epsilon}, 0)) - (H_s(\bar{\epsilon}, 0) - H_s(\tilde{\epsilon}, 0))\Lambda(\epsilon, 0) \\ &= -\epsilon(H'_s(\bar{\epsilon}, 0) - H'_s(\tilde{\epsilon}, 0) - R(\epsilon, 0)(H_s(\bar{\epsilon}, 0) - H_s(\tilde{\epsilon}, 0))), \end{aligned}$$

yielding, for some $k \in \mathbb{R}_+$,

$$(91) \quad |(H_s(\bar{\epsilon}, 0) - H_s(\tilde{\epsilon}, 0))_{jq}| \leq k|\bar{\epsilon}|, \quad j \neq q, \quad \bar{\epsilon} \in S_\cap \cup \{0\}, \quad i = 1, 2,$$

by the boundedness of $|H'_s(\bar{\epsilon}, 0) - H'_s(\tilde{\epsilon}, 0)|$, $|R(\epsilon, 0)|$ and $|H_s(\bar{\epsilon}, 0) - H_s(\tilde{\epsilon}, 0)|$ over $S_\cap \cup \{0\}$ (recall that $\Lambda(\epsilon, 0)$ has distinct eigenvalues for $\epsilon \in S \cup \{0\}$). Relation (77) comes from (91) and from the fact that the diagonal entries of $H_s(\bar{\epsilon}, 0) - H_s(\tilde{\epsilon}, 0)$ are zeros (since $(H_s(\hat{\epsilon}, 0))_{jj} = 1$). \square

Corollary 4.23. *Let $s = D, U$. There exists a transformation $y = H_s(\hat{\epsilon}, x)z$, with $H_s(\hat{\epsilon}, x)$ given by Theorem 4.22, conjugating the system (25) to its model (30) over $\Omega_s^{\hat{\epsilon}}$, for $\hat{\epsilon} \in S \cup \{0\}$.*

We have seen that the solutions in the invariant manifold $[y]_j = G_{j,s}(\hat{\epsilon}, x)$ converge uniformly on compact sets of Ω_s^0 when $\hat{\epsilon} \rightarrow 0$. This property remains for the corresponding solutions of the linear system:

Corollary 4.24 (of Theorem 4.19). *When $\hat{\epsilon} \rightarrow 0$, the fundamental matrix $W_s(\hat{\epsilon}, x)$ converges (uniformly on compact sets of Ω_s^0) to the fundamental matrix $W_s(0, x)$ defined in (43), $s = D, U$.*

Proof. From (76) and the convergence of $F(\hat{\epsilon}, x)$ to $F(0, x)$, it suffices to prove the desired convergence of $H_s(\hat{\epsilon}, x)$. This is immediate, since each column has an expression in terms of the solution $[y]_j = G_{j,s}(\hat{\epsilon}, x)$ as in (84), using the notation (80). \square

The bases $W_D(\hat{\epsilon}, x)$ and $W_U(\hat{\epsilon}, x)$ defined respectively on $\Omega_D^{\hat{\epsilon}}$ and $\Omega_U^{\hat{\epsilon}}$ will allow the calculation of the analytic invariants of the linear system.

4.7. Definition of the unfolded Stokes matrices. In this section, we define the unfolded Stokes matrices by comparing the fundamental matrices of solutions $W_D(\hat{\epsilon}, x)$ and $W_U(\hat{\epsilon}, x)$ on the connected components of the intersection of $\Omega_D^{\hat{\epsilon}}$ and $\Omega_U^{\hat{\epsilon}}$ (Figure 11).

Theorem 4.25. *There exist matrices \hat{C}_R and \hat{C}_L such that*

$$(92) \quad H_D(\hat{\epsilon}, x)^{-1} H_U(\hat{\epsilon}, x) = \begin{cases} F_D(\hat{\epsilon}, x) \hat{C}_R (F_D(\hat{\epsilon}, x))^{-1}, & \text{on } \Omega_R^{\hat{\epsilon}}, \\ F_D(\hat{\epsilon}, x) \hat{C}_L (F_D(\hat{\epsilon}, x))^{-1}, & \text{on } \Omega_L^{\hat{\epsilon}}, \\ I, & \text{on } \Omega_C^{\hat{\epsilon}}. \end{cases}$$

\hat{C}_R and \hat{C}_L are respectively an upper triangular and a lower triangular unipotent matrix. They depend analytically on $\hat{\epsilon} \in S$ and converge when $\hat{\epsilon} \rightarrow 0$ ($\hat{\epsilon} \in S$) to the Stokes matrices defined by (13).

Proof. As $W_D(\hat{\epsilon}, x)$ and $W_U(\hat{\epsilon}, x)$ are two fundamental matrices of solutions on the intersection of $\Omega_D^{\hat{\epsilon}}$ and $\Omega_U^{\hat{\epsilon}}$ (see Theorem 4.22), there exist matrices expressing the fact that columns of $W_U(\hat{\epsilon}, x)$ are linear combinations of columns of $W_D(\hat{\epsilon}, x)$ on the intersection parts $\Omega_L^{\hat{\epsilon}}$, $\Omega_R^{\hat{\epsilon}}$ and $\Omega_C^{\hat{\epsilon}}$. With (75) and (76), these relations become equivalent to

$$(93) \quad H_D(\hat{\epsilon}, x)^{-1} H_U(\hat{\epsilon}, x) = \begin{cases} F_D(\hat{\epsilon}, x) \hat{C}_R (F_D(\hat{\epsilon}, x))^{-1} & \text{on } \Omega_R^{\hat{\epsilon}} \\ F_D(\hat{\epsilon}, x) \hat{C}_L (F_D(\hat{\epsilon}, x))^{-1} & \text{on } \Omega_L^{\hat{\epsilon}} \\ F_D(\hat{\epsilon}, x) \hat{C}_0 (F_D(\hat{\epsilon}, x))^{-1} & \text{on } \Omega_C^{\hat{\epsilon}}. \end{cases}$$

Then, taking the limit $x \rightarrow \hat{x}_L$ on $\Omega_L^{\hat{\epsilon}}$, $x \rightarrow \hat{x}_R$ on $\Omega_R^{\hat{\epsilon}}$ and both limits on $\Omega_C^{\hat{\epsilon}}$ leads, with (60) and (79), to $\hat{C}_0 = I$ and to the unipotent triangular form of the matrices \hat{C}_R and \hat{C}_L . Since $W_s(\hat{\epsilon}, x)$ and $F_s(\hat{\epsilon}, x)$ converge uniformly on compact sets of Ω_s^0 (see Corollary 4.19 and Remark 4.2), so does $H_s(\hat{\epsilon}, x)$. Then, the matrices \hat{C}_R and \hat{C}_L must converge to the Stokes matrices when $\hat{\epsilon} \rightarrow 0$, $\hat{\epsilon} \in S$. \square

Definition 4.26. We call \hat{C}_R and \hat{C}_L (defined by (92)) the *unfolded Stokes matrices* and $\{\hat{C}_R, \hat{C}_L\}$ an *unfolded Stokes collection*.

Proposition 4.27. *A fundamental matrix of solutions of (25) that can be written as (76), with $H_s(\hat{\epsilon}, x)$ analytic on $S \times \Omega_s^{\hat{\epsilon}}$, satisfying (77), (78) and with a limit when $x \rightarrow \hat{x}_l$, $x \in \Omega_s^{\hat{\epsilon}}$ that is bounded, invertible and independent of s , is unique up to right multiplication by any nonsingular diagonal matrix \hat{K} depending analytically on $\hat{\epsilon} \in S$ with a nonsingular limit at $\epsilon = 0$ and such that*

$$(94) \quad |\tilde{K} - \hat{K}| \leq c|\bar{\epsilon}| \quad \text{over } S_{\cap}, \text{ for some } c \in \mathbb{R}_+.$$

Proof. Let us suppose that we have two fundamental matrices of solutions that can be written as $H_s(\hat{\epsilon}, x)F_s(\hat{\epsilon}, x)$ and $H_s^*(\hat{\epsilon}, x)F_s(\hat{\epsilon}, x)$ with properties listed in the proposition. Since we have two bases of solutions over $\Omega_C^{\hat{\epsilon}}$, there exists a matrix \hat{K} such that

$$(95) \quad H_s^*(\hat{\epsilon}, x)F_s(\hat{\epsilon}, x) = H_s(\hat{\epsilon}, x)F_s(\hat{\epsilon}, x)\hat{K}, \quad x \in \Omega_C^{\hat{\epsilon}}.$$

Since the limits when $x \rightarrow \hat{x}_l$, $l = L, R$, of $H_s(\hat{\epsilon}, x)$ and of $H_s^*(\hat{\epsilon}, x)$ are bounded and invertible, \hat{K} must be a diagonal matrix. Then, we have

$$(96) \quad H_s(\hat{\epsilon}, x)^{-1} H_s^*(\hat{\epsilon}, x) = \hat{K}, \quad x \in \Omega_C^\epsilon,$$

and in particular

$$(97) \quad H_s(\hat{\epsilon}, 0)^{-1} H_s^*(\hat{\epsilon}, 0) = \hat{K}.$$

From (97), (77) and (78), we obtain (94). \square

As the uniqueness of $W_s(\hat{\epsilon}, x)$ is ensured by the choice of a nonsingular diagonal matrix \hat{K} having properties listed in Proposition 4.27, it is natural to adopt the following definition:

Definition 4.28. Two unfolded Stokes collections, $\{\hat{C}_R, \hat{C}_L\}$ and $\{\hat{C}'_R, \hat{C}'_L\}$ (see Definition 4.26), are *equivalent* if

$$(98) \quad \hat{C}'_l = \hat{K} \hat{C}_l \hat{K}^{-1}, \quad l = L, R,$$

for some nonsingular diagonal matrix \hat{K} depending analytically on $\hat{\epsilon} \in S$ with a nonsingular limit at $\epsilon = 0$ and such that (94) is satisfied.

Using results obtained from the study of the monodromy of the solutions, we will prove in Section 4.13 that these equivalence classes of unfolded Stokes collections constitute the analytic part of the complete system of invariants for the systems (25).

4.8. Unfolded Stokes matrices and monodromy in the linear system. In this section, we show how the unfolded Stokes matrices are linked to the monodromy operator acting on $W_s(\hat{\epsilon}, x)$, how they give information on the existence of the bases of solutions composed of eigenvectors of the monodromy operator, and how they provide a meaning to the Stokes matrices at $\epsilon = 0$.

To study the action of the monodromy operator, we consider the ramified domain

$$(99) \quad V^\epsilon = \Omega_D^\epsilon \cup \Omega_U^\epsilon,$$

illustrated in Figure 13, which could have a (non illustrated) spiraling part around \hat{x}_R and \hat{x}_L .

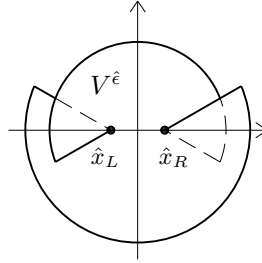

FIGURE 13. Domain of $H(\hat{\epsilon}, x)$, denoted V^ϵ , case $\sqrt{\hat{\epsilon}} \in \mathbb{R}_*$.

Notation 4.29. Let $F_V(\hat{\epsilon}, x)$ be the analytic continuation of $F_D(\hat{\epsilon}, x)$ from Ω_D^ϵ to V^ϵ (through Ω_C^ϵ).

The well chosen basis of solutions we consider on this domain is the analytic continuation of $W_D(\hat{\epsilon}, x)$ from $\Omega_D^{\hat{\epsilon}}$ to $V^{\hat{\epsilon}}$, that we write as

$$(100) \quad W_V(\hat{\epsilon}, x) = [w_1(\hat{\epsilon}, x) \dots w_n(\hat{\epsilon}, x)] = H(\hat{\epsilon}, x)F_V(\hat{\epsilon}, x),$$

where

$$(101) \quad H(\hat{\epsilon}, x) = \begin{cases} H_D(\hat{\epsilon}, x), & \text{on } \Omega_D^{\hat{\epsilon}}, \\ H_U(\hat{\epsilon}, x), & \text{on } \Omega_U^{\hat{\epsilon}}, \end{cases}$$

which is well-defined because of (92).

The fundamental group of $\mathbb{D}_r \setminus \{x_R, x_L\}$ based at a nonsingular point acts on a solution (valid at this base point) by giving its analytic continuation at the end of a loop. In this way we have monodromy operators around each singular point $x = x_l$. We can extend this action of the fundamental group to any function of the solutions. When the monodromy operator acts on a fundamental matrix of solutions W , it is represented by a matrix acting by right multiplication on W .

Notation 4.30. Let us take the fundamental group of $\mathbb{D}_r \setminus \{x_R, x_L\}$ based, independently of $\hat{\epsilon} \in S$, at a point belonging to $\Omega_R^{\hat{\epsilon}}$ (respectively $\Omega_L^{\hat{\epsilon}}$) and taken on $\Omega_D^{\hat{\epsilon}}$. We denote $M_{\hat{x}_R}$ (respectively $M_{\hat{x}_L}$) the monodromy operator associated to the loop which makes one turn around the singular point $x = \hat{x}_R$ (respectively $x = \hat{x}_L$) in the negative (respectively positive) direction and which does not surround any other singular point (see Figure 14).

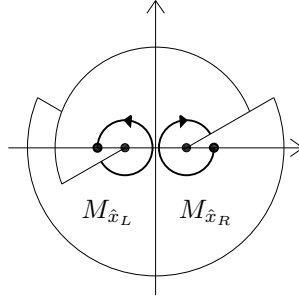

FIGURE 14. Illustration of the definition of the monodromy operators $M_{\hat{x}_L}$ and $M_{\hat{x}_R}$, case $\hat{x}_L = \sqrt{\hat{\epsilon}} \in \mathbb{R}_-^*$.

Proposition 4.31. *For $l = L, R$, the action of the monodromy operator $M_{\hat{x}_l}$ on $W_V(\hat{\epsilon}, x)$ is represented by the matrix \hat{m}_l satisfying*

$$(102) \quad \hat{m}_l = \hat{C}_l \hat{D}_l,$$

where \hat{C}_l is the unfolded Stokes matrix defined by (92) and \hat{D}_l , given by (34), is the matrix representing the action of the monodromy operator $M_{\hat{x}_l}$ on the fundamental matrix of solutions $F_V(\hat{\epsilon}, x)$ of the model system.

Proof. Starting on $\Omega_R^{\hat{\epsilon}}$, the operator $M_{\hat{x}_R}$ acting on $W_V(\hat{\epsilon}, x) = H_D(\hat{\epsilon}, x)F_D(\hat{\epsilon}, x)$ gives $H_U(\hat{\epsilon}, x)F_D(\hat{\epsilon}, x)\hat{D}_R$. Starting on $\Omega_L^{\hat{\epsilon}}$, the operator $M_{\hat{x}_L}$ acting on $W_V(\hat{\epsilon}, x) = H_D(\hat{\epsilon}, x)F_D(\hat{\epsilon}, x)$ gives $H_U(\hat{\epsilon}, x)F_D(\hat{\epsilon}, x)\hat{D}_L$. As we have (92), equation (102) is verified for $l = L, R$. \square

Notation 4.32. The j^{th} row (respectively column) of a matrix will be called *trivial* if it corresponds to the j^{th} row (respectively column) of the identity matrix.

Remark 4.33. *Relation (102) gives a geometric meaning to zeros in unfolded Stokes matrices \hat{C}_l . For example, if a permutation P is such that $P\hat{C}_lP^{-1}$ is in a block diagonal form, it indicates a decomposition of the solution space into invariant subspaces under the action of the monodromy operator $M_{\hat{x}_l}$. A trivial j^{th} column (see Notation 4.32) of \hat{C}_l points out that $w_j(\hat{\epsilon}, x)$ is eigenvector of $M_{\hat{x}_l}$. If an unfolded Stokes matrix \hat{C}_l is equal to the identity, it would imply that all the columns of $W_V(\hat{\epsilon}, x)$ are eigenvectors of $M_{\hat{x}_l}$.*

Via the Jordan normal form of the monodromy matrix $\hat{C}_l\hat{D}_l$, we will now express how the entries of the unfolded Stokes matrices are linked to the existence of the solutions that are eigenvectors of the monodromy operator around the singular points. This will give a geometric interpretation to the entries of $\hat{C}_l = C_l(\hat{\epsilon})$ and, in particular, of their limits, the entries of $C_l = C_l(0)$.

Theorem 4.34. *$t \in \mathbb{C}^n$ is an eigenvector of the monodromy matrix \hat{m}_l if and only if $W_V(\hat{\epsilon}, x)t$ is a solution eigenvector of the monodromy operator $M_{\hat{x}_l}$ with the same eigenvalue. Hence, for $l = L, R$, the number of independent solutions which are eigenvectors of $M_{\hat{x}_l}$ is equal to the number of Jordan blocks in the Jordan matrix associated to $\hat{m}_l = \hat{C}_l\hat{D}_l$. The values for which the monodromy matrix \hat{m}_l may not be diagonalizable, are the resonance values of $\hat{\epsilon}$ specified in Definition 4.14 (which exactly correspond to multiple eigenvalues of \hat{m}_l).*

For nonresonance values of $\hat{\epsilon}$, let \hat{T}_l be the unipotent triangular matrix diagonalizing the monodromy matrix $\hat{m}_l = \hat{C}_l\hat{D}_l$:

$$(103) \quad (\hat{T}_l)^{-1}\hat{m}_l\hat{T}_l = \hat{D}_l.$$

The fundamental matrix of solutions

$$(104) \quad W_{\hat{x}_l}(x) = W_V(\hat{\epsilon}, x)\hat{T}_l$$

is composed of eigenvectors of the monodromy operator around $x = \hat{x}_l$. A fundamental matrix having this property is unique up to its normalization: the j^{th} column of $W_{\hat{x}_l}$ is a nonzero multiple of the Floquet solution (for example [11] p. 25) given by

$$(105) \quad \hat{w}_{j,l}(x) = (x - \hat{x}_l)^{\hat{\mu}_{j,l}}\hat{g}_{j,l}(x),$$

with $\hat{\mu}_{j,l}$ given by (33) and $\hat{g}_{j,l}(x) = e_j + O(|x - \hat{x}_l|)$ an analytic function of x in a region containing $x = \hat{x}_l$ but no other singular point.

When $\hat{\epsilon}$ is a resonance value, the matrix $\hat{m}_l = \hat{C}_l\hat{D}_l$ is no more diagonalizable with no j^{th} eigenvector if and only if the j^{th} Floquet solution $\hat{w}_{j,l}(x)$ does not exist and has to be replaced, in the basis of solutions around $x = \hat{x}_l$, by a solution containing logarithmic terms.

Proof. By Proposition 4.31, we have $M_{\hat{x}_l}W_V(\hat{\epsilon}, x) = W_V(\hat{\epsilon}, x)\hat{m}_l$. Let $t \in \mathbb{C}^n$ and $\beta \in \mathbb{C}$. The first assertion of the theorem is obtained from

$$(106) \quad \begin{aligned} \hat{m}_l t = \beta t &\iff W_V(\hat{\epsilon}, x)\hat{m}_l t = \beta W_V(\hat{\epsilon}, x)t \\ &\iff M_{\hat{x}_l}W_V(\hat{\epsilon}, x)t = \beta W_V(\hat{\epsilon}, x)t. \end{aligned}$$

To prove the uniqueness (up to normalization) of $W_{\hat{x}_l}(x)$, let us suppose that W^* is such that $M_{\hat{x}_l}W^* = W^*\hat{D}_l$. Since we have two bases of solutions, there

exists a nonsingular matrix K such that $W_{\hat{x}_l} = W^*K$. Since $M_{\hat{x}_l}W_{\hat{x}_l} = W_{\hat{x}_l}\hat{D}_l$, we must have $\hat{D}_lK = K\hat{D}_l$. Since $\hat{\epsilon}$ is not a resonance value, the eigenvalues of \hat{D}_l are distinct and K can only be diagonal. \square

Remark 4.35. For nonresonance values of $\hat{\epsilon}$, (103) implies that the unfolded Stokes matrices are equal to the multiplicative commutator of the matrices \hat{T}_l and \hat{D}_l :

$$(107) \quad \hat{C}_l = \hat{T}_l\hat{D}_l\hat{T}_l^{-1}\hat{D}_l^{-1} = [\hat{T}_l, \hat{D}_l].$$

The unfolded Stokes matrix \hat{C}_R (respectively \hat{C}_L) is linked to the presence of logarithmic terms in solutions around $x = \hat{x}_R$ (respectively $x = \hat{x}_L$):

Corollary 4.36. *There exist polynomials in terms of the entries of the unfolded Stokes matrices $\hat{C}_l = C_l(\hat{\epsilon})$ and the entries of \hat{D}_l indicating, when they are nonzero at a resonance value, the nonexistence of a Floquet solution $\hat{w}_{j,l}(x)$ at the resonance.*

In generic cases, the obstruction to the existence of Floquet solutions can be forced by the special form of the Stokes matrix $C_l = C_l(0)$. This is the case when

- $(C_R)_{12} \neq 0$: $\hat{w}_{2,R}(x)$ does not exist at the resonance $\hat{\mu}_{1,R} - \hat{\mu}_{2,R} \in \mathbb{N}^*$;
- $(C_L)_{n(n-1)} \neq 0$: $\hat{w}_{n-1,L}(x)$ does not exist at the resonance $\hat{\mu}_{n,L} - \hat{\mu}_{n-1,L} \in \mathbb{N}^*$;
- $\arg(\lambda_{s,0} - \lambda_{j,0})$ are distinct for all $s \neq j$: a nonvanishing s^{th} polynomial in terms of the entries of the Stokes matrices C_l with integer coefficients yields an obstruction to the existence of $\hat{w}_{j,l}(x)$ at the resonance $\hat{\mu}_{s,l} - \hat{\mu}_{j,l} \in \mathbb{N}^*$, with $s > j$ if $l = L$ and $s < j$ if $l = R$.

Proof. The polynomials of the corollary could be obtained by analytic or algebraic arguments, by counting the number of eigenvectors of $\hat{C}_l\hat{D}_l$. We present the proof in the analytic way. Recall that the matrices \hat{T}_l are triangular and unipotent. Since $\hat{T}_l = \hat{C}_l\hat{D}_l\hat{T}_l\hat{D}_l^{-1}$ (see (107)), elements $(\hat{T}_l)_{ij}$, for $i \neq j$, can be calculated from the recurrent equations

$$(108) \quad (\hat{T}_l)_{ij}(1 - \hat{\Delta}_{ij,l}) = (\hat{C}_l)_{ij} + \sum_{\substack{i < k < j, l=R \\ j < k < i, l=L}} (\hat{C}_l)_{ik}(\hat{T}_l)_{kj}\hat{\Delta}_{kj,l},$$

with $\hat{\Delta}_{s,j,l}$ given by (35). At the resonance, $\hat{\Delta}_{s,j,l} = 1$ for some s, j, l . Conditions to the nonexistence of the j^{th} column of \hat{T}_l at the resonance can be calculated from (108): they are given by polynomials in terms of entries of \hat{D}_l and of entries of the unfolded Stokes matrices. For generic cases, these polynomials have a limit at $\epsilon = 0$ and the conditions can be formulated with polynomials in the entries of the Stokes matrices at $\epsilon = 0$: the nonvanishing of the polynomials for small $\hat{\epsilon}$ is ensured by the nonvanishing of the limit polynomial at $\epsilon = 0$ which depends on C_l . This is the case for the conditions to the existence of

- the second column of \hat{T}_R ;
- the $(n-1)^{\text{th}}$ column of \hat{T}_L ;
- all columns if the Stokes lines are distinct (i.e. $\arg(\lambda_{s,0} - \lambda_{j,0})$ are distinct for all $s \neq j$). In that case, the resonance $\hat{\Delta}_{ij,l} = 1$ is distinct from the resonance $\hat{\Delta}_{kj,l} = 1$ for $k \neq i$. On the sequence $\hat{\epsilon}_n \rightarrow 0$ corresponding to the resonance $\hat{\Delta}_{ij,l} = 1$, the limit of $\left(\frac{\hat{\Delta}_{kj,l}}{1 - \hat{\Delta}_{kj,l}}\right)$ is 0 or -1 , hence the polynomials at the limit have integer coefficients (independent of $\hat{\epsilon}$).

\square

Example 4.37. *Let us consider the case $n = 3$, with distinct arguments of $\lambda_2 - \lambda_3$, $\lambda_1 - \lambda_2$ and $\lambda_1 - \lambda_3$. Equation (108) gives*

$$(109) \quad \begin{aligned} (\hat{T}_R)_{12}(1 - \hat{\Delta}_{12,R}) &= (\hat{C}_R)_{12}, \\ (\hat{T}_R)_{13}(1 - \hat{\Delta}_{13,R}) &= (\hat{C}_R)_{13} + (\hat{C}_R)_{12}(\hat{C}_R)_{23} \left(\frac{\hat{\Delta}_{23,R}}{1 - \hat{\Delta}_{23,R}} \right), \\ (\hat{T}_R)_{23}(1 - \hat{\Delta}_{23,R}) &= (\hat{C}_R)_{23}, \\ (\hat{T}_L)_{21}(1 - \hat{\Delta}_{21,L}) &= (\hat{C}_L)_{21}, \\ (\hat{T}_L)_{31}(1 - \hat{\Delta}_{31,L}) &= (\hat{C}_L)_{31} + (\hat{C}_L)_{21}(\hat{C}_L)_{32} \left(\frac{\hat{\Delta}_{21,L}}{1 - \hat{\Delta}_{21,L}} \right), \\ (\hat{T}_L)_{32}(1 - \hat{\Delta}_{32,L}) &= (\hat{C}_L)_{32}. \end{aligned}$$

Decreasing values of $\hat{\epsilon}$ such that $\hat{\mu}_{1,R} - \hat{\mu}_{3,R} \in \mathbb{N}^$ and $\hat{\mu}_{3,L} - \hat{\mu}_{1,L} \in \mathbb{N}^*$ are approaching the ray $\arg(\sqrt{\epsilon}) = \arg(\lambda_{3,0} - \lambda_{1,0})$. The following comes from the inequalities $\arg(\lambda_{1,0} - \lambda_{2,0}) < \arg(\lambda_{1,0} - \lambda_{3,0}) < \arg(\lambda_{2,0} - \lambda_{3,0})$. When $\hat{\epsilon} \rightarrow 0$ on resonance values*

- $\hat{\mu}_{1,R} - \hat{\mu}_{3,R} \in \mathbb{N}^*$ making $\hat{\Delta}_{13,R} = 1$, we have $\Im(\hat{\mu}_{2,R} - \hat{\mu}_{3,R}) > 0$ and then $\left(\frac{\hat{\Delta}_{23,R}}{1 - \hat{\Delta}_{23,R}} \right) = \left(\frac{1}{\hat{\Delta}_{32,R} - 1} \right)$ tends to -1 , since $\hat{\Delta}_{32,R} \rightarrow 0$;
- $\hat{\mu}_{3,L} - \hat{\mu}_{1,L} \in \mathbb{N}^*$ making $\hat{\Delta}_{31,L} = 1$, we have $\Im(\hat{\mu}_{1,L} - \hat{\mu}_{2,L}) > 0$ and then $\left(\frac{\hat{\Delta}_{21,L}}{1 - \hat{\Delta}_{21,L}} \right) = \left(\frac{1}{\hat{\Delta}_{12,L} - 1} \right)$ tends to -1 , since $\hat{\Delta}_{12,L} \rightarrow 0$.

These limits imply that the right hand side of the equations (109) at the resonance is minus an entry of the inverse of the unfolded Stokes matrices. We immediately see that

- if $(C_R)_{12} \neq 0$, $(\hat{T}_R)_{12}$ (and hence $\hat{w}_{2,R}(x)$) does not have a limit at the resonances $\hat{\mu}_{1,R} - \hat{\mu}_{2,R} \in \mathbb{N}^*$ making $\hat{\Delta}_{12,R} = 1$;
- if $(C_R)_{23} \neq 0$, $(\hat{T}_R)_{23}$ (and hence $\hat{w}_{3,R}(x)$) does not have a limit at the resonances $\hat{\mu}_{2,R} - \hat{\mu}_{3,R} \in \mathbb{N}^*$ making $\hat{\Delta}_{23,R} = 1$;
- if $(C_R)_{13} - (C_R)_{12}(C_R)_{23} \neq 0$, $(\hat{T}_R)_{13}$ (and hence $\hat{w}_{3,R}(x)$) does not have a limit at the resonances $\hat{\mu}_{1,R} - \hat{\mu}_{3,R} \in \mathbb{N}^*$ making $\hat{\Delta}_{13,R} = 1$;
- if $(C_L)_{21} \neq 0$, $(\hat{T}_L)_{21}$ (and hence $\hat{w}_{1,L}(x)$) does not have a limit at the resonances $\hat{\mu}_{2,L} - \hat{\mu}_{1,L} \in \mathbb{N}^*$ making $\hat{\Delta}_{21,L} = 1$;
- if $(C_L)_{32} \neq 0$, $(\hat{T}_L)_{32}$ (and hence $\hat{w}_{2,L}(x)$) does not have a limit at the resonances $\hat{\mu}_{3,L} - \hat{\mu}_{2,L} \in \mathbb{N}^*$ making $\hat{\Delta}_{32,L} = 1$;
- if $(C_L)_{31} - (C_L)_{21}(C_L)_{32} \neq 0$, $(\hat{T}_L)_{31}$ (and hence $\hat{w}_{1,L}(x)$) does not have a limit at the resonances $\hat{\mu}_{3,L} - \hat{\mu}_{1,L} \in \mathbb{N}^*$ making $\hat{\Delta}_{31,L} = 1$.

4.9. Stokes matrices and monodromy in the Riccati systems. In this section, we give a meaning to the unfolded Stokes matrices in the corresponding Riccati systems. This allows an interpretation of the Stokes matrices at $\epsilon = 0$. This section is not prerequisite to state the complete system of analytic invariants of the systems (25).

We will look at the monodromy of first integrals in the Riccati systems. These first integrals are obtained from the basis of the linear system.

Proposition 4.38. *For $x \in V^\epsilon$, the j^{th} Riccati system has first integrals \mathcal{H}_q^j , for $q \in \{1, 2, \dots, n\} \setminus \{j\}$, that can be written as*

$$(110) \quad \mathcal{H}_q^j(\hat{\epsilon}, x, [y]_j) = (-1)^{q-j} \frac{\left| \begin{array}{cccc} b_1^j(\hat{\epsilon}, x, [y]_j) & \dots & \widehat{b_q^j(\hat{\epsilon}, x, [y]_j)} & \dots & b_n^j(\hat{\epsilon}, x, [y]_j) \end{array} \right|}{\left| \begin{array}{cccc} b_1^j(\hat{\epsilon}, x, [y]_j) & \dots & b_q^j(\hat{\epsilon}, x, [y]_j) & \dots & b_n^j(\hat{\epsilon}, x, [y]_j) \end{array} \right|},$$

with

$$(111) \quad b_i^j(\hat{\epsilon}, x, [y]_j) = (-1)^{i-j} (w_i(\hat{\epsilon}, x))_j ([y]_j - [w_i]_j),$$

and $w_i(\hat{\epsilon}, x)$ the i^{th} column of the fundamental matrix of solutions $W_V(\hat{\epsilon}, x)$ given by (100) (for $[w_i]_j$, see Notation 4.5). \mathcal{H}_q^j has values in \mathbb{CP}^1 for $q \neq j$.

Proof. Let $w_i(\hat{\epsilon}, x)$ be the columns of the fundamental matrix of solutions $W_V(\hat{\epsilon}, x)$ given by (100). The general solution of a linear system (25) may be expressed as a linear combination $y = \sum_{q=1}^n k_q w_q(\hat{\epsilon}, x)$ of the particular solution $w_q(\hat{\epsilon}, x)$, with $k_q \in \mathbb{C}$. In particular, the j^{th} component of this general solution y satisfies

$$(112) \quad (y)_j = \sum_{q=1}^n k_q (w_q(\hat{\epsilon}, x))_j,$$

so

$$(113) \quad \sum_{q=1}^n k_q (w_q(\hat{\epsilon}, x))_j \frac{y}{(y)_j} = \sum_{q=1}^n k_q w_q(\hat{\epsilon}, x),$$

and

$$(114) \quad \sum_{q=1}^n \frac{k_q}{k_j} \left(w_q(\hat{\epsilon}, x) - (w_q(\hat{\epsilon}, x))_j \frac{y}{(y)_j} \right) = 0.$$

Solving for $\frac{k_q}{k_j}$, $q \neq j$, and using Notation 4.5 and (111) gives (110). \square

As detailed in the next theorem, entries of the inverse of the unfolded Stokes matrices appear in the expression of the monodromy of the first integrals \mathcal{H}_q^j around $x = \hat{x}_l$.

Theorem 4.39. *The monodromy of a first integral \mathcal{H}_q^j around $x = \hat{x}_l$ may be written as the composition of*

- a wild part (i.e. of the form $e^{\frac{2\pi i}{\alpha}}$ with $\alpha \in \mathbb{C}$, $\alpha \rightarrow 0$) depending on the formal invariants,
- a map depending on the entries of the inverse of the unfolded Stokes matrices and having a limit for $\epsilon = 0$.

More precisely, with $\mathcal{H}_j^j = 1$, the monodromy of the first integrals may be expressed as

$$(115) \quad M_{\hat{x}_R}(\mathcal{H}_q^j) = \hat{\Delta}_{j,q,R} \frac{\mathcal{H}_q^j + \sum_{p=q+1}^n (\hat{C}_R^{-1})_{qp} \mathcal{H}_p^j}{1 + \sum_{p=j+1}^n (\hat{C}_R^{-1})_{jp} \mathcal{H}_p^j},$$

and

$$(116) \quad M_{\hat{x}_L}(\mathcal{H}_q^j) = \hat{\Delta}_{j,q,L} \frac{\mathcal{H}_q^j + \sum_{p=1}^{q-1} (\hat{C}_L^{-1})_{qp} \mathcal{H}_p^j}{1 + \sum_{p=1}^{j-1} (\hat{C}_L^{-1})_{jp} \mathcal{H}_p^j}.$$

Denoting

$$(117) \quad \mathcal{H}^j = (\mathcal{H}_1^j, \dots, \mathcal{H}_n^j)^T,$$

this is equivalent to

$$(118) \quad M_{\hat{x}_l}(\mathcal{H}^j) = \text{diag}\{\hat{\Delta}_{j1,l}, \dots, \hat{\Delta}_{jn,l}\} \frac{\hat{C}_l^{-1} \mathcal{H}^j}{[(\hat{C}_l^{-1})_{j1}, \dots, (\hat{C}_l^{-1})_{jn}] \mathcal{H}^j},$$

with $\hat{\Delta}_{jq,l}$ as defined by (35).

Proof. In order to calculate the monodromy of the first integrals given by (110), we need to compute the monodromy of

$$(119) \quad B^j(\hat{\epsilon}, x, [y]_j) = [b_1^j(\hat{\epsilon}, x, [y]_j) \quad \dots \quad b_n^j(\hat{\epsilon}, x, [y]_j)],$$

with $b_i^j(\hat{\epsilon}, x, [y]_j)$ given by (111). Since the monodromy of $w_q(\hat{\epsilon}, x)$ is given by Proposition 4.31, we have

$$(120) \quad M_{\hat{x}_l}(B^j(\hat{\epsilon}, x, [y]_j)) = B^j(\hat{\epsilon}, x, [y]_j) \hat{m}_l,$$

with \hat{m}_l given by (102). With \mathcal{H}^j defined in (117), relation (114) implies

$$(121) \quad B^j(\hat{\epsilon}, x, [y]_j) \mathcal{H}^j = 0,$$

and thus, using (120),

$$(122) \quad B^j(\hat{\epsilon}, x, [y]_j) \hat{m}_l M_{\hat{x}_l}(\mathcal{H}^j) = 0.$$

Equations (121) and (122) imply that

$$(123) \quad M_{\hat{x}_l}(\mathcal{H}_q^j) = \frac{(\hat{m}_l^{-1} \mathcal{H}^j)_q}{(\hat{m}_l^{-1} \mathcal{H}^j)_j},$$

leading to the equations of the theorem, using (102). \square

Theorem 4.39 yields the following interpretation of the Stokes matrices at $\epsilon = 0$:

Corollary 4.40. *The first integral \mathcal{H}_q^j is an eigenvector of the monodromy operator around a singular point $x = \hat{x}_l$ (by this we means $M_{\hat{x}_l} \mathcal{H}_q^j = \hat{\Delta}_{jq,l} \mathcal{H}_q^j$) if and only if the rows j and q in the inverse of the unfolded Stokes matrix \hat{C}_l are trivial (see Notation 4.32). Hence, a nontrivial i^{th} row in the inverse of the right (respectively left) Stokes matrix at $\epsilon = 0$ is an obstruction for the first integrals \mathcal{H}_k^i to be eigenvectors of the monodromy operator around the right (respectively left) singular point, for $k \in \{1, \dots, n\} \setminus \{i\}$.*

Proof. This is immediate from equations (115) and (116). \square

The wild part in the monodromy of the first integrals of the Riccati system is due to the definition of the fundamental matrix of solutions of the model system over the considered domain and is not a consequence of the Stokes phenomenon:

Remark 4.41. *If we compare first integrals over the intersections of the sectorial domains $\Omega_U^{\hat{\epsilon}}$ and $\Omega_D^{\hat{\epsilon}}$ instead of over the auto-intersection of $V^{\hat{\epsilon}}$ (thus taking Notation 4.20 for $F_s(\hat{\epsilon}, x)$ over $\Omega_s^{\hat{\epsilon}}$ instead of Notation 4.29 for $F_V(\hat{\epsilon}, x)$ over $V^{\hat{\epsilon}}$), the wild part is only present in the comparison over $\Omega_C^{\hat{\epsilon}}$ (which does not exist at $\epsilon = 0$). When we compare the first integrals over $\Omega_R^{\hat{\epsilon}}$ and $\Omega_L^{\hat{\epsilon}}$, there is no wild part in equations corresponding to (115), (116) and (118).*

4.10. Auto-intersection relation and $\frac{1}{2}$ -summable representative of the equivalence class of unfolded Stokes matrices. In this section, we compare the two points of view that we have on S_\cap , the auto-intersection of S . This will yield a relation that is satisfied for all $\epsilon \in S_\cap$. We call it the auto-intersection relation. It allows to prove the existence of a representative of the equivalence class of unfolded Stokes matrices which is $\frac{1}{2}$ -summable in ϵ . Further, it will be a necessary and sufficient condition for the realization of the complete system of analytic invariants.

For $\bar{\epsilon}$ and $\tilde{\epsilon} = \bar{\epsilon}e^{2\pi i}$ in S_\cap (Figure 3), we have two different presentations of the dynamics of the same linear differential system. On S_\cap , since there is no resonance value, there always exists transition matrices between fundamental matrices of solutions composed of eigenvectors of the monodromy operators around the singular points. We will use these transition matrices to compare the two presentations on S_\cap . First, let us take the monodromy operators with the base point taken on the upper (respectively lower) sectorial domain when the corresponding loop surrounds the upper (respectively lower) singular point.

Notation 4.42. In Notation 4.30, we defined the monodromy operators $M_{\hat{x}_R}$ and $M_{\hat{x}_L}$, for $\hat{\epsilon} \in S$. Over S_\cap , let us denote

- $M_{\hat{x}_L}^* = M_{\hat{x}_L}$,
- $M_{\hat{x}_R}^* = M_{\hat{x}_R}$,
- $M_{\hat{x}_L}^* = M_{\hat{x}_L}^{-1}$,
- $M_{\hat{x}_R}^* = M_{\hat{x}_R}^{-1}$.

Hence, the base points of $M_{\hat{x}_L}^*$ and $M_{\hat{x}_R}^*$ belongs to $\Omega_D^{\bar{\epsilon}} \cap \Omega_D^{\tilde{\epsilon}}$, whereas the base points of $M_{\hat{x}_L}^*$ (respectively $M_{\hat{x}_R}^*$) are taken on $\Omega_U^{\bar{\epsilon}} \cap \Omega_U^{\tilde{\epsilon}}$ (Figures 15 and 16).

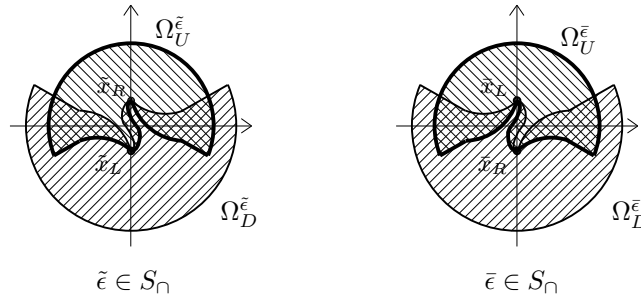

FIGURE 15. Sectorial domains in the x -variable for $\hat{\epsilon} \in S_\cap$.

Definition 4.43. For $l = L, R$, let us take $W_{\hat{x}_l}(x)$ a fundamental matrix of solutions of (25) composed of eigenvectors of the monodromy operator $M_{\hat{x}_l}^*$, depending analytically on $\hat{\epsilon} \in S_\cap$ and converging uniformly over compact sets of Ω_s^0 when $\hat{\epsilon} \rightarrow 0$ (and $\hat{\epsilon} \in S_\cap$) to $W_s(0, x)$ defined by (43), with $s = D$ if $\Im(\hat{x}_l) < 0$ and $s = U$ otherwise. Let $E_{L, \hat{x}_L \rightarrow \hat{x}_R}$ be the matrix such that, over a fixed compact set of Ω_L^0 sufficiently far from the singular points,

$$(124) \quad E_{L, \hat{x}_L \rightarrow \hat{x}_R} = (W_{\hat{x}_L}(x))^{-1} W_{\hat{x}_R}(x).$$

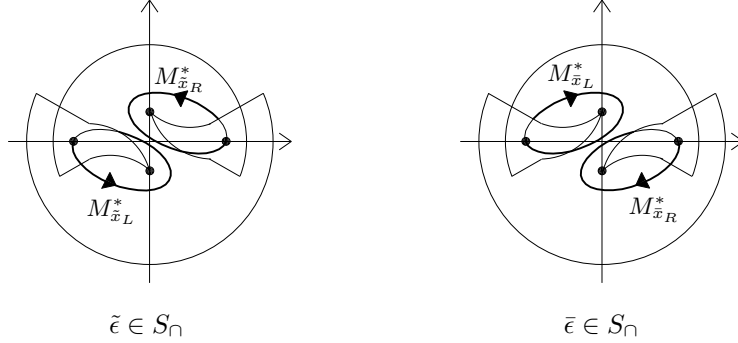

FIGURE 16. Illustration of the definition of the monodromy operators $M_{\tilde{x}_L}^*$, $M_{\tilde{x}_R}^*$, $M_{\bar{x}_L}^*$ and $M_{\bar{x}_R}^*$.

Let $E_{\hat{x}_L \rightarrow \hat{x}_R}$ be the matrix such that, over a fixed compact set of Ω_R^0 sufficiently far from the singular points,

$$(125) \quad E_{R, \hat{x}_L \rightarrow \hat{x}_R} = (W_{\hat{x}_L}(x))^{-1} W_{\hat{x}_R}(x).$$

We call $E_{L, \hat{x}_L \rightarrow \hat{x}_R}$ (respectively $E_{\hat{x}_L \rightarrow \hat{x}_R}$) the *left* (respectively *right*) *transition matrix* from \hat{x}_L to \hat{x}_R . These transition matrices are unique up to multiplication on each side by nonsingular diagonal matrices depending analytically on $\hat{\epsilon} \in S_\Gamma$, with a nonsingular limit at $\epsilon = 0$ (coming from the normalization of the chosen fundamental matrices of solutions).

The following proposition is implicit from the paper [3] of A. Glutsyuk. The proof will be useful later.

Proposition 4.44. *Let us take two families of systems*

$$(126) \quad (x^2 - \hat{\epsilon})y_i' = B_i(\hat{\epsilon}, x)y_i, \quad i = 1, 2,$$

having the form (25) with the same model system and depending on $\hat{\epsilon} \in S_\Gamma$. Let

$$(127) \quad x_U = \bar{x}_L = \tilde{x}_R, \quad x_D = \bar{x}_R = \tilde{x}_L.$$

Let us take for each family of systems a right transition matrix from x_D to x_U , i.e. $E_{R, x_D \rightarrow x_U}^i$ (Definition 4.43). The two family of systems (126) are analytically equivalent, the equivalence depending analytically on $(\epsilon, x) \in S_\Gamma \times \mathbb{D}_r$ and converging uniformly on compact sets of \mathbb{D}_r when $\epsilon \rightarrow 0$, if and only if there exist \hat{Q}_U and \hat{Q}_D nonsingular diagonal matrices depending analytically on $\hat{\epsilon} \in S_\Gamma$, with a nonsingular limit at $\epsilon = 0$, and such that

$$(128) \quad E_{R, x_D \rightarrow x_U}^1 \hat{Q}_U = \hat{Q}_D E_{R, x_D \rightarrow x_U}^2.$$

Proof. Let us denote by $W_{\hat{x}_l}^i(x)$, $l = L, R$, the fundamental matrix of solutions taken to calculate the right transition matrices $E_{R, x_D \rightarrow x_U}^i$, $i = 1, 2$. Let us take two domains $\mathcal{G}_U^{\hat{\epsilon}}$ and $\mathcal{G}_D^{\hat{\epsilon}}$ covering \mathbb{D}_r (Figure 17), such that $\mathcal{G}_U^{\hat{\epsilon}}$ (respectively $\mathcal{G}_D^{\hat{\epsilon}}$) contains x_U but not x_D (respectively x_D but not x_U) and has the limit Ω_U^0 (respectively Ω_D^0) when $\hat{\epsilon} \rightarrow 0$ in S_Γ .

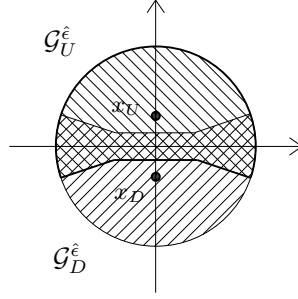
FIGURE 17. Domains $\mathcal{G}_U^{\hat{\epsilon}}$ and $\mathcal{G}_D^{\hat{\epsilon}}$ and their intersection.

Let us suppose that (128) is satisfied. The transformation $y_1 = P_{\hat{\epsilon}}(x)y_2$, with

$$(129) \quad P_{\hat{\epsilon}}(x) = \begin{cases} W_{x_U}^1(x)\hat{Q}_U(W_{x_U}^2(x))^{-1}, & \text{on } \mathcal{G}_U^{\hat{\epsilon}}, \\ W_{x_D}^1(x)\hat{Q}_D(W_{x_D}^2(x))^{-1}, & \text{on } \mathcal{G}_D^{\hat{\epsilon}}, \end{cases}$$

is well-defined on \mathbb{D}_r because of (128), for any $\hat{\epsilon} \in S_{\cap} \cup \{0\}$. It conjugates the two systems, depends analytically on $(\hat{\epsilon}, x) \in S_{\cap} \times \mathbb{D}_r$ and converges uniformly on compact sets of \mathbb{D}_r when $\hat{\epsilon} \rightarrow 0$.

On the other hand, let us suppose that the change $y_1 = P_{\hat{\epsilon}}(x)y_2$ yields an analytic equivalence (as in the statement of the proposition) between the two systems. Then, by uniqueness (up to normalization) of $W_{\hat{x}_L}^i(x)$ and $W_{\hat{x}_R}^i(x)$, we must have

$$(130) \quad P_{\hat{\epsilon}}(x)W_{x_U}^2(x) = W_{x_U}^1(x)\hat{Q}_U, \quad \text{over } \mathcal{G}_U^{\hat{\epsilon}},$$

and

$$(131) \quad P_{\hat{\epsilon}}(x)W_{x_D}^2(x) = W_{x_D}^1(x)\hat{Q}_D, \quad \text{over } \mathcal{G}_D^{\hat{\epsilon}},$$

with \hat{Q}_U and \hat{Q}_D nonsingular diagonal matrices depending analytically on $\hat{\epsilon} \in S_{\cap}$ and having a nonsingular limit at $\epsilon = 0$. Isolating $P_{\hat{\epsilon}}(x)$ in (130) and (131), we get, over a compact in Ω_R^0 and for $\hat{\epsilon}$ sufficiently small,

$$(132) \quad W_{x_D}^1(x)\hat{Q}_D(W_{x_D}^2(x))^{-1} = W_{x_U}^1(x)\hat{Q}_U(W_{x_U}^2(x))^{-1},$$

which is equivalent to (128), using (125). \square

Remark 4.45. Taking the left transition matrices instead of the right transition matrices in Proposition 4.44 (and taking in the proof a compact set on Ω_L^0 instead of Ω_R^0) yields similar result.

When taking a system of the form (25), the right transition matrices $E_{R, \bar{x}_L \rightarrow \bar{x}_R}$ and $E_{R, \bar{x}_R \rightarrow \bar{x}_L}$ both correspond to the transition from the lower point to the upper point. By Proposition 4.44, we know they satisfy a relation like (128). We formulate it more precisely in Proposition 4.53.

Definition 4.46. For $r(\epsilon)$ analytic in $\epsilon \in S_{\cap}$, we say that $r(\epsilon)$ is exponentially close to 0 in $\sqrt{\epsilon}$ if it satisfies $|r(\epsilon)| < be^{-\frac{a}{\sqrt{|\epsilon|}}}$ for some $a, b \in \mathbb{R}_+^*$.

Lemma 4.47. Following its definition given by (35),

$$(133) \quad \tilde{\Delta}_{s,j,l} = (\tilde{D}_l)_{ss}(\tilde{D}_l^{-1})_{jj}, \quad s < j, l = L, R$$

is exponentially close to 0 in $\sqrt{\epsilon}$ (to prove it, use (54)). We also have

$$(134) \quad (\hat{\Delta}_{sj,l})^{-1} = \hat{\Delta}_{js,l}$$

and

$$(135) \quad \hat{\Delta}_{sj,l} \hat{\Delta}_{ji,l} = \hat{\Delta}_{si,l}.$$

By (31), (34) and (55), we obtain

$$(136) \quad \tilde{D}_L = \bar{D}_R^{-1}, \quad \tilde{D}_R = \bar{D}_L^{-1}$$

and, by (35),

$$(137) \quad \begin{aligned} \bar{\Delta}_{sj,R} &= \tilde{\Delta}_{js,L}, \\ \bar{\Delta}_{sj,L} &= \tilde{\Delta}_{js,R}. \end{aligned}$$

Hence, $\bar{\Delta}_{sj,l}$ is exponentially close to 0 in $\sqrt{\epsilon}$ for $s > j$ and $l = L, R$.

Lemma 4.48. *On S_Γ , entries from the following matrices are exponentially close to 0 in $\sqrt{\epsilon}$ in the sense of Definition 4.46:*

$$(138) \quad \begin{aligned} \bar{C}_L - \bar{T}_L, & \quad I - \tilde{T}_L, \\ \bar{C}_R - \bar{T}_R, & \quad I - \tilde{T}_R. \end{aligned}$$

$$(139) \quad \begin{aligned} \bar{C}_L^{-1} - \bar{T}_L^{-1}, & \quad I - \tilde{T}_L^{-1}, \\ \bar{C}_R^{-1} - \bar{T}_R^{-1}, & \quad I - \tilde{T}_R^{-1}, \end{aligned}$$

$$(140) \quad \begin{aligned} \bar{C}_L - \tilde{D}_L \tilde{T}_L^{-1} \tilde{D}_L^{-1}, \\ \bar{C}_R - \tilde{D}_R \tilde{T}_R^{-1} \tilde{D}_R^{-1}, \end{aligned}$$

and

$$(141) \quad \begin{aligned} I - \bar{D}_R \bar{T}_L \bar{D}_R^{-1}, & \quad I - \bar{D}_L \bar{T}_L \bar{D}_L^{-1}, & \quad I - \bar{D}_R \bar{T}_L^{-1} \bar{D}_R^{-1} \\ I - \bar{D}_R \bar{T}_R \bar{D}_R^{-1}, & \quad I - \bar{D}_L \bar{T}_R \bar{D}_L^{-1}, & \quad I - \bar{D}_L \bar{T}_R^{-1} \bar{D}_L^{-1}. \end{aligned}$$

Proof. The proof follows from Lemma 4.47 and (107). Relation (108) is used to obtain (138). Since $\hat{T}_l^{-1} = \hat{D}_l \hat{T}_l^{-1} \hat{D}_l^{-1} \hat{C}_l^{-1}$, we have, for $i \neq j$,

$$(142) \quad (\hat{T}_l^{-1})_{ij} (1 - \Delta_{ij,l}) = (\hat{C}_l^{-1})_{ij} + \sum_{\substack{i < k < j, l=R \\ j < k < i, l=L}} (\hat{T}_l^{-1})_{ik} (\hat{C}_l^{-1})_{kj} \Delta_{ik,l},$$

Relation (142) leads to (139). Since $\hat{D}_l \hat{T}_l^{-1} \hat{D}_l^{-1} = \hat{T}_l^{-1} \hat{C}_l$, we have, for $i \neq j$,

$$(143) \quad (\hat{T}_l^{-1})_{ij} (\Delta_{ij,l} - 1) = (\hat{C}_l)_{ij} + \sum_{\substack{i < k < j, l=R \\ j < k < i, l=L}} (\hat{T}_l^{-1})_{ik} (\hat{C}_l)_{kj},$$

Relations (143) and (139) yield (140). Finally, (141) follows from (138) and (139), using (36) if necessary. \square

Definition 4.49. Let the formal invariants be given. Let $\{\hat{C}_R, \hat{C}_L\}$ be a representative of the equivalence class of the unfolded Stokes collections. Let \hat{T}_l be obtained by (103). We define

$$(144) \quad \begin{aligned} \tilde{N}_L &= \tilde{D}_L \tilde{T}_L^{-1} \tilde{T}_R \tilde{D}_L^{-1}, & \tilde{N}_R &= \tilde{T}_L^{-1} \tilde{T}_R, \\ \bar{N}_L &= \bar{T}_R^{-1} \bar{T}_L, & \bar{N}_R &= \bar{D}_R \bar{T}_R^{-1} \bar{T}_L \bar{D}_R^{-1}. \end{aligned}$$

We call the matrix \hat{N}_L (respectively \hat{N}_R) the *left* (respectively *right*) *transition invariant*. Two transition invariants \hat{N}_l and \hat{N}'_l , with $l = L, R$, are equivalent if

$$(145) \quad \hat{N}'_l = \hat{K} \hat{N}_l \hat{K}^{-1}$$

with \hat{K} as in Definition 4.28.

Corollary 4.50 (of Lemma 4.48). *On S_\cap , the difference between a left (respectively right) transition invariant and a left (respectively right) unfolded Stokes matrix is exponentially close to 0 in $\sqrt{\epsilon}$ in the sense of Definition 4.46, i.e.*

$$(146) \quad \tilde{N}_R - \tilde{C}_R, \quad \tilde{N}_L - \tilde{C}_L, \quad \tilde{N}_L - \tilde{C}_L, \quad \tilde{N}_R - \tilde{C}_R.$$

Remark 4.51. *From Corollary 4.50, the diagonal entries of the transition invariants \hat{N}_l , $l = L, R$, tend to 1 when $\epsilon \rightarrow 0$ in S_\cap . They are thus always different from zero if the radius ρ of the sector S is sufficiently small.*

Definition 4.52. Let the unfolded Stokes matrices and the formal invariants be given. Let \hat{T}_l as obtained by (103). We say that the *auto-intersection relation* is satisfied if there exist \bar{Q}_U and \bar{Q}_D nonsingular diagonal matrices depending analytically on $\bar{\epsilon} \in S_\cap$, with a nonsingular limit at $\epsilon = 0$, such that

$$(147) \quad |\bar{Q}_s - I| < c_s |\bar{\epsilon}|, \quad c_s \in \mathbb{R}, \quad \bar{\epsilon} \in S_\cap, \quad s = D, U,$$

and

$$(148) \quad \bar{Q}_D \bar{D}_R \bar{T}_R^{-1} \bar{T}_L \bar{D}_R^{-1} = \bar{T}_L^{-1} \bar{T}_R \bar{Q}_U,$$

which is equivalent to

$$(149) \quad \bar{Q}_D \bar{N}_l = \tilde{N}_l \bar{Q}_U, \quad l = L, R.$$

because of (136) and Definition 4.49.

Proposition 4.53. *The auto-intersection relation (149) for the family (25) is satisfied.*

Proof. We proceed similarly as the proof of Proposition 4.44, taking

- (a) $W_U(\bar{\epsilon}, x) \bar{D}_R \bar{T}_L \bar{D}_R^{-1}$ and $W_U(\bar{\epsilon}, x) \tilde{D}_R \tilde{T}_R \tilde{D}_R^{-1}$ as the fundamental matrices of solutions composed of eigenvectors of $M_{\bar{x}_L}^*$ (to verify, use (75), (92) and (107)),
- (b) $W_D(\bar{\epsilon}, x) \bar{T}_R$ and $W_D(\bar{\epsilon}, x) \tilde{T}_L$ as the fundamental matrices of solutions composed of eigenvectors of $M_{\bar{x}_R}^*$,

with $W_s(\epsilon, x)$ given by (76). By Lemma 4.48 and Corollary 4.24, these solutions converge uniformly to $W_s(0, x)$ (defined by (43)) on compact sets of Ω_s^0 when $\bar{\epsilon} \rightarrow 0$, $\bar{\epsilon} \in S_\cap$, for $s = D$ or $s = U$. The corresponding transition matrices are here given by

$$(150) \quad E_{L, \bar{x}_L \rightarrow \bar{x}_R} = \tilde{N}_L e^{2\pi i \Lambda_1(\epsilon)}, \quad E_{R, \bar{x}_L \rightarrow \bar{x}_R} = \tilde{N}_R,$$

$$(151) \quad E_{L, \bar{x}_R \rightarrow \bar{x}_L} = \bar{N}_L e^{2\pi i \Lambda_1(\epsilon)}, \quad E_{R, \bar{x}_R \rightarrow \bar{x}_L} = \bar{N}_R,$$

leading to (149).

Let us now prove (147) for $s = D$ (the case $s = U$ is similar). We have obtained the existence of nonsingular diagonal matrices \bar{Q}_U and \bar{Q}_D depending analytically on $\bar{\epsilon} \in S_\cap$, with a nonsingular limit at $\epsilon = 0$, such that

$$(152) \quad W_U(\bar{\epsilon}, x) \bar{D}_R \bar{T}_L \bar{D}_R^{-1} = W_U(\bar{\epsilon}, x) \tilde{D}_R \tilde{T}_R \tilde{D}_R^{-1} \bar{Q}_U$$

and

$$(153) \quad W_D(\bar{\epsilon}, x)\bar{T}_R = W_D(\tilde{\epsilon}, x)\tilde{T}_L\bar{Q}_D.$$

Extending the solution $W_D(\bar{\epsilon}, x)\bar{T}_R$ (respectively $W_D(\tilde{\epsilon}, x)\tilde{T}_L$) to $x = 0$ along a path in $\Omega_D^{\bar{\epsilon}}$ (respectively $\Omega_D^{\tilde{\epsilon}}$), we obtain

$$(154) \quad W_D(\bar{\epsilon}, 0)\bar{T}_R = W_D(\tilde{\epsilon}, 0)\tilde{T}_L\bar{Q}_D\bar{D}_R$$

or equivalently, because of (76),

$$(155) \quad H_D(\bar{\epsilon}, 0)F_D(\bar{\epsilon}, 0)\bar{T}_R = H_D(\tilde{\epsilon}, 0)F_D(\tilde{\epsilon}, 0)\tilde{T}_L\bar{Q}_D\bar{D}_R.$$

Since $F_D(\bar{\epsilon}, 0) = F_D(\tilde{\epsilon}, 0)\bar{D}_R$, we have

$$(156) \quad H_D(\bar{\epsilon}, 0)F_D(\bar{\epsilon}, 0)\bar{T}_R F_D(\bar{\epsilon}, 0)^{-1} = H_D(\tilde{\epsilon}, 0)F_D(\tilde{\epsilon}, 0)\tilde{T}_L F_D(\tilde{\epsilon}, 0)^{-1}\bar{Q}_D.$$

Using (138), we have that $F_D(\bar{\epsilon}, 0)\bar{T}_R F_D(\bar{\epsilon}, 0)^{-1}$ and $F_D(\tilde{\epsilon}, 0)\tilde{T}_L F_D(\tilde{\epsilon}, 0)^{-1}$ are exponentially close in $\sqrt{\epsilon}$ to I . We use (77) and (78) in order to obtain (147) for $s = D$. \square

We now present an important consequence to the auto-intersection relation:

Theorem 4.54. *There exists a representative of the equivalence class of unfolded Stokes matrices which is $\frac{1}{2}$ -summable in ϵ . It is defined over S with a slight reduction of the opening and radius.*

Proof. The strategy consists in using the Ramis-Sibuya Theorem (see for instance [8]): if $C(\hat{\epsilon})$ depends analytically on $\hat{\epsilon}$ on a ramified sector around the origin and if the difference on the auto-intersection of the sector is exponentially close to 0 in $\sqrt{\epsilon}$, i.e. $|C(\bar{\epsilon}) - C(\tilde{\epsilon})| < B e^{-\frac{A}{\sqrt{|\epsilon|}}}$ for some positive A and B , then $C(\epsilon)$ is $\frac{1}{2}$ -summable in ϵ .

By Proposition 4.53, the auto-intersection relation (149) is satisfied. Hence,

$$(157) \quad \bar{Q}_D \bar{N}_l = \tilde{N}_l \bar{Q}_D \bar{Q},$$

with $\bar{Q} = \bar{Q}_D^{-1} \bar{Q}_U$. We then have

$$(158) \quad (\bar{N}_l)_{ii} = (\tilde{N}_l)_{ii} (\bar{Q})_{ii},$$

Corollary 4.50 says that \bar{N}_l (respectively \tilde{N}_l) is exponentially close in $\sqrt{\epsilon}$ to \bar{C}_l (respectively \tilde{C}_l). Since the unfolded Stokes matrices has 1's on the diagonal, relation (158) implies that \bar{Q} is exponentially close (in $\sqrt{\epsilon}$) to I . If the opening and the radius of S are reduced slightly, there exists \hat{K} a nonsingular diagonal matrix depending analytically on $\hat{\epsilon} \in S$, with a nonsingular limit at $\epsilon = 0$, such that $\tilde{K}^{-1} \bar{K} = \bar{Q}_D$ (recall that (147) is satisfied). Relation (157) becomes

$$(159) \quad \bar{K} \bar{N}_l \bar{K}^{-1} = \hat{K} \tilde{N}_l \hat{K}^{-1} \bar{Q},$$

since \bar{Q} is diagonal, and hence commutes with \bar{K} . Let us take the representative of the equivalence class of unfolded Stokes matrices $\hat{C}'_l = \hat{K} \hat{C}_l \hat{K}^{-1}$. Using Corollary 4.50 with

$$(160) \quad \hat{N}'_l = \hat{K} \hat{N}_l \hat{K}^{-1},$$

we obtain that \bar{N}'_l (respectively \tilde{N}'_l) is exponentially close to \bar{C}'_l (respectively \tilde{C}'_l). On the other hand, relation (159) implies

$$(161) \quad \bar{N}'_l = \tilde{N}'_l \bar{Q}$$

with \bar{Q} exponentially close in $\sqrt{\epsilon}$ to I . The difference between the representatives \bar{C}'_l and \tilde{C}'_l is hence exponentially close to 0 in $\sqrt{\epsilon}$, for $l = L, R$. \square

Remark 4.55. *In dimension $n = 2$, it is always possible to choose an analytic representative of the equivalence classes of unfolded Stokes matrices. All the cases have been enumerated in [2]. Indeed, in the case of nonvanishing elements $(\hat{C}_L)_{21}$ and $(\hat{C}_R)_{12}$, the auto-intersection relation is equivalent to the analyticity of the product $(\hat{C}_L)_{21}(\hat{C}_R)_{12}$. Preliminary investigation in the case $n = 3$ shows that this could not be the case generically. We study this in more details in [7].*

4.11. Unfolded Stokes matrices reducible in block diagonal form. We will now state a sufficient condition for the decomposition of a system (25) in dimension n as the direct product of irreducible systems of lower dimension (this may require a permutation), using the following lemma.

Lemma 4.56. *For $\hat{\epsilon} \in S_\cap$, the matrix $P^{-1}\hat{C}_L P$ (respectively $P^{-1}\hat{C}_R P$), with a permutation matrix P , is lower (respectively upper) triangular, unipotent and in a block diagonal form if and only if $P^{-1}\hat{T}_L P$ (respectively $P^{-1}\hat{T}_R P$) has the same form.*

\bar{C}_R and \bar{C}_L have a common block diagonal form with the same permutation matrix P (when staying triangular) if and only if \tilde{C}_R and \tilde{C}_L have the same block diagonal form with the same permutation matrix P (and stay triangular).

Proof. The first assertion comes from the fact that columns of $P^{-1}\hat{T}_l P$ are eigenvectors of $P^{-1}\hat{C}_l \hat{D}_l P$ (note that there are no resonances for $\hat{\epsilon}$ in S_\cap). Let us prove the converse. $P^{-1}\hat{T}_l P$ is unipotent, triangular and in a block diagonal form if and only if $P^{-1}\hat{D}_l \hat{T}_l \hat{D}_l^{-1} P$ has the same structure with the same permutation matrix P . Then, the product $(P^{-1}\hat{T}_l P)(P^{-1}\hat{D}_l \hat{T}_l \hat{D}_l^{-1} P)^{-1} = P^{-1}\hat{C}_l P$ (by (107)) has the desired property.

The second assertion follows directly from (148) and from the first assertion. \square

Theorem 4.57. *Let us take any family of systems (25) with both unfolded Stokes matrices admitting, after conjugation (if necessary) by the same permutation matrix P preserving their triangular form, the same decomposition in diagonal blocks for all $\hat{\epsilon} \in S$ (i.e. $P^{-1}\hat{C}_l P = \hat{c}_{n_1}^l \oplus \hat{c}_{n_2}^l \oplus \dots \oplus \hat{c}_{n_k}^l$ for $l = L, R$, with $n_1 + n_2 + \dots + n_k = n$). This family of systems is analytically equivalent (with permutation P) to the direct product of families of systems.*

Proof. First, let us take a system (25) which has unfolded Stokes matrices in block diagonal form with the same positions of the blocks: $\hat{C}_l = \hat{c}_{n_1}^l \oplus \hat{c}_{n_2}^l \oplus \dots \oplus \hat{c}_{n_k}^l$ for $l = L, R$, with $n_1 + n_2 + \dots + n_k = n$. We will prove that this system is analytically equivalent to a direct product of smaller systems of dimensions n_1, \dots, n_k . Looking at (92), we notice that these relations would still hold if we replace by zero each element $(H_s(\hat{\epsilon}, x))_{ij}$ such that the position (i, j) is outside the diagonal blocks of \hat{C}_l . This leads us to define $J_s(\hat{\epsilon}, x)$, for $x \in \Omega_s^\epsilon$, by

(162)

$$(J_s(\hat{\epsilon}, x))_{ij} = \begin{cases} 0, & \text{if } (i, j) \text{ lies outside the diagonal blocks,} \\ (H_s(\hat{\epsilon}, x))_{ij}, & \text{otherwise.} \end{cases}$$

$J_s(\hat{\epsilon}, x)$ is in block diagonal form $J_{s,n_1}(\hat{\epsilon}, x) \oplus J_{s,n_2}(\hat{\epsilon}, x) \oplus \dots \oplus J_{s,n_k}(\hat{\epsilon}, x)$ and it follows from (79) that it is invertible. From (92), we have

$$(163) \quad J_D(\hat{\epsilon}, x)^{-1} J_U(\hat{\epsilon}, x) = \begin{cases} F_D(\hat{\epsilon}, x) \hat{C}_R (F_D(\hat{\epsilon}, x))^{-1}, & \text{on } \Omega_R^\epsilon, \\ F_D(\hat{\epsilon}, x) \hat{C}_L (F_D(\hat{\epsilon}, x))^{-1}, & \text{on } \Omega_L^\epsilon, \\ I, & \text{on } \Omega_C^\epsilon. \end{cases}$$

These relations imply that the transformation

$$(164) \quad \mathcal{Q}(\hat{\epsilon}, x) = \begin{cases} J_D(\hat{\epsilon}, x) H_D(\hat{\epsilon}, x)^{-1}, & x \in \Omega_D^\epsilon, \\ J_U(\hat{\epsilon}, x) H_U(\hat{\epsilon}, x)^{-1}, & x \in \Omega_U^\epsilon, \end{cases}$$

is well-defined on the intersections of the domains and is an analytic function of x in a whole neighborhood of $x = 0$, including the points \hat{x}_R and \hat{x}_L . We will now prove that $\mathcal{Q}(\hat{\epsilon}, x)$ is unramified in ϵ . Since it is bounded at $\epsilon = 0$, this will imply the analyticity of $\mathcal{Q}(\epsilon, x)$ at $\epsilon = 0$. To prove that

$$(165) \quad \mathcal{Q}(\tilde{\epsilon}, x) = \mathcal{Q}(\bar{\epsilon}, x),$$

i.e.

$$(166) \quad J_s(\tilde{\epsilon}, x)^{-1} J_s(\bar{\epsilon}, x) = H_s(\tilde{\epsilon}, x)^{-1} H_s(\bar{\epsilon}, x), \quad s \in \{1, 2\},$$

we will consider $x \in \Omega_C^\epsilon \cap \Omega_C^{\tilde{\epsilon}}$. In this region, we have $J_U(\hat{\epsilon}, x) = J_D(\hat{\epsilon}, x)$ and $H_U(\hat{\epsilon}, x) = H_D(\hat{\epsilon}, x)$. By uniqueness of the Floquet solutions (Theorem 4.34), we have

$$(167) \quad H_D(\bar{\epsilon}, x) F_D(\bar{\epsilon}, x) \bar{T}_R K = H_D(\tilde{\epsilon}, x) F_D(\tilde{\epsilon}, x) \tilde{T}_L$$

with K a nonsingular diagonal matrix. Hence,

$$(168) \quad H_D(\bar{\epsilon}, x) F_D(\bar{\epsilon}, x) = H_D(\tilde{\epsilon}, x) F_D(\tilde{\epsilon}, x) Z,$$

with $Z = \tilde{T}_L K^{-1} \bar{T}_R^{-1}$. By Lemma 4.56, Z is in the block diagonal form $Z_{n_1} \oplus Z_{n_2} \oplus \dots \oplus Z_{n_k}$. By definition of $J_D(\hat{\epsilon}, x)$, we have

$$(169) \quad J_D(\bar{\epsilon}, x) F_D(\bar{\epsilon}, x) = J_D(\tilde{\epsilon}, x) F_D(\tilde{\epsilon}, x) Z.$$

Relations (168) and (169) yield (166). Finally, $\lim_{\epsilon \rightarrow 0} \mathcal{Q}(\epsilon, x)$ is bounded, so $\mathcal{Q}(\epsilon, x)$ is an analytic function of (ϵ, x) in a whole neighborhood of $(0, 0)$. The transformation $v = \mathcal{Q}(\epsilon, x)y$ gives a system with the fundamental matrix of solutions $J_s(\hat{\epsilon}, x) F_s(\hat{\epsilon}, x)$ on Ω_s^ϵ , and hence with the matrix in block diagonal form $B(\epsilon, x) = B_{n_1}(\epsilon, x) \oplus B_{n_2}(\epsilon, x) \oplus \dots \oplus B_{n_k}(\epsilon, x)$.

Finally, let us take a system (25) in which the unfolded Stokes matrices conjugated by a permutation matrix have the same decomposition in diagonal blocks. We apply the previous result to the system transformed by $y \mapsto Py$. \square

4.12. Unfolded Stokes matrices with trivial rows or column. We include here the study of the cases when both unfolded Stokes matrices have a trivial row or column (see Notation 4.32). When this happens, the system is analytically equivalent to a simpler one. This section is not a prerequisite to obtain the complete system of invariants of the systems (25).

Lemma 4.58. *For $\hat{\epsilon}$ in S_\cap and $j \in \{1, 2, \dots, n\}$, the following properties are equivalent, and they are satisfied for $\bar{\epsilon}$ if and only if they are satisfied for $\tilde{\epsilon}$:*

- (1) the j^{th} solution that is eigenvector of the monodromy operator around $x = \hat{x}_R$ is a multiple of the j^{th} solution that is eigenvector of the monodromy operator around $x = \hat{x}_L$;
- (2) the j^{th} column of the transition invariants \hat{N}_L and \hat{N}_R (Definition 4.49) is trivial;
- (3) the j^{th} columns of \hat{T}_R and \hat{T}_L are trivial;
- (4) the j^{th} columns of \hat{C}_R and \hat{C}_L are trivial;
- (5) the solution $w_j(\hat{\epsilon}, x)$, corresponding to the j^{th} column of $W_V(\hat{\epsilon}, x)$ given by (100), is eigenvector of the monodromy around both singular points.

Proof. It follows from (149). \square

Theorem 4.59. *A family of systems (25) with both unfolded Stokes matrices having the j^{th} column trivial for all $\hat{\epsilon} \in S$ is analytically equivalent to a family of system (25) with an invariant subsystem formed by the equations $i \neq j$ (i.e. the (i, j) entries are null for all $i \neq j$).*

Proof. We follow the same steps as in the proof of Theorem 4.57, considering the j^{th} column with nondiagonal entries null (instead of null entries outside diagonal blocks in Theorem 4.57), and taking a different definition of $J_s(\hat{\epsilon}, x)$. We take $J_s(\hat{\epsilon}, x) = \mathcal{Q}_s(\hat{\epsilon}, x)H_s(\hat{\epsilon}, x)$, with

$$(170) \quad (\mathcal{Q}_s(\hat{\epsilon}, x))_{ik} = \begin{cases} 1, & \text{if } i = k, \\ \frac{-(H_s(\hat{\epsilon}, x))_{ij}}{(H_s(\hat{\epsilon}, x))_{jj}}, & \text{if } k = j, i \neq k, \\ 0, & \text{otherwise.} \end{cases}$$

The j^{th} column of $J_s(\hat{\epsilon}, x)$ then has zero nondiagonal entries. The rest follows as in the proof of Theorem 4.57, using Lemma 4.58 instead of Lemma 4.56 (and forgetting about the last part of the proof about the permutation of the y -coordinates). \square

Lemma 4.60. *For $\hat{\epsilon}$ in S_{\cap} and $j \in \{1, 2, \dots, n\}$, the following properties are equivalent, and they are satisfied for $\bar{\epsilon}$ if and only if they are also for $\tilde{\epsilon}$:*

- (1) the j^{th} row of the transition invariants \hat{N}_L and \hat{N}_R is trivial;
- (2) the j^{th} rows of \hat{T}_R and \hat{T}_L are trivial;
- (3) the j^{th} rows of \hat{C}_R and \hat{C}_L are trivial.

Hence, in the j^{th} Riccati system, the property of a first integral \mathcal{H}_q^j to be an eigenvector of the monodromy around both singular points is conserved in both points of view $\bar{\epsilon}$ and $\tilde{\epsilon}$.

Proof. The first part follows from (149). The last part comes from Corollary 4.40: a first integral \mathcal{H}_q^j is eigenvector of the monodromy around both singular points if and only if rows q and j of the inverse of two unfolded Stokes matrices are trivial. \square

Theorem 4.61. *A family of systems (25) with both unfolded Stokes matrices having the j^{th} row trivial for all $\hat{\epsilon} \in S$ is analytically equivalent to a family of system (25) where the j^{th} equation is independent of the others, hence integrable (i.e. the (j, i) entries are null for all $i \neq j$).*

Proof. The proof of the analytic equivalence (to a system having (j, i) entries null for all $i \neq j$ with j fixed) is very similar to the proof of Theorem 4.57, considering

the j^{th} row with nondiagonal entries null (instead of null entries outside diagonal blocks in Theorem 4.57), and taking a different definition of $J_s(\hat{\epsilon}, x)$, namely

$$(171) \quad (J_s(\hat{\epsilon}, x))_{ik} = \begin{cases} (H_s(\hat{\epsilon}, x))_{ik}, & i \neq j, \\ 0, & i = j, \neq k \\ 1, & i = j = k. \end{cases}$$

We then follow the proof of Theorem 4.57, using Lemma 4.60 instead of Lemma 4.56 and forgetting about the last section of the proof that concerns permutation. \square

4.13. Analytic invariants. We now have the tools to prove that the equivalent unfolded Stokes collections are analytic invariants for the classification of the systems (25).

Theorem 4.62. *Two families of systems of the form (25) with the same model system (30) are analytically equivalent if and only if their unfolded Stokes collections are equivalent. In particular, a family (25) is analytically equivalent to its model if and only if the unfolded Stokes matrices are the identity.*

Proof. We consider two systems of the form (25):

$$(172) \quad (x^2 - \epsilon)y'_i = B_i(\epsilon, x)y_i,$$

with

$$(173) \quad B_i(\epsilon, x) = \Lambda(\epsilon, x) + (x^2 - \epsilon)R_i(\epsilon, x), \quad i = 1, 2,$$

and $\Lambda(\epsilon, x)$ given by (27). We choose a neighborhood of the origin \mathbb{D}_r common to the two systems for which the modulus is defined. We denote the fundamental matrix of solutions of (172) given by Theorem 4.22 as $H_{i,s}(\hat{\epsilon}, x)F_s(\hat{\epsilon}, x)$ (for $(\hat{\epsilon}, x) \in S \times \Omega_s^\hat{\epsilon}$, $s = D, U$).

Let us suppose that these two systems are analytically equivalent via a transformation $y_2 = \mathcal{Q}(\epsilon, x)y_1$. By Proposition 4.27, we must have

$$(174) \quad H_{2,s}(\hat{\epsilon}, x) = \mathcal{Q}(\epsilon, x)H_{1,s}(\hat{\epsilon}, x)\hat{K} \quad \text{on } \Omega_s^\hat{\epsilon}, \quad s = D, U,$$

with \hat{K} a nonsingular diagonal matrix depending analytically on $\hat{\epsilon} \in S$ with a nonsingular limit at $\epsilon = 0$ and such that (94) is satisfied. Then, on the intersections of $\Omega_D^\hat{\epsilon}$ and $\Omega_U^\hat{\epsilon}$, we have

$$(175) \quad (H_{2,D}(\hat{\epsilon}, x))^{-1}H_{2,U}(\hat{\epsilon}, x) = \hat{K}^{-1}(H_{1,D}(\hat{\epsilon}, x))^{-1}H_{1,U}(\hat{\epsilon}, x)\hat{K}.$$

This implies that the unfolded Stokes collections given by (92) are equivalent.

Let us prove the other direction. Let us suppose that the two systems above have equivalent Stokes collections $\{\hat{C}_R^i, \hat{C}_L^i\}$ with a matrix \hat{K} as in Definition 4.28, i.e.

$$(176) \quad \hat{C}_l^2 = \hat{K}\hat{C}_l^1\hat{K}^{-1}, \quad l = L, R.$$

By taking, for the second system, an adequate normalization of the fundamental matrix of solutions (namely changing from $H_{2,s}(\hat{\epsilon}, x)F_s(\hat{\epsilon}, x)$ to $H_{2,s}(\hat{\epsilon}, x)F_s(\hat{\epsilon}, x)\hat{K}$, $s = D, U$), we can, without loss of generality, suppose that

$$(177) \quad \hat{C}_l^2 = \hat{C}_l^1, \quad l = L, R.$$

First, let us suppose that the unfolded Stokes matrices \hat{C}_R^i and \hat{C}_L^i cannot have a block diagonal form (for all $\hat{\epsilon} \in S$) with the same positions of the blocks, neither

after conjugation of each of them by the same permutation matrix (that keeps their triangular form). We take

$$(178) \quad \mathcal{Q}(\hat{\epsilon}, x) = \begin{cases} H_{2,D}(\hat{\epsilon}, x)(H_{1,D}(\hat{\epsilon}, x))^{-1}, & \text{on } \Omega_D^{\hat{\epsilon}}, \\ H_{2,U}(\hat{\epsilon}, x)(H_{1,U}(\hat{\epsilon}, x))^{-1}, & \text{on } \Omega_U^{\hat{\epsilon}}, \end{cases}$$

which is well-defined because of (177). Since $\lim_{x \rightarrow \hat{x}_l} \mathcal{Q}(\hat{\epsilon}, x)$ is bounded, invertible and independent of s for $l = L, R$ (see (79)), $\mathcal{Q}(\hat{\epsilon}, x)$ is an analytic function of x on the whole neighborhood \mathbb{D}_r of $x = 0$ which includes the points \hat{x}_R and \hat{x}_L , for $\hat{\epsilon} \in S$. We will now choose carefully $\hat{\eta}$ such that $\hat{\eta}\mathcal{Q}(\hat{\epsilon}, x)$ becomes analytic at $\epsilon = 0$. We will prove that $\hat{\eta}\mathcal{Q}(\hat{\epsilon}, x)$ is uniform in ϵ and bounded near $\epsilon = 0$. The transformation $\mathcal{Q}(\bar{\epsilon}, x)\mathcal{Q}(\tilde{\epsilon}, x)^{-1}$ is an automorphism of the second family of systems (172). Hence, over each domain $\Omega_s^{\bar{\epsilon}}$, $s = D, U$, we have the following automorphism of the model

$$(179) \quad (H_{2,s}(\bar{\epsilon}, x))^{-1}\mathcal{Q}(\bar{\epsilon}, x)\mathcal{Q}(\tilde{\epsilon}, x)^{-1}H_{2,s}(\tilde{\epsilon}, x) = \bar{D}_s,$$

giving \bar{D}_s a diagonal matrix depending on $\bar{\epsilon}$. With relations (92) applied to the second system, (179) leads to

$$(180) \quad \bar{C}_l^2 \bar{D}_U = \bar{D}_D \bar{C}_l^2, \quad l \in \{R, L\}.$$

As the diagonal entries of \bar{C}_l are 1's, we have $\bar{D}_U = \bar{D}_D$. The hypothesis that the Stokes matrices have no common reduction to block diagonal form (neither after conjugation by a permutation matrix that keeps their triangular form) implies that this relation can only be satisfied for $\bar{D}_U = \bar{\mu}I$ for some $\bar{\mu}$ analytic function over S_{\cap} . Relation (179) becomes

$$(181) \quad \mathcal{Q}(\bar{\epsilon}, x)\mathcal{Q}(\tilde{\epsilon}, x)^{-1} = \bar{\mu}I.$$

In particular,

$$(182) \quad \mathcal{Q}(\bar{\epsilon}, 0)\mathcal{Q}(\tilde{\epsilon}, 0)^{-1} = \bar{\mu}I.$$

Using properties (77) and (78) (which remained valid when we modified $H_{2,s}(\hat{\epsilon}, x)$ to $H_{2,s}(\hat{\epsilon}, x)\hat{K}$, $s = D, U$), the definition (178) implies there exists $C \in \mathbb{R}_+$ such that

$$(183) \quad |\mathcal{Q}(\bar{\epsilon}, 0)\mathcal{Q}(\tilde{\epsilon}, 0)^{-1} - I| \leq C|\bar{\epsilon}|, \quad \bar{\epsilon} \in S_{\cap}.$$

Relation (182) and (183) imply there exists $c \in \mathbb{R}_+$ such that

$$(184) \quad |\bar{\mu} - 1| \leq c|\bar{\epsilon}|, \quad \bar{\epsilon} \in S_{\cap}.$$

Reducing slightly the radius ρ of S and its opening, let $\hat{\eta}$ be an analytic function of $\hat{\epsilon}$ on S satisfying

$$(185) \quad \hat{\eta}^{-1}\hat{\eta} = \bar{\mu}.$$

Of course, such a function can be found with $\lim_{\hat{\epsilon} \rightarrow 0} \hat{\eta} = 1$. Let $\mathcal{Q}^*(\hat{\epsilon}, x) = \hat{\eta}\mathcal{Q}(\hat{\epsilon}, x)$. From (181) and (185), we get

$$(186) \quad \mathcal{Q}^*(\bar{\epsilon}, x) = \mathcal{Q}^*(\tilde{\epsilon}, x).$$

Then,

$$(187) \quad \lim_{\epsilon \rightarrow 0} \mathcal{Q}^*(\epsilon, x) = H_{2,s}(0, x)(H_{1,s}(0, x))^{-1}, \quad x \in \Omega_s^0, \quad s = D, U,$$

which is finite, so $\mathcal{Q}^*(\epsilon, x)$ is analytic in ϵ at $\epsilon = 0$. Hence, $\mathcal{Q}^*(\epsilon, x)$ analytically conjugates the two systems.

Finally, let us suppose that both unfolded Stokes matrices of each system admit, after conjugation if necessary by the same permutation matrix that keeps their triangular form, the same maximal decomposition in diagonal blocks for all $\hat{\epsilon} \in S$. By Theorem 4.57, each system is analytically equivalent (with permutation P) to a system decomposed in smaller indecomposable systems. The decomposed systems have equivalent unfolded Stokes collections and the smaller indecomposable systems too. By applying the former argument to each pair of indecomposable systems, we find that they are analytically equivalent. Hence, the two decomposed systems are analytically equivalent, and so are the initial systems. \square

5. REALIZATION OF THE ANALYTIC INVARIANTS

By Section 4, the complete system of analytic invariants for the systems (25) consists of the formal invariants (the model system) and an equivalence class of unfolded Stokes matrices. In this section, we give the realization theorem for these invariants by proceeding in two steps. First, we consider the local realization :

Theorem 5.1. *Let a complete system of analytic invariants be given:*

- *a model system (i.e. formal invariants $\lambda_{j,q}(\epsilon)$, $j = 1, 2, \dots, n$, $q = 0, 1$, depending analytically on ϵ at the origin),*
- *an equivalence class (see Definition 4.28) of unfolded Stokes matrices \hat{C}_R and \hat{C}_L , which are respectively an upper triangular and a lower triangular unipotent matrix depending analytically on $\hat{\epsilon} \in S$ and having a bounded limit when $\hat{\epsilon} \rightarrow 0$ on S (the sector S of radius ρ_0 and of opening $2\pi + \gamma_0$ is chosen from the formal invariants as in Section 4.3, and ρ_0 can obviously be chosen smaller to ensure the analyticity, over S , of the entries of \hat{C}_R and \hat{C}_L).*

Then, there exist $r > 0$, a radius $\rho < \min\{\rho_0, \frac{r^2}{2}\}$ of S and a system $(x^2 - \epsilon)y' = A(\hat{\epsilon}, x)y$ ($y \in \mathbb{C}^n$) characterized by these analytic invariants, with $A(\hat{\epsilon}, x)$ analytic over $S \times \mathbb{D}_r$. The limit of $A(\hat{\epsilon}, x)$ when $\hat{\epsilon} \rightarrow 0$ ($\hat{\epsilon} \in S$) is analytic in x over \mathbb{D}_r .

We prove Theorem 5.1 from Sections 5.1 to 5.5. Then, we show that the auto-intersection relation (148) is sufficient for the global realization of the analytic invariants, i.e.:

Theorem 5.2. *Let a complete system of analytic invariants as described in Theorem 5.1 be given and satisfying the auto-intersection relation (148). Then, there exist $r > 0$, a radius $\rho < \min\{\rho_0, \frac{r^2}{2}\}$ of S and a system $(x^2 - \epsilon)y' = B(\epsilon, x)y$ ($y \in \mathbb{C}^n$) characterized by these analytic invariants, with $B(\epsilon, x)$ analytic over $\mathbb{D}_\rho \times \mathbb{D}_r$.*

The proof of Theorem 5.2 is presented from Sections 5.6 to 5.9. It uses the ramified system constructed in the proof of Theorem 5.1. The auto-intersection relation (148) will be the key ingredient to prove Theorem 5.2, namely to correct the family to a uniform family. It will guarantee the triviality of the abstract vector bundle realizing the family of Stokes matrices.

5.1. Introduction to the proof of Theorem 5.1. Considering $\hat{\epsilon}$ fixed, we realize the invariants on an abstract vector bundle which we then show to be trivial. For this, using ideas from the proof of the realization theorem at $\epsilon = 0$ in [10] (p. 150) and from the proof of Cartan's Lemma in [4] (p. 199), we will prove that, for

$s = D, U$ and sufficiently small radii ρ of S and r of Ω_s^ϵ , there exist matrices $H_s(\hat{\epsilon}, x)$ depending analytically on $(\hat{\epsilon}, x) \in S \times \Omega_s^\epsilon$, having a limit when $\hat{\epsilon} \rightarrow 0$ in S that is analytic in x over Ω_s^0 , and such that, for $\hat{\epsilon} \in S \cup \{0\}$,

$$(188) \quad H_D(\hat{\epsilon}, x)^{-1} H_U(\hat{\epsilon}, x) = I + Z(\hat{\epsilon}, x), \quad x \in \Omega_U^\epsilon \cap \Omega_D^\epsilon,$$

where

$$(189) \quad Z(\hat{\epsilon}, x) = \begin{cases} F_D(\hat{\epsilon}, x) \hat{C}_R F_D(\hat{\epsilon}, x)^{-1} - I & \text{on } \Omega_R^\epsilon, \\ F_D(\hat{\epsilon}, x) \hat{C}_L F_D(\hat{\epsilon}, x)^{-1} - I & \text{on } \Omega_L^\epsilon, \\ 0 & \text{on } \Omega_C^\epsilon, \end{cases}$$

with $F_s(\hat{\epsilon}, x)$ a fundamental matrix of solutions of the model system (as in Notation 4.20) which is completely determined by the given formal invariants.

Then, we consider

$$(190) \quad W_s(\hat{\epsilon}, x) = H_s(\hat{\epsilon}, x) F_s(\hat{\epsilon}, x), \quad (\hat{\epsilon}, x) \in (S \cup \{0\}) \times \Omega_s^\epsilon, \quad s = D, U.$$

Relations (188) implies that

$$(191) \quad W'_D(\hat{\epsilon}, x) W_D(\hat{\epsilon}, x)^{-1} = W'_U(\hat{\epsilon}, x) W_U(\hat{\epsilon}, x)^{-1}, \quad \text{on } \Omega_\cap^\epsilon, \quad \hat{\epsilon} \in (S \cup \{0\}),$$

so that

$$(192) \quad A(\hat{\epsilon}, x) = \begin{cases} (x^2 - \epsilon) W'_D(\hat{\epsilon}, x) W_D(\hat{\epsilon}, x)^{-1}, & \text{on } \Omega_D^\epsilon, \\ (x^2 - \epsilon) W'_U(\hat{\epsilon}, x) W_U(\hat{\epsilon}, x)^{-1}, & \text{on } \Omega_U^\epsilon, \end{cases}$$

is well-defined and hence analytic over $(S \cup \{0\}) \times (\mathbb{D}_r \setminus \{\hat{x}_R, \hat{x}_L\})$.

We will prove the boundedness of $H_s(\hat{\epsilon}, x)$, $H_s(\hat{\epsilon}, x)^{-1}$ and $H'_s(\hat{\epsilon}, x)$ near $x = \hat{x}_l$, for $\hat{\epsilon} \in (S \cup \{0\})$, $s = D, U$ and $l = L, R$. This implies that $A(\hat{\epsilon}, x)$ is analytic over $S \times \mathbb{D}_r$ and has a limit when $\hat{\epsilon} \rightarrow 0$ (with $\hat{\epsilon} \in S$) that is analytic in x over \mathbb{D}_r , since

$$(193) \quad \begin{aligned} & (x^2 - \epsilon) W'_s(\hat{\epsilon}, x) W_s(\hat{\epsilon}, x)^{-1} \\ &= (x^2 - \epsilon) H'_s(\hat{\epsilon}, x) H_s(\hat{\epsilon}, x)^{-1} + H_s(\hat{\epsilon}, x) \Lambda(\epsilon, x) H_s(\hat{\epsilon}, x)^{-1}. \end{aligned}$$

$H_s(\hat{\epsilon}, x)$ will be obtained in Section 5.5 from a specific sequence of matrices constructed in Section 5.4. This proof needs adequate choice of radii r of Ω_s^ϵ and ρ of S .

5.2. Choice of the radius r for the domains in the x -variable. First, we choose r by considering the case $\epsilon = 0$. For $r > 0$, let us take Ω_D and Ω_U as in Definition 2.2 (Figure 1) and let

$$(194) \quad \begin{aligned} \Omega_{D,\beta} &= \{x \in \mathbb{C} : |x| < r, -(\pi + \delta + \beta) < \arg(x) < \delta + \beta\}, \\ \Omega_{U,\beta} &= \{x \in \mathbb{C} : |x| < r, -(\delta + \beta) < \arg(x) < \pi + \delta + \beta\}, \end{aligned}$$

with $\beta > 0$ sufficiently small so that the closure of $\Omega_{s,\beta}$ does not contain more separation rays (Definition 2.1) than Ω_s , $s = D, U$ (Figure 18). From these domains, we define domains having their part of the boundary other than the part $\{|x| = r\}$ included in some solution curves of the system $\dot{x} = x^2 - \epsilon$ allowing complex time. The procedure explained in Section 4.4 yields Ω_s^0 (respectively $\Omega_{s,\beta}^0$) included in Ω_s (respectively $\Omega_{s,\beta}$), for $s = D, U$ (Figure 18). In the course of the proof, for domains denoted by the letter Ω , we use the notation

$$(195) \quad \Omega_\cap = \Omega_U \cap \Omega_D = \Omega_L \cup \Omega_C \cup \Omega_R.$$

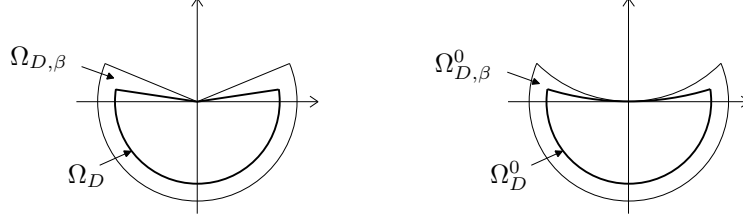
FIGURE 18. Sectorial domains Ω_D , $\Omega_{D,\beta}$, Ω_D^0 and $\Omega_{D,\beta}^0$.

We now define domains $\Omega_s^0(\nu)$ included in $\Omega_{s,\beta}^0$ and converging when $\nu \rightarrow \infty$ to Ω_s^0 . In the t -variable (see Section 4.4), let us define the neighborhoods $\Gamma_s^0(\nu)$ (Figure 19) of Γ_s^0 (which is the domain corresponding to Ω_s^0 in the t -variable):

$$(196) \quad \Gamma_s^0(\nu) = \{z : \exists t \in \Gamma_s^0 \text{ s.t. } |z - t| \frac{|z|}{|t|} < 2^{-\nu} \theta\}, \quad \nu \geq 1, s = D, U.$$

We choose $\theta > 0$ such that $\Gamma_s^0(1)$ is included in $\Gamma_{s,\beta}^0$ (which is the domain corre-

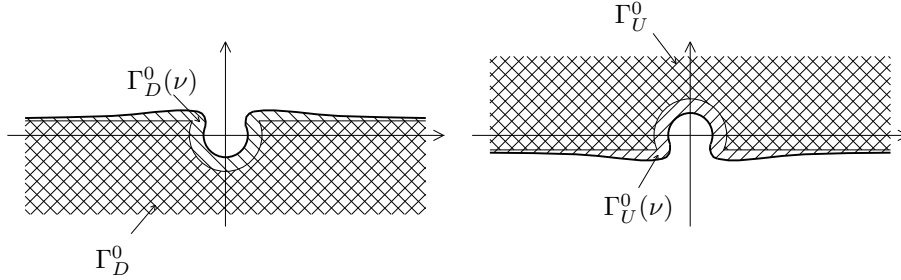
FIGURE 19. A neighborhood $\Gamma_s^0(\nu)$ of Γ_s^0 , $s = D, U$.

sponding to $\Omega_{s,\beta}^0$ in the t -variable). In the x -variable, the domains $\Gamma_s^0(\nu)$ correspond to

$$(197) \quad \Omega_s^0(\nu) = \{y : \exists x \in \Omega_s^0 \text{ s.t. } |y - x| < 2^{-\nu} \theta |y|^2\}, \quad \nu \geq 0, s = D, U.$$

As illustrated in Figure 20, we write the boundary of $\Omega_\cap^0(\nu) = \Omega_U^0(\nu) \cap \Omega_D^0(\nu)$ as

$$(198) \quad \partial\Omega_\cap^0(\nu) = \gamma_{\nu,U}^0 \cup \gamma_{\nu,D}^0,$$

denoting $\gamma_{\nu,s}^0 \subset \partial\Omega_\cap^0(\nu)$ the path included in the boundary of $\Omega_s^0(\nu)$, $s = D, U$ starting at $x = -r$ and ending at $x = r$.

Asymptotic properties of $Z(0, x)$ imply that $\forall N \in \mathbb{N}^*$ there exists $K_N^0 \in \mathbb{R}_+$ such that

$$(199) \quad |Z(0, x)| \leq K_N^0 |x|^N, \quad x \in \Omega_l^0(\theta), l = L, R.$$

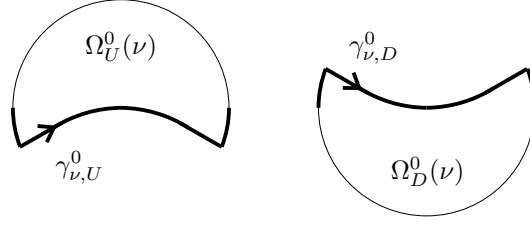
FIGURE 20. Integration path $\gamma_{\nu,s}^0 \subset \partial\Omega_s^0(\nu)$, $s = D, U$.

We take r sufficiently small so that the length of each path $\gamma_{\nu,s}^0$ is bounded by a constant c_s^0 such that

$$(200) \quad \int_{\gamma_{\nu,s}^0} |dh| < c_s^0 < \min \left\{ \frac{\pi\theta}{2^4 K_2^0}, \frac{\pi}{K_1^0} \right\}, \quad \nu \geq 1, s = D, U.$$

5.3. Choice of radius ρ of S and sequence of spiraling domains. First, let us take the radius $\rho > 0$ for S such that $\rho < \min\{\rho_0, \frac{r^2}{2}\}$. Restricting ρ if necessary, we construct, as in Section 4.4, sectorial domains $\Omega_s^{\hat{\epsilon}}$ (respectively $\Omega_{s,\beta}^{\hat{\epsilon}}$) that differ from Ω_s^0 (respectively $\Omega_{s,\beta}^0$) mainly inside a small disk. $\Omega_{s,\beta}^{\hat{\epsilon}}$ is a neighborhood of $\Omega_s^{\hat{\epsilon}}$ (see Figure 21). As in Figure 10, these sectorial domains may spiral around the singular points, depending on the value of $\hat{\epsilon}$. Nevertheless, $\Omega_s^{\hat{\epsilon}}$ always stay inside $\Omega_{s,\beta}^{\hat{\epsilon}}$.

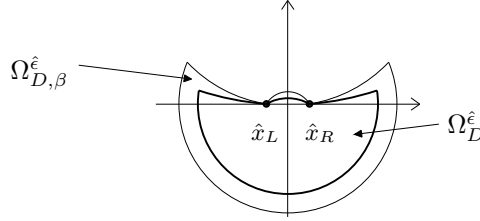
FIGURE 21. Sectorial domains $\Omega_D^{\hat{\epsilon}}$ and $\Omega_{D,\beta}^{\hat{\epsilon}}$, case $\sqrt{\hat{\epsilon}} \in \mathbb{R}_+^*$.

For $\nu \geq 1$, we define the spiraling domains $\Omega_s^{\hat{\epsilon}}(\nu)$ which converge when $\nu \rightarrow \infty$ to $\Omega_s^{\hat{\epsilon}}$ and are included in $\Omega_{s,\beta}^{\hat{\epsilon}}$ for ρ sufficiently small:

$$(201) \quad \Omega_s^{\hat{\epsilon}}(\nu) = \Omega_s^{\hat{\epsilon}} \cup_{l=L,R} \{y : \exists x \in \Omega_l^{\hat{\epsilon}} \text{ s.t. } |y-x| < 2^{-\nu}\theta|y-\hat{x}_l|^2\}, \quad \hat{\epsilon} \in S \cup \{0\}, s = D, U.$$

The spirals of $\Omega_s^{\hat{\epsilon}}(\nu)$ near $x = \hat{x}_l$ are approximately logarithmic.

As illustrated in Figure 22, we denote as $\gamma_{\nu,s}^{\hat{\epsilon}} = \gamma_{\nu,s,L}^{\hat{\epsilon}} \cup \gamma_{\nu,s,R}^{\hat{\epsilon}}$ the broken path included in the boundary of $\Omega_s^{\hat{\epsilon}}(\nu)$, $s = D, U$. The path $\gamma_{\nu,s,L}^{\hat{\epsilon}}$ starts at $x = -r$ and ends at $x = \hat{x}_L$, whereas $\gamma_{\nu,s,R}^{\hat{\epsilon}}$ starts at $x = \hat{x}_R$ and ends at $x = r$. Remember that they may spiral near the singular points.

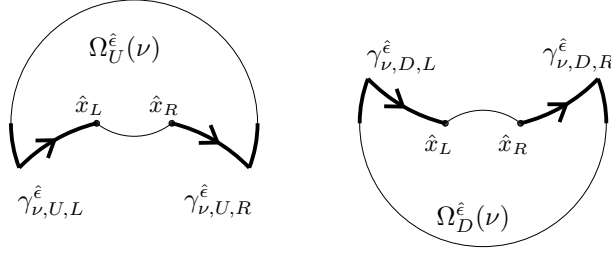

FIGURE 22. Integration path $\gamma_{\nu,s}^{\hat{\epsilon}} = \gamma_{\nu,s,L}^{\hat{\epsilon}} \cup \gamma_{\nu,s,R}^{\hat{\epsilon}}$, $s = D, U$, case $\sqrt{\hat{\epsilon}} \in \mathbb{R}_-^*$.

Reducing ρ if necessary, properties of $Z(\hat{\epsilon}, x)$ (from (189)) on $\Omega_{L,\beta}^{\hat{\epsilon}}$ and $\Omega_{R,\beta}^{\hat{\epsilon}}$ imply that, for $N = 1, 2, 3, 4$, there exists $K_N \in \mathbb{R}_+$ ($K_N \geq K_N^0$) such that

$$(202) \quad |Z(\hat{\epsilon}, x)| \leq K_N |x - \hat{x}_l|^N, \quad (\hat{\epsilon}, x) \in (S \cup \{0\}) \times \Omega_l^{\hat{\epsilon}}(1), \quad l = L, R.$$

Also,

$$(203) \quad Z(\hat{\epsilon}, x) = 0 \quad (\hat{\epsilon}, x) \in S \times \Omega_C^{\hat{\epsilon}}(1).$$

We reduce ρ in order to have

$$(204) \quad \int_{\gamma_{\nu,s}^{\hat{\epsilon}}} |dh| = c_s \leq \min \left\{ \frac{\pi\theta}{2^4 K_2}, \frac{\pi}{2^2 K_1} \right\}, \quad \nu \geq 1, \quad \hat{\epsilon} \in S \cup \{0\}, \quad s = D, U,$$

(since the spirals are logarithmic, they have finite length).

5.4. Construction of a specific sequence Z^ν , Z_U^ν and Z_D^ν . In this section, starting from $Z^1 = Z(\hat{\epsilon}, x)$, we construct, for $\nu = 2, 3, \dots$, a sequence of matrices Z^ν , Z_U^ν and Z_D^ν such that the following four conditions are satisfied:

- (I) $Z^{\nu-1} = Z_U^\nu - Z_D^\nu$, for $(\hat{\epsilon}, x) \in (S \cup \{0\}) \times \Omega_{\hat{\rho}}^{\hat{\epsilon}}(\nu-1)$;
- (II) for $s = D, U$,
 - $Z_s^\nu(\hat{\epsilon}, x)$ is analytic on $S \times \Omega_s^{\hat{\epsilon}}(\nu-1)$,
 - $Z_s^\nu(0, x)$ is analytic for $x \in \Omega_s^0(\nu-1)$,
 - $|Z_s^\nu| \leq 2^{-(\nu+1)}$ for $(\hat{\epsilon}, x) \in (S \cup \{0\}) \times \Omega_s^{\hat{\epsilon}}(\nu)$
- (III) $I + Z^\nu = (I + Z_D^\nu)(I + Z^{\nu-1})(I + Z_U^\nu)^{-1}$, $(\hat{\epsilon}, x) \in (S \cup \{0\}) \times \Omega_{\hat{\rho}}^{\hat{\epsilon}}(\nu-\delta)$ for some $0 < \delta < 1$;
- (IV) • $Z^\nu(0, x)$ is analytic over $\Omega_{\hat{\rho}}^0(\nu-\delta)$,
 - $Z^\nu(\hat{\epsilon}, x) = 0$ on $S \times \Omega_C^{\hat{\epsilon}}(\nu-\delta)$,
 - $Z^\nu(\hat{\epsilon}, x)$ is analytic on $S \times \Omega_{\hat{\rho}}^{\hat{\epsilon}}(\nu-\delta)$ and satisfies, for $N = 1, 2, 3, 4$, $|Z^\nu| \leq 2^{-2(\nu-1)} K_N |x - \hat{x}_l|^N$ for $(\hat{\epsilon}, x) \in (S \cup \{0\}) \times \Omega_l^{\hat{\epsilon}}(\nu)$, $l = L, R$.

In order to obtain condition (I), we define the matrices $Z_D^\nu(\hat{\epsilon}, x)$ and $Z_U^\nu(\hat{\epsilon}, x)$ for $\nu = 2, 3, \dots$ by

$$(205) \quad Z_s^\nu(\hat{\epsilon}, x) = \frac{1}{2\pi i} \int_{\gamma_{\nu-1, s}^{\hat{\epsilon}}} \frac{Z^{\nu-1}(\hat{\epsilon}, h)}{h-x} dh, \quad (\hat{\epsilon}, x) \in (S \cup \{0\}) \times \Omega_s^{\hat{\epsilon}}(\nu-1), \quad s = D, U.$$

Condition (I) is satisfied since, for $(\hat{\epsilon}, x) \in (S \cup \{0\}) \times \Omega_{\cap}^{\hat{\epsilon}}(\nu-1)$,

$$(206) \quad Z_U^\nu(\hat{\epsilon}, x) - Z_D^\nu(\hat{\epsilon}, x) = \frac{1}{2\pi i} \int_{\gamma_{\nu-1}^{\hat{\epsilon}}} \frac{Z^{\nu-1}(\hat{\epsilon}, h)}{h-x} dh = Z^{\nu-1}(\hat{\epsilon}, x),$$

where $\gamma_{\nu-1}^{\hat{\epsilon}}$ (Figure 23) is a union of two paths surrounding $\Omega_L^{\hat{\epsilon}}(\nu-1)$ and $\Omega_R^{\hat{\epsilon}}(\nu-1)$:

$$(207) \quad \gamma_{\nu-1}^{\hat{\epsilon}} = \gamma_{\nu-1, U, L}^{\hat{\epsilon}}(\gamma_{\nu-1, D, L}^{\hat{\epsilon}})^{-1} \cup \gamma_{\nu-1, U, R}^{\hat{\epsilon}}(\gamma_{\nu-1, D, R}^{\hat{\epsilon}})^{-1}.$$

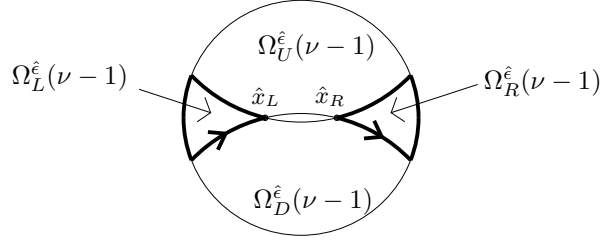

FIGURE 23. Integration path $\gamma_{\nu-1}^{\hat{\epsilon}}$, case $\sqrt{\hat{\epsilon}} \in \mathbb{R}_+^*$.

Let us now prove (II) for $\nu \geq 2$, taking into account that (IV) is satisfied (it is indeed for $\nu = 1$). When integrating in (205), we have

$$(208) \quad |h-x| \geq 2^{-\nu} \theta |h - \hat{x}_l|^2, \quad h \in \gamma_{\nu-1, s}^{\hat{\epsilon}}, \quad x \in \Omega_s^{\hat{\epsilon}}(\nu), \quad \hat{\epsilon} \in S \cup \{0\}, \quad s = D, U, \quad l = L, R.$$

Then, using (IV) as well as relations (204) and (208), we have, for $s = D, U$,

$$(209) \quad \begin{aligned} |Z_s^\nu(\hat{\epsilon}, x)| &\leq \frac{1}{2\pi} \int_{\gamma_{\nu-1, s}^{\hat{\epsilon}}} \frac{|Z^{\nu-1}(\hat{\epsilon}, h)|}{|h-x|} |dh|, & (\hat{\epsilon}, x) \in (S \cup \{0\}) \times \Omega_s^{\hat{\epsilon}}(\nu), \\ &\leq \frac{2^{-2(\nu-2)} K_{2c_s}}{2\pi 2^{-\nu} \theta} \leq 2^{-(\nu+1)}, & (\hat{\epsilon}, x) \in (S \cup \{0\}) \times \Omega_s^{\hat{\epsilon}}(\nu). \end{aligned}$$

Let us now prove condition (IV), taking Z^ν defined by relation (III) (there exists some $0 < \delta < 1$ such that $(I + Z_U^\nu)$ is invertible for $(\hat{\epsilon}, x) \in (S \cup \{0\}) \times \Omega_{\cap}^{\hat{\epsilon}}(\nu - \delta)$). On each side of (III), multiplying by $(I + Z_U^\nu)$ on the right yields

$$(210) \quad Z_U^\nu + Z^\nu(I + Z_U^\nu) = Z^{\nu-1} + Z_D^\nu + Z_D^\nu Z^{\nu-1}, \quad (\hat{\epsilon}, x) \in (S \cup \{0\}) \times \Omega_{\cap}^{\hat{\epsilon}}(\nu).$$

Using condition (I), it yields

$$(211) \quad Z^\nu(I + Z_U^\nu) = Z_D^\nu Z^{\nu-1}, \quad (\hat{\epsilon}, x) \in (S \cup \{0\}) \times \Omega_{\cap}^{\hat{\epsilon}}(\nu).$$

Hence,

$$(212) \quad \begin{aligned} |Z^\nu| &\leq |Z_D^\nu| |Z^{\nu-1}| |(I + Z_U^\nu)^{-1}| & (\hat{\epsilon}, x) \in (S \cup \{0\}) \times \Omega_{\cap}^{\hat{\epsilon}}(\nu) \\ &\leq |Z_D^\nu| |Z^{\nu-1}| \frac{1}{1 - |Z_U^\nu|} & (\hat{\epsilon}, x) \in (S \cup \{0\}) \times \Omega_{\cap}^{\hat{\epsilon}}(\nu), \end{aligned}$$

the last inequality obtained since $|Z_U^\nu| < \frac{1}{2}$. Because of (203), we have

$$(213) \quad Z^\nu(\hat{\epsilon}, x) = 0 \text{ on } S \times \Omega_C^{\hat{\epsilon}}(\nu).$$

Finally, we finish the proof of (IV) from condition (II) and the induction hypothesis into (212): for $N \leq 4$ and $l = L, R$, we have

$$(214) \quad \begin{aligned} |Z^\nu| &\leq 2^{-(\nu+1)}(2^{-2(\nu-2)}K_N|x - \hat{x}_l|^N)\left(\frac{1}{1-2^{-(\nu+1)}}\right), & (\hat{\epsilon}, x) \in (S \cup \{0\}) \times \Omega_l^\epsilon(\nu), \\ &\leq 2^{-2(\nu-1)}K_N|x - \hat{x}_l|^N, & (\hat{\epsilon}, x) \in (S \cup \{0\}) \times \Omega_l^\epsilon(\nu). \end{aligned}$$

5.5. Construction of $H_D(\hat{\epsilon}, x)$ and $H_U(\hat{\epsilon}, x)$. The sequence of matrices Z^ν , Z_U^ν and Z_D^ν constructed in Section 5.4 satisfies condition (III) and hence, for $(\hat{\epsilon}, x) \in (S \cup \{0\}) \times \Omega_\cap^\epsilon(\nu)$,

$$(215) \quad \begin{aligned} I + Z(\hat{\epsilon}, x) &= I + Z^1 = \\ &[(I + Z_D^\nu) \dots (I + Z_D^3)(I + Z_D^2)]^{-1} (I + Z^\nu) [(I + Z_U^\nu) \dots (I + Z_U^3)(I + Z_U^2)]. \end{aligned}$$

Since

$$(216) \quad \lim_{\nu \rightarrow \infty} Z^\nu = 0, \quad (\hat{\epsilon}, x) \in (S \cup \{0\}) \times \Omega_\cap^\epsilon(\nu),$$

and

$$(217) \quad \prod_{\nu=2}^{\infty} |1 + Z_s^\nu| \leq \prod_{\nu=2}^{\infty} (1 + 2^{-(\nu+1)}), \quad (\hat{\epsilon}, x) \in (S \cup \{0\}) \times \Omega_s^\epsilon(\nu), \quad s = D, U,$$

the products in brackets are convergent in (215) when $\nu \rightarrow \infty$ and we are led to matrices satisfying (188) (details in Lemma 4 from the proof of Cartan's Lemma in [4] p. 195):

$$(218) \quad H_s(\hat{\epsilon}, x) = \lim_{\nu \rightarrow \infty} (I + Z_s^\nu) \dots (I + Z_s^3)(I + Z_s^2), \quad (\hat{\epsilon}, x) \in (S \cup \{0\}) \times \Omega_s^\epsilon(\nu), \quad s = D, U.$$

The boundedness of $H_s(\hat{\epsilon}, x)$ and $H_s(\hat{\epsilon}, x)^{-1}$ when $x \rightarrow \hat{x}_l$, $x \in \Omega_s^\epsilon$, $\hat{\epsilon} \in S \cup \{0\}$, $s = D, U$, $l = L, R$, is obtained from (IV) and from the fact that the limit of the products in brackets in (215) are invertible and convergent when $\nu \rightarrow \infty$.

Let us now prove that $H_s'(\hat{\epsilon}, x) = \frac{\partial H_s(\hat{\epsilon}, x)}{\partial x}$ is bounded when $x \rightarrow \hat{x}_l$, $x \in \Omega_s^\epsilon$, $\hat{\epsilon} \in S \cup \{0\}$, $l = L, R$ and $s = D, U$, by proving there exists $K \in \mathbb{R}_+$ such that

$$(219) \quad |H_s(\hat{\epsilon}, \hat{x}_l + t) - H_s(\hat{\epsilon}, \hat{x}_l)| \leq K|t|, \quad \hat{x}_l + t \in \Omega_s^\epsilon.$$

First, let us prove there exists $k \in \mathbb{R}_+$ such that

$$(220) \quad |Z_s^\nu(\hat{\epsilon}, \hat{x}_l + t) - Z_s^\nu(\hat{\epsilon}, \hat{x}_l)| \leq 2^{-\nu}k|t|, \quad \hat{x}_l + t \in \Omega_s^\epsilon(\nu).$$

Using (205), (IV), (208) and (204), we have, for t such that $\hat{x}_l + t \in \Omega_s^\epsilon(\nu)$,

$$(221) \quad \begin{aligned} |Z_s^\nu(\hat{\epsilon}, \hat{x}_l + t) - Z_s^\nu(\hat{\epsilon}, \hat{x}_l)| &= \frac{1}{2\pi} \left| \int_{\gamma_{\nu-1, s}^\epsilon} Z^{\nu-1}(\hat{\epsilon}, h) \left(\frac{1}{h - (\hat{x}_l + t)} - \frac{1}{h - \hat{x}_l} \right) dh \right| \\ &\leq \frac{|t|}{2\pi} \left| \int_{\gamma_{\nu-1, s}^\epsilon} \frac{|Z^{\nu-1}(\hat{\epsilon}, h)|}{|h - (\hat{x}_l + t)||h - \hat{x}_l|} |dh| \right| \\ &\leq \frac{|t|}{2\pi} \frac{K_3 2^\nu c_s}{2^{2(\nu-2)}\theta} \\ &\leq |t| \frac{K_3}{2^{\nu+1}K_2}, \end{aligned}$$

thus proving (220) with $k = \frac{K_3}{2K_2}$. To obtain (219) from (220), let us denote shortly

$$(222) \quad Z_s^\nu(\hat{\epsilon}, \hat{x}_l) = \hat{Z}_{s, l}^\nu, \quad Z_s^\nu(\hat{\epsilon}, \hat{x}_l + t) = \hat{Z}_{s, t}^\nu.$$

From (218), we have

$$(223) \quad \begin{aligned} & |H_s(\hat{\epsilon}, \hat{x}_l + t) - H_s(\hat{\epsilon}, \hat{x}_l)| \\ &= \lim_{\nu \rightarrow \infty} |(I + \hat{Z}_{s,t}^\nu) \dots (I + \hat{Z}_{s,t}^3)(I + \hat{Z}_{s,t}^2) - (I + \hat{Z}_{s,l}^\nu) \dots (I + \hat{Z}_{s,l}^3)(I + \hat{Z}_{s,l}^2)|. \end{aligned}$$

Using (220) and (II), we can bound (223) and obtain (219) from:

$$(224) \quad \begin{aligned} & |H_s(\hat{\epsilon}, \hat{x}_l + t) - H_s(\hat{\epsilon}, \hat{x}_l)| \\ & \leq \lim_{\nu \rightarrow \infty} \sum_{i=2}^\nu |\hat{Z}_{s,t}^i - \hat{Z}_{s,l}^i| \prod_{q=2}^{i-1} |I + \hat{Z}_{s,t}^q| \prod_{p=i+1}^\nu |I + \hat{Z}_{s,l}^p| \\ & \leq \lim_{\nu \rightarrow \infty} \sum_{i=2}^\nu \frac{|I + \hat{Z}_{s,l}^i|}{1 - 2^{-(i+1)}} |\hat{Z}_{s,t}^i - \hat{Z}_{s,l}^i| \prod_{q=2}^{i-1} |I + \hat{Z}_{s,t}^q| \prod_{p=i+1}^\nu |I + \hat{Z}_{s,l}^p| \\ & \leq \lim_{\nu \rightarrow \infty} \sum_{i=2}^\nu \frac{|\hat{Z}_{s,t}^i - \hat{Z}_{s,l}^i|}{1 - 2^{-(i+1)}} \prod_{p=2}^\nu (1 + 2^{-(p+1)}) \\ & \leq \lim_{\nu \rightarrow \infty} \sum_{i=2}^\nu \frac{k|t|}{2^{i(1-2^{-(i+1)})}} \prod_{p=2}^\nu (1 + 2^{-(p+1)}) \\ & \leq \lim_{\nu \rightarrow \infty} k|t| \sum_{i=2}^\nu 2^{-(i-1)} \prod_{p=2}^\nu (1 + 2^{-(p+1)}). \end{aligned}$$

This section concludes the proof of Theorem 5.1. \square

5.6. Introduction to the proof of Theorem 5.2. From now on and until the end of Section 5, we present the proof of Theorem 5.2, using the proof of Theorem 5.1.

Since the given system of invariants satisfy the auto-intersection relation (148), Theorem 4.54 allows us to take, without loss of generality, the unfolded Stokes matrices as $\frac{1}{2}$ -summable in ϵ and then, by (161), the corresponding matrices \tilde{N}_R and \bar{N}_R (Definition 4.49) satisfy

$$(225) \quad \bar{N}_R = \tilde{N}_R \bar{Q},$$

with \bar{Q} a nonsingular diagonal matrix exponentially close to I in $\sqrt{\epsilon}$. Let

$$(226) \quad (x^2 - \epsilon)v' = A(\hat{\epsilon}, x)v$$

be the system constructed in the proof of Theorem 5.1 by using the $\frac{1}{2}$ -summable unfolded Stokes matrices. We will correct the system (226) by a transformation $y = J(\hat{\epsilon}, x)v$ (defined for $(\hat{\epsilon}, x) \in S \times \mathbb{D}_r$) to obtain a system $(x^2 - \epsilon)y' = B(\epsilon, x)y$ with $B(\epsilon, x)$ analytic in ϵ at $\epsilon = 0$. The condition (225) will be used in the correction of the family.

5.7. The correction to a uniform family. Let $\bar{\epsilon}$ and $\tilde{\epsilon} = \bar{\epsilon}e^{2\pi i}$ in S_\cap . Similarly as in Proposition 4.53, \bar{N}_R (respectively \tilde{N}_R) is the transition matrix $E_{R, \bar{x}_R \rightarrow \bar{x}_L}$ (respectively $E_{R, \tilde{x}_L \rightarrow \tilde{x}_R}$) between $H_D(\bar{\epsilon}, x)F_D(\bar{\epsilon}, x)\bar{T}_R$ and $H_U(\bar{\epsilon}, x)F_U(\bar{\epsilon}, x)\bar{D}_R\bar{T}_L\bar{D}_R^{-1}$ (respectively $H_D(\tilde{\epsilon}, x)F_D(\tilde{\epsilon}, x)\tilde{T}_L$ and $H_U(\tilde{\epsilon}, x)F_U(\tilde{\epsilon}, x)\tilde{D}_R\tilde{T}_R\tilde{D}_R^{-1}$). Because the transition matrices satisfy (225), Proposition 4.44 implies that there exists an invertible transformation $P(\bar{\epsilon}, x)$ analytic in $(\bar{\epsilon}, x) \in S_\cap \times \mathbb{D}_r$ and conjugating the systems $(x^2 - \epsilon)v' = A(\bar{\epsilon}, x)v$ and $(x^2 - \epsilon)v' = A(\tilde{\epsilon}, x)v$, i.e.

$$(227) \quad A(\tilde{\epsilon}, x) = P(\bar{\epsilon}, x)A(\bar{\epsilon}, x)P(\bar{\epsilon}, x)^{-1} + (x^2 - \epsilon)P(\bar{\epsilon}, x)'P(\bar{\epsilon}, x)^{-1}.$$

We need to go inside the details of the construction of $P(\bar{\epsilon}, x)$ to estimate its growth. $P(\bar{\epsilon}, x)$ is as follows:

$$(228) \quad P(\bar{\epsilon}, x) = \begin{cases} H_U(\tilde{\epsilon}, x)F_U(\tilde{\epsilon}, x)\tilde{D}_R\tilde{T}_R\tilde{D}_R^{-1}\bar{Q} \\ \quad \times (H_U(\bar{\epsilon}, x)F_U(\bar{\epsilon}, x)[\bar{D}_R\bar{T}_L\bar{D}_R^{-1}])^{-1}, & x \in \Omega_U^{\bar{\epsilon}} \cap \Omega_U^{\tilde{\epsilon}}, \\ H_D(\tilde{\epsilon}, x)F_D(\tilde{\epsilon}, x)\tilde{T}_L (H_D(\bar{\epsilon}, x)F_D(\bar{\epsilon}, x)\bar{T}_R)^{-1}, & x \in \Omega_D^{\bar{\epsilon}} \cap \Omega_D^{\tilde{\epsilon}}. \end{cases}$$

$P(\bar{\epsilon}, x)$ is well-defined (to verify, use (188), (75) and (107)) and can be analytically extended to \mathbb{D}_r . It satisfies $P(0, x) = I$ (see Lemma 4.48).

In Section 5.8, we will show that there exists $\mathcal{K}_1 \in \mathbb{R}_+$ such that

$$(229) \quad |P(\bar{\epsilon}, x) - I| \leq \mathcal{K}_1 |\bar{\epsilon}|, \quad (\bar{\epsilon}, x) \in (S_\cap \cup \{0\}) \times \mathbb{D}_r.$$

This leads to the proof, sketched in Section 5.9, of the existence of $J(\hat{\epsilon}, x)$, a non-singular matrix depending analytically on $(\hat{\epsilon}, x) \in S \times B_r$ such that

$$(230) \quad J(\tilde{\epsilon}, x)^{-1} J(\bar{\epsilon}, x) = P(\bar{\epsilon}, x)$$

on S_\cap and such that $J(\hat{\epsilon}, x)$, $J'(\hat{\epsilon}, x)$ and $J(\hat{\epsilon}, x)^{-1}$ have a bounded limit at $\epsilon = 0$ (this proof requires slight reductions of the radius and opening of S).

Let $(x^2 - \epsilon)y' = B(\hat{\epsilon}, x)y$ be the system obtained by the change $y = J(\hat{\epsilon}, x)v$ into (226). We have

$$(231) \quad B(\hat{\epsilon}, x) = J(\hat{\epsilon}, x)A(\hat{\epsilon}, x)J(\hat{\epsilon}, x)^{-1} + (x^2 - \epsilon)J(\hat{\epsilon}, x)'J(\hat{\epsilon}, x)^{-1}.$$

Replacing (230) into (227), we get

$$(232) \quad \begin{aligned} & J(\tilde{\epsilon}, x)A(\tilde{\epsilon}, x)J(\tilde{\epsilon}, x)^{-1} + (x^2 - \epsilon)J(\tilde{\epsilon}, x)'J(\tilde{\epsilon}, x)^{-1} \\ &= J(\bar{\epsilon}, x)A(\bar{\epsilon}, x)J(\bar{\epsilon}, x)^{-1} + (x^2 - \epsilon)J(\bar{\epsilon}, x)'J(\bar{\epsilon}, x)^{-1}, \end{aligned}$$

and hence we will have $B(\tilde{\epsilon}, x) = B(\bar{\epsilon}, x)$ on S_\cap (for x fixed). $B(\epsilon, x)$ will be analytic in ϵ because it will be unramified and because $\lim_{\epsilon \rightarrow 0} B(\epsilon, x)$ will exist.

In conclusion, once (229) and the existence of the desired $J(\hat{\epsilon}, x)$ are proved (in Sections 5.8 and 5.9), we will have constructed an analytic family of systems with the given complete system of analytic invariants.

5.8. Properties of $P(\bar{\epsilon}, x)$ near $\bar{\epsilon} = 0$. In this section, we show that the conjugating transformation $P(\bar{\epsilon}, x)$ satisfies (229).

5.8.1. *Proof of (229).* Let us detail how to obtain (229) for $\bar{\epsilon} \neq 0$ from the construction of $P(\bar{\epsilon}, x)$ given by (228). We will prove that (229) is satisfied for $x \in (\Omega_U^\bar{\epsilon} \cap \Omega_U^{\bar{\epsilon}}) \cup (\Omega_D^\bar{\epsilon} \cap \Omega_D^{\bar{\epsilon}})$. By the Maximum Modulus Theorem, this implies that (229) is satisfied for $x \in \mathbb{D}_r$.

With the shorter notations

$$(233) \quad \hat{H}_D = H_D(\hat{\epsilon}, x) \quad \text{and} \quad \hat{F}_D = F_D(\hat{\epsilon}, x),$$

we have, for $x \in \Omega_D^\bar{\epsilon} \cap \Omega_D^{\bar{\epsilon}}$,

$$(234) \quad \begin{aligned} |P(\bar{\epsilon}, x) - I| &= |\tilde{H}_D \tilde{F}_D \tilde{T}_L \tilde{T}_R^{-1} \tilde{F}_D^{-1} \tilde{H}_D^{-1} - I| \\ &= |\tilde{H}_D \tilde{F}_D (\tilde{T}_L \tilde{T}_R^{-1} - I) \tilde{F}_D^{-1} \tilde{H}_D^{-1} + (\tilde{H}_D \tilde{H}_D^{-1} - I)| \\ &\leq |\tilde{H}_D^{-1}| |\tilde{H}_D| |\tilde{F}_D| |\tilde{F}_D^{-1}| |\tilde{T}_L \tilde{T}_R^{-1} - I| + |\tilde{H}_D^{-1}| |\tilde{H}_D - \tilde{H}_D| \\ &\leq |\tilde{H}_D^{-1}| |\tilde{H}_D| |\tilde{F}_D| |\tilde{F}_D^{-1}| (|\tilde{T}_L - I| + |\tilde{T}_R^{-1} - I| + |\tilde{T}_L - I| |\tilde{T}_R^{-1} - I|) \\ &\quad + |\tilde{H}_D^{-1}| |\tilde{H}_D - \tilde{H}_D|, \end{aligned}$$

as well as a similar relation on $\Omega_U^\bar{\epsilon} \cap \Omega_U^{\bar{\epsilon}}$. From Lemma 4.48 (and using (36)), the following matrices appearing in (234) and in the similar relation on $\Omega_U^\bar{\epsilon} \cap \Omega_U^{\bar{\epsilon}}$ are exponentially close in $\sqrt{\bar{\epsilon}}$ to I :

$$(235) \quad \tilde{D}_R \tilde{T}_R \tilde{D}_R^{-1}, \quad \bar{D}_R \bar{T}_L^{-1} \bar{D}_R^{-1}, \quad \tilde{T}_L, \quad \bar{T}_R^{-1}.$$

Hence, in order to obtain the relation (229) for $x \in (\Omega_U^{\bar{\epsilon}} \cap \Omega_U^{\tilde{\epsilon}}) \cup (\Omega_D^{\bar{\epsilon}} \cap \Omega_D^{\tilde{\epsilon}})$, it suffices to bound $|H_s(\tilde{\epsilon}, x) - H_s(\bar{\epsilon}, x)|$. From (218), we have

$$(236) \quad \begin{aligned} & |H_s(\tilde{\epsilon}, x) - H_s(\bar{\epsilon}, x)| \\ &= \lim_{\nu \rightarrow \infty} |(I + \tilde{Z}_s^\nu) \dots (I + \tilde{Z}_s^3)(I + \tilde{Z}_s^2) - (I + \bar{Z}_s^\nu) \dots (I + \bar{Z}_s^3)(I + \bar{Z}_s^2)|. \end{aligned}$$

We will prove in Section 5.8.2 that there exists $k_1 \in \mathbb{R}_+$ such that, for $\nu \geq 2$,

$$(237) \quad |\tilde{Z}_s^\nu - \bar{Z}_s^\nu| \leq 2^{-\nu} k_1 |\bar{\epsilon}|, \quad (\bar{\epsilon}, x) \in S_\cap \times (\Omega_s^{\bar{\epsilon}}(\nu) \cap \Omega_s^{\tilde{\epsilon}}(\nu)), \quad s = D, U.$$

Using (236), (237) and condition (II) in Section 5.4, we then have

$$(238) \quad \begin{aligned} & |H_s(\tilde{\epsilon}, x) - H_s(\bar{\epsilon}, x)| \\ & \leq \lim_{\nu \rightarrow \infty} \sum_{i=2}^\nu |\tilde{Z}_s^i - \bar{Z}_s^i| \prod_{q=2}^{i-1} |I + \tilde{Z}_s^q| \prod_{p=i+1}^\nu |I + \bar{Z}_s^p| \\ & \leq \lim_{\nu \rightarrow \infty} \sum_{i=2}^\nu |\tilde{Z}_s^i - \bar{Z}_s^i| \prod_{q=2}^{i-1} |I + \tilde{Z}_s^q| \prod_{p=i+1}^\nu |I + \bar{Z}_s^p| \frac{|I + \tilde{Z}_s^i|}{1 - 2^{-(i+1)}} \\ & \leq \lim_{\nu \rightarrow \infty} \prod_{p=2}^\nu (1 + 2^{-(p+1)}) \sum_{i=2}^\nu \frac{|\tilde{Z}_s^i - \bar{Z}_s^i|}{1 - 2^{-(i+1)}} \\ & \leq \lim_{\nu \rightarrow \infty} \prod_{p=2}^\nu (1 + 2^{-(p+1)}) \sum_{i=2}^\nu \frac{k_1 |\bar{\epsilon}|}{2^{i(1-2^{-(i+1)})}} \\ & \leq \lim_{\nu \rightarrow \infty} k_1 |\bar{\epsilon}| \prod_{p=2}^\nu (1 + 2^{-(p+1)}) \sum_{i=2}^\nu 2^{-i(i-1)}, \end{aligned}$$

yielding the existence of $\mathcal{K}_1^* \in \mathbb{R}_+$ such that

$$(239) \quad |H_s(\tilde{\epsilon}, x) - H_s(\bar{\epsilon}, x)| \leq \mathcal{K}_1^* |\bar{\epsilon}|, \quad (\bar{\epsilon}, x) \in S_\cap \times (\Omega_s^{\bar{\epsilon}} \cap \Omega_s^{\tilde{\epsilon}}), \quad s = D, U.$$

5.8.2. *Property (237) of Z_s^ν .* Let us now prove (237), the remaining ingredient of the proof of (229) for $x \in (\Omega_U^{\bar{\epsilon}} \cap \Omega_U^{\tilde{\epsilon}}) \cup (\Omega_D^{\bar{\epsilon}} \cap \Omega_D^{\tilde{\epsilon}})$. From the definition of \tilde{Z}_s^ν in (205), we have, for $(\hat{\epsilon}, x) \in S \times (\Omega_s^{\bar{\epsilon}}(\nu) \cap \Omega_s^{\tilde{\epsilon}}(\nu))$ and $s = D, U$,

$$(240) \quad \left| \tilde{Z}_s^\nu - \bar{Z}_s^\nu \right| = \left| \frac{1}{2\pi i} \int_{\gamma_{\nu-1, s}^{\tilde{\epsilon}}} \frac{Z^{\nu-1}(\tilde{\epsilon}, h)}{h-x} dh - \frac{1}{2\pi i} \int_{\gamma_{\nu-1, s}^{\bar{\epsilon}}} \frac{Z^{\nu-1}(\bar{\epsilon}, h)}{h-x} dh \right|$$

The integration paths in (240) differ near the singular points but have a nonvoid common part. For $s = D, U$, we denote by $i_{\nu, s}^{\bar{\epsilon}}$ the common part of $\gamma_{\nu, s}^{\bar{\epsilon}}$ and $\gamma_{\nu, s}^{\tilde{\epsilon}}$, and by $r_{\nu, s}^{\bar{\epsilon}}$ and $r_{\nu, s}^{\tilde{\epsilon}}$ their respective remaining broken paths (i.e. we have $\gamma_{\nu, s}^{\tilde{\epsilon}} = i_{\nu, s}^{\bar{\epsilon}} + r_{\nu, s}^{\tilde{\epsilon}}$). Finally, as illustrated in Figure 24, we separate the left and right parts of $r_{\nu, s}^{\tilde{\epsilon}}$, denoting $r_{\nu, s}^{\tilde{\epsilon}} = r_{\nu, s, L}^{\tilde{\epsilon}} \cup r_{\nu, s, R}^{\tilde{\epsilon}}$. With these notations, we can write

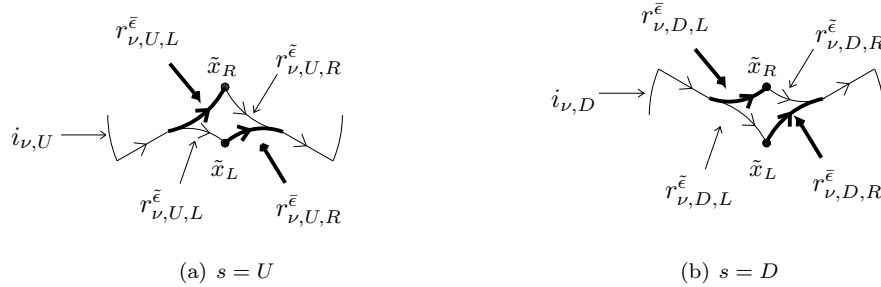

FIGURE 24. Integration paths $i_{\nu, s}^{\bar{\epsilon}}$, $r_{\nu, s}^{\tilde{\epsilon}} = r_{\nu, s, L}^{\tilde{\epsilon}} \cup r_{\nu, s, R}^{\tilde{\epsilon}}$ and $r_{\nu, s}^{\bar{\epsilon}} = r_{\nu, s, L}^{\bar{\epsilon}} \cup r_{\nu, s, R}^{\bar{\epsilon}}$, $s = D, U$.

(240) as

$$(241) \quad \left| \tilde{Z}_s^\nu - \bar{Z}_s^\nu \right| = \left| \frac{1}{2\pi i} \int_{i_{\nu-1,s}^{\bar{\epsilon}}} \frac{Z^{\nu-1}(\bar{\epsilon},h) - Z^{\nu-1}(\bar{\epsilon},h)}{h-x} dh \right. \\ \left. + \frac{1}{2\pi i} \int_{r_{\nu-1,s}^{\bar{\epsilon}}} \frac{Z^{\nu-1}(\bar{\epsilon},h)}{h-x} dh - \frac{1}{2\pi i} \int_{r_{\nu-1,s}^{\bar{\epsilon}}} \frac{Z^{\nu-1}(\bar{\epsilon},h)}{h-x} dh \right|,$$

and hence

$$(242) \quad \left| \tilde{Z}_s^\nu - \bar{Z}_s^\nu \right| \leq \frac{1}{2\pi} \int_{i_{\nu-1,s}^{\bar{\epsilon}}} \frac{|Z^{\nu-1}(\bar{\epsilon},h) - Z^{\nu-1}(\bar{\epsilon},h)|}{|h-x|} |dh| \\ + \frac{1}{2\pi} \left| \int_{r_{\nu-1,s}^{\bar{\epsilon}}} \frac{Z^{\nu-1}(\bar{\epsilon},h)}{h-x} dh \right| + \frac{1}{2\pi} \left| \int_{r_{\nu-1,s}^{\bar{\epsilon}}} \frac{Z^{\nu-1}(\bar{\epsilon},h)}{h-x} dh \right|.$$

In order to prove (237) from (242), we will bound its last row, and then use induction.

By condition (IV) in Section 5.4, we have

$$(243) \quad |Z^{\nu-1}(\hat{\epsilon}, h)| \leq 2^{-2(\nu-2)} K_4 |h - \hat{x}_l|^4, \quad (\hat{\epsilon}, x) \in (S \cup \{0\}) \times \Omega_l^{\hat{\epsilon}}(\nu).$$

Using (208), we thus have, for $x \in \Omega_l^{\bar{\epsilon}}(\nu) \cap \Omega_l^{\bar{\epsilon}}(\nu)$ $s = D, U$, $l = L, R$ and $\hat{\epsilon} \in \{\bar{\epsilon}, \bar{\epsilon}\}$,

$$(244) \quad \left| \int_{r_{\nu-1,s,l}^{\bar{\epsilon}}} \frac{Z^{\nu-1}(\bar{\epsilon},h)}{h-x} dh \right| \leq \int_{r_{\nu-1,s,l}^{\bar{\epsilon}}} \frac{|Z^{\nu-1}(\bar{\epsilon},h)|}{|h-x|} |dh| \\ \leq \int_{r_{\nu-1,s,l}^{\bar{\epsilon}}} \frac{2^{-2(\nu-2)} K_4 |h - \hat{x}_l|^2}{2^{-\nu\theta}} |dh|.$$

The integration paths $r_{\nu-1,s}^{\bar{\epsilon}}$ are located inside a disk of radius $c\sqrt{|\bar{\epsilon}|}$ for some $c \in \mathbb{R}_+^*$ (Section 4.4), yielding

$$(245) \quad \left| \int_{r_{\nu-1,s,l}^{\bar{\epsilon}}} \frac{Z^{\nu-1}(\bar{\epsilon},h)}{h-x} dh \right| \leq \int_{r_{\nu-1,s,l}^{\bar{\epsilon}}} \theta^{-1} 2^{4-\nu} K_4 (|h| + \sqrt{|\bar{\epsilon}|})^2 |dh| \\ \leq \int_{r_{\nu-1,s,l}^{\bar{\epsilon}}} \theta^{-1} 2^{4-\nu} K_4 |\bar{\epsilon}| (c+1)^2 |dh| \\ = \theta^{-1} 2^{4-\nu} K_4 |\bar{\epsilon}| (c+1)^2 \int_{r_{\nu-1,s,l}^{\bar{\epsilon}}} |dh|.$$

Thus, a bound for the last row of (242) is, using (204) and the fact that the length of the path $r_{\nu-1,s}^{\bar{\epsilon}}$ is smaller than the length of the path $\gamma_{\nu-1,s}^{\bar{\epsilon}}$,

$$(246) \quad \frac{1}{2\pi} \left(\left| \int_{r_{\nu-1,s}^{\bar{\epsilon}}} \frac{Z^{\nu-1}(\bar{\epsilon},h)}{h-x} dh \right| + \left| \int_{r_{\nu-1,s}^{\bar{\epsilon}}} \frac{Z^{\nu-1}(\bar{\epsilon},h)}{h-x} dh \right| \right) \\ \leq (2\pi\theta)^{-1} 2^{4-\nu} K_4 |\bar{\epsilon}| (c+1)^2 \left(\int_{r_{\nu-1,s}^{\bar{\epsilon}}} |dh| + \int_{r_{\nu-1,s}^{\bar{\epsilon}}} |dh| \right) \\ \leq (2\pi\theta)^{-1} 2^{4-\nu} K_4 |\bar{\epsilon}| (c+1)^2 \left(\int_{\gamma_{\nu-1,s}^{\bar{\epsilon}}} |dh| + \int_{\gamma_{\nu-1,s}^{\bar{\epsilon}}} |dh| \right) \\ \leq (2\pi\theta)^{-1} 2^{4-\nu} K_4 |\bar{\epsilon}| (c+1)^2 2c_s \\ = \frac{k_1^*}{2^{\nu+5}} |\bar{\epsilon}|,$$

where

$$(247) \quad k_1^* = \frac{2^5 K_4 (c+1)^2}{K_2}.$$

Hence, (242) becomes

$$(248) \quad \left| \tilde{Z}_s^\nu - \bar{Z}_s^\nu \right| \leq \frac{1}{2\pi} \int_{i_{\nu-1,s}^{\bar{\epsilon}}} \frac{|Z^{\nu-1}(\bar{\epsilon},h) - Z^{\nu-1}(\bar{\epsilon},h)|}{|h-x|} |dh| + \frac{k_1^*}{2^{\nu+5}} |\bar{\epsilon}|, \\ (\bar{\epsilon}, x) \in S_\cap \times (\Omega_l^{\bar{\epsilon}}(\nu) \cap \Omega_l^{\bar{\epsilon}}(\nu)).$$

From (248), we will prove (237) for $\nu = 2$, $\nu = 3$ and $\nu > 3$.

Beginning with $\nu = 2$, we have, from

$$(249) \quad F_s(\bar{\epsilon}, x) = F_s(\bar{\epsilon}, x), \quad x \in \Omega_s^{\bar{\epsilon}} \cap \Omega_s^{\bar{\epsilon}}, \quad s = D, U,$$

and from (189),

$$(250) \quad |\tilde{Z}^1 - \bar{Z}^1| \leq \begin{cases} |F_D(\bar{\epsilon}, x) \left(\tilde{C}_R - \bar{C}_R \right) F_D(\bar{\epsilon}, x)^{-1}|, & \text{on } \Omega_R^{\bar{\epsilon}} \cap \Omega_R^{\bar{\epsilon}}, \\ |F_D(\bar{\epsilon}, x) \left(\tilde{C}_L - \bar{C}_L \right) F_D(\bar{\epsilon}, x)^{-1}|, & \text{on } \Omega_L^{\bar{\epsilon}} \cap \Omega_L^{\bar{\epsilon}}. \end{cases}$$

By the $\frac{1}{2}$ -summability of the unfolded Stokes matrices, $|\tilde{C}_l - \bar{C}_l|$ is exponentially close to 0 in $\sqrt{\bar{\epsilon}}$. Since

$$(251) \quad \left(F_D(\bar{\epsilon}, x) \left(\tilde{C}_l - \bar{C}_l \right) F_D(\bar{\epsilon}, x)^{-1} \right)_{ij} = \frac{f_i(\bar{\epsilon}, x)}{f_j(\bar{\epsilon}, x)} \left(\tilde{C}_l - \bar{C}_l \right)_{ij}, \quad l = L, R,$$

and since there exists $k \in \mathbb{R}_+$ such that

$$(252) \quad \left| \frac{f_i(\bar{\epsilon}, x)}{f_j(\bar{\epsilon}, x)} \right| \leq k|x - \bar{x}_l|^2, \quad \text{on } \Omega_l^{\bar{\epsilon}}, \quad l = L, R, \quad i \neq j,$$

relation (250) implies that there exists $w_1 \in \mathbb{R}_+$ such that

$$(253) \quad |\tilde{Z}^1 - \bar{Z}^1| \leq \frac{w_1}{2^4} K_2 |\bar{\epsilon}| |x - \bar{x}_l|^2, \quad l = L, R, \quad (\bar{\epsilon}, x) \in S_\cap \times (\Omega_l^{\bar{\epsilon}}(\nu) \cap \Omega_l^{\bar{\epsilon}}(\nu)),$$

with K_2 given by (202). Using relations (204) and (208) and the fact that the length of the path $i_{\nu, s}^{\bar{\epsilon}}$ is smaller than the length of the path $\gamma_{\nu, s}^{\bar{\epsilon}}$, the integral in (248) for $\nu = 2$ is bounded by

$$(254) \quad \begin{aligned} \frac{1}{2\pi} \int_{i_{1, s}} \frac{|Z^1(\bar{\epsilon}, h) - Z^1(\bar{\epsilon}, h)|}{|h - x|} |dh| &\leq \frac{1}{2\pi} \int_{i_{1, s}} \frac{w_1 K_2 |\bar{\epsilon}| |h - \bar{x}_l|^2}{2^4 |h - x|} |dh| \\ &\leq \frac{1}{2\pi} \int_{i_{1, s}} \frac{w_1 K_2 |\bar{\epsilon}| |h - \bar{x}_l|^2}{2^4 2^{-2} \theta |h - \bar{x}_l|^2} |dh| \\ &\leq w_1 |\bar{\epsilon}| \frac{K_2}{2^3 \theta \pi} \int_{i_{1, s}} |dh| \\ &\leq w_1 |\bar{\epsilon}| \frac{K_2 c_s}{2^3 \theta \pi} \\ &\leq \frac{1}{2^7} w_1 |\bar{\epsilon}|. \end{aligned}$$

From (248) and (254), we have

$$(255) \quad |\tilde{Z}_s^2 - \bar{Z}_s^2| \leq \frac{1}{2^6} k_1 |\bar{\epsilon}|, \quad (\bar{\epsilon}, x) \in S_\cap \times (\Omega_s^{\bar{\epsilon}}(2) \cap \Omega_s^{\bar{\epsilon}}(2)), \quad s = D, U,$$

with

$$(256) \quad k_1 = \max\{k_1^*, w_1\}.$$

Relation (237) is thus satisfied for $\nu = 2$.

Now, let us study $|\tilde{Z}^{\nu-1} - \bar{Z}^{\nu-1}|$ in order to bound (248) for $\nu \geq 3$. From the equality

$$(257) \quad \tilde{A}\tilde{B}\tilde{C}^{-1} - \bar{A}\bar{B}\bar{C}^{-1} = \left((\tilde{A} - \bar{A})\tilde{B} + \bar{A}(\tilde{B} - \bar{B}) + \bar{A}\bar{B}\bar{C}^{-1}(\bar{C} - \tilde{C}) \right) \tilde{C}^{-1},$$

applied to relation $Z^{\nu-1} = Z_D^{\nu-1} Z^{\nu-2} (I + Z_U^{\nu-1})^{-1}$ coming from (211), we have (taking $Z^{\nu-1} = ABC^{-1}$, $Z_D^{\nu-1} = A$, $Z^{\nu-2} = B$ and $(I + Z_U^{\nu-1}) = C$)

$$(258) \quad \begin{aligned} &|\tilde{Z}^{\nu-1} - \bar{Z}^{\nu-1}| \\ &\leq \left(|\tilde{Z}_D^{\nu-1} - \bar{Z}_D^{\nu-1}| |\tilde{Z}^{\nu-2}| + |\bar{Z}_D^{\nu-1}| |\tilde{Z}^{\nu-2} - \bar{Z}^{\nu-2}| + |\bar{Z}^{\nu-1}| |\bar{Z}_U^{\nu-1} - \tilde{Z}_U^{\nu-1}| \right) \\ &\quad \times |(I + \tilde{Z}_U^{\nu-1})^{-1}|. \end{aligned}$$

Let us remark that, because of (249), we have

$$(259) \quad |\hat{Z}^\nu| \leq 2^{-2(\nu-1)} K_1 |x - \bar{x}_l|, \quad (\hat{\epsilon}, x) \in S_\cap \times \Omega_l^{\hat{\epsilon}}(\nu) \cap \Omega_l^{\hat{\epsilon}}(\nu), \quad l = L, R,$$

coming from condition (IV) of Section 5.4.

For $\nu = 3$, equation (258) yields, with the use of (253), (255), (256), (259) and $|Z_s^{\nu-1}| \leq 2^{-\nu}$ (from (II)),

$$(260) \quad \begin{aligned} |\tilde{Z}^2 - \bar{Z}^2| &\leq k_1 |\bar{\epsilon}| K_2 |x - \bar{x}_l|^2 \left(\frac{1}{2^6} + \frac{1}{2^3 2^4} + \frac{1}{2^2 2^6} \right) \left(\frac{1}{1-2^{-3}} \right), & l = L, R, \\ &\leq k_1 |\bar{\epsilon}| K_2 |x - \bar{x}_l|^2 \frac{1}{2^4}, & l = L, R, \end{aligned}$$

for $(\bar{\epsilon}, x) \in S_\cap \times (\Omega_s^{\bar{\epsilon}}(2) \cap \Omega_s^{\bar{\epsilon}}(2))$. In the same way as when we bounded (254), we use (260) to bound the integral in (248) for $\nu = 3$:

$$(261) \quad \begin{aligned} \frac{1}{2\pi} \int_{i_{2,s}} \frac{|Z^2(\bar{\epsilon}, h) - \bar{Z}^2(\bar{\epsilon}, h)|}{|h-x|} |dh| &\leq \frac{1}{2\pi} \int_{i_{2,s}} \frac{k_1 |\bar{\epsilon}| K_2 |h - \bar{x}_l|^2}{2^4 2^{-3} \theta |h - \bar{x}_l|^2} |dh| \\ &\leq \frac{k_1 |\bar{\epsilon}| K_2}{2^2 \pi \theta} \int_{i_{2,s}} |dh| \\ &\leq \frac{k_1 |\bar{\epsilon}| K_2}{2^2 \pi \theta} \int_{\gamma_{2,s}^{\bar{\epsilon}}} |dh| \\ &\leq \frac{1}{2^2} k_1 |\bar{\epsilon}| \frac{K_2 c_s}{\pi \theta} \\ &\leq \frac{1}{2^6} k_1 |\bar{\epsilon}|. \end{aligned}$$

Then, (261) into (248) gives

$$(262) \quad |\tilde{Z}_s^3 - \bar{Z}_s^3| \leq \frac{1}{2^5} k_1 |\bar{\epsilon}|, \quad (\bar{\epsilon}, x) \in S_\cap \times (\Omega_s^{\bar{\epsilon}}(3) \cap \Omega_s^{\bar{\epsilon}}(3)), \quad s = D, U.$$

Relation (237) is hence satisfied for $\nu = 3$.

We are now ready to prove (237) for $\nu > 3$ by induction on ν . Let us suppose that we have

$$(263) \quad \begin{aligned} |\tilde{Z}^{\nu-2} - \bar{Z}^{\nu-2}| &\leq \frac{k_1}{2^{2(\nu-3)}} |\bar{\epsilon}| K_2 |x - \bar{x}_l|^2, \\ (\bar{\epsilon}, x) &\in S_\cap \times (\Omega_s^{\bar{\epsilon}}(\nu-2) \cap \Omega_s^{\bar{\epsilon}}(\nu-2)), \quad l = L, R, \end{aligned}$$

and

$$(264) \quad |\tilde{Z}_s^{\nu-1} - \bar{Z}_s^{\nu-1}| \leq \frac{1}{2^{\nu-1}} k_1 |\bar{\epsilon}|, \quad (\bar{\epsilon}, x) \in S_\cap \times (\Omega_s^{\bar{\epsilon}}(\nu-1) \cap \Omega_s^{\bar{\epsilon}}(\nu-1)), \quad s = D, U,$$

(this is indeed satisfied for $\nu = 4$ because of (260) and (262)). For $\nu > 3$, relation (258) yields, using (263), (264), (259) and $|\tilde{Z}_s^{\nu-1}| \leq 2^{-\nu}$ (from (II)),

$$(265) \quad \begin{aligned} |\tilde{Z}^{\nu-1} - \bar{Z}^{\nu-1}| &\leq k_1 |\bar{\epsilon}| K_2 |x - \bar{x}_l|^2 \left(\frac{1}{2^{\nu-1} 2^{2(\nu-3)}} + \frac{1}{2^\nu 2^{2(\nu-3)}} + \frac{1}{2^{2(\nu-2)} 2^{\nu-1}} \right) \\ &\quad \times \left(\frac{1}{1-2^{-\nu}} \right), \end{aligned}$$

and thus, for $(\bar{\epsilon}, x) \in S_\cap \times (\Omega_s^{\bar{\epsilon}}(\nu-1) \cap \Omega_s^{\bar{\epsilon}}(\nu-1))$ and $l = L, R$,

$$(266) \quad |\tilde{Z}^{\nu-1} - \bar{Z}^{\nu-1}| \leq \frac{k_1}{2^{2(\nu-2)}} |\bar{\epsilon}| K_2 |x - \bar{x}_l|^2.$$

In the same way as when we bounded (254) and (261), we use (266) to bound the integral in (248) for $\nu > 3$:

$$(267) \quad \begin{aligned} \frac{1}{2\pi} \int_{i_{\nu-1,s}^{\bar{\epsilon}}} \frac{|Z^{\nu-1}(\bar{\epsilon}, h) - \bar{Z}^{\nu-1}(\bar{\epsilon}, h)|}{|h-x|} |dh| &\leq \frac{1}{2\pi} \int_{i_{\nu-1,s}^{\bar{\epsilon}}} \frac{k_1 K_2 |\bar{\epsilon}| |h - \bar{x}_l|^2}{2^{2(\nu-2)} |h-x|} |dh| \\ &\leq \frac{1}{2\pi} \int_{i_{\nu-1,s}^{\bar{\epsilon}}} \frac{k_1 K_2 |\bar{\epsilon}| |h - \bar{x}_l|^2}{2^{2(\nu-2)} 2^{-\nu} \theta |h - \bar{x}_l|^2} |dh| \\ &\leq \frac{k_1 K_2 |\bar{\epsilon}|}{\pi 2^{\nu-3} \theta} \int_{i_{\nu-1,s}^{\bar{\epsilon}}} |dh| \\ &\leq \frac{k_1 K_2 |\bar{\epsilon}|}{\pi 2^{\nu-3} \theta} \int_{\gamma_{\nu-1,s}^{\bar{\epsilon}}} |dh| \\ &\leq \frac{1}{2^{\nu-3}} k_1 |\bar{\epsilon}| \frac{K_2 c_s}{\pi \theta} \\ &\leq \frac{1}{2^{\nu+1}} k_1 |\bar{\epsilon}|. \end{aligned}$$

Then, (267) and (248) gives (237) for $\nu > 3$ (using (256)).

5.9. Construction of $J(\hat{\epsilon}, x)$. For fixed x , the existence of $J(\hat{\epsilon}, x)$ follows from the triviality of the vector bundle on the punctured disk in ϵ -space. But, we need to show that $J(\hat{\epsilon}, x)$ depends analytically on the "parameter" $x \in \mathbb{D}_r$ and also that we can fill the hole at $\epsilon = 0$. So we need to go into the details of the construction of $J(\hat{\epsilon}, x)$. We do this in a sketchy way since the details are completely similar (and simpler) to those we have done in Sections 5.1 to 5.5.

S has been taken previously with an opening $2\pi + \gamma_0$. We reduce slightly the opening of S to $2\pi + \gamma$ with $0 < \gamma < \gamma_0$, denoting the sector with the previous opening S^{prev} , such that, for some $\alpha > 0$,

$$(268) \quad S(1) = S \cup \{\epsilon : \exists \hat{\epsilon} \in S_\cap \text{ s.t. } |\epsilon - \hat{\epsilon}| < 2^{-1}\alpha|\epsilon|\} \subset S^{prev}.$$

We write S as the union of two sectors V_U and V_D

$$(269) \quad \begin{aligned} V_D &= \{\epsilon \in \mathbb{C} : 0 < |\epsilon| < \rho, \arg(\epsilon) \in (\pi - \gamma, 2\pi + \gamma)\}, \\ V_U &= \{\epsilon \in \mathbb{C} : 0 < |\epsilon| < \rho, \arg(\epsilon) \in (2\pi - \gamma, 3\pi + \gamma)\}. \end{aligned}$$

We take the following domains converging when $\nu \rightarrow \infty$ to V_s and included into S^{prev} :

$$(270) \quad V_s(\nu) = V_s \cup \{\epsilon : \exists \hat{\epsilon} \in V_U \cap V_D \text{ s.t. } |\epsilon - \hat{\epsilon}| < 2^{-\nu}\alpha|\epsilon|\}, \quad \nu \geq 1, s = D, U.$$

We separate the intersection of $V_U(\nu)$ and $V_D(\nu)$ into a left and a right domain:

$$(271) \quad V_\cap(\nu) = V_U(\nu) \cap V_D(\nu) = V_L(\nu) \cup V_R(\nu).$$

We divide the boundary of $V_\cap(\nu)$ in two parts: as illustrated in Figure 25, we denote $t_{\nu,s} = t_{\nu,s,L} \cup t_{\nu,s,R}$ the path included in the boundary of $V_s(\nu)$, $s = D, U$. The path $t_{\nu,s,L}$ begins at $\epsilon = -\rho$ and ends at $\epsilon = 0$, whereas $t_{\nu,s,R}$ begins at $\epsilon = 0$ and ends at $\epsilon = \rho$.

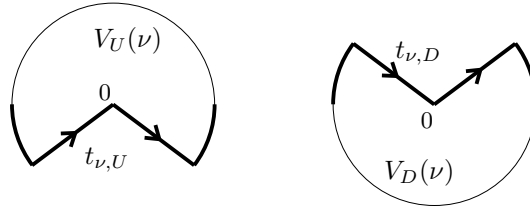

FIGURE 25. Integration path $t_{\nu,s} = t_{\nu,s,L} \cup t_{\nu,s,R}$, $s = D, U$.

We reduce the radius ρ of S (and hence of V_s and $V_s(\nu)$, $s = D, U$) a last time so that the length of each path $t_{\nu,s}$ is bounded as follows:

$$(272) \quad \int_{t_{\nu,s}} |dh| < l_s < \min \left\{ \frac{\pi\alpha}{2^4\mathcal{K}_1}, \frac{\pi}{\mathcal{K}_1} \right\}, \quad s = D, U, \nu \geq 1,$$

with \mathcal{K}_1 given by (229).

Starting from

$$(273) \quad Y^1 = \begin{cases} P(\epsilon, x) - I, & \epsilon \in V_L, \\ 0, & \epsilon \in V_R, \end{cases}$$

and using (229), we construct, for $\nu = 2, 3, \dots$, a sequence of matrices Y^ν , Y_U^ν and Y_D^ν satisfying the conditions:

$$(i) \quad Y^{\nu-1} = Y_U^\nu - Y_D^\nu, (\epsilon, x) \in V_\cap(\nu - 1) \times \mathbb{D}_r;$$

- (ii) for $s = D, U$,
 - Y_s^ν is analytic for $(\epsilon, x) \in V_s(\nu - 1) \times \mathbb{D}_r$,
 - $|Y_s^\nu| \leq 2^{-(\nu+1)}$ for $(\epsilon, x) \in V_s(\nu) \times \mathbb{D}_r$;
- (iii) For some $0 < \delta < 1$,
 - $I + Y^\nu = (I + Y_D^\nu)(I + Y^{\nu-1})(I + Y_U^\nu)^{-1}$ for $(\epsilon, x) \in V_L(\nu - \delta) \times \mathbb{D}_r$,
 - $Y^\nu = 0$ on $V_R(\nu - \delta) \times \mathbb{D}_r$;
- (iv) • Y^ν is analytic for $(\epsilon, x) \in V_L(\nu - \delta) \times \mathbb{D}_r$,
- $Y^\nu(0, x) = 0$,
- Y^ν satisfies, with \mathcal{K}_1 given by (229),
 $|Y^\nu| \leq 2^{-2(\nu-1)}\mathcal{K}_1|\epsilon|$ for $(\hat{\epsilon}, x) \in V_L(\nu) \times \mathbb{D}_r$.

We can prove that the properties (i) to (iv) are satisfied in a similar (and simpler) way as in Section 5.4, by defining the matrices $Y_D^\nu(\epsilon, x)$ and $Y_U^\nu(\epsilon, x)$, for $\nu = 2, 3, \dots$, by

$$(274) \quad Y_s^\nu(\epsilon, x) = \frac{1}{2\pi i} \int_{t_{\nu-1, s}} \frac{Y^{\nu-1}(h, x)}{h - \epsilon} dh, \quad (\epsilon, x) \in V_s(\nu - 1) \times \mathbb{D}_r, \quad s = D, U.$$

As in Section 5.5, the desired $J(\hat{\epsilon}, x)$ is given by

$$(275) \quad J(\hat{\epsilon}, x) = \begin{cases} J_D(\hat{\epsilon}, x), & \hat{\epsilon} \in V_D, \\ J_U(\epsilon, x), & \hat{\epsilon} \in V_U, \end{cases}$$

with

$$(276) \quad J_s(\epsilon, x) = \lim_{\nu \rightarrow \infty} (I + Y_s^\nu) \dots (I + Y_s^3)(I + Y_s^2), \quad s = D, U.$$

By (ii), $J(\hat{\epsilon}, x)^{-1}$ has a bounded limit at $\epsilon = 0$. Since the family $\{J'(\hat{\epsilon}, x)\}_{\hat{\epsilon} \in (S \cup \{0\})}$ is bounded, $J'(\hat{\epsilon}, x)$ has a bounded limit at $\epsilon = 0$. This concludes the proof of Theorem 5.2. \square

6. DISCUSSION AND DIRECTIONS FOR FURTHER RESEARCH

The work presented in this paper brings a new light on the divergence of formal solutions near an irregular singular point of Poincaré rank 1. It gives new perspectives, including a unified point of view in the understanding of the dynamics of the singularities by deformation. We have identified, interpreted and studied the realization of the complete system of analytic invariants of unfolded differential linear systems with an irregular singularity of Poincaré rank 1 (nonresonant case). The meaning of the auto-intersection relation (which is the necessary and sufficient condition for the realization) is still obscure (in dimension $n \geq 3$). We will investigate it in more details in [7].

One of the next steps in the large program of understanding singularities by unfolding is the study of analytic invariants of nonresonant linear differential equations with singularities of Poincaré rank k higher than 1. One difference is that there is no more a bijection between the $2k$ Stokes matrices and the $k + 1$ singular points in the unfolded systems.

Another direction of research is the existence of universal families. Can we identify canonical representatives of the analytic equivalence classes of unfolded systems?

ACKNOWLEDGEMENTS

The authors are grateful to Claudine Mitschi and to the reviewer for helpful suggestions and comments. They also thank Sergei Yakovenko for stimulating discussions.

REFERENCES

- [1] W. Balser, W. B. Jurkat, D. A. Lutz, *Birkhoff invariants and Stokes' multipliers for meromorphic linear differential equations*, J. Math. Anal. Appl. 71 (1979), no. 1, 48–94.
- [2] C. Christopher, C. Rousseau, *The moduli space of germs of generic families of analytic diffeomorphisms unfolding a parabolic fixed point*, preprint CRM, 2008.
- [3] A. Glutsyuk, *Stokes operators via limit monodromy of generic perturbation*, J. Dynam. Control Systems 5 (1999), no. 1, 101–135.
- [4] R. C. Gunning, H. Rossi, *Analytic functions of several complex variables*, Prentice-Hall Inc., Englewood Cliffs, N.J., 1965.
- [5] Y. Ilyashenko, S. Yakovenko, *Lectures on Analytic Differential Equations*, Graduate Studies in Mathematics, 86, American Mathematical Society, Providence, RI, 2008.
- [6] C. Lambert, C. Rousseau, *The Stokes phenomenon in the confluence of the hypergeometric equation using Riccati equation*, J. Differential Equations 244 (2008), no. 10, 2641–2664.
- [7] C. Lambert, C. Rousseau, *Moduli space of unfolded differential linear systems with an irregular singularity of Poincaré rank 1*, in preparation.
- [8] J.-P. Ramis, *Gevrey asymptotics and applications to holomorphic ordinary differential equations*, Differential equations and asymptotic theory in mathematical physics, 44–99, Ser. Anal., 2, World Sci. Publ., Hackensack, NJ, 2004.
- [9] C. Rousseau, L. Teyssier, *Analytical moduli for unfoldings of saddle-node vector-fields*, Mosc. Math. J. 8 (2008), no. 3, 547–614.
- [10] Y. Sibuya, *Linear differential equations in the complex domain: problems of analytic continuation*. Translations of Mathematical Monographs, 82, American Mathematical Society, Providence, RI, 1990.
- [11] W. Wasow, *Asymptotic expansions for ordinary differential equations*, Dover Publications Inc., New York, 1987.

DÉPARTEMENT DE MATHÉMATIQUES ET DE STATISTIQUE, UNIVERSITÉ DE MONTRÉAL, C.P.
6128, SUCCURSALE CENTRE-VILLE, MONTRÉAL (QC), H3C 3J7, CANADA
E-mail address: `lambert@dms.umontreal.ca`, `rousseau@dms.umontreal.ca`