

STRING-NET MODEL OF TURAEV-VIRO INVARIANTS

ALEXANDER KIRILLOV, JR.

ABSTRACT. In this paper, we describe the relation between the Turaev–Viro TQFT and the string-net space introduced in the papers of Levin and Wen. In particular, the case of surfaces with boundary is considered in detail.

INTRODUCTION

It is known that any spherical fusion category \mathcal{A} (i.e. a semisimple abelian category with finitely many simple objects, an associative tensor product and a duality functor satisfying certain properties) defines a 3-dimensional topological quantum field theory (TQFT). This construction was first given by Turaev and Viro in [TV1992] in the special case of the category of representations of the quantum group $U_q sl(2)$ and generalized to arbitrary spherical categories in [BW1996]. It was recently shown in [BalK2010] that this theory can be extended to a 3-2-1 theory, i.e. allowing for surfaces with boundary and 3- cobordisms with “tubes”, or “Wilson lines”, connecting the boundary circles of the 2-dimensional surfaces.

In this paper we show that the vector space $Z_{TV}(\Sigma)$ which this theory associates to a 2-dimensional surface can also be described in terms of so-called “string nets”, or space of colored graphs on the surface modulo some local relations. These string nets were introduced in the paper of Levin and Wen [LW2005]; the corresponding model is called the Levin–Wen model. [In fact, this is one of the two equivalent descriptions of the Levin–Wen model; in the other description, the vector space associated to the surface is described as the ground space of certain Hamiltonian. This second description will not be used in this paper.] The same model has also appeared in the works of Kitaev on topological quantum computation [Kit2003]; for example, in the special case when \mathcal{A} is the category of \mathbb{Z}_2 -graded vector spaces, the model is known as Kitaev’s toric code model.

The idea that Turaev–Viro and Kitaev–Levin–Wen models are equivalent is certainly not new. This statement has been made in a number of papers, most notably in [KMR2009] and [KKR2010]. However, none of these papers contain full proofs. In these papers, many of the statements are written in the special case when all multiplicities in tensor product of two simple objects are zero or one (with the note that it can be generalized) and some details of the proofs are missing. The goal of this paper is to give a complete and readable to mathematicians proof of the above statement.

In addition, we also carefully treat the case of surfaces with boundary, which in the language of Levin–Wen model correspond to “excited states”, or “quasiparticles”. We show that these excited states are again equivalent to the Turaev–Viro model for surfaces with boundary as defined in [BalK2010]; in particular, we show

This work was partially supported by NSF grant DMS-0700589 .

that the possible boundary conditions for a circle are described by objects in the category $\mathcal{C} = Z(\mathcal{A})$ —the Drinfeld center of \mathcal{A} .

Acknowledgments. The author would like to thank Oleg Viro, Ben Balsam, Zhenghan Wang, Kevin Walker, Anton Kapustin, Alexey Kitaev and Joel Kamnitzer for numerous helpful discussions. Special thanks to Microsoft Station Q, where part of this work was written.

Notation. Throughout the paper, we fix an algebraically closed field \mathbf{k} of characteristic zero. All vector spaces and linear maps will be considered over \mathbf{k} .

All manifolds, homeomorphisms etc. are considered in piecewise-linear (PL) topology. [Note that it is well known that in dimensions 2 and below, PL category is equivalent to the smooth category; however, PL setting is more convenient for our purposes.] We denote by D^2 the “standard” two-dimensional disk:

$$D^2 = \{(x, y) \in \mathbb{R}^2 \mid |x| \leq 1, |y| \leq 1\}$$

and by S^1 its boundary. We will also use the notation $I = [0, 1]$.

Unless otherwise noted, all manifolds are oriented, and homeomorphisms are orientation-preserving. D^2 is considered with the natural orientation inherited from \mathbb{R}^2 , and S^1 with the counterclockwise orientation.

In the figures, we use different line styles for different kinds of lines. Note that some lines are colored, so if you are reading this paper printed in black and white, it will be difficult to tell these styles apart:





	boundary of the surface
	edge of a cell decomposition for the surface
	a graph on the surface
	arc of a graph colored in a special way (see Eqn. (3.4))
	arc of a graph colored by an object of Drinfeld center of \mathcal{A} (see

Figure 14)

1. SPHERICAL CATEGORIES: AN OVERVIEW

In this section we collect notation and some facts about spherical categories.

We denote by \mathcal{Vec} the category of finite-dimensional vector spaces over the ground field \mathbf{k} .

Throughout the paper, \mathcal{A} will denote a spherical fusion category over \mathbf{k} . We refer the reader to the paper [DGNO] for the definitions and properties of such categories.

In particular, \mathcal{A} is semisimple with finitely many isomorphism classes of simple objects. We will denote by $\text{Irr}(\mathcal{A})$ the set of isomorphism classes of simple objects; abusing the language, we will frequently use the same letter i for denoting both a simple object and its isomorphism class. In those cases where it can lead to confusion, we will use notation X_i for a representative of isomorphism class i . We will also denote by $\mathbf{1} = X_0$ the unit object in \mathcal{A} (which is simple).

To simplify the notation, we will assume that \mathcal{A} is a strict pivotal category, i.e. that $V^{**} = V$. As is well-known, this is not really a restriction, since any pivotal category is equivalent to a strict pivotal category.

We will denote, for an object X of \mathcal{A} , by

$$d_X = \dim X \in \mathbf{k}$$

its categorical dimension; it is known that for simple X , d_X is non-zero. We will fix, for any simple object $X \in \mathcal{A}$, a choice of square root $\sqrt{d_X}$ so that for $X = \mathbf{1}$, $\sqrt{d_{\mathbf{1}}} = 1$ and that for any simple X , $\sqrt{d_X} = \sqrt{d_{X^*}}$.

We will also denote

$$(1.1) \quad \mathcal{D} = \sqrt{\sum_{i \in \text{Irr}(\mathcal{A})} d_i^2}$$

(throughout the paper, we fix a choice of the square root). Note that by results of [ENO2005], $\mathcal{D} \neq 0$.

We define the functor $\mathcal{A}^{\boxtimes n} \rightarrow \mathcal{V}ec$ by

$$(1.2) \quad \langle V_1, \dots, V_n \rangle = \text{Hom}_{\mathcal{A}}(\mathbf{1}, V_1 \otimes \dots \otimes V_n)$$

for any collection V_1, \dots, V_n of objects of \mathcal{A} . Note that pivotal structure gives functorial isomorphisms

$$(1.3) \quad z: \langle V_1, \dots, V_n \rangle \simeq \langle V_n, V_1, \dots, V_{n-1} \rangle$$

such that $z^n = \text{id}$ (see [BakK2001, Section 5.3]); thus, up to a canonical isomorphism, the space $\langle V_1, \dots, V_n \rangle$ only depends on the cyclic order of V_1, \dots, V_n .

We have a natural composition map

$$(1.4) \quad \begin{aligned} &\langle V_1, \dots, V_n, X \rangle \otimes \langle X^*, W_1, \dots, W_m \rangle \rightarrow \langle V_1, \dots, V_n, W_1, \dots, W_m \rangle \\ &\varphi \otimes \psi \mapsto \varphi \circ_X \psi = \text{ev}_X \circ (\varphi \otimes \psi) \end{aligned}$$

where $\text{ev}_X: X \otimes X^* \rightarrow \mathbf{1}$ is the evaluation morphism (see Figure 3 for an illustration of this operation).

Note that for any objects $A, B \in \text{Obj } \mathcal{C}$, we have a non-degenerate pairing $\text{Hom}_{\mathcal{C}}(A, B) \otimes \text{Hom}_{\mathcal{C}}(A^*, B^*) \rightarrow \mathbf{k}$ defined by

$$(1.5) \quad (\varphi, \varphi') = (\mathbf{1} \xrightarrow{\text{coev}_A} A \otimes A^* \xrightarrow{\varphi \otimes \varphi'} B \otimes B^* \xrightarrow{\text{ev}_B} \mathbf{1})$$

In particular, this gives us a non-degenerate pairing $\langle V_1, \dots, V_n \rangle \otimes \langle V_n^*, \dots, V_1^* \rangle \rightarrow \mathbf{k}$ and thus, functorial isomorphisms

$$(1.6) \quad \langle V_1, \dots, V_n \rangle^* \simeq \langle V_n^*, \dots, V_1^* \rangle$$

compatible with the cyclic permutations (1.3).

2. COLORED GRAPHS

We will consider finite graphs embedded in an oriented surface Σ (which is not required to be compact and may have boundary); for such a graph Γ , let $E(\Gamma)$ be the set of edges. Note that edges are not oriented. Let E^{or} be the set of oriented edges, i.e. pairs $\mathbf{e} = (e, \text{orientation of } e)$; for such an oriented edge \mathbf{e} , we denote by $\bar{\mathbf{e}}$ the edge with opposite orientation.

If Σ has a boundary, the graph is allowed to have uncolored one-valent vertices on $\partial\Sigma$ but no other common points with $\partial\Sigma$; all other vertices will be called interior. We will call the edges of Γ terminating at these one-valent vertices *legs*.

Definition 2.1. Let Σ an oriented surface (possibly with boundary) and $\Gamma \subset \Sigma$ — an embedded graph as defined above. A *coloring* of Γ is the following data:

- Choice of an object $V(\mathbf{e}) \in \text{Obj } \mathcal{A}$ for every oriented edge $\mathbf{e} \in E^{or}(\Gamma)$ so that $V(\bar{\mathbf{e}}) = V(\mathbf{e})^*$.

- Choice of a vector $\varphi(v) \in \langle V(\mathbf{e}_1), \dots, V(\mathbf{e}_n) \rangle$ (see (1.2)) for every interior vertex v , where $\mathbf{e}_1, \dots, \mathbf{e}_n$ are edges incident to v , taken in counterclockwise order and with outward orientation (see Figure 1).

An *isomorphism* f of two coloring $\{V(\mathbf{e}), \varphi(v)\}, \{V'(\mathbf{e}), \varphi'(v)\}$ is a collection of isomorphisms $f_{\mathbf{e}}: V(\mathbf{e}) \simeq V'(\mathbf{e})$ which agree with isomorphisms $V(\bar{\mathbf{e}}) = V(\mathbf{e})^*$ and which identify $\varphi', \varphi: \varphi'(v) = f \circ \varphi(v)$.

We will denote the set of all colored graphs on a surface Σ by $\text{Graph}(\Sigma)$.

Note that if Σ has a boundary, then every colored graph Γ defines a collection of points $B = \{b_1, \dots, b_n\} \subset \partial\Sigma$ (the endpoints of the legs of Γ) and a collection of objects $V_b \in \text{Obj } \mathcal{A}$ for every $b \in B$: the colors of the legs of Γ taken with outgoing orientation. We will denote the pair $(B, \{V_b\})$ by $\mathbf{V} = \Gamma \cap \partial\Sigma$ and call it *boundary value*. We will denote

$$\text{Graph}(\Sigma, \mathbf{V}) = \text{set of all colored graphs in } \Sigma \text{ with boundary value } \mathbf{V}.$$

We will return to the discussion of possible boundary values later in Section 6.

We can also consider formal linear combinations of colored graphs. Namely, for fixed boundary value \mathbf{V} as above, we will denote

$$(2.1) \quad \text{VGraph}(\Sigma, \mathbf{V}) = \{\text{formal linear combinations of graphs } \Gamma \in \text{Graph}(\Sigma, \mathbf{V})\}$$

In particular, if $\partial\Sigma = \emptyset$, then the only possible boundary condition is trivial ($B = \emptyset$); in this case, we will just write $\text{VGraph}(\Sigma)$.

In the figures, we will show the coloring by choosing for each edge an orientation and writing the color of the corresponding oriented edge next to it; we will also frequently replace vertices by round circles labeled by the corresponding vector $\varphi(v)$, as shown in Figure 1.

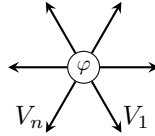
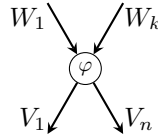

FIGURE 1. Labeling of colored graphs

Note that since we have a canonical isomorphism $\langle V, W^* \rangle \simeq \text{Hom}_{\mathcal{A}}(W, V)$, we can also interpret an element $\varphi \in \langle V_1, \dots, V_n, W_k^*, \dots, W_1^* \rangle$ as a morphism $W_1 \otimes \dots \otimes W_k \rightarrow V_1 \otimes \dots \otimes V_n$, as illustrated in Figure 2.



$$\varphi \in \langle V_1, \dots, V_n, W_k^*, \dots, W_1^* \rangle \simeq \text{Hom}_{\mathcal{A}}(W_1 \otimes \dots \otimes W_k, V_1 \otimes \dots \otimes V_n)$$

FIGURE 2. Colored graph as a tangle

Remark 2.2. Note that this convention is **opposite** to the conversion used in [BaK2010, BakK2001], where morphisms were acting “from the bottom to top”. Thus, care must be taken when using graphical presentations of morphisms from those papers.

We will also use the following convention: if a figure contains a pair of vertices, one with outgoing edges labeled V_1, \dots, V_n and the other with edges labeled V_n^*, \dots, V_1^* , and the vertices are labeled by the same letter α (or β , or ...) it will stand for summation over the dual bases:

$$(2.2) \quad \begin{array}{c} \begin{array}{c} \nearrow \\ \nearrow \\ \leftarrow \alpha \rightarrow \\ \searrow \\ \searrow \\ \downarrow \\ V_1^* \quad V_n^* \end{array} \quad \begin{array}{c} \nearrow \\ \nearrow \\ \leftarrow \alpha \rightarrow \\ \searrow \\ \searrow \\ \downarrow \\ V_n \quad V_1 \end{array} \quad = \quad \sum_{\alpha} \quad \begin{array}{c} \nearrow \\ \nearrow \\ \leftarrow \varphi_{\alpha} \rightarrow \\ \searrow \\ \searrow \\ \downarrow \\ V_1^* \quad V_n^* \end{array} \quad \begin{array}{c} \nearrow \\ \nearrow \\ \leftarrow \varphi^{\alpha} \rightarrow \\ \searrow \\ \searrow \\ \downarrow \\ V_n \quad V_1 \end{array} \end{array}$$

where $\varphi_{\alpha} \in \langle V_1, \dots, V_n \rangle$, $\varphi^{\alpha} \in \langle V_n^*, \dots, V_1^* \rangle$ are dual bases with respect to pairing (1.5).

The following theorem is a variation of result of Reshetikhin and Turaev.

Theorem 2.3. *There is a unique way to assign to every colored planar graph Γ in a disk $D \subset \mathbb{R}^2$ a vector*

$$(2.3) \quad \langle \Gamma \rangle_D \in \langle V(\mathbf{e}_1), \dots, V(\mathbf{e}_n) \rangle$$

where $\mathbf{e}_1, \dots, \mathbf{e}_n$ are the edges of Γ meeting the boundary of D (legs), taken in counterclockwise order and with outgoing orientation, so that that following conditions are satisfied:

- (1) $\langle \Gamma \rangle$ only depends on the isotopy class of Γ .
- (2) If Γ is a single vertex colored by $\varphi \in \langle V(\mathbf{e}_1), \dots, V(\mathbf{e}_n) \rangle$, then $\langle \Gamma \rangle = \varphi$.
- (3) Local relations shown in Figure 3 hold.

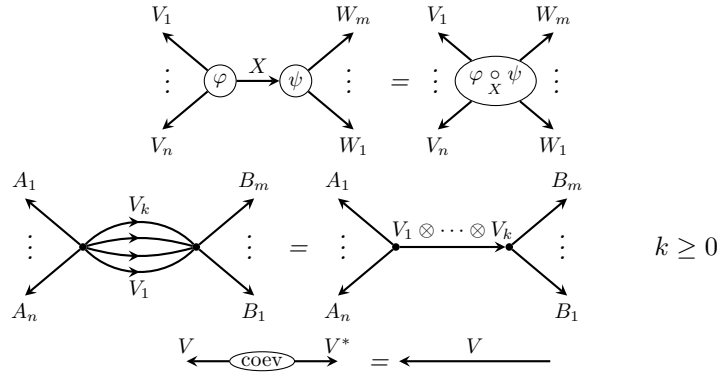

FIGURE 3. Local relations for colored graphs. Here $\varphi \circ \psi$ is defined by (1.4).

Local relations should be understood as follows: for any pair Γ, Γ' of colored graphs which are identical outside a subdisk $D' \subset D$, and in this disk are homeomorphic to the graphs shown in Figure 3, we must have $\langle \Gamma \rangle = \langle \Gamma' \rangle$.

Moreover, so defined $\langle \Gamma \rangle$ satisfies the following properties:

- (1) $\langle \Gamma \rangle$ is linear in color of each vertex v (for fixed colors of edges and other vertices).
- (2) $\langle \Gamma \rangle$ is additive in colors of edges as shown in Figure 4.

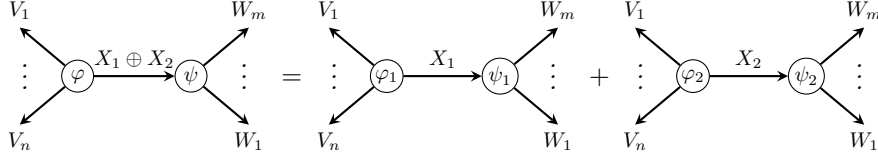

FIGURE 4. Linearity of $\langle \Gamma \rangle$. Here φ_1, φ_2 are compositions of φ with projector $X_1 \oplus X_2 \rightarrow X_1$ (respectively, $X_1 \oplus X_2 \rightarrow X_2$), and similarly for ψ_1, ψ_2 .

- (3) If Γ, Γ' are two isomorphic colorings of the same graph, then $\langle \Gamma \rangle = \langle \Gamma' \rangle$.
- (4) Composition property: if $D' \subset D$ is a subdisk such that $\partial D'$ does not contain vertices of Γ and meets edges of Γ transversally, then $\langle \Gamma \rangle_D$ will not change if we replace subgraph $\Gamma \cap D'$ by a single vertex colored by $\langle \Gamma \cap D' \rangle_{D'}$.

We will call the vector $\langle \Gamma \rangle$ the evaluation of Γ .

In particular, for a planar graph $\Gamma \subset \mathbb{R}^2$ with no outgoing legs, $\langle \Gamma \rangle \in \mathbf{k}$ is a number.

This evaluation map can be naturally extended to formal linear combinations of graphs: for fixed boundary value $\mathbf{V} = (\{b_1, \dots, b_n\}, \{V_1, \dots, V_n\})$, the map $\Gamma \mapsto \langle \Gamma \rangle$ extends in an obvious way to a linear map

$$\text{VGraph}(D, \mathbf{V}) \rightarrow \langle V_1 \otimes \cdots \otimes V_n \rangle$$

3. STRING NETS

In this section we give a definition and list some properties of the main object of our study, the string-net space. Practically all results of this section are known (with possible exception of Lemma 3.6); see, e.g., [KKR2010].

Let Σ be an oriented surface; as before, it can have boundary and we do not assume that it is compact — for example, compact surface with punctures is also allowed. We fix a boundary value \mathbf{V} as in the previous section and consider the set $\text{Graph}(\Sigma, \mathbf{V})$ of colored graphs in Σ with boundary value \mathbf{V} ; we will also use the vector space $\text{VGraph}(\Sigma, \mathbf{V})$ of formal linear combinations of such graphs.

We now want to define local relations between graphs. One way of doing it is as follows.

Let $D \subset \Sigma$ be an embedded disk, $\mathbf{\Gamma} = c_1 \Gamma_1 + \cdots + c_n \Gamma_n \in \text{VGraph}(\Sigma, \mathbf{V})$ — a linear combination of colored graphs in Σ such that

- (1) $\mathbf{\Gamma}$ is transversal to ∂D (i.e., no vertices of Γ_i are on the boundary of D and edges of each Γ_i meet ∂D transversally).
- (2) All Γ_i coincide outside of D .
- (3) $\langle \mathbf{\Gamma} \rangle_D = \sum c_i \langle \Gamma_i \cap D \rangle_D = 0$, where $\langle \Gamma_i \cap D \rangle_D$ is the expectation value defined by Theorem 2.3.

In this case we will call $\mathbf{\Gamma}$ a null graph.

Definition 3.1. Let Σ be an oriented surface (possibly with boundary) and let $\mathbf{V} = (B, \{V_b\})$ be a boundary value as defined in Section 2. The string-net space $H^{string}(\Sigma, \mathbf{V})$ is the quotient space

$$H^{string}(\Sigma, \mathbf{V}) = \text{VGraph}(\Sigma, \mathbf{V})/N(\Sigma, \mathbf{V})$$

where $N(\Sigma, \mathbf{V})$ is the subspace spanned by null graphs (for all possible embedded disks $D \subset \Sigma$).

Remark 3.2. This definition is an example of a general construction of TQFT as space of fields modulo local relations, as defined in [Wal2010].

Example 3.3. Let $\Sigma = S^2 - \{pt\} = \mathbb{R}^2$. Then $H^{string}(\Sigma) = \mathbf{k}$: the map $\Gamma \mapsto \langle \Gamma \rangle$ descends to an isomorphism $H^{string} \rightarrow \mathbf{k}$.

Motivated by this example, we will denote for a linear combination of colored graphs $\Gamma \in \text{VGraph}(\Sigma, \mathbf{V})$ its class in $H^{string}(\Sigma, \mathbf{V})$ by $\langle \Gamma \rangle_\Sigma$ (or just $\langle \Gamma \rangle$ when there is no ambiguity).

It is immediate from the definition that all local relations listed in Theorem 2.3 are satisfied in H^{string} . The following theorem lists some corollaries of these relations.

Theorem 3.4.

- (1) If Γ, Γ' are isomorphic coloring of the same graph (see Definition 2.1), then $\langle \Gamma \rangle = \langle \Gamma' \rangle$.
- (2) If Γ, Γ' are isotopic, then $\langle \Gamma \rangle = \langle \Gamma' \rangle$.
- (3) The map $\Gamma \rightarrow \langle \Gamma \rangle$ is linear in colors of edges and vertices in the same sense as in Theorem 2.3.
- (4) $H^{string}(\Sigma_1 \sqcup \Sigma_2) = H^{string}(\Sigma_1) \otimes H^{string}(\Sigma_2)$
- (5) For any surface Σ , we have the following local relations in $H^{string}(\Sigma)$:

$$(3.1) \quad \sum_{i \in \text{Irr}(\mathcal{A})} d_i \begin{array}{c} V_1 \quad \dots \quad V_n \\ \searrow \quad \downarrow \quad \swarrow \\ \alpha \\ \downarrow i \\ \alpha \\ \swarrow \quad \downarrow \quad \searrow \\ V_1 \quad \dots \quad V_n \end{array} = \begin{array}{c} \downarrow \\ \dots \\ \downarrow \end{array}$$

$$(3.2) \quad \begin{array}{c} X \\ \circlearrowright \end{array} = d_X$$

$$(3.3) \quad \begin{array}{c} \bullet \end{array} \xrightarrow{i} = 0, \quad i \in \text{Irr}(\mathcal{A}), i \neq \mathbf{1}$$

In the last picture, the shaded area is an embedded disk which can contain any subgraph such that the only edge crossing the boundary of the shaded disk is the one labeled by i .

Proof. Parts (1)–(3) follow from analogous statements for the disk given in Theorem 2.3. (4) is immediate from the definition. Equation (3.1) is also well-known; a proof can be found, e.g., in [BalK2010, Lemma 1.1]. The other two identities immediately follow from the definition. \square

This theorem has an immediate corollary.

Corollary 3.5. *Let dashed line stand for the sum of all colorings of an edge by simple objects i , each taken with coefficient d_i :*

$$(3.4) \quad \text{---} = \sum_{i \in \text{Irr}(\mathcal{A})} d_i \mid^i$$

Then one has the following relations in $H^{\text{string}}(\Sigma)$:

$$(3.5) \quad \text{---} = \mathcal{D}^2$$

$$(3.6) \quad \begin{array}{c} V_1 \quad \dots \quad V_n \\ \searrow \quad \dots \quad \swarrow \\ \alpha \\ \vdots \\ \alpha \\ \swarrow \quad \dots \quad \searrow \\ V_1 \quad \dots \quad V_n \end{array} = \begin{array}{c} \downarrow \\ V_1 \cdots V_n \\ \downarrow \end{array}$$

$$(3.7) \quad \text{---} = \text{---}$$

The last relation holds regardless of the contents of the shaded region (which can contain arbitrary graphs or punctures).

Proof. The first two relations are just a rewriting of the relations from Theorem 3.4. The final relation follows by applying the second local relation twice as shown below:

$$\text{---} = \begin{array}{c} \downarrow \\ \alpha \\ \uparrow \\ \alpha \end{array} = \text{---}$$

□

The following relation will also be useful in the future.

Lemma 3.6. *Let D_1, D_2 be two non-intersecting disks. Then for any $V, W \in \text{Obj } \mathcal{A}$, $i \in \text{Irr}(\mathcal{A})$ we have the following identity in $H^{\text{string}}(D_1 \sqcup D_2)$:*

$$\langle \text{---} \rangle_{D_1} \otimes \langle \text{---} \rangle_{D_2} = \langle \text{---} \rangle_{D_1} \otimes \langle \text{---} \rangle_{D_2}$$

(as before, we are using summation convention (2.2)).

Proof. Let us write $V = \bigoplus_j V_j \otimes j$, $W = \bigoplus_j W_j \otimes j$ where V_j, W_j are vector spaces. Clearly, summands with $j \neq i$ give zero contribution to both sides of equality in

the lemma. Thus, it suffices to prove that for any pair of vector spaces V_i, W_i and a linear map $\Phi_i: V_i \rightarrow W_i$, we have

$$\sum_{\alpha} \Phi_i^*(\varphi^{\alpha}) \otimes \varphi_{\alpha} = \sum_{\alpha} \psi^{\beta} \otimes \Phi_i(\psi_{\beta}) \in V_i^* \otimes W_i$$

where $\varphi_{\alpha} \in W_i, \varphi^{\alpha} \in W_i^*, \psi_{\beta} \in V_i, \psi^{\beta} \in V_i^*$ are bases such that $\langle \varphi_{\alpha}, \varphi^{\alpha'} \rangle = d_i^{-1} \delta_{\alpha, \alpha'}$, and similarly for $\psi_{\beta}, \psi^{\beta}$. This identity is trivial: under identification $V_i^* \otimes W_i \simeq \text{Hom}(V_i, W_i)$, both sides are identified with $d_i^{-1} \Phi_i$. \square

For future use, we will need to know how the string net space changes when we add or remove a puncture. The following lemma, the proof of which is left to the reader, is the first step in this direction.

Lemma 3.7. *Let $\Sigma' = \Sigma - p$ be a surface obtained by removing from Σ a single point p . Then the obvious embedding $\text{Graph}(\Sigma - p) \rightarrow \text{Graph}(\Sigma)$ descends to an isomorphism*

$$H^{\text{string}}(\Sigma) = H^{\text{string}}(\Sigma - p) / \left\langle \left\langle \begin{array}{c} p \\ \bullet \end{array} \right\rangle - \left\langle \begin{array}{c} p \\ \bullet \end{array} \right\rangle \right\rangle$$

Corollary 3.8 ([BW1996]). $H^{\text{string}}(S^2) = \mathbf{k}$

Proof. Since $S^2 = \mathbb{R}^2 \cup \infty$, it suffices to prove that in $H^{\text{string}}(\mathbb{R}^2)$, we have the relation shown in Figure 5. But this is part of the definition of a spherical category.

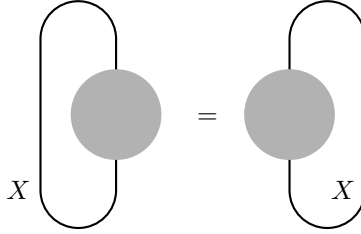

FIGURE 5. Spherical property

\square

Of course, this was exactly the motivation for the definition of spherical category in [BW1996].

Let now $P = \{p_1, \dots, p_k\}$ be a finite collection of distinct points in Σ . By the Lemma 3.7, we have an surjection $H^{\text{string}}(\Sigma - P) \rightarrow H^{\text{string}}(\Sigma)$.

Theorem 3.9. *Let $P = \{p_1, \dots, p_k\} \subset \Sigma$. For each point $p \in P$, let*

$$(3.8) \quad B_p: H^{\text{string}}(\Sigma - P) \rightarrow H^{\text{string}}(\Sigma - P)$$

be the operator that adds to a colored graph Γ a small loop around puncture p colored as shown in Figure 6.

- (1) Each B_p is a projector: $B_p^2 = B_p$.
- (2) Operators B_{p_i} for different points p_i commute. Thus, the operator $B_P = \prod_{p \in P} B_p: H^{\text{string}}(\Sigma - P) \rightarrow H^{\text{string}}(\Sigma - P)$ is also a projector.
- (3) The map $H^{\text{string}}(\Sigma - P) \rightarrow H^{\text{string}}(\Sigma)$ gives an isomorphism

$$\text{Im}(B_P) = \{\psi \in H^{\text{string}}(\Sigma - P) \mid B_P \psi = \psi\} \simeq H^{\text{string}}(\Sigma)$$

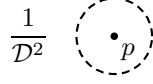
FIGURE 6. Operator B_p

Proof. Part (1) follows from Corollary 3.5; part (2) is obvious from the definition.

To prove part (3), denote by π the natural map $H^{string}(\Sigma - P) \rightarrow H^{string}(\Sigma)$. Then it follows from Corollary 3.5 and Lemma 3.7 that for any $\psi \in \ker(\pi)$, we have $B_P\psi = 0$; thus, B_P is well defined on $H^{string}(\Sigma)$. Using Corollary 3.5 again, we see that B_P acts by identity on $H^{string}(\Sigma)$: for every ψ , we have $\pi(B_P\psi) = \pi(\psi)$. This proves the lemma. \square

4. TURAEV-VIRO MODEL

In this section we recall the definition of Turaev–Viro model for an arbitrary spherical fusion category \mathcal{A} . The definition, given in [BW1996], generalizes the original definition of Turaev and Viro given in [TV1992]. Our exposition follows our earlier paper [BalK2010], to which the reader is referred for details and proofs. We give an overview here for reader’s convenience.

Let Σ be an oriented closed surface and let Δ be a cell decomposition of Σ . We will consider not just triangulations but more general cell decompositions, namely PLCW decompositions as defined in [Kir2010]. Without going into details, it suffices to say here that 2-cells of such a decomposition are images of n -gons (with $n \geq 1$) mapped into Σ so that the map is injective on the interior of the polygon and also injective on the interior of every edge, but is allowed to identify different edges or different vertices of the same polygon. An example of such a cell decomposition would be a 2-torus obtained by gluing together opposite edges of a rectangle.

From now on, the words “cell decomposition” and “cell complex” will stand for PLCW decomposition and PLCW complex as defined in [Kir2010].

For every such cell decomposition we can define the state space

$$H_{TV}(\Sigma, \Delta) = \bigoplus_l \bigotimes_C H(C, l)$$

where l is a coloring of edges of Δ by simple objects of \mathcal{A} , C is a 2-cell of Δ , and

$$(4.1) \quad H(C, l) = \langle l(e_1), l(e_2), \dots, l(e_n) \rangle, \quad \partial C = e_1 \cup e_2 \cdots \cup e_n$$

where the edges e_1, \dots, e_n are taken in the counterclockwise order on ∂C as shown in Figure 7.

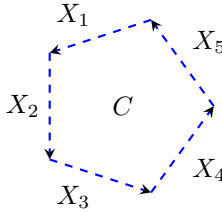

$$H(C) = \langle X_1, \dots, X_n \rangle = \text{Hom}_{\mathcal{A}}(\mathbf{1}, X_1 \otimes \cdots \otimes X_n)$$

FIGURE 7. State space for a cell

Next, given a cobordism M between two surfaces Σ, Σ' with cell decompositions, one can define an operator $Z(M): H_{TV}(\Sigma, \Delta) \rightarrow H_{TV}(\Sigma', \Delta')$; it is defined using a cell decomposition of M but can be shown to be independent of the choice of the decomposition (see [BalK2010, Theorem 4.4]). In particular, taking $M = \Sigma \times I$, we get an operator $Z(\Sigma \times I): H_{TV}(\Sigma, \Delta) \rightarrow H_{TV}(\Sigma, \Delta)$ which can be shown to be a projector. We now define the Turaev–Viro space associated to Σ as

$$Z_{TV}(\Sigma, \Delta) = \text{Im}(Z(M \times I)).$$

It can be shown that for any two cell decompositions Δ, Δ' of the same surface Σ , we have a canonical isomorphism $Z_{TV}(\Sigma, \Delta) \simeq Z_{TV}(\Sigma, \Delta')$ (see [BalK2010]); thus, this space is determined just by the surface Σ . Therefore, we will omit Δ in the notation, writing just $Z_{TV}(\Sigma)$.

5. TV=STRING NETS

In this section we will prove the first main result of the paper.

Theorem 5.1. *Let Σ be a closed oriented surface. Then one has a canonical isomorphism*

$$H^{string}(\Sigma) \simeq Z_{TV}(\Sigma).$$

The proof of the theorem occupies the rest of this section. Throughout the proof, we assume that Σ is closed (i.e., it is compact without boundary).

We begin by choosing a cell decomposition Δ of Σ . Then we have a natural map $\pi_\Delta: H_{TV}(\Sigma, \Delta) \rightarrow H^{string}(\Sigma)$ defined as follows. Let Γ_Δ be the dual graph of Δ . Then each coloring l of edges of Δ defines a coloring of edges of Γ_Δ , and for every 2-cell C of Δ , a vector $\Phi \in H(C, l)$ defines a coloring of the vertex v of Γ_Δ corresponding to C , as shown in Figure 8; thus, for a fixed choice of colors l of edges, every vector $\Psi \in \bigotimes_C H(C, l)$ defines a coloring of Γ_Δ which we will denote by $\tilde{\Psi}$.

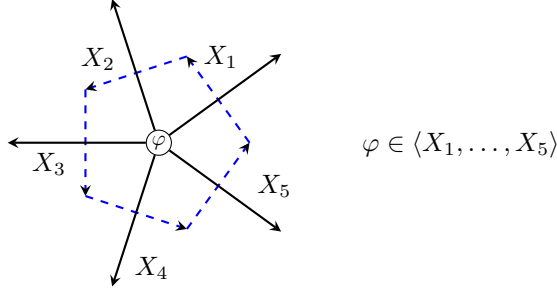

FIGURE 8. Coloring of the dual graph.

Define now the map π_Δ by

$$(5.1) \quad \pi_\Delta: H_{TV}(\Sigma, \Delta) \rightarrow H^{string}(\Sigma)$$

$$\Psi \mapsto (\Gamma_\Delta, \sqrt{d_l} \tilde{\Psi}), \quad \sqrt{d_l} = \prod_e d_{l(e)}^{\frac{1}{2}}$$

where the product is over all (unoriented) edges e of Δ and $d_{l(e)}$ is the dimension of the color $l(e)$ (it does not depend on the choice of orientation).

The map (5.1) can be rewritten as follows. Let Δ^0 be the set of vertices of the cell decomposition Δ and let

$$H_{\Delta}^{string} = H^{string}(\Sigma - \Delta^0).$$

Then we have a natural surjective map $H_{\Delta}^{string} \rightarrow H^{string}(\Sigma)$ (see Lemma 3.7), and the map (5.1) can be written as the composition

$$(5.2) \quad H_{TV}(\Sigma, \Delta) \rightarrow H_{\Delta}^{string} \rightarrow H^{string}(\Sigma).$$

Now Theorem 5.1 immediately follows from the three lemmas below.

Lemma 5.2. *Let Δ, Δ' be two different cell decompositions of Σ , and $f_{\Delta, \Delta'} = Z(\Sigma \times I): H(\Sigma, \Delta) \rightarrow H(\Sigma, \Delta')$ be the canonical linear map defined by the cylinder $\Sigma \times I$ with any cell decomposition extending Δ, Δ' on the boundary (see[BalK2010, Theorem 4.4]). Then the following diagram is commutative:*

$$\begin{array}{ccc} H(\Sigma, \Delta) & \xrightarrow{\pi_{\Delta}} & H^{string}(\Sigma) \\ f_{\Delta, \Delta'} \downarrow & & \nearrow \pi_{\Delta'} \\ H(\Sigma, \Delta') & & \end{array}$$

Lemma 5.3. *The map $H_{TV}(\Sigma, \Delta) \rightarrow H_{\Delta}^{string}$ defined by (5.2) is an isomorphism.*

Lemma 5.4. *The isomorphism $H_{TV}(\Sigma, \Delta) \rightarrow H_{\Delta}^{string}$ defined by (5.2) identifies the operator $A = Z(\Sigma \times I): H_{TV}(\Sigma, \Delta) \rightarrow H_{TV}(\Sigma, \Delta)$ with the operator*

$$B_{\Delta^0} = \prod_{p \in \Delta^0} B_p: H_{\Delta}^{string} \rightarrow H_{\Delta}^{string},$$

where Δ^0 is the set of vertices of Δ and operators B_p are defined in Theorem 3.9.

Combining these lemmas with the result of Theorem 3.9, we get the statement of Theorem 5.1.

We now proceed to the proofs of the three lemmas above.

Proof of Lemma 5.2. By the results of [Kir2010], any two cell decompositions of Σ are related by a sequence of elementary moves M1 (erasing a vertex of valency 2) and M2 (erasing an edge separating two different cells). Thus, it suffices to prove the result in these two special cases, where it is an easy explicit computation. \square

Proof of Lemma 5.3. We will prove the theorem by constructing an inverse map $H_{\Delta}^{string} \rightarrow H_{TV}(\Sigma, \Delta)$. To do that, we first give a different description of H_{Δ}^{string} .

Lemma 5.5. *Let $VGraph_{\Delta}$ be the space of formal linear combinations of colored graphs in $\Sigma - \Delta^0$ which are transversal to edges of Δ (i.e., no vertex of Γ is on an edge of Δ , and all edges of Γ intersect edges of Δ transversally). Then*

$$H_{\Delta}^{string} = VGraph_{\Delta} / N$$

where N is the subspace generated by

- Local relations inside each 2-cell of Δ
- Local move of moving a vertex through an edge of Δ as shown in Figure 9.

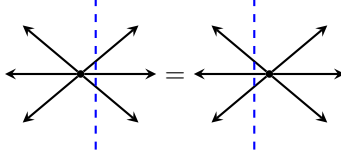
 FIGURE 9. A defining relation for H_{Δ}^{string}

Proof of this lemma is left to the reader as an easy exercise.

We now define the inverse map $H_{\Delta}^{string} \rightarrow H_{TV}(\Sigma, \Delta)$ as follows. Let Γ be a colored graph satisfying the conditions of Lemma 5.5. For any simple coloring l of edges of Δ , let Γ^l be the formal linear combination of colored graphs obtained from Γ by replacing, for every edge e of Δ , all edges of Γ crossing e by a single edge colored by $l(e)$, as shown in Figure 10.

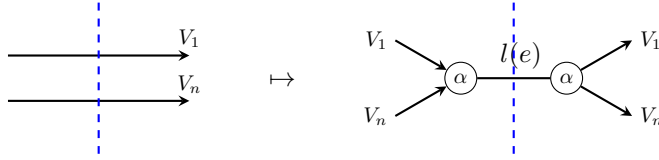
 FIGURE 10. Transformation $\Gamma \mapsto \Gamma^l$.

It is immediate from definition that if we consider the intersection $\Gamma^l \cap C$, where C is a 2-cell of Δ , then the expectation value

$$\langle \Gamma^l \cap C \rangle_C \in \langle l(e_1), \dots, l(e_n) \rangle = H(C, l)$$

where, as in Section 4, $l(e_1), \dots, l(e_n)$ are edges of C taken in counterclockwise order. Thus, we can define the map

$$\begin{aligned} s: \text{VGraph}_{\Delta} &\rightarrow H_{TV}(\Sigma, \Delta) \\ \Gamma &\mapsto \sum_l \sqrt{d_l} \bigotimes_C \langle \Gamma^l \rangle_C \end{aligned}$$

It easily follows from Lemma 5.5 and Lemma 3.6 that s descends to the string net space H_{Δ}^{string} . Local relations (3.1) imply that s is inverse of the map $\pi: H_{TV}(\Sigma, \Delta) \rightarrow H_{\Delta}^{string}$, which completes the proof of Lemma 5.3. \square

Proof of Lemma 5.4. We need to prove that for any $\varphi \in H_{TV}(\Sigma, \Delta)$ we have

$$\pi_{\Delta}(A\varphi) = \left(\prod B_p \right) \pi_{\Delta}(\varphi)$$

where $A = Z_{TV}(\Sigma \times I)$.

To avoid complicated notation, we illustrate the proof using the cell decomposition below.

Let $\varphi = \bigotimes_C \varphi_C \in H_{TV}(\Sigma, \Delta)$, so that

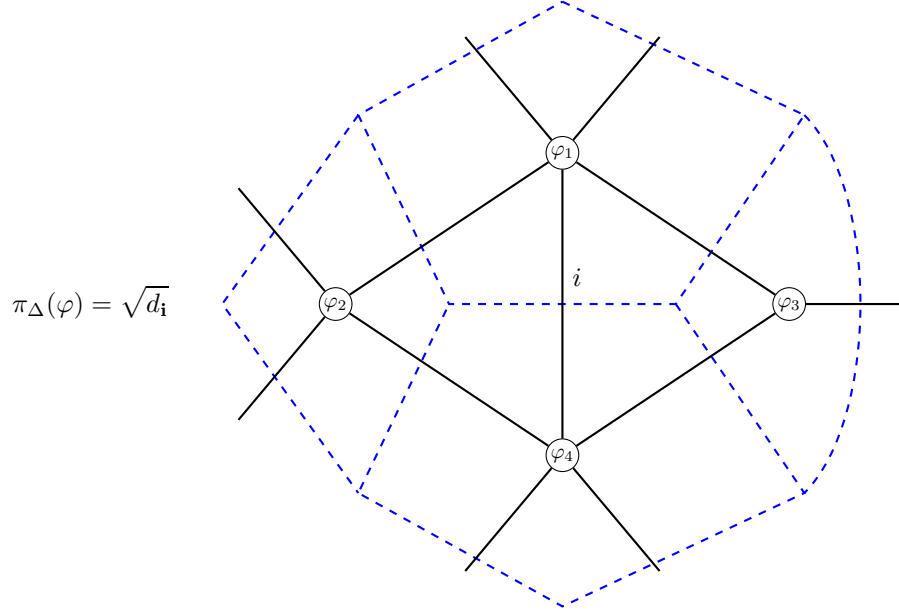

where $\mathbf{i} = (i_1, \dots, i_n)$ is the collection of colors of the edges of the dual graph Γ_Δ , and $\sqrt{d_{\mathbf{i}}} = \prod \sqrt{d_{i_e}}$. (For illustration we have marked just one of the colors i_e in the figure).

Let us consider the cylinder $\Sigma \times I$ with the obvious cell decomposition: its cells are of the form $C \times I$, where C is a cell of Δ , and let $A = Z(\Sigma \times I): H_{TV}(\Sigma, \Delta) \rightarrow H_{TV}(\Sigma, \Delta)$ be the corresponding operator as defined in Section 4. Then an easy explicit computation using results of[BalK2010] shows that

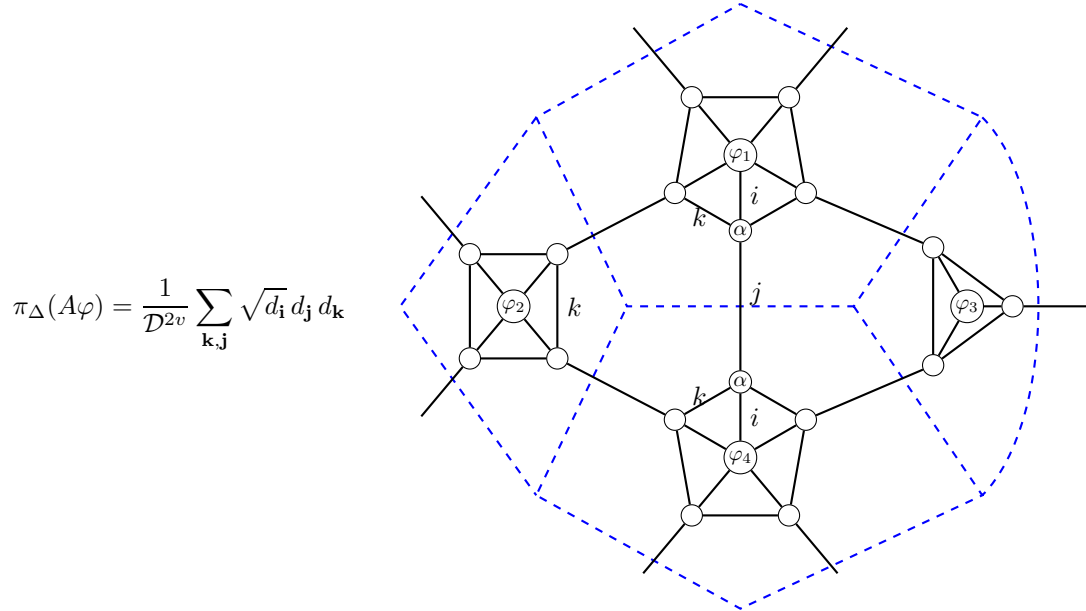

where v is the number of vertices of the cell decomposition Δ and \mathbf{j}, \mathbf{k} are described below.

In this figure there are 3 kinds of edges:

“inner” (they come in pairs of the same color; one such pair is labeled by i in the figure). We denote by \mathbf{i} the set of colors of all such pairs.

“outer” (one such is labeled by letter j). We denote by \mathbf{j} the set of colors of all such edges

“side” (these edges are dual to the edges $p \times I$ of $\Sigma \times I$, where p is a vertex of Δ ; they come in “tuples” — as many edges of the same color as there are cells incident to a given vertex. One such “tuple” is labeled k in the figure). We denote by \mathbf{k} the set of colors of all such “tuples”

The small circles correspond to 2-cells $e \times I$ of $\Sigma \times I$, where e is an edge of Δ ; they come in pairs (one such pair is labeled by letter α in the figure; as before, we assume summation over dual bases).

Now, using relation (3.1) we can contract all “outer” edges, rewriting this as

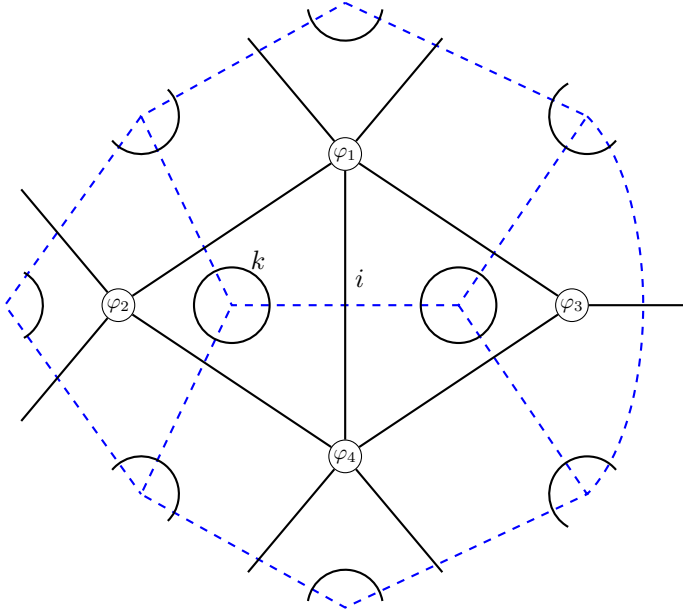
$$\pi_{\Delta}(A\varphi) = \frac{1}{\mathcal{D}^{2v}} \sum_{\mathbf{k}} \sqrt{d_{\mathbf{i}}} d_{\mathbf{k}}$$

$$= \left(\prod B_p \right) \pi_{\Delta}(\varphi)$$

□

This completes the proof of Theorem 5.1.

6. CATEGORY OF BOUNDARY VALUES

We now consider string nets on surfaces with boundary. In this section we will show that possible boundary values are described by objects in a certain abelian category $\mathcal{C}(\partial\Sigma)$; choosing a homeomorphism $\partial\Sigma \simeq (S^1)^n$ gives an equivalence $\mathcal{C}(\Sigma) \simeq \mathcal{C}^{\boxtimes n}$, where $\mathcal{C} = \mathcal{C}(S^1)$ is the so-called Drinfeld center of \mathcal{A} . Thus, for any choice of objects $Y_1, \dots, Y_n \in \mathcal{C}$ we will have the vector space $Z(\Sigma; Y_1, \dots, Y_n)$ of string nets satisfying boundary condition given by $Y_1 \boxtimes \dots \boxtimes Y_n$.

In physics literature, the space $Z(\Sigma; Y_1, \dots, Y_n)$ is usually thought of as the space of “excited states” on the surface $\hat{\Sigma}$ obtained by gluing a disk D_i to every boundary circle of Σ ; more precisely, vectors in $Z(\Sigma; Y_1, \dots, Y_n)$ are said to describe states which have excitations localized in disks D_i , with Y_i describing the type of such an excitation. Simple objects Y_i are said to describe “quasiparticle states” or “anyons” (see [Kit2003]).

We begin by explaining the reasoning that leads us to the correct definition of the category $\mathcal{C}(\partial\Sigma)$; readers who are interested in the final answer can skip to Definition 6.1.

Let us for simplicity assume that $S = \partial\Sigma$ is a single circle. Since the string nets are allowed to meet the boundary circle, the first natural idea is to say that the boundary condition is described by a collection $B = \{b_1, \dots, b_k\}$ of marked points on S colored by objects V_1, \dots, V_k of \mathcal{A} , as was done in Section 2. However, it is also natural to impose the local relation shown in Figure 11.

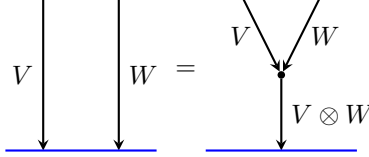

FIGURE 11. A local move for string nets on a surface with boundary. Here the vertex should be colored by element in $\langle W^*, V^*, V \otimes W \rangle$ corresponding to the identity morphism $V \otimes W \rightarrow V \otimes W$.

Thus, the boundary condition described by a collection of objects $V_1, \dots, V_i, V_{i+1}, \dots$ should be considered equivalent to the boundary condition described by the collection $V_1, \dots, V_i \otimes V_{i+1}, \dots$. Since using this equivalence, any collection of objects V_1, \dots, V_k can be replaced by a single object $V = V_1 \otimes \dots \otimes V_k$, one can think that the boundary condition is described just by an object $V \in \mathcal{A}$; this is the point of view taken in [KKR2010].

Unfortunately, this is not the right definition. To see why it is so, consider the case when we have two points on the boundary circle colored by objects $V, W \in \mathcal{A}$. Then, as described above, this boundary condition is equivalent to the one described by a single point colored by $V \otimes W$. On the other hand, we could also move point colored by W around the circle, arriving at the pair W, V , which is equivalent to $W \otimes V$. Thus, in our yet to be defined category of boundary conditions, we must have the relation $V \otimes W \simeq W \otimes V$. Informally, we could say that this category should be something like the quotient

$$(6.1) \quad \mathcal{C} = \mathcal{A}/(V \otimes W \simeq W \otimes V)$$

Of course, defining a “quotient category” is more complicated than just defining a quotient of a vector space, so one needs to make sense out of this formula. One way to do it is to use the results of [Gre2009], which gives the answer: when properly defined, the quotient (6.1) is exactly the Drinfeld center of \mathcal{A} . However, we choose to use a different approach (which, of course, gives the same answer).

We can now give a precise definition.

Definition 6.1. Let S be an oriented 1-dimensional manifold (not necessarily connected). Define $\hat{\mathcal{C}}(S)$ as the category whose objects are finite subsets $B \subset S$ together

with a choice of object $V_b \in \text{Obj } \mathcal{A}$ for every point $b \in B$; we will use a notation $\mathbf{V} = (B, \{V_b\})$ for such an object. Define the morphisms in $\widehat{\mathcal{C}}(S)$ by

$$\text{Hom}_{\widehat{\mathcal{C}}}(V, V') = H^{\text{string}}(S \times I; \mathbf{V}^*, \mathbf{V}'), \quad \mathbf{V} = (B, \{V_b\}), \quad \mathbf{V}' = (B', \{V_{b'}\})$$

where $\mathbf{V}^*, \mathbf{V}'$ means the boundary condition obtained by putting points $b \in B$ on the “top” $S \times \{1\}$, colored by objects V_b^* for outgoing legs (and thus colored by V_b for incoming legs), and putting points $b' \in B'$ on the “bottom” $S \times \{0\}$, colored by objects $V_{b'}$ for outgoing legs.

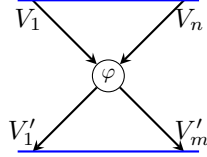

FIGURE 12. Morphisms in $\widehat{\mathcal{C}}(S)$

Note also, if $b, b' \in B$ are such that b' is the successor of b in the order given by orientation of S , then we have an isomorphism $(\dots V_b, V_{b'}, \dots) \simeq (\dots V_b \otimes V_{b'}, \dots)$ in $\widehat{\mathcal{C}}$ shown in Figure 13. Thus, the category $\widehat{\mathcal{C}}$ meets the requirements outlined in informal discussion before.

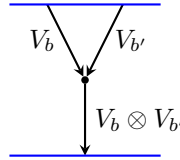

FIGURE 13.

Note that $\widehat{\mathcal{C}}$ in general is not an abelian category, even though the morphisms do form vector spaces. Let $\mathcal{C}(S)$ be the pseudo-abelian completion of $\widehat{\mathcal{C}}$ i.e., the category obtained by adjoining finite direct sums and images of idempotents. Recall that the morphisms in this category are defined by

$$(6.2) \quad \text{Hom}_{\mathcal{C}(S)}(Y_1, Y_2) = \{f \in \text{Hom}_{\widehat{\mathcal{C}}(S)}(X_1, X_2) \mid P_2 f = f P_1 = f\}$$

if $Y_i = \text{Im}(P_i)$ for some idempotents $P_i: X_i \rightarrow X_i$, $X_i \in \text{Obj } \widehat{\mathcal{C}}(S)$.

Example 6.2. Let $S = \mathbb{R}$. Then $\widehat{\mathcal{C}}(S) \simeq \mathcal{C}(S) \simeq \mathcal{A}$, with the equivalence given by $(V_{p_1}, \dots, V_{p_n}) \mapsto V_{p_1} \otimes \dots \otimes V_{p_n}$.

Theorem 6.3.

- (1) Any orientation-preserving homeomorphism of 1-dimensional manifolds $\varphi: S \rightarrow S'$ gives rise to an equivalence $\varphi_*: \mathcal{C}(S) \rightarrow \mathcal{C}(S')$ such that $(\varphi\psi)_* = \varphi_*\psi_*$ (note that it is an equality and not just an isomorphism). Moreover, every homotopy φ_t between two homeomorphisms gives rise to a isomorphism of functors $\varphi_0 \rightarrow \varphi_1$.
- (2) One has a natural equivalence $\mathcal{C}(S \sqcup S') \simeq \mathcal{C}(S) \boxtimes \mathcal{C}(S')$.

The proof is straightforward.

Theorem 6.4. *Let S^1 be the standard circle. Then one has an equivalence $J: \mathcal{C}(S^1) \simeq Z(\mathcal{A})$, where $Z(\mathcal{A})$ is the Drinfeld center of \mathcal{A} (see Section 8).*

Before proving this theorem, we note the following useful corollary.

Corollary 6.5. *For any oriented 1-manifold S , $\mathcal{C}(S)$ is an abelian category.*

Indeed, it immediately follows from the fact that $\mathcal{C}(\mathbb{R}) \simeq \mathcal{A}$ and $\mathcal{C}(S^1) \simeq Z(\mathcal{A})$ are abelian (Example 6.2, Theorem 6.4) and Theorem 6.3.

Proof of Theorem 6.4. The proof uses several results about Drinfeld center of \mathcal{A} , which are collected in Section 8. In particular, we will denote by $F: Z(\mathcal{A}) \rightarrow \mathcal{A}$ the forgetful functor and by $I: \mathcal{A} \rightarrow Z(\mathcal{A})$ the adjoint functor. Explicit description of this functor can be found in Section 8.

As before, we will frequently use graphical presentation of morphisms which involve objects both of \mathcal{A} and $Z(\mathcal{A})$. In these diagrams, we will show objects of $Z(\mathcal{A})$ by double green lines and the half-braiding isomorphism $\varphi_Y: Y \otimes V \rightarrow V \otimes Y$ by crossing as in Figure 14.

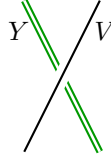

FIGURE 14. Graphical presentation of the half-braiding $\varphi_Y: Y \otimes V \rightarrow V \otimes Y$, $Y \in \text{Obj } Z(\mathcal{A})$, $V \in \text{Obj } \mathcal{A}$

Let \mathcal{C}' be the full subcategory in $\widehat{\mathcal{C}}(S^1)$ formed by objects $\mathbf{V} = (B, \{V_b\})$ such that B does not contain the point $p_0 = (1, 0) \in S^1$. Since it is obvious that every object in $\widehat{\mathcal{C}}(S^1)$ is isomorphic to an object in \mathcal{C}' , the inclusion $\mathcal{C}' \subset \mathcal{C}$ is an equivalence.

Let us now construct the functor $J: \mathcal{C}' \rightarrow Z(\mathcal{A})$ as follows. Let $\mathbf{V} = (B, \{V_b\})$ be an object in \mathcal{C}' . Number the points of B , writing $B = \{b_1, \dots, b_k\}$ going counterclockwise starting with p_0 . Define

$$J(\mathbf{V}) = I(V_1 \otimes \dots \otimes V_k)$$

where $I: \mathcal{A} \rightarrow Z(\mathcal{A})$ is the functor (8.1).

Now, define J on morphisms as follows. Let $\Gamma \in H^{string}(S^1 \times I)$ be a colored graph representing a morphism $\mathbf{V} \rightarrow \mathbf{V}'$. Without loss of generality, we can assume that this graph does not have any vertices on the interval $\{p_0\} \times I$. Define $J(\Gamma): J(\mathbf{V}) \rightarrow J(\mathbf{V}')$ be the morphism represented by the graph $\Gamma'' \subset [0, 1] \times I$, obtained by

- (1) Replacing all edges of Γ crossing $\{p_0\} \times I$ by a single edge, colored by a linear combination of simple objects of \mathcal{A} , as in the proof of Lemma 5.3.
- (2) Cutting the cylinder along the interval $\{p_0\} \times I$, to get a colored graph in $[0, 1] \times I$
- (3) Adding to the obtained graph four new legs and two vertices colored as in Figure 15.

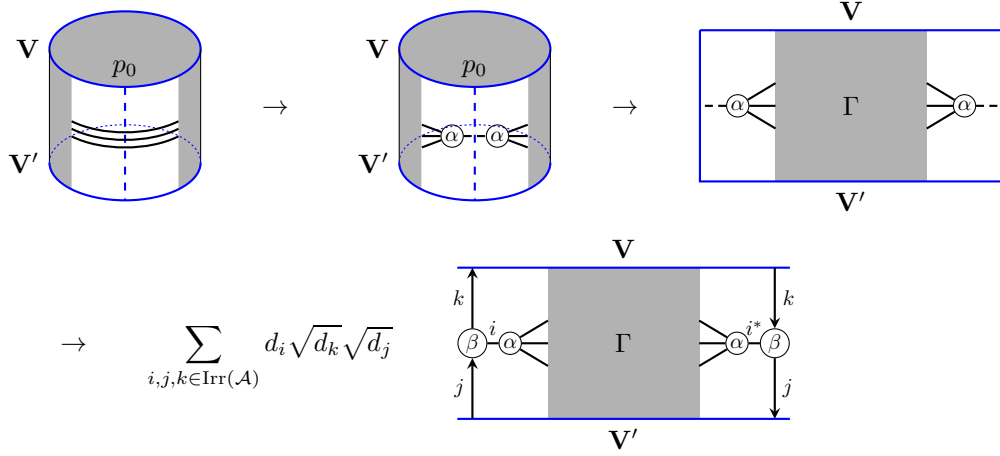

FIGURE 15.

The same argument as in the proof of Theorem 8.2 shows that $J(\Gamma)$ only depends on the class $\langle \Gamma \rangle$ in $H^{string}(S^1 \times I)$. By Lemma 8.4, $J(\Gamma) \in \text{Hom}_{Z(\mathcal{A})}(J(\mathbf{V}), J(\mathbf{V}'))$. It is also easy to see that so defined J preserves composition of morphisms; thus, we have defined a functor $J: \mathcal{C}' \rightarrow Z(\mathcal{A})$.

It is obvious from the definition that J is additive and that its essential image consists of objects of the form $I(V)$, $V \in \text{Obj}(\mathcal{A})$. Since $Z(\mathcal{A})$ is an abelian category, it is clear that this functor extends naturally to the pseudo-abelian completion of \mathcal{C}' which is equivalent to the pseudo-abelian completion \mathcal{C} of $\widehat{\mathcal{C}}(S^1)$. Since every object in $Z(\mathcal{A})$ is a direct summand of some object of the form $I(V)$, $V \in \mathcal{A}$ (see remark after Lemma 8.3), we see that the functor $J: \mathcal{C} \rightarrow Z(\mathcal{A})$ is essentially surjective.

To prove that J is an equivalence, we construct the inverse functor $K: Z(\mathcal{A}) \rightarrow \mathcal{C}'$, which sends an object $Y \in Z(\mathcal{A})$ to the image of the projector $P \in \text{Hom}_{\mathcal{C}(S^1)}(\mathbf{Y}, \mathbf{Y})$ shown in Figure 16; the image makes sense in the pseudo-abelian completion. Using

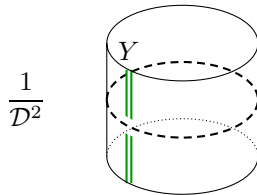

FIGURE 16. The projector $P \in \text{Hom}_{\mathcal{C}(S^1)}(\mathbf{Y}, \mathbf{Y})$. Here \mathbf{Y} is $F(Y)$ placed at the point $(-1, 0) \in S^1$.

Lemma 8.3, it is easy to show that one has canonical functorial isomorphisms $KJ \simeq \text{id}$, $JK \simeq \text{id}$. Thus, J is an equivalence. \square

Note that the explicit construction of the equivalence also gives the following result which we will use later.

Corollary 6.6. *Let $K: Z(\mathcal{A}) \rightarrow \mathcal{C}(S^1)$ be the equivalence constructed in Theorem 6.4. Then for any $\mathbf{V} \in \widehat{\mathcal{C}}(S^1)$, $Y \in Z(\mathcal{A})$, we have*

$$\mathrm{Hom}_{\mathcal{C}(S^1)}(\mathbf{V}, K(Y)) = \{f \in H^{string}(S^1 \times I, \mathbf{V}^*, \mathbf{Y}) \mid Pf = f\}$$

where \mathbf{Y} , P are as shown in Figure 16.

7. EXTENDED THEORY: EXCITED STATES

Let now Σ be an oriented surface with boundary. Recall that then, for every choice of boundary conditions $\mathbf{V} \in \mathrm{Obj} \widehat{\mathcal{C}}(\partial\Sigma)$, we have the vector space of string nets $H^{string}(\Sigma; \mathbf{V})$ (see Definition 3.1). We can extend this to the pseudo-abelian completion $\mathcal{C}(\partial\Sigma)$ as follows.

Definition 7.1. Let Σ be an oriented surface (possibly with boundary) and $Y \in \mathrm{Obj} \mathcal{C}(\partial\Sigma)$. Define

$$H^{string}(\Sigma, Y) = \mathrm{VGraph}(\Sigma, Y)/N$$

where

- $\mathrm{VGraph}(\Sigma, Y)$ is the vector space of formal linear combinations of pairs $\hat{\Gamma} = (\varphi, \Gamma)$, where Γ is a colored graph on Σ with some boundary value \mathbf{V} and $\varphi \in \mathrm{Hom}_{\mathcal{C}(\partial\Sigma)}(\mathbf{V}, Y)$
- N is the subspace of local relations, spanned by the same local relations as in Definition 3.1 (coming from embedded disks $D \subset \Sigma$) and additional relation

$$(7.1) \quad (\varphi f, \Gamma) = (\varphi, f\Gamma)$$

where Γ is a colored graph with boundary value \mathbf{V} and $f \in \mathrm{Hom}_{\mathcal{C}(\partial\Sigma)}(\mathbf{V}, \mathbf{V}') = H^{string}(\partial\Sigma \times I, \mathbf{V}^*, \mathbf{V}')$, $\varphi \in \mathrm{Hom}_{\mathcal{C}(\partial\Sigma)}(\mathbf{V}', Y)$. Here $f\Gamma$ means the graph obtained by composing Γ and f .

It is immediate from the definition that for $Y \in \widehat{\mathcal{C}}(\partial\Sigma)$, this definition coincides with Definition 3.1; it is also obvious that this definition is functorial in Y .

Note that if we choose, for every boundary circle $(\partial\Sigma)_a$ of Σ , an orientation-preserving homeomorphism $\psi_a: (\partial\Sigma)_a \rightarrow S^1$, then by Theorem 6.4, Theorem 6.3, this gives rise to an equivalence

$$(7.2) \quad K_\psi: Z(\mathcal{A})^{\boxtimes A} \simeq \mathcal{C}(\partial\Sigma)$$

where A is the set of boundary components of $\partial\Sigma$. Thus, given a collection of objects $Y_a \in Z(\mathcal{A})$, $a \in A$, we can define the space

$$(7.3) \quad H^{string}(\Sigma, \{\psi_a\}, \{Y_a\}) = H^{string}(\Sigma, K_\psi(\boxtimes Y_a))$$

The space $H^{string}(\Sigma, \{\psi_a\}, \{Y_a\})$ admits an alternative definition. Namely, let $\widehat{\Sigma}$ be the closed surface obtained by gluing to Σ a copy of the standard 2-disk D along each boundary circle $(\partial\Sigma)_a$ of Σ , using parametrization ψ_a . So defined surface comes with a collection of marked points $p_a = \psi_a^{-1}(p)$, where $p = (1, 0)$ is the marked point on S^1 . Moreover, for every point p_a we also have a distinguished ‘‘tangent direction’’ v_a at p_a (in PL setting, we understand it as a germ of an arc staring at p_a), namely the direction of the radius connecting p with the center of the disk D . We will refer to the collection $(\widehat{\Sigma}, \{p_a\}, \{v_a\})$ as an *extended surface*. It is easy to see that given $(\widehat{\Sigma}, \{p_a\}, \{v_a\})$, the original surface Σ and parametrizations ψ_a are defined uniquely up to a contractible set of choices.

Given such an extended surface $\widehat{\Sigma}$ and a collection of objects $Y_a \in Z(\mathcal{A})$, one object for each marked point p_a , define the string net space

$$(7.4) \quad \hat{H}^{string}(\widehat{\Sigma}, \{p_a\}, \{v_a\}, \{Y_a\}) = \text{VGraph}'(\widehat{\Sigma}, \{p_a\}, \{v_a\}, \{Y_a\})/N$$

where

- $\text{VGraph}'(\widehat{\Sigma}, \{p_a\}, \{v_a\}, \{Y_a\})$ is the vector space of formal linear combinations of colored graphs on $\widehat{\Sigma}$ such that each colored graph has an uncolored one-valent vertex at each point p_a , with the corresponding edge coming from direction v_a (i.e., in some neighborhood of p_a , the edge coincides with the corresponding arc) and colored by the object $F(Y_a)$ as shown in Figure 17.

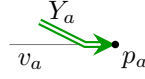

FIGURE 17. Colored graphs in a neighborhood of marked point

- N is the subspace of local relations, spanned by the same local relations as in Definition 3.1 coming from embedded disks $D \subset \Sigma$ not containing the special points p_a and additional local relations in a neighborhood of each marked point p_a shown in Figure 18.

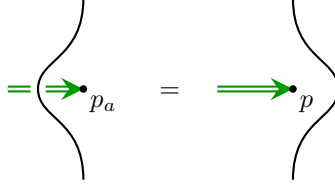

FIGURE 18. Extra local relation near marked point

Theorem 7.2. *Let $\Sigma, \widehat{\Sigma}$ be as above, and let $Y_a, a \in A$, be a collection of objects in $Z(\mathcal{A})$, one object for each boundary component of Σ . Then one has a canonical isomorphism*

$$(7.5) \quad H^{string}(\Sigma, \{\psi_a\}, \{Y_a\}) \simeq \hat{H}^{string}(\widehat{\Sigma}, \{p_a\}, \{v_a\}, \{Y_a\})$$

Proof. Denote for brevity

$$H^{string} = H^{string}(\Sigma, \{\psi_a\}, \{Y_a\})$$

$$\hat{H}^{string} = \hat{H}^{string}(\widehat{\Sigma}, \{p_a\}, \{v_a\}, \{Y_a\})$$

By definition, the space H^{string} is defined as the vector space of pairs $(\{\varphi_a\}, \Gamma)$ modulo local relations; here Γ is a colored graph on Σ with boundary value $\mathbf{V} = \{\mathbf{V}_a\}, a \in A$, and

$$\varphi_a \in \text{Hom}_{\mathcal{C}(S^1)}(\mathbf{V}_a, K(Y_a)) = \{f \in \text{Hom}_{\widehat{\mathcal{C}}(S^1)}(\mathbf{V}_a, \mathbf{Y}_a) \mid Pf = f\}$$

where \mathbf{Y}, P are as in Corollary 6.6.

Construct the map $T: H^{string} \rightarrow \hat{H}^{string}$ by

$$T(\{\varphi_a\}, \Gamma) = \Gamma'$$

where the graph Γ' is given by Figure 19 in the neighborhood of the glued disk D_a and coincides with Γ elsewhere.

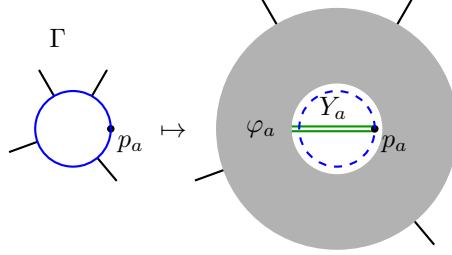

FIGURE 19. Map $T: H^{string} \rightarrow \hat{H}^{string}$. The shaded area represents $\varphi_a \in \text{Hom}_{\mathcal{C}(S^1)}(\mathbf{V}_a, K(Y_a))$.

It is immediate from the definition that this map is well defined and surjective. To prove that it is actually an isomorphism, construct now the map

$$S: \hat{H}^{string}(\hat{\Sigma}, \{p_a\}, \{v_a\}, \{Y_a\}) \rightarrow H^{string}(\Sigma, \{\psi_a\}, \{Y_a\})$$

$$\Gamma \mapsto (\{\text{id}\}, \Gamma')$$

where Γ' is given by Figure 20 in the neighborhood of the boundary component $(\partial\Sigma)_a$ and coincides with Γ elsewhere.

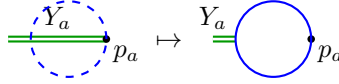

FIGURE 20. Map $S: \hat{H}^{string} \rightarrow H^{string}$

It is easily checked that the map S is well defined and is inverse to T . This completes the construction of the isomorphism. \square

We can now prove the second main result of the paper, extending Theorem 5.1 to the case of surfaces with boundary. Recall that one can extend Turaev–Viro theory, defining vector spaces $Z_{TV}(\Sigma, \{Y_a\}_{a \in A})$ for a surface Σ with boundary together with a choice of marked point on each boundary component and a choice of an object $Y_a \in Z(\mathcal{A})$ for each boundary component (see [BalK2010]). Since a choice of a parameterization $\psi_a: (\partial\Sigma)_a \rightarrow S^1$ also determines a marked point $p_a = \psi_a^{-1}(p)$, $p = (1, 0) \in S^1$, we can also define the space $Z_{TV}(\Sigma, \{Y_a\})$ for a surface with a parametrized boundary.

Theorem 7.3. *Let Σ be a compact oriented surface with boundary together with a choice of a parameterization $\psi_a: (\partial\Sigma)_a \rightarrow S^1$ for each boundary component and a choice of an object $Y_a \in Z(\mathcal{A})$ for each boundary component. Then one has a canonical isomorphism*

$$Z_{TV}(\Sigma, \{Y_a^*\}_{a \in A}) \simeq H^{string}(\Sigma, \{Y_a\})$$

where A is the set of connected components of the boundary of Σ .

Proof. The proof repeats with necessary changes the proof of Theorem 5.1. We outline the main steps below, stressing the changes.

First, we need to choose a cell decomposition Δ of Σ such that for each boundary circle, the marked point p_a is one of the vertices of Δ . This this also gives a cell decomposition $\hat{\Delta}$ of the surface $\hat{\Sigma}$ obtained by gluing a disk to every boundary component of Σ (see Theorem 7.2). As in [BalK2010], this allows us to define the vector space $H_{TV}(\hat{\Sigma}, \{Y_a^*\})$. As before, we let Δ^0 be the set of all vertices of Δ .

Define now the string net space $\hat{H}_{\Delta}^{string}(\hat{\Sigma}, \{Y_a\})$ as the vector space of colored graphs $\Gamma \in \hat{\Sigma} - \Delta^0$ such that in a neighborhood of each marked point p_a the graph looks as shown in Figure 17, modulo the same local relations as in Definition 3.1, for any embedded disk $D \subset \hat{\Sigma} - \Delta^0$ (note that we do not impose extra local relation of Figure 18).

Then we have the following results:

- (1) Define, for every point $p \in \Delta^0$, the operator B_p by Figure 21 if $p = p_a$ is a marked point and by the same formula as in Theorem 3.9 for other vertices.

$$\text{---} \underline{\underline{Y_a}} \bullet p_a \quad \mapsto \quad \frac{1}{D^2} \quad \underline{\underline{Y_a}} \bullet p_a \text{ (in a dashed circle)}$$

FIGURE 21. Operator B_p for the marked point $p = p_a$.

Then operators B_p are mutually commuting projectors, and we have a natural isomorphism

$$H^{string}(\Sigma, \{Y_a\}) \simeq \hat{H}^{string}(\hat{\Sigma}, \{Y_a\}) = \text{Im}(B)$$

where

$$B = \prod_{p \in \Delta^0} B_p: \hat{H}_{\Delta}^{string}(\hat{\Sigma}, \{Y_a\}) \rightarrow \hat{H}_{\Delta}^{string}(\hat{\Sigma}, \{Y_a\})$$

(compare with Theorem 3.9).

The proof of this result is quite similar to the proof of Theorem 3.9; details are left to the reader.

- (2) One has a natural isomorphism $\hat{H}_{\Delta}^{string}(\hat{\Sigma}, \{Y_a\}) \simeq H_{TV}(\Sigma, \Delta, \{Y^*\})$

The isomorphism is constructed in the same way as in Lemma 5.3, with the only change that for the glued disk D_a (which is a cell of the decomposition $\hat{\Delta}$), we add an extra edge to the dual graph Γ_{Δ} and coloring of the vertex is as shown in Figure 22.

- (3) The isomorphism of the previous part identifies the operator B with $Z_{TV}(\Sigma \times I): H_{TV}(\Sigma, \Delta, \{Y^*\}) \rightarrow H_{TV}(\Sigma, \Delta, \{Y^*\})$

This is proved in the same way as Lemma 5.4

□

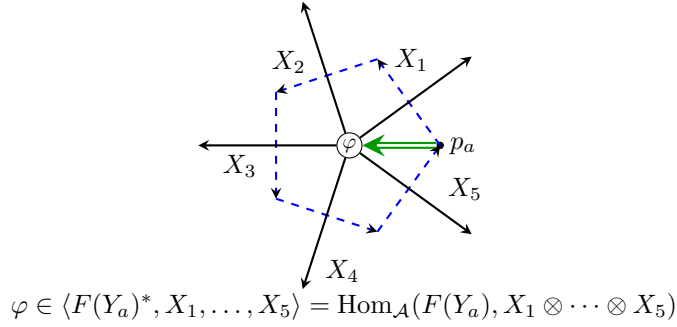

FIGURE 22. Coloring of the dual graph for the embedded disk.

8. DRINFELD CENTER: TECHNICAL LEMMAS

In this section we collect some basic facts about the Drinfeld center of a fusion category, which were used in the proof of Theorem 6.4. Throughout this section, \mathcal{A} be a spherical fusion category over an algebraically closed field of characteristic zero.

Recall that the Drinfeld center $Z(\mathcal{A})$ of a fusion category \mathcal{A} is defined as the category whose objects are pairs (Y, φ_Y) , where Y is an object of \mathcal{A} and φ_Y – a functorial isomorphism $Y \otimes - \rightarrow - \otimes Y$ satisfying certain compatibility conditions (see [Mug2003a]). We will refer to φ_Y as “half-braiding”.

Theorem 8.1. [Mug2003b] *Let \mathcal{A} be a spherical fusion category over an algebraically closed field of characteristic zero. Then $Z(\mathcal{A})$ is a modular category; in particular, it is semisimple with finitely many simple objects, it is braided and has a pivotal structure which coincides with the pivotal structure on \mathcal{A} .*

We have an obvious forgetful functor $F: Z(\mathcal{A}) \rightarrow \mathcal{A}$. To simplify the notation, we will frequently omit it in the formulas, writing for example $\text{Hom}_{\mathcal{A}}(Y, V)$ instead of $\text{Hom}_{\mathcal{A}}(F(Y), V)$, for $Y \in \text{Obj } Z(\mathcal{A})$, $V \in \text{Obj } \mathcal{A}$. Note, however, that if $Y, Z \in \text{Obj } Z(\mathcal{A})$, then $\text{Hom}_{Z(\mathcal{A})}(Y, Z)$ is different from $\text{Hom}_{\mathcal{A}}(Y, Z)$: namely, $\text{Hom}_{Z(\mathcal{A})}(Y, Z)$ is a subspace in $\text{Hom}_{\mathcal{A}}(Y, Z)$ consisting of those morphisms that commute with the half-braiding.

The following theorem, proof of which can be found in [BalK2010], gives an explicit description of the functor $I: \mathcal{A} \rightarrow Z(\mathcal{A})$ adjoint to F .

Theorem 8.2. *Define, for $V \in \text{Obj } \mathcal{A}$*

$$(8.1) \quad I(V) = \bigoplus_{i \in \text{Irr}(\mathcal{A})} X_i \otimes V \otimes X_i^*.$$

Then

- (1) $I(V)$ has a natural structure of an object of $Z(\mathcal{A})$, with the half braiding given by Figure 23.

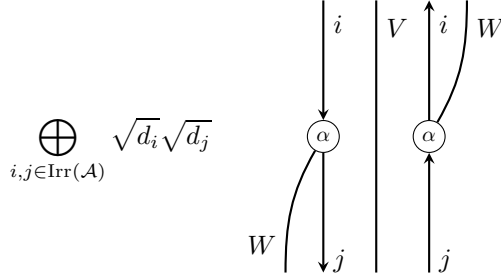

FIGURE 23. Half-braiding $I(V) \otimes W \rightarrow W \otimes I(V)$.

- (2) So defined functor $I: \mathcal{A} \rightarrow Z(\mathcal{A})$ is two-sided adjoint of the forgetful functor $F: Z(\mathcal{A}) \rightarrow \mathcal{A}$: one has functorial isomorphisms

$$\text{Hom}_{\mathcal{A}}(V, F(X)) \simeq \text{Hom}_{Z(\mathcal{A})}(I(V), X)$$

$$(8.2) \quad \varphi \mapsto \sum_{i \in \text{Irr}(\mathcal{A})} \frac{\sqrt{d_i}}{\mathcal{D}} \text{ (diagram) }$$

and

$$\text{Hom}_{\mathcal{A}}(F(X), V) \simeq \text{Hom}_{Z(\mathcal{A})}(X, I(V))$$

$$(8.3) \quad \varphi \mapsto \sum_{i \in \text{Irr}(\mathcal{A})} \frac{\sqrt{d_i}}{\mathcal{D}} \text{ (diagram) }$$

Lemma 8.3. Let $Y \in \text{Obj } Z(\mathcal{A})$. Define $P_Y \in \text{End}_{\mathcal{A}}(I(Y), I(Y))$ by

$$P_Y = \sum_{i,j \in \text{Irr}(\mathcal{A})} \frac{\sqrt{d_i} \sqrt{d_j}}{\mathcal{D}^2} \text{ (diagram) }$$

Then

- (1) $P_Y \in \text{End}_{Z(\mathcal{A})}(I(Y))$
- (2) $P_Y^2 = P_Y$
- (3) The image of P_Y is canonically isomorphic to Y as an object of $Z(\mathcal{A})$.

Proof. Easily follows from Theorem 8.2. □

In particular, this lemma implies that every object Y in $Z(\mathcal{A})$ is a direct summand of an object of the form $I(V)$ for some $V \in \mathcal{A}$ (suffices to take $V = F(Y)$).

We will need one more lemma.

Lemma 8.4. *For any $V, W \in \text{Obj}(\mathcal{A})$, one has the following commutative diagram of functorial isomorphisms*

$$(8.4) \quad \begin{array}{ccc} \bigoplus_{Z \in \text{Irr}(Z(\mathcal{A}))} \text{Hom}_{\mathcal{A}}(V, Z) \otimes \text{Hom}_{\mathcal{A}}(Z, W) & & \\ \swarrow f_1 & & \searrow f_2 \\ \bigoplus_{i \in \text{Irr}(\mathcal{A})} \text{Hom}_{\mathcal{A}}(V, i \otimes W \otimes i^*) & \xrightarrow{f_3} & \text{Hom}_{Z(\mathcal{A})}(I(V), I(W)) \end{array}$$

where the maps f_i are defined by

$$f_1: \varphi \otimes \psi \mapsto \sum_{i \in \text{Irr}(\mathcal{A})} \frac{\sqrt{d_i}}{\mathcal{D}} \begin{array}{c} V \\ | \\ \textcircled{\varphi} \\ | \\ \textcircled{\psi} \\ | \\ W \end{array} \begin{array}{c} \\ \\ \\ \\ i \end{array}$$

$$f_2: \varphi \otimes \psi \mapsto \sum_{i, j \in \text{Irr}(\mathcal{A})} \frac{\sqrt{d_i} \sqrt{d_j}}{\mathcal{D}^2} \begin{array}{c} V \\ | \\ \textcircled{\varphi} \\ | \\ \textcircled{\psi} \\ | \\ W \end{array} \begin{array}{c} i \\ \\ \\ \\ j \end{array}$$

$$f_3: \varphi \mapsto \sum_{j, k \in \text{Irr}(\mathcal{A})} \frac{\sqrt{d_i} \sqrt{d_j} \sqrt{d_k}}{\mathcal{D}} \begin{array}{c} V \\ | \\ \textcircled{\varphi} \\ | \\ \textcircled{\alpha} \end{array} \begin{array}{c} k \\ | \\ \textcircled{\alpha} \\ | \\ j \end{array} \begin{array}{c} i \\ | \\ \textcircled{\alpha} \\ | \\ W \end{array} \begin{array}{c} i^* \\ | \\ \textcircled{\alpha} \\ | \\ j \end{array} \begin{array}{c} k \\ | \\ \textcircled{\alpha} \\ | \\ j \end{array}$$

The proof of this lemma repeats with minor changes the proof of Theorem 7.3 in [BalK2010].

REFERENCES

- [BakK2001] Bojko Bakalov and Alexander Kirillov Jr., *Lectures on tensor categories and modular functors*, University Lecture Series, vol. 21, American Mathematical Society, Providence, RI, 2001. MR1797619 (2002d:18003)
- [BS2001] Paul Balmer and Marco Schlichting, *Idempotent completion of triangulated categories*, J. Algebra **236** (2001), no. 2, 819–834, DOI 10.1006/jabr.2000.8529. MR1813503 (2002a:18013)

- [Bal2010] Benjamin Balsam, *Turaev-Viro invariants as an extended TQFT II* (October 2010).
- [BalK2010] Benjamin Balsam and Alexander Kirillov Jr, *Turaev-Viro invariants as an extended TQFT*, available at [arXiv:1004.1533](https://arxiv.org/abs/1004.1533).
- [BW1996] John W. Barrett and Bruce W. Westbury, *Invariants of piecewise-linear 3-manifolds*, *Trans. Amer. Math. Soc.* **348** (1996), no. 10, 3997–4022, DOI 10.1090/S0002-9947-96-01660-1. MR1357878 (97f:57017)
- [DGNO] Vladimir Drinfeld, Shlomo Gelaki, Dmitri Nikshych, and Victor Ostrik, *On braided fusion categories I*, available at [arXiv:0906.0620](https://arxiv.org/abs/0906.0620).
- [ENO2005] Pavel Etingof, Dmitri Nikshych, and Viktor Ostrik, *On fusion categories*, *Ann. of Math. (2)* **162** (2005), no. 2, 581–642, DOI 10.4007/annals.2005.162.581. MR2183279 (2006m:16051)
- [ENO2009] Pavel Etingof, Dmitri Nikshych, and Victor Ostrik, *Fusion categories and homotopy theory*, available at [arXiv:0909.3140](https://arxiv.org/abs/0909.3140).
- [FKLW2003] Michael H. Freedman, Alexei Kitaev, Michael J. Larsen, and Zhenghan Wang, *Topological quantum computation*, *Bull. Amer. Math. Soc. (N.S.)* **40** (2003), no. 1, 31–38 (electronic), DOI 10.1090/S0273-0979-02-00964-3. Mathematical challenges of the 21st century (Los Angeles, CA, 2000). MR1943131 (2003m:57065)
- [FHK1994] M. Fukuma, S. Hosono, and H. Kawai, *Lattice topological field theory in two dimensions*, *Comm. Math. Phys.* **161** (1994), no. 1, 157–175. MR1266073 (95b:81179)
- [FHLT2009] Daniel Freed, Michael Hopkins, Jacob Lurie, and Constantin Teleman, *Topological quantum field theories from compact Lie groups*, available at [arXiv:0905.0731](https://arxiv.org/abs/0905.0731).
- [FNWW2008] M. Freedman, C. Nayak, K. Walker, and Z. Wang, *On picture (2+1)-TQFTs*, available at [arXiv:0806.1926](https://arxiv.org/abs/0806.1926).
- [Gre2009] Justin Greenough, *Monoidal 2-structure of Bimodule Categories*, available at [arXiv:0911.4979](https://arxiv.org/abs/0911.4979).
- [KMR2009] Zoltan Kadar, Annalisa Marzuoli, and Mario Rasetti, *Microscopic description of 2d topological phases, duality and 3d state sums*, available at [arXiv:0907.3724](https://arxiv.org/abs/0907.3724).
- [Kir2010] Alexander Kirillov Jr, *On piecewise linear cell decompositions* (September 2010), available at [arXiv:1009.4227](https://arxiv.org/abs/1009.4227).
- [Kit2003] A. Yu. Kitaev, *Fault-tolerant quantum computation by anyons*, *Annals of Physics* **303** (2003), no. 1, 2–303.
- [KKR2010] Robert Koenig, Greg Kuperberg, and Ben W. Reichardt, *Quantum computation with Turaev-Viro codes*, available at [arXiv:1002.2816](https://arxiv.org/abs/1002.2816).
- [LW2005] Michael Levin and Xiao-Gang Wen, *String-net condensation: A physical mechanism for topological phases*, *Phys. Rev. B* **71** (2005), no. 4, DOI 10.1103/PhysRevB.71.045110.
- [Lur2009] Jacob Lurie, *On the classification of topological quantum field theories*, available at <http://www-math.mit.edu/~lurie/>.
- [MW2010] Scott Morrison and Kevin Walker, *The blob complex*, available at <http://canyon23.net/math/>.
- [Mug2003a] Michael Müger, *From subfactors to categories and topology. I. Frobenius algebras in and Morita equivalence of tensor categories*, *J. Pure Appl. Algebra* **180** (2003), no. 1-2, 81–157, DOI 10.1016/S0022-4049(02)00247-5. MR1966524 (2004f:18013)
- [Mug2003b] ———, *From subfactors to categories and topology. II. The quantum double of tensor categories and subfactors*, *J. Pure Appl. Algebra* **180** (2003), no. 1-2, 159–219, DOI 10.1016/S0022-4049(02)00248-7. MR1966525 (2004f:18014)
- [Oec2005] Robert Oeckl, *Discrete gauge theory*, Imperial College Press, London, 2005. From lattices to TQFT. MR2174961 (2006i:81142)
- [Ost2003] Victor Ostrik, *Module categories, weak Hopf algebras and modular invariants*, *Transform. Groups* **8** (2003), no. 2, 177–206, DOI 10.1007/s00031-003-0515-6. MR1976459 (2004h:18006)
- [Stir2010] Spencer D. Stirling, *Counterexamples in Levin-Wen string-net models, group categories, and Turaev unimodality*, available at [arXiv:1004.1737](https://arxiv.org/abs/1004.1737).
- [Tur1993] Vladimir Turaev, *Quantum invariants of links and 3-valent graphs in 3-manifolds*, *Inst. Hautes Études Sci. Publ. Math.* **77** (1993), 121–171. MR1249172 (94j:57012)

- [Tur1994] V. G. Turaev, *Quantum invariants of knots and 3-manifolds*, de Gruyter Studies in Mathematics, vol. 18, Walter de Gruyter & Co., Berlin, 1994. MR1292673 (95k:57014)
- [TV1992] V. G. Turaev and O. Ya. Viro, *State sum invariants of 3-manifolds and quantum 6j-symbols*, *Topology* **31** (1992), no. 4, 865–902, DOI 10.1016/0040-9383(92)90015-A. MR1191386 (94d:57044)
- [TV2010] Vladimir Turaev and Alexis Virelizier, *On two approaches to 3-dimensional TQFTs*, available at [arXiv:1006.3501](https://arxiv.org/abs/1006.3501).
- [Wal2010] Kevin Walker, *TQFTs [early incomplete draft], version 1h*, available at <http://canyon23.net/math/>.

DEPARTMENT OF MATHEMATICS, SUNY AT STONY BROOK, STONY BROOK, NY 11794, USA
E-mail address: kirillov@math.sunysb.edu
URL: <http://www.math.sunysb.edu/~kirillov/>