

---

# A short review of the theory of hard exclusive processes

Samuel Wallon

Received: date / Accepted: date

**Abstract** We first present an introduction to the theory of hard exclusive processes. We then illustrate this theory by a few selected examples. The last part is devoted to the most recent developments in the asymptotical energy limit.

**Keywords** QCD · phenomenology · exclusive processes · collinear factorization · generalized parton distributions · distribution amplitudes · high energy factorization · power corrections

## 1 Introduction

### 1.1 Hard processes in QCD

Quantum chromodynamics (QCD) is the theory of strong interaction, one of the four elementary interactions of the universe. It is a relativistic quantum field theory of Yang-Mills type, with the  $SU(3)$  gauge group. The quarks and gluons elementary fields are confined inside hadrons. Nevertheless, they can be expressed as superpositions of Fock states:

- mesons ( $\pi, \eta, f_0, \rho, \omega \dots$ ):  $|q\bar{q}\rangle + |q\bar{q}g\rangle + |qqq\bar{q}\rangle + \dots$
- baryons ( $p, n, N, \Delta \dots$ ):  $|qqq\rangle + |qqqg\rangle + |qqq\bar{q}\rangle + \dots$

In contrast with electrodynamics, strong interaction increases with distance, or equivalently decreases when energy increases. This phenomenon, called asymptotical freedom, means that the coupling satisfies  $\alpha_s(Q) \ll 1$  for  $Q \gg \Lambda_{QCD} \simeq 200$  MeV. The natural question which then arises is how to describe and understand the internal structure of hadrons, starting from their elementary constituents, despite the confinement. In the non-perturbative domain, the two available tools are:

- Chiral perturbation theory: systematic expansion based on the fact that  $u$  and  $d$  quarks have a very small mass, the  $\pi$  mass being an expansion parameter outside the chiral limit (in which these mass would be set to zero).

---

Presented at the workshop "30 years of strong interactions", Spa, Belgium, 6-8 April 2011.

S. Wallon  
Université Pierre et Marie Curie & Laboratoire de Physique Théorique CNRS / Université Paris Sud Orsay  
E-mail: wallon@th.u-psud.fr

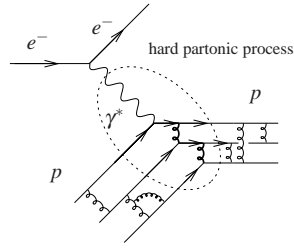

**Fig. 1** The partonic description of the electromagnetic proton form-factor. The partonic process at lowest order, calculable based on perturbation theory, is surrounded by a dashed line.

- Discretization of QCD on a 4-d lattice, leading to numerical simulations.

Other analytical tools have been proposed recently, among which is the AdS/QCD correspondence, a phenomenological extension of the AdS/CFT correspondence.

Besides these tools, one may wonder whether it is possible to extract informations reducing the process to interactions involving a small number of *partons* (quarks, gluons), despite confinement. This is possible if the considered process is driven by short distance phenomena, with typical distances between the interacting partons much less than 1 fm, i.e. for  $\alpha_s \ll 1$ . This is the underlying principle of perturbative methods. In practice, this may be of practical use when hitting strongly enough a hadron. This can be illustrated by the elastic scattering of an electron on a proton, introducing the proton form factor, as shown in Fig.1. This description is based on following hierarchy of time scales

$$\tau_{\text{electromagnetic interaction}} \sim \tau_{\text{parton life time after interaction}} \ll \tau_{\text{strong interaction}}$$

which is valid when both the virtuality  $Q^2$  of the exchanged virtual photon ( $\gamma^*$ ) and the square of the center-of-mass energy of the  $\gamma^*p$  pair are large with respect to  $\Lambda_{QCD}^2$ .

More generally, perturbative methods can be applied to any process governed by a hard scale, called generically *hard processes*. This can be the virtuality of the electromagnetic probe:

- in elastic scattering  $e^\pm p \rightarrow e^\pm p$
- in deep inelastic scattering (DIS)  $e^\pm p \rightarrow e^\pm X$
- in deep virtual Compton scattering (DVCS)  $e^\pm p \rightarrow e^\pm p \gamma$ .

This also applies to  $e^+e^- \rightarrow X$  annihilation where the hard scale is provided by the total center of mass energy. In meson photoproduction  $\gamma p \rightarrow Mp$  a large  $t$ -channel momentum exchange can justify the application of perturbation theory. Finally, the hard scale can be given by the mass of a heavy bound state, e.g.  $\gamma p \rightarrow J/\Psi p$ .

A precise treatment relies on factorization theorems. The scattering amplitude is described by the convolution of the partonic amplitude with the non-perturbative hadronic content, as illustrated in Fig.2.

## 1.2 From inclusive to exclusive processes

Historically, the partonic proton content was first studied in DIS. In this inclusive process, the measurement of the two external kinematical variables  $Q^2$  and  $s_{\gamma^*p}$  give a direct access

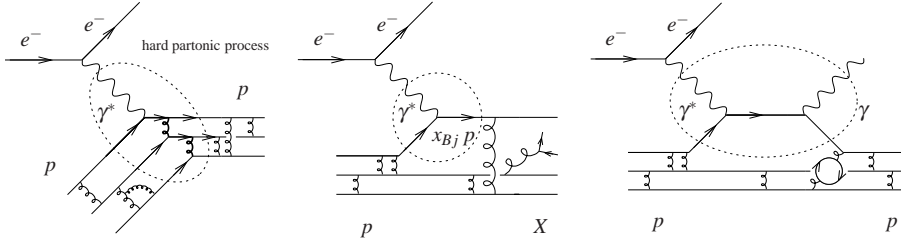

**Fig. 2** Factorization of various hard processes. Left: Elastic  $e^- p \rightarrow e^- p$ . Center: Deep inelastic scattering  $e^- p \rightarrow e^- X$ . Right: Deep virtual Compton scattering  $e^- p \rightarrow e^- p \gamma$ . In each case, the partonic process at lowest order is surrounded by a dashed line.

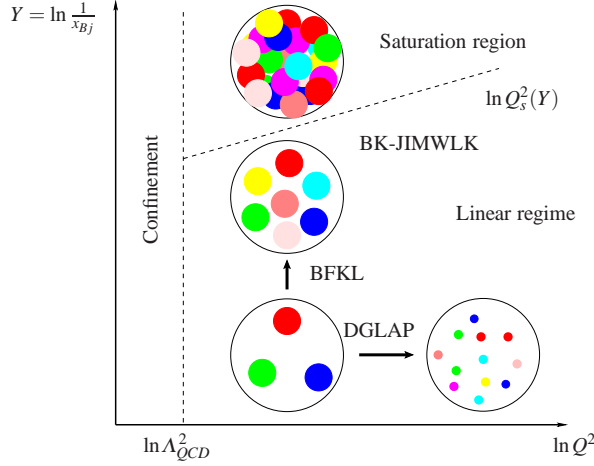

**Fig. 3** The various regimes governing the partonic content of the proton in the  $(\ln Q^2, Y)$  plane.

to the kinematics of the partonic process, through

$$s_{\gamma^* p} = (q_{\gamma^*} + p_p)^2 = 4E_{\text{c.m.}}^2, \quad Q^2 \equiv -q_{\gamma^*}^2 > 0, \quad x_{Bj} = \frac{Q^2}{2p_p \cdot q_{\gamma^*}} \simeq \frac{Q^2}{s_{\gamma^* p} + Q^2} \quad (1)$$

as illustrated in Fig.2 (Center). Indeed, the two parameters  $x_{Bj}$  and  $Q^2$  have a direct interpretation in the Feynman-Bjorken mechanism:  $x_B$  is the proton momentum fraction carried by the scattered quark while  $1/Q \ll 1/\Lambda_{QCD}$  is the transverse resolution of the photonic probe. There are several regimes governing the evolution of perturbative content of the proton in terms of  $x_{Bj}$  and  $Q^2$ , as illustrated in Fig.3. The first domain, corresponding to the “usual” regime, with  $s_{\gamma^* p} \sim Q^2$ , for which  $x_{Bj}$  is moderate ( $x_{Bj} \gtrsim .01$ ), is described by an evolution in  $Q$  governed by the QCD renormalization group. This is the so-called Dokshitzer, Gribov, Lipatov, Altarelli, Parisi (DGLAP) equation [1,2,3], which sums up terms of type

$$\sum_n (\alpha_s \ln Q^2)^n + \alpha_s \sum_n (\alpha_s \ln Q^2)^n + \dots \quad \begin{array}{c} \text{LLQ} \\ \text{NLLQ} \end{array} \quad (2)$$

Note that this perturbative approach is based on collinear factorization, which we shall discuss further in Secs.1.3 and 1.4.

Besides this domain, in the perturbative Regge limit, for which  $s_{\gamma^* p} \rightarrow \infty$  i.e.  $x_{Bj} \sim Q^2/s_{\gamma^* p} \rightarrow 0$ , another evolution is expected to deal with the stacking of partons. This leads to the Balitskii, Fadin, Kuraev, Lipatov (BFKL) equation [4, 5, 6, 7], a resummation which looks symbolically like

$$\sum_n (\alpha_s \ln 1/x_{Bj})^n + \alpha_s \sum_n (\alpha_s \ln 1/x_{Bj})^n + \dots .$$

LLx                      NLLx                      (3)

This perturbative approach is based on the  $k_T$  factorization, which we shall discuss further in Secs. 3.2. At very small values of  $x_{Bj}$ , the density of partons cannot grow for ever, and some kind of saturation phenomena should tame this growth. Its simplest version is described by the Balitski-Kovchegov (BK) equation [8, 9, 10, 11, 12, 13], which realizes this saturation through “fan diagrams” developing from the probe toward the nucleon target, these diagrams being made of  $\mathbb{P}$ omeron exchanges recombining through triple  $\mathbb{P}$ omeron vertices [14, 15, 16, 17], a common building block of various approaches [18, 19, 20, 21]. Further extensions of these models are known under the acronym JIMWLK [22, 23, 24, 25, 26, 27, 28, 29, 30].

Besides these rather inclusive studies, a very important effort is being realized in order to get access to the hadron structure through exclusive processes. Going from inclusive to exclusive processes is difficult, since exclusive processes are rare! This requires high luminosity accelerators and high-performance detection facilities. Such studies have been carried on in recent or actual experiments such as HERA (H1, ZEUS), HERMES, JLab@6 GeV (Hall A, CLAS), BaBar, Belle, BEPC-II (BES-III). In the near future, several experiments, either already built or planned, will offer various possibilities for precise experimental studies: LHC, COMPASS-II, JLab@12 GeV, Super-B, EIC, ILC. Let us briefly summarize, in a non exhaustive way, the various studies which may be carried in these experimental facilities:

- Proton form factor at JLab@6 GeV and in the future at PANDA (timelike proton form factor through  $p\bar{p} \rightarrow e^+e^-$ )
- $\gamma^*\gamma$  single-tagged channel at  $e^+e^-$  colliders ( BaBar, Belle, BES,...): Transition form factor  $\gamma^*\gamma \rightarrow \pi$ , generalized distribution amplitudes (GDAs) in  $\gamma^*\gamma \rightarrow \pi\pi$ , exotic hybrid meson production
- DVCS and generalized parton distributions (GPDs) at HERA (H1, ZEUS), HERMES, JLab@6 GeV and in the future at JLab@12 GeV, COMPASS-II, EIC, and time-like Compton scattering at JLab@12 GeV and in ultraperipheral collisions at RHIC and LHC
- Non exotic and exotic hybrid meson electroproduction: GPDs and distribution amplitudes (DAs), etc... at NMC (CERN), E665 (Fermilab), HERA (H1, ZEUS), COMPASS, HERMES, JLab
- Transition distribution amplitudes (TDA) (PANDA at GSI)
- Transverse momentum distributions (TMDs) ( BaBar, Belle, COMPASS, ...)
- Diffractive processes, including ultraperipheral collisions at LHC (with or without fix target), ILC

Very important theoretical developments have been carried during the last decade. The key words are DAs, GPDs, GDAs, TDAs ... TMDs, to be explained further on. Two fundamental tool will be presented. The first one, devoted to medium energy experiments, therefore applicable at JLab, HERMES, COMPASS, BaBar, Belle, PANDA, Super-B, is the *collinear factorization*. The second one, which is specific to asymptotical energies, applies to high-energy collider experiments, like HERA, Tevatron, LHC, ILC (EIC and COMPASS at the boundary), and is called  *$k_T$ -factorization*.

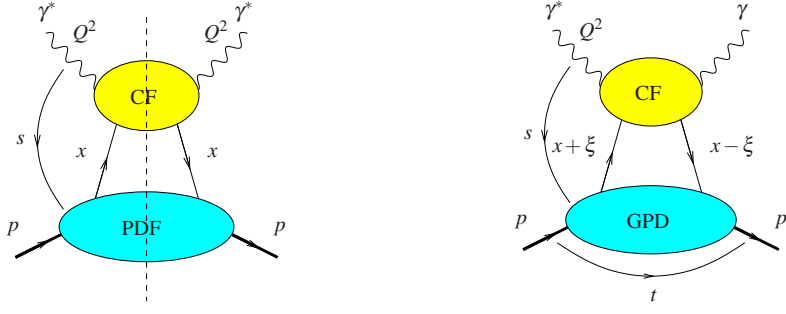

Fig. 4 Factorization of DIS (left) and DVCS (right) amplitudes.

### 1.3 Extensions from DIS

Factorizing the leptonic tensor, DIS  $e^\pm p \rightarrow e^\pm X$  deals with the inclusive subprocess  $\gamma^* p \rightarrow X$ . Through optical theorem, the total cross-section of this subprocess is related to the imaginary part of the forward Compton amplitude  $\gamma^* p \rightarrow \gamma^* p$ . This amplitude can be expanded on the basis of transverse and longitudinal polarization tensors, defining the transverse and longitudinal structure functions. In the limit of a hard virtual photon, this later amplitude factorizes into a hard part and a soft part, as illustrated in the left panel of Fig. 4. This is a mathematical convolution (for the longitudinal momentum fraction  $x$ ) between coefficient functions (CFs) and parton distribution functions (PDFs), symbolically written as

$$\text{Im.} \mathcal{M}_{\gamma^* p \rightarrow \gamma^* p} = CF \otimes PDF \quad (4)$$

We now consider the virtual Compton scattering (VCS) process

$$\gamma^*(q) p(p) \rightarrow \gamma^*(q') p(p'), \quad (5)$$

which opened the way to the introduction of non-forward parton distributions, now called GPDs<sup>1</sup>. This is a subprocess of the exclusive process

$$e^\pm N \rightarrow e^\pm N \gamma. \quad (6)$$

The skewness  $\xi$ , which characterizes the relative amount of longitudinal momentum transferred to the nucleon, is defined in a covariant manner by

$$\xi = -\frac{(q - q') \cdot (q + q')}{(p + p') \cdot (q + q')}. \quad (7)$$

From Eq. (7) one deduces, in the special case of DVCS where the produced photon is real, that

$$\xi = \frac{x_{Bj}}{2 - x_{Bj}}, \quad (8)$$

which relates the skewness to the usual  $x_{Bj}$  parameter. This shows in particular that at small- $x_{Bj}$ , typically at HERA collider (H1, ZEUS), skewness effects are rather small, and were in

<sup>1</sup> For early reviews on GPDs, see Refs. [31,32]). See Refs. [33,34] for more recent reviews. Up-to-date reviews on models and data can be found in Refs. [35,36,37].

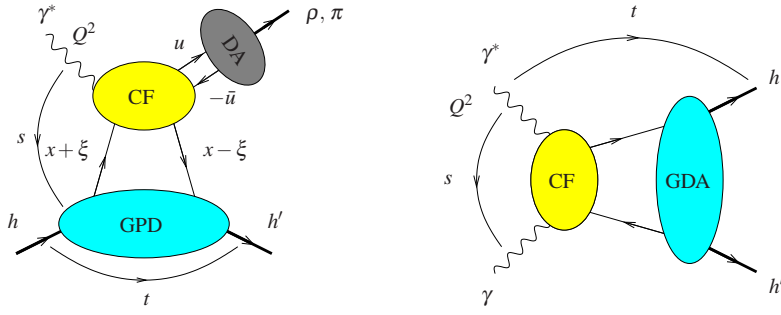

**Fig. 5** Factorization of the meson electroproduction scattering amplitude (left) and of the  $\gamma^* - \gamma$  annihilation amplitude (right).

particular overcome in the seminal paper [38] on diffractive electroproduction, which was devoted to HERA kinematics.

The amplitude of the process (6) is the sum of the DVCS contribution and of the Bethe-Heitler (BH) one (where the  $\gamma$  is directly emitted by the  $e^\pm$ ). The BH process can be computed in QED, based on the measurement of proton elastic form factors. On the other hand, the DVCS amplitude involves GPDs, which are thus in principle accessible. The squared amplitude of the process (6) reads

$$|A|^2 = |A_{BH}|^2 + |A_{DVCS}|^2 + \underbrace{A_{DVCS}A_{BH}^* + A_{DVCS}^*A_{BH}}_I. \quad (9)$$

In practice, one can extract GPDs directly from the process (6) when the BH amplitude is negligible, which turns out to be the case at small  $x_{Bj}$ , a typical situation for H1 and HERA. In the more general situation when  $x_{Bj}$  is not small, the extraction of GPDs is made easier through the study of the interference  $I$  between the DVCS and the BH amplitudes. This can be done based on two generic methods: either by studying beam-charge asymmetries or by using beam polarization asymmetries.

The DVCS amplitude factorizes in the kinematical region  $Q^2 \gg \Lambda_{QCD}$  and  $s \gg -t$  [39, 40, 41, 42]: it is a convolution between CFs and GPDs

$$\mathcal{M}_{\gamma^* p \rightarrow \gamma p} = CF \otimes GPD, \quad (10)$$

as illustrated at twist-2 level in the right panel of Fig. 4. A time-like version of DVCS, with an incoming on-shell photon and an outgoing time-like photon, factorizes and is expected to give access to the same GPDs [43, 44].

Replacing the produced photon by a meson  $M$ , whose partonic content is described by a DA, meson electroproduction again factorizes like [45, 40]

$$\mathcal{M}_{\gamma^* p \rightarrow Mp} = GPD \otimes CF \otimes DA, \quad (11)$$

as illustrated in the left panel of Fig. 5. As shown in Ref. [39] by considering the light-cone limit of non-local twist 2 operators, and then investigated in [46, 47], the cross-process of DVCS has a factorized form in the kinematical region  $Q^2 \gg \Lambda_{QCD}^2$  and  $s \ll -t$

$$\mathcal{M}_{\gamma^* \gamma \rightarrow \text{hadron hadron}} = CF \otimes GDA, \quad (12)$$

where the GDAs describes the partonic content of a hadron pair. This is illustrated in the right panel of Fig. 5.

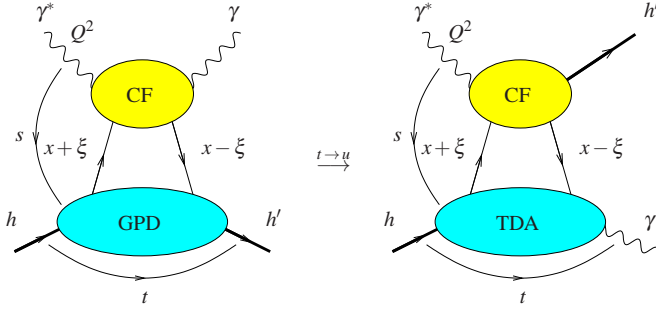

**Fig. 6** Factorized amplitude for DVCS (left) and for the crossed process backward DVCS in the conventional kinematics

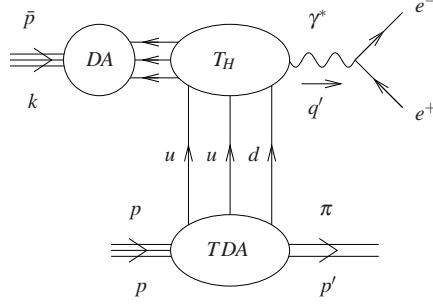

**Fig. 7** Factorization of the forward  $\bar{p}p \rightarrow \gamma^* \pi$  process.

DVCS is an extension from DIS by allowing the kinematics to be non-diagonal. Starting from usual DVCS, further extensions are obtained by allowing the initial and final hadrons to differ. When being in the same octuplet, this leads to introduce transition GPDs. An even less diagonal quantity is naturally introduced when the baryonic numbers of the initial and final hadron differ, by  $t \leftrightarrow u$  crossing from DVCS, leading to the introduction [48,49] of the TDA of the hadron to a photon, as shown in Fig. 6. This can be further extended by replacing the outgoing  $\gamma$  by any hadronic state. As an example, the  $p \rightarrow \pi$  TDA could be studied at PANDA, in the forward  $\bar{p}p \rightarrow \gamma^* \pi$  scattering [50], as shown in Fig. 7.

#### 1.4 Factorization

Factorization relies on two steps: the first one is based on momentum factorization, based on the light-cone dominance in the  $Q^2 \rightarrow \infty$  limit. The natural frame to set up this factorization is the Sudakov decomposition, introducing two light-cone directions  $p_1$  and  $p_2$

$$p_1 = \frac{\sqrt{s}}{2}(1, 0_{\perp}, 1), \quad p_2 = \frac{\sqrt{s}}{2}(1, 0_{\perp}, -1) \quad (13)$$

with  $2p_1 \cdot p_2 = s \sim s_{\gamma^* p}$ . Any four-vector is then expanded according to

$$k = \alpha p_1 + \beta p_2 + k_{\perp}. \quad (14)$$

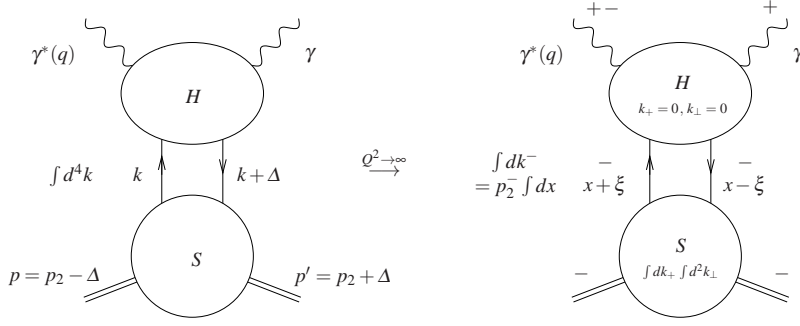
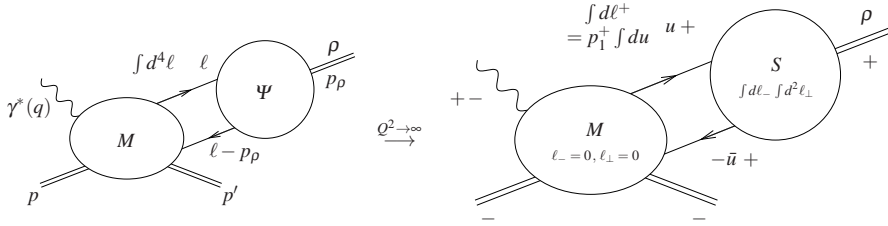

**Fig. 8** Factorization of DVCS in momentum space at large  $Q^2$ .

At large  $Q^2$ , considering the momentum  $k$  of the parton connecting the hard part  $H$  with the soft part  $S$ , the hard part only depends on the component of  $k$  along the incident hadron (denoted as the  $-$  component). In this approximation, the amplitude is then the convolution with respect to the  $-$  fraction of the hard and soft part, as illustrated in Fig. 8, and reads symbolically

$$\int d^4 k S(k, k+\Delta) H(q, k, k+\Delta) = \int dk^- \int dk^+ d^2 k_\perp S(k, k+\Delta) H(q, k^-, k^- + \Delta^-) \quad (15)$$

The second step is to perform the factorization with respect to quantum numbers, in accordance to  $C$ ,  $P$  and  $T$  parity which select the allowed structures when performing Fierz decomposition in  $t$  channel (among the 16 Dirac matrices in the case of quark exchange).



**Fig. 9** Collinear factorization of  $\rho$ -electroproduction.

The case of  $\rho$ -meson production involves a second collinear factorization. Indeed the  $\rho$ -meson is described by its wave function  $\Psi$  which reduces for hard processes to its DA [51, 52, 53, 54, 55], originally introduced in the case of form factors, as (denoting  $l^+ = u p_2$ )

$$\Phi(u, \mu_F^2) = \int d\ell^- \int^{|\ell_\perp| < \mu_F^2} d^2 \ell_\perp \Psi(\ell, \ell - p_\rho) \quad (16)$$

where  $\mu_F$  is the factorization scale. For large  $Q^2$ , factorization symbolically reads

$$\begin{aligned} \int d^4 \ell M(q, \ell, \ell - p_\rho) \Psi(\ell, \ell - p_\rho) &= \int d\ell^+ M(q; \ell^+, \ell^+ - p_\rho^+) \int d\ell^- \int^{|\ell_\perp| < \mu_F^2} d^2 \ell_\perp \Psi(\ell, \ell - p_\rho) \\ &= p_\rho^+ \int du M(q; u p_\rho^+, -\bar{u} p_\rho^+; \mu_F) \Phi(u, \mu_F). \end{aligned} \quad (17)$$



as illustrated in Fig. 9. The arbitrariness of the amplitude with respect to  $\mu_F$  leads to the Efremov, Radyushkin, Brodsky, Lepage (ERBL) equations for the DAs [56,57,58].

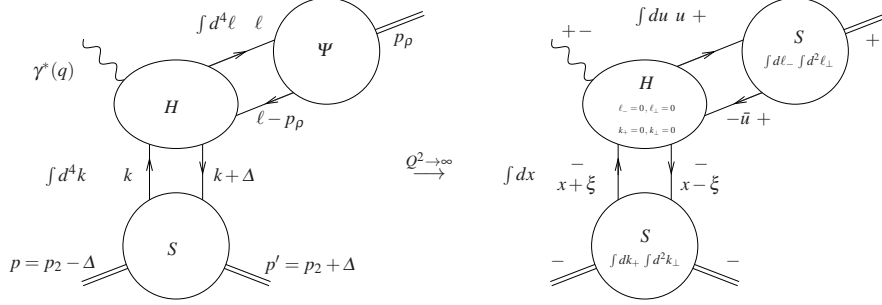

**Fig. 10** Momentum space factorization of  $\rho$ -electroproduction.

The scattering amplitude for meson electroproduction has the fully factorized form, shown in the left panel of Fig. 10,

$$\int d^4k d^4\ell S(k, k+\Delta)H(q; k, k+\Delta)\Psi(\ell, \ell-p_\rho) = p^- p_\rho^+ \int dx du \quad (18)$$

$$\times \left[ \int_{|k_\perp^2| < \mu_F^2} dk^+ \int d^2k_\perp S(k, k+\Delta) \right] H(q; (x+\xi)p^-, (x-\xi)p^-; u p_\rho^+, -\bar{u} p_\rho^+; \mu_{F_1}; \mu_{F_2}) \Phi(u, \mu_{F_1}).$$

After completing momentum and quantum number factorization, we have thus been led to

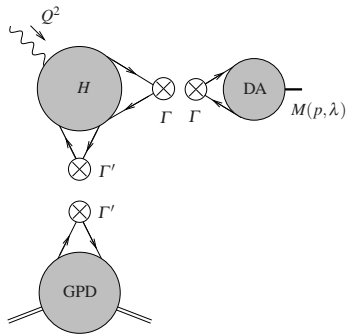

**Fig. 11** Factorization of  $\rho$ -electroproduction including quantum numbers. Crosses symbolize  $\Gamma$  matrices.

introduce three building blocks entering Fig. 11. These are

$$\begin{aligned}
 & \text{Diagram } H \text{ (circle with } Q^2 \text{ and } \Gamma, \Gamma' \text{)} = \text{Diagram } \Gamma + \text{Diagram } \Gamma' \text{ (hand-bag diagrams)} \\
 & \text{Diagram } DA \text{ (circle with } M(p, \lambda) \text{ and } \Gamma \text{)} = \langle M(p, \lambda) | \mathcal{O}(\Psi, \bar{\Psi}, A) | 0 \rangle \text{ matrix element of a non-local light-cone operator} \\
 & \text{Diagram } GPD \text{ (circle with } N(p), N(p') \text{ and } \Gamma' \text{)} = \langle N(p') | \mathcal{O}'(\Psi, \bar{\Psi}, A) | N(p) \rangle \text{ matrix element of a non-local light-cone operator}
 \end{aligned}$$

### 1.5 GPDs at twist 2

The GPDs have a simple physical interpretation at twist 2, illustrated in Fig. 12, based on density number operators [59, 60, 61]. As for DAs, the arbitrariness in the choice of  $\mu_{F_2}$  leads to evolution equations for GPDs, called ERBL-DGLAP equations [62, 63, 64, 39], which are extensions of the ERBL [56, 57, 58] and DGLAP [1, 2, 3] evolution equations.

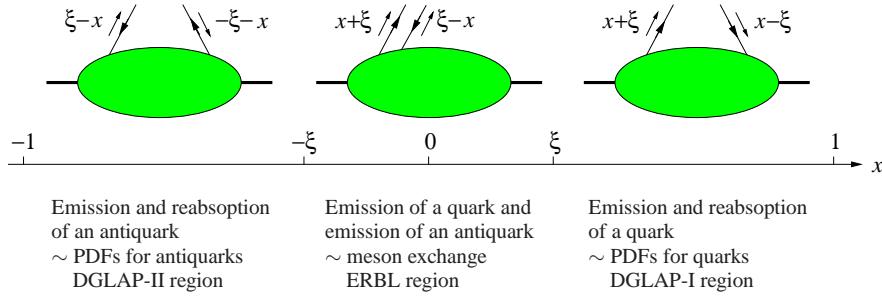

**Fig. 12** The partonic interpretation of GPDs (Fig. from Ref.[33]).

For quarks, one should distinguish two kinds of GPDs. The exchanges without helicity flip involve chiral-even  $\Gamma'$  matrices, and define 4 chiral-even GPDs:  $H^q$  (reducing to the PDF  $q$  in the limit  $\xi = 0$ ,  $t = 0$ ),  $E^q$ ,  $\tilde{H}^q$  (which is the polarized PDF  $\Delta q$  in the limit  $\xi = 0$ ,

$t = 0$ ) and  $\tilde{E}^q$ , defined by

$$\begin{aligned}
F^q &= \frac{1}{2} \int \frac{dz^+}{2\pi} e^{ixP^-z^+} \langle p' | \bar{q}(-\frac{1}{2}z) \gamma^- q(\frac{1}{2}z) | p \rangle \Big|_{z^-=0, z_\perp=0} \\
&= \frac{1}{2P^-} \left[ H^q(x, \xi, t) \bar{u}(p') \gamma^- u(p) + E^q(x, \xi, t) \bar{u}(p') \frac{i\sigma^{-\alpha} \Delta_\alpha}{2m} u(p) \right], \\
\tilde{F}^q &= \frac{1}{2} \int \frac{dz^+}{2\pi} e^{ixP^-z^+} \langle p' | \bar{q}(-\frac{1}{2}z) \gamma^- \gamma_5 q(\frac{1}{2}z) | p \rangle \Big|_{z^-=0, z_\perp=0} \\
&= \frac{1}{2P^-} \left[ \tilde{H}^q(x, \xi, t) \bar{u}(p') \gamma^- \gamma_5 u(p) + \tilde{E}^q(x, \xi, t) \bar{u}(p') \frac{\gamma_5 \Delta^-}{2m} u(p) \right]. \quad (19)
\end{aligned}$$

The exchanges with helicity flip involve chiral-odd  $\Gamma'$  matrices, leading to the 4 chiral-odd GPDs  $H_T^q$  (the quark transversity PDFs  $\Delta_T q$  when  $\xi = 0, t = 0$ ),  $E_T^q, \tilde{H}_T^q, \tilde{E}_T^q$ , defined by

$$\begin{aligned}
&\frac{1}{2} \int \frac{dz^+}{2\pi} e^{ixP^-z^+} \langle p' | \bar{q}(-\frac{1}{2}z) i\sigma^{-i} q(\frac{1}{2}z) | p \rangle \Big|_{z^-=0, z_\perp=0} \quad (20) \\
&= \frac{1}{2P^-} \bar{u}(p') \left[ H_T^q i\sigma^{-i} + \tilde{H}_T^q \frac{P^- \Delta^i - \Delta^- P^i}{m^2} + E_T^q \frac{\gamma^- \Delta^i - \Delta^- \gamma^i}{2m} + \tilde{E}_T^q \frac{\gamma^- P^i - P^- \gamma^i}{m} \right] u(p).
\end{aligned}$$

Analogously, there are 4 gluonic GPDs without helicity flip:  $H^g$  (it is the PDF  $xg$  in the limit  $\xi = 0, t = 0$ ),  $E^g, \tilde{H}^g$  (it is the polarized PDF  $x\Delta g$  when  $\xi = 0, t = 0$ ) and  $\tilde{E}^g$ ; and 4 gluonic GPDs with helicity flip:  $H_T^g, E_T^g, \tilde{H}_T^g$  and  $\tilde{E}_T^g$  (there is no forward limit reducing to gluons PDFs here: a change of 2 units of helicity cannot be compensated by a spin 1/2 target).

## 1.6 Selection rules and factorization status

The selection rule for the meson electroproduction can be obtained in a simple manner. Since for a massless particle chirality = + (resp. -) helicity for a (anti)particle and based on the fact that QED and QCD vertices are chiral even (no chirality flip during the interaction), one deduces<sup>2</sup> that the total helicity of a  $q\bar{q}$  pair produced by a  $\gamma^*$  should be 0. Therefore, the helicity of the  $\gamma^*$  equals the  $z$  projection of the  $q\bar{q}$  angular momentum  $L_z^{q\bar{q}}$ . In the pure collinear limit (i.e. twist 2), the  $q\bar{q}$  does not carry any angular momentum:  $L_z^{q\bar{q}} = 0$ . Thus the  $\gamma^*$  is longitudinally polarized. Additionally, at  $t = 0$  there is no source of orbital momentum from the proton coupling, which implies that the helicity of the meson and of the photon should be identical. In the collinear factorization approach, the extension to  $t \neq 0$  changes nothing from the hard part side, the only dependence with respect to  $t$  being encoded in the non-perturbative correlator which defines the GPDs. This implies that the above selection rule remains true. Thus, only 2 transitions are possible (this is the so-called  $s$ -channel helicity conservation (SCHC)):  $\gamma_L^* \rightarrow \rho_L$ , for which QCD factorization holds at  $t=2$  at any order (i.e. LL, NLL, etc...) [45] and  $\gamma_T^* \rightarrow \rho_T$ , corresponding to twist  $t = 3$  at the amplitude level, for which QCD factorization is not proven. In fact an explicit computation of the  $\rho_T$  electroproduction [65] at leading order shows that the hard part has *end-point singularities* like

$$\int_0^1 \frac{du}{u} \quad \text{and} \quad \int_0^1 \frac{du}{1-u} \quad (21)$$

occurring when the momentum fraction carried by the quark or the anti-quark vanishes.

<sup>2</sup> This is the same reason which explains the vanishing of  $F_L$  in DIS.

### 1.7 Some solutions to factorization breaking?

In order to extend the factorization theorem at higher twist, as well as to improve the phenomenological description of hard exclusive processes at moderate values of the hard scale, several solutions have been proposed. One may add contributions of 3-parton DAs [66, 67] for  $\rho_T$  [68, 69] (of dominant twist equal 3 for  $\rho_T$ ). This in fact does not solve the problem, while reducing the level of divergency, but is needed for consistency.

On top of the potential end-point singularities discussed above, phenomenologically the use of simple asymptotical DAs lead usually to a too small ERBL contribution in hard exclusive processes, a situation which is not improved by NLO corrections. It was suggested by Chernyak and Zhitnitsky [70] to use DAs which would be mostly concentrated close to the end point, and not identical to the asymptotical DA, a solution which indeed improve very much the description of the data, for example of the pion form factor. However, since close to the end-point one may face theoretical inconsistencies when justifying the factorization, Li and Serman [71] then introduced an improved collinear approximation (ICA). They suggested to keep a transverse  $\ell_\perp$  dependency in the  $q, \bar{q}$  momenta. Soft and collinear gluon exchange between the valence quarks are responsible for large double-logarithmic effects which exponentiate. The corresponding study is made easier when using the impact parameter space  $b_\perp$  conjugated to  $\ell_\perp$ , leading to the Sudakov factor

$$\exp[-S(u, b, Q)], \quad (22)$$

a factor already involved in previous studies of elastic hadron-hadron scattering at fixed angle [72].  $S$  diverges when  $b_\perp \sim O(1/\Lambda_{QCD})$  (large transverse separation, i.e. small transverse momenta) or small fraction  $u \sim O(\Lambda_{QCD}/Q)$ . This thus regularizes potential end-point singularities, even when using non asymptotical DAs. See Ref. [73] for a detailed and pedagogical discussion in the case of the  $\gamma\gamma^* \rightarrow \pi^0$  form factors. These Sudakov effects have been implemented outside of pure QCD processes, in particular for the study of semi-leptonic  $B \rightarrow \pi$  decay [74]. In this ICA, a dependency of the hard part with respect to the partons transverse momenta is kept. This suggested Jakob and Kroll to keep such a dependency also inside the wave function of the produced meson. This was implemented in the form of an ad-hoc non-perturbative gaussian ansatz [75]

$$\exp[-a^2 |k_\perp^2|/(u\bar{u})], \quad (23)$$

and other similar ansätze, which give back the usual asymptotic DA  $6u\bar{u}$  when integrating over  $k_\perp$ . These gaussian ansätze combined with the perturbative Sudakov resummation tail effect were then implemented for various phenomenological studies like the pion form factor [75], the meson-photon form factor [76, 77]. The phenomenological description of the pion form factor is then improved, but is still below the data, even with the Chernyak and Zhitnitsky model. For other observables for which one really faces an end-point singularity, like the above example of  $\rho_T$ -electroproduction, the same approach seems to allow for a consistent treatment, and at least to interesting models [78, 79, 80, 81] which can describe the meson electroproduction data, in particular the HERA data at small- $x_{Bj}$ . We will in Sec. 3.3 that at small  $x_{Bj}$ , relying on the  $k_T$ -factorization, the off-mass-shellness of the  $t$ -channel gluons can serve as a regulator, preventing from facing end-point singularities.

## 2 A few applications

### 2.1 Electroproduction of an exotic hybrid meson

Using  $\mathbf{J} = \mathbf{L} + \mathbf{S}$  and neglecting any spin-orbital interaction,  $S, L$  can be considered as additional quantum numbers to classify hadron states, with

$$\mathbf{J}^2 = J(J+1), \quad \mathbf{S}^2 = S(S+1), \quad \mathbf{L}^2 = L(L+1), \quad (24)$$

and  $J = |L - S|, \dots, L + S$ . In the usual quark-model, meson are  $q\bar{q}$  bound states with charge parity  $C$  and space parity  $P$  satisfying

$$C = (-)^{L+S} \quad \text{and} \quad P = (-)^{L+1}. \quad (25)$$

Thus the allowed quantum numbers are

$$\begin{aligned} S = 0, L = J, J = 0, 1, 2, \dots : J^{PC} &= 0^{-+}(\pi, \eta), 1^{+-}(h_1, b_1), 2^{-+}, 3^{+-}, \dots \\ S = 1, L = 0, J = 1 : J^{PC} &= 1^{--}(\rho, \omega, \phi) \\ L = 1, J = 0, 1, 2 : J^{PC} &= 0^{++}(f_0, a_0), 1^{++}(f_1, a_1), 2^{++}(f_2, a_2) \\ L = 2, J = 1, 2, 3 : J^{PC} &= 1^{--}, 2^{--}, 3^{--} \\ &\dots \end{aligned} \quad (26)$$

which show that the exotic mesons with  $J^{PC} = 0^{--}, 0^{+-}, 1^{-+}, \dots$  are forbidden.

We restrict ourselves to the light  $1^{-+}$  exotic meson, denoted as  $H$ . There are several experimental candidates for  $H$ : the  $\pi_1(1400)$ , seen at GAMS [82], E852 [83], Crystal Barrel [84,85], VES [86], the  $\pi_1(1600)$ , seen at E852 [87,88,89,90,91], Crystal Barrel [92], VES [93,94,86,95], most recently confirmed by COMPASS [96], and the  $\pi_1(2000)$  [90,91].

Based on the fact that an extra degree of freedom is required to describe these exotic quantum numbers [97,98], one possibility is to consider a tower of Fock states starting with  $|q\bar{q}g\rangle$  ( $|q\bar{q}q\bar{q}\rangle$  states may also be considered). The natural question is then to study the feasibility of producing exotic meson in hard exclusive processes. Based on the fact that such a Fock state is expected to be a higher twist component (of twist 3 when thinking of the genuine twist 3 content of the usual  $\rho$ -meson), a strong  $1/Q$  suppression was expected in hard electroproduction of  $\pi_1$  with respect to  $\rho$ . It was shown in Refs. [99,100] that no suppression should be expected. This is based on the fact that the gluonic field operator does not need to appear explicitly in the local interpolating operator  $\mathcal{O}(\Psi, \bar{\Psi}, A)$  creating the  $|q\bar{q}g\rangle$  state. Indeed, while the twist of such a typical operator  $\bar{\Psi}\gamma^\mu G_{\mu\nu}\Psi$  is 4, leading to a  $1/Q^2$  suppression, collinear approach describes hard exclusive processes in terms of non-local light-cone operators, among which are the twist 2 operator

$$\bar{\psi}(-z/2)\gamma_\mu[-z/2; z/2]\psi(z/2) \quad (27)$$

where  $[-z/2; z/2]$  is a Wilson line, necessary to fulfill gauge invariance (i.e. a "color tube" between  $q$  and  $\bar{q}$ ) which thus hides gluonic degrees of freedom: at twist 2 the needed gluon is there.

The  $H$  DA is defined as (for longitudinal polarization)

$$\langle H(p, 0) | \bar{\psi}(-z/2)\gamma_\mu[-z/2; z/2]\psi(z/2) | 0 \rangle \Big|_{\substack{z^2=0 \\ z^+=0 \\ z_\perp=0}} = i f_H M_H e_\mu^{(0)} \int_0^1 dy e^{i(\bar{y}-y)p \cdot z/2} \phi_L^H(y). \quad (28)$$

Inserting the  $C$ -parity operator gives an antisymmetric DA for  $H^0$ ,  $\phi_L^H(y) = -\phi_L^H(1-y)$ , while the usual  $\rho$  DA is symmetric. The identification of quantum numbers can be performed when expanding the operator in the l.h.s of Eq. (28) in terms of local operators

$$\begin{aligned} & \langle H(p, \lambda) | \bar{\psi}(-z/2) \gamma_\mu [-z/2; z/2] \psi(z/2) | 0 \rangle \\ &= \sum_n \frac{1}{n!} z_{\mu_1} \dots z_{\mu_n} \langle H(p, \lambda) | \bar{\psi}(0) \gamma_\mu \overleftrightarrow{D}_{\mu_1} \dots \overleftrightarrow{D}_{\mu_n} \psi(0) | 0 \rangle, \end{aligned}$$

where  $D_\mu$  is the usual covariant derivative and  $\overleftrightarrow{D}_\mu = \frac{1}{2}(\overrightarrow{D}_\mu - \overleftarrow{D}_\mu)$ . The hybrid selects the odd-terms

$$\begin{aligned} & \langle H(p, \lambda) | \bar{\psi}(-z/2) \gamma_\mu [-z/2; z/2] \psi(z/2) | 0 \rangle = \\ & \sum_{n \text{ odd}} \frac{1}{n!} z_{\mu_1} \dots z_{\mu_n} \langle H(p, \lambda) | \bar{\psi}(0) \gamma_\mu \overleftrightarrow{D}_{\mu_1} \dots \overleftrightarrow{D}_{\mu_n} \psi(0) | 0 \rangle, \end{aligned}$$

while the usual  $\rho$ -meson would select the even terms. The special case  $n = 1$  is just

$$\mathcal{R}_{\mu\nu} = S_{(\mu\nu)} \bar{\psi}(0) \gamma_\mu \overleftrightarrow{D}_\nu \psi(0), \quad (29)$$

with  $S_{(\mu\nu)}$  the symmetrization operator  $S_{(\mu\nu)} T_{\mu\nu} = \frac{1}{2}(T_{\mu\nu} + T_{\nu\mu})$ . The relation with the hybrid DA is now

$$\langle H(p, \lambda) | \mathcal{R}_{\mu\nu} | 0 \rangle = \frac{1}{2} f_H M_H S_{(\mu\nu)} e_\mu^{(\lambda)} p_\nu \int_0^1 dy (1-2y) \phi^H(y). \quad (30)$$

The  $C$ - and  $P$ - parity are consistent since  $C(R_{\mu\nu}) = +$  and  $P(R_{k0}) = -$  (after going to rest-frame:  $p_i = 0$  and  $e_0 = 0$ ). The last step to control the order of magnitude is to fix  $f_H$  (the analogue of  $f_\rho$ ). It turns out that the operator  $\mathcal{R}_{\mu\nu}$  is related to quark energy-momentum tensor  $\Theta_{\mu\nu}$ :  $\mathcal{R}_{\mu\nu} = -i\Theta_{\mu\nu}$  which was studied based on QCD sum rules [101, 102]. Using the resonance for  $M \approx 1.4$  GeV (the  $\pi_1(1400)$ ) one gets  $f_H \approx 50$  MeV, to be compared with  $f_\rho = 216$  MeV. This leads to the following rough estimate of ratios of electroproduction cross-sections

$$\frac{d\sigma^H(Q^2, x_B, t)}{d\sigma^\rho(Q^2, x_B, t)} \approx \left( \frac{5f_H}{3f_\rho} \right)^2 \approx 0.15, \quad (31)$$

which does not change significantly [100] when using *Double Distributions* [40, 103] to model GPDs as well as when varying factorization and renormalization scales.

It turns out that the range around 1400 MeV is dominated by the  $a_2(1329)(2^{++})$  resonance, providing a possible playground for interference effects between  $H$  and  $a_2$ . This is possible through the  $\pi\eta$  channel, the presumable main decay mode for the  $\pi_1(1400)$  candidate. Based on models for the two  $C = +$  and  $C = -$  corresponding GDAs, angular asymmetry studies can be performed with respect to the  $\pi$  polar angle in the  $\pi\eta$  center-of-mass.

Hybrid could be also copiously produced in  $\gamma^*\gamma$  channel, i.e. at  $e^+e^-$  colliders with one tagged out-going electron. This can be described in a hard factorization framework, as illustrated in Fig. 13. The basic result obtained in this framework is that the production

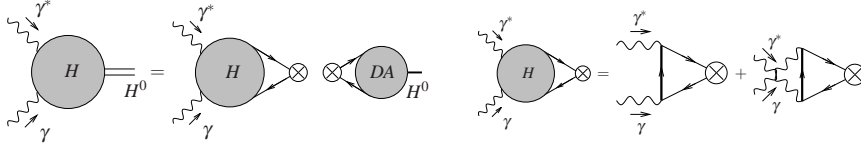

**Fig. 13** Left: Factorization of the  $\gamma^* \gamma \rightarrow H$  process. Right: Hard part at leading order.

amplitude for a hybrid state  $M^{\gamma^* \gamma \rightarrow \pi_1}$  scales in  $Q^2$  in the same way as the one for the "non-exotic"  $\pi^0$  production. One also obtains an estimate for the ratio of squared matrix elements of scattering amplitude for a hybrid state  $M^{\gamma^* \gamma \rightarrow \pi_1}$  versus a "non-exotic"  $\pi^0$  production

$$\frac{|M^{\gamma^* \gamma \rightarrow \pi_1}|^2}{|M^{\gamma^* \gamma \rightarrow \pi^0}|^2} \simeq 20\% .$$

Based on BaBar counting rates of  $\gamma^* \gamma \rightarrow \eta'$  up to  $Q^2 = 30 \text{ GeV}^2$ , one expect visible counting rates for  $\gamma^* \gamma \rightarrow \pi_1$ . If the state does not appear as a bump in the mass distribution, one may look for interference effects with the background opening the possibility to enhance the hybrid signal [104].

## 2.2 Spin transversity in the nucleon

The transverse spin content of the proton is an observable which is non-diagonal with respect to helicity. Indeed,

$$\begin{aligned} |\uparrow\rangle_{(x)} &\sim |\rightarrow\rangle + |\leftarrow\rangle \\ |\downarrow\rangle_{(x)} &\sim |\rightarrow\rangle - |\leftarrow\rangle . \end{aligned} \quad (32)$$

spin along  $x$  helicity state

An observable sensitive to helicity spin flip gives thus access to the transversity  $\Delta_T q(x)$ , which is very badly known. The transversity GPDs themselves are completely unknown. Chirality  $\pm$  is defined by

$$q_{\pm}(z) \equiv \frac{1}{2}(1 \pm \gamma^5)q(z) \text{ with } q(z) = q_+(z) + q_-(z). \quad (33)$$

A chiral-even quantity *conserves* chirality, like  $\bar{q}_{\pm}(z)\gamma^{\mu}q_{\pm}(-z)$  and  $\bar{q}_{\pm}(z)\gamma^{\mu}\gamma^5 q_{\pm}(-z)$ , while a chiral-odd operator *reverses* chirality, like  $\bar{q}_{\pm}(z) \cdot 1 \cdot q_{\mp}(-z)$ ,  $\bar{q}_{\pm}(z) \cdot \gamma^5 \cdot q_{\mp}(-z)$  and  $\bar{q}_{\pm}(z)[\gamma^{\mu}, \gamma^{\nu}]q_{\mp}(-z)$ . For a massless (anti)particle, chirality = (-)helicity. Transversity is thus a chiral-odd quantity. Now, since QCD and QED are chiral even (neglecting mass effects), the observable we are looking for should have the form  $\mathcal{A} \sim (\text{Ch.-odd})_1 \otimes (\text{Ch.-odd})_2$ .

The dominant DA for  $\rho_T$  is of twist 2 and chiral-odd ( $[\gamma^{\mu}, \gamma^{\nu}]$  coupling). Unfortunately, the scattering amplitude of the process  $\gamma^* N \rightarrow \rho_T N'$  is zero at twist 2. Indeed, at Born order, the two diagrams shown in Fig. 14 vanish [105], due to  $\gamma^{\alpha}[\gamma^{\mu}, \gamma^{\nu}]\gamma_{\alpha} = 0$ . This is true at any order in perturbation theory [106], since this would require a transfer of 2 units of helicity from the proton. This vanishing is true only a twist 2. A possible way out is to consider higher twist contributions, which do not vanish [107, 108]. However processes involving twist 3 DAs may face problems with factorization (end-point singularities: see later). The process  $\gamma p \rightarrow \pi^+ \rho_T^0 n$  gives access to transversity at twist 2. The factorization picture of this process is similar to the factorization à la Brodsky Lepage of  $\gamma + \pi \rightarrow \pi + \rho$  at large  $s$  and

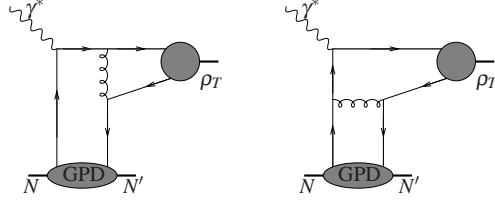

**Fig. 14** The two diagrams contributing at twist 2 to  $\gamma^* N \rightarrow \rho_T N'$ .

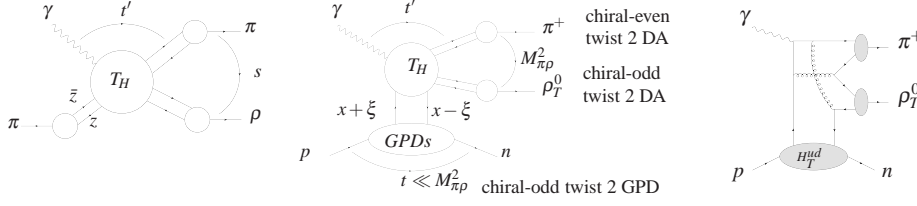

**Fig. 15** Left: Factorization of the amplitude for the process  $\gamma + \pi \rightarrow \pi + \rho$  at large  $s$  and fixed angle (i.e. fixed ratio  $t'/s$ ); Center: replacing one DA by a GPD leads to the factorization of the amplitude for  $\gamma p \rightarrow \pi^+ \rho_T^0 n$  at large  $M_{\pi\rho}^2$ . Right: An example of non-vanishing diagram contributing to  $\gamma p \rightarrow \pi^+ \rho_T^0 n$ .

fixed angle (i.e. fixed ratio  $t'/s, u'/s$ ), as shown in Fig. 15 (left). This justifies the factorization of the amplitude for  $\gamma p \rightarrow \pi^+ \rho_T^0 n$  at large  $M_{\pi\rho}^2$ , as shown in Fig. 15 (center). A typical non-vanishing diagram is shown in Fig. 15 (right). At large  $s$ , with Pomeron exchange, a similar study was proposed earlier [109, 110]. All these processes with a 3 body final state can give access to all GPDs:  $M_{\pi\rho}^2$  plays the role of the  $\gamma^*$  virtuality of usual DVCS (here in the time-like domain) and could be studied at JLab and COMPASS.

### 3 Hard exclusive processes in the perturbative Regge limit

#### 3.1 Theoretical motivations

Consider the diffusion of two hadrons  $h_1$  and  $h_2$ , in the special limit where

$$\sqrt{s} \gg \text{other scales (masses, transferred momenta, virtualities...)} \gg \Lambda_{QCD}. \quad (34)$$

In this limit, typical large logarithms like  $\alpha_s \ln s \sim 1$  arise, and should be resummed. The dominant sub-series, in the called LLx approximation,

$$\mathcal{A} = \underbrace{\text{diagram}}_{\sim s} + \left( \underbrace{\text{diagram}}_{\sim s} + \underbrace{\text{diagram}}_{\sim s} + \dots \right) + \left( \underbrace{\text{diagram}}_{\sim s} + \dots \right) + \dots \quad (35)$$

leads, using the optical theorem, to the total-cross section

$$\sigma_{tot}^{h_1 h_2 \rightarrow tout} = \frac{1}{s} \text{Im} \mathcal{A} \sim s^{\alpha_{\mathbb{P}}(0)-1}, \quad (36)$$



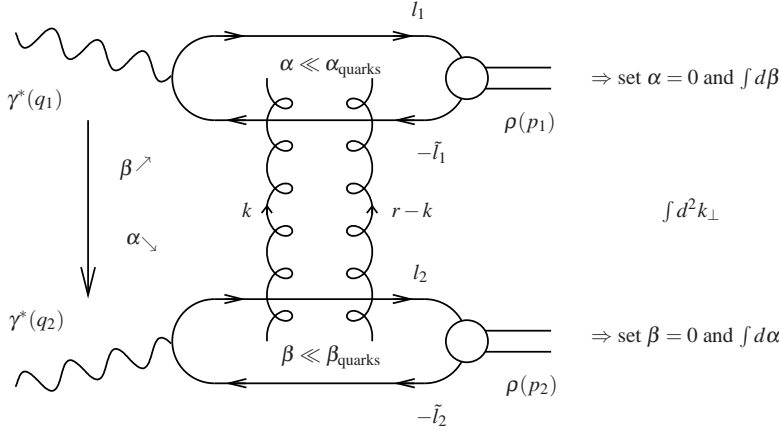

with  $\alpha_{\mathbb{P}}(0) - 1 = C \alpha_s$  ( $C > 0$ ). This is the so-called BFKL Pomeron (Balitsky, Fadin, Kuraev, Lipatov) [4, 5, 6, 7]. This result violates QCD  $S$  matrix unitarity which states that  $SS^\dagger = S^\dagger S = 1$  (i.e.  $\sum Prob. = 1$ ). The question is thus until when this result could be applicable, and how to improve it. Phenomenologically, a longstanding question is how to test this dynamics experimentally, in particular based on exclusive processes.

### 3.2 $k_T$ factorization

Let us consider  $\gamma^* \gamma^* \rightarrow \rho \rho$  scattering as an example. Using the Sudakov decomposition (14) where the two outgoing mesons flies along  $p_1$  and  $p_2$ , and expanding each loop momentum integration according to

$$d^4 k = \frac{s}{2} d\alpha d\beta d^2 k_\perp \quad (37)$$

the dominant contribution for the amplitude, which scales like  $s$  in the two gluon approximation, is obtained in the approximation where the above and below gluon emissions are treated eikonally, with  $\alpha \ll \alpha_{\text{quarks}}$  (above) and  $\beta \ll \beta_{\text{quarks}}$  (below). The amplitude is dominated by the exchange of the  $t$ -channel gluons with non-sense polarizations ( $\epsilon_{NS}^{up} = \frac{2}{\sqrt{s}} p_2$ ,  $\epsilon_{NS}^{down} = \frac{2}{\sqrt{s}} p_1$ ). This approximation is illustrated in Fig. 3.2 This leads to the impact representation for the amplitude, in the two-gluon approximation<sup>3</sup>,

$$\mathcal{M} = is \int \frac{d^2 \underline{k}}{(2\pi)^2 \underline{k}^2 (\underline{r} - \underline{k})^2} \Phi^{\gamma^*(q_1) \rightarrow \rho(p_1^p)}(\underline{k}, \underline{r} - \underline{k}) \Phi^{\gamma^*(q_2) \rightarrow \rho(p_2^p)}(-\underline{k}, -\underline{r} + \underline{k}) \quad (38)$$

where  $\Phi^{\gamma^*(q_1) \rightarrow \rho(p_1^p)}$  are the  $\gamma_{L,T}^*(q)g(k_1) \rightarrow \rho_{L,T}g(k_2)$ . The LLx approximation is obtained when replacing the two gluon exchange by the BFKL ladder, thus changing the first term under the integration in Eq. (38) by the BFKL Green function.

Note that the two  $t$ -channel gluons are off-shell, in contrast with usual collinear factorization. Since probes are color neutral, QCD gauge invariance implies that their impact factor should vanish when  $\underline{k} \rightarrow 0$  or  $\underline{r} - \underline{k} \rightarrow 0$ .

<sup>3</sup> Underlined letters denote euclidean two-dimensional vectors.

### 3.3 Meson production at HERA

Diffraction meson production at HERA, the first and single  $e^\pm p$  collider, running from 1992 until 2007, is a typical application of the above tool. The "easy" case (from factorization point of view) is  $J/\Psi$  production: since  $u \sim 1/2$  based on the non-relativistic limit for bound state of massive quarks [70], one avoids possible end-point singularities [111, 112, 113, 114, 115, 116]. At large  $t$  (providing the hard scale), light meson diffractive photoproduction  $\gamma + p \rightarrow \rho_{L,T} + X$  (with a rapidity gap between the meson and the proton remnants) was studied at LLx based on  $k_T$ -factorization [117, 118, 119, 120], taking into account a possible chiral-odd coupling of the photon [121, 122, 123]. In these approaches, H1 and ZEUS data seems to favor BFKL but end-point singularities for  $\rho_T$  are regularized with a quark mass  $m = m_\rho/2$  while the spin density matrix is badly described.

Exclusive electroproduction of vector meson  $\gamma_{L,T}^* + p \rightarrow \rho_{L,T} + p$  was studied in Ref. [124] and a hierarchy for the helicity amplitudes  $T_{\lambda_1 \lambda_2}$  of the process ( $\lambda_1 = 0, +1, -1$  is the photon helicity and  $\lambda_2 = 0, 1, -1$  is the vector-meson helicity) was obtained, modifying the pure SCHC according to

$$T_{00} > T_{11} > T_{10} > T_{01} > T_{1-1}. \quad (39)$$

The recent HERA data [125, 126] are in agreement with the above hierarchy, as illustrated in Fig. 16 for the ratios  $T_{11}/T_{00}$  and  $T_{01}/T_{00}$ , the two left panel showing in particular the twist 2 dominance of the amplitude  $T_{00}$  with respect to the twist 3 dominated amplitudes  $T_{11}$  and  $T_{01}$ . A similar approach to  $k_T$ -factorization, based on the so-called dipole model

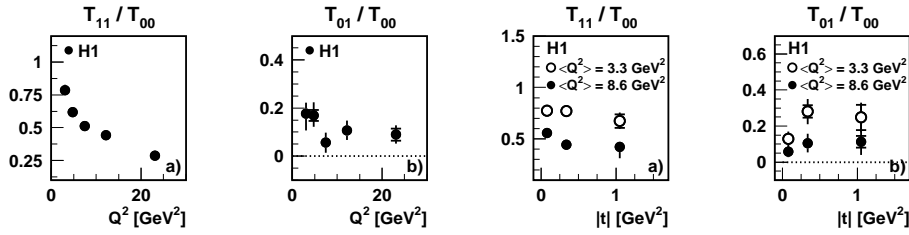

**Fig. 16** Left: Ratio  $T_{11}/T_{00}$  (a) and  $T_{01}/T_{00}$  (b) as a function of  $|t|$ . Right (a) and (b): same ratios as a function of  $Q^2$ , as measured by H1 for  $\gamma_{L,T}^* + p \rightarrow \rho_{L,T} + p$ . Figures from [126].

in transverse coordinate space [127, 128], has been developed [129] and applied to HERA data [130, 131, 132, 133]. Besides, it turns out that the data can also be well described by a GPD like evolution, based on ICA for the coupling with the meson DA with a gaussian ansatz for the meson wave function combined with Sudakov resummation effects [79, 80, 81]. There is however no complete description of this process starting from first principle.

The light-cone collinear factorization has been developed in order to deal with exclusive processes beyond leading twist [134, 135, 69, 68], inspired by the inclusive case [136, 137, 138, 139, 140, 141, 142]. Recently, a new self-consistent and very efficient extension has been carried on at a full twist 3 level [143, 144], illustrated below for the  $\gamma_T^* \rightarrow \rho_T$  impact factor at twist 3. It is a non-covariant technique in axial gauge based on the parametrization of matrix element along a light-like preferred direction  $z = \lambda n$  ( $n = 2 p_2/s$ ). Using notations of Fig. 9, the pure twist 2 collinear approximation means  $l_\mu = u p_\mu$ , which we should now

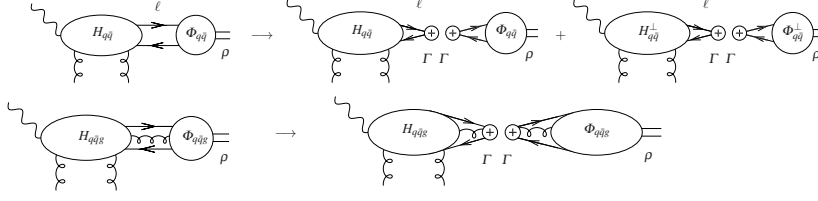

**Fig. 17** Impact factor factorization up to twist 3.

extend. A Sudakov expansion in the basis  $p \sim p\rho, n$  ( $p^2 = n^2 = 0$  and  $p \cdot n = 1$ ) is made, with the scaling indicated below each term

$$l_{\mu} = up_{\mu} + l_{\mu}^{\perp} + (l \cdot p)n_{\mu}, \quad u = l \cdot n \quad (40)$$

$$1 \quad 1/Q \quad 1/Q^2.$$

We now Taylor expand the hard part  $H(\ell)$  along the collinear direction  $p$

$$H(\ell) = H(up) + \left. \frac{\partial H(\ell)}{\partial \ell_{\alpha}} \right|_{\ell=up} (\ell - up)_{\alpha} + \dots \quad \text{with } (\ell - up)_{\alpha} \approx \ell_{\alpha}^{\perp}. \quad (41)$$

Fourier transform turns the  $l_{\alpha}^{\perp}$  contribution to a derivative of the soft term, of type

$$\int d^4 z e^{-i\ell \cdot z} \langle \rho(p) | \psi(0) i \overleftrightarrow{\partial}_{\alpha^{\perp}} \bar{\psi}(z) | 0 \rangle.$$

After Fierz transformation, this gives the two and three body factorized contributions to the impact factor symbolically shown in Fig. 17. We are thus lead to introduce non-local correlators along the preferred direction  $z = \lambda n$ , with contributions arising from Taylor expansion up to needed term for a given twist order computation, here 7 correlators at twist 3, which are non-minimal. These correlators satisfies two equations of motion. Additionally, the independence with respect to the choice of the vector  $n$  defining

- the light-cone direction  $z: z = \lambda n$
- the  $\rho_T$  polarization vector:  $e_T \cdot n = 0$
- the axial gauge:  $n \cdot A = 0$

leads for the amplitude  $\mathcal{A}$  to an equation of the form

$$\frac{d\mathcal{A}}{dn_{\perp}^{\mu}} = 0 \quad (42)$$

since only the  $\perp$  component of  $n$  here matters, as illustrated in Fig. 18. It can be shown that Eq. (42) implies, for the factorized amplitude  $\mathcal{A} = H \otimes S$ , a set of two equations among the non-local correlators. Finally, 3 independent DA are necessary, which are  $\phi_1(y)$  (2-body twist 2 correlator),  $B(y_1, y_2)$  (3-body genuine twist 3 vector correlator) and  $D(y_1, y_2)$  (3-body genuine twist 3 axial correlator).

Another approach [145, 66, 67], fully covariant but much less convenient when practically computing coefficient functions, can equivalently be used. The dictionnary between these two approaches has been derived and explicitly checked for the  $\gamma_T^* \rightarrow \rho_T$  impact factor at twist 3 [143, 144]. This result, combined to a simple model for the proton impact factor, has been applied successfully [146] to the ratios  $T_{11}/T_{00}$  and  $T_{01}/T_{00}$  measured at HERA.

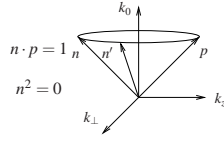

**Fig. 18** Arbitrariness of the light-cone choice for  $n$ , under the constraint  $n \cdot p = 1$ .

### 3.4 Exclusive $\gamma^{(*)}\gamma^{(*)}$ processes

Exclusive  $\gamma^{(*)}\gamma^{(*)}$  processes are gold places for testing QCD at large  $s$ . Aside from studies of the inclusive  $\gamma^*\gamma^*$  total cross-section [147, 148, 149, 150, 151, 152, 153], there have been indeed several proposals in order to test perturbative QCD in the large  $s$  limit ( $t$ -structure of the hard  $\mathbb{P}$ omeron, saturation,  $\mathbb{O}$ dderon...). These are based either on ultraperipheral events where the incoming photon are produced by leptonic or hadronic sources, or on single or double tagged  $e^+e^-$  collisions. The first proposition was to consider  $\gamma^{(*)}(q) + \gamma^{(*)}(q') \rightarrow J/\Psi J/\Psi$ , using the mass of the  $J/\Psi$  has a hard scale [154, 155]. Then, the double tagged lepton scattering at the International Linear Collider (ILC)  $e^+e^- \rightarrow e^+e^- \rho_L(p_1) + \rho_L(p_2)$  has been proposed and studied [156, 157, 158, 159, 160, 161], as an access to the subprocess  $\gamma_{L,T}^*(q) + \gamma_{L,T}^*(q') \rightarrow \rho_L(p_1) + \rho_L(p_2)$ . These studies have proven the feasibility at ILC of these measurements, based on the expected high energy and high luminosity of ILC project. A BFKL enhancement with respect to Born and DGLAP contributions is expected<sup>4</sup>, with a factor of the order of 4 to 5.

Other proposals have been made, including searches for the elusive  $\mathbb{O}$ dderon [163], the  $C$ -parity odd partner of the  $\mathbb{P}$ omeron. Apart from exclusive tests like  $\gamma\gamma \rightarrow \eta_c \eta_c$  which only involve the tiny  $\mathbb{O}$ dderon exchange [164, 165], it has been recently proposed to consider the  $\gamma + \gamma \rightarrow \pi^+ \pi^- \pi^+ \pi^-$  process. Since the  $\pi^+ \pi^-$  pair has no fixed  $C$ -parity,  $\mathbb{O}$ dderon and  $\mathbb{P}$ omeron exchanges can interfere. Thus, although the  $\mathbb{O}$ dderon contribution is presumably tiny, it appears linearly in the charge asymmetry [166]. However, the distinction with pure QCD processes (with gluons instead of a photon) is tricky, and pile-up at CMS and ATLAS put severe conditions for this measurement.

## 4 Conclusion

Since a decade, there have been much progress in the understanding of hard exclusive processes. At medium energies, there is now a conceptual framework starting from first principle, allowing to describe a huge number of processes. At high energy, the impact representation is a powerful tool for describing exclusive processes in diffractive experiments; they are and will be essential for studying QCD in the hard Regge limit ( $\mathbb{P}$ omeron,  $\mathbb{O}$ dderon, saturation...). Still, some problems remain. Proofs of factorization have been obtained only for very few processes (ex.:  $\gamma^* p \rightarrow \gamma p$ ,  $\gamma_L^* p \rightarrow \rho_L p$ .) For some other processes factorization is highly plausible, but not fully demonstrated at any order (ex.: processes involving GDAs and TDAs). Some processes explicitly show signs of breaking of factorization (ex.:  $\gamma_T^* p \rightarrow \rho_T p$  which has end-point singularities at Leading Order). Besides, models and results from the lattice for the non-perturbative correlators entering GPDs, DAs, GDAs, TDAs are needed,

<sup>4</sup> Note that this process  $\gamma^*\gamma^* \rightarrow \rho_L \rho_L$  is dominated at high energy by gluon exchange. At medium energies, quark exchange start to be the dominant contribution, which can be factorized in two ways involving either the GDA of the  $\rho$  pair or the  $\gamma^* \rightarrow \rho$  TDA, depending on the polarization of the incoming photons [162].

---

even at a qualitative level! The effect of QCD evolution, the NLO corrections, the choice of renormalization/factorization scale, power corrections will be very relevant to interpret and describe the forecoming data. At high energy and high luminosity colliders (LHC, Tevatron, ILC) exclusive processes are and will be essential for studying QCD in the hard Regge limit (Pomeron, Odderon, saturation effects...). To conclude, one should notice that links between theoretical and experimental communities involved in exclusive processes are very fruitful.

### Acknowledgements

I would like to thank B. Pire and L. Szymanowski for discussions and comments.

- [1] V.N. Gribov, L.N. Lipatov, *Sov. J. Nucl. Phys.* **15**, 438 (1972)
- [2] G. Altarelli, G. Parisi, *Nucl. Phys.* **B126**, 298 (1977)
- [3] Y.L. Dokshitzer, *Sov. Phys. JETP* **46**, 641 (1977)
- [4] V.S. Fadin, E.A. Kuraev, L.N. Lipatov, *Phys. Lett.* **B60**, 50 (1975)
- [5] E.A. Kuraev, L.N. Lipatov, V.S. Fadin, *Sov. Phys. JETP* **44**, 443 (1976)
- [6] E.A. Kuraev, L.N. Lipatov, V.S. Fadin, *Sov. Phys. JETP* **45**, 199 (1977)
- [7] I.I. Balitsky, L.N. Lipatov, *Sov. J. Nucl. Phys.* **28**, 822 (1978)
- [8] I. Balitsky, *Nucl. Phys.* **B463**, 99 (1996)
- [9] I. Balitsky, *Phys. Rev. Lett.* **81**, 2024 (1998)
- [10] I. Balitsky, *Phys. Rev.* **D60**, 014020 (1999)
- [11] I. Balitsky, *Phys. Lett.* **B518**, 235 (2001)
- [12] Y.V. Kovchegov, *Phys. Rev.* **D60**, 034008 (1999)
- [13] Y.V. Kovchegov, *Phys. Rev.* **D61**, 074018 (2000)
- [14] J. Bartels, *Z. Phys.* **C60**, 471 (1993)
- [15] J. Bartels, *Phys. Lett.* **B298**, 204 (1993)
- [16] J. Bartels, M. Wusthoff, *Z. Phys.* **C66**, 157 (1995)
- [17] J. Bartels, L.N. Lipatov, M. Wusthoff, *Nucl. Phys.* **B464**, 298 (1996)
- [18] R.B. Peschanski, *Phys. Lett.* **B409**, 491 (1997)
- [19] A. Bialas, H. Navelet, R.B. Peschanski, *Phys. Rev.* **D57**, 6585 (1998)
- [20] A. Bialas, H. Navelet, R.B. Peschanski, *Phys. Lett.* **B427**, 147 (1998)
- [21] G.A. Chirilli, L. Szymanowski, S. Wallon, *Phys. Rev.* **D83**, 014020 (2011)

- 
- [22] J. Jalilian-Marian, A. Kovner, A. Leonidov, H. Weigert, Phys. Rev. **D59**, 014014 (1999)
- [23] J. Jalilian-Marian, A. Kovner, H. Weigert, Phys. Rev. **D59**, 014015 (1999)
- [24] J. Jalilian-Marian, A. Kovner, A. Leonidov, H. Weigert, Nucl. Phys. **B504**, 415 (1997)
- [25] J. Jalilian-Marian, A. Kovner, A. Leonidov, H. Weigert, Phys. Rev. **D59**, 034007 (1999)
- [26] A. Kovner, J.G. Milhano, H. Weigert, Phys. Rev. **D62**, 114005 (2000)
- [27] E. Iancu, A. Leonidov, L.D. McLerran, Nucl. Phys. **A692**, 583 (2001)
- [28] E. Iancu, A. Leonidov, L.D. McLerran, Phys. Lett. **B510**, 133 (2001)
- [29] E. Ferreira, E. Iancu, A. Leonidov, L. McLerran, Nucl. Phys. **A703**, 489 (2002)
- [30] H. Weigert, Nucl. Phys. **A703**, 823 (2002)
- [31] P.A.M. Guichon, M. Vanderhaeghen, Prog. Part. Nucl. Phys. **41**, 125 (1998)
- [32] K. Goeke, M.V. Polyakov, M. Vanderhaeghen, Prog. Part. Nucl. Phys. **47**, 401 (2001)
- [33] M. Diehl, Phys. Rept. **388**, 41 (2003)
- [34] A.V. Belitsky, A.V. Radyushkin, Phys. Rept. **418**, 1 (2005)
- [35] S. Boffi, B. Pasquini, Riv. Nuovo Cim. **30**, 387 (2007)
- [36] V.D. Burkert, M. Diehl, In \*Close, Frank (ed.) et al.: Electromagnetic interactions and hadronic structure\* 359-423
- [37] M. Guidal, Prog. Part. Nucl. Phys. **61**, 89 (2008)
- [38] S.J. Brodsky, L. Frankfurt, J.F. Gunion, A.H. Mueller, M. Strikman, Phys. Rev. **D50**, 3134 (1994)
- [39] D. Mueller, D. Robaschik, B. Geyer, F.M. Dittes, J. Horejsi, Fortschr. Phys. **42**, 101 (1994)
- [40] A.V. Radyushkin, Phys. Rev. **D56**, 5524 (1997)
- [41] X.D. Ji, J. Osborne, Phys. Rev. **D58**, 094018 (1998)
- [42] J.C. Collins, A. Freund, Phys. Rev. **D59**, 074009 (1999)
- [43] B. Pire, L. Szymanowski, J. Wagner, Phys.Rev. **D79**, 014010 (2009)
- [44] B. Pire, L. Szymanowski, J. Wagner, Phys.Rev. **D83**, 034009 (2011)
- [45] J.C. Collins, L. Frankfurt, M. Strikman, Phys. Rev. **D56**, 2982 (1997)
- [46] M. Diehl, T. Gousset, B. Pire, O. Teryaev, Phys. Rev. Lett. **81**, 1782 (1998)
- [47] M. Diehl, T. Gousset, B. Pire, Phys. Rev. **D62**, 073014 (2000)

- 
- [48] B. Pire, L. Szymanowski, Phys. Rev. **D71**, 111501 (2005)
- [49] B. Pire, L. Szymanowski, Phys. Lett. **B622**, 83 (2005)
- [50] J.P. Lansberg, B. Pire, L. Szymanowski, Phys. Rev. **D76**, 111502 (2007)
- [51] V.L. Chernyak, A.R. Zhitnitsky, JETP Lett. **25**, 510 (1977)
- [52] V.L. Chernyak, A.R. Zhitnitsky, V.G. Serbo, JETP Lett. **26**, 594 (1977)
- [53] V.L. Chernyak, V.G. Serbo, A.R. Zhitnitsky, Sov. J. Nucl. Phys. **31**, 552 (1980)
- [54] V.L. Chernyak, A.R. Zhitnitsky, Sov. J. Nucl. Phys. **31**, 544 (1980)
- [55] G.P. Lepage, S.J. Brodsky, Phys. Rev. **D22**, 2157 (1980)
- [56] G.R. Farrar, D.R. Jackson, Phys. Rev. Lett. **43**, 246 (1979)
- [57] G.P. Lepage, S.J. Brodsky, Phys. Lett. **B87**, 359 (1979)
- [58] A.V. Efremov, A.V. Radyushkin, Phys. Lett. **B94**, 245 (1980)
- [59] X.D. Ji, J. Phys. **G24**, 1181 (1998)
- [60] K.J. Golec-Biernat, A.D. Martin, Phys. Rev. **D59**, 014029 (1999)
- [61] M. Diehl, T. Feldmann, R. Jakob, P. Kroll, Nucl. Phys. **B596**, 33 (2001)
- [62] A.P. Bukhvostov, E.A. Kuraev, L.N. Lipatov, JETP Lett. **37**, 482 (1983)
- [63] A.P. Bukhvostov, G.V. Frolov, L.N. Lipatov, E.A. Kuraev, Nucl. Phys. **B258**, 601 (1985)
- [64] F.M. Dittes, D. Mueller, D. Robaschik, B. Geyer, J. Horejsi, Phys. Lett. **B209**, 325 (1988)
- [65] L. Mankiewicz, G. Piller, Phys. Rev. **D61**, 074013 (2000)
- [66] P. Ball, V.M. Braun, Y. Koike, K. Tanaka, Nucl. Phys. **B529**, 323 (1998)
- [67] P. Ball, V.M. Braun, Nucl. Phys. **B543**, 201 (1999)
- [68] I.V. Anikin, O.V. Teryaev, Nucl. Phys. **A711**, 199 (2002)
- [69] I.V. Anikin, O.V. Teryaev, Phys. Lett. **B554**, 51 (2003)
- [70] V.L. Chernyak, A.R. Zhitnitsky, Phys. Rept. **112**, 173 (1984)
- [71] H. nan Li, G. Sterman, Nucl. Phys. **B381**, 129 (1992)
- [72] J. Botts, G. Sterman, Nucl. Phys. **B325**, 62 (1989)
- [73] I.V. Musatov, A.V. Radyushkin, Phys. Rev. **D56**, 2713 (1997)
- [74] S. Descotes-Genon, C.T. Sachrajda, Nucl. Phys. **B625**, 239 (2002)
- [75] R. Jakob, P. Kroll, Phys. Lett. **B315**, 463 (1993)

- [76] R. Jakob, P. Kroll, M. Raulfs, J. Phys. **G22**, 45 (1996)
- [77] P. Kroll, M. Raulfs, Phys. Lett. **B387**, 848 (1996)
- [78] M. Vanderhaeghen, P.A.M. Guichon, M. Guidal, Phys. Rev. **D60**, 094017 (1999)
- [79] S.V. Goloskokov, P. Kroll, Eur. Phys. J. **C42**, 281 (2005)
- [80] S.V. Goloskokov, P. Kroll, Eur. Phys. J. **C50**, 829 (2007)
- [81] S.V. Goloskokov, P. Kroll, Eur. Phys. J. **C53**, 367 (2008)
- [82] D. Alde, et al., Phys.Lett. **B205**, 397 (1988)
- [83] D.R. Thompson, et al., Phys. Rev. Lett. **79**, 1630 (1997)
- [84] A. Abele, et al., Phys.Lett. **B423**, 175 (1998)
- [85] A. Abele, et al., Phys.Lett. **B446**, 349 (1999)
- [86] V. Dorofeev, et al., AIP Conf.Proc. **619**, 143 (2002)
- [87] G.S. Adams, et al., Phys. Rev. Lett. **81**, 5760 (1998)
- [88] E. Ivanov, et al., Phys.Rev.Lett. **86**, 3977 (2001)
- [89] S. Chung, K. Danyo, R. Hackenburg, C. Olchanski, J. Suh, et al., Phys.Rev. **D65**, 072001 (2002)
- [90] J. Kuhn, et al., Phys.Lett. **B595**, 109 (2004)
- [91] M. Lu, et al., Phys.Rev.Lett. **94**, 032002 (2005)
- [92] C. Baker, C. Batty, K. Braune, D. Bugg, N. Dzhaoshvili, et al., Phys.Lett. **B563**, 140 (2003)
- [93] G. Beladidze, et al., Phys.Lett. **B313**, 276 (1993)
- [94] Y. Khokhlov, Nucl.Phys. **A663**, 596 (2000)
- [95] D. Amelin, Y. Gavrilov, Y. Gouz, V. Dorofeev, R. Dzhelyadin, et al., Phys.Atom.Nucl. **68**, 359 (2005)
- [96] M. Alekseev, et al., Phys.Rev.Lett. **104**, 241803 (2010)
- [97] R.L. Jaffe, K. Johnson, Z. Ryzak, Ann. Phys. **168**, 344 (1986)
- [98] G.S. Bali, Phys. Rept. **343**, 1 (2001)
- [99] I.V. Anikin, B. Pire, L. Szymanowski, O.V. Teryaev, S. Wallon, Phys. Rev. **D70**, 011501 (2004)
- [100] I.V. Anikin, B. Pire, L. Szymanowski, O.V. Teryaev, S. Wallon, Phys. Rev. **D71**, 034021 (2005)
- [101] I.I. Balitsky, D. Diakonov, A.V. Yung, Phys. Lett. **B112**, 71 (1982)



- 
- [102] I.I. Balitsky, D. Diakonov, A.V. Yung, *Z. Phys.* **C33**, 265 (1986)
- [103] A.V. Radyushkin, *Phys. Rev.* **D59**, 014030 (1999)
- [104] I.V. Anikin, B. Pire, L. Szymanowski, O.V. Teryaev, S. Wallon, *Eur. Phys. J.* **C47**, 71 (2006)
- [105] M. Diehl, T. Gousset, B. Pire, *Phys. Rev.* **D59**, 034023 (1999)
- [106] J.C. Collins, M. Diehl, *Phys. Rev.* **D61**, 114015 (2000)
- [107] S. Ahmad, G.R. Goldstein, S. Liuti, *Phys. Rev.* **D79**, 054014 (2009)
- [108] S. Goloskokov, P. Kroll, *Eur.Phys.J.* **C65**, 137 (2010).
- [109] D.Y. Ivanov, B. Pire, L. Szymanowski, O.V. Teryaev, *Phys. Lett.* **B550**, 65 (2002)
- [110] R. Enberg, B. Pire, L. Szymanowski, *Eur. Phys. J.* **C47**, 87 (2006)
- [111] M.G. Ryskin, *Z. Phys.* **C57**, 89 (1993)
- [112] A.D. Martin, M.G. Ryskin, T. Teubner, *Phys. Rev.* **D55**, 4329 (1997)
- [113] A.D. Martin, M.G. Ryskin, T. Teubner, *Phys. Rev.* **D56**, 3007 (1997)
- [114] A.D. Martin, M.G. Ryskin, T. Teubner, *Phys. Rev.* **D62**, 014022 (2000)
- [115] R. Enberg, L. Motyka, G. Poludniowski, *Eur. Phys. J.* **C26**, 219 (2002)
- [116] D. Ivanov, A. Schafer, L. Szymanowski, G. Krasnikov, *Eur.Phys.J.* **C34**, 297 (2004)
- [117] D.Y. Ivanov, *Phys. Rev.* **D53**, 3564 (1996)
- [118] J.R. Forshaw, M.G. Ryskin, *Z. Phys.* **C68**, 137 (1995)
- [119] J. Bartels, J.R. Forshaw, H. Lotter, M. Wusthoff, *Phys. Lett.* **B375**, 301 (1996)
- [120] J.R. Forshaw, G. Poludniowski, *Eur. Phys. J.* **C26**, 411 (2003)
- [121] D.Y. Ivanov, R. Kirschner, A. Schafer, L. Szymanowski, *Phys. Lett.* **B478**, 101 (2000)
- [122] R. Enberg, J.R. Forshaw, L. Motyka, G. Poludniowski, *JHEP* **09**, 008 (2003)
- [123] G.G. Poludniowski, R. Enberg, J.R. Forshaw, L. Motyka, *JHEP* **12**, 002 (2003)
- [124] D.Y. Ivanov, R. Kirschner, *Phys. Rev.* **D58**, 114026 (1998)
- [125] S. Chekanov, et al., *PMC Phys.* **A1**, 6 (2007)
- [126] F.D. Aaron, et al., *JHEP* **05**, 032 (2010)
- [127] A.H. Mueller, *Nucl. Phys.* **B335**, 115 (1990)
- [128] N.N. Nikolaev, B.G. Zakharov, *Z. Phys.* **C49**, 607 (1991)
- [129] J. Nemchik, N.N. Nikolaev, E. Predazzi, B.G. Zakharov, *Z. Phys.* **C75**, 71 (1997)

- 
- [130] J.R. Forshaw, R. Sandapen, G. Shaw, Phys. Rev. **D69**, 094013 (2004)
- [131] H. Kowalski, L. Motyka, G. Watt, Phys.Rev. **D74**, 074016 (2006)
- [132] J.R. Forshaw, R. Sandapen, JHEP **11**, 037 (2010)
- [133] J.R. Forshaw, R. Sandapen, *Extracting the Distribution Amplitudes of the rho meson from the Color Glass Condensate*, arXiv:1104.4753 [hep-ph]
- [134] I.V. Anikin, B. Pire, O.V. Teryaev, Phys. Rev. **D62**, 071501 (2000)
- [135] I.V. Anikin, O.V. Teryaev, Phys. Lett. **B509**, 95 (2001)
- [136] A.V. Efremov, O.V. Teryaev, Sov. J. Nucl. Phys. **36**, 140 (1982)
- [137] E.V. Shuryak, A.I. Vainshtein, Nucl. Phys. **B199**, 451 (1982)
- [138] E.V. Shuryak, A.I. Vainshtein, Nucl. Phys. **B201**, 141 (1982)
- [139] R.K. Ellis, W. Furmanski, R. Petronzio, Nucl. Phys. **B212**, 29 (1983)
- [140] A.V. Efremov, O.V. Teryaev, Sov. J. Nucl. Phys. **39**, 962 (1984)
- [141] O.V. Teryaev, *Twist - three in proton nucleon single spin asymmetries*, hep-ph/0102296
- [142] A.V. Radyushkin, C. Weiss, Phys. Rev. **D64**, 097504 (2001)
- [143] I.V. Anikin, D.Y. Ivanov, B. Pire, L. Szymanowski, S. Wallon, Phys. Lett. **B682**, 413 (2010)
- [144] I.V. Anikin, D.Y. Ivanov, B. Pire, L. Szymanowski, S. Wallon, Nucl. Phys. **B828**, 1 (2010)
- [145] P. Ball, V.M. Braun, Phys. Rev. **D54**, 2182 (1996)
- [146] I. Anikin, A. Besse, D. Ivanov, B. Pire, L. Szymanowski, S. Wallon, Phys. Rev. **D84**, 054004 (2011)
- [147] J. Bartels, A. D. Roeck, H. Lotter, Phys. Lett. **B389** 742 (1996)
- [148] S. J. Brodsky, F. Hautmann, D. E. Soper, Phys. Rev. Lett. **78** 803 (1997)
- [149] S. J. Brodsky, F. Hautmann, D. E. Soper, Phys. Rev. **D56** 6957 (1997)
- [150] M. Boonekamp, A. De Roeck, C. Royon, S. Wallon, Nucl. Phys. **B555** 540 (1999)
- [151] A. Bialas, W. Czyz, W. Florkowski, Eur. Phys. J. **C2** 683 (1998)
- [152] J. Kwiecinski, L. Motyka, Phys. Lett. **B462** 203 (1999)
- [153] J. Kwiecinski and L. Motyka, Eur. Phys. J. **C18** 343 (2000)
- [154] J. Kwiecinski, L. Motyka, Phys. Lett. **B438**, 203 (1998)
- [155] J. Kwiecinski, L. Motyka, A.D. Roeck, (1999)

- 
- [156] B. Pire, L. Szymanowski, S. Wallon, *Eur. Phys. J.* **C44**, 545 (2005)
- [157] R. Enberg, B. Pire, L. Szymanowski, S. Wallon, *Eur. Phys. J.* **C45**, 759 (2006)
- [158] D.Y. Ivanov, A. Papa, *Nucl. Phys.* **B732**, 183 (2006)
- [159] D.Y. Ivanov, A. Papa, *Eur. Phys. J.* **C49**, 947 (2007)
- [160] M. Segond, L. Szymanowski, S. Wallon, *Eur. Phys. J.* **C52**, 93 (2007)
- [161] F. Caporale, A. Papa, A.S. Vera, *Eur. Phys. J.* **C53**, 525 (2008)
- [162] B. Pire, M. Segond, L. Szymanowski, S. Wallon, *Phys. Lett.* **B639**, 642 (2006)
- [163] L. Lukaszuk, B. Nicolescu, *Nuovo Cim. Lett.* **8**, 405 (1973)
- [164] L. Motyka, J. Kwiecinski, *Phys. Rev.* **D58** 117501 (1998)
- [165] S. Braunewell, C. Ewerz, *Phys. Rev.* **D70**, 014021 (2004)
- [166] B. Pire, F. Schwennsen, L. Szymanowski, S. Wallon, *Phys. Rev.* **D78**, 094009 (2008)