

Distributed and Cascade Lossy Source Coding with a Side Information “Vending Machine”

Behzad Ahmadi and Osvaldo Simeone

Department of Electrical and Computer Engineering

New Jersey Institute of Technology

University Heights, Newark, New Jersey 07102

Email: behzad.ahmadi@njit.edu, osvaldo.simeone@njit.edu

Abstract

Source coding with a side information “vending machine” is a recently proposed framework in which the statistical relationship between the side information and the source, instead of being given and fixed as in the classical Wyner-Ziv problem, can be controlled by the decoder. This control action is selected by the decoder based on the message encoded by the source node. Unlike conventional settings, the message can thus carry not only information about the source to be reproduced at the decoder, but also control information aimed at improving the quality of the side information.

In this paper, the analysis of the trade-offs between rate, distortion and cost associated with the control actions is extended from the previously studied point-to-point set-up to two basic multiterminal models. First, a distributed source coding model is studied, in which two encoders communicate over rate-limited links to a decoder, whose side information can be controlled. The control actions are selected by the decoder based on the messages encoded by both source nodes. For this set-up, inner bounds are derived on the rate-distortion-cost region for both cases in which the side information is available causally and non-causally at the decoder. These bounds are shown to be tight under specific assumptions, including the scenario in which the sequence observed by one of the nodes is a function of the source observed by the other and the side information is available causally at the decoder. Then, a cascade scenario in which three nodes are connected in a cascade and the last node has controllable side information, is also investigated. For this model, the rate-distortion-cost region is derived for general

This work has been supported by the U.S. National Science Foundation under grant CCF-0914899.

distortion requirements and under the assumption of causal availability of side information at the last node.

Keywords: Distributed source coding, cascade source coding, observation costs, side information, side information vending machine, rate-distortion theory.

I. INTRODUCTION

Reference [1] introduced the notion of a side information “vending machine”. To illustrate the idea, consider the setting in Fig. 1, as studied in [1]. Here, unlike the conventional Wyner-Ziv set-up (see, e.g., [2, Chapter 12]), the joint distribution of the side information Y available at the decoder (Node 2) and of the source X observed at the encoder (Node 1) is not given. Instead, it can be controlled through the selection of an “action” A , so that, for a given action A and source symbol X , the side information Y is distributed according to a given conditional distribution $p(y|a, x)$. Action A is selected by the decoder based on the message M , of R bits per source symbol, received from the encoder, and is subject to a cost constraint. The latter limits the “quality” of the side information that can be collected by the decoder.

The source coding problem with a vending machine provides a useful model for scenarios in which acquiring data as side information is costly and thus should be done effectively. Examples include computer networks, in which data must be obtained from remote data bases, and sensor networks, where data is acquired via measurements.

The key aspect of this model is that the message M produced by the encoder plays a double role. In fact, on the one hand, it needs to carry the description of the source X itself, as in, e.g., the standard Wyner-Ziv model. On the other hand, it can also carry *control* information aimed at enabling the decoder to make an appropriate selection of action A . The goal of such a selection is to obtain a side information Y that is better suited to provide partial information about the source X to the decoder. This in turn can potentially reduce the rate R necessary for the decoder to reconstruct source X at a given distortion level (or, vice versa, to reduce the distortion level for a given rate R).

The performance of the system in Fig. 1 is expressed in terms of the interplay among three metrics, namely the rate R , the cost budget Γ on the action A , and the distortion D of the reconstruction \hat{X} at the decoder. This trade-off is summarized by the *rate-distortion-cost* function $R(D, \Gamma)$. This function characterizes the infimum of all rates R for which a distortion level D

can be achieved under an action cost budget Γ , by allowing encoding of an arbitrary number n of source symbols $X^n = (X_1, \dots, X_n)$. This function is derived in [1] for both cases in which the side information Y is available “non-causally” to the decoder, as in the standard Wyner-Ziv model, or “causally”, as introduced in [3]. In the former case (Fig. 1-(a)), the estimated sequence $\hat{X}^n = (\hat{X}_1, \dots, \hat{X}_n)$ is a function of message M and of the entire side information sequence $Y^n = (Y_1, \dots, Y_n)$, while, in the latter (Fig. 1-(b)), each estimated sample \hat{X}_i is a function of message M and the side information as received up to time i , i.e., $Y^i = (Y_1, \dots, Y_i)$ for $i = 1, \dots, n$. We note that the model with causal side information is appropriate, for instance, when there are delay constraints on the reproduction at the decoder or when the decoder operates by filtering the side information sequence. We refer to [3, Sec I] for an extensive discussion on these points.

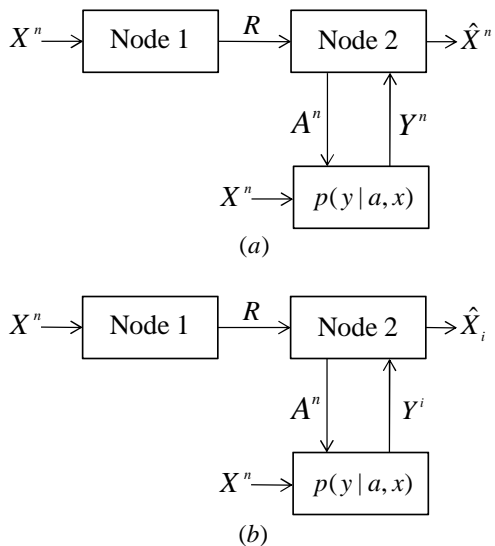

Fig. 1. Source coding with a vending machine at the decoder [1] with: (a) “non-causal” side information; (b) “causal” side information.

Following reference [1], recent works [4] and [5] generalized the characterization of the rate-distortion-cost function for the models in Fig. 1 to a set-up analogous to the so called Kaspi-Heegard-Berger problem [6][7], in which the side information vending machine may or may not be available at the decoder. This entails the presence of *two decoders*, rather than only one as in Fig. 1, one with access to the vending machine and one without any side information. Reference [4], [5] also solved the more general case in which both decoders have access to the same vending

machine, and either the side informations produced by the vending machine at the two decoders satisfy a degradedness condition, or lossless source reconstructions are required at the decoders. The papers [8][9] studied the setting of Fig. 1 but under the additional constraints of common reconstruction, in the sense of [10], in [8], and of secrecy with respect to an “eavesdropping” node in [9], providing characterizations of the corresponding achievable performance. The impact of actions that adapt to the previously measured samples of the side information is studied in [11]. Finally, real-time constraints are investigated in [12].

A. Contributions and Overview

In this paper, we study two multi-terminal extensions of the set-up in Fig. 1, namely the *distributed source coding* setting of Fig. 2, and the *cascade* model of Fig. 3. The analysis of these scenarios is motivated by the observation that they constitute key components of computer and sensor networks. In fact, as discussed above, an important aspect of these networks is the need to effectively acquire side information data, which can be modeled by including a side information vending machine. We overview the two extensions and the corresponding main results below.

1) *Distributed source coding with a side information vending machine* (Sec. II): In the distributed source coding setting of Fig. 2, *two encoders* (Node 1 and Node 2), which measure correlated sources X_1 and X_2 , respectively, communicate over rate-limited links, of rates R_1 and R_2 , respectively, to a single decoder (Node 3). The decoder has side information Y on sources X_1 and X_2 , which can be controlled through an action A . The action sequence is selected by the decoder based on the messages M_1 and M_2 received from Node 1 and Node 2, respectively, and needs to satisfy a cost constraint of Γ . Inner bounds are derived to the rate-distortion-cost region $\mathcal{R}(D_1, D_2, \Gamma)$ under non-causal and causal side information by combining the strategies proposed in [1] with the Berger-Tung strategy [13] and its extension to the Wyner-Ziv set-up [14]. These bounds are shown to be tight under specific assumptions, including the scenario where the sequence observed by one of the nodes is a function of the source observed by the other and the side information is available causally at the decoder.

2) *Cascade source coding with a side information vending machine* (Sec. III): In the cascade model of Fig. 3, Node 1 is connected via a rate-limited link, of rate R_{12} , to Node 2, which is in turn communicates with Node 3 with rate R_{23} . Source X_1 is measured by Node 1 and the

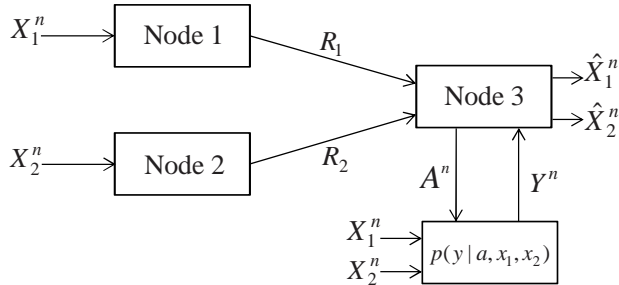

Fig. 2. Distributed source coding with a side information vending machine at the decoder.

correlated source X_2 by both Node 1 and Node 2. Similarly to the distributed coding setting described above, Node 3 has side information Y on sources X_1 and X_2 , which can be controlled via an action A . Action A is selected by Node 3 based on the message received from Node 2 and needs to satisfy a cost constraint of Γ . We derive the set $\mathcal{R}(D_1, D_2, \Gamma)$ of all achievable rates (R_{12}, R_{23}) for given distortion constraints (D_1, D_2) on the reconstructions \hat{X}_1 and \hat{X}_2 at Node 2 and Node 3, respectively, and for cost constraint Γ . This characterization is obtained under the assumption that the side information Y be available causally at Node 3. It is mentioned that, following the submission of this work, the analysis of the case with non-causal side information at Node 3 was carried out in [15].

Notation: For a, b integer with $a \leq b$, we define $[a, b]$ as the interval $[a, a + 1, \dots, b]$ and $x_a^b = (x_a, \dots, x_b)$; if instead $a > b$ we set $[a, b] = \emptyset$ and $x_a^b = \emptyset$. We will also write x_1^b for x^b for simplicity of notation. Random variables are denoted with capital letters and corresponding values with lowercase letters. Given random variables, or more generally vectors, X and Y , we will use the notation $p_X(x)$ or $p(x)$ for $\Pr[X = x]$, and $p_{X|Y}(x|y)$ or $p(x|y)$ for $\Pr[X = x|Y = y]$, where the latter notations are used when the meaning is clear from the context. Given set \mathcal{X} , we define as \mathcal{X}^n the n -fold Cartesian product of \mathcal{X} . Function $\delta(x)$ represents the Kronecker delta function, i.e., $\delta(x) = 1$ if $x = 0$ and $\delta(x) = 0$ otherwise.

II. DISTRIBUTED SOURCE CODING WITH A SIDE INFORMATION VENDING MACHINE

In this section, we first detail the system model for the problem of distributed source coding with a side information vending machine in Sec. II-A. Then, we propose an achievable strategy in Sec. II-B for both the cases with non-causal and causal side information at the decoder. In

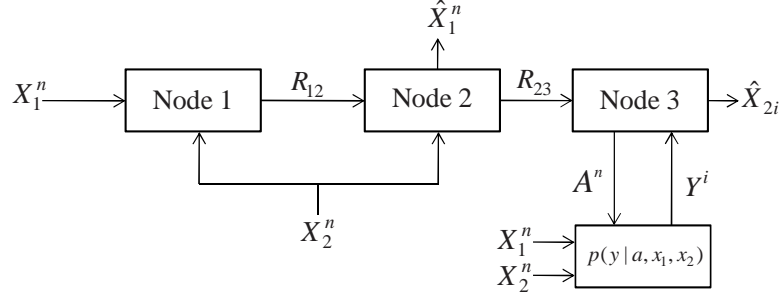

Fig. 3. Cascade source coding with a side information vending machine. Side information is assumed to be available “causally” to the decoder.

Sec. II-C and Sec. II-D scenarios are discussed in which the achievable strategies match given outer bounds. A numerical example is then developed in Sec. II-E.

A. System Model

The problem of distributed lossy source coding with a vending machine and non-causal side information is illustrated in Fig. 2. It is defined by the probability mass functions (pmfs) $p_{X_1 X_2}(x_1, x_2)$ and $p_{Y|AX_1 X_2}(y|a, x_1, x_2)$ and discrete alphabets $\mathcal{X}_1, \mathcal{X}_2, \mathcal{Y}, \mathcal{A}, \hat{\mathcal{X}}_1, \hat{\mathcal{X}}_2$ as follows. The source sequences X_1^n and X_2^n with $X_1^n \in \mathcal{X}_1^n$ and $X_2^n \in \mathcal{X}_2^n$, respectively, are such that the tuples (X_{1i}, X_{2i}) for $i \in [1, n]$ are independent identically distributed (i.i.d.) with joint pmf $p_{X_1 X_2}(x_1, x_2)$. Node 1 measures sequences X_1^n and encodes it into message M_1 of nR_1 bits, while Node 2 measures sequences X_2^n and encodes it into message M_2 of nR_2 bits. Node 3 wishes to reconstruct the two sources within given distortion requirements, to be discussed below, as $\hat{X}_1^n \in \hat{\mathcal{X}}_1^n$ and $\hat{X}_2^n \in \hat{\mathcal{X}}_2^n$.

To this end, Node 3 selects an action sequence A^n , where $A^n \in \mathcal{A}^n$, based on the messages M_1 and M_2 received from Node 1 and Node 2, respectively. The side information sequence Y^n is then realized as the output of a memoryless channel with inputs (A^n, X_1^n, X_2^n) . Specifically, given A^n, X_1^n and X_2^n , the sequence Y^n is distributed as

$$p(y^n|a^n, x_1^n, x_2^n) = \prod_{i=1}^n p_{Y|AX_1 X_2}(y_i|a_i, x_{1i}, x_{2i}). \quad (1)$$

The overall cost of an action sequence a^n is defined by a per-symbol cost function $\Lambda: \mathcal{A} \rightarrow [0, \Lambda_{\max}]$

with $0 \leq \Lambda_{\max} < \infty$, as

$$\Lambda^n(a^n) = \frac{1}{n} \sum_{i=1}^n \Lambda(a_i). \quad (2)$$

The estimated sequences \hat{X}_1^n and \hat{X}_2^n are obtained as a function of both messages M_1 and M_2 and of the side information Y . The estimates \hat{X}_1^n and \hat{X}_2^n are constrained to satisfy distortion constraints defined by two per-symbol distortion measures, namely $d_j(x_1, x_2, y, \hat{x}_j): \mathcal{X}_1 \times \mathcal{X}_2 \times \mathcal{Y} \times \hat{\mathcal{X}}_j \rightarrow [0, D_{\max}]$ for $j = 1, 2$ with $0 \leq D_{\max} < \infty$. Based on such scalar measures, the overall distortion for the estimated sequences \hat{x}_1^n and \hat{x}_2^n is defined as

$$d_j^n(x_1^n, x_2^n, y^n, \hat{x}_j^n) = \frac{1}{n} \sum_{i=1}^n d_j(x_{1i}, x_{2i}, y_i, \hat{x}_{ji}) \text{ for } j = 1, 2. \quad (3)$$

Note that, based on (3), the estimate \hat{X}_j^n for $j = 1, 2$ can be required to be a lossy version of an arbitrary (per-letter) function of both sources X_1^n and X_2^n and of the side information sequence Y^n . A formal description of the operations at encoders and decoder, and of cost and distortion constraints, is presented below for both the cases in which the side information is available causally or non-causally at the decoder.

Definition 1. An $(n, R_1, R_2, D_1, D_2, \Gamma)$ code for the case of *non-casual* side information at Node 3 consists of two source encoders

$$\begin{aligned} g_1: \mathcal{X}_1^n &\rightarrow [1, 2^{nR_1}], \\ \text{and } g_2: \mathcal{X}_2^n &\rightarrow [1, 2^{nR_2}], \end{aligned} \quad (4)$$

which map the sequences X_1^n and X_2^n into messages M_1 and M_2 at Node 1 and Node 2, respectively; an ‘‘action’’ function

$$\ell: [1, 2^{nR_1}] \times [1, 2^{nR_2}] \rightarrow \mathcal{A}^n, \quad (5)$$

which maps the message (M_1, M_2) into an action sequence A^n at Node 3; and two decoding functions

$$h_1: [1, 2^{nR_1}] \times [1, 2^{nR_2}] \times \mathcal{Y}^n \rightarrow \hat{\mathcal{X}}_1^n, \quad (6)$$

$$\text{and } h_2: [1, 2^{nR_1}] \times [1, 2^{nR_2}] \times \mathcal{Y}^n \rightarrow \hat{\mathcal{X}}_2^n, \quad (7)$$

which map the messages M_1 and M_2 , and the side information sequence Y^n into the estimated sequences \hat{X}_1^n and \hat{X}_2^n at Node 3; such that the action cost constraint Γ is satisfied as

$$\frac{1}{n} \sum_{i=1}^n \mathbb{E} [\Lambda(A_i)] \leq \Gamma, \quad (8)$$

and the distortion constraints D_1 and D_2 hold, namely

$$\frac{1}{n} \sum_{i=1}^n \mathbb{E} [d_j(X_{1i}, X_{2i}, Y_i, \hat{X}_{ji})] \leq D_j, \text{ for } j = 1, 2. \quad (9)$$

Definition 2. A $(n, R_1, R_2, D_1, D_2, \Gamma)$ code for the case of *causal* side information at Node 3 is as in Definition 1 with the only difference that, in lieu of (6)-(7), we have the sequence of decoding functions

$$h_{1i}: [1, 2^{nR_1}] \times [1, 2^{nR_2}] \times \mathcal{Y}^i \rightarrow \hat{\mathcal{X}}_{1i}, \quad (10)$$

$$\text{and } h_{2i}: [1, 2^{nR_1}] \times [1, 2^{nR_2}] \times \mathcal{Y}^i \rightarrow \hat{\mathcal{X}}_{2i}, \quad (11)$$

for $i \in [1, n]$, which map the message (M_1, M_2) and the measured sequence Y^i into the i th estimated symbol $\hat{X}_{ji} = h_{ji}(M_1, M_2, Y^i)$ for $j = 1, 2$ at Node 3.

Definition 3. Given a distortion-cost tuple (D_1, D_2, Γ) , a rate pair (R_1, R_2) is said to be achievable for the case with non-causal or causal side information if, for any $\epsilon > 0$ and sufficiently large n , there exists a corresponding $(n, R_1, R_2, D_1 + \epsilon, D_2 + \epsilon, \Gamma + \epsilon)$ code.

Definition 4. The *rate-distortion-cost region* $\mathcal{R}_{NC}(D_1, D_2, \Gamma)$ is defined as the closure of all rate pairs (R_1, R_2) that are achievable with non-causal side information given the distortion-cost tuple (D_1, D_2, Γ) . The rate-distortion-cost region $\mathcal{R}_C(D_1, D_2, \Gamma)$ is similarly defined for the case of casual side information.

B. Achievable Strategies

In this section, we obtain inner bounds to the rate-distortion-cost regions for the cases with non-causal and causal side information.

Proposition 1. *The rate-distortion-cost region with non-causal side information at Node 3 satisfies the inclusion $\mathcal{R}_{NC}(D_1, D_2, \Gamma) \supseteq \mathcal{R}_{NC}^a(D_1, D_2, \Gamma)$, where the region $\mathcal{R}_{NC}^a(D_1, D_2, \Gamma)$ is*

given by the union of the set of all of rate tuples (R_1, R_2) that satisfy the inequalities

$$R_1 \geq I(X_1; V_1|V_2, Q) + I(X_1; U_1|V_1, V_2, U_2, Y, Q) \quad (12a)$$

$$R_2 \geq I(X_2; V_2|V_1, Q) + I(X_2; U_2|V_1, V_2, U_1, Y, Q) \quad (12b)$$

$$\text{and } R_1 + R_2 \geq I(X_1, X_2; V_1, V_2|Q) + I(X_1, X_2; U_1, U_2|V_1, V_2, Y, Q), \quad (12c)$$

for some joint pmfs that factorizes as

$$\begin{aligned} p(q, x_1, x_2, y, v_1, v_2, u_1, u_2, a, \hat{x}_1, \hat{x}_2) &= p(q)p(x_1, x_2)p(v_1, u_1|x_1, q)p(v_2, u_2|x_2, q)\delta(a - a(v_1, v_2, q)) \\ &\quad p(y|a, x_1, x_2)\delta(\hat{x}_1 - \hat{x}_1(u_1, u_2, y, q)) \\ &\quad \delta(\hat{x}_2 - \hat{x}_2(u_1, u_2, y, q)), \end{aligned} \quad (13)$$

with pmfs $p(q)$ and $p(v_1, u_1|x_1, q)$ and $p(v_2, u_2|x_2, q)$ and deterministic functions $a: \mathcal{V}_1 \times \mathcal{V}_2 \times \mathcal{Q} \rightarrow \mathcal{A}$, $\hat{x}_j: \mathcal{U}_1 \times \mathcal{U}_2 \times \mathcal{Y} \times \mathcal{Q} \rightarrow \hat{\mathcal{X}}_j$ for $j = 1, 2$, such that the action and the distortion constraints

$$\mathbb{E}[\Lambda(A)] \leq \Gamma \quad (14a)$$

$$\text{and } \mathbb{E} \left[d_j(X_1, X_2, Y, \hat{X}_j) \right] \leq D_j, \text{ for } j = 1, 2, \quad (14b)$$

hold. Finally, any extreme point of the region $\mathcal{R}_{NC}^a(D_1, D_2, \Gamma)$ can be obtained by limiting the cardinalities of the random variables (V_1, V_2, U_1, U_2) as $|\mathcal{V}_j| \leq |\mathcal{X}_j| + 6$ and $|\mathcal{U}_j| \leq |\mathcal{X}_j| |\mathcal{V}_j| + 5$, for $j = 1, 2$.

Remark 1. If we set $p(y|a, x_1, x_2) = p(y|x_1, x_2)$, so that the side information is action-independent, Proposition 1 reduces to the extension of the Berger-Tung scheme [13] to the Wyner-Ziv set-up studied in [14, Theorem 2]. Moreover, in the special case in which there is only one encoder, the achievable rate coincides with that derived in [1, Theorem 1].

The proof of Proposition 1 follows easily from standard arguments, and thus it is only briefly discussed here. The proposed scheme combines the Berger-Tung distributed source coding strategy [13] and the distributed Wyner-Ziv approach proposed in [14, Theorem II] with the layered two-stage coding scheme that is proved to be optimal in [1] for the special case of a single encoder. Throughout the discussion we neglect the time-sharing variable Q for simplicity. This can be handled in the standard way (see, e.g., [2, Sec. 4.5.3]). The encoding scheme at Node 1 and Node 2 multiplexes two descriptions, which are obtained in two encoding stages. In

the first encoding stage, the distributed source coding strategy of [13], conventionally referred to as the Berger-Tung scheme, is adopted by Node 1 and Node 2 to convey descriptions V_1^n and V_2^n , respectively, to Node 3. In order for the decoder to be able to recover these descriptions the rates R'_1 and R'_2 allocated by Node 1 and Node 2 have to satisfy the conditions [13][2, Chapter 13]

$$R'_1 \geq I(X_1; V_1|V_2) \quad (15a)$$

$$R'_2 \geq I(X_2; V_2|V_1) \quad (15b)$$

$$\text{and } R'_1 + R'_2 \geq I(X_1, X_2; V_1, V_2). \quad (15c)$$

Having decoded the descriptions (V_1^n, V_2^n) , Node 3 selects the action sequence A^n as the per-symbol function $A_i = a(V_{1i}, V_{2i})$ for $i \in [1, n]$. Node 3 thus measures the side information sequence Y^n . The sequences (Y^n, V_1^n, V_2^n) can then be regarded as side information available at the decoder. Therefore, in the second encoding stage, the distributed Wyner-Ziv scheme proposed in [14, Theorem 2] is used to convey the descriptions U_1^n and U_2^n by Node 1 and Node 2, respectively, to Node 3. Note that the fact that sequences (Y^n, V_1^n, V_2^n) are not i.i.d. does not affect the achievability of the rate region derived in [14]. This is because, as shown in [2, Lemma 3.1], the packing lemma leveraged to ensure the correctness of the decoding process applies for an arbitrary distribution of the sequences (Y^n, V_1^n, V_2^n) . In order for the decoder to correctly retrieve the descriptions U_1^n and U_2^n , the rates R''_1 and R''_2 allocated by Node 1 and Node 2 must satisfy the inequalities [14]

$$R''_1 \geq I(X_1; U_1|V_1, V_2, U_2, Y) \quad (16a)$$

$$R''_2 \geq I(X_2; U_2|V_1, V_2, U_1, Y) \quad (16b)$$

$$\text{and } R''_1 + R''_2 \geq I(X_1, X_2; U_1, U_2|V_1, V_2, Y). \quad (16c)$$

Node 1 and Node 2 multiplex the source indices obtained in the two phases and hence the overall rates are $R_1 = R'_1 + R''_1$ and $R_2 = R'_2 + R''_2$. Using these equalities, along with (15) and (16), leads to (12). Finally, the decoder j estimates \hat{X}_j^n with $j = 1, 2$ sample by sample as a function of U_{1i}, U_{2i} and Y_i . The proof of the cardinality bounds follows from standard arguments and is

sketched in Appendix A¹. We now turn to a similar achievable strategy for the case with causal side information.

Proposition 2. *The rate-distortion-cost region with causal side information at Node 3 satisfies the inclusion $\mathcal{R}_C(D_1, D_2, \Gamma) \supseteq \mathcal{R}_C^a(D_1, D_2, \Gamma)$, where the region $\mathcal{R}_C^a(D_1, D_2, \Gamma)$ is given by the union of the set of all of rate tuples (R_1, R_2) that satisfy the inequalities*

$$R_1 \geq I(X_1; U_1 | U_2, Q) \quad (17a)$$

$$R_2 \geq I(X_2; U_2 | U_1, Q) \quad (17b)$$

$$\text{and } R_1 + R_2 \geq I(X_1, X_2; U_1, U_2 | Q), \quad (17c)$$

for some joint pmfs that factorizes as

$$\begin{aligned} p(q, x_1, x_2, y, u_1, u_2, a, \hat{x}_1, \hat{x}_2) &= p(q)p(x_1, x_2)p(u_1|x_1, q)p(u_2|x_2, q)\delta(a - a(u_1, u_2, q)) \\ &\quad p(y|a, x_1, x_2)\delta(\hat{x}_1 - \hat{x}_1(u_1, u_2, y, q)) \\ &\quad \delta(\hat{x}_2 - \hat{x}_2(u_1, u_2, y, q)), \end{aligned} \quad (18)$$

with pmfs $p(q)$, $p(u_1|x_1, q)$ and $p(u_2|x_2, q)$ and deterministic functions $a: \mathcal{U}_1 \times \mathcal{U}_2 \times \mathcal{Q} \rightarrow \mathcal{A}$ and $\hat{x}_j: \mathcal{U}_1 \times \mathcal{U}_2 \times \mathcal{Y} \times \mathcal{Q} \rightarrow \hat{\mathcal{X}}_j$ for $j = 1, 2$, such that the action and the distortion constraints (14a)-(14b) hold, respectively. Finally, any extreme point in the region $\mathcal{R}_C^a(D_1, D_2, \Gamma)$ can be obtained by constraining the cardinalities of random variables (U_1, U_2) as $|\mathcal{U}_1| \leq |\mathcal{X}_1| + 5$ and $|\mathcal{U}_2| \leq |\mathcal{X}_2| + 5$.

The proof follows by similar arguments as the ones in the proof of Proposition 1 with the only difference that only one stage of encoding is sufficient. Specifically, as in Proposition 1, Berger-Tung coding is adopted to convey the descriptions U_1^n and U_2^n to Node 3. Note that, with causal side information, there is no advantage in having a second encoding stage, since the side information sequence cannot be leveraged for binning in contrast to the case with non-causal side information [3][2, Chapter 12]. The cardinality bounds follow from arguments similar to Appendix A.

¹It is noted that, using the approach of [16], it may be possible to improve the cardinality bounds. This aspect is not further explored here.

C. Degraded Source Sets and Causal Side Information

In this section, we consider the special case in which the sequence observed by Node 2 is a symbol-by-symbol function of the source observed at Node 1 [17, Sec. V.] (see also [18]). In other words, we can write $X_{1i} = (X'_{1i}, X_{2i})$ for $i \in [1, n]$, where X_1^n is an i.i.d. sequence independent of X_2^n . We refer to this set-up as having *degraded source sets*. Moreover, we assume that the side information Y is available causally at Node 3. The next proposition proves that the achievable strategy of Proposition 2 is optimal in this case.

Proposition 3. *The rate-distortion-cost region $\mathcal{R}_C(D_1, D_2, \Gamma)$ for the set-up with degraded source sets and with causal side information at Node 3 satisfies $\mathcal{R}_C(D_1, D_2, \Gamma) = \mathcal{R}_C^a(D_1, D_2, \Gamma)$.*

Remark 2. *Proposition 3 generalizes to the case with action-dependent side information the result in [17, Sec. V] for the case with no side information.*

For the proof of converse, we refer the reader to Appendix B.

D. One-Distortion Criterion and Non-Causal Side Information

In this section, we consider a variation on the set-up of source coding with action-dependent non-causal side information described in Definition 1. Specifically, Node 3 selects the action sequence A^n based only on the message M_1 received from Node 1. In other words, the action function (5) is modified to

$$\ell: [1, 2^{nR_1}] \rightarrow \mathcal{A}^n, \quad (19)$$

which maps the message M_1 into an action sequence A^n at Node 3. This may be the case in scenarios in which there is a hierarchy between Node 1 and Node 2, e.g., in a sensor network, and the functionality of remote control of the side information is assigned solely to Node 1. The next proposition characterizes the rate-distortion-cost function $\mathcal{R}_{NC}(D_1, 0, \Gamma)$ under the mentioned assumption when Hamming distortion is selected for \hat{X}_2 . That is, we choose the distortion measure $d_2(x_2, \hat{x}_2)$ as $d_H(x_2, \hat{x}_2) = 0$ if $x_2 = \hat{x}_2$ and $d_H(x_2, \hat{x}_2) = 1$ otherwise. This implies that we impose the constraint of vanishingly small per-symbol Hamming distortion between source X_2^n and estimate \hat{X}_2^n , or equivalently the constraint $\frac{1}{n} \sum_{i=1}^n \Pr[\hat{X}_{2i} \neq X_{2i}] \rightarrow 0$ for $n \rightarrow \infty$. We will refer to this assumption by saying that source sequence X_2^n must be recovered losslessly at the decoder.

Proposition 4. *If the action function is given by (19) and X_2^n must be recovered losslessly at Node 3, the rate-distortion-cost region $\mathcal{R}_{NC}(D_1, 0, \Gamma)$ is given by union of the set of all of rate tuples (R_1, R_2) that satisfy the inequalities*

$$R_1 \geq I(X_1; A|Q) + I(X_1; U_1|A, X_2, Y, Q) \quad (20a)$$

$$R_2 \geq H(X_2|A, Y, V, Q) \quad (20b)$$

$$\text{and } R_1 + R_2 \geq I(X_1; A|Q) + H(X_2|A, Y, Q) + I(X_1; U_1|A, X_2, Y, Q), \quad (20c)$$

for some joint pmfs that factorizes as

$$p(q, x_1, x_2, y, u_1, a, \hat{x}_1) = p(q)p(x_1, x_2)p(a, u_1|x_1, q)p(y|a, x_1, x_2)\delta(\hat{x}_1 - \hat{x}_1(u_1, y, q)), \quad (21)$$

with pmfs $p(q)$ and $p(a, u_1|x_1, q)$ and deterministic function $\hat{x}_1(u_1, y, q)$, such that the action and the distortion constraints

$$\mathbb{E}[\Lambda(A)] \leq \Gamma \quad (22a)$$

$$\text{and } \mathbb{E}\left[d_1(X_1, X_2, Y, \hat{X}_1)\right] \leq D_1 \quad (22b)$$

hold. Finally, Q and U_1 are auxiliary random variables whose alphabet cardinality can be constrained as $|Q| \leq 6$ and $|U_1| \leq 6|\mathcal{X}_1||\mathcal{A}| + 3$ without loss of optimality.

Remark 3. *In the case in which there is no side information, Proposition 4 reduces to [19, Theorem 1].*

For the proof of converse, we refer the reader to Appendix C. The achievability follows from Proposition 1 by setting $V_2 = \emptyset$, $V_1 = A$ and $U_2 = X_2$.

Remark 4. *Extension of the result in Proposition to an arbitrary number K of encoders can be found in [20].*

E. A Binary Example

We now focus on a specific numerical example in order to illustrate the result derived in Proposition 1 and Proposition 4 and the advantage of selecting actions at Node 3 based on the message received from one of the nodes. Specifically, we assume that all alphabets are binary and that (X_1, X_2) is a doubly symmetric binary source (DSBS) characterized by probability p , with

$0 \leq p \leq 1/2$, so that $p(x_1) = p(x_2) = 1/2$ for $x_1, x_2 \in \{0, 1\}$ and $\Pr[X_1 \neq X_2] = p$. Moreover, we adopt Hamming distortion for both sources to reconstruct both X_1 and X_2 losslessly in the sense discussed above. Note that, this implies that we set $d_1(x_1, x_2, y, \hat{x}_1) = d_H(x_1, \hat{x}_1)$ and $D_1 = 0$. The side information Y_i is such that

$$Y_i = \begin{cases} f(X_{1i}, X_{2i}) & \text{if } A_i = 1 \\ 1 & \text{if } A_i = 0 \end{cases}, \quad (23)$$

where $f(x_1, x_2)$ is a deterministic function to be specified. Therefore, when action $A_i = 1$ is selected, then $Y_i = f(X_{1i}, X_{2i})$ is measured at the receiver, while with $A_i = 0$ no useful information is collected by the decoder. The action sequence A^n must satisfy the cost constraint (8), where the cost function is defined as $\Lambda(A_i) = 1$ if $A_i = 1$ and $\Lambda(A_i) = 0$ if $A_i = 0$. It follows that, given (23), a cost Γ implies that the decoder can observe $f(X_{1i}, X_{2i})$ only for at most $n\Gamma$ symbols. As for the function $f(x_1, x_2)$, we consider two cases, namely $f(x_1, x_2) = x_1 \oplus x_2$, where \oplus is the binary sum and $f(x_1, x_2) = x_1 \odot x_2$, where \odot is the binary product. We assume that the side information is available non-causally at the decoder.

To start with, observe that the sum-rate is a non-increasing function of the action cost Γ and hence the minimum sum-rate is obtained when $\Gamma = 1$. With $\Gamma = 1$, it is clearly optimal to set $A = 1$, irrespective of the value of X_1 . In this case, from the Slepian-Wolf theorem, the sum rate equals $R_{sum}(1) = H(X_1, X_2|Y)$. Specifically, with sum side information we get

$$R_{sum}^{\oplus}(1) = 1, \quad (24)$$

since we have $R_{sum}^{\oplus}(1) = H(X_1, X_2|X_1 \oplus X_2) = H(X_1|X_1 \oplus X_2) = H(X_1)$, where the second equality follows from the chain rule and the second from the crypto-lemma [21, Lemma 2]. Instead, with product side information, we obtain

$$R_{sum}^{\odot}(1) = H\left(\frac{1-p}{1+p}, \frac{p}{1+p}, \frac{p}{1+p}\right) \left(\frac{1+p}{2}\right), \quad (25)$$

where we have used the definition $H(p_1, p_2, \dots, p_k) = -\sum_{i=1}^k p_i \log_2 p_i$. Equation (25) follows since

$$\begin{aligned} R_{sum}^{\odot}(1) &= H(X_1, X_2|X_1 \odot X_2) \\ &= H(X_1, X_2|X_1 \odot X_2 = 0) \Pr[X_1 \odot X_2 = 0], \end{aligned} \quad (26)$$

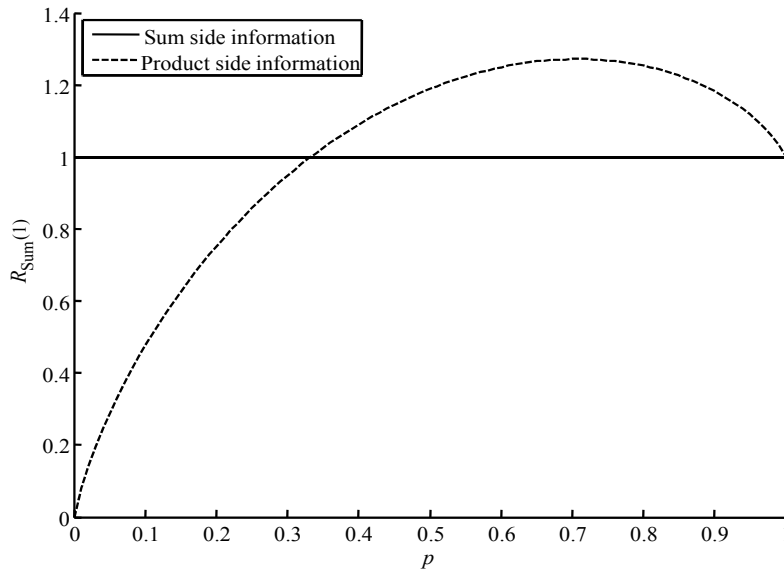

Fig. 4. Sum-rates versus p for sum and product side informations ($\Gamma = 1$).

where the second equality is a consequence of the fact that $X_1 \odot X_2 = 1$ implies that $X_1 = 1$ and $X_2 = 1$. Sum-rate (25) is then obtained by evaluating (26) for the DSBS at hand. Fig. 4 shows the sum-rates (24) and (25), demonstrating that, if p is sufficiently small, namely if $p \lesssim 0.33$, we have $R_{sum}^{\odot}(1) < R_{sum}^{\oplus}(1)$ and thus product side information is more informative than the sum, while for $p \gtrsim 0.33$ the opposite is true (and for $p = 1$, they are equally informative).

Considering a general cost budget $0 \leq \Gamma \leq 1$, in order to emphasize the role of both data and control information for the system performance, we now evaluate the sum-rate attainable by imposing that the action A be selected by Node 3 a priori, that is, without any control from Node 1. This can be easily seen to be given by [1]

$$\begin{aligned} R_{sum, greedy}(\Gamma) &= \Gamma H(X_1, X_2|Y) + (1 - \Gamma)H(X_1, X_2) \\ &= \Gamma H(X_1, X_2|Y) + (1 - \Gamma)(1 + H(p)). \end{aligned} \quad (27)$$

This sum-rate will be compared below with the performance of the scheme in Proposition 1, in which the actions are selected based on both messages (M_1, M_2) , and that of Proposition 4, in which the actions are selected based only on message M_1 .

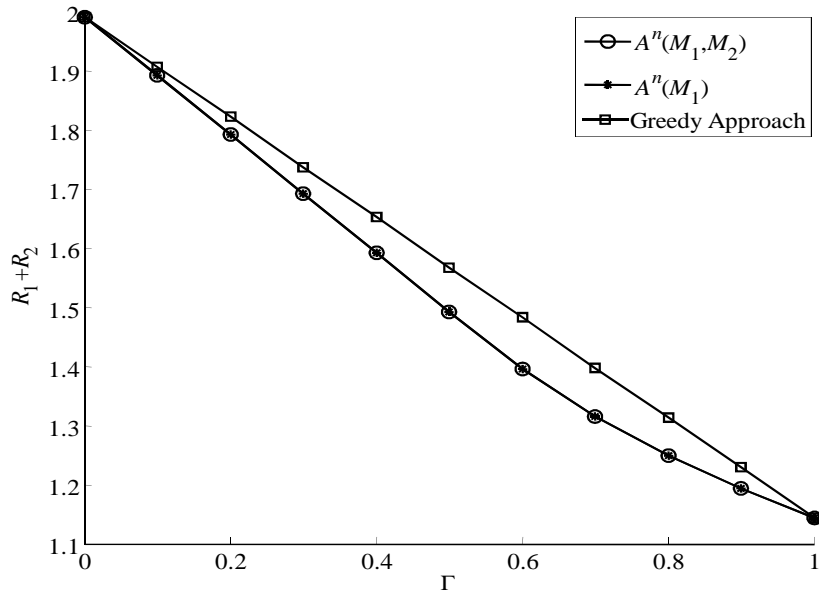

Fig. 5. Sum-rates versus the action cost Γ for product side information ($p = 0.45$).

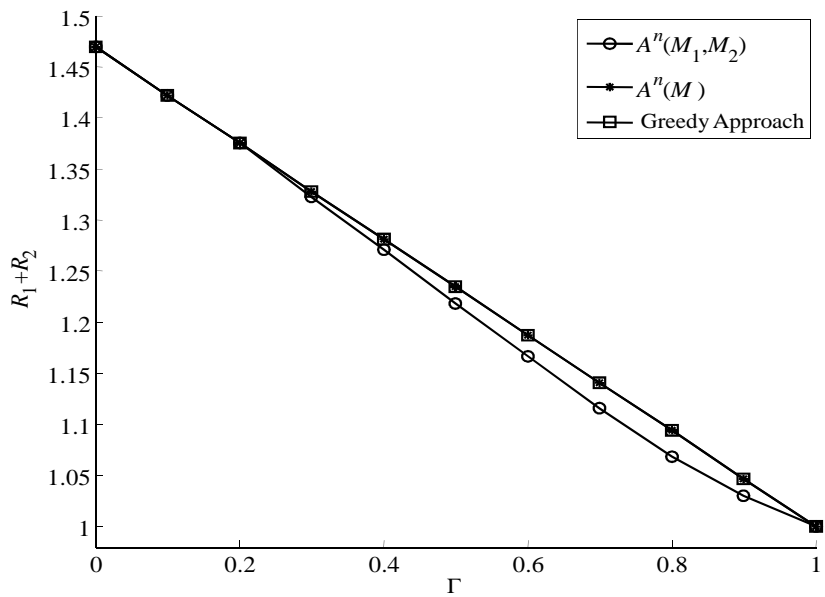

Fig. 6. Sum-rates versus the action cost Γ for sum side information ($p = 0.1$).

Fig. 5 depicts the mentioned sum-rates² versus the action cost Γ for $p = 0.45$ and product side

²The sum-rate from Proposition 1 is calculated by assuming binary auxiliary variables V_1 and V_2 and performing global optimization.

information. It can be seen that the greedy approach suffers from a significant performance loss with respect to the approaches in which actions are selected based on the messages received from one encoder or both encoders. It can be also observed that no gains are obtained by selecting the actions based on both messages. The fact that choosing the action based on the message received from Node 1 provides performance benefits can be explained as follows. If $X_1 = 0$, the value of the side information is always $Y = X_1 \odot X_2 = 0$ irrespective of the value of X_2 . Therefore, if $X_1 = 0$, the side information is less informative than if $X_1 = 1$ and hence it may be advantageous to save on the action cost by setting $A = 0$. Consequently, choosing actions based on the message received from Node 1 can result in a lower sum-rate.

The scenario with sum side information is considered in Fig. 6 for $p = 0.1$. A first observation is that, as proved in Appendix D, choosing the action based only on M_1 cannot improve the sum-rate with respect to the greedy case. This contrasts with the product side information case, and is due to the fact that X_1 is independent of the side information Y . Instead, choosing the actions based on both messages allows to save on the necessary communication sum-rate.

III. CASCADE SOURCE CODING WITH A SIDE INFORMATION VENDING MACHINE

In this section, we first describe the system model for the setting of Fig. 3 of cascade source coding with a side information vending machine. We recall that side information Y is here assumed to be available causally at the decoder (Node 3). The corresponding model with non-causal side information is studied in [15]. We then present the characterization of the corresponding rate-distortion-cost performance in Sec. III-B.

A. System Model

The problem of cascade lossy computing with causal observation costs at second user, illustrated in Fig. 3, is defined by the pmfs $p_{X_1 X_2}(x_1, x_2)$ and $p_{Y|AX_1 X_2}(y|a, x_1, x_2)$ and discrete alphabets $\mathcal{X}_1, \mathcal{X}_2, \mathcal{Y}, \mathcal{A}, \hat{\mathcal{X}}_1, \hat{\mathcal{X}}_2$, as follows. The source sequences X_1^n and X_2^n with $X_1^n \in \mathcal{X}_1^n$ and $X_2^n \in \mathcal{X}_2^n$, respectively, are such that the pairs (X_{1i}, X_{2i}) for $i \in [1, n]$ are i.i.d. with joint pmf $p_{X_1 X_2}(x_1, x_2)$. Node 1 measures sequences X_1^n and X_2^n and encodes them in a message M_{12} of nR_{12} bits, which is delivered to Node 2. Node 2 estimates a sequence $\hat{X}_1^n \in \hat{\mathcal{X}}_1^n$ within given distortion requirements to be discussed below. Moreover, Node 2 encodes the message M_{12} , received from Node 1, and the locally available sequence X_2^n in a message M_{23} of nR_{23}

bits, which is delivered to node 3. Node 3 wishes to estimate a sequence $\hat{X}_2^n \in \hat{\mathcal{X}}_2^n$ within given distortion requirements to be discussed. To this end, Node 3 receives message M_{23} and based on this, selects an action sequence A^n , where $A^n \in \mathcal{A}^n$. The action sequence affects the quality of the measurement Y^n of sequence X_1^n and X_2^n obtained at the Node 3. Specifically, given A^n , X_1^n and X_2^n , the sequence Y^n is distributed as in (1). The cost of the action sequence is defined by a cost function $\Lambda: \mathcal{A} \rightarrow [0, \Lambda_{\max}]$ with $0 \leq \Lambda_{\max} < \infty$, as in (2). The estimated sequence \hat{X}_2^n with $\hat{X}_2^n \in \hat{\mathcal{X}}_2^n$ is then obtained as a function of M_{23} and Y^n .

Estimated sequences \hat{X}_j^n for $j = 1, 2$ must satisfy distortion constraints defined by functions $d_j(x_1, x_2, y, \hat{x}_j): \mathcal{X}_1 \times \mathcal{X}_2 \times \mathcal{Y} \times \hat{\mathcal{X}}_j \rightarrow [0, D_{\max}]$ with $0 \leq D_{\max} < \infty$ for $j = 1, 2$, respectively. A formal description of the operations at encoder and decoder follows.

Definition 5. An $(n, R_{12}, R_{23}, D_1, D_2, \Gamma)$ code for the set-up of Fig. 3 consists of two source encoders, namely

$$g_1: \mathcal{X}_1^n \times \mathcal{X}_2^n \rightarrow [1, 2^{nR_{12}}], \quad (28)$$

which maps the sequences X_1^n and X_2^n into a message M_{12} ;

$$g_2: \mathcal{X}_2^n \times [1, 2^{nR_{12}}] \rightarrow [1, 2^{nR_{23}}] \quad (29)$$

which maps the sequence X_2^n and message M_{12} into a message M_{23} ; an ‘‘action’’ function

$$\ell: [1, 2^{nR_{23}}] \rightarrow \mathcal{A}^n, \quad (30)$$

which maps the message M_{23} into an action sequence A^n ; a decoding function

$$h_1: [1, 2^{nR_{12}}] \times \mathcal{X}_2^n \rightarrow \hat{\mathcal{X}}_1^n, \quad (31)$$

which maps the message M_{12} and the measured sequence X_2^n into the estimated sequence \hat{X}_1^n ; and a sequence of decoding functions

$$h_{2i}: [1, 2^{nR_{23}}] \times \mathcal{Y}^i \rightarrow \hat{\mathcal{X}}_2, \quad (32)$$

for $i \in [1, n]$ which maps the message M_{23} and the measured sequence Y^i into the i th estimated symbol $\hat{X}_{2i} = h_{2i}(M_{23}, Y^i)$; such that the action cost constraint Γ and distortion constraints D_j

for $j = 1, 2$ are satisfied, i.e.,

$$\frac{1}{n} \sum_{i=1}^n \mathbb{E} [\Lambda(A_i)] \leq \Gamma \quad (33)$$

$$\text{and } \frac{1}{n} \sum_{i=1}^n \mathbb{E} [d_j(X_{1i}, X_{2i}, Y_i, \hat{X}_{ji})] \leq D_j \text{ for } j = 1, 2, \quad (34)$$

respectively.

Definition 6. Given a distortion-cost tuple (D_1, D_2, Γ) , a rate tuple (R_{12}, R_{23}) is said to be achievable if, for any $\epsilon > 0$, and sufficiently large n , there exists a $(n, R_{12}, R_{23}, D_1 + \epsilon, D_2 + \epsilon, \Gamma + \epsilon)$ code.

Definition 7. The rate-distortion-cost region $\mathcal{R}(D_1, D_2, \Gamma)$ is defined as the closure of all rate tuples (R_{12}, R_{23}) that are achievable given the distortion-cost tuple (D_1, D_2, Γ) .

Remark 5. For side information Y independent of the action A given X_1 and X_2 , i.e., for $p(y|a, x_1, x_2) = p(y|x_1, x_2)$, the rate-distortion region $\mathcal{R}(D_1, D_2, \Gamma)$ has been derived in [22].

B. Rate-Distortion-Cost Region

We have the following characterization of the rate-distortion-cost region.

Proposition 5. The rate-distortion-cost region $\mathcal{R}(D_1, D_2, \Gamma)$ for the set-up of Fig. 3 is given by the union of all rate pairs (R_{12}, R_{23}) satisfying the inequalities

$$R_{12} \geq I(X_1; U, A, \hat{X}_1 | X_2) \quad (35a)$$

$$\text{and } R_{23} \geq I(X_1, X_2; U, A), \quad (35b)$$

for some joint pmf that factorizes as

$$p(x_1, x_2, y, a, u, \hat{x}_1, \hat{x}_2) = p(x_1, x_2)p(a, u, \hat{x}_1 | x_1, x_2)p(y|a, x_1, x_2) \cdot \delta(\hat{x}_2 - \hat{x}_2(u, y)), \quad (36)$$

with pmf $p(a, u, \hat{x}_1 | x_1, x_2)$ and deterministic function $\hat{x}_2(u, y)$, such that the action and the distortion constraints

$$\mathbb{E} [\Lambda(A)] \leq \Gamma \quad (37)$$

$$\text{and } \mathbb{E}[d_j(X_1, X_2, Y, \hat{X}_j)] \leq D_j, \text{ for } j = 1, 2, \quad (38)$$

respectively, hold. Finally, U is an auxiliary random variable whose alphabet cardinality can be constrained as $|\mathcal{U}| \leq |\mathcal{X}_1| |\mathcal{X}_2| + 4$, without loss of optimality.

Remark 6. If $p(y|a, x_1, x_2) = p(y|x_1, x_2)$, Proposition 5 reduces to [22, Theorem 1].

The proof of converse is provided in Appendix E. The coding strategy that proves achievability is a combination of the techniques proposed in [1] and [22, Theorem 1]. Here we briefly outline the main ideas, since the technical details follow from standard arguments. In the scheme at hand, Node 1 first maps sequences X_1^n and X_2^n into the action sequence A^n and an auxiliary codeword U^n using the standard joint typicality criterion. This mapping operation requires a codebook of rate $I(X_1, X_2; U, A)$ (see, e.g., [2, Chapter 3]). Then, given the so obtained sequences A^n and U^n , source sequences X_1^n and X_2^n are further mapped into the estimate \hat{X}_1^n for Node 2 so that the sequences $(X_1^n, X_2^n, A^n, U^n, \hat{X}_1^n)$ are jointly typical. This requires rate $I(X_1, X_2; \hat{X}_1|U, A)$ [2, Chapter 3]. Leveraging the side information X_2^n available at Node 2, conveying the codewords A^n , \hat{X}_1^n and U^n to Node 2 requires rate $I(X_1, X_2; U, A) + I(X_1, X_2; \hat{X}_1|U, A) - I(U, A, \hat{X}_1; X_2)$ [2, Chapter 12], which equals the right-hand side of (35a). Node 2 conveys U^n and A^n to Node 3 by simply forwarding the index received from Node 1 (of rate $I(X_1, X_2; U, A)$). Finally, Node 3 estimates \hat{X}_2^n through a symbol-by-symbol function as $\hat{X}_{2i} = \hat{x}_2(U_i, Y_i)$ for $i \in [1, n]$.

IV. CONCLUDING REMARKS

In the setting of source coding with a side information vending machine introduced in [1], the decoder can control the quality of the side information through a control, or action, sequence that is selected based on the message encoded by the source node. Since this message must also carry information directly related to the source to be reproduced at the decoder, a key aspect of the model is the interplay between encoding data and control information.

In this work, we have generalized the original work [1] to two standard multiterminal scenarios, namely distributed source coding and cascade source coding. For the former, we obtained inner bounds to the rate-distortion-cost regions for the cases with non-causal and causal side information at the decoder. These bounds have been found to be tight in two special cases. We have also provided some numerical example to shed some light on the advantages of an optimized trade-off between data and control transmission. As for the cascade source coding problem, a single-letter characterizations of achievable rate-distortion-cost trade-offs has been

derived under the assumption of causal side information at the decoder.

A number of open problems have been left unsolved by this work, including the identification of more general conditions under which the inner bounds of Proposition 1 and Proposition 2 are tight. The technical challenges that we have faced in this task are related to the well-known issues that arise when identifying auxiliary random variables that satisfy the desired Markov chain conditions in distributed source coding problems (see, e.g., [2, Chapter 13]).

APPENDIX A

Using standard inequalities, it can be seen that the rate region (12) evaluated with a constant Q is a contra-polymatroid, as the Berger-Tung region (17) (see e.g., [23]). Moreover, the role of the variable Q is that of performing the convexification of the union of all regions of tuples $(R_1, R_2, D_1, D_2, \Gamma)$ that satisfy (12) and (14) for some fixed Q . It follows from [23] that every extreme point of region of achievable tuples $(R_1, R_2, D_1, D_2, \Gamma)$ satisfies the equations

$$R_1 = I(X_1; V_1|V_2) + I(X_1; U_1|U_2, V_1, V_2, Y) \quad (39a)$$

$$R_2 = I(X_2; V_2) + I(X_2; U_2|V_1, V_2, Y) \quad (39b)$$

along with (14), where both relationships are satisfied with equality, or

$$R_1 = I(X_1; V_1) + I(X_1; U_1|V_1, V_2, Y) \quad (40a)$$

$$R_2 = I(X_2; V_2|V_1) + I(X_2; U_2|U_1, V_1, V_2, Y) \quad (40b)$$

along with (14) satisfied with equality. Applying the Fenchel–Eggleston–Caratheodory theorem to the right-hand side of the equations above and to (14) concludes the proof (See [2, Appendix C] and [13]).

APPENDIX B

PROOF OF THE CONVERSE FOR PROPOSITION 3

In this section, the proof of converse for Proposition 3 is given. For any $(n, R_1, R_2, D_1 + \epsilon, D_2 + \epsilon, \Gamma + \epsilon)$ code, we have the following inequalities:

$$\begin{aligned}
nR_1 &\geq H(M_1) \geq H(M_1|M_2) \\
&\stackrel{(a)}{=} I(M_1; X_1^n, X_2^n|M_2) \\
&= \sum_{i=1}^n H(X_{1i}, X_{2i}|X_1^{i-1}, X_2^{i-1}, M_2) - H(X_{1i}, X_{2i}|X_1^{i-1}, X_2^{i-1}, M_1, M_2) \\
&\stackrel{(b)}{=} \sum_{i=1}^n H(X_{1i}, X_{2i}|X_1^{i-1}, X_2^{i-1}, M_2) - H(X_{1i}, X_{2i}|X_1^{i-1}, X_2^{i-1}, M_1, M_2, Y^{i-1}) \\
&\stackrel{(c)}{\geq} \sum_{i=1}^n H(X_{1i}, X_{2i}|X_1^{i-1}, X_2^{i-1}, M_2, Y^{i-1}) - H(X_{1i}, X_{2i}|X_1^{i-1}, X_2^{i-1}, M_1, M_2, Y^{i-1}) \\
&\stackrel{(d)}{=} \sum_{i=1}^n I(X_{1i}, X_{2i}; U_{1i}|U_{2i}),
\end{aligned}$$

where (a) follows because M_1 is a function of (X_1^n, X_2^n) given that X_2^n is a function of X_1^n by assumption; (b) follows since $(X_{1i}, X_{2i})|(X_1^{i-1}, X_2^{i-1}, M_1, M_2)|Y^{i-1}$ forms a Markov chain; (c) follows by the fact that conditioning decreases entropy; and (d) follows by defining $U_{ji} = (X_1^{i-1}, X_2^{i-1}, Y^{i-1}, M_j)$ for $j = 1, 2$. We also have a similar chain of inequalities for R_2 . As for the sum-rate $R_1 + R_2$, we have

$$\begin{aligned}
n(R_1 + R_2) &\geq H(M_1, M_2) \\
&\stackrel{(a)}{=} I(M_1, M_2; X_1^n, X_2^n) \\
&= \sum_{i=1}^n H(X_{1i}, X_{2i}|X_1^{i-1}, X_2^{i-1}) - H(X_{1i}, X_{2i}|X_1^{i-1}, X_2^{i-1}, M_1, M_2) \\
&\stackrel{(b)}{=} \sum_{i=1}^n H(X_{1i}, X_{2i}|X_1^{i-1}, X_2^{i-1}) - H(X_{1i}, X_{2i}|X_1^{i-1}, X_2^{i-1}, M_1, M_2, Y^{i-1}) \\
&\stackrel{(c)}{\geq} \sum_{i=1}^n I(X_{1i}, X_{2i}; U_{1i}, U_{2i}),
\end{aligned}$$

where (a) follows because (M_1, M_2) are functions of (X_1^n, X_2^n) ; (b) follows since $(X_{1i}, X_{2i})|(X_1^{i-1}, X_2^{i-1}, M_1, M_2)|Y^{i-1}$ forms a Markov chain; and (c) follows using the definition of U_{ji} for $j = 1, 2$. Next, let Q be a uniform random variable over the interval $[1, n]$ and independent of $(X_1^n, X_2^n, U_1^n, U_2^n, Y^n)$ and define $U_j \triangleq (Q, U_{jQ})$, for $j = 1, 2$, $X_1 \triangleq X_{1Q}$, $X_2 \triangleq X_{2Q}$, $Y \triangleq Y_Q$.

Note that \hat{X}_j is a function of U_1, U_2 and Y for $j = 1, 2$. Moreover, from (8) and (9), we have

$$\Gamma + \epsilon \geq \frac{1}{n} \sum_{i=1}^n \mathbb{E}[\Lambda(A_i)] = \mathbb{E}[\Lambda(A)] \quad (41)$$

$$\text{and } D_j + \epsilon \geq \frac{1}{n} \sum_{i=1}^n \mathbb{E} \left[d_j(X_{1i}, X_{2i}, Y_i, \hat{X}_{ji},) \right] = \mathbb{E}[d_1(X_1, X_2, Y, \hat{X}_j)], \text{ for } j = 1, 2. \quad (42)$$

APPENDIX C

PROOF OF THE CONVERSE FOR PROPOSITION 4

In this section, the proof of converse for Proposition 4 is given. Fix a code $(n, R_1, R_2, D_1 + \epsilon, \epsilon, \Gamma)$ for an $\epsilon > 0$, whose existence for all sufficiently large n is required by the definition of achievability.

From the distortion constraint for \hat{X}_2 , we have the inequality

$$\epsilon \geq \frac{1}{n} \sum_{i=1}^n \mathbb{E}[d_H(X_{2i}, \hat{X}_{2i})] \stackrel{(a)}{=} \frac{1}{n} \sum_{i=1}^n p_{e,2i}, \quad (43)$$

where we have defined $p_{e,2i} = \Pr[X_{2i} \neq \hat{X}_{2i}]$, and (a) follows from the definition of the metric $d_H(x, \hat{x})$ as the Hamming distortion. Moreover, we also have the following chain of inequalities

$$\begin{aligned} H(X_2^n | \hat{X}_2^n) &\stackrel{(a)}{\leq} \sum_{i=1}^n H(X_{2i} | \hat{X}_{2i}) \stackrel{(b)}{\leq} \sum_{i=1}^n H(p_{e,i}) + p_{e,i} \log |\mathcal{X}_{2i}| \\ &\stackrel{(c)}{\leq} nH \left(\frac{1}{n} \sum_{i=1}^n p_{e,i} \right) + n \left(\frac{1}{n} \sum_{i=1}^n p_{e,i} \right) \log |\mathcal{X}_{2i}| \\ &\stackrel{(d)}{\leq} nH(\epsilon) + n\epsilon \log |\mathcal{X}_{2i}| \\ &\triangleq n\delta(\epsilon), \end{aligned} \quad (44)$$

where (a) follows by conditioning reduces entropy; (b) follows by Fano's inequality; (c) follows by Jensen's inequality; and (d) follows by (43), where $\delta(\epsilon) \rightarrow 0$ as $\epsilon \rightarrow 0$. Note that, in the following, we use the convention in [2, Chapter 3] of defining as $\delta(\epsilon)$ any function such that $\delta(\epsilon) \rightarrow 0$ as $\epsilon \rightarrow 0$.

For rate R_1 , we then have the following series of inequalities

$$\begin{aligned}
nR_1 &\geq H(M_1) \stackrel{(a)}{=} H(M_1, A^n) \\
&= H(A^n) + H(M_1|A^n) \\
&\stackrel{(b)}{\geq} H(A^n) - H(A^n|X_1^n, X_2^n) + H(M_1|A^n, Y^n, X_2^n) - H(M_1|A^n, Y^n, X_1^n, X_2^n) \\
&= I(A^n; X_1^n, X_2^n) + I(M_1; X_1^n|A^n, Y^n, X_2^n) \\
&= I(A^n; X_1^n, X_2^n) + H(X_1^n|A^n, Y^n, X_2^n) - H(X_1^n|A^n, Y^n, X_2^n, M_1) \\
&= H(X_1^n, X_2^n) - H(X_1^n, X_2^n|A^n) + H(X_1^n, X_2^n, Y^n|A^n) - H(Y^n, X_2^n|A^n) \\
&\quad - H(X_1^n|A^n, Y^n, X_2^n, M_1) \\
&= H(X_1^n, X_2^n) + H(Y^n|A^n, X_1^n, X_2^n) - H(Y^n, X_2^n|A^n) \\
&\quad - H(X_1^n|A^n, Y^n, X_2^n, M_1), \tag{45}
\end{aligned}$$

where (a) follows because A^n is a function of M_1 and (b) follows because entropy is non-negative and conditioning decreases entropy. For the first three terms in (45) we have

$$\begin{aligned}
&H(X_1^n, X_2^n) + H(Y^n|A^n, X_1^n, X_2^n) - H(Y^n, X_2^n|A^n) \\
&= H(X_1^n, X_2^n) + H(Y^n|A^n, X_1^n, X_2^n) - H(Y^n|A^n) - H(X_2^n|A^n, Y^n) \\
&\stackrel{(a)}{=} \sum_{i=1}^n H(X_{1i}, X_{2i}) + H(Y_i|Y^{i-1}, A^n, X_1^n, X_2^n) - H(Y_i|Y^{i-1}, A^n) - H(X_{2i}|X_2^{i-1}, A^n, Y^n) \\
&\stackrel{(b)}{\geq} \sum_{i=1}^n H(X_{1i}, X_{2i}) + H(Y_i|A_i, X_{1i}, X_{2i}) - H(Y_i|A_i) - H(X_{2i}|A_i, Y_i) \\
&= \sum_{i=1}^n H(X_{1i}, X_{2i}) - I(Y_i; X_{1i}, X_{2i}|A_i) - H(X_{2i}|A_i, Y_i) \\
&= \sum_{i=1}^n H(X_{1i}, X_{2i}) - H(X_{1i}, X_{2i}|A_i) + H(X_{1i}, X_{2i}|A_i, Y_i) - H(X_{2i}|A_i, Y_i) \\
&= \sum_{i=1}^n I(X_{1i}, X_{2i}; A_i) + H(X_{1i}|A_i, Y_i, X_{2i}), \tag{46}
\end{aligned}$$

where (a) follows by the chain rule for entropy and the fact that X_1^n, X_2^n are i.i.d. and (b) follows since $Y_i|(A_i, X_{1i}, X_{2i})|(Y^{i-1}, A^{n \setminus i}, X_1^{n \setminus i}, X_2^{n \setminus i})$ forms a Markov chain, by the definition of problem, and since conditioning reduces entropy.

Combining (45) and (46), and defining $U_{1i} = (A^{n \setminus i}, Y^{n \setminus i}, X_2^{n \setminus i}, M_1)$, we obtain

$$\begin{aligned}
nR_1 &\stackrel{(a)}{\geq} \sum_{i=1}^n I(X_{1i}, X_{2i}; A_i) + H(X_{1i}|A_i, Y_i, X_{2i}) \\
&\quad - H(X_{1i}|X_1^{i-1}, A^n, Y^n, X_2^n, M_1) \\
&\stackrel{(b)}{\geq} \sum_{i=1}^n I(X_{1i}; A_i) + H(X_{1i}|A_i, Y_i, X_{2i}) - H(X_{1i}|A^n, Y^n, X_2^n, M_1) \\
&\stackrel{(c)}{=} \sum_{i=1}^n (X_{1i}; A_i) + I(X_{1i}; U_{1i}|A_i, Y_i, X_{2i}), \tag{47}
\end{aligned}$$

where (a) follows by the chain rule for entropy; (b) follows because mutual information is non-negative and due to the fact that conditioning decreases entropy; and (c) follows by the definition of mutual information and definition of U_{1i} .

Next, we consider the rate R_2 . We have

$$\begin{aligned}
nR_2 &\geq H(M_2) \geq H(M_2|A^n, Y^n, M_1) - H(M_2|A^n, Y^n, M_1, X_2^n) \\
&= I(M_2; X_2^n|A^n, Y^n, M_1) \\
&= H(X_2^n|A^n, Y^n, M_1) - H(X_2^n|A^n, Y^n, M_1, M_2) \\
&\stackrel{(a)}{\geq} H(X_2^n|A^n, Y^n, M_1) - n\delta(\epsilon) \\
&= \sum_{i=1}^n H(X_{2i}|X_2^{i-1}, A^n, Y^n, M_1) - n\delta(\epsilon) \\
&\stackrel{(b)}{\geq} \sum_{i=1}^n H(X_{2i}|A_i, Y_i, U_{1i}) - n\delta(\epsilon), \tag{48}
\end{aligned}$$

where (a) follows because from (44), $H(X_2^n|A^n, Y^n, M_1, M_2) \leq H(X_2^n|\hat{X}_2^n) \leq n\delta(\epsilon)$, given that \hat{X}_2^n is a function of M_1 , M_2 and Y^n and (b) follows using the definition of U_{1i} and due to the fact that conditioning decreases entropy. For the sum-rate $R_1 + R_2$, we also have the following

series of inequalities

$$\begin{aligned}
n(R_1 + R_2) &\geq H(M_1, M_2) \stackrel{(a)}{=} H(M_1, M_2, A^n) \\
&= H(A^n) + H(M_1, M_2|A^n) \\
&\geq H(A^n) - H(A^n|X_1^n, X_2^n) + H(M_1, M_2|A^n, Y^n) \\
&\quad - H(M_1, M_2|A^n, Y^n, X_1^n, X_2^n) \\
&= I(A^n; X_1^n, X_2^n) + I(M_1, M_2; X_1^n, X_2^n|A^n, Y^n) \\
&= I(A^n; X_1^n, X_2^n) + H(X_1^n, X_2^n|A^n, Y^n) - H(X_1^n, X_2^n|A^n, Y^n, M_1, M_2) \\
&= H(X_1^n, X_2^n) - H(X_1^n, X_2^n|A^n) + H(X_1^n, X_2^n, Y^n|A^n) - H(Y^n|A^n) \\
&\quad - H(X_2^n|A^n, Y^n, M_1, M_2) - H(X_1^n|A^n, Y^n, X_2^n, M_1, M_2) \\
&\stackrel{(b)}{\geq} H(X_1^n, X_2^n) + H(Y^n|A^n, X_1^n, X_2^n) - H(Y^n|A^n) \\
&\quad - H(X_1^n|A^n, Y^n, X_2^n, M_1, M_2) - n\delta(\epsilon), \tag{49}
\end{aligned}$$

where (a) follows because A^n is a function of M_1 ; and (b) follows as in (a) of (48). For the first three terms in (49) we have

$$\begin{aligned}
&H(X_1^n, X_2^n) + H(Y^n|A^n, X_1^n, X_2^n) - H(Y^n|A^n) \\
&\stackrel{(a)}{=} \sum_{i=1}^n H(X_{1i}, X_{2i}) + H(Y_i|Y^{i-1}, A^n, X_1^n, X_2^n) - H(Y_i|Y^{i-1}, A^n) \\
&\stackrel{(b)}{\geq} \sum_{i=1}^n H(X_{1i}, X_{2i}) + H(Y_i|A_i, X_{1i}, X_{2i}) - H(Y_i|A_i) \\
&= \sum_{i=1}^n H(X_{1i}, X_{2i}) - I(Y_i; X_{1i}, X_{2i}|A_i) \\
&= \sum_{i=1}^n H(X_{1i}, X_{2i}) - H(X_{1i}, X_{2i}|A_i) + H(X_{1i}, X_{2i}|A_i, Y_i) \\
&= \sum_{i=1}^n I(X_{1i}, X_{2i}; A_i) + H(X_{2i}|A_i, Y_i) + H(X_{1i}|A_i, Y_i, X_{2i}), \tag{50}
\end{aligned}$$

where (a) follows from the chain rule for entropy and by the chain rule for entropy and the fact that (X_1^n, X_2^n) are i.i.d.; and (b) follows since $Y_i \text{---} (A_i, X_{\{1,2\}i}) \text{---} (Y^{i-1}, A^{n \setminus i}, X_1^{n \setminus i}, X_2^{n \setminus i})$

forms a Markov chain, by the definition of problem, and since conditioning reduces entropy. Combining (49) and (50), and using the definition of U_{1i} , we obtain

$$\begin{aligned}
n(R_1 + R_2) &\stackrel{(a)}{\geq} \sum_{i=1}^n I(X_{1i}, X_{2i}; A_i) + H(X_{2i}|A_i, Y_i) + H(X_{1i}|A_i, Y_i, X_{2i}) \\
&\quad - H(X_{1i}|X_1^{i-1}, A^n, Y^n, X_2^n, M_1, M_2) - n\delta(\epsilon) \\
&\stackrel{(b)}{\geq} \sum_{i=1}^n I(X_{1i}; A_i) + H(X_{2i}|A_i, Y_i) + H(X_{1i}|A_i, Y_i, X_{2i}) \\
&\quad - H(X_{1i}|A^n, Y^n, X_2^n, M_1) - n\delta(\epsilon) \\
&\stackrel{(c)}{\geq} \sum_{i=1}^n (X_{1i}; A_i) + H(X_{2i}|A_i, Y_i) + I(X_{1i}; U_{1i}|A_i, Y_i, X_{2i}) - n\delta(\epsilon), \tag{51}
\end{aligned}$$

where (a) follows by the chain rule for entropy; (b) follows because mutual information is non-negative and due to the fact that conditioning decreases entropy; and (c) follows by the definition of mutual information and definition of U_{1i} and the fact that conditioning decreases entropy.

Moreover, $(X_{2i}, Y_i) - (X_{1i}, A_i) - U_{1i}$ forms a Markov chain. This can be seen by using the principle of d -separation [24, Sec. A.9] from Fig. 7, which represents the joint distribution of all the variables at hand.

Let Q be a uniform random variable over the interval $[1, n]$ and independent of $(X_1^n, X_2^n, A^n, U_1^n, Y^n, \hat{X}_1^n)$ and define $U_1 \triangleq (Q, U_{1Q})$, $X_1 \triangleq X_{1Q}$, $X_2 \triangleq X_{2Q}$, $Y \triangleq Y_Q$, $A \triangleq A_Q$, and $\hat{X}_1 \triangleq \hat{X}_{1Q}$. Note that \hat{X}_1 is a function of U_1 and Y . Moreover, from (8) and (9), we have

$$\begin{aligned}
\Gamma + \epsilon &\geq \frac{1}{n} \sum_{i=1}^n \mathbb{E}[\Lambda(A_i)] = \mathbb{E}[\Lambda(A)] \\
\text{and } D_1 + \epsilon &\geq \frac{1}{n} \sum_{i=1}^n \mathbb{E} \left[d_1(X_{1i}, X_{2i}, Y_i, \hat{X}_{1i}) \right] = \mathbb{E}[d_1(X_1, X_2, Y, \hat{X}_1)]. \tag{52}
\end{aligned}$$

Finally, since (47), (48) and (51) are convex with respect to $p(a, u_1|x_1, q)$ for fixed $p(q)$, $p(x_1, x_2)$, and $p(y|a, x_1, x_2)$, we have that inequalities (20) hold, which completes the proof of (20a)-(22b). The cardinality bounds are proved by using the Fenchel–Eggleston–Caratheodory theorem in the standard way.

APPENDIX D

GREEDY ACTIONS ARE OPTIMAL WITH SUM SIDE INFORMATION

Here we prove equality

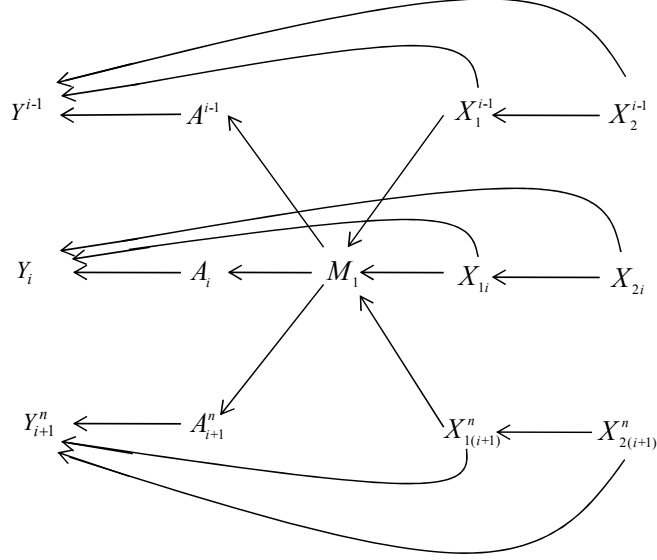

Fig. 7. Bayesian network representing the joint pmf of variables $(M_1, X_1^n, X_2^n, A^n, Y^n)$ for the model in Fig. 2.

$$R_{sum, greedy}^\oplus(\Gamma) = R_{sum}^\oplus(\Gamma). \quad (53)$$

which shows that no gain is accrued by choosing the actions based only on message M_1 with the sum side information. Fix the pmf $p(a|x_1)$ that achieves the minimum in the sum-rate obtained from (20c), namely

$$R_{sum}^\oplus(\Gamma) = \min I(X; A) + H(X_1, X_2|A, Y),$$

where the mutual information is calculated with respect to the distribution

$$p(x_1, x_2, y, a) = p(x_1, x_2)p(a|x_1)p(y|a, x_1, x_2), \quad (54)$$

and the minimum is taken over all distributions $p(a|x_1)$ such that $E[\Lambda(A)] = E[A] \leq \Gamma$. Note that for such a pmf $p(a|x_1)$ we have $E[A] = p(a) = \Gamma$, as it can be easily seen. We then have

the following series of equalities:

$$\begin{aligned}
& R_{sum, greedy}^{\oplus}(\Gamma) - R_{sum}^{\oplus}(\Gamma) \\
& \stackrel{(a)}{=} \Gamma H(X_1, X_2 | X_1 \oplus X_2) + (1 - \Gamma)H(X_1, X_2) \\
& \quad - H(X_1, X_2 | A, X_1 \oplus X_2) - I(X_1; A) \\
& \stackrel{(b)}{=} \Gamma H(X_1 | X_1 \oplus X_2) + (1 - \Gamma)(1 + H(p)) - \Gamma H(X_1, X_2 | A = 1, X_1 \oplus X_2) \\
& \quad - (1 - \Gamma)H(X_1, X_2 | A = 0) - I(X_1; A) \\
& \stackrel{(c)}{=} \Gamma H(X_1) + (1 - \Gamma)(1 + H(p)) - \Gamma H(X_1 | A = 1) - (1 - \Gamma)H(X_1 | A = 0) \\
& \quad - (1 - \Gamma)H(X_2 | X_1, A = 0) - I(X_1; A) \\
& \stackrel{(d)}{=} \Gamma + (1 - \Gamma)(1 + H(p)) - H(X_1 | A) - (1 - \Gamma)H(X_2 | X_1) - I(X_1; A) \\
& = \Gamma + (1 - \Gamma)(1 + H(p)) - H(X_1 | A) - (1 - \Gamma)H(p) - 1 + H(X_1 | A) = 0,
\end{aligned}$$

where (a) follows by the definition (27); (b) follows using the chain rule for entropy and from the definition of conditional entropy; (c) follows by the crypto-lemma [21, Lemma 2]; (d) follows from the fact that $X_2 - X_1 - A$ forms a Markov chain.

APPENDIX E

PROOF OF THE CONVERSE FOR PROPOSITION 5

In this section, we provide the proof of converse for Proposition 5. For any $(n, R_{12}, R_{23}, D_1 + \epsilon, D_2 + \epsilon, \Gamma + \epsilon)$ code, we have the following inequalities:

$$\begin{aligned}
nR_{12} &\geq H(M_{12}) \geq H(M_{12}|X_2^n) \stackrel{(a)}{=} H(M_{12}, M_{23}|X_2^n) \\
&\stackrel{(b)}{=} I(X_1^n; M_{12}, M_{23}|X_2^n) \\
&= \sum_{i=1}^n H(X_{1i}|X_1^{i-1}, X_2^n) - H(X_{1i}|X_1^{i-1}, X_2^n, M_{12}, M_{23}) \\
&\stackrel{(c)}{=} \sum_{i=1}^n H(X_{1i}|X_{2i}) - H(X_{1i}|X_1^{i-1}, X_2^n, A^n, M_{12}, M_{23}) \\
&\stackrel{(d)}{=} \sum_{i=1}^n H(X_{1i}|X_{2i}) - H(X_{1i}|X_1^{i-1}, X_2^n, Y^{i-1}, M_{12}, M_{23}, A^n, \hat{X}_1^n) \\
&\stackrel{(e)}{\geq} \sum_{i=1}^n H(X_{1i}|X_{2i}) - H(X_{1i}|X_{2i}, A_i, U_i, \hat{X}_{1i}) \\
&= \sum_{i=1}^n I(X_{1i}; A_i, U_i, \hat{X}_{1i}|X_{2i}), \tag{55}
\end{aligned}$$

where (a) follows because M_{23} is a function of (M_{12}, X_2^n) ; (b) follows by definition of mutual information and since M_{12} and M_{23} are functions of X_1^n and X_2^n ; (c) follows because X_1^n and X_2^n are i.i.d and since A^n is a function of M_{23} ; (d) follows because $Y^{i-1} - (X_1^{i-1}, X_2^n, A^n, M_{12}, M_{23}) - X_{1i}$ forms a Markov chain and since \hat{X}_1^n is a function of M_{12} and X_2^n ; and (e) follows by defining $U_i = (X_1^{i-1}, X_2^{i-1}, Y^{i-1}, A^{n \setminus i}, M_{23})$ and since conditioning decreases entropy.

We also have the inequalities

$$\begin{aligned}
nR_{23} &\geq H(M_{23}) \stackrel{(a)}{=} I(X_1^n, X_2^n; M_{23}) \\
&\stackrel{(b)}{=} \sum_{i=1}^n H(X_{1i}, X_{2i}) - H(X_{1i}, X_{2i} | X_1^{i-1}, X_2^{i-1}, M_{23}) \\
&\stackrel{(c)}{=} \sum_{i=1}^n H(X_{1i}, X_{2i}) - H(X_{1i}, X_{2i} | X_1^{i-1}, X_2^{i-1}, A^n, M_{23}) \\
&\stackrel{(d)}{=} \sum_{i=1}^n H(X_{1i}, X_{2i}) - H(X_{1i}, X_{2i} | X_1^{i-1}, X_2^{i-1}, Y^{i-1}, A^n, M_{23}) \\
&\stackrel{(e)}{=} \sum_{i=1}^n H(X_{1i}, X_{2i}) - H(X_{1i}, X_{2i} | A_i, U_i) \\
&= \sum_{i=1}^n I(X_{1i}, X_{2i}; A_i, U_i), \tag{56}
\end{aligned}$$

where (a) follows because M_{23} is a function of X_1^n and X_2^n ; (b) follows by the definition of mutual information and the chain rule for entropy and since X_1^n and X_2^n are i.i.d; (c) follows because A^n is a function of M_{23} ; (d) follows because $Y^{i-1} - (X_1^{i-1}, X_2^{i-1}, A^n, M_{23}) - (X_{1i}, X_{2i})$ forms a Markov chain; and (e) follows by the definition of U_i .

Let Q be a uniform random variable over $[1, n]$ and independent of $(X_1^n, X_2^n, Y^n, A^n, U^n, \hat{X}_1^n)$ and define $U \triangleq (Q, U_Q)$, $X_1 \triangleq X_{1Q}$, $X_2 \triangleq X_{2Q}$, $Y \triangleq Y_Q$, $A \triangleq A_Q$, $\hat{X}_1 \triangleq \hat{X}_{1Q}$, and $\hat{X}_2 \triangleq \hat{X}_{2Q}$. Note that \hat{X}_2 is a function of U and Y . Moreover, from (33) and (34), we have

$$\Gamma + \epsilon \geq \frac{1}{n} \sum_{i=1}^n \mathbb{E} [\Lambda(A_i)] = \mathbb{E}[\Lambda(A)] \tag{57}$$

$$\text{and } D_j + \epsilon \geq \frac{1}{n} \sum_{i=1}^n \mathbb{E} \left[d_j(X_{1i}, X_{2i}, Y_i, \hat{X}_{ji}) \right] = \mathbb{E}[d_j(X_1, X_2, Y, \hat{X}_j)] \text{ for } j = 1, 2. \tag{58}$$

Finally, since (55) and (56) are convex with respect to $p(a, u, \hat{x}_1 | x_1, x_2)$ for fixed $p(x_1, x_2)$ and $p(y | a, x_1, x_2)$, we have from (55) and (56) that inequalities (35) hold. The cardinality bounds are proved by using the Fenchel–Eggleston–Caratheodory theorem in the standard way.

REFERENCES

- [1] H. Permuter and T. Weissman, “Source coding with a side information “vending machine,”” *IEEE Trans. Inf. Theory*, vol. 57, no. 7, pp. 4530–4544, Jul 2011.
- [2] A. El Gamal and Y. Kim, *Network Information Theory*, Cambridge University Press, Dec. 2011.

- [3] T. Weissman and A. El Gamal, "Source coding with limited-look-ahead side information at the decoder," *IEEE Trans. Inf. Theory*, vol. 52, no. 12, pp. 5218–5239, Dec. 2006.
- [4] B. Ahmadi and O. Simeone, "Robust coding for lossy computing with receiver-side observation costs," in *Proc. IEEE International Symposium on Information Theory (ISIT 2011)*, pp. 2939–2943, July 31–Aug. 5, Saint Petersburg, Russia, 2011 (see also arXiv:1108.1535).
- [5] Y. Chia, H. Asnani, and T. Weissman, "Multi-terminal source coding with action dependent side information," in *Proc. IEEE International Symposium on Information Theory (ISIT 2011)*, pp. 2035–2039, July 31–Aug. 5, Saint Petersburg, Russia, 2011.
- [6] C. Heegard and T. Berger, "Rate distortion when side information may be absent," *IEEE Trans. Inf. Theory*, vol. 31, no. 6, pp. 727–734, Nov. 1985.
- [7] A. Kaspi, "Rate-distortion when side-information may be present at the decoder," *IEEE Trans. Inf. Theory*, vol. 40, no. 6, pp. 2031–2034, Nov. 1994.
- [8] K. Kittichokechai, T. J. Oechtering and M. Skoglund, "Source coding with common reconstruction and action-dependent side information," in *Proc. IEEE Information Theory Workshop*, pp. 1–5, Dublin, Ireland, Aug. 2010.
- [9] K. Kittichokechai, T. J. Oechtering and M. Skoglund, "Secure source coding with action-dependent side information," in *Proc. IEEE International Symposium on Information Theory (ISIT 2011)*, pp. 1678–1682, July 31–Aug. 5, Saint Petersburg, Russia, 2011.
- [10] Y. Steinberg, "Coding and common reconstruction," *IEEE Trans. Inf. Theory*, vol. 55, no. 11, pp. 4995–5010, Nov. 2009.
- [11] C. Choudhuri and U. Mitra, "How useful is adaptive action?," in *Proc. IEEE Globecom*, Dec. 3–7, Anaheim, CA, 2012.
- [12] H. Asnani and T. Weissman, "On real time coding with limited lookahead," submitted (arXiv:1105.5755).
- [13] S.-Y. Tung, "Multiterminal source coding," Ph.D. Thesis, Cornell University, Ithaca, NY, 1978.
- [14] M. Gastpar, "The Wyner–Ziv problem with multiple sources," *IEEE Trans. Inform. Theory*, vol. 50, no. 11, pp. 2762–2767, Nov. 2004.
- [15] B. Ahmadi, C. Choudhuri, O. Simeone and U. Mitra, "Cascade source coding with a side information "Vending Machine"," <http://arxiv.org/abs/1207.2793>.
- [16] S. Jana, "Alphabet sizes of auxiliary random variables in canonical inner bounds," in *Proc. Conf. Inf. Sci. Syst. (CISS)*, pp. 67–71, March. 18–20, Baltimore, MD, 2009.
- [17] A. H. Kaspi and T. Berger, "Rate-distortion for correlated sources with partially separated encoders," *IEEE Trans. Inform. Theory*, vol. 28, no. 6, pp. 828–840, Nov. 1982.
- [18] A. B. Wagner, B. G. Kelly, and Y. Altug, "The lossy one-helper conjecture is false," in *Proc. Allerton Conf. on Communications, Control, and Computing*, pp. 716–723, Sept. 30–Oct. 2, Monticello, IL, 2009.
- [19] T. Berger and R. Yeung, "Multiterminal source encoding with one distortion criterion," *IEEE Trans. Inform. Theory*, vol. 35, no. 2, pp. 228–236, Mar 1989.
- [20] B. Ahmadi and O. Simeone, "Distributed and cascade lossy source coding with a side information "Vending Machine"," <http://arxiv.org/abs/1109.6665>.
- [21] G. D. Forney Jr., "On the role of MMSE estimation in approaching the information- theoretic limits of linear Gaussian channels: Shannon meets Wiener," in *Proc. Allerton Conf. Communication, Control, and Computing*, Monticello, IL, pp. 430–439, Oct. 2003.
- [22] Y.-K. Chia and T. Weissman, "Cascade and triangular source coding with causal side information," in *Proc. IEEE*

International Symposium on Information Theory (ISIT 2011), pp. 1683–1687, July 31–Aug. 5, Saint Petersburg, Russia, 2011.

- [23] J. Chen, X. Zhang, T. Berger, and S. B. Wicker, “An upper bound on the sum rate distortion function and its corresponding rate allocation schemes for the CEO problem,” *IEEE J. Select. Areas Commun.*, vol. 22, no. 6, pp. 977–987, Aug. 2004.
- [24] G. Kramer, *Topics in Multi-User Information Theory*, Now Publishers, 2008.