

NUCLEI AND EXOTIC 4-MANIFOLDS

KOUICHI YASUI

ABSTRACT. We introduce a new generalization of Gompf nuclei and give applications. We construct infinitely many exotic smooth structures for a large class of compact 4-manifolds with boundary, regarding topological invariants. We prove that a large class of closed 3-manifolds (including disjoint unions of Stein fillable 3-manifolds) bound compact connected oriented 4-manifolds which admit infinitely many smooth structures. To detect smooth structures, we introduce a relative genus function. As a side result, we show that log transform and knot surgery of 4-manifolds do not admit any Stein structure, under a mild condition. Applying these results together with corks, we construct arbitrary many compact Stein 4-manifolds and infinitely many non-Stein 4-manifolds which are all homeomorphic but mutually non-diffeomorphic.

1. INTRODUCTION

It is currently known that many closed (or non-compact) 4-manifolds admit infinitely many smooth structures (cf. [25], [39], [20]). However, smooth structures on compact 4-manifolds with boundary are not much investigated, partially due to the difficulty of the invariants (e.g. relative Seiberg-Witten invariants). The main purpose of this paper is to study smooth and Stein structures on such 4-manifolds.

Gompf [23] (and independently Ue [41]) introduced nuclei, which is useful to construct exotic smooth structures of “closed” 4-manifolds (e.g. [35], [37], [8]). They also proved that each Gompf nucleus admits infinitely many smooth structures.

In this paper, we introduce a new generalization of Gompf nuclei. Unlike Fuller’s generalization for higher genus fibrations in [22], we require our nucleus to contain a cusp neighborhood. See Definition 3.2 for details. Applying nuclei, we construct exotic smooth structures for a large class of non-closed 4-manifolds, regarding topological invariants and boundary 3-manifolds.

We first prove the theorem below using log transform and knot surgery, where the closed case follows from theorems of Boyer [9] and Fintushel-Stern [16], [19].

Theorem 1.1. *Let X be an arbitrary connected oriented smooth 4-manifold. Here X is allowed to be closed, or to have (possibly disconnected) boundary, or to be non-compact. Suppose that X smoothly contains a nucleus. Assume further that X can be embedded into a connected oriented closed smooth 4-manifold Z with $b_2^+ > 1$ whose Seiberg-Witten invariant does not vanish. Then there exist infinitely many smooth 4-manifolds which are all homeomorphic to X but mutually non-diffeomorphic.*

Date: February 17, 2012.

2010 Mathematics Subject Classification. Primary 57R55, Secondary 57R65, 57R17.

Key words and phrases. 4-manifold; smooth structure; cork; Stein manifold; 3-manifold.

The author was partially supported by KAKENHI 23840027.

Remark 1.2. This theorem also holds in the case where the closed 4-manifold $Z \supset X$ satisfies $\pi_1(Z) \cong 1$, $b_2^+(Z) = 1$, $b_2^-(Z) \leq 9$ and $SW_Z \neq 0$ (see Subsection 5.5).

To detect smooth structures, we introduce a relative genus function (Definition 4.1), generalizing techniques of Akbulut and the author in [6]. While the reader may expect that the relative Seiberg-Witten (or Ozsváth-Szabó) invariants also detect smooth structures in the compact case, it seems that known formulas (to the author) do not work in this general setting (cf. Theorem 3.3 of [31]).

In the rest of this section, except for Theorem 1.6, we discuss applications of Theorem 1.1. Here recall that a (4-dimensional oriented) 2-handlebody means a compact, connected, oriented smooth 4-manifold obtained from the 4-ball by attaching 1- and 2-handles. Applying Theorem 1.1 and corks, we can easily construct infinitely many exotic smooth structures for a large class of 4-manifolds with boundary, regarding topological invariants.

Theorem 1.3. *Let X be a 2-handlebody which contains a nucleus as a subhandlebody. Suppose that the nucleus admits a Stein structure. Then, there exists a compact connected oriented smooth 4-manifold X_0 which satisfies the following.*

- (1) *There exist infinitely many smooth 4-manifolds which are all homeomorphic to X_0 but mutually non-diffeomorphic.*
- (2) *The fundamental group, the integral homology groups, the integral homology groups of the boundary, and the intersection form of X_0 are isomorphic to those of X .*
- (3) *X_0 (resp. X) can be embedded into X (resp. X_0).*

See also Corollaries 8.2 and 8.3 for simple consequences. Note that Theorem 1.1 of [6] gives finitely many exotic smooth structures for a larger class.

We next consider smooth structures of 4-manifolds from a view point of boundary 3-manifolds. Since every closed connected oriented 3-manifold bounds a simply connected compact oriented smooth 4-manifold, the following question is natural.

Question 1.4. Does every closed oriented (possibly disconnected) 3-manifold bound a (simply) connected compact oriented 4-manifold which has infinitely many distinct smooth structures?

There are a few affirmative examples. $\#_n(S^1 \times S^2)$ ($n \geq 0$) is easy to check using closed elliptic surfaces. Other known examples (to the author) are certain homology 3-spheres (Gompf [23] and Ue [41]), certain circle bundles over surfaces (Fintushel-Stern [18], [17] and Mark [31]) and certain Seifert 3-manifolds (Akhmedov-Etnyre-Mark-Smith [7]). In this paper, we give an affirmative answer for a large class of 3-manifolds applying Theorem 1.1. Note that most connected closed orientable 3-manifolds are known to be Stein fillable ([24], [25], [33]), though there are infinitely many non Stein fillable 3-manifolds ([27], [29], [30]).

Theorem 1.5. (1) *For every Stein fillable 3-manifold M , there exist infinitely many smooth 4-manifolds X_n ($n \geq 1$) such that they are all homeomorphic but mutually non-diffeomorphic and that the boundary ∂X_n of each X_n is diffeomorphic to M .*

(2) *Let M be a disjoint union of arbitrary finite number of Stein fillable 3-manifolds. Then there exist infinitely many smooth 4-manifolds X_n ($n \geq 1$) such that they are all homeomorphic but mutually non-diffeomorphic and that the boundary ∂X_n of each X_n is diffeomorphic to M .*

Moreover, ignoring the simple connectivity of 4-manifolds, we also prove this for more general 3-manifolds including non Stein fillable 3-manifolds with both orientations. See Theorem 9.2, Corollary 9.3 and Example 9.4.

We here discuss non-existence of Stein structures. It is interesting to find surgical operations which produce compact Stein 4-manifolds. Since log transform (resp. knot surgery) produces closed complex surfaces (resp. symplectic 4-manifolds) under certain conditions (cf. [25]), one might expect that these operations can produce compact Stein 4-manifolds. However, we give a negative answer under a mild condition.

Theorem 1.6. *Let X be a compact connected oriented smooth 4-manifold with boundary. Suppose that X contains a c -embedded torus T and that T represents a non-torsion (i.e. infinite order) class of $H_2(X; \mathbb{Z})$. Then the following hold.*

- (1) *For each $p \geq 2$, the p -log transform $X_{(p)}$ of X along T does not admit any Stein structure for both orientations.*
- (2) *For each knot K in S^3 with the non-trivial Alexander polynomial, the knot surgery X_K of X along T does not admit any Stein structure for both orientations.*

We finally discuss smooth structures of Stein 4-manifolds. It is known that diffeomorphism types of Stein 4-manifolds bounded by certain 3-manifolds are unique (e.g. $\#_n S^1 \times S^2$ ($n \geq 0$). cf. [33]). It is thus interesting to find exotic Stein 4-manifold pairs. Akhmedov-Etnyre-Mark-Smith [7] constructed the first example of infinitely many compact Stein 4-manifolds which are all homeomorphic but mutually non-diffeomorphic. Akbulut and the author (Theorem 10.1 of [6]) recently constructed arbitrary many compact Stein 4-manifolds and arbitrary many non-Stein 4-manifolds which are all homeomorphic but mutually non-diffeomorphic. In this paper, we construct arbitrary many compact Stein 4-manifolds and infinitely many non-Stein 4-manifolds which are all homeomorphic but mutually non-diffeomorphic.

Theorem 1.7. *Let X be a 2-handlebody which contains a nucleus as a subhandlebody. Suppose that the nucleus admits a Stein structure. Then for each integer $n \geq 1$, there exist infinitely many compact connected oriented smooth 4-manifolds X_i ($i = 0, 1, 2, \dots$) which satisfy the following.*

- (1) *X_i ($i \geq 0$) are all homeomorphic but mutually non-diffeomorphic.*
- (2) *Each X_i ($1 \leq i \leq n$) admits a Stein structure, and any X_i ($i \geq n + 1$) admits no Stein structure.*
- (3) *The fundamental group, the integral homology groups, the integral homology groups of the boundary, and the intersection form of each X_i ($i \geq 0$) are isomorphic to those of X .*
- (4) *Each X_i ($0 \leq i \leq n$) can be embedded into X .*
- (5) *X can be embedded into X_0 .*

See also Corollaries 11.5 and 11.6 for simple consequences. In a forthcoming paper [43], we will apply Theorem 1.1 to construct exotic S^2 -knots and links in certain 4-manifolds.

This paper is organized as follows. In Section 2, we recall log transform, knot surgery and the adjunction inequality. In Section 3, we study a generalization of Gompf nuclei. In Section 4, we introduce a relative genus function. In Section 5, we prove Theorem 1.1. In Sections 6 and 7, we briefly review compact Stein 4-manifolds, corks and W -modifications. In Section 8, we prove Theorem 1.3, applying W -modifications and Theorem 1.1. In Section 9, we prove Theorem 1.5,

using compact Stein 4-manifolds and applying Theorem 1.1. In Section 10, we prove Theorem 1.6. In Section 11, we recall an algorithm of Akbulut and the author [6] and prove Theorem 1.7, applying the algorithm and Theorems 1.1 and 1.6.

Acknowledgements. The author would like to thank Anar Akhmedov, Mikio Furuta, Kazunori Kikuchi, Hirofumi Sasahira, Motoo Tange, Masaaki Ue and Yuichi Yamada for their helpful comments.

2. LOG TRANSFORM, KNOT SURGERY AND THE ADJUNCTION INEQUALITY

In this section, we briefly recall log transform, knot surgery and their effects on Seiberg-Witten invariants. Furthermore, we recall the adjunction inequality. For details, see [25], [20], [39], [38].

Throughout this paper, for an embedded oriented connected closed surface Σ in a 4-manifold X , we denote by $[\Sigma]$ the class of $H_2(X; \mathbb{Z})$ represented by Σ . The symbol $\nu(\cdot)$ and $PD(\cdot)$ denote the regular neighborhood and the Poincaré dual class, respectively.

Definition 2.1. (1) The smooth 4-manifold C given by the left handlebody in Figure 1 is called a *cuspidal neighborhood*. Note that this 4-manifold is diffeomorphic to the middle and the right handlebodies. It is known that C admits a torus fibration structure over D^2 with only one singular fiber, i.e., a cusp fiber. The obvious $T^2 \times D^2$ in the left diagram describes the tubular neighborhood of the regular fiber.

(2) A smoothly embedded torus T in a 4-manifold X is called a *c-embedded torus* if X smoothly contains a cuspidal neighborhood C , and T is a regular fiber of C . Note that the self-intersection number of any *c-embedded torus* is zero.

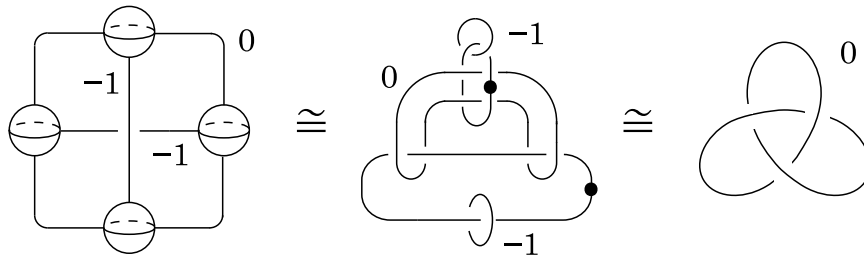

FIGURE 1. Diagrams of a cuspidal neighborhood C

2.1. Log transform. Recall that self-diffeomorphisms of $T^3 = S^1 \times S^1 \times S^1$ are classified, up to isotopy, by $\text{Aut}_{\mathbb{Z}}(H_1(T^3; \mathbb{Z}))$. Let φ_p ($p \geq 0$) be the self-diffeomorphism of $T^2 \times S^1$ induced by the automorphism

$$\begin{pmatrix} 1 & 0 & 0 \\ 0 & 0 & 1 \\ 0 & -1 & p \end{pmatrix}$$

of $H_1(S^1; \mathbb{Z}) \oplus H_1(S^1; \mathbb{Z}) \oplus H_1(S^1; \mathbb{Z})$ with the obvious basis.

Definition 2.2. Let X be a smooth 4-manifold which contains a torus T with the self-intersection number zero, and let $\nu(T)$ denote the tubular neighborhood of T . Let $X_{(p)}$ be the smooth 4-manifold obtained from X by removing $\nu(T)$ and gluing $T^2 \times D^2$ via the diffeomorphism $\varphi_p : T^2 \times \partial D^2 \rightarrow \partial\nu(T)$, where we identify $\partial\nu(T)$ with $T^2 \times \partial D^2$. This $X_{(p)}$ is called the p -log transform of X along T . We denote the new embedded torus $T^2 \times 0$ in $X_{(p)}$ by T_p , which is called the *multiple fiber*.

Remark 2.3. (1) Note that $X_{(p)}$ contains a parallel copy of the original torus T . This torus satisfies $[T] = p[T_p]$ in $H_2(X_{(p)}; \mathbb{Z})$. This can be seen as follows. Let $\lambda_1, \lambda_2, \lambda_3$ be the obvious basis of $H_1(S^1 \times S^1; \mathbb{Z}) \oplus H_1(\partial D^2; \mathbb{Z})$. The tori $\varphi_p(T^2 \times \{pt.\})$ and $T \times \{pt.\}$ in $\partial\nu(T) \subset X_{(p)}$ are parallel copies of T_p and T , respectively. By the definition of φ_p , the obvious basis μ_1, μ_2, μ_3 of $H_1(\partial\nu(T)) = H_1(T; \mathbb{Z}) \oplus H_1(\partial D^2; \mathbb{Z})$ satisfies $\mu_1 = \varphi_{p*}(\lambda_1)$ and $\mu_2 = p\varphi_{p*}(\lambda_2) - \varphi_{p*}(\lambda_3)$. Since $[\varphi_p(S^1 \times \{pt.\} \times S^1)] = 0$ in $H_2(X_{(p)}; \mathbb{Z})$, the K un uth formula easily gives $[T] = p[T_p]$ in $H_2(X_{(p)}; \mathbb{Z})$ as desired.

(2) The above definition of log transform is a special case of the general log transform. When the torus is c -embedded, this definition is known to be consistent with the general one. See [23], [25] for details.

By the following result, we may identify $X_{(1)}$ with X if the torus T is c -embedded.

Theorem 2.4 (Gompf [23]). *Let X be a connected closed oriented smooth 4-manifold which contains a c -embedded torus T . Then the log transform $X_{(1)}$ along T is diffeomorphic to X .*

The Seiberg-Witten invariant of $X_{(p)}$ is given as follows.

Theorem 2.5 (Fintushel-Stern [16], Morgan-Mrowka-Szab o [32]). *Let X be a connected closed oriented smooth 4-manifold with $b_2^+ > 1$ which contains a c -embedded torus T . Let $X_{(p)}$ and T_p ($p \geq 1$) be the p -log transform of X along T and the multiple fiber of $X_{(p)}$, respectively. If $[T]$ is non-torsion in $H_2(X; \mathbb{Z})$, then*

$$SW_{X_{(p)}} = SW_X \cdot (t^{-(p-1)} + t^{-(p-3)} + \dots + t^{p-1}),$$

where $t = \exp(PD([T_p]))$.

2.2. Knot surgery.

Definition 2.6. Let X be a compact oriented smooth 4-manifold which contains a torus T with the self-intersection number 0, and let K be a knot in S^3 . We call the smooth 4-manifold

$$X_K := (X - \text{int } \nu(T)) \cup_{\varphi} ((S^3 - \text{int } \nu(K)) \times S^1)$$

a *knot surgery* of X along T with K . Here $\varphi : \partial\nu(T) \rightarrow \partial\nu(K) \times S^1$ is any gluing map which sends $\{pt.\} \times \partial D^2 \subset T^2 \times \partial D^2 \cong \partial\nu(T)$ to $\ell \times \{pt.\} \subset \partial\nu(K) \times S^1$, where ℓ denotes a longitude of K . Note that the diffeomorphism type of X_K may depend on the choice of φ . We denote by T_K the torus $m \times S^1 \subset (S^3 - \nu(K)) \times S^1$ in X_K , where m denotes a meridian of K . Note $[T_K] \cdot [T_K] = 0$.

Remark 2.7. Note that X_K contains a parallel copy of the original torus T . Similarly to Remark 2.3.(1), we can see that $[T] = [T_K]$ in $H_2(X_K; \mathbb{Z})$.

The Seiberg-Witten invariant of X_K is given as follows.

Theorem 2.8 (Fintushel-Stern [19], see also [21]). *Let X be a connected closed oriented smooth 4-manifold with $b_2^+ > 1$ which contains a c -embedded torus T . If $[T]$ is non-torsion in $H_2(X; \mathbb{Z})$, then, for any knot K in S^3 , the knot surgery X_K satisfies*

$$\mathcal{SW}_{X_K} = \mathcal{SW}_X \cdot \Delta_K(t),$$

where Δ_K is the symmetrized Alexander polynomial of K , and $t = \exp(PD(2[T]))$.

2.3. The adjunction inequality. In this paper, we use the following adjunction inequality to detect smooth structures. According to Theorem 2.10, we can apply the adjunction inequality for many closed 4-manifolds with the non-vanishing Seiberg-Witten invariants.

Theorem 2.9 (Kronheimer-Mrowka [26], Ozsváth-Szabó [34]. cf. [33]). *Let X be a connected closed oriented smooth 4-manifold with $b_2^+ > 1$, and let $K \in H^2(X; \mathbb{Z})$ be a Seiberg-Witten basic class of X . If a smoothly embedded connected closed oriented surface $\Sigma \subset X$ of genus $g \geq 0$ satisfies $[\Sigma] \cdot [\Sigma] \geq 0$, and $[\Sigma]$ is non-torsion, then the following inequality holds:*

$$[\Sigma] \cdot [\Sigma] + |\langle K, [\Sigma] \rangle| \leq 2g - 2.$$

Furthermore, if X is of Seiberg-Witten simple type and $g \geq 1$, then the same inequality also holds in the $[\Sigma] \cdot [\Sigma] < 0$ case.

Theorem 2.10 (Morgan-Mrowka-Szabo [32]). *Let X be a connected closed oriented smooth 4-manifold with $b_2^+ > 1$. If X contains a smoothly embedded torus T , and $[T]$ is non-torsion, then X is of Seiberg-Witten simple type.*

3. GENERALIZED NUCLEUS

In this section, we give a new generalization of Gompf nuclei [23] and discuss their properties. For related discussions, see also [15]. We begin with the following lemma.

Lemma 3.1. *Let X be a compact connected oriented smooth 4-manifold (possibly with boundary) which contains a torus T . Suppose that $H_2(X; \mathbb{Z})$ has no torsion and that $H_1(X - \text{int } \nu(T); \mathbb{Z}) \cong \mathbb{Z}/d\mathbb{Z}$ for some positive integer d . Then there exists a primitive (i.e. indivisible) class \hat{T} of $H_2(X; \mathbb{Z})$ such that $[T] = d \cdot \hat{T}$.*

Proof. Using the homology exact sequence for the pair $(X, \nu(T))$, the Alexander duality $H^{4-i}(X - \text{int } \nu(T); \mathbb{Z}) \cong H_i(X, \nu(T); \mathbb{Z})$, and the universal coefficient theorem, we easily get the following exact sequence:

$$0 \rightarrow H_2(\nu(T); \mathbb{Z}) \rightarrow H_2(X; \mathbb{Z}) \rightarrow \text{Hom}(H_2(X - \text{int } \nu(T); \mathbb{Z}), \mathbb{Z}) \oplus (\mathbb{Z}/d\mathbb{Z}) \rightarrow \mathbb{Z} \oplus \mathbb{Z}.$$

We can now easily check the claim. \square

We here give a generalization of Gompf nucleus [23]. Our generalization is different from Fuller's one [22], since our purpose is to produce exotic smooth structures.

Definition 3.2. Let N be a connected compact oriented smooth 4-manifold with a connected non-empty boundary. Suppose that N smoothly contains a torus T . We call (N, T) (or N itself) a *nucleus*, if the following conditions hold.

- (i) $\pi_1(N) \cong 1$ and $H_2(N; \mathbb{Z}) \cong \mathbb{Z} \oplus \mathbb{Z}$.
- (ii) The intersection form of N is unimodular. In particular, the boundary ∂N is a connected homology 3-sphere (cf. [25]).

- (iii) T is c -embedded in N . In particular, $[T] \cdot [T] = 0$.
- (iv) $\pi_1(N - \text{int } \nu(T)) \cong \mathbb{Z}/d_T\mathbb{Z}$ for some positive integer d_T . We call d_T the *divisor* of T .
- (v) The inclusion induced homomorphism $\pi_1(\partial\nu(T)) \rightarrow \pi_1(N - \text{int } \nu(T))$ is surjective.

Remark 3.3. In the above definition of nuclei, we added the condition (v) to guarantee the simple connectivity of the log transform $N_{(p)}$ for some p 's (see Lemma 3.6). However, as long as $N_{(p)}$ is simply connected (for some p 's), all arguments in this paper work even when N does not satisfy the condition (v).

There are many examples of our generalized nuclei. Actually, it is easy to construct examples using handlebody pictures.

Example 3.4. (1) Let X be a 4-manifold obtained from the cusp neighborhood C by attaching a single 2-handle along a knot which links with the 0-framed trefoil knot in the right diagram of Figure 1 geometrically once. Let T denote the regular fiber of the cusp neighborhood C . Then (X, T) is clearly a nucleus with $d_T = 1$. It easily follows from the Van Kampen's Theorem that $(X_{(p)}, T)$ is also a nucleus with $d_T = p$. Note that $X_{(p)}$ still contains a smaller copy of C .

(2) Let $G(n)$ ($n \geq 1$) be the 4-manifold in Figure 2. This $G(n)$ is the Gompf nucleus introduced by Gompf [23]. Note that the intersection form of $G(n)$ is odd (resp. even) if n is odd (resp. even). As noted in the above, $G(n)$ and its p -log transform $G(n)_{(p)}$ ($p \geq 1$) are nuclei in the sense of Definition 3.2.



FIGURE 2. Gompf nucleus $G(n)$ ($n \geq 1$)

We here discuss basic properties of our nuclei.

Lemma 3.5. *Let (N, T) and d_T be a nucleus and the divisor of T , respectively. Then there exists a basis \hat{T}, S of $H_2(N; \mathbb{Z})$ such that $[T] = d_T \cdot \hat{T}$ and $S \cdot \hat{T} = 1$. Consequently, the intersection form of N is indefinite.*

Proof. Lemma 3.1 gives a primitive class \hat{T} with $[T] = d_T \cdot \hat{T}$. Since the intersection form of N is unimodular, the fact $\hat{T} \cdot \hat{T} = 0$ implies the existence of the required class S . \square

Lemma 3.6. *Let (N, T) and d_T be a nucleus and the divisor of T , respectively. Assume that a positive integer p is relatively prime to d_T . Let $N_{(p)}$ be the p -log transform of N along T . Then the following hold.*

- (1) $\pi_1(N_{(p)}) \cong 1$ and $H_2(N_{(p)}; \mathbb{Z}) \cong \mathbb{Z} \oplus \mathbb{Z}$.
- (2) *The intersection form of $N_{(p)}$ is unimodular and indefinite. The intersection form of $N_{(p)}$ is even if and only if the following two conditions are satisfied.*
 - (i) *The intersection form of N is even.*
 - (ii) *p is odd, or d_T is even.*

(3) *If the intersection form of N and $N_{(p)}$ are isomorphic, then any diffeomorphism between the boundaries ∂N and $\partial N_{(p)}$ extends to a homeomorphism between N and $N_{(p)}$.*

Proof. (1) The Van Kampen's theorem gives $\pi_1(N_{(p)}) \cong 1$. We can easily check that $H_2(N_{(p)}; \mathbb{Z})$ has no torsion and that $H_3(N_{(p)}; \mathbb{Z}) = 0$, using the universal coefficient theorem and the Poincaré duality. Since the Euler characteristics of $N_{(p)}$ and N are equal, $H_2(N_{(p)}; \mathbb{Z}) \cong \mathbb{Z} \oplus \mathbb{Z}$.

(2) Since N is simply connected, and $\partial N_{(p)} (= \partial N)$ is a homology 3-sphere, the intersection form of $N_{(p)}$ is unimodular (cf. [25]). Lemma 3.1 thus implies that $N_{(p)}$ has an indefinite form.

We next discuss the parity of the intersection form. Let S denote the class of $H_2(N; \mathbb{Z})$ given in Lemma 3.5 and put $s = S \cdot S$. We here consider a handle decomposition of N . N is obtained from the cusp neighborhood in the middle diagram of Figure 1 by attaching handles. Recall that (part of) 2-handles of N naturally give a generating set of $H_2(N; \mathbb{Z})$ after appropriately sliding 2-handles. Therefore, if necessary by creating a canceling 2-handle/3-handle pair and sliding handles except those of the cusp neighborhood C , the class S is represented by a 2-handle (say K) of the decomposition of N . In particular, (the attaching circle of) K does not algebraically link with any 1-handles of the decomposition of N . Furthermore, we may assume that K does not algebraically link with the two -1 -framed knots of C , if necessary, by further sliding K over 1-handles of C . It follows that the Seifert framing of K is s and that K links with the 0-framed knot in the left picture of Figure 3 algebraically d_T times. Hence the 2-handle K is given as shown in the left picture of Figure 3, though the actual K may geometrically link with other handles in the picture.

Applying the p -log transform procedure in Figure 17 of [5] to the above handlebody of N , we get the right handlebody of $N_{(p)}$ in Figure 3. Note that the obvious $T^2 \times D^2$ describes $\nu(T_p)$. The bottom s -framed circle (say L_1) may geometrically link with other handles in the picture, though its algebraic linking numbers with other handles are correct. Let L_2 denote the middle $(p-1)$ -framed knot in the right diagram of Figure 3. By introducing a canceling 2-handle/3-handle pair and sliding handles, we get a 2-handle $L (= pL_1 + d_T L_2)$ which satisfies the following three conditions: (i) L does not algebraically link with any 1-handles; (ii) L links with the middle 0-framed knot algebraically d_T times; (iii) The Seifert framing of L is $s' := p^2 s + (d_T)^2 (p-1)$. This together with Lemma 3.1 implies the existence of a basis S', \widehat{T}_p of $H_2(N_{(p)}; \mathbb{Z})$ which satisfies the following:

$$[T_p] = d_T \cdot \widehat{T}_p, \quad S' \cdot S' = s', \quad S' \cdot \widehat{T}_p = 1.$$

Thus the intersection form of $N_{(p)}$ is even if and only if $s' = p^2 s + (d_T)^2 (p-1)$ is even. We can now easily check the claim (2).

(3) This clearly follows from Boyer's theorem [9] (cf. Corollary 2.3 of [37]). \square

Lemma 3.7. *Let (N, T) be a nucleus. Assume that the divisor d_T satisfies $d_T = 1$. Let K be a knot in S^3 , and let N_K be the knot surgery of N along T . Then the following hold.*

(1) *The fundamental group, the homology groups, and the intersection form of N_K are isomorphic to those of N . Furthermore, the class $[T]$ is primitive in $H_2(N_K; \mathbb{Z})$.*

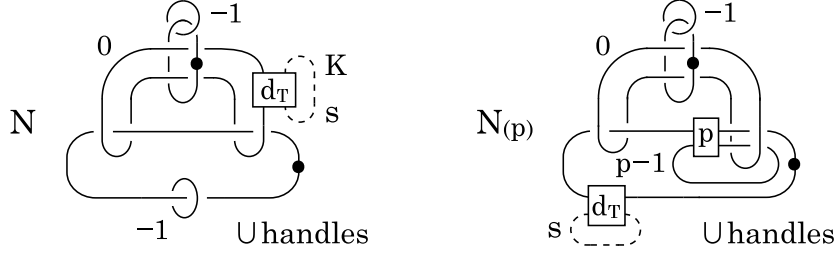

FIGURE 3. handlebodies of N and $N_{(p)}$

(2) Any diffeomorphism between the boundaries ∂N and ∂N_K extends to a homeomorphism between N and N_K .

Proof. (1) A sketch of a proof was given by Fintushel-Stern [19]. We here explain more detail for the reader's convenience. Since $\pi_1(X - \nu(T)) \cong 1$, N_K is simply connected ([19]). Since ∂N_K is a connected homology 3-sphere, it is easy to see that $H_2(N_K; \mathbb{Z})$ has no torsion and that $H_3(N_K; \mathbb{Z}) = 0$ by the Poincaré duality and the universal coefficient theorem. These fact give $H_2(N_K; \mathbb{Z}) \cong H_2(N; \mathbb{Z})$ because the Euler characteristics of N_K and N are the same. Hence the homology groups of N_K and N are isomorphic.

The condition $\pi_1(X - \nu(T)) \cong 1$ gives an embedded closed connected oriented surface S in N which transversely intersects with the torus T in exactly one point. (The reason is as follows. It is easy to construct a continuous map $S^2 \rightarrow N$ such that its image of a disk ($\subset S^2$) is a disk $D := \{pt.\} \times D^2$ in $T \times D^2 \cong \nu(T)$. Approximating this map by an immersion and resolving its singular points (cf. Remark 2.1.2 of [25]), we obtain the desired surface.) Let $T' \subset N - \nu(T)$ be a parallel copy of T . We may assume that $T' \subset N$ intersects with $S \subset N$ in exactly one point and that the point is outside of the disk D . Let Σ be a Seifert surface of a longitude of K . We denote by S_K the closed connected oriented surface in X_K obtained by gluing $S - \text{int } D$ with $\Sigma \times \{pt.\} \subset (S^3 - \text{int } \nu(K)) \times S^1$ along $\partial D = \partial \Sigma \times \{pt.\}$. Since we can move Σ along the trivial S^1 direction in $(S^3 - \text{int } \nu(K)) \times S^1$, the surface S_K satisfies $S_K \cdot S_K = S \cdot S$. By the construction, $S_K \cdot T' = 1$. This shows that the intersection forms of N and N_K are isomorphic and that the class $[T]$ is primitive in $H_2(N_K; \mathbb{Z})$.

The claim (2) follows from Boyer's theorem. \square

4. RELATIVE GENUS FUNCTION

In this section, we introduce a relative genus function of a 4-manifold.

Here recall that, for any oriented smooth 4-manifold X , every class $\alpha \in H_2(X; \mathbb{Z})$ can be represented by a smoothly embedded closed connected oriented surface in X (cf. Exercise 4.5.12.(b) of [25]). Note that this holds even when X has (possibly disconnected) boundary, or is non-compact. We also use the following convention. For a class $\alpha \in H_2(X; \mathbb{Z})/\text{Tor}$ and a smoothly embedded closed connected oriented surface Σ in X , we say “ Σ represents α ”, if $[\Sigma] \in H_2(X; \mathbb{Z})$ represents $\alpha \in H_2(X; \mathbb{Z})/\text{Tor}$.

The (minimal) genus function $g_X : H_2(X; \mathbb{Z}) \rightarrow \mathbb{Z}$ of X is defined as follows:

$$g_X(\alpha) = \min \left\{ g \in \mathbb{Z} \mid \begin{array}{l} \alpha \text{ is represented by a smoothly embedded} \\ \text{closed connected oriented surface of genus } g \text{ in } X. \end{array} \right\}.$$

Similarly, one can also define the genus function $g_X : H_2(X; \mathbb{Z})/\text{Tor} \rightarrow \mathbb{Z}$ of X . We use the same symbol g_X for these two functions, if it is clear from the context.

In [2], Akbulut successfully used the genus function to detect smooth structures of two 4-manifolds with $b_2 = 1$. However, it is generally difficult to see differences of the functions in the $b_2 \geq 2$ case, since we have to consider the automorphisms of the second homology groups induced by self-diffeomorphisms.

To avoid this issue, we introduce relative versions of the genus function, by generalizing techniques of Akbulut and the author in [6]. We use the following notation. Let $\mathbb{Z}_{\geq 0}$ denote the set of non-negative integers. For an index set Λ , let \mathbb{Z}^Λ and $(\mathbb{Z}_{\geq 0})^\Lambda$ denote the direct products $\prod_\Lambda \mathbb{Z}$ and $\prod_\Lambda (\mathbb{Z}_{\geq 0})$, respectively. Let $\text{Sym}_\Lambda(\mathbb{Z})$ denote the set of $\Lambda \times \Lambda$ integer symmetric matrices. Namely, we set

$$\begin{aligned} \mathbb{Z}^\Lambda &= \{(d_\lambda)_{\lambda \in \Lambda} \mid d_\lambda \in \mathbb{Z} \text{ for all } \lambda \in \Lambda\}, \\ (\mathbb{Z}_{\geq 0})^\Lambda &= \{(g_\lambda)_{\lambda \in \Lambda} \mid g_\lambda \in \mathbb{Z}_{\geq 0} \text{ for all } \lambda \in \Lambda\}, \\ \text{Sym}_\Lambda(\mathbb{Z}) &= \{(Q_{\lambda, \mu})_{(\lambda, \mu) \in \Lambda \times \Lambda} \mid Q_{\lambda, \mu} \in \mathbb{Z} \text{ and } Q_{\lambda, \mu} = Q_{\mu, \lambda} \text{ for all } (\lambda, \mu) \in \Lambda \times \Lambda\}. \end{aligned}$$

Let X be an arbitrary connected oriented smooth 4-manifold. X is allowed to be closed or to have (possibly disconnected) boundary or to be non-compact.

Definition 4.1. Suppose that $H_2(X; \mathbb{Z})/\text{Tor}$ is a free \mathbb{Z} -module. Let fix an index set Λ which has a bijection to a basis of $H_2(X; \mathbb{Z})/\text{Tor}$. Note that any two bases of a (possibly infinitely generated) free \mathbb{Z} -module have the same cardinality. Fix an element λ_0 of Λ .

(1) Let $\mathbf{v} = \{v_\lambda \mid \lambda \in \Lambda\}$ be a basis of $H_2(X; \mathbb{Z})/\text{Tor}$. For $Q \in \text{Sym}_\Lambda(\mathbb{Z})$, $\mathbf{d} \in \mathbb{Z}^\Lambda$ and $\mathbf{g} \in (\mathbb{Z}_{\geq 0})^{\Lambda - \{\lambda_0\}}$, we define $G_{X, Q, \mathbf{d}, \mathbf{g}}(\mathbf{v}) \in \mathbb{Z} \cup \{\infty\}$ as follows. Here we put $Q = (Q_{\lambda, \mu})_{(\lambda, \mu) \in \Lambda \times \Lambda}$, $\mathbf{d} = (d_\lambda)_{\lambda \in \Lambda}$ and $\mathbf{g} = (g_\lambda)_{\lambda \in \Lambda - \{\lambda_0\}}$.

$$G_{X, Q, \mathbf{d}, \mathbf{g}}(\mathbf{v}) = \begin{cases} g_X(d_{\lambda_0} v_{\lambda_0}), & \text{if } \mathbf{v} \text{ satisfies the following conditions (i) and (ii).} \\ \infty, & \text{otherwise.} \end{cases}$$

(i) The basis \mathbf{v} represents Q , namely, $v_\lambda \cdot v_\mu = Q_{\lambda, \mu}$ for each $\lambda, \mu \in \Lambda$.

(ii) For each $\lambda \in \Lambda - \{\lambda_0\}$, $d_\lambda v_\lambda \in H_2(X; \mathbb{Z})/\text{Tor}$ satisfies $g_X(d_\lambda v_\lambda) \leq g_\lambda$.

(2) For $Q \in \text{Sym}_\Lambda(\mathbb{Z})$, $\mathbf{d} \in \mathbb{Z}^\Lambda$ and $\mathbf{g} \in (\mathbb{Z}_{\geq 0})^{\Lambda - \{\lambda_0\}}$, we define $G_X(Q, \mathbf{d}, \mathbf{g}) \in \mathbb{Z} \cup \{\infty\}$ as follows.

$$G_X(Q, \mathbf{d}, \mathbf{g}) = \min\{G_{X, Q, \mathbf{d}, \mathbf{g}}(\mathbf{v}) \mid \mathbf{v} \text{ is a basis of } H_2(X; \mathbb{Z})/\text{Tor}\}.$$

We call this function

$$G_X : \text{Sym}_\Lambda(\mathbb{Z}) \times \mathbb{Z}^\Lambda \times (\mathbb{Z}_{\geq 0})^{\Lambda - \{\lambda_0\}} \rightarrow \mathbb{Z} \cup \{\infty\}$$

the *relative genus function* of X .

Remark 4.2. (1) This function is clearly an invariant of smooth structures. Namely, if X and Y are orientation preserving diffeomorphic, then $G_X = G_Y$ for any fixed pair (Λ, λ_0) . If X and Y are orientation reversing diffeomorphic, then $G_X(Q, \mathbf{d}, \mathbf{g}) = G_Y(-Q, \mathbf{d}, \mathbf{g})$ for each $(Q, \mathbf{d}, \mathbf{g}) \in \text{Sym}_\Lambda(\mathbb{Z}) \times \mathbb{Z}^\Lambda \times (\mathbb{Z}_{\geq 0})^{\Lambda - \{\lambda_0\}}$.

(2) The following variant G^\pm is useful to detect smooth structures without fixing orientations. Let

$$G_X^\pm : \text{Sym}_\Lambda(\mathbb{Z}) \times \mathbb{Z}^\Lambda \times (\mathbb{Z}_{\geq 0})^{\Lambda - \{\lambda_0\}} \rightarrow \mathbb{Z} \cup \{\infty\}$$

be the function defined by $G_X^\pm(Q, \mathbf{d}, \mathbf{g}) = \min\{G_X(Q, \mathbf{d}, \mathbf{g}), G_X(-Q, \mathbf{d}, \mathbf{g})\}$. Clearly, if X and Y are diffeomorphic (not necessarily orientation preserving), then $G_X^\pm = G_Y^\pm$.

We next slightly generalize the relative genus function, since we need to deal with the case where $H_2(X; \mathbb{Z})/\text{Tor}$ is not a free module. While the following function G_{X, F_0, F_1} is stronger and enough for our purpose, we mainly use G_X in this paper. This is just because we can decrease the number of symbols for discussions.

Definition 4.3. Let F_0 and F_1 be a free \mathbb{Z} -module and a (possibly non-free) \mathbb{Z} -module, respectively. Let Λ_0 be an index set which has a bijection to a basis of F_0 . Put $\Lambda_1 = F_1$ and regard Λ_1 as an index set. Denote by Λ the disjoint union $\Lambda_0 \amalg \Lambda_1$. Fix an element $\lambda_0 \in \Lambda_0 \subset \Lambda$.

(1) Let $\mathbf{v} = \{v_\lambda \mid \lambda \in \Lambda\}$ be a subset of $H_2(X; \mathbb{Z})$. For $Q \in \text{Sym}_\Lambda(\mathbb{Z})$, $\mathbf{d} \in \mathbb{Z}^\Lambda$ and $\mathbf{g} \in (\mathbb{Z}_{\geq 0})^{\Lambda - \{\lambda_0\}}$, we define $G_{X, F_0, F_1, Q, \mathbf{d}, \mathbf{g}}(\mathbf{v}) \in \mathbb{Z} \cup \{\infty\}$ as follows. Here we put $Q = (Q_{\lambda, \mu})_{(\lambda, \mu) \in \Lambda \times \Lambda}$, $\mathbf{d} = (d_\lambda)_{\lambda \in \Lambda}$ and $\mathbf{g} = (g_\lambda)_{\lambda \in \Lambda - \{\lambda_0\}}$.

$$G_{X, F_0, F_1, Q, \mathbf{d}, \mathbf{g}}(\mathbf{v}) = \begin{cases} g_X(d_{\lambda_0} v_{\lambda_0}), & \text{if } \mathbf{v} \text{ satisfies the following conditions (i)–(iii).} \\ \infty, & \text{otherwise.} \end{cases}$$

- (i) The subset \mathbf{v} represents Q , namely, $v_\lambda \cdot v_\mu = Q_{\lambda, \mu}$ for each $\lambda, \mu \in \Lambda$.
- (ii) For each $\lambda \in \Lambda - \{\lambda_0\}$, $d_\lambda v_\lambda \in H_2(X; \mathbb{Z})$ satisfies $g_X(d_\lambda v_\lambda) \leq g_\lambda$.
- (iii) There exists a direct sum decomposition $H_2(X; \mathbb{Z}) = F'_0 \oplus F'_1$ satisfying the following conditions (a) and (b).
 - (a) The submodules F'_0 and F'_1 are isomorphic to F_0 and F_1 , respectively.
 - (b) The subset $\mathbf{v}^{(0)} := \{v_\lambda \mid \lambda \in \Lambda_0\}$ of \mathbf{v} is a basis of F'_0 , and the subset $\mathbf{v}^{(1)} := \{v_\lambda \mid \lambda \in \Lambda_1\}$ of \mathbf{v} satisfies $\mathbf{v}^{(1)} = F'_1$.

(2) For $Q \in \text{Sym}_\Lambda(\mathbb{Z})$, $\mathbf{d} \in \mathbb{Z}^\Lambda$ and $\mathbf{g} \in (\mathbb{Z}_{\geq 0})^{\Lambda - \{\lambda_0\}}$, we define $G_{X, F_0, F_1}(Q, \mathbf{d}, \mathbf{g}) \in \mathbb{Z} \cup \{\infty\}$ as follows.

$$G_{X, F_0, F_1}(Q, \mathbf{d}, \mathbf{g}) = \min\{G_{X, F_0, F_1, Q, \mathbf{d}, \mathbf{g}}(\mathbf{v}) \mid \mathbf{v} \text{ is a subset of } H_2(X; \mathbb{Z})\}.$$

We call this function

$$G_{X, F_0, F_1} : \text{Sym}_\Lambda(\mathbb{Z}) \times \mathbb{Z}^\Lambda \times (\mathbb{Z}_{\geq 0})^{\Lambda - \{\lambda_0\}} \rightarrow \mathbb{Z} \cup \{\infty\}$$

the *relative genus function* of X with respect to F_0, F_1 .

Remark 4.4. Similarly to G_X , this function is an invariant of smooth structures. Namely, if X and Y are orientation preserving diffeomorphic, then $G_{X, F_0, F_1} = G_{Y, F_0, F_1}$ for each modules F_0 and F_1 . If X and Y are orientation reversing diffeomorphic, then $G_{X, F_0, F_1}(Q, \mathbf{d}, \mathbf{g}) = G_{Y, F_0, F_1}(-Q, \mathbf{d}, \mathbf{g})$ for each $(Q, \mathbf{d}, \mathbf{g}) \in \text{Sym}_\Lambda(\mathbb{Z}) \times \mathbb{Z}^\Lambda \times (\mathbb{Z}_{\geq 0})^{\Lambda - \{\lambda_0\}}$. Similarly to G_X^\pm , we can also define G_{X, F_0, F_1}^\pm .

5. PRODUCING EXOTIC SMOOTH STRUCTURES

To state the results of this paper simply, we use the following convention. For a smooth 4-manifold X , we say “ X admits infinitely many distinct (exotic) smooth

structures”, if there exist infinitely many smooth 4-manifolds which are all homeomorphic to X but mutually non-diffeomorphic. In this section we prove the following, which is a restatement of Theorem 1.1, using log transform, knot surgery and the relative genus function.

Theorem 5.1. *Let X be an arbitrary connected oriented smooth 4-manifold. Here X is allowed to be closed, or to have (possibly disconnected) boundary, or to be non-compact. Suppose that X smoothly contains a nucleus. Assume further that X can be embedded into a connected oriented closed smooth 4-manifold with $b_2^+ > 1$ whose Seiberg-Witten invariant does not vanish. Then X admits infinitely many exotic smooth structures.*

Throughout this section, we fix the notation as follows.

Definition 5.2. Let (N, T) and d_T be a nucleus and the divisor of T , respectively. Let X be an arbitrary connected oriented smooth 4-manifold which smoothly contains the nucleus N . Let Z be a closed connected oriented smooth 4-manifold with $b_2^+ > 1$ whose Seiberg-Witten invariant does not vanish, and let $\psi : X \rightarrow Z$ be a smooth embedding. Assume that $H_2(X; \mathbb{Z})/\text{Tor}$ is a free \mathbb{Z} -module, unless otherwise stated.

To construct the desired manifolds, we need the following data.

Definition 5.3 (Data set of X). (1) Let \widehat{T}, S be a basis of $H_2(N; \mathbb{Z})$ such that $[T] = d_T \cdot \widehat{T}$ and $S \cdot \widehat{T} = 1$ (see Lemma 3.5).

(2) Put $X^0 = X - \text{int } N$. Since ∂N is a homology 3-sphere, we get the decomposition

$$H_2(X; \mathbb{Z})/\text{Tor} = H_2(N; \mathbb{Z}) \oplus (H_2(X^0; \mathbb{Z})/\text{Tor}).$$

Let

$$(\psi|_{X^0})_* : H_2(X^0; \mathbb{Z})/\text{Tor} \rightarrow H_2(Z; \mathbb{Z})/\text{Tor}$$

be the homomorphism induced by the embedding $\psi|_{X^0} : X^0 \rightarrow Z$. Since

$$(H_2(X^0; \mathbb{Z})/\text{Tor})/\ker(\psi|_{X^0})_* \cong \text{Im}(\psi|_{X^0})_*$$

is a free \mathbb{Z} -module, we have a direct sum decomposition

$$H_2(X^0; \mathbb{Z})/\text{Tor} = F_{X^0} \oplus \ker(\psi|_{X^0})_*,$$

where F_{X^0} is a free \mathbb{Z} -module isomorphic to $\text{Im}(\psi|_{X^0})_*$. Note that F_{X^0} is finitely generated, because $H_2(Z; \mathbb{Z})/\text{Tor}$ is finitely generated. Put $k = \text{rank}(F_{X^0})$. Beware that k can be zero.

(3) Let $\{u_1, u_2, \dots, u_k\}$ and $\{u_\lambda \mid \lambda \in \Lambda_1\}$ be bases of F_{X^0} and $\ker(\psi|_{X^0})_*$, respectively. Note that

$$\mathbf{u} := \{S, \widehat{T}, u_1, u_2, \dots, u_k\} \cup \{u_\lambda \mid \lambda \in \Lambda_1\}$$

is a basis of $H_2(X; \mathbb{Z})/\text{Tor}$.

(4) For $1 \leq i \leq k$, define $g(u_i)$ by

$$g(u_i) = \begin{cases} g_{X^0}(u_i), & \text{if } u_i \cdot u_i \geq 0. \\ \max\{g_{X^0}(u_i), 1\}, & \text{if } u_i \cdot u_i < 0. \end{cases}$$

Remark 5.4. When $H_2(X; \mathbb{Z})$ is finitely generated (e.g. X is compact), it suffices to set $F_{X^0} = H_2(X^0; \mathbb{Z})/\text{Tor}$, ignoring the above definition. In this case, we do not need to use $\ker(\psi|_{X^0})_*$ in the following argument.

5.1. Construction 1: log transform. In this subsection, we construct infinitely many distinct exotic smooth structures on X using log transform.

Definition 5.5 (Data set of $X_{(p)}$). (1) Let p be a positive integer which is relatively prime to d_T . Let $N_{(p)}$ (resp. $X_{(p)}$) be the p -log transform of N (resp. X) along T . Let T_p denote the multiple fiber of $N_{(p)}$ (hence, of $X_{(p)}$). When the intersection form of N is even, and d_T is odd, we further assume that p is odd. Note that the intersection forms of $N_{(p)}$ and N are isomorphic by Lemma 3.6. Lemmas 3.1 and 3.6 thus imply the existence of a basis \widehat{T}_p, S_p of $H_2(N_{(p)}; \mathbb{Z})$ which satisfies

$$[T_p] = d_T \cdot \widehat{T}_p, \quad S_p \cdot S_p = S \cdot S, \quad \widehat{T}_p \cdot S_p = 1.$$

Note $S_1 = S$, since $N_{(1)} \cong N$ and $X_{(1)} \cong X$.

(2) Regard S_p as an element of $H_2(X_{(p)}; \mathbb{Z})$ through the homomorphism induced by the inclusion. For $p \geq 1$, define $g(S_p)$ by

$$g(S_p) = \begin{cases} g_{X_{(p)}}(S_p), & \text{if } S_p \cdot S_p \geq 0. \\ \max\{g_{X_{(p)}}(S_p), 1\}, & \text{if } S_p \cdot S_p < 0. \end{cases}$$

We here define integers p_n ($n = 1, 2, \dots$). Roughly speaking, the following conditions require that p_n is sufficiently larger than p_{n-1} for each n .

Definition 5.6. Put $p_1 = 1$. Define an integer sequence p_n ($n \geq 2$) so that it satisfies the following conditions (i)–(iv).

- (i) $p_n > p_{n-1}$, for each $n \geq 2$.
- (ii) $d_T(p_2 - 1) + u_i \cdot u_i > 2g(u_i) - 2$, for each $1 \leq i \leq k$.
- (iii) $d_T(p_n - 1) + S \cdot S > 2g(S_{p_{n-1}}) - 2$, for each $n \geq 2$.
- (iv) Each p_n ($n \geq 2$) is relatively prime to d_T .

In the case where the intersection form of N is even (i.e. $S \cdot S$ is even), and d_T is odd, we further assume the following (v).

- (v) Every p_n ($n \geq 2$) is odd.

We are now ready to define the desired manifolds.

Definition 5.7. Let X_n (resp. Z_n) ($n \geq 1$) be the p_n -log transform of X (resp. Z) along the torus T in the nucleus N .

Note that X_1 (resp. Z_1) is diffeomorphic to X (resp. Z). We here check topological types of X_n 's.

Lemma 5.8. *Every X_n ($n \geq 1$) is homeomorphic to X .*

Proof. Since X_n is obtained from X by replacing the copy of N with $N_{(p_n)}$, Lemma 3.6 shows the claim. \square

5.2. Detecting smooth structures. In this subsection, we detect smooth structures of X_n 's obtained in Subsection 5.1. To see differences of the relative genus functions, we choose an element $(Q, \mathbf{d}, \mathbf{g})$ as follows.

Definition 5.9. Let Λ be the disjoint union $\{0, 1, \dots, k+1\} \coprod \Lambda_1$, and put $\lambda_0 = 0 \in \Lambda$. Let $Q \in \text{Sym}_\Lambda(\mathbb{Z})$ be the intersection matrix of $H_2(X; \mathbb{Z})/\text{Tor}$ given by the basis \mathbf{u} . Define $\mathbf{d} = (d_\lambda)_{\lambda \in \Lambda}$ and $\mathbf{g} = (g_\lambda)_{\lambda \in \Lambda - \{\lambda_0\}}$ as follows:

$$\begin{aligned} d_0 &= 1, & d_1 &= d_T, & d_i &= 1 \quad (2 \leq i \leq k+1), & d_\lambda &= 0 \quad (\lambda \in \Lambda_1), \\ g_1 &= 1, & g_i &= g(u_{i-1}) \quad (2 \leq i \leq k+1), & g_\lambda &= 0 \quad (\lambda \in \Lambda_1). \end{aligned}$$

For this $(Q, \mathbf{d}, \mathbf{g})$, we obtain the following evaluation.

Proposition 5.10. *Let $(Q, \mathbf{d}, \mathbf{g}) \in \text{Sym}_\Lambda(\mathbb{Z}) \times \mathbb{Z}^\Lambda \times \mathbb{Z}^{\Lambda - \{\lambda_0\}}$ be the one in Definition 5.9. Then the following inequalities hold.*

- For each $n \geq 1$, $G_{X_n}(Q, \mathbf{d}, \mathbf{g}) \leq g(S_{p_n})$.
- For each $n \geq 2$, $g(S_{p_{n-1}}) < G_{X_n}(Q, \mathbf{d}, \mathbf{g})$.

Consequently $G_{X_n} \neq G_{X_m}$ for any $n \neq m$.

Proof. Put $\mathbf{u}_n = \{S_{p_n}, \widehat{T}_{p_n}, u_1, u_2, \dots, u_k\} \cup \{u_\lambda \mid \lambda \in \Lambda_1\}$, and regard \mathbf{u}_n as the subset of $H_2(X_n; \mathbb{Z})/\text{Tor}$ through the natural inclusions $N_{(p_n)} \rightarrow X_n$ and $X^0 \rightarrow X_n$. This \mathbf{u}_n is clearly a basis of $H_2(X_n; \mathbb{Z})/\text{Tor}$. By Definitions 5.3 and 5.5, we have

$$G_{X_n}(Q, \mathbf{d}, \mathbf{g}) \leq G_{X_n, Q, \mathbf{d}, \mathbf{g}}(\mathbf{u}_n) \leq g(S_{p_n}), \text{ for each } n \geq 1.$$

We next show $G_{X_n}(Q, \mathbf{d}, \mathbf{g}) > g(S_{p_{n-1}})$ for each $n \geq 2$. Here note that every u_λ ($\lambda \in \Lambda_1$) satisfies $u_\lambda \cdot w = 0$ for any $w \in H_2(X; \mathbb{Z})/\text{Tor}$, because $u_\lambda \in \ker(\psi|_{X^0})_*$. Suppose $G_{X_n}(Q, \mathbf{d}, \mathbf{g}) \leq g(S_{p_{n-1}})$. Then there exists a basis $\{v_\lambda \mid \lambda \in \Lambda\}$ of $H_2(X_n; \mathbb{Z})/\text{Tor}$ satisfying the following (i)–(v).

- (i) $v_0 \cdot v_0 = S \cdot S$, $v_1 \cdot v_1 = 0$, $v_i \cdot v_i = u_{i-1} \cdot u_{i-1}$ ($2 \leq i \leq k+1$).
- (ii) v_0 is represented by a smoothly embedded closed oriented surface of genus $g(S_{p_{n-1}})$.
- (iii) $d_T v_1$ is represented by a smoothly embedded torus.
- (iv) Each v_i ($2 \leq i \leq k+1$) is represented by a smoothly embedded closed oriented surface of genus $g(u_{i-1})$.
- (v) For any $\lambda \in \Lambda_1$ and any $w \in H_2(X_n; \mathbb{Z})/\text{Tor}$, they satisfy $v_\lambda \cdot w = 0$.

Since \mathbf{u}_n is a basis, for each $\lambda \in \Lambda$, there exists a set $\{a_\mu^{(\lambda)} \in \mathbb{Z} \mid \mu \in \Lambda\}$ satisfying

$$v_\lambda = a_0^{(\lambda)} S_{p_n} + a_1^{(\lambda)} \widehat{T}_{p_n} + a_2^{(\lambda)} u_1 + a_3^{(\lambda)} u_2 + \dots + a_{k+1}^{(\lambda)} u_k + \sum_{\mu \in \Lambda_1} a_\mu^{(\lambda)} u_\mu,$$

where $a_\mu^{(\lambda)} = 0$ all but finitely many μ 's. We may regard each v_λ ($\lambda \in \Lambda$) as an element of $H_2(Z_n; \mathbb{Z})$ (up to torsion) through the inclusion $X_n \rightarrow Z_n$.

Theorem 2.5 gives a class K of $H^2(Z_n; \mathbb{Z})$ such that

$$L^+ := K + (p_n - 1)PD([T_{p_n}]) \quad \text{and} \quad L^- := K - (p_n - 1)PD([T_{p_n}])$$

are Seiberg-Witten basic classes of Z_n . Applying the adjunction inequality to v_0 and the basic classes L^+ and L^- , we get the inequalities below.

$$\begin{aligned} 2g(S_{p_{n-1}}) - 2 &\geq \left| \langle K, v_0 \rangle + d_T(p_n - 1)a_0^{(0)} \right| + S \cdot S, \\ 2g(S_{p_{n-1}}) - 2 &\geq \left| \langle K, v_0 \rangle - d_T(p_n - 1)a_0^{(0)} \right| + S \cdot S. \end{aligned}$$

These inequalities imply

$$2g(S_{p_{n-1}}) - 2 \geq d_T(p_n - 1) \left| a_0^{(0)} \right| + S \cdot S.$$

The condition (iii) of p_n in Definition 5.6 thus shows $a_0^{(0)} = 0$. We next apply the adjunction inequality to v_1 and the basic classes L^+ and L^- . We then get

$$0 = \left| \langle K, v_1 \rangle + d_T(p_n - 1)a_0^{(1)} \right| = \left| \langle K, v_1 \rangle - d_T(p_n - 1)a_0^{(1)} \right|.$$

Since d_T and $p_n - 1$ are positive, this equality shows $a_0^{(1)} = 0$. We finally apply the adjunction inequality to each v_i ($2 \leq i \leq k + 1$) and the basic classes L^+ and L^- . We then get the inequalities below.

$$\begin{aligned} 2g(u_{i-1}) - 2 &\geq \left| \langle K, v_i \rangle + d_T(p_n - 1)a_0^{(i)} \right| + u_{i-1} \cdot u_{i-1}, \\ 2g(u_{i-1}) - 2 &\geq \left| \langle K, v_i \rangle - d_T(p_n - 1)a_0^{(i)} \right| + u_{i-1} \cdot u_{i-1}. \end{aligned}$$

These inequalities give

$$2g(u_{i-1}) - 2 \geq d_T(p_n - 1) \left| a_0^{(i)} \right| + u_{i-1} \cdot u_{i-1}.$$

The conditions (i) and (ii) of p_n in Definition 5.6 thus show $a_0^{(i)} = 0$ ($2 \leq i \leq k + 1$).

The condition (v) of the basis $\{v_\lambda \mid \lambda \in \Lambda\}$ shows $a_0^{(\lambda)} = 0$ for any $\lambda \in \Lambda_1$. We now have $a_0^{(\lambda)} = 0$ for all $\lambda \in \Lambda$. This contradicts the assumption that $\{v_\lambda \mid \lambda \in \Lambda\}$ is a basis of $H_2(X_n; \mathbb{Z})/\text{Tor}$. \square

This proposition and Lemma 5.8 clearly give the following.

Theorem 5.11. *Assume that $H_2(X; \mathbb{Z})/\text{Tor}$ is a free \mathbb{Z} -module. Then the smooth 4-manifolds X_n ($n \geq 1$) are all homeomorphic to X but mutually non-diffeomorphic with respect to the given orientations.*

We are now ready to prove Theorem 5.1.

Proof of Theorem 5.1. When $H_2(X; \mathbb{Z})/\text{Tor}$ is a free module, Theorem 5.1 clearly follows from the theorem above. We prove the general case, that is, we allow $H_2(X; \mathbb{Z})/\text{Tor}$ to be non-free module. We use the same definitions as in Definitions 5.2, 5.3, 5.5, 5.6 and 5.7, except for the following $(\psi|_{X^0})_*$ and F_{X^0} . Let

$$(\psi|_{X^0})_* : H_2(X^0; \mathbb{Z}) \rightarrow H_2(Z; \mathbb{Z})/\text{Tor}$$

be the homomorphism induced by the embedding $\psi|_{X^0}: X^0 \rightarrow Z$. Since

$$H_2(X^0; \mathbb{Z})/\ker(\psi|_{X^0})_* \cong \text{Im}(\psi|_{X^0})_*$$

is a free \mathbb{Z} -module, $H_2(X^0; \mathbb{Z})$ has a direct sum decomposition

$$H_2(X^0; \mathbb{Z}) = F_{X^0} \oplus \ker(\psi|_{X^0})_*,$$

where F_{X^0} is a finitely generated free \mathbb{Z} -module isomorphic to $\text{Im}(\psi|_{X^0})_*$. Put

$$F_0 = H_2(N; \mathbb{Z}) \oplus F_{X^0} \quad \text{and} \quad F_1 = \ker(\psi|_{X^0})_*.$$

Similarly to the proof of Proposition 5.10, we can show $G_{X_n, F_0, F_1} \neq G_{X_m, F_0, F_1}$ for any $n \neq m$ (Consider the subset $\mathbf{u}'_n = \{S_{p_n}, \widehat{T}_{p_n}, u_1, u_2, \dots, u_k\} \cup \ker(\psi|_{X^0})_*$ of $H_2(X_n; \mathbb{Z})$. Note that \mathbf{u}'_n is a generating set of $H_2(X; \mathbb{Z})$). Therefore the desired claim follows. \square

5.3. Construction 2: knot surgery. In this subsection, we construct infinitely many distinct exotic smooth structures on X using knot surgery.

Recall Definitions 5.2 and 5.3. In this subsection, as an additional condition of the nucleus (N, T) , we assume $d_T = 1$.

Definition 5.12. (1) Let K be a knot in S^3 , and let $\deg(\Delta_K)$ denote the maximal degree of the symmetrized Alexander polynomial of K . Let S_K be the primitive class of $H_2(N_K; \mathbb{Z})$ which satisfies $[T] \cdot S_K = 1$ and $S_K \cdot S_K = S \cdot S$ (see Lemma 3.7 and its proof).

(2) Regard S_K as an element of $H_2(X_K; \mathbb{Z})$ through the homomorphism induced by the inclusion. Define $g(S_K)$ by

$$g(S_K) = \begin{cases} g_{X_K}(S_K), & \text{if } S \cdot S \geq 0. \\ \max\{g_{X_K}(S_K), 1\}, & \text{if } S \cdot S < 0. \end{cases}$$

We here define an infinite sequence K_n ($n = 1, 2, \dots$) of knots in S^3 . Roughly speaking, the following conditions require that $\deg(\Delta_{K_n})$ is sufficiently larger than $\deg(\Delta_{K_{n-1}})$ for each n (Such a sequence of knots is known to exist (cf. p.366 of [19])).

Definition 5.13. Let K_1 be the unknot in S^3 . Let K_n ($n \geq 2$) be an infinite sequence of knots in S^3 which satisfies the following conditions (i)–(iii).

- (i) $\deg(\Delta_{K_n}) > \deg(\Delta_{K_{n-1}})$, for each $n \geq 2$.
- (ii) $2 \deg(\Delta_{K_2}) + u_i \cdot u_i > 2g(u_i) - 2$, for each $1 \leq i \leq k$.
- (iii) $2 \deg(\Delta_{K_n}) + S \cdot S > 2g(S_{K_{n-1}}) - 2$, for each $n \geq 2$.

We are now ready to define the desired manifolds.

Definition 5.14. Let Y_n (resp. Z_n) ($n \geq 1$) be the knot surgery of X (resp. Z) along the torus T with the knot K_n .

Note that Y_1 (resp. Z_1) is diffeomorphic to X (resp. Z). The reason is as follows. Since K_1 is unknot, $S^3 - \nu(K_1)$ is diffeomorphic to $S^1 \times D^2$. Therefore Y_1 is the 1-log transform of X on the cusp neighborhood (cf. Remark 2.3). Hence $Y_1 \cong X_{(1)} \cong X$ (cf. [25]).

Similarly to the proof of Proposition 5.10, we obtain the following evaluation.

Proposition 5.15. *Let $(Q, \mathbf{d}, \mathbf{g})$ be the one in Definition 5.9 (Note $d_T = 1$ in this case). Then the following inequalities hold.*

- For each $n \geq 1$, $G_{Y_n}(Q, \mathbf{d}, \mathbf{g}) \leq g(S_{K_n})$.
- For each $n \geq 2$, $g(S_{K_{n-1}}) < G_{Y_n}(Q, \mathbf{d}, \mathbf{g})$.

Consequently $G_{Y_n} \neq G_{Y_m}$ for any $n \neq m$.

This proposition and Lemma 3.7 clearly provide us the following.

Theorem 5.16. *Assume that $H_2(X; \mathbb{Z})/\text{Tor}$ is a free \mathbb{Z} -module and that $d_T = 1$. Then the smooth 4-manifolds Y_n ($n \geq 1$) are all homeomorphic to X , but mutually non-diffeomorphic with respect to the given orientations.*

Remark 5.17. Similarly to the proof of Theorem 5.1, we can prove Theorem 5.16 even when $H_2(X; \mathbb{Z})/\text{Tor}$ is not a free \mathbb{Z} -module. Note that, in this case, we need to slightly modify the construction of Y_n 's, similarly to the proof of Theorem 5.1.

5.4. Strengthening the constructions. In the previous subsections, we did not exclude the possibility that some of the 4-manifolds are orientation reversing diffeomorphic. In this subsection, we exclude this possibility by restricting the conditions of p_n 's and K_n 's in Definitions 5.6 and 5.13.

Let (N, T) , X , Z be as in Definition 5.2. Recall the definitions of X_n 's and Y_n 's in Definitions 5.7 and 5.14. We here strengthen the constructions of these manifolds as follows.

Definition 5.18. Assume that the integer sequence p_n ($n \geq 1$) in Definition 5.6 further satisfies the following (vi) and (vii). Then define $\widehat{X}_n = X_n$ ($n \geq 1$).

- (vi) $d_T(p_2 - 1) - u_i \cdot u_i > 2g(u_i) - 2$, for each $1 \leq i \leq k$.
- (vii) $d_T(p_n - 1) - S \cdot S > 2g(S_{p_{n-1}}) - 2$, for each $n \geq 2$.

Definition 5.19. Assume that $d_T = 1$ and that the sequence K_n ($n \geq 2$) of knots in Definition 5.13 further satisfies the following conditions (iv) and (v). Then define $\widehat{Y}_n = Y_n$ ($n \geq 1$).

- (iv) $2 \deg(\Delta_{K_2}) - u_i \cdot u_i > 2g(u_i) - 2$, for each $1 \leq i \leq k$.
- (v) $2 \deg(\Delta_{K_n}) - S \cdot S > 2g(S_{K_{n-1}}) - 2$, for each $n \geq 2$.

Similarly to the proof of Proposition 5.10, we obtain the following stronger evaluations.

Proposition 5.20. *Let $(Q, \mathbf{d}, \mathbf{g})$ be the one in Definition 5.9. Then the following inequalities hold.*

- For each $n \geq 1$, $G_{\widehat{X}_n}^\pm(Q, \mathbf{d}, \mathbf{g}) \leq g(S_{p_n})$.
- For each $n \geq 2$, $g(S_{p_{n-1}}) < G_{\widehat{X}_n}^\pm(Q, \mathbf{d}, \mathbf{g})$.

Consequently $G_{\widehat{X}_n}^\pm \neq G_{\widehat{X}_m}^\pm$ for any $n \neq m$.

Proposition 5.21. *Let $(Q, \mathbf{d}, \mathbf{g})$ be the one in Definition 5.9 (Note $d_T = 1$ in this case). Then the following inequalities hold.*

- For each $n \geq 1$, $G_{\widehat{Y}_n}^\pm(Q, \mathbf{d}, \mathbf{g}) \leq g(S_{K_n})$.
- For each $n \geq 2$, $g(S_{K_{n-1}}) < G_{\widehat{Y}_n}^\pm(Q, \mathbf{d}, \mathbf{g})$.

Consequently $G_{\widehat{Y}_n}^\pm \neq G_{\widehat{Y}_m}^\pm$ for any $n \neq m$.

These propositions provide us the stronger versions of Theorems 5.11 and 5.16.

Theorem 5.22. *Assume that $H_2(X; \mathbb{Z})/\text{Tor}$ is a free \mathbb{Z} -module. Then the following hold.*

- (1) \widehat{X}_n ($n \geq 1$) are all homeomorphic to X , but mutually non-diffeomorphic for any orientations.
- (2) \widehat{Y}_n ($n \geq 1$) are all homeomorphic to X , but mutually non-diffeomorphic for any orientations.

5.5. Remarks. We conclude this section making some remarks.

(1) Modifying the constructions of \widehat{X}_n 's and \widehat{Y}_n 's similarly to the proof of Theorem 5.1, we can show that Theorem 5.22 holds even when $H_2(X; \mathbb{Z})/\text{Tor}$ is not a free \mathbb{Z} -module.

(2) The constructions of X_n 's, Y_n 's, \widehat{X}_n 's and \widehat{Y}_n 's depend on the choice of the embedding $\psi : X \rightarrow Z$. When $H_2(X; \mathbb{Z})$ is finitely generated (e.g. X is compact) we can arrange the constructions so that they do not depend on the choice of ψ . See Remark 5.4.

(3) While we required the closed 4-manifold $Z \supset X$ to be $b_2^+(Z) > 1$ in Theorem 5.1, the same claim also holds if $\pi_1(Z) \cong 1$, $b_2^+(Z) = 1$ and $b_2^-(Z) \leq 9$. For the log transform construction, this can be seen as follows (the knot surgery case is similar). The adjunction inequality for the above Z was given, for example, in [36], though the inequality was proved only for surfaces with the non-negative self-intersection numbers. We can thus prove the desired claim by modifying the

conditions of the integer sequence p_n ($n \geq 1$) and the proof of Proposition 5.10, namely as follows. Choose the class S so that $S \cdot S > 0$. Then consider a basis $\mathbf{u}'_n = \{S_{p_n}, \widehat{T}_{p_n}, u_1 + l_1 S_{p_n}, u_2 + l_2 S_{p_n}, \dots, u_k + l_k S_{p_n}\} \cup \{u_\lambda \mid \lambda \in \Lambda_1\}$ of $H_2(X_n; \mathbb{Z})/\text{Tor}$, where each l_i is an integer satisfying $(u_i + l_i S_{p_n})^2 \geq 0$. Let $Q \in \text{Sym}_\Lambda(\mathbb{Z})$ be the intersection matrix given by the basis \mathbf{u}'_n , and let $\mathbf{d} \in \mathbb{Z}^\Lambda$ be the one in Definition 5.9. Since $g_{X_n}(u_i + l_i S_{p_n}) \leq g_{X^0}(u_i) + g_{N(p_n)}(l_i S_{p_n})$, the rest of the argument is similar, except that we use infinitely many different $\mathbf{g} \in \mathbb{Z}^{\Lambda - \{\lambda_0\}}$ to see differences of relative genus functions of X_n 's ($n \geq 1$).

6. COMPACT STEIN 4-MANIFOLDS

In this section, we briefly recall Stein 4-manifolds. For the definition of basic terms and more details, the reader can consult [25] and [33]. In this paper, we use Seifert framings and sometimes abbreviate them to framings. (When a knot goes over 4-dimensional 1-handles, then convert the diagram into the dotted circle notation and calculate its Seifert framing (cf. [25]).) We use the following terminologies in the rest of this paper.

Definition 6.1. (1) For a Legendrian knot K in $\#n(S^1 \times S^2)$ ($n \geq 0$), we denote by $tb(K)$ and $r(K)$ the Thurston-Bennequin number and the rotation number of K , respectively.

(2) We call a compact connected oriented 4-dimensional handlebody a *2-handlebody* if it consists of one 0-handle and 1- and 2-handles.

(3) We call a 2-handlebody a *Legendrian handlebody* if its 2-handles are attached along an oriented framed Legendrian link in $\partial(D^4 \cup 1\text{-handles}) = \#n(S^1 \times S^2)$ ($n \geq 0$). It is known that every 2-handlebody can be changed into a Legendrian handlebody by an isotopy of the attaching link of 2-handles, and orienting its components.

(4) We call a Legendrian handlebody a *Stein handlebody* if the framing of its each 2-handle K is $tb(K) - 1$.

Remark 6.2. For a given Legendrian knot, we can decrease its Thurston-Bennequin number by an arbitrary positive integer, by locally adding “zig-zags” to the knot.

Next we recall the following useful theorem.

Theorem 6.3 (Eliashberg [11], Gompf [24]. cf. [25]). *A compact, connected, oriented, smooth 4-manifold admits a Stein structure if and only if it can be represented as a Stein handlebody.*

We call a compact smooth 4-manifold with a Stein structure a *compact Stein 4-manifold*.

Example 6.4. Gompf nucleus $G(n)$ ($n \geq 2$) admits a Stein handlebody decomposition as shown in Figure 4.

One can similarly construct many other nuclei which admit Stein structures. These Stein nuclei are useful to construct exotic smooth structures. See Section 8.

Compact Stein 4-manifolds are known to admit the following useful embeddings, where minimal means that there exists no smoothly embedded 2-sphere with the self-intersection number -1 .

Theorem 6.5 (Lisca-Matić [28]). *Every compact Stein 4-manifold can be embedded into a minimal closed complex surface of general type with $b_2^+ > 1$.*

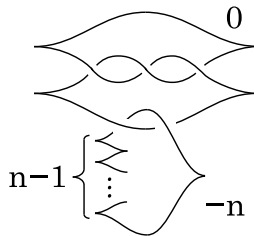

FIGURE 4. A Stein handlebody decomposition of $G(n)$ ($n \geq 2$).

Theorem 6.6 (Akbulut-Ozbagci [4]). *Every compact Stein 4-manifold can be embedded into a simply connected, minimal, closed, symplectic 4-manifold with $b_2^+ > 1$.*

Proof. (simply connectedness). Since “simply connected” is not claimed in [4], we explain only this part for completeness. We follow the proof in [4]. We first attach 2-handles to a given Stein 4-manifold to make it simply connected Stein 4-manifold. Then we apply the procedure prescribed in [4]. Namely, we attach 2-handles to this simply connected Stein 4-manifold so that it admits a Lefschetz fibration over D^2 . As their construction shows, this fibration can be extended to a Lefschetz fibration $X \rightarrow S^2$ by attaching $F \times D^2$ (i.e. 2-, 3- and 4-handles), where F denotes a regular fiber. As shown in [4], X is a (possibly non-minimal) closed symplectic 4-manifold with $b_2^+ > 1$. Note that X and $X - \nu(F)$ is simply connected. Taking the fiber sum of two copies of X , we get a simply connected, minimal, closed, symplectic 4-manifold with $b_2^+ > 1$ by a theorem of Stipsicz [40]. \square

Remark 6.7. Every closed symplectic 4-manifold with $b_2^+ > 1$ is known to have the non-vanishing Seiberg-Witten invariant (cf. [25]). Furthermore, it is known that every minimal closed complex surface of general type with $b_2^+ > 1$ has only one Seiberg-Witten basic class up to sign and that the square of the basic class is positive (see Theorems 3.4.22 and 3.4.19 of [25]).

7. CORKS AND W -MODIFICATIONS

In this section, we briefly recall corks ([1], [5]) and W -modifications ([6]).

7.1. Corks.

Definition 7.1. Let C be a compact contractible (Stein) 4-manifold with boundary and $\tau : \partial C \rightarrow \partial C$ an involution on the boundary. We call (C, τ) a *cork* if τ extends to a self-homeomorphism of C , but cannot extend to any self-diffeomorphism of C . For a cork (C, τ) and a smooth 4-manifold X which contains C , a *cork twist of X along (C, τ)* is defined to be the smooth 4-manifold obtained from X by removing the submanifold C and regluing it via the involution τ .

Note that Boyer’s theorem [9] tells that every self-diffeomorphism of the boundary ∂C extends to a self-homeomorphism of C , in the case where C is a compact contractible smooth 4-manifold.

Definition 7.2. Let W_n be the compact smooth 4-manifold in Figure 5. Let $f_n : \partial W_n \rightarrow \partial W_n$ be the diffeomorphism obtained by first surgering $S^1 \times D^3$ to $D^2 \times S^2$ in the interior of W_n , then surgering the other embedded $D^2 \times S^2$ back to $S^1 \times D^3$ (i.e. replacing the dot and 0 in Figure 5).

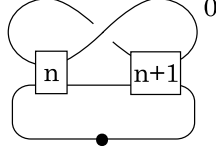
FIGURE 5. W_n

We can check that W_n is contractible and that f_n is an involution as follows. Changing the crossing of the attaching circle of the 2-handle of W_n as in the left picture of Figure 6, we get W_{n-1} by isotopy ([5]). Repeating this process (i.e. by homotopy), we get $W_0(\cong D^4)$. Hence W_n is contractible. Since the diagram of W_n is induced from a symmetric link, the 4-manifold obtained by replacing the dot and 0 is diffeomorphic to W_n . Fixing the identification of W_n (hence, of ∂W_n) by Figure 5, the diffeomorphism f_n becomes an involution of ∂W_n .

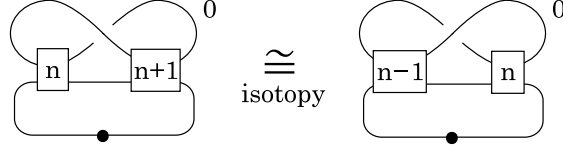
FIGURE 6. W_{n-1}

Theorem 7.3 (Theorem 2.5 of [5]). *For $n \geq 1$, the pair (W_n, f_n) is a cork.*

7.2. W -modifications. In this subsection, we recall W -modifications introduced in [6]. We first define them for smooth 2-handlebodies and later redefine them for Legendrian handlebodies. In this paper, the words the “attaching circle of a 2-handle” and a “smoothly embedded surface” are often abbreviated to a “2-handle” and a “surface”, if they are clear from the context.

Definition 7.4. Let p be a positive integer, and let K be a 2-handle of a (smooth) 2-handlebody X . Take a small segment of the attaching circle of K as in the first row of Figure 7.

We call the local operations shown in the left and the right side of Figure 7 a $W^+(p)$ -modification to K and a $W^-(p)$ -modification to K , respectively. Here we do not change the framing of K (ignore the orientations shown in the figure). They are clearly related by a cork twist along (W_1, f_1) as shown in the figure.

We will call the 0-framed 2-handle γ on the left (or right) side of the Figure 7 the *auxiliary 2-handle* of the $W^\pm(p)$ -modification of K . We will use the same symbol K for the new 2-handle obtained from the original K of X by the modification.

For convenience, we refer the $W^+(0)$ - and $W^-(0)$ -modifications as undone operations. For brevity, sometimes we will call these operations W^+ - and W^- -modifications when we do not need to specify the coefficients, or call them as W -modifications when we do not need to specify both the coefficient and \pm .

Similarly we can talk about $W^\pm(p)$ -modification for any cork (W, f) coming from a symmetric link. However, for simplicity, we will discuss the effects of W -modifications only when $(W, f) = (W_1, f_1)$.

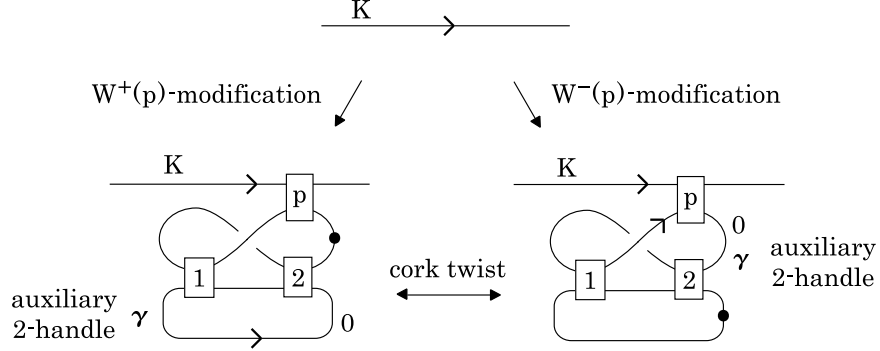

FIGURE 7. $W^\pm(p)$ -modifications ($p \geq 1$) (the framing of K is unchanged)

It is easy to check the following lemmas.

Lemma 7.5 (Proposition 4.2 of [6]). *Let X be a 2-handlebody. Then any W -modification to X does not change the isomorphism classes of the fundamental group, the integral homology groups, the integral homology groups of the boundary ∂X , and the intersection form of X .*

Lemma 7.6 (Proposition 4.5 of [6]). *Let X be a 2-handlebody. Let X^+ (resp. X^-) be the 2-handlebody obtained from X by applying a W^+ -modification (resp. W^- -modification). Then X^+ and X^- can be embedded into X . Furthermore, X can be embedded into X^- .*

Next we define Legendrian versions of W -modifications for Legendrian handlebodies (recall Definition 6.1).

Let K be a 2-handle of a Legendrian handlebody. Take a small segment of the attaching circle of K as in the first row of Figure 9. Without loss of generality, we may assume that the orientation of the segment of K is from the left to the right (Otherwise locally apply the Legendrian isotopy in Figure 8. Note that this isotopy does not change the Thurston-Bennequin number and the rotation number).

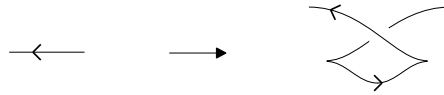

FIGURE 8. Legendrian isotopy

Definition 7.7. Let p be a positive integer. We call the local operations shown in the left and the right side of Figure 9 a $W^+(p)$ -modification to K and a $W^-(p)$ -modification to K , respectively. Here we orient the 2-handles as in the figure. Hence, each operation produces a new Legendrian handlebody from a given Legendrian handlebody. When we see Legendrian handlebodies as smooth handlebodies, these definitions and the orientations are consistent with those in Definition 7.7 and Figure 7 (We can check this just by converting the 1-handle notation). Note that the auxiliary 2-handle γ to any $W^+(p)$ - (resp. $W^-(p)$ -) modification satisfies the following: its framing is 0 (resp. 0); $tb(\gamma) = 2$ (resp. $tb(\gamma) = 1$); $r(\gamma) = 0$ (resp. $r(\gamma) = 1$).

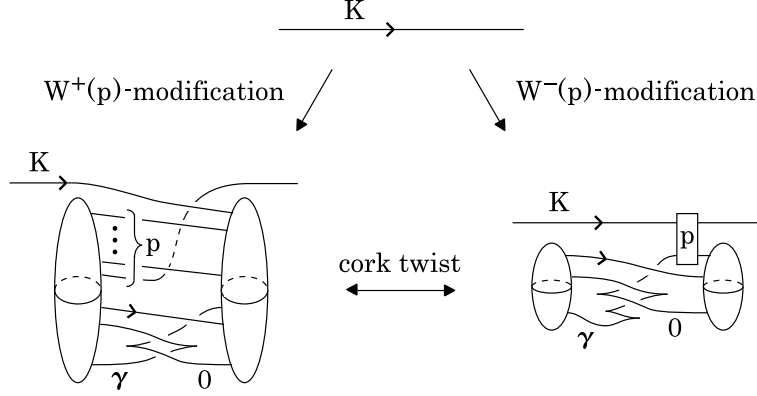

FIGURE 9. $W^+(p)$ - and $W^-(p)$ -modification ($p \geq 1$). Every framing is Seifert framing. The framing of K is unchanged.

The above definition clearly gives the following.

Proposition 7.8 ([6]). *Let K be a 2-handle of a Legendrian handlebody.*

- (1) *Every $W^+(p)$ -modification to K has the following effect.*
 - *$tb(K)$ is increased by p , and $r(K)$ is unchanged.*
- (2) *Every $W^-(p)$ -modification to K has the following effect.*
 - *$tb(K)$ and $r(K)$ are unchanged.*

8. EXOTIC SMOOTH STRUCTURES ON 4-MANIFOLDS WITH BOUNDARY

In this section, applying Theorem 1.1, we show that many compact 4-manifolds with boundary admit infinitely many distinct exotic smooth structures after W^+ -modifications. Namely, we prove the following, which is a restatement of Theorem 1.3.

Theorem 8.1. *Let X be a 2-handlebody which contains a nucleus N as a subhandlebody. Suppose that N admits a Stein structure. Then, there exists a compact connected oriented smooth 4-manifold X_0 which satisfies the following.*

- (1) *X_0 admits infinitely many distinct exotic smooth structures.*
- (2) *The fundamental group, the integral homology groups, the integral homology groups of the boundary, and the intersection form of X_0 are isomorphic to those of X .*
- (3) *X_0 (resp. X) can be embedded into X (resp. X_0).*

Proof. Since N admits a Stein structure, we may assume that the subhandlebody N itself is a Stein handlebody (if necessary by changing the decomposition of N). Let L_1, L_2, \dots, L_k denote all the 2-handles of X except those of N . By isotopy of the attaching circles of L_1, L_2, \dots, L_k , we may assume that X is a Legendrian handlebody (cf. Section 4.2 of [33]). Note that we keep the Stein handle decomposition of N unchanged. We next apply $W^+(p_i)$ -modification to each L_i ($1 \leq i \leq k$), where p_i is a sufficiently large integer. Then we can add zig-zags to each L_i and each auxiliary 2-handle so that the Seifert framings of the resulting 2-handles are one less than their Thurston-Bennequin numbers. The resultant handlebody (say X_1) is clearly a Stein handlebody and contains the nucleus N . Hence, we can

embed X_1 into a closed symplectic 4-manifold with $b_2^+ > 1$. Theorem 1.1 thus shows that X_1 admits infinitely many exotic smooth structures. Let X_0 be the 4-manifold obtained from X_1 by replacing the each $W^+(p_i)$ -modification ($1 \leq i \leq k$) to $W^-(p_i)$ -modification. Namely, X_0 is the 4-manifold obtained from X_1 by cork twists along disjoint copies of W_1 . X_1 is thus homeomorphic to X_0 . Hence the claim (1) follows. Lemmas 7.5 and 7.6 clearly give the claims (2) and (3). \square

This theorem immediately gives the following.

Corollary 8.2. *Let Y be a 2-handlebody, and let N be a nucleus which admits a Stein structure. Put $X = Y \natural N$. Then there exists a compact connected oriented smooth 4-manifold X_0 which satisfies (1)–(3) of Theorem 8.1.*

Since every finitely presented group (resp. integral symmetric bilinear form $\mathbb{Z}^k \times \mathbb{Z}^k \rightarrow \mathbb{Z}$ ($k \geq 0$)) is realized as the fundamental group (resp. intersection form) of a 2-handlebody, we have the following corollary. Note that (1) also follows from a result of Park [37].

Corollary 8.3. (1) *Let G be any finitely presented group. Then there exists a compact connected oriented smooth 4-manifold with boundary such that it admits infinitely many distinct exotic smooth structures and that its fundamental group is isomorphic to G .*

(2) *Let $Q : \mathbb{Z}^k \times \mathbb{Z}^k \rightarrow \mathbb{Z}$ ($k \geq 0$) be any integral symmetric bilinear form, and let $R : \mathbb{Z}^2 \times \mathbb{Z}^2 \rightarrow \mathbb{Z}$ be any integral, indefinite, unimodular symmetric bilinear form. Then there exists a simply connected compact oriented smooth 4-manifold with boundary such that it admits infinitely many distinct exotic smooth structures and that its intersection form is isomorphic to $Q \oplus R$.*

Remark 8.4. Akbulut and the author [6] recently constructed finitely many smooth structures on 4-manifolds with boundary and with $b_2 \geq 1$, using W -modifications. However, to the author’s knowledge, there are no examples of compact 4-manifolds with $b_2 = 1$ which admits infinitely many exotic smooth structures. Since Akbulut [3] proved that knot surgery produces at least one exotic smooth structure of the cusp neighborhood C , it is interesting to see whether knot surgery produces infinitely many exotic smooth structures on C .

9. 3-MANIFOLDS BOUNDING EXOTIC 4-MANIFOLDS

To state the results simply and precisely, we recall the following convention. For a closed oriented 3-manifold M and an oriented 4-manifold X , we say “ M bounds X ” if the oriented boundary of X is diffeomorphic to M .

In this section, we prove that many 3-manifolds bound (simply connected) 4-manifolds which admit infinitely many smooth structures, applying Theorem 1.1. Namely, we show that many 3-manifolds bound (simply connected) 4-manifolds satisfying the assumption of Theorem 1.1.

A compact connected oriented 3-manifold M is said to be *Stein fillable* if there exists a compact connected Stein 4-manifold whose boundary is orientation preserving diffeomorphic to M . We first prove the following theorem, which is a restatement of Theorem 1.5.

Theorem 9.1. (1) *Every Stein fillable 3-manifold bounds a simply connected compact oriented smooth 4-manifold which admits infinitely many distinct smooth structures.*

(2) Let n be any positive integer, and let M_1, M_2, \dots, M_n be any Stein fillable 3-manifolds. Then the disjoint union $M = \coprod_{i=1}^n M_i$ bounds a simply connected compact oriented smooth 4-manifold which admits infinitely many distinct smooth structures.

Proof. (1) Let M be a Stein fillable 3-manifold, and let \widetilde{M} be a Stein handlebody with $\partial\widetilde{M} \cong M$. Convert the 1-handle notation of the handlebody diagram of \widetilde{M} into the dotted circle notation. This naturally gives a framed link L in S^3 such that the Dehn surgery along L gives M . Here recall the Wirtinger presentation of $\pi_1(S^3 - \text{int } \nu(L))$. This group is generated by a link (say \mathbf{m}) which consists of meridians of L (cf. Exercise 5.2.2.(b) of [25]). Since M is obtained from $S^3 - \text{int } \nu(L)$ by attaching 3-dimensional 2- and 3-handles, the link \mathbf{m} in M also generates $\pi_1(M)$. Attach 4-dimensional 2-handles to \widetilde{M} along a Legendrianization of the link \mathbf{m} so that the resulting handlebody (say Y) is a Stein handlebody. This construction shows $\pi_1(Y - \text{int } \widetilde{M}) \cong 1$.

Let N be a nucleus which admits a Stein structure (e.g. Gompf nucleus $G(n)$ ($n \geq 2$)). The boundary sum $Y \natural N$ clearly admits a Stein handle decomposition. We can thus embed $Y \natural N$ into a closed symplectic 4-manifold Z with $b_2^+ > 1$, using a method of Akbulut-Ozbagci in [4]. Their method (cf. the proof of Theorem 6.6) allows us to assume that Z is obtained from $Y \natural N$ by attaching 2-, 3-, and 4-handles only. Note that we do not assume the minimality of Z . Since $\pi_1((Y \natural N) - \text{int } \widetilde{M}) \cong 1$, the 4-manifold $X := Z - \text{int } \widetilde{M}$ is simply connected.

Theorem 1.1 shows that X (hence the reverse orientation \overline{X} of X) has infinitely many distinct exotic smooth structures, because X contains the nucleus N and is embedded into Z . Note $\partial\overline{X} \cong M$.

(2) Let M_i ($1 \leq i \leq n$) and M be as in the assumption, and let \widetilde{M}_i ($1 \leq i \leq n$) be a Stein handlebody with $\partial\widetilde{M}_i \cong M_i$. Similarly to (1), for each $1 \leq i \leq n$, we obtain a Stein handlebody Y_i such that Y_i contains \widetilde{M}_i and that $\pi_1(Y_i - \text{int } \widetilde{M}_i) \cong 1$. Let \widetilde{M} denote the disjoint union $\coprod_{i=1}^n \widetilde{M}_i$, and let Y denote the boundary sum $\natural_{i=1}^n Y_i$. Let N be a nucleus which admits a Stein structure. Then the boundary sum $Y \natural N$ is clearly a Stein handlebody. Note that the complement $(Y \natural N) - \text{int } \widetilde{M} (= N \natural_{i=1}^n (Y_i - \text{int } \widetilde{M}_i))$ is simply connected. Similarly to (1), a method of Akbulut-Ozbagci in [4] gives a closed symplectic 4-manifold Z with $b_2^+ > 1$ such that Z contains $Y \natural N$ and that $X := Z - \text{int } \widetilde{M}$ is simply connected. Since X contains the nucleus N and is embedded into Z , Theorem 1.1 shows that X (hence the reverse orientation \overline{X}) admits infinitely many distinct exotic smooth structures. Note $\partial\overline{X} \cong M$. \square

We extend this theorem to more general 3-manifolds, ignoring simple connectivity of 4-manifolds. Here we briefly recall weakly symplectically fillable 3-manifolds. For details, the reader can consult [33]. A compact symplectic manifold (X, ω) is said to have *weakly convex boundary* if its boundary ∂X admits a contact structure ξ such that $\omega|_\xi > 0$. A closed oriented 3-manifold M is said to be *weakly symplectically fillable* if M bounds a compact symplectic 4-manifold with weakly convex boundary. Such a symplectic 4-manifold is called a *weak symplectic filling* of M . It is known that a compact Stein 4-manifold is a symplectic 4-manifold with weakly convex boundary. Stein fillable 3-manifolds are thus weakly symplectically fillable. For the following Theorem 9.2.(2), see also the schematic picture in Figure 10.

Theorem 9.2. (1) *Every connected weakly symplectically fillable 3-manifold bounds a compact connected oriented smooth 4-manifold which admits infinitely many distinct smooth structures.*

(2) *Let n and m_1, m_2, \dots, m_n be any positive integers. Let each $M_j^{(i)}$ ($i \in \{1, 2, \dots, n\}$, $j \in \{1, 2, \dots, m_i\}$) be a connected oriented closed 3-manifold. Let M denote the disjoint union $\coprod_{i=1}^n (\#_{j=1}^{m_i} M_j^{(i)})$. Assume that, for each $1 \leq i \leq n$, the disjoint union $\coprod_{j=1}^{m_i} M_j^{(i)}$ bounds a compact connected oriented smooth 4-manifold Y_i . Assume further that the disjoint union $Y := \coprod_{i=1}^n Y_i$ can be embedded into a compact connected symplectic 4-manifold with weakly convex boundary. Then M bounds a compact connected oriented smooth 4-manifold which admits infinitely many distinct smooth structures.*

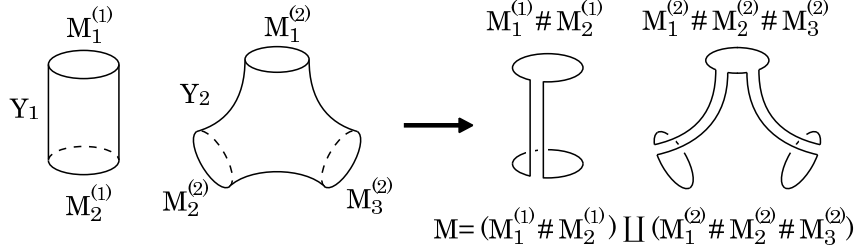

FIGURE 10. A schematic picture of Theorem 9.2.(2) ($\dim M = 1$)

Proof. (1) Let M be a weakly symplectically fillable 3-manifold, and let \widetilde{M} be a weak symplectic filling of M . The contact 3-manifold $\partial\widetilde{M} = M$ is represented by a contact (± 1) -surgery along a Legendrian link L in the standard contact S^3 ([10]). Attach two 2-handles to $\partial\widetilde{M}$ along the framed Legendrian link as shown in Figure 4, where we draw the link in a 3-ball away from L in S^3 (the framings in the figure are the Seifert framings.). The resulting 4-manifold is clearly the boundary sum $\widetilde{M} \natural G(n)$ ($n \geq 2$). According to a theorem of Weinstein [42] (see also Theorem 5.8 of [14]), this construction ensures that $\widetilde{M} \natural G(n)$ admits a symplectic structure with weakly convex boundary. By a theorem of Eliashberg [12] and Etnyre [13], we can embed $\widetilde{M} \natural G(n)$ into a closed symplectic 4-manifold Z with $b_2^+ > 1$. (The $b_2^+ > 1$ condition is easily verified by using an embedding of $\widetilde{M} \natural G(n) \natural G(n)$.) Theorem 1.1 thus shows that $X := Z - \text{int } \widetilde{M}$ admits infinitely many distinct exotic smooth structures. Note $\partial\overline{X} \cong M$.

(2) Let S be a compact connected symplectic 4-manifold with weakly convex boundary which contains Y . Similarly to the proof of (1), we obtain a closed connected symplectic 4-manifold Z with $b_2^+ > 1$ which contains $S \natural G(k)$ ($k \geq 2$). Put $M_i = \#_{j=1}^{m_i} M_j^{(i)}$ ($1 \leq i \leq n$) and $Z^0 = Z - \text{int } Y$. Since each Y_i ($1 \leq i \leq n$) is path connected, we can take a path $\gamma_j^{(i)} \subset Y_i$ which connects points of $M_1^{(i)}$ and $M_j^{(i)}$, for each $2 \leq j \leq m_i$. By dimensional reason, we may assume that $\gamma_2^{(i)}, \gamma_3^{(i)}, \dots, \gamma_{m_i}^{(i)}$ are smoothly embedded mutually disjoint paths in Y_i . Taking their regular neighborhoods, we get the corresponding $(m_i - 1)$ mutually disjoint 4-dimensional 1-handles $\widehat{\gamma}_2^{(i)}, \widehat{\gamma}_3^{(i)}, \dots, \widehat{\gamma}_{m_i}^{(i)} \subset Y_i$ for each $1 \leq i \leq n$. The attaching

region of each $\widehat{\gamma}_j^{(i)}$ is located in $M_1^{(i)} \amalg M_j^{(i)}$. Note that these 1-handles naturally give the connected sum $M_i = \#_{j=1}^{m_i} M_j^{(i)}$ embedded in Y_i . Using these 1-handles $\widehat{\gamma}_2^{(i)}, \widehat{\gamma}_3^{(i)}, \dots, \widehat{\gamma}_{m_i}^{(i)}$ ($1 \leq i \leq n$), we join connected components of Z^0 in Z . Let X be the resulting compact oriented smooth 4-manifold. This construction shows that, for each $1 \leq i \leq n$, $M_1^{(i)}, M_2^{(i)}, \dots, M_{m_i}^{(i)}$ belong to the same connected component of X . Since $\partial Y_i = \amalg_{j=1}^{m_i} M_j^{(i)}$, this shows that the number of connected components of X is the same as that of $X \cup (\amalg_{i=1}^n Y_i)$. Thus X is connected, because $X \cup (\amalg_{i=1}^n Y_i) = Z$. Note that X contains the nucleus N and that $\partial X = \overline{M}$. Theorem 1.1 thus shows that X admits infinitely many distinct smooth structures. \square

Corollary 9.3. *Let M be a weakly symplectically fillable 3-manifold. Then $M \# \overline{M}$ bounds a compact connected oriented smooth 4-manifold which admits infinitely many distinct smooth structures.*

Proof. Let \widetilde{M} be a weak symplectic filling of M . Note that $Y = M \times [0, 1]$ is embedded into \widetilde{M} and that $\partial Y = M \amalg \overline{M}$. Thus, the desired claim follows from Theorem 9.2.(2). \square

This corollary provides non weakly symplectically fillable 3-manifolds bounding 4-manifolds which admit infinitely many smooth structures.

Example 9.4. Let $\Sigma(2, 3, 5)$ denote the Poincaré homology sphere. Since $\Sigma(2, 3, 5)$ is Stein fillable, the above corollary shows that $\Sigma(2, 3, 5) \# \overline{\Sigma(2, 3, 5)}$ bounds a compact connected oriented smooth 4-manifold which admits infinitely many distinct smooth structures. Note that $\Sigma(2, 3, 5) \# \overline{\Sigma(2, 3, 5)}$ is not weakly symplectically fillable (hence, non Stein fillable) for both orientations ([27]).

10. NON-EXISTENCE OF STEIN STRUCTURES

In this section, we show that log transform and knot surgery do not produce compact Stein 4-manifolds under a mild condition.

Lemma 10.1. *Let X be a compact connected oriented smooth 4-manifold (possibly with boundary) which contains a torus T . Let $X_{(p)}$ ($p \geq 1$) and X_K be the p -log transform along T and the knot surgery along T with a knot K , respectively. Then the following hold.*

- (1) *Assume that T is a c -embedded torus. Then $[T]$ is non-torsion in $H_2(X; \mathbb{Z})$ if and only if $[T_p]$ is non-torsion in $H_2(X_{(p)}; \mathbb{Z})$.*
- (2) *$[T]$ is non-torsion in $H_2(X; \mathbb{Z})$ if and only if $[T]$ is non-torsion in $H_2(X_K; \mathbb{Z})$, where the last $[T]$ denotes the class of a parallel copy of the original T . (This holds even when $T \subset X$ is not c -embedded.)*

Proof. (1) Applying the p -log transform procedure in Figure 17 of [5] to the cusp neighborhood C , we easily see $\pi_1(C_{(p)}) \cong \mathbb{Z}/p\mathbb{Z}$. The Mayer-Vietoris exact sequences for $X = (X - \text{int } C) \cup C$ and $X_{(p)} = (X - \text{int } C_{(p)}) \cup C_{(p)}$ thus imply $b_1(X_{(p)}) = b_1(X)$.

Suppose that $[T]$ is non-torsion in $H_2(X; \mathbb{Z})$. We show that $[T_p]$ is non-torsion in $H_2(X_{(p)}; \mathbb{Z})$. It suffices to see that the homomorphism $H_2(\nu(T_p); \mathbb{Q}) \rightarrow H_2(X_{(p)}; \mathbb{Q})$ induced by the inclusion is injective.

(i) The case where X is closed. Suppose that the above homomorphism is not injective, thus, a 0-map. Then we can easily show $b_3(X_{(p)}) = b_3(X) - 1$ by

using two homology exact sequences for the pairs $(X, \nu(T))$ and $(X_{(p)}, \nu(T_p))$ (Note $H_*(X, \nu(T)) \cong H_*(X_{(p)}, \nu(T_p))$). Since X and $X_{(p)}$ are closed 4-manifolds, we have $b_1(X_{(p)}) = b_3(X_{(p)})$ and $b_1(X) = b_3(X)$. We thus get $b_1(X_{(p)}) \neq b_1(X)$, which is a contradiction. Hence the homomorphism $H_2(\nu(T_p); \mathbb{Q}) \rightarrow H_2(X_{(p)}; \mathbb{Q})$ is injective.

(ii) The case where X has non-empty boundary. Take a double DX of X to form a closed 4-manifold. The Mayer-Vietoris exact sequence shows that the inclusion induced homomorphism $H_2(X; \mathbb{Q}) \rightarrow H_2(DX; \mathbb{Q})$ is injective. The required claim in the closed case thus shows that the inclusion induced homomorphism $H_2(\nu(T_p); \mathbb{Q}) \rightarrow H_2((DX)_{(p)}; \mathbb{Q})$ is injective. Therefore, the homomorphism $H_2(\nu(T_p); \mathbb{Q}) \rightarrow H_2(X_{(p)}; \mathbb{Q})$ is injective.

Conversely, suppose that $[T_p]$ is non-torsion in $H_2(X_{(p)}; \mathbb{Z})$. Then the same argument as above shows that $H_2(\nu(T); \mathbb{Q}) \rightarrow H_2(X; \mathbb{Q})$ is injective.

(2) By the gluing condition of knot surgery, we can easily check $b_1(X_K) = b_1(X)$ using the Mayer-Vietoris exact sequences. Let T_K be the torus given in Definition 2.6. The natural inclusion induces an isomorphism $H_2(\nu(T_K); \mathbb{Q}) \rightarrow H_2((S^3 - \nu(K)) \times S^1; \mathbb{Q})$. Note that $[T_K] = [T]$ in $H_2(X_K; \mathbb{Q})$ and that $H_*((S^3 - \nu(K)) \times S^1; \mathbb{Q}) \cong H_*(T^2 \times D^2; \mathbb{Q})$. The following conditions (a) and (b) are thus equivalent: (a) The inclusion induced homomorphism $H_2(\nu(T); \mathbb{Q}) \rightarrow H_2(X_K; \mathbb{Q})$ is injective; (b) The inclusion induced homomorphism $H_2((S^3 - \nu(K)) \times S^1; \mathbb{Q}) \rightarrow H_2(X_K; \mathbb{Q})$ is injective. Since $H_*(X, \nu(T)) \cong H_*(X_K, (S^3 - \nu(K)) \times S^1)$, the rest of the proof is similar to the (1) case. \square

Remark 10.2. If T is not c -embedded, Lemma 10.1.(1) does not always hold. For example, put $T = T^2 \times \{pt.\}$ in $T^2 \times S^2$. Then, applying the procedure in [5], we easily see that the p -log transform ($p \geq 1$) of $T^2 \times S^2$ is diffeomorphic to $S^1 \times S^3$. Consequently $[T_p] = 0$, while $[T]$ is non-torsion in $H_2(T^2 \times S^2; \mathbb{Z})$.

Lemma 10.3. *Let X be a compact connected oriented smooth 4-manifold with boundary which contains a cusp neighborhood. Then the reverse orientation \overline{X} of X does not admit any Stein structure.*

Proof. By the assumption, the boundary sum $\overline{X} \natural G(n)$ ($n \geq 2$) contains the boundary sum $\overline{C} \natural G(n)$, where $G(n)$ and \overline{C} denote the Gompf nucleus and the reverse orientation of C , respectively. A handlebody picture of $\overline{C} \natural G(n)$ is given in Figure 11. Sliding the right trefoil knot over the left trefoil knot, we get a 0-framed ribbon knot. This ribbon knot gives a smoothly embedded sphere $\Sigma \subset \overline{C} \natural G(n)$ with $\Sigma \cdot \Sigma = 0$. Now suppose that \overline{X} admits a Stein structure. Then $\overline{X} \natural G(n)$ admits a Stein structure, because $G(n)$ also admits a Stein structure (Example 6.4). We can thus embed the Stein 4-manifold $\overline{X} \natural G(n)$ into a closed symplectic 4-manifold Z with $b_2^+ > 1$. Note that the sphere Σ represents a non-torsion class of $H_2(Z; \mathbb{Z})$, because it algebraically intersects with the obvious sphere with the self-intersection number $-n$. Since $[\Sigma] \cdot [\Sigma] = 0$, this contradicts the adjunction inequality. \square

The following is a restatement of Theorem 1.6.

Theorem 10.4. *Let X be a compact connected oriented smooth 4-manifold with boundary which contains a c -embedded torus T . Assume that $[T]$ is non-torsion in $H_2(X; \mathbb{Z})$. Let $X_{(p)}$ and X_K denote the p -log transform along T and the knot surgery along T with a knot K , respectively. Then the following hold.*

(1) For $p \geq 2$, $X_{(p)}$ does not admit any Stein structure for both orientations.

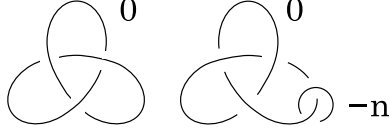
FIGURE 11. $\overline{\mathcal{C}}_n G(n)$

(2) For any knot K in S^3 with the non-trivial Alexander polynomial, X_K does not admit any Stein structure for both orientations.

We give two proofs of this theorem, using two different embeddings of a Stein 4-manifold. Namely, Lisca-Matić's embedding into a minimal complex surfaces of general type and Akbulut-Ozbagci's embedding into a closed symplectic 4-manifold. While our second proof is a little more technical, we hope that the second proof is useful to show non-existence of some other structures under some conditions, since a symplectic 4-manifold with weakly convex boundary also can be embedded into a closed symplectic 4-manifold ([12], [13]).

Proof 1 of Theorem 10.4. (1) By Lemma 10.1, $[T_p]$ is non-torsion in $H_2(X_{(p)}; \mathbb{Z})$. Suppose that $X_{(p)}$ with the orientation induced from X admits a Stein structure. Then $X_{(p)}$ has a Stein handlebody decomposition. Attach a 2-handle along the meridian of the attaching circle of each 2-handle of the Stein handlebody $X_{(p)}$ so that the resulting manifold (say $Y_{(p)}$) is a Stein handlebody. Theorem 6.5 thus gives a minimal complex surface (say $Z_{(p)}$) of general type and with $b_2^+ > 1$ which contains $Y_{(p)} \supset X_{(p)}$. The construction of $Y_{(p)}$ ensures that $[T_p]$ is non-torsion in $H_2(Z_{(p)}; \mathbb{Z})$.

Since $X_{(p)}$ is the p -log transform of X along T , reversing this operation along T_p in $Z_{(p)}$, we obtain a closed oriented smooth 4-manifold (say Z) which contains X . Note that $Z_{(p)}$ is the p -log transform of Z along the c -embedded torus T in $X \subset Z$. Since $[T_p]$ is non-torsion in $H_2(Z_{(p)}; \mathbb{Z})$, Lemma 10.1 shows that $[T]$ is non-torsion in $H_2(Z; \mathbb{Z})$. It is easy to see $b_2^+(Z) > 1$. Theorem 2.5 thus gives a class K of $H^2(Z_{(p)}; \mathbb{Z})$ such that

$$L_1 := K + (p-1)PD([T_p]) \quad \text{and} \quad L_2 := K - (p-1)PD([T_p])$$

are Seiberg-Witten basic classes of $Z_{(p)}$, because the Seiberg-Witten invariant of the complex surface $Z_{(p)}$ does not vanish. Since $[T_p]$ is non-torsion, we get $L_1 \neq L_2$. Since the minimal complex surface Z of general type has only one basic class up to sign (Remark 6.7), we have $L_1 + L_2 = 0$. This shows $2K = 0$. Applying the adjunction inequality to L_1 and $[T_p]$, we get $\langle K, [T_p] \rangle = 0$. The square of L_1 is thus zero. This is a contradiction (see Remark 6.7). Hence $X_{(p)}$ does not admit any Stein structure. Since $X_{(p)}$ still contains (a smaller copy of) the cusp neighborhood, Lemma 10.3 shows that the reverse orientation $\overline{X}_{(p)}$ of $X_{(p)}$ admits no Stein structures.

The proof of (2) is similar to the above. □

Proof 2 of Theorem 10.4. (1) By Lemma 10.1, $[T_p]$ is non-torsion in $H_2(X_{(p)}; \mathbb{Z})$. Suppose that $X_{(p)}$ with the orientation induced from X admits a Stein structure. Then $X_{(p)}$ has a Stein handlebody decomposition. For each 2-handle K of the Stein handlebody $X_{(p)}$, take a small segment of the attaching circle and attach

a 2-handle as in Figure 12. The resulting manifold (say $Y_{(p)}$) is clearly a Stein handlebody. Theorem 6.6 thus gives a closed symplectic 4-manifold (say $Z_{(p)}$) with $b_2^+ > 1$ which contains $Y_{(p)}$. The construction of $Y_{(p)}$ ensures the existence of a smoothly embedded sphere S in $Z_{(p)}$ which satisfies $[S] \cdot [S] = -2$ and $[S] \cdot [T_p] \geq 3$.

Reversing the p -log transform operation along T_p in $Z_{(p)}$, we obtain a closed oriented smooth 4-manifold (say Z) which contains X . Note that $Z_{(p)}$ is the p -log transform of Z along the c -embedded torus T in $X \subset Z$. Since the Seiberg-Witten invariant of the symplectic 4-manifold $Z_{(p)}$ does not vanish, Theorem 2.5 gives a class K of $H^2(Z_{(p)}; \mathbb{Z})$ such that $K + (p-1)PD([T_p])$ and $K - (p-1)PD([T_p])$ are Seiberg-Witten basic classes of $Z_{(p)}$. Applying the adjunction inequality to these basic classes and the sphere S , we get the following inequalities:

$$\begin{aligned} |\langle K, [S] \rangle + (p-1)[T_p] \cdot S| - 2 &\leq 0, \\ |\langle K, [S] \rangle - (p-1)[T_p] \cdot S| - 2 &\leq 0. \end{aligned}$$

This gives $-2 \leq [S] \cdot [T_p] \leq 2$, which contradicts the fact $[S] \cdot [T_p] \geq 3$. Hence $X_{(p)}$ does not admit any Stein structure. Since $X_{(p)}$ still contains (a smaller copy of) the cusp neighborhood, Lemma 10.3 shows that the reverse orientation $\overline{X}_{(p)}$ admits no Stein structures.

The proof of (2) is similar to (1). □

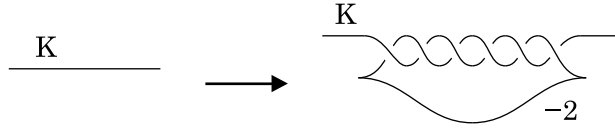

FIGURE 12.

Remark 10.5. (1) In the $p \geq 3$ (resp. $\deg(\Delta_K) \geq 2$) case, we can simplify the first proof as follows. Since $[T_p]$ (resp. $[T]$) is non-torsion in $H_2(Z_{(p)}; \mathbb{Z})$ (resp. $H_2(Z_K; \mathbb{Z})$), Theorem 2.5 (resp. Theorem 2.8) implies that the number of Seiberg-Witten basic classes of $Z_{(p)}$ (resp. Z_K) is larger than two. This is a contradiction. (2) If Theorem 2.8 holds for non c -embedded torus, the above proofs show that Theorem 10.4.(2) holds even when T is not c -embedded. On the other hand, Theorem 10.4.(1) does not always hold when T is not c -embedded. Actually, any log transform of $T^2 \times D^2$ along the obvious torus produces $T^2 \times D^2$ itself, because any self-diffeomorphism of the boundary $S^1 \times S^1 \times S^1$ extends to a self-diffeomorphism of its color neighborhood $S^1 \times S^1 \times S^1 \times [0, 1]$. $T^2 \times D^2$ is known to admit a Stein structure.

11. STEIN 4-MANIFOLDS AND NON-STEIN 4-MANIFOLDS

In this section we construct arbitrary many Stein 4-manifolds and infinitely many non-Stein 4-manifolds which are all homeomorphic but mutually non-diffeomorphic. Namely, we prove the following theorem, which is a restatement of Theorem 1.7.

Theorem 11.1. *Let X be a 2-handlebody which contains a nucleus N as a sub-handlebody. Suppose that N admits a Stein structure. Then for each integer $n \geq 1$, there exist infinitely many compact connected oriented smooth 4-manifolds*

X_i ($i = 0, 1, 2, \dots$) which satisfies the following.

- (1) X_i ($i \geq 0$) are all homeomorphic but mutually non-diffeomorphic.
- (2) Each X_i ($1 \leq i \leq n$) admits a Stein structure, and any X_i ($i \geq n + 1$) admits no Stein structure.
- (3) The fundamental group, the integral homology groups, the integral homology groups of the boundary, and the intersection form of each X_i ($i \geq 0$) are isomorphic to those of X .
- (4) X can be embedded into X_0 .
- (5) Each X_i ($0 \leq i \leq n$) can be embedded into X .

Note that Akbulut and the author [6] recently constructed arbitrary many Stein 4-manifolds and arbitrary many non-Stein 4-manifolds which are all homeomorphic but mutually non-diffeomorphic. (The following claim is a simplification of the claims of Theorem 10.1 and Remark 10.7 of [6]. While (4) and (5) are not clearly stated in [6], we can easily check from the proof of Theorem 10.1 in [6].)

Theorem 11.2 (Theorem 10.1 and Remark 10.7 of [6]). *Let X be a 2-handlebody with $b_2 \geq 1$, and let Y be the boundary sum $X \natural (S^2 \times D^2)$. Then, for each $n \geq 1$, there exist compact connected oriented smooth 4-manifolds Y_0, Y_1, \dots, Y_{2n} which satisfies the following. (Furthermore, the same claim also holds in the $Y = X \natural (\mathbb{C}\mathbb{P}^2 - \text{int } D^4)$ case.)*

- (1) Y_i ($0 \leq i \leq 2n$) are mutually homeomorphic but non-diffeomorphic.
- (2) Every Y_i ($1 \leq i \leq n$) admits a Stein structure, and any Y_j ($n + 1 \leq j \leq 2n$) admits no Stein structure.
- (3) The fundamental groups, the integral homology groups, the integral homology groups of the boundary, and the intersection forms of every Y_i ($0 \leq i \leq 2n$) are isomorphic to those of Y .
- (4) Y can be embedded into Y_0 .
- (5) Each Y_i ($0 \leq i \leq 2n$) can be embedded into Y .

To prove Theorem 11.1, we recall the following theorem of Akbulut and the author [6].

Theorem 11.3 (Theorem 1.1 of [6]). *Let X be any 2-handlebody with $b_2 \geq 1$. Then for each integer $n \geq 1$, there exist compact connected oriented smooth 4-manifolds X_0, X_1, \dots, X_n which satisfies the following.*

- (1) The fundamental group, the integral homology groups, the integral homology groups of the boundary, and the intersection form of each X_i ($0 \leq i \leq n$) are isomorphic to those of X .
- (2) X_i ($0 \leq i \leq n$) are all homeomorphic but mutually non-diffeomorphic.
- (3) Each X_i ($1 \leq i \leq n$) admits a Stein structure.
- (4) X can be embedded into X_0 .
- (5) Each X_i ($0 \leq i \leq n$) can be embedded into X .

We here briefly summarize the construction of the above X_i 's in Section 5 of [6], emphasizing not their Stein handlebody decompositions but their smooth handlebody decompositions. Recall the following terminology of [6].

Definition 11.4. (1) A Legendrian handlebody X is said to be a good Legendrian handlebody if the following two conditions are satisfied.

- (i) Some 2-handles K_1, K_2, \dots, K_s of the handlebody X does not algebraically go over any 1-handles.

- (ii) The homology classes given by 2-handles K_1, K_2, \dots, K_s span a basis of $H_2(X; \mathbb{Z})$.
- (2) A Stein handlebody is said to be a good Stein handlebody if it satisfies the above conditions (i) and (ii).

Each X_i ($0 \leq i \leq n$) in Theorem 11.3 is obtained from X , roughly, by the following Steps (I)–(III). (These steps are simplified and little different from the original construction. However, the resulting Legendrian handlebodies X_0, X_1, \dots, X_n are the same.)

- (I) By sliding 2-handles and isotopy, change the given 2-handlebody X into a good Legendrian handlebody. Let K_0, K_1, \dots, K_l denote all the 2-handles of X . We assume that K_0 does not go over any 1-handles.
- (II) Apply $W^-(p_1)$ -, $W^-(p_2)$ -, \dots , $W^-(p_n)$ -modifications to K_0 (see Figure 13). Here we may choose p_1 to be an arbitrary large integer. Also, we may choose each p_i ($2 \leq i \leq n$) so that $p_i - p_{i-1}$ is arbitrary large. Next apply a $W^-(q_j)$ -modification to each 2-handle K_j ($1 \leq j \leq l$) (see Figure 14). We may choose each q_j ($1 \leq j \leq l$) to be an arbitrary large integer. Let X_0 denote the resulting Legendrian handlebody. (Beware that this X_0 corresponds to $X_{-1}^{(n)}$ in Section 5 of [6].)
- (III) Fix an integer i with $1 \leq i \leq n$. Replace the $W^-(p_i)$ -modification applied to K_0 with the corresponding $W^+(p_i)$ -modification (i.e. twist the cork W_1 , see Figure 13). Also, for each $1 \leq j \leq l$, replace the $W^-(q_j)$ -modification applied to K_j with the corresponding $W^+(q_j)$ -modification (i.e. twist the cork W_1 , see Figure 14.). Finally add zig-zags to all the 2-handles so that the handlebody becomes a Stein handlebody and that it satisfies certain conditions with respect to the Thurston-Bennequin numbers and the rotation numbers. The result of X is the X_i in Theorem 11.3.

Keeping these steps in mind, we prove Theorem 11.1.

Proof of Theorem 11.1. Let X, N, n be as in the assumption. Since N admits a Stein structure, we may assume that the subhandlebody N itself is a Stein handlebody (if necessary by changing the decomposition of N). We carefully apply Step (I) to X as follows. Let K_0, K_1, \dots, K_s denote all the 2-handles of the Stein handlebody N , and let $K_{s+1}, K_{s+2}, \dots, K_l$ denote all the other 2-handles of X . Since N is simply connected, we may assume that each K_j ($s+1 \leq j \leq l$) does not algebraically go over any 1-handles of N , if necessary, by sliding the K_j over K_0, K_1, \dots, K_s . Moreover, if necessary by sliding and isotoping handles $K_{s+1}, K_{s+2}, \dots, K_l$, we may assume that $X - \{K_0, K_1, \dots, K_s\}$ is a good Legendrian handlebody and that X is a Legendrian handlebody (cf. Section 4.2 of [33]). Note that we keep handles of N unchanged yet. Hence this Legendrian handlebody X still contains the Stein handlebody N as a subhandlebody.

Now we slide and isotope handles K_0, K_1, \dots, K_s of N so that X becomes a good Legendrian handlebody, where we do not slide any K_i ($0 \leq i \leq s$) over the handles $K_{s+1}, K_{s+2}, \dots, K_l$. This finishes Step (I). For a while, we call this sliding operation of K_0, K_1, \dots, K_s the “normalization of N ”. We use the same symbol K_0, K_1, \dots, K_s for the resulting 2-handles. We denote the resulting good Legendrian handlebody by $X^{(g)}$. Note that $X^{(g)}$ is diffeomorphic to X and that we can recover the Stein handlebody decomposition of N by reversing the operation “normalization of N ”.

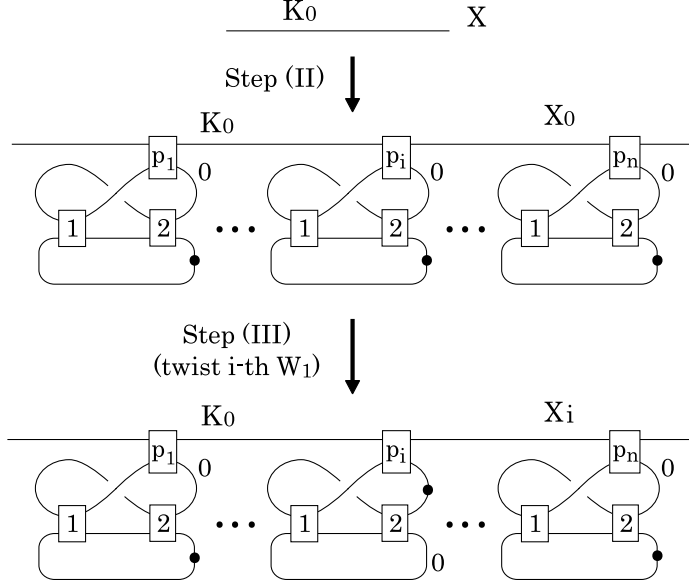
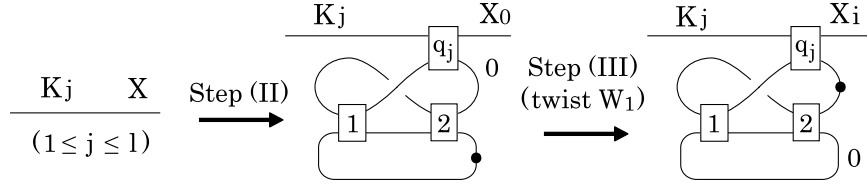
FIGURE 13. Steps (II) and (III) to K_0 (ignoring Legendrian diagrams)FIGURE 14. Steps (II) and (III) to K_j (ignoring Legendrian diagrams)

We next apply Steps (II) and (III) to the above $X^{(g)}$. Let X_0, X_1, \dots, X_n be the resulting Legendrian handlebodies. It follows from Theorem 11.3 that these X_i 's satisfy the claims (1)–(5) of Theorem 11.1. Unfortunately, any Stein 4-manifold X_i ($1 \leq i \leq n$) possibly do not contain the nucleus N . We thus proceed with this construction.

We here apply cork twists to X_n as follows (see also Figures 15, 16 and 17). Replace all the W^+ -modifications applied to each K_j ($0 \leq j \leq s$) of the Legendrian handlebody X_n in Step (III) with the corresponding W^- -modifications. We denote by \tilde{X}_n the resulting Legendrian handlebody. Since \tilde{X}_n is obtained from X_n by cork twists, \tilde{X}_n is homeomorphic to X_n .

Let \tilde{X} be the Legendrian handlebody obtained from X_n by removing all the W_1 's which links with 2-handles of N . Namely, we define \tilde{X} to be the Legendrian handlebody obtained from X_n by the following operations (i) and (ii) (see also Figures 15, 16 and 17).

- (i) Remove all the 1- and 2-handles of W_1 's given by $W(p_i)$ -modifications ($1 \leq i \leq n$) in Steps (II) and (III).

- (ii) Remove all the 1- and 2-handles of W_1 's given by $W^+(q_j)$ -modifications ($1 \leq j \leq s$) in Step (III).

As a smooth handlebody, \tilde{X}_n can be obtained from \tilde{X} by W -modifications. We can thus embed \tilde{X}_n into \tilde{X} by Lemma 7.6. Reversing the operation “normalization of N ”, we can change \tilde{X} into a Stein handlebody keeping its diffeomorphism type. Note that $N \subset \tilde{X}_n \subset \tilde{X}$.

Since \tilde{X} is a Stein handlebody, we can embed \tilde{X} (and hence \tilde{X}_n) into a closed symplectic 4-manifold with $b_2^+ > 1$. Theorem 1.1 thus shows that \tilde{X}_n admits infinitely many distinct smooth structures, because \tilde{X}_n contains the nucleus N . Since \tilde{X}_n is homeomorphic to X_n , the rest of the proof follows from Theorem 10.4. \square

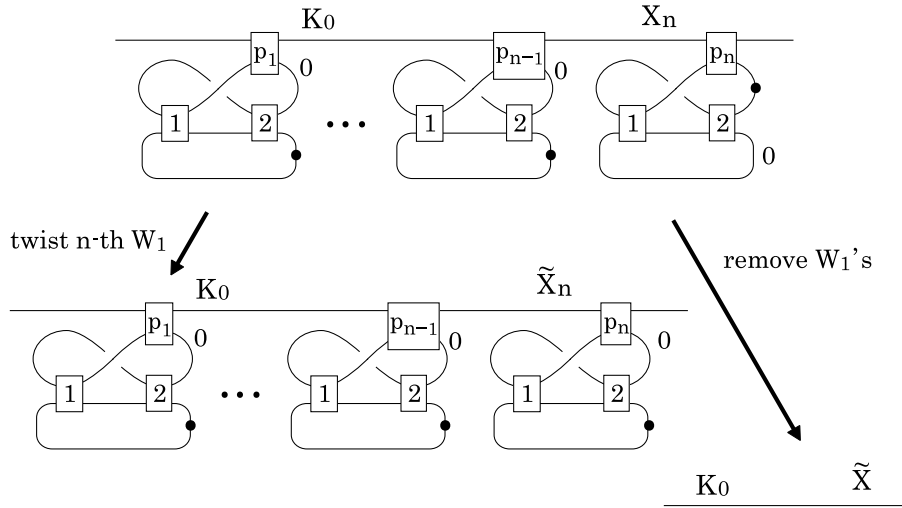

FIGURE 15. Constructions of \tilde{X}_n and \tilde{X} (ignoring Legendrian diagrams)

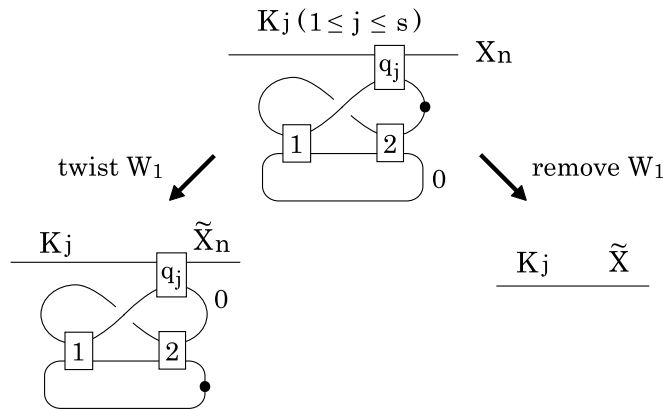

FIGURE 16. Constructions of \tilde{X}_n and \tilde{X} (ignoring Legendrian diagrams)

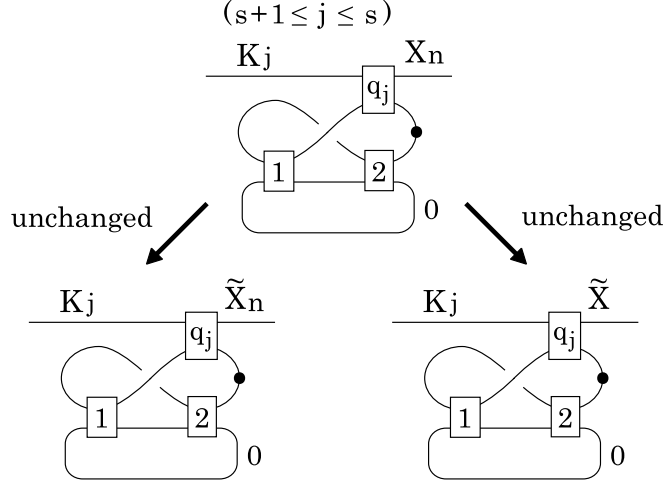

FIGURE 17. Constructions of \tilde{X}_n and \tilde{X} (ignoring Legendrian diagrams)

Theorem 11.1 immediately gives the following.

Corollary 11.5. *Let Y be a 2-handlebody, and let N be a nucleus which admits a Stein structure. Put $X = Y \natural N$. Then, for each integer $n \geq 1$, there exist infinitely many compact connected oriented smooth 4-manifolds X_i ($i = 0, 1, 2, \dots$) which satisfies (1)–(5) of Theorem 11.1.*

Since every finitely presented group (resp. integral symmetric bilinear form $\mathbb{Z}^k \times \mathbb{Z}^k \rightarrow \mathbb{Z}$ ($k \geq 0$)) is realized as the fundamental group (resp. intersection form) of a 2-handlebody, this corollary shows the following.

Corollary 11.6. (1) *Let G be any finitely presented group. Then there exist arbitrary many compact Stein 4-manifolds and infinitely many non-Stein smooth 4-manifolds such that they are all homeomorphic but mutually non-diffeomorphic and that each of their fundamental groups is isomorphic to G .*

(2) *Let $Q : \mathbb{Z}^k \times \mathbb{Z}^k \rightarrow \mathbb{Z}$ ($k \geq 0$) be any integral symmetric bilinear form, and let $R : \mathbb{Z}^2 \times \mathbb{Z}^2 \rightarrow \mathbb{Z}$ be any integral, indefinite, unimodular symmetric bilinear form. Then there exist arbitrary many simply connected compact Stein 4-manifolds and infinitely many non-Stein smooth 4-manifolds such that they are all homeomorphic but mutually non-diffeomorphic and that each of their intersection forms is isomorphic to $Q \oplus R$.*

REFERENCES

- [1] S. Akbulut, *A fake compact contractible 4-manifold*, J. Differential Geom. **33** (1991), no. 2, 335–356.
- [2] S. Akbulut, *An exotic 4-manifold*, J. Differential Geom. **33** (1991), no. 2, 357–361.
- [3] S. Akbulut, *A fake cusp and a fishtail*, Proceedings of 6th Gökova Geometry-Topology Conference, Turkish J. Math. **23** (1999), no. 1, 19–31.
- [4] S. Akbulut and B. Ozbagci, *On the topology of compact Stein surfaces*, Int. Math. Res. Not. **2002**, no. 15, 769–782.
- [5] S. Akbulut and K. Yasui, *Corks, Plugs and exotic structures*, Journal of Gökova Geometry Topology, volume **2** (2008), 40–82.
- [6] S. Akbulut and K. Yasui, *Cork twisting exotic Stein 4-manifolds*, arXiv:1102.3049.

- [7] A. Akhmedov, J. B. Etnyre, T. E. Mark, and I. Smith, *A note on Stein fillings of contact manifolds*, Math. Res. Lett. **15** (2008), no. 6, 1127–1132.
- [8] A. Akhmedov, B. D. Park and G. Urzúa, *Spin symplectic 4-manifolds near Bogomolov-Miyaoka-Yau line*, Journal of Gökova Geometry Topology, Volume **4** (2010) 55–66.
- [9] S. Boyer, *Simply-connected 4-manifolds with a given boundary*, Trans. Amer. Math. Soc. **298** (1986), no. 1, 331–357.
- [10] F. Ding and H. Geiges, *A Legendrian surgery presentation of contact 3-manifolds*, Proc. Cambridge Philos. Soc. **136** (2004) 583–598.
- [11] Y. Eliashberg, *Topological characterization of Stein manifolds of dimension > 2* , International J. of Math. Vol. 1 (1990), No 1 pp. 29–46.
- [12] Y. Eliashberg, *A few remarks about symplectic filling*, Geom. Topol. **8** (2004) 277–293.
- [13] J. Etnyre, *On symplectic fillings*, Algebr. Geom. Topol. **4** (2004), 73–80.
- [14] J. Etnyre, *Contact geometry in low dimensional topology*, Low dimensional topology, 229–264, IAS/Park City Math. Ser., **15**, Amer. Math. Soc., Providence, RI, 2009.
- [15] R. Fintushel and R. J. Stern, *Surgery in cusp neighborhoods and the geography of irreducible 4-manifolds*, Invent. Math. **117** (1994), no. 3, 455–523.
- [16] R. Fintushel and R. J. Stern, *Rational blowdowns of smooth 4-manifolds*, J. Differential Geom. **46** (1997), no. 2, 181–235.
- [17] R. Fintushel and R. Stern, *Surfaces in 4-manifolds*, Math. Res. Letters **4** (1997), 907–914.
- [18] R. Fintushel and R. J. Stern, *Surfaces in 4-manifolds: Addendum*, arXiv:math/0511707.
- [19] R. Fintushel and R. J. Stern, *Knots, links, and 4-manifolds*, Invent. Math. **134** (1998), no. 2, 363–400.
- [20] R. Fintushel and R. J. Stern, *Six Lectures on Four 4-Manifolds*, Low dimensional topology, 265–315, IAS/Park City Math. Ser., **15**, Amer. Math. Soc., Providence, RI, 2009.
- [21] R. Fintushel and R. J. Stern, *Surgery on nullhomologous tori and simply connected 4-manifolds with $b^+ = 1$* , J. Topol. **1**, (2008) 1–15
- [22] T. Fuller, *Generalized nuclei of complex surfaces*, Pacific J. Math. **187** (1999), no. 2, 281–295.
- [23] R. E. Gompf, *Nuclei of elliptic surfaces*, Topology **30** (1991), no. 3, 479–511.
- [24] R. E. Gompf, *Handlebody construction of Stein surfaces*, Ann. of Math. (2) **148** (1998), no. 2, 619–693.
- [25] R. E. Gompf and A. I. Stipsicz, *4-manifolds and Kirby calculus*, Graduate Studies in Mathematics, **20**. American Mathematical Society, 1999.
- [26] P. Kronheimer and T. Mrowka, *The genus of embedded surfaces in the projective plane*, Math. Res. Lett. **1** (1994), no. 6, 797–808.
- [27] P. Lisca, *Symplectic fillings and positive scalar curvature*, Geom. Topol. **2** (1998), 103–116.
- [28] P. Lisca and G. Matić, *Tight contact structures and Seiberg-Witten invariants*, Invent. Math. **129** (1997) 509–525.
- [29] P. Lisca and A. I. Stipsicz, *Ozsváth-Szabó invariants and tight contact three-manifolds. I*, Geom. Topol. **8** (2004), 925–945.
- [30] P. Lisca and A. I. Stipsicz, *Ozsváth-Szabó invariants and tight contact three-manifolds. II*, J. Differential Geom. **75** (2007), 109–141.
- [31] T. Mark, *Knotted surfaces in 4-manifolds*, arXiv:0801.4367, to appear in Forum Math.
- [32] J. Morgan, T. Mrowka and Z. Szabó, *Product formulas along T^3 for Seiberg-Witten invariants*, Math. Res. Lett. **4** (1997), 915–929.
- [33] B. Ozbagci and A. I. Stipsicz, *Surgery on contact 3-manifolds and Stein surfaces*, Bolyai Society Mathematical Studies, 13. Springer-Verlag, Berlin; Janos Bolyai Mathematical Society, Budapest, 2004.
- [34] P. Ozsváth and Z. Szabó, *The symplectic Thom conjecture*, Ann. of Math. **151** (2000), 93–124.
- [35] B. D. Park and Z. Szabó, *The geography problem for irreducible spin four-manifolds*, Trans. Amer. Math. Soc. **352** (2000), no. 8, 3639–3650.
- [36] J. Park, *Non-complex symplectic 4-manifolds with $b_2^+ = 1$* , Bull. London Math. Soc. **36** (2004), no. 2, 231–240.
- [37] J. Park, *The geography of symplectic 4-manifolds with an arbitrary fundamental group*, Proc. Amer. Math. Soc. **135** (2007), no. 7, 2301–2307.
- [38] A. Scorpan, *The Wild World of 4-Manifolds*, American Mathematical Society, Providence, Rhode Island, 2005.

- [39] R. J. Stern, *Will we ever classify simply-connected smooth 4-manifolds?*, Floer Homology, Gauge Theory, and Low-dimensional Topology, (D. Ellwood, *et. al.*, eds.), CMI/AMS publication, 2006, 225–239.
- [40] A. I. Stipsicz, *On the number of vanishing cycles in Lefschetz fibrations*, Math. Res. Lett. **6** (1999), no. 3-4, 449–456.
- [41] M. Ue, *On the decompositions of elliptic surfaces*, Knots 90 (Osaka, 1990), 299–322, de Gruyter, Berlin, 1992.
- [42] A. Weinstein, *Contact surgery and symplectic handlebodies*, Hokkaido Math. J. **20** (1991), 241–251.
- [43] K. Yasui, *Exotic S^2 -knots and links in 4-manifolds*, in preparation.

DEPARTMENT OF MATHEMATICS, GRADUATE SCHOOL OF SCIENCE, HIROSHIMA UNIVERSITY, 1-3-1 KAGAMIYAMA, HIGASHI-HIROSHIMA, 739-8526, JAPAN
E-mail address: `kyasui@hiroshima-u.ac.jp`