

TEICHMÜLLER CURVES GENERATED BY WEIERSTRASS PRYM EIGENFORMS IN GENUS THREE AND GENUS FOUR

ERWAN LANNEAU, DUC-MANH NGUYEN

ABSTRACT. This paper is devoted to the classification of the infinite families of Teichmüller curves generated by Prym eigenforms of genus 3 having a single zero. These curves were discovered by McMullen [McM06b]. The main invariants of our classification is the discriminant D of the corresponding quadratic order, and the generators of this order. It turns out that for D sufficiently large, there are two Teichmüller curves when $D \equiv 1 \pmod{8}$, only one Teichmüller curve when $D \equiv 0, 4 \pmod{8}$, and no Teichmüller curves when $D \equiv 5 \pmod{8}$. For small values of D , where this classification is not necessarily true, the number of Teichmüller curves can be determined directly. The ingredients of our proof are first, a description of these curves in terms of prototypes and models, and then a careful analysis of the combinatorial connectedness in the spirit of McMullen [McM05a]. As a consequence, we obtain a description of cusps of Teichmüller curves given by Prym eigenforms.

We would like also to emphasize that even though we have the same statement compared to [McM06b], when $D \equiv 1 \pmod{8}$, the reason for this disconnectedness is different.

The classification of these Teichmüller curves plays a key role in our investigation of the dynamics of $SL(2, \mathbb{R})$ on the intersection of the Prym eigenform locus with the stratum $\Omega\mathcal{M}(2, 2)$, which is the object of a forthcoming paper.

CONTENTS

1. Introduction	2
2. Background and tools	7
3. Cylinder decompositions of Prym eigenforms	10
4. Prototypes	13
5. Uniqueness	21
6. Case D odd	23
7. Prototypes and butterfly moves	24
8. Components of the space of prototypes	29
9. Components of the Prym eigenforms locus	38
Appendix A. Exceptional cases in Theorem 8.2	43
Appendix B. Square-tiled surfaces	43
Appendix C. Cusps of the Teichmüller curves in genus 3	44
Appendix D. Components of the Prym eigenforms locus in genus 4	47
References	50

Date: June 25, 2018.

Key words and phrases. Real multiplication, Prym locus, Teichmüller curve, Translation surface.

1. INTRODUCTION

For a long time, it has been known that the ergodic properties of linear flows on a translation surface are strongly related to the behavior of its $\mathrm{SL}(2, \mathbb{R})$ -orbit in the moduli space $\Omega\mathfrak{M}_g$ (see *e.g.* [MaTa02, Zor06] for surveys of the literature on this subject). The projection of the $\mathrm{SL}(2, \mathbb{R})$ -orbit of a translation surface into the Teichmüller space is a *Teichmüller disc*. It has been known that when the stabilizer of a surface is a lattice in $\mathrm{SL}(2, \mathbb{R})$, the Teichmüller disc projects onto a *Teichmüller curve* [Vee92, SW06] in the moduli space \mathfrak{M}_g .

Since the work of Veech much effort has gone into the study of these Teichmüller discs and their closures. Two decades later, thanks to the seminal work of McMullen [McM03a, McM03b, McM05a, McM05b, McM06a, McM07], a complete classification of the closures of Teichmüller discs, as well as a complete list of the Teichmüller curves has been established in genus two (see [Cal04] for a partial classification involving different ideas). See [Möl06, Möl08, BM10, EM10] for related results in higher genera.

McMullen's analysis relates Teichmüller curves to the locus $\Omega E_D(2) \subset \Omega\mathfrak{M}_2$ (respectively, $\Omega E_D(1, 1)$) corresponding to pairs $(X, \omega) \in \Omega\mathfrak{M}_2$ where X is a Riemann surface whose the Jacobian $\mathrm{Jac}(X)$ admits real multiplication by some order O_D and ω being then an eigenform for the real multiplication with a single zero (respectively, two simple zeroes) (see Section 2 for precise definitions).

Roughly speaking, one can single out two key facts of genus two surfaces, playing a crucial role in McMullen's approach:

- (1) The existence of the so-called hyperelliptic involution ρ on X , and
- (2) the complex dimension of $H^1(X, \mathbb{C})$ is 2.

Later [McM06b] McMullen extended these results to the Prym eigenform loci ΩE_D in higher genera, that can be thought as natural loci where these two above properties remains true. Then it was proven in [McM06b] that these loci are closed $\mathrm{SL}(2, \mathbb{R})$ -invariant. Moreover by a dimension count, the intersections $\Omega E_D(4) \subset \Omega\mathfrak{M}_3$ and $\Omega E_D(6) \subset \Omega\mathfrak{M}_4$ of ΩE_D with the minimal strata, consist entirely of Teichmüller curves.

The family of Teichmüller curves in $\Omega E_D(2)$ has been classified by McMullen [McM05a]. In this paper we prove a classification type result for $\Omega E_D(4)$:

Theorem 1.1. *For $D \geq 17$, $\Omega E_D(4)$ is non empty if and only if $D \equiv 0, 1$, or $4 \pmod{8}$, and all the loci $\Omega E_D(4)$ are pairwise disjoint. Moreover, for those discriminants, the following dichotomy holds. Either*

- (1) *D is odd and then $\Omega E_D(4)$ has exactly two connected components, or*
- (2) *D is even and $\Omega E_D(4)$ is connected.*

In addition, each component of $\Omega E_D(4)$ corresponds to a closed $\mathrm{GL}^+(2, \mathbb{R})$ -orbit.

For $D < 17$, $\Omega E_D(4)$ is non-empty if and only if $D \in \{8, 12\}$ and in this case, it is connected (see Theorem 2.10). As a direct consequence, we get a surprising fact: all surfaces in $\Omega E_8(4)$ have no simple cylinders. Note that translation surfaces with no simple cylinders are quite rare, as generic ones always have simple cylinders. All examples of such surfaces (*e.g.* the Wollmilchsau surface) known to the authors are square-tiled surfaces (see [HS08]). Since 8 is not a perfect square, surfaces of $\Omega E_8(4)$ are not square-tiled.

Remark 1.2. *It is not difficult to see that the parity of the spin structures determined by Abelian differentials in $\Omega E_D(4)$ are odd (see [KZ03]). Theorem 1.1 is thus a crucial step in our attempt to obtain an accurate count of the number of components of the intersection $\Omega E_D \cap \Omega \mathfrak{M}(2, 2)^{\text{odd}}$.*

This count, together with other problems such as the characterization of surfaces in $\Omega E_D \cap \Omega \mathfrak{M}(2, 2)^{\text{odd}}$, and the classification of the $\text{GL}^+(2, \mathbb{R})$ -orbits (Ratner type theorem) will be addressed in a forthcoming paper [LN11].

The strategy we develop can also be used to investigate the connectedness of the loci $\Omega E_D(6)$, namely:

Theorem 1.3. *For any $D \in \mathbb{N}$, $D \equiv 0, 1 \pmod{4}$, and $D \notin \{4, 9\}$, the locus $\Omega E_D(6)$ is non empty and has at most two components. Moreover if D is odd then $\Omega E_D(6)$ is connected.*

Remark 1.4. *Unfortunately, we do not succeed to obtain an accurate count of $\text{GL}^+(2, \mathbb{R})$ -orbits in $\Omega E_D(6)$ for D even. There are reasons to believe that the locus $\Omega E_D(6)$ is always connected (i.e there is only one $\text{GL}^+(2, \mathbb{R})$ -orbit). This is strongly supported by the fact that $\Omega E_{d^2}(6)$ is connected for small values of even d (we have checked for $d \leq 20$) and for small values of D (e.g. $D < 53$) that are not a square.*

Since it seems to us that such a result would require other tools and ideas than what has been introduced in the present paper, we will adress the topological classification of $\Omega E_D(6)$ in a forthcoming paper.

Euler characteristics of Prym loci. In the recent paper [Möll11], Möller provide a way to calculate the Euler characteristics of the Teichmüller curves obtained by the Prym construction.

From this point of view this paper is, jointly with the work of [Möll11], a continuation of [McM06b].

Cusps of Teichmüller curves. The projection of $\Omega E_D(2g - 2)$ to the moduli space \mathcal{M}_g leads to Teichmüller curves. Let $\text{SL}(X, \omega)$ denote the Veech group of (X, ω) which is a lattice of $\text{SL}(2, \mathbb{R})$. A Teichmüller curve can never be compact, since any periodic direction of (X, ω) gives rise to a cusp, each cusps corresponds to the $\text{SL}(X, \omega)$ -orbits of a periodic direction of (X, ω) .

For $g = 2, 3, 4$, let $W_D(2g - 2)$ be the projection of $\Omega E_D(2g - 2)$ into \mathfrak{M}_g . By [McM05a], Theorem 1.1 and Theorem 1.3 we know that $W_D(2g - 2)$ is the union of at most two Teichmüller curves.

A corollary of our result is a description of the number of cusps of theses curves for $g = 3$ and $g = 4$. For a more detailed description, see Appendix C.

Table 1 represents the number of cusps for the first discriminants. Observe that the first data (i.e. $g = 2$) have been already established by McMullen (see [McM05a], Table 3).

Remark 1.5. *For a combinatorial description of the cusps of $W_D(4)$, see Propositions 4.2, 4.5 & 4.6 for the 3-cylinder decompositions and Theorem C.1 for the 1 and 2-cylinder decompositions.*

When D is not a square, the number of cusps of $W_D(2)$ and $W_D(6)$ is the same (see Proposition D.4).

Genus 2			Genus 3			Genus 4		
D	$ \mathcal{P}_D $	$ C(W_D(2)) $	$ \mathcal{P}_D $	$ \mathcal{P}'_D $	$ C(W_D(4)) $	$ \mathcal{P}_D $	$ \mathcal{P}'_D $	$ C(W_D(6)) $
5	1	1	0	0	0	0	1	1
8	2	2	0	1	1	1	1	2
9	1	1+1	0	0	0	0	0	0
12	3	3	1	0	2	1	2	3
13	3	3	0	0	0	2	1	3
16	2	2+1	0	0	0	1	0	1+1
17	6	6	2	2	6	2	4	6
20	5	5	1	2	4	3	2	5
21	4	4	0	0	0	2	2	4
24	6	6	2	0	4	4	2	6
25	6	6+2	2	0	4+2	2	1	3+3
28	7	7	1	2	4	3	4	7
29	5	5	0	0	0	4	1	5
32	7	7	3	2	8	4	3	7
33	12	12	4	6	14	6	6	12
36	5	5+3	1	0	2+2	3	0	3+5
37	9	9	0	0	0	4	5	9
40	12	12	2	2	6	6	6	12
41	14	14	7	2	16	8	6	14
44	9	9	3	0	6	7	2	9
45	8	8	0	0	0	4	4	8
48	11	11	3	4	10	7	4	11
49	13	13+5	4	2	10+6	6	3	9+9
52	15	15	5	2	12	7	8	15

TABLE 1. The number of cusps $C(W_D(2g-2))$ of the Weierstrass curve in genus 2, 3 and 4. Lines in bold correspond to square tilde surfaces ($\sqrt{D} \in \mathbb{N}$); In this case the number of cusps is broken down as the sum of the number of cusps for decomposition in models A_{\pm}, B and cusps for others decompositions. When D is not a square, the number of cusps is given, respectively for $g = 2, 3, 4$, by $|\mathcal{P}_D|$, $2|\mathcal{P}_D| + |\mathcal{P}'_D|$, and $|\mathcal{P}_D| + |\mathcal{P}'_D|$.

Outline. We briefly sketch the proof of Theorem 1.1. It involves decompositions of surfaces into cylinders, and then a combinatorial analysis of the space of such decompositions. This last step is tackled using number theory arguments.

- (1) Associated to any Abelian differential $(X, \omega) \in \Omega E_D(4)$ is a flat metric structure (with cone type singularities). Since (X, ω) is a Veech surface [McM06b], the Veech dichotomy ensures that there are infinitely many *completely periodic* directions *i.e.* each trajectory is either a saddle connection or a closed geodesic. The surface is then the union of finitely many open cylinders and saddle connections in this direction. The parameters of a cylinder are denoted

by (w, h, t) for, respectively, the *width*, *height* and *twist*. It turns out that a surface in $\Omega E_D(4)$ always admits a decomposition into three cylinders following one of three topological models (named $A+$, $A-$, and B) presented in Figure 1. This corresponds to Proposition 3.2 and Corollary 3.4.

- (2) The first main ingredient is a combinatoric representation of every surface in $\Omega E_D(4)$ that is decomposed into three cylinders in the horizontal direction. We show (Proposition 4.2 and Proposition 4.5) that up to the action of $\mathrm{GL}^+(2, \mathbb{R})$ and appropriate Dehn twists, any cylinder decomposition of type $A+$ or $A-$ can be encoded by the parameters $(w, h, t, e, \varepsilon)$, where $(w, h, t, e) \in \mathbb{Z}^4$ satisfies

$$(\mathcal{P}) \begin{cases} w > 0, h > 0, e + 2h < w, 0 \leq t < \gcd(w, h), \\ \gcd(w, h, t, e) = 1, \text{ and } D = e^2 + 8hw, \end{cases}$$

and $\varepsilon \in \{\pm\}$ (compare with [McM05a]). The set of all $p = (w, h, t, e) \in \mathbb{Z}^4$ satisfying (\mathcal{P}) is denoted by \mathcal{P}_D , and the set of (p, ε) with $p \in \mathcal{P}_D$ and $\varepsilon \in \{\pm\}$ is denoted by Q_D . The set Q_D naturally parametrizes the set of all decompositions of type $A\pm$ for a fixed D . For $D \neq 8$, since any surface in $\Omega E_D(4)$ always admits a decompositions of type $A\pm$ (see Proposition 4.7), this provides a (huge) upper bound for the number of components of $\Omega E_D(4)$ by the cardinal of Q_D .

- (3) In general, neither the Prym involution nor the quadratic order is uniquely determined by the Prym eigenform. However, the analysis on the prototypes allows us to show that, for Prym eigenform in $\Omega \mathcal{M}(4)$, the Prym involution and the quadratic order are unique. It follows immediately that $\Omega E_{D_1}(4)$ and $\Omega E_{D_2}(4)$ are disjoint if $D_1 \neq D_2$ (see Theorem 5.1 and Corollary 5.2).
- (4) In Section 7 we introduce an equivalence relation \sim on Q_D which are generated by changes of periodic directions called *Butterfly moves*. A Butterfly move is the operation of switching from a cylinder decomposition of type $A+$ or $A-$ to another one such that the simple cylinders in the two decompositions are disjoint. If we have a decomposition of type $A+$, then a Butterfly move yields a decomposition of type $A-$, and vice versa. Two elements of Q_D are equivalent if they parametrize two cylinder decompositions on the same surface which can be connected by a sequence of Butterfly moves. Thus

$$\#\{\text{Components of } \Omega E_D(4)\} \leq \#(Q_D / \sim).$$

Given the parameters of the initial cylinder decomposition and the parameter of the Butterfly move, one can write down the parameters of the new decomposition rather explicitly (see Proposition 7.5 and Proposition 7.6). It turns out that the changing rules are the same for decompositions of type $A+$ and $A-$, therefore the equivalence relation \sim descends to an equivalence relation (still denoted by \sim) in \mathcal{P}_D : for any $p, p' \in \mathcal{P}_D$, $p \sim p'$ if there exist $\varepsilon, \varepsilon' \in \{\pm\}$, such that $(p, \varepsilon) \sim (p', \varepsilon')$ in Q_D . Obviously

$$\#(Q_D / \sim) \leq 2 \cdot \#(\mathcal{P}_D / \sim).$$

The remaining parts consist in showing that $\#(\mathcal{P}_D / \sim) = 1$.

- (5) To compute the number of equivalence classes in \mathcal{P}_D , we use McMullen’s approach [McM05a]. We first show that every prototype $(w, h, t, e) \in \mathcal{P}_D$ can be connected to a reduced one, *i.e.* a prototype (w, h, t, e) where $h = 1$. For fixed D such reduced prototypes are uniquely determined by its e and thus they are parametrized by

$$\mathcal{S}_D = \{e \in \mathbb{Z}, e^2 \equiv D \pmod{8}, e^2 \text{ and } (e+4)^2 < D\}.$$

The prototype in \mathcal{P}_D associated to an element $e \in \mathcal{S}_D$ will be denoted by $[e]$. We define an equivalence relation in \mathcal{S}_D which is generated by the following condition $e \sim -e - 4q$ whenever $-e - 4q \in \mathcal{S}_D$ and $\gcd(w, q) = 1$, where $q > 0$ and $w = (D - e^2)/8$. By definition, we have $e \sim e'$ in \mathcal{S}_D implies that $[e] \sim [e']$ in \mathcal{P}_D but the converse is not necessarily true. Thus, the number of equivalence classes in \mathcal{S}_D gives us an upper bound for the number of equivalence classes in \mathcal{P}_D .

- (6) In Section 8 we show that, for D sufficiently large (*i.e.* $D \geq 83^2$) \mathcal{S}_D / \sim consists of a single component if $D \not\equiv 4 \pmod{16}$, otherwise two. It follows immediately that for $D \not\equiv 4 \pmod{16}$, there is only one equivalence class in \mathcal{P}_D . For the remaining cases, we show that it is possible to connect the two components of \mathcal{S}_D through \mathcal{P}_D , hence there is actually only one equivalence class in \mathcal{P}_D , which implies that Q_D (and thus $\Omega E_D(4)$) has at most two components.
- (7) For $D \equiv 0, 4 \pmod{8}$, two components of Q_D can be connected by an explicit path in ΩE_D (see Theorem 9.2), therefore $\Omega E_D(4)$ consists of only one $\mathrm{GL}^+(2, \mathbb{R})$ -orbit and our statement is proven in this case. When $D \equiv 1 \pmod{8}$, since $\Omega E_D(4)$ contains at most two components, it remains to show that $\Omega E_D(4)$ is non connected.
- (8) When $D \equiv 1 \pmod{8}$ (*i.e.* D is odd since $D \not\equiv 5 \pmod{8}$) it turns out that the locus $\Omega E_D(4)$ contains at least two distinct $\mathrm{GL}^+(2, \mathbb{R})$ -orbits (Theorem 6.1). Roughly speaking, the two components correspond to two distinct complex lines in the space $\Omega(X, \rho)^- \simeq H^1(X, \mathbb{R})^-$ (see Section 6).
- (9) Note that the number theory arguments that we use only apply when D is sufficiently large. For small values of D , Theorem 1.1 is proven with computer assistance (see Table 2 page 32, and Table 3 page 43). Actually, the number of components of $\Omega E_D(4)$ is not always equal to the number of components of Q_D , there are several exceptions, namely when $D \in \{41, 48, 68, 100\}$. We discuss and prove Theorem 1.1 for those exceptional cases in Section 9.

Reader’s guide. In Section 2 we review basic definitions on real multiplication and state precisely the classification. Section 3 is devoted to a classification of cylinder decompositions. This allows us to obtain a combinatorial description of Prym eigenforms, which is achieved in Section 4. In Section 5, and Section 6 the combinatorial description of cylinder decompositions is used to prove that for different values of D , the loci $\Omega E_D(4)$ are disjoint, and when D is odd, $\Omega E_D(4)$ contains at least two distinct $\mathrm{GL}^+(2, \mathbb{R})$ -orbits.

In Section 7, we introduce the spaces of prototypes Q_D and \mathcal{P}_D . We define the “Butterfly Move” operations, and compute the induced transformations on the sets Q_D and \mathcal{P}_D . Section 8 can be read independently from the others. We prove the combinatorial connectedness of the space of prototypes \mathcal{P}_D . Then in the last part (Section 9) we give the proof of our main result. In the Appendix we treat the particular cases separately, and give a quick résumé of the classification problem for Prym eigenforms

in $\Omega\mathfrak{M}(6)$. We also derive the number of cusps of Teichmüller curves given by Prym eigenforms (Appendix C).

Acknowledgments. The authors are grateful to the Hausdorff Institute in Bonn, where this work began, for its hospitality, excellent ambiance and working conditions. The authors thank the Centre de Physique Théorique in Marseille and the Université Bordeaux 1.

We thank Vincent Delecroix, Pascal Hubert, Samuel Lelièvre, Carlos Matheus, Curt McMullen and Martin Möller for useful discussions and remarks on this paper.

We also thank [Ste09] for computational help.

2. BACKGROUND AND TOOLS

We review basic notions and results concerning Abelian differentials, translation surfaces and real multiplication. For general references see *e.g.* [MaTa02, Zor06, McM03a, McM06b].

2.1. Prym varieties. If X is a Riemann surface, and $\rho : X \rightarrow X$ is a holomorphic involution then the *Prym variety* of (X, ρ) is the abelian variety defined by

$$\text{Prym}(X, \rho) = (\Omega(X)^-)^* / H_1(X, \mathbb{Z})^-,$$

where $\Omega(X)^- = \{\omega \in \Omega(X), \rho^*(\omega) = -\omega\}$, and $H_1(X, \mathbb{Z})^- = \{\gamma \in H_1(X, \mathbb{Z}), \rho(\gamma) = -\gamma\}$.

In the rest of this paper, we will assume that $\dim_{\mathbb{C}} \text{Prym}(X, \rho) = 2$. This assumption can be easily read as follows. Since $\Omega(X/\rho)$ is identified with $\Omega(X)^+ = \ker(\rho - \text{id}) \subset \Omega(X)$ one has

$$\dim_{\mathbb{C}} \text{Prym}(X, \rho) = \dim_{\mathbb{C}} \Omega(X) - \dim_{\mathbb{C}} \Omega(X/\rho) = \text{genus}(X) - \text{genus}(X/\rho) = 2$$

Remark 2.1. *This assumption can be thought as the natural condition coming for the genus two case discussed in the introduction (compare with [McM06b], Section 3).*

In the present article we will concentrate on the following construction of Prym varieties.

Example 2.2. *Let q be a quadratic differential on the 2-torus having three simple poles and a single zero (of order 3). Let $\pi : X \rightarrow \mathbb{T}^2$ be the double orientating cover. Then the deck transformation ρ on X provides a natural Prym variety $\text{Prym}(X, \rho)$ where $\sqrt{\pi^*q} \in \Omega(X)^-$. Observe that the form $\sqrt{\pi^*q}$ has a unique zero of order 4.*

2.2. Real multiplication on abelian variety. Let $D > 0$ be a positive integer congruent to 0 or 1 modulo 4. Let

$$\mathcal{O}_D \cong \mathbb{Z}[X]/(X^2 + bX + c)$$

be the real quadratic order of discriminant D , where $b, c \in \mathbb{Z}$ and $D = b^2 - 4c$.

If P is a polarized abelian variety, we can then identify P with the quotient \mathbb{C}^g/L where L is a lattice isomorphic to \mathbb{Z}^{2g} equipped with a symplectic pairing $\langle \cdot, \cdot \rangle$. The endomorphism ring $\text{End}(P)$ of P is then identified with the set of complex linear maps $T : \mathbb{C}^g \rightarrow \mathbb{C}^g$ such that $T(L) \subset L$. Recall that an endomorphism is said to be *self-adjoint* if for all $x, y \in L$ the relation $\langle Tx, y \rangle = \langle x, Ty \rangle$ holds.

We say that the variety P admits *real multiplication* by the order \mathcal{O}_D , if $\dim_{\mathbb{C}} P = 2$, and if there exists a representation $i : \mathcal{O}_D \rightarrow \text{End}(P)$ which satisfies

- (1) $i(\lambda)$ is self-adjoint for any $\lambda \in \mathcal{O}_D$,
- (2) $i(\mathcal{O}_D)$ is a *proper subring* of $\text{End}(P)$ i.e. if $T \in \text{End}(P)$ and $nT \in i(\mathcal{O}_D)$ where $n \in \mathbb{Z}$, $n > 0$ then $T \in i(\mathcal{O}_D)$.

2.3. Prym eigenforms. Let $P = \text{Prym}(X, \rho)$ be a Prym variety. We say that P has real multiplication by the order O_D if there exists a representation $\iota : O_D \rightarrow \text{End}(P)$ which satisfies above conditions (1) and (2), where the lattice $H_1(X, \mathbb{Z})^-$ is equipped with the restriction of the intersection form on $H_1(X, \mathbb{Z})$.

Since ρ acts on $\Omega(X)$, it follows that we have a splitting into a direct sum of two eigenspaces: $\Omega(X) = \Omega(X)^+ \oplus \Omega(X)^-$. If P has real multiplication then O_D acts naturally on $\Omega(P) \cong \Omega(X)^-$. We say that a non zero form $\omega \in \Omega(X)^-$ is a *Prym eigenform* if $O_D \cdot \omega \subset \mathbb{C}\omega$.

2.4. Pseudo-Anosov homeomorphisms. Real multiplication arises naturally with pseudo-Anosov homeomorphisms commuting with ρ . Let $\phi : X \rightarrow X$ be a pseudo-Anosov affine with respect to the flat metric given by $\omega \in \Omega(X, \rho)^-$. Since ϕ commutes with ρ it induces a homomorphism

$$T = \phi_* + \phi_*^{-1} : H_1(X, \mathbb{Z})^- \rightarrow H_1(X, \mathbb{Z})^-,$$

that is self-adjoint. Observe that T preserves the complex line S in $(\Omega(X, \rho)^-)^*$ spanned by the dual of $\text{Re}(\omega)$ and $\text{Im}(\omega)$, and the restriction of T to this vector space is $\text{Tr}(D\phi) \cdot \text{id}_S$.

Now the crucial assumption on the dimension comes into play. Since $\dim_{\mathbb{C}} \Omega(X, \rho)^- = 2$ one has $\dim_{\mathbb{C}} S^{\perp} = 1$. Since T is self-adjoint, it preserves the splitting $(\Omega(X, \rho)^-)^* = S \oplus S^{\perp}$, acting by real scalar multiplication on each line, hence T is \mathbb{C} -linear, *i.e.* $T \in \text{End}(P)$. This equips $\text{Prym}(X, \rho)$ with the real multiplication by $\mathbb{Z}[T] \simeq O_D$ for a convenient discriminant D . Since $T^*\omega = \text{Tr}(D\phi)\omega$, the form ω becomes an eigenform for this real multiplication.

We now summarize results on the moduli space of all forms, its stratification and the action of $\text{GL}^+(2, \mathbb{R})$ upon it.

2.5. Stratification of the space of Prym eigenforms. As usual we denote by $\Omega\mathfrak{M}_g$ the Abelian differential bundle over the moduli space of Riemann surfaces of genus g , that is the moduli space of pairs (X, ω) , where X is a Riemann surface of genus g , and ω is an Abelian differential on X . For $g > 1$ the natural stratification given by the orders of the zeroes of ω is denoted by:

$$\Omega\mathfrak{M}_g = \bigsqcup_{\substack{0 < k_1 \leq \dots \leq k_n, \\ k_1 + \dots + k_n = 2g - 2}} \Omega\mathfrak{M}(k_1, \dots, k_n),$$

where $\Omega\mathfrak{M}(k_1, \dots, k_n) = \{(X, \omega) \in \Omega\mathfrak{M}_g, \text{ the zeroes of } \omega \text{ have orders } (k_1, \dots, k_n)\}$. We refer to [HM79, Mas82, KZ97, Vee90] for more details. These strata are not necessarily connected, but the classification has been obtained by Kontsevich and Zorich [KZ03].

Let $\Omega E_D \subset \Omega\mathfrak{M}_g$ (respectively, $\Omega E_D(k_1, \dots, k_n) \subset \Omega\mathfrak{M}(k_1, \dots, k_n)$) be the space of Prym eigenforms (respectively, with marked zeroes) with multiplication by O_D . Note that in general, neither the involution ρ , nor the representation of O_D is uniquely determined by the eigenform ω . We discuss this uniqueness for the case $\Omega E_D(4)$ in Section 5.

Example 2.3. *Coming back to Example 2.2 one has $\sqrt{\pi^*q} \in \Omega\mathfrak{M}(4)$, the underlying Riemann surface having genus 3. Thus, combining with Section 2.4, this furnishes examples in $\Omega E_D(4)$.*

Remark 2.4. *Applying Riemann-Hurwitz formula to the condition*

$$\dim_{\mathbb{C}} \text{Prym}(X, \rho) = g(X) - g(X/\rho) = 2$$

we get that $\Omega E_D = \emptyset$ unless $2 \leq g(X) \leq 5$. Moreover if $g(X) = 5$ then ρ has no fixed points i.e. the projection $X \rightarrow Y = X/\rho$ is unramified.

2.6. Dynamics on moduli spaces. The group $\text{GL}^+(2, \mathbb{R})$ acts on the set of translation surfaces by postcomposition in the charts of the translation structure. The subgroup $\text{SL}(2, \mathbb{R})$ preserves the area of a translation surface. The dynamics of the one-parameter diagonal subgroup of $\text{SL}(2, \mathbb{R})$ has been studied by Masur [Mas82] and Veech [Vee82]. One important conjecture in Teichmüller dynamics is that the closure of any $\text{GL}^+(2, \mathbb{R})$ -orbit is an algebraic orbifold. This conjecture has been proven for genus $g = 2$ by McMullen [McM07]. More recently, Eskin-Mirzakhani [EM10] announced some important breakthrough toward the establishment of this conjecture in the general case.

The strata $\Omega\mathfrak{M}(k_1, \dots, k_n)$ are obvious $\text{GL}^+(2, \mathbb{R})$ -orbit closures, and the $\text{GL}^+(2, \mathbb{R})$ -orbits of Veech surfaces are also closed [SW06]

The main important fact about the Prym eigenforms is that they furnishes new examples of closed $\text{GL}^+(2, \mathbb{R})$ -invariant subsets of $\Omega\mathfrak{M}_g$. Namely one has:

Theorem 2.5 (McMullen [McM06b]). *The locus ΩE_D of Prym eigenforms for real multiplication by O_D is a closed, $\text{GL}^+(2, \mathbb{R})$ -invariant subset of $\Omega\mathfrak{M}_g$.*

2.7. Weierstrass curves. Following McMullen, we call the locus $\Omega E_D(2g-2)$ the *Weierstrass locus*. Remark that the unique zero of the eigenforms in $\Omega E_D(2g-2)$ must be a fixed point of ρ . Since when $g(X) = 5$ the involution ρ has no fixed points (Remark 2.4), it follows that $\Omega E_D(2g-2)$ is non-empty only if $g = 2, 3, 4$. As a corollary of Theorem 2.5, a dimension count gives

Corollary 2.6. *For $g = 2, 3, 4$, the projection of the Weierstrass locus to \mathfrak{M}_g is a finite union of Teichmüller curves. Each of such curves is primitive unless D is a square.*

It turns out that for surfaces $(X, \omega) \in \Omega\mathfrak{M}(2g-2)$, if there exists a Prym involution ρ such that $\dim_{\mathbb{C}} \Omega(X, \rho) = 2$, and $\rho(\omega) = -\omega$, then the following are equivalent (see [McM07]):

- (1) $(X, \omega) \in \Omega E_D(2g-2)$.
- (2) There is a hyperbolic element in $\text{SL}(X, \omega)$.
- (3) The group $\text{SL}(X, \omega)$ is a lattice.

Teichmüller curves in \mathfrak{M}_2 have been intensively studied ([McM03a, McM05a, McM06b, Cal04]). The situation is now rather well understood. The question whether or not the Weierstrass locus is connected has been raised in [McM05a] and solved for $g = 2$:

Theorem 2.7 (McMullen [McM05a]). *For any integer $D \geq 5$ with $D \equiv 0$ or $1 \pmod{4}$*

- (1) *Either the Weierstrass locus $\Omega E_D(2)$ is connected, or*
- (2) *$D \equiv 1 \pmod{8}$ and $D \neq 9$, in which case $\Omega E_D(2)$ has exactly two components.*

For $D < 5$, $\Omega_D(2) = \emptyset$.

We are finally in a position to state precisely our results.

2.8. Statements of the results.

Theorem 2.8 (Generic case). *Let $D \geq 17$ be a discriminant. The locus $\Omega E_D(4)$ is non empty if and only if $D \not\equiv 5 \pmod{8}$. In this case, one has the two possibilities:*

- (1) *Either D is even, then the locus $\Omega E_D(4)$ consists of a single $\mathrm{GL}^+(2, \mathbb{R})$ -orbit,*
- (2) *or D is odd then the locus $\Omega E_D(4)$ consists of two $\mathrm{GL}^+(2, \mathbb{R})$ -orbits.*

Moreover, if $D_1 \neq D_2$, then $\Omega E_{D_1}(4) \cap \Omega E_{D_2}(4) = \emptyset$.

Remark 2.9.

- (1) *An important difference between $\Omega E_D(4)$ and $\Omega E_D(2)$ is the symplectic form of the Prym varieties. In the case $\Omega E_D(2)$, the Prym variety is the Jacobian variety of a Riemann surface, therefore the symplectic form is given by $\begin{pmatrix} J & 0 \\ 0 & J \end{pmatrix}$, where $J = \begin{pmatrix} 0 & 1 \\ -1 & 0 \end{pmatrix}$, but in the case $\Omega E_D(4)$, the symplectic form of the Prym variety is given by the matrix $\begin{pmatrix} J & 0 \\ 0 & 2J \end{pmatrix}$. This difference is responsible for the non-existence of $\Omega E_D(4)$, when $D \equiv 5 \pmod{8}$.*
- (2) *We would like also to emphasize on the fact that, even though we have the same statement compared to Theorem 2.7 when $D \equiv 1 \pmod{8}$, i.e. $\Omega E_D(4)$ has two components, the reason for this disconnectedness is different in the two cases. Roughly speaking, in our case, the two components correspond to two distinct complex lines in the space $\Omega(X, \rho)^- \simeq H^1(X, \mathbb{R})^-$ (see Section 6), but in the case $\Omega E_D(2)$, the two components correspond to the same complex line, they can only be distinguished by the spin invariant (see [McM05a, Section 5]).*
- (3) *Using similar ideas, we obtain a partial classification of Teichmüller curves in $\Omega E_D(6)$. See Appendix, Section D for more precise detail.*

There are only 4 admissible values for D smaller than 17, namely $D \in \{8, 9, 12, 16\}$. For these small values of D one has:

Theorem 2.10 (Small discriminants).

- (1) $\Omega E_9(4) = \Omega E_{16}(4) = \emptyset$.
- (2) $\Omega E_{12}(4)$ consists of a single $\mathrm{GL}^+(2, \mathbb{R})$ -orbit, the associated Teichmüller curve having 2 cusps.
- (3) $\Omega E_8(4)$ consists of a single $\mathrm{GL}^+(2, \mathbb{R})$ -orbit, the associated Teichmüller curve having only one cusp. Moreover, if $(X, \omega) \in \Omega E_8(4)$ then (X, ω) has no simple cylinders.

Theorem 2.10 is a direct consequence of the classification of cylinder decompositions in $\Omega E_D(4)$, its proof is given in Section 4.4.

Remark 2.11. *In the appendix we prove a similar result (Theorem 1.3) for the Prym locus of eigenforms in genus 4 with a single zero, namely $\Omega E_D(6)$.*

3. CYLINDER DECOMPOSITIONS OF PRYM EIGENFORMS

In this section we give a complete topological description of the cylinder decompositions of Prym eigenforms. A good introduction to the geometry of translation surfaces is [Tro86]; See also [MaTa02, Zor06].

3.1. Cylinder decompositions. Associated to any Abelian differential is a flat metric structure with cone type singularities whose transition maps are translation $z \mapsto z + c$. The singularities of the flat metric structure are the zeroes of the holomorphic 1-form. On such surfaces, a *saddle connection* is a geodesic segment whose endpoints are singularities (the endpoints might coincide), a *cylinder* is an open subset isometric to $\mathbb{R} \times]0, h[/ \mathbb{Z}$, where the action of \mathbb{Z} is generated by $(x, y) \mapsto (x + w, y)$, $w > 0$, and maximal with respect to this property, h and w are called the *height* and the *width* of the cylinder (see [HM79] for more details). A cylinder is bounded by concatenations of saddle connections freely homotopic to the waist curve. Note that, in general, the two boundary components are not necessarily disjoint. If each boundary component of a cylinder is a single saddle connection, we say that the cylinder is *simple*.

For any direction $\theta \in \mathbb{S}^1$, we have a flow on the translation surface whose trajectories are geodesics in this direction. We say that the flow in direction θ is *completely periodic* if each trajectory is either a saddle connection or a closed geodesic. The surface is then the union of finitely many open cylinder and saddle connections in this direction.

We say that the flow in direction θ is *uniformly distributed* if each trajectory is dense and uniformly distributed with respect to the natural Lebesgue measure on Σ .

Observe that surfaces that are completely periodic in some direction are very rare in a stratum. But in the Prym locus this is the typical case. Indeed, the surfaces in $\Omega E_D(2)$ and $\Omega E_D(1, 1)$ are completely periodic, that is, if there is a closed geodesic in some direction θ , then the surface is completely periodic in this direction (see [Cal04], and [McM07]). Following [McM06b], surfaces $(X, \omega) \in \Omega E_D(4)$ are Veech surfaces *i.e.* the Veech group $\mathrm{SL}(X, \omega) := \mathrm{Stab}_{\mathrm{SL}(2, \mathbb{R})}(X, \omega)$ is a lattice. Thus the central result from [Vee89] applies:

Theorem 3.1 (Veech [Vee89]). *Let (X, ω) be a Veech surface. Then for any θ :*

- (1) *Either the flow in direction θ is completely periodic, or*
- (2) *the flow in direction θ is uniformly distributed.*

For the rest of this section let $(X, \omega) \in \Omega E_D(4)$ be a Prym eigenform for some discriminant D . Recall that $\rho : X \rightarrow X$ is a holomorphic involution of the genus 3 Riemann surface X and ω is anti-invariant *i.e.* $\rho^*(\omega) = -\omega$. Let Σ denote the flat surface associated to the pair (X, ω) , then ρ is an isometry of Σ whose differential is $-\mathrm{id}$. Note that the unique singular point of Σ (which corresponds to the zero of ω) is obviously a fixed point of ρ (compare to Example 2.2).

3.2. Topological classification of cylinder decompositions. The next proposition furnishes a classification of topological configurations of cylinder decompositions of Prym eigenforms.

Proposition 3.2. *Let $(X, \omega) \in \Omega E_D(4)$ be a Prym eigenform for some discriminant D . If the horizontal direction is completely periodic then the horizontal flow on X decomposes the surface into cylinders following one of the following five models (models $A+$, $A-$, B , C , D):*

- *three cylinders: one is fixed, two are exchanged by the involution (see Figure 1).*
- *two cylinders exchanged by the involution (see Figure 2, left).*
- *one cylinder fixed by the involution (see Figure 2, right).*

The proof of the proposition will use the following lemma, easily derived from the Riemann-Hurwitz's formula

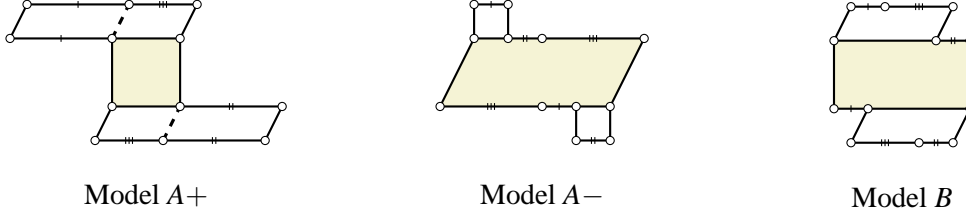

FIGURE 1. Three-cylinder decompositions for periodic directions on Prym eigenforms (the cylinder fixed by ρ is colored in gray).



FIGURE 2. Two-cylinder decomposition (the cylinders must be exchanged by ρ) on the left, and one-cylinder decomposition on the right.

Lemma 3.3. *Let X be a Riemann surface of genus 3, and $\rho : X \rightarrow X$ be a holomorphic involution. Suppose that $\dim_{\mathbb{C}} \text{Prym}(X, \rho) = 2$, then ρ has exactly 4 fixed points.*

Proof of Proposition 3.2. Since the cone angle at the singularity of Σ is $(4+1)2\pi = 10\pi$, there are exactly 5 horizontal saddle connections. Each of these saddle connections appears in the lower boundary of a unique cylinder, thus we have a partition of the set of horizontal saddle connections into k subsets, where k is the number of cylinders. Clearly we have $k \leq 5$. Note that a saddle connection can not be the upper boundary of a cylinder, and the lower boundary of another cylinder, since this would imply that this saddle connection is actually a simple closed geodesic containing no singularities.

Since ρ is an isometry, it sends a cylinder isometrically to a cylinder, therefore ρ induces a permutation on the set of cylinders. As $D\rho = -\text{id}$, ρ sends the lower boundary of a cylinder to the upper boundary of another cylinder, hence a cylinder which is invariant by ρ contains exactly two fixed points in its interior. Recall that the singularity of Σ is already one fixed point, thus there are at most one cylinder invariant by ρ .

- (1) If $k = 5$ or $k = 4$, then there always exists a saddle connection which is the lower boundary of one cylinder, and the upper boundary of another one, therefore these cases are excluded.
- (2) If $k = 3$, then ρ preserves one cylinder, and exchanges the other two. Let C_0 be the cylinder invariant by ρ , and C_1, C_2 the two permuted cylinders. Let n_0 be the number saddle connections contained in the lower boundary of C_0 , since the upper boundary and lower boundary of C_0 are exchanged by ρ , there are also n_0 saddle connections in the upper boundary of C_0 . Note also that the lower boundary of C_1 is mapped onto the upper boundary of C_2 and vice versa.
 - (a) Case $n_0 = 1$: in this case C_0 is a simple cylinder, and the lower boundaries of both C_1 and C_2 must contain two saddle connections. The corresponding configuration is given by Model A+.

- (b) Case $n_0 = 2$: in this case, none of the cylinders are simple, and there is also only one possible configuration which is given by Model *B*.
 - (c) Case $n_0 = 3$: in this case, both C_1, C_2 are simple, and the unique possible configuration is given by Model *A*–.
- (3) If $k = 2$, then the two cylinders are permuted by ρ . Since the number of saddle connections in the lower boundary of one cylinder is the same as the number of those in the upper boundary of the other one, it follows that the partition of the set of saddle connections must be $\{2, 3\}$ (otherwise, there would be a saddle connection which is a lower boundary of one cylinder, and the upper boundary of the other one). Hence, there is only one possible configuration which is given by Model *C*.
- (4) If $k = 1$, both of the lower and upper boundaries of the unique cylinder contain 5 saddle connections. Observe that ρ induces a permutation on the set of saddle connections. Since there are already two fixed points of ρ in the interior of the cylinder, there is only one fixed point in the interior of the saddle connections, which means that only one saddle connection is invariant by ρ . Therefore, ρ must preserve one saddle connection, and exchange the other two pairs. Again, there is one possible configuration, which is given by Model *D*.

Proposition 3.2 is now proved. □

An immediate consequence of Proposition 3.2 is

Corollary 3.4. *For any Abelian differential in the locus $\Omega E_D(4)$, the associated flat surface admits a three-cylinder decomposition.*

Proof. Let Σ be the flat surface associated to an Abelian differential in $\Omega E_D(4)$. By Corollary 2.6, we know that Σ is a Veech surface, therefore it admits infinitely many completely periodic directions. Without loss of generality, we can assume that the horizontal direction is completely periodic for Σ . From Proposition 3.2, we only have to consider the cases *C* and *D* where Σ is decomposed into one or two cylinders. But in those cases, one can easily find a simple cylinder in another direction $\theta \neq (1, 0) \in \mathbb{S}^1$. Since Σ is a Veech surface, it is also decomposed into cylinders in the direction θ . But since there is at least one simple cylinder in that direction, the new decomposition must belong to the cases *A*+ or *A*–. □

Remark 3.5. *It turns out (see Proposition 4.7) that for all but one value of D , the surfaces in $\Omega E_D(4)$ always admit a cylinder decomposition in Model *A*±.*

4. PROTOTYPES

The main goal of this section is to provide a canonical representation of any three-cylinder decomposition of a surface in $\Omega E_D(4)$ in terms of *prototype* (up to the action of $\mathrm{GL}^+(2, \mathbb{R})$). More precisely, for each such decomposition (see Proposition 3.2) we will attach parameters satisfying some specific conditions, which provide a necessary and sufficient condition to be a surface in $\Omega E_D(4)$. As a consequence, we derive the following finiteness result.

Theorem 4.1. *Let D be a fixed positive integer. Let Q_D be the (finite) set of tuples $(w, h, t, e, \varepsilon) \in \mathbb{Z}^5$ satisfying*

$$\begin{cases} w > 0, h > 0, \varepsilon = \pm 1, \\ e + 2h < w, 0 \leq t < \gcd(w, h), \\ \gcd(w, h, t, e) = 1, \text{ and } D = e^2 + 8wh. \end{cases}$$

If $D \neq 8$ then there is an onto map from Q_D on the components of $\Omega E_D(4)$.

4.1. Normalizing cylinder decompositions. Recall that Corollary 3.4 tells us that a surface $(X, \omega) \in \Omega E_D(4)$ always admits a cylinder decomposition into Model $A+$, $A-$ or B . We will examine separately each of the three cases.

Notation. For all $\gamma \in H_1(X, \mathbb{Z})$ we set $\omega(\gamma) := \int_\gamma \omega$.

4.1.1. *Cylinder decompositions of type $A+$.*

Proposition 4.2. *Let $(X, \omega) \in \Omega E_D(4)$ be a Prym eigenform which admits a cylinder decomposition in Model $A+$. Let $\alpha_1, \beta_1, \alpha_{2,1}, \beta_{2,1}, \alpha_{2,2}, \beta_{2,2} \in H_1(X, \mathbb{Z})$ be a symplectic basis as presented in Figure 3. We set $\alpha_2 := \alpha_{2,1} + \alpha_{2,2}$ and $\beta_2 := \beta_{2,1} + \beta_{2,2}$. Then*

- (i) *There exists a unique generator T of O_D which is written in the basis $\{\alpha_1, \beta_1, \alpha_2, \beta_2\}$ by a matrix of the form $\begin{pmatrix} e - \text{id}_2 & 2B \\ B^* & 0 \end{pmatrix}$, $B \in \mathbf{M}_{2 \times 2}(\mathbb{Z})$, such that $T^*(\omega) = \lambda(T)\omega$ with $\lambda(T) > 0$.*
- (ii) *Up to the $\text{GL}^+(2, \mathbb{R})$ -action and Dehn twists $\beta_1 \mapsto \beta_1 + n\alpha_1$, $\beta_{2,i} \mapsto \beta_{2,i} + m\alpha_{2,i}$, $n, m \in \mathbb{Z}$, there exist $w, h, t \in \mathbb{N}$ such that the tuple (w, h, t, e) satisfies*

$$(\mathcal{P}) \begin{cases} w > 0, h > 0, 0 \leq t < \gcd(w, h), \\ \gcd(w, h, t, e) = 1, \\ D = e^2 + 8wh, \\ 0 < \lambda := \frac{e + \sqrt{D}}{2} < w \end{cases},$$

and the matrix of T is given by $\begin{pmatrix} e & 0 & 2w & 2t \\ 0 & e & 0 & 2h \\ h & -t & 0 & 0 \\ 0 & w & 0 & 0 \end{pmatrix}$. Moreover, in these coordinates we have

$$(1) \quad \begin{cases} \omega(\mathbb{Z}\alpha_1 + \mathbb{Z}\beta_1) = \lambda \cdot \mathbb{Z}^2 \\ \omega(\mathbb{Z}\alpha_{2,1} + \mathbb{Z}\beta_{2,2}) = \omega(\mathbb{Z}\alpha_{2,2} + \mathbb{Z}\beta_{2,2}) = \mathbb{Z}(w, 0) + \mathbb{Z}(t, h) \end{cases}$$

Conversely, let (X, ω) be an Abelian differential in $\Omega \mathfrak{M}(4)$ having a decomposition into three cylinders in model $A+$. Suppose that there exists $(w, h, t, e) \in \mathbb{Z}^4$ verifying (\mathcal{P}) such that, after normalizing by $\text{GL}^+(2, \mathbb{R})$, the conditions in (1) are satisfied, then (X, ω) belongs to $\Omega E_D(4)$.

Remark 4.3. *Since λ is the positive root of the polynomial $X^2 - eX - 2wh$, the condition $\lambda < w$ can be read $w^2 - ew - 2wh > 0$, or equivalently $e + 2h < w$.*

For the proof of Proposition 4.2, we need the following straightforward lemma

Lemma 4.4. *Let $P \cong \mathbb{C}^2/L$ be a polarized Abelian variety of dimension 2. Suppose that $L = L_1 \oplus L_2$, where $L_i \cong \mathbb{Z}^2$, and $L_1^\perp = L_2$ with respect to the symplectic form $\langle \cdot, \cdot \rangle$ on L . Let (a_i, b_i) , $i = 1, 2$, be a basis of L_i , and set $\langle a_i, b_i \rangle = \mu_i \in \mathbb{N} \setminus \{0\}$. If $T \in \text{End}(P)$ is self-adjoint, then the matrix of T in the basis (a_1, b_1, a_2, b_2) is given by*

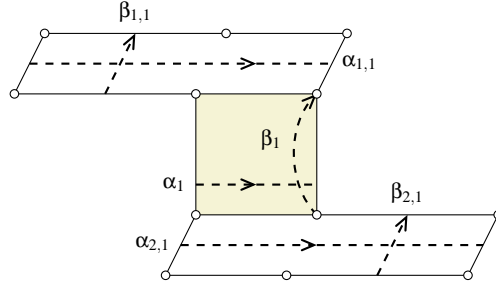

FIGURE 3. Basis $\{\alpha_1, \beta_1, \alpha_{2,1}, \beta_{2,1}, \alpha_{2,2}, \beta_{2,2}\}$ of $H_1(X, \mathbb{Z})$ associated to a cylinder decomposition in Model A+ (the fixed cylinder is colored in grey). If $\alpha_2 := \alpha_{2,1} + \alpha_{2,2}$ and $\beta_2 := \beta_{2,1} + \beta_{2,2}$, then $\{\alpha_1, \beta_1, \alpha_2, \beta_2\}$ is a symplectic basis of $H_1(X, \mathbb{Z})^-$.

$$T = \begin{pmatrix} e \cdot \text{id}_2 & B \\ \frac{\mu_1}{\mu_2} B^* & f \cdot \text{id}_2 \end{pmatrix},$$

with $e, f \in \mathbb{Z}, B, \frac{\mu_1}{\mu_2} B^* \in \mathbf{M}_{2 \times 2}(\mathbb{Z})$, where $\begin{pmatrix} a & b \\ c & d \end{pmatrix}^* = \begin{pmatrix} d & -b \\ -c & a \end{pmatrix}$.

Proof of Proposition 4.2. Since ρ permutes $\alpha_{2,1}$ and $-\alpha_{2,2}$ and permutes $\beta_{2,1}$ and $-\beta_{2,2}$, we have $\alpha_2, \beta_2 \in H_1(X, \mathbb{Z})^-$. Thus we have a splitting $H_1(X, \mathbb{Z})^- = L_1 \oplus L_2$, where $L_i = \mathbb{Z}\alpha_i + \mathbb{Z}\beta_i$. In the basis $(\alpha_1, \beta_1, \alpha_2, \beta_2)$, the restriction of the intersection form is given by the matrix $\begin{pmatrix} J & 0 \\ 0 & 2J \end{pmatrix}$.

Let T be a generator of \mathcal{O}_D , since T is self-adjoint, Lemma 4.4 implies that, in the basis $(\alpha_1, \beta_1, \alpha_2, \beta_2)$, the matrix of T has the form

$$T = \begin{pmatrix} e & 0 & 2w & 2t \\ 0 & e & 2c & 2h \\ h & -t & f & 0 \\ -c & w & 0 & f \end{pmatrix}_{(\alpha_1, \beta_1, \alpha_2, \beta_2)}$$

for some $w, h, t, c, e, f \in \mathbb{Z}$. By replacing T by $T - f$, which is still a generator of \mathcal{O}_D , we can assume that $f = 0$. Since ω is an eigenform, we have $T^*(\omega) = \lambda(T)\omega$. Using the fact that $(\omega(\alpha_1), \omega(\beta_1))$ is a basis of \mathbb{R}^2 , it is straightforward to verify that $\lambda(T) \neq 0$. Thus, by changing the sign of T if necessary, we can assume that $\lambda(T) > 0$. The uniqueness of T follows immediately from the fact that any generator of \mathcal{O}_D can be written as $a \cdot T + b \cdot \text{id}_4$, $a, b \in \mathbb{Z}$.

Using $\text{GL}^+(2, \mathbb{R})$, we can assume that $\omega(\alpha_1) = (\lambda, 0), \omega(\beta_1) = (0, \lambda)$. In the basis $(\alpha_1, \beta_1, \alpha_2, \beta_2)$, we have $\text{Re}(\omega) = (\lambda, 0, x, y), \text{Im}(\omega) = (0, \lambda, 0, z)$, with $x > 0, z > 0$. Since $T^*(\omega) = \lambda\omega$, it follows

$$(2) \quad (\lambda, 0, x, y) \cdot T = \lambda(\lambda, 0, x, y)$$

and

$$(3) \quad (0, \lambda, 0, z) \cdot T = \lambda(0, \lambda, 0, z)$$

From (2) we draw $x = 2w$, and $y = 2t$, and from (3), we draw $c = 0$, and $z = 2h$. We deduce in particular that $w > 0, h > 0$. We can renormalize further using Dehn twists $\beta_1 \mapsto n\alpha_1 + \beta_1$ and $\beta_2 \mapsto m\alpha_2 + \beta_2$ so that $0 \leq t < \text{gcd}(w, h)$. Properness of \mathcal{O}_D implies $\text{gcd}(w, h, t, e) = 1$.

Remark that T satisfies

$$(4) \quad T^2 = eT + 2wh\text{Id}_{\mathbb{R}^4}$$

Therefore λ satisfies the quadratic equation $\lambda^2 - e\lambda - 2wh = 0$. Moreover, since T generates O_D , Equation (4) implies that $D = e^2 + 8wh$. Since λ is a positive algebraic number, we must have $\lambda = \frac{e + \sqrt{D}}{2}$. By construction we have $0 < \lambda < w$. All the conditions of (\mathcal{P}) are now fulfilled.

Conversely, if (w, h, t, e) satisfies (\mathcal{P}) , and all the conditions in (1) hold then the construction using model $A+$ gives us an Abelian differential (X, ω) in $\Omega\mathcal{M}(4)$, which admits an involution $\rho : X \rightarrow X$ satisfying $\dim_{\mathbb{C}} \Omega(X, \rho)^- = 2$ (since $H_1(X, \mathbb{Z})^- \cong \mathbb{Z}^4$) and $\omega \in \Omega(X, \rho)^-$. The endomorphism $T : H_1(X, \mathbb{Z})^- \rightarrow H_1(X, \mathbb{Z})^-$ constructed as above is clearly self-adjoint, and its restriction to complex line $S = \mathbb{C} \cdot \omega$ is $\lambda \cdot \text{Id}_S$. Let $S' = S^\perp$ be the orthogonal complement of S in $\Omega(X, \rho)^-$ with respect to the intersection form, then S' is also a complex line in $\Omega(X, \rho)^-$. Since T satisfies Equation (4), the restriction of T to S' is $\lambda' \cdot \text{Id}_{S'}$, where λ' is the other root of the polynomial $X^2 - eX - 2wh$ (note that $\lambda' < 0$). Consequently, T is a \mathbb{C} -linear endomorphism of $\Omega(X, \rho)^-$, that is T belongs to $\text{End}(\text{Prym}(X, \rho))$. Since the subring of $\text{End}(\text{Prym}(X, \rho))$ generated by T is isomorphic to O_D , this completes the proof of the proposition. \square

4.1.2. *Cylinder decompositions of type A-*. The next result parallels Proposition 4.2.

Proposition 4.5. *Let (X, ω) be an Abelian differential in $\Omega E_D(4)$ which admits a decomposition into cylinders in the horizontal direction in Model A-. Let $\alpha_{1,1}, \beta_{1,1}, \alpha_{1,2}, \beta_{1,2}, \alpha_2, \beta_2 \in H_1(X, \mathbb{Z})$ be as in Figure 4 below. We set $\alpha_1 = \alpha_{1,1} + \alpha_{1,2}, \beta_1 = \beta_{1,1} + \beta_{1,2}$. Then*

- (i) *There exists a unique generator T of O_D which is written in the basis $\{\alpha_1, \beta_1, \alpha_2, \beta_2\}$ by the matrix $\begin{pmatrix} e \cdot \text{id}_2 & B \\ 2B^* & 0 \end{pmatrix}$ such that $T^*(\omega) = \lambda(T)\omega$ with $\lambda(T) > 0$.*
- (ii) *Up to the action $\text{GL}^+(2, \mathbb{R})$ and Dehn twists, there exist $w, h, t \in \mathbb{N}$ such that the tuple (w, h, t, e) satisfies condition (\mathcal{P}) of Proposition 4.2, and the matrix of T is given by $\begin{pmatrix} e & 0 & w & t \\ 0 & e & 0 & h \\ 2h & -2t & 0 & 0 \\ 0 & 2w & 0 & 0 \end{pmatrix}$. Moreover, in these coordinates we have*

$$(5) \quad \begin{cases} \omega(\mathbb{Z}\alpha_2 + \mathbb{Z}\beta_2) = \mathbb{Z}(w, 0) + \mathbb{Z}(t, h) \\ \omega(\mathbb{Z}\alpha_{1,1} + \mathbb{Z}\beta_{1,1}) = \omega(\mathbb{Z}\alpha_{1,2} + \mathbb{Z}\beta_{1,2}) = \frac{\lambda}{2} \cdot \mathbb{Z}^2 \end{cases}$$

Conversely, let (X, ω) be an Abelian differential in $\Omega\mathcal{M}(4)$ having a decomposition into three cylinders in model A-. Suppose that there exists $(w, h, t, e) \in \mathbb{Z}^4$ verifying (\mathcal{P}) , such that after normalizing by $\text{GL}^+(2, \mathbb{R})$, all the conditions in (5) are satisfied, then (X, ω) belongs to $\Omega E_D(4)$.

Proof of Proposition 4.5. We have $H_1(X, \mathbb{Z})^- = L_1 \oplus L_2$, where $L_i = \mathbb{Z}\alpha_i + \mathbb{Z}\beta_i$. In the basis $(\alpha_1, \beta_1, \alpha_2, \beta_2)$, the intersection form is given by the matrix $\begin{pmatrix} 2J & 0 \\ 0 & J \end{pmatrix}$. From Lemma 4.4, we know that the matrix of any element of O_D has the form $\begin{pmatrix} e \cdot \text{id}_2 & B \\ 2B^* & f \cdot \text{id}_2 \end{pmatrix}$, with B in $\mathbf{M}_{2 \times 2}(\mathbb{Z})$. The remainder of the proof follows the same lines as Proposition 4.2. \square

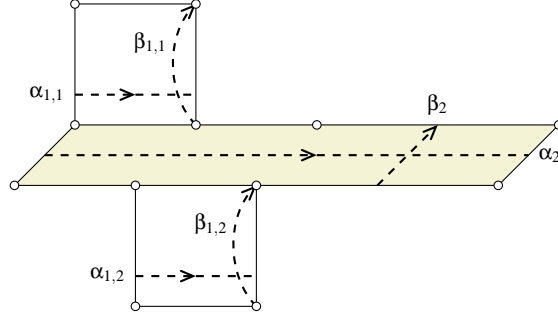

FIGURE 4. Basis $\{\alpha_{1,1}, \beta_{1,1}, \alpha_{1,2}, \beta_{1,2}, \alpha_2, \beta_2\}$ of $H_1(X, \mathbb{Z})$ associated to a cylinder decomposition in Model A– (the fixed cylinder is colored in grey). If $\alpha_1 := \alpha_{1,1} + \alpha_{1,2}$ and $\beta_1 := \beta_{1,1} + \beta_{1,2}$, then $\{\alpha_1, \beta_1, \alpha_2, \beta_2\}$ is a symplectic basis of $H_1(X, \mathbb{Z})^-$.

4.1.3. Cylinder decompositions of type B.

Proposition 4.6. *Suppose that $(X, \omega) \in \Omega E_D(4)$ admits a cylinder decomposition in Model B and let $\alpha_{1,1}, \beta_{1,1}, \alpha_{1,2}, \beta_{1,2}, \alpha_2, \beta_2 \in H_1(X, \mathbb{Z})$ be as in Figure 5 below. Set $\alpha_1 = \alpha_{1,1} + \alpha_{1,2}, \beta_1 = \beta_{1,1} + \beta_{1,2}$. Then*

- (i) *There exists a unique generator T of O_D which is written in the basis $(\alpha_1, \beta_1, \alpha_2, \beta_2)$ by a matrix of the form $\begin{pmatrix} e \cdot \text{id}_2 & B \\ 2B^* & 0 \end{pmatrix}$ such that $T^*(\omega) = \lambda(T)\omega$ with $\lambda(T) > 0$.*
- (ii) *Up to the action of $\text{GL}^+(2, \mathbb{R})$ and Dehn twists, there exist $w, h, t \in \mathbb{N}$ such that the tuple (w, h, t, e) satisfies*

$$(\mathcal{P}') \begin{cases} w > 0, h > 0, 0 \leq t < \gcd(w, h), \\ \gcd(w, h, t, e) = 1, \\ D = e^2 + 8wh, \\ 0 < \frac{e + \sqrt{D}}{4} < w < \frac{e + \sqrt{D}}{2} =: \lambda, \end{cases},$$

and the matrix of T is given by $\begin{pmatrix} e & 0 & w & t \\ 0 & e & 0 & h \\ 2h & -2t & 0 & 0 \\ 0 & 2w & 0 & 0 \end{pmatrix}$. Moreover, in these coordinates we have

$$(6) \quad \begin{cases} \omega(\mathbb{Z}\alpha_{1,1} + \mathbb{Z}\beta_{1,1}) = \omega(\mathbb{Z}\alpha_{1,2} + \mathbb{Z}\beta_{1,2}) = \frac{\lambda}{2} \cdot \mathbb{Z}^2, \\ \omega(\mathbb{Z}\alpha_2 + \mathbb{Z}\beta_2) = \mathbb{Z}(w, 0) + \mathbb{Z}(t, h). \end{cases}$$

Conversely, let (X, ω) be an Abelian differential in $\Omega\mathcal{M}(4)$ having a cylinder decomposition in Model B. Suppose that there exists $(w, h, t, e) \in \mathbb{Z}^4$ verifying (\mathcal{P}') such that, after normalizing by $\text{GL}^+(2, \mathbb{R})$, all the conditions in (6) are satisfied, then (X, ω) belongs to $\Omega E_D(4)$.

Proof of Proposition 4.6. We first observe that $(\alpha_{1,1}, \beta_{1,1}, \alpha_{1,2}, \beta_{1,2}, \alpha_2, \beta_2)$ is a canonical basis of $H_1(X, \mathbb{Z})$. To see this, we only have to check that $\langle \beta_{1,1}, \beta_{1,2} \rangle = \langle \beta_{1,1}, \beta_2 \rangle = \langle \beta_{1,2}, \beta_2 \rangle = 0$. But this follows immediately from the fact that the cycles $\beta_{1,1} + \beta_2, \beta_{1,2} + \beta_2, \beta_2$ can be represented by three disjoint simple closed curves. The proof of the proposition then follows the same lines as Proposition

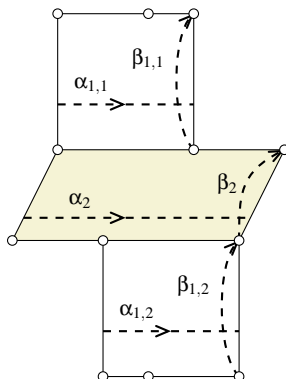

FIGURE 5. Basis $\{\alpha_{1,1}, \beta_{1,1}, \alpha_{1,2}, \beta_{1,2}, \alpha_2, \beta_2\}$ of $H_1(X, \mathbb{Z})$ associated to a cylinder decomposition in Model B (the fixed cylinder is colored in grey). If $\alpha_1 := \alpha_{1,1} + \alpha_{1,2}$ and $\beta_1 := \beta_{1,1} + \beta_{1,2}$, then $\{\alpha_1, \beta_1, \alpha_2, \beta_2\}$ is a symplectic basis of $H_1(X, \mathbb{Z})^-$.

4.5, with the exception that by construction we must have

$$0 < \frac{\lambda}{2} < w < \lambda.$$

We leave the details to the reader. □

4.2. Surfaces having no cylinder decompositions in model A_{\pm} .

Proposition 4.7. *Let $(X, \omega) \in \Omega E_D(4)$ be an eigenform. If (X, ω) admits no cylinder decompositions in Model A+ or Model A- then, up to the action of $GL^+(2, \mathbb{R})$, the surface (X, ω) is the one presented in Figure 6. In particular, we have $D = 8$.*

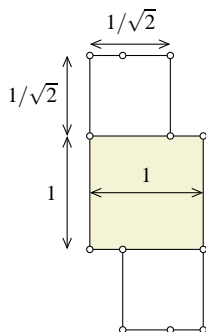

FIGURE 6. A surface in $\Omega E_D(4)$ (decomposed into cylinders in Model B) that does not admit a cylinder decomposition in Model A_{\pm} in any direction.

Proof of Proposition 4.7. Since Model A+ and Model A- are characterized by the fact that there exists a simple cylinder (see Proposition 3.2), we will show that in all cases, but one, we can find

a direction having a simple cylinder. Thus let $(X, \omega) \in \Omega E_D(4)$ be an eigenform and let us assume (X, ω) is decomposed into cylinders following Model B (see Figure 5). Using $GL^+(2, \mathbb{R})$, we can normalize so that

$$\begin{cases} \omega(\alpha_{1,1}) = (x, 0) \\ \omega(\beta_{1,1}) = (0, x) \\ \omega(\alpha_2) = (x+y, 0) \\ \omega(\beta_2) = (t, 1) \end{cases}$$

where the parameters $x, y, t \in \mathbb{R}$ satisfy $0 < y < x$ and $0 \leq t < x+y$. We will show that unless $t = 0$, $y = x^2/(x+1)$ and $x = 1/\sqrt{2}$ there always exists a direction having a simple cylinder.

- **Step 1:** $t = 0$. Let us consider the direction θ_1 of slope $\frac{x+1}{t-x-y}$. Clearly, if $\frac{x+y-t}{x+1}x < x-y$ then there exists a simple cylinder in direction θ_1 (see Figure 7, left). Thus let us assume $\frac{x+y-t}{x+1}x \geq x-y$, or equivalently

$$(7) \quad tx \leq 2xy - x + y.$$

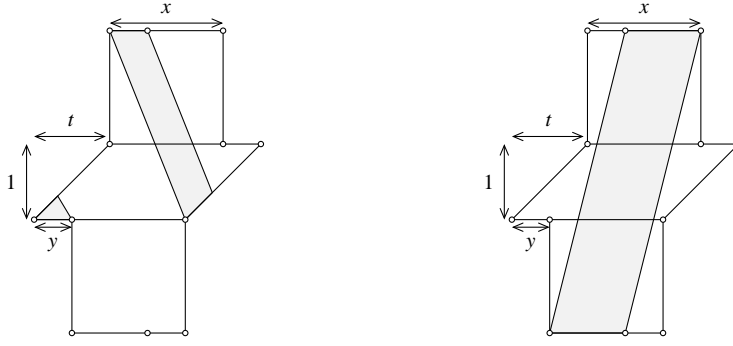

FIGURE 7. Cylinders in directions θ_1 and θ_2 .

Let us consider a second direction θ_2 of slope $\frac{2x+1}{t}$. Clearly if $t > 0$ and $\frac{tx}{2x+1} < y$ then there exists a simple cylinder in direction θ_2 (see Figure 7, right). Observe that if $t > 0$ then this case actually occurs since inequality (7) implies $tx \leq 2xy - x + y < y(2x+1)$. Thus the proposition is proven unless $t = 0$. Hence from now on, we assume $t = 0$.

- **Step 2:** $y = \frac{x^2}{x+1}$. We apply the previous idea to the direction θ_3 of slope $\frac{x+1}{x}$ (see Figure 8 for details).
- **Step 3:** $x = \frac{1}{\sqrt{2}}$. Since $y = \frac{x^2}{x+1}$, the inequality (7) becomes $x \geq \frac{1}{\sqrt{2}}$. To complete the first part of the proposition, it remains to show that if there is no simple cylinders then $x \leq \frac{1}{\sqrt{2}}$. This is achieved by considering the direction θ_4 of slope $-\frac{2x+1}{2x}$ as shown in Figure 9. Clearly, if $\frac{2x}{2x+1}(x+1) < x+y$ then there exists a simple cylinder in direction θ_4 (see the figure for details). Thus one can assume $\frac{2x}{2x+1}(x+1) \geq x+y$. Substituting y by $\frac{x^2}{x+1}$, we see that this inequality is equivalent to $x \leq \frac{1}{\sqrt{2}}$, that is the desired inequality. The proof of the first part of the proposition is now complete.

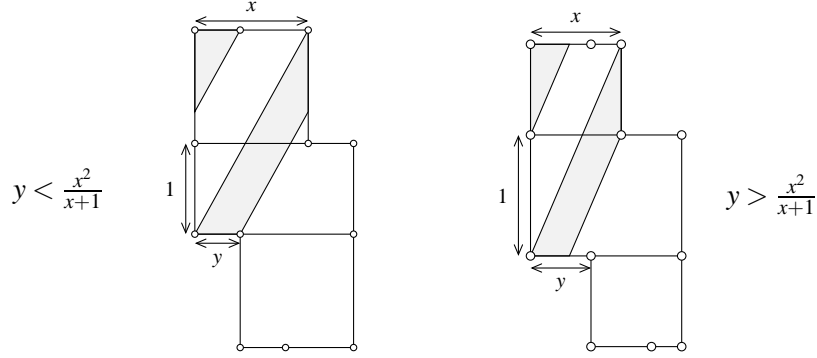

FIGURE 8. Cylinders in direction θ_3 of slope $\frac{x+1}{x}$ when $t = 0$. If $y \neq \frac{x^2}{x+1}$ then there always exists a simple cylinder in direction θ_3 .

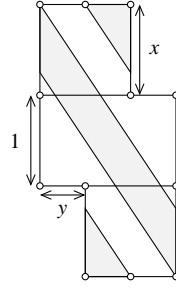

FIGURE 9. Cylinder in direction θ_4 of slope $-\frac{2x+1}{2x}$.

In order to compute the discriminant, one needs to put (X, ω) into the form of Proposition 4.6. Since $x + y = 1$ we have $w = 1$, $h = 1$ and $\lambda/2 = x$. Thus $\lambda = \frac{e + \sqrt{D}}{2} = 2x = \sqrt{2}$ and $e = 0$. Since the tuple $(w, h, t, e) = (1, 1, 0, 0)$ is a solution to (\mathcal{P}') the discriminant is $D = e^2 + 8wh = 8$. This completes the proof of Proposition 4.7. \square

4.3. Two Consequences.

Proof of Theorem 4.1. From Proposition 4.7, we know that, when $D \neq 8$, every surface in $\Omega E_D(4)$ admits a cylinder decomposition in models $A+$, or $A-$. Theorem 4.1 is then a direct consequence of Propositions 4.2 and 4.5. \square

From Propositions 4.2, 4.5 and 4.6, we also draw

Corollary 4.8. *Let D be a discriminant.*

- (1) *If $D \equiv 5 \pmod{8}$, then $\Omega E_D(4) = \emptyset$.*
- (2) *If $D \equiv 0, 1, 4 \pmod{8}$ and $D \geq 17$ then $\Omega E_D(4) \neq \emptyset$.*

Proof. The first assertion is immediate: if $(X, \omega) \in \Omega E_D(4)$ then Corollary 3.4 implies that (X, ω) admits a decomposition into three cylinders in some direction in model $A+$, $A-$ or B . Following

respectively Proposition 4.2, 4.5 or 4.6, there exists $(w, h, t, e) \in \mathbb{Z}^4$ such that $D = e^2 + 8wh$. Thus $D \equiv 0, 1, 4 \pmod{8}$.

Conversely, given any $D \geq 17$ such that $D \equiv 0, 1, 4 \pmod{8}$, it is straightforward to construct a solution $(w, h, t, e) \in \mathbb{Z}^4$ satisfying (\mathcal{P}) . Indeed:

- if $D \equiv 0 \pmod{8}$, the tuple $(D/8, 1, 0, 0)$ is a solution.
- if $D \equiv 1 \pmod{8}$, the tuple $((D-1)/8, 1, 0, -1)$ is a solution.
- if $D \equiv 4 \pmod{8}$, the tuple $((D-4)/8, 1, 0, -2)$ is a solution.

By Propositions 4.2, 4.5, we know that any solution to (\mathcal{P}) gives rise to a surface in $\Omega E_D(4)$. \square

4.4. Small discriminants. We can now prove Theorem 2.10, which deals with discriminants smaller than 17.

Proof of Theorem 2.10.

There are only 4 admissible values for D smaller than 17, i.e. $D \in \{8, 9, 12, 16\}$.

- (1) For $D = 16$, or $D = 9$, there are no (w, h, t, e) satisfying (\mathcal{P}) nor (\mathcal{P}') .
- (2) For $D = 12$, $(w, h, t, e) = (1, 1, 0, -2)$ is the only solution to (\mathcal{P}) , and there are no solutions to (\mathcal{P}') . *A priori*, we get two surfaces from a solution to (\mathcal{P}) , one for the Model $A+$, and one for the Model $A-$. But a surface admitting cylinder decomposition in Model $A+$ also admits cylinder decompositions in Model $A-$ and vice versa (see also Section 7). Therefore, the two surfaces belong to the same $\mathrm{GL}^+(2, \mathbb{R})$ -orbit. Since $D = 12$ is not a square, the surfaces in $\Omega E_{12}(4)$ can not be square-tiled. A classical theorem due to Thurston [Thu88] then implies that they do not admit any decomposition into one cylinder, or two cylinders exchanged by the Prym involution. Thus, the corresponding Teichmüller curve has exactly two cusps corresponding to two models of decomposition into three cylinders.
- (3) For $D = 8$, $(w, h, t, e) = (1, 1, 0, 0)$ is the only solution to (\mathcal{P}') , and there are no solutions to (\mathcal{P}) . A direct consequence of this fact is that the surfaces in $\Omega E_8(4)$ do not have any simple cylinder, since otherwise they would have a decomposition in model $A+$ or $A-$, and there would be a solution to (\mathcal{P}) . Another consequence is that the surfaces in $\Omega E_8(4)$ do not admit any decomposition into one or two cylinders, since otherwise they would have a simple cylinder. Therefore, the corresponding Teichmüller curve has only one cusp corresponding to the unique model of cylinder decomposition.

\square

5. UNIQUENESS

As remarked previously, in general, neither the representation of O_D nor the involution ρ is uniquely determined by the eigenform (X, ω) . However, if $(X, \omega) \in \Omega E_D(4)$, then it does uniquely determine the pair (ρ, i) , up to isomorphisms of the order O_D .

Theorem 5.1. *Let (X, ω) be an Abelian differential in $\Omega \mathfrak{M}(4)$. Suppose that there exist*

- *two involutions $\rho, \rho' : X \rightarrow X$ such that*

$$\dim_{\mathbb{C}} \Omega(X)_{\rho}^{-} = \dim_{\mathbb{C}} \Omega(X)_{\rho'}^{-} = 2 \quad \text{and} \quad \rho^*(\omega) = \rho'^*(\omega) = -\omega,$$

- two injective ring homomorphisms

$$i : O_D \rightarrow \text{End}(H_1(X, \mathbb{Z})_{\rho}^-) \quad \text{and} \quad i' : O_{D'} \rightarrow \text{End}(H_1(X, \mathbb{Z})_{\rho'}^-)$$

such that their images are self-adjoint, proper subrings.

If ω is an eigenform for both $i(O_D)$ and $i'(O_{D'})$ then $\rho = \rho'$, $D = D'$, and there exists a ring isomorphism $j : O_D \rightarrow O_{D'}$ such that $i' = i \circ j$.

Proof. Choose a direction for which the flat surface Σ associated to (X, ω) admits a decomposition into three cylinders, such a direction always exists by Corollary 3.4. Let us assume that the decomposition has type $A+$. The arguments that we will present also work for the two other models $A-$ and B . The key ingredient is to show that the restrictions of ρ and ρ' to some cylinder are the same.

The proof of Proposition 3.2 shows that there is exactly one invariant cylinder for each involution. But since there is only one simple cylinder in decomposition $A+$ it must be invariant by *both* ρ and ρ' . Hence $\rho = \rho'$.

Let $\alpha_1, \beta_1, \alpha_{2,1}, \beta_{2,1}, \alpha_{2,2}, \beta_{2,2}$ be as in Proposition 4.2, so that there exists $\lambda > 0$, and a generator T of O_D such that, $i(T)^*(\omega) = \lambda \cdot \omega$, and in the basis $(\alpha_1, \beta_1, \alpha_2, \beta_2)$,

$$i(T) = \begin{pmatrix} e & 0 & 2w & 2t \\ 0 & e & 0 & 2h \\ h & -t & 0 & 0 \\ 0 & w & 0 & 0 \end{pmatrix},$$

where $(w, h, t, e) \in \mathbb{Z}^4$ $w > 0$, $h > 0$, $e \in \mathbb{Z}$, $\gcd(w, h, t, e) = 1$. Similarly, there exists $\lambda' > 0$, and a generator T' of $O_{D'}$ satisfying the same conditions with adequate parameters $(w', h', t', e') \in \mathbb{Z}^4$. There also exist $g, g' \in \text{GL}(2, \mathbb{R})$ such that

$$\begin{cases} \text{Re}(g \cdot \omega) = (\lambda, 0, 2w, 2t), & \text{Im}(g \cdot \omega) = (0, \lambda, 0, 2h), \\ \text{Re}(g' \cdot \omega) = (\lambda', 0, 2w', 2t'), & \text{Im}(g' \cdot \omega) = (0, \lambda', 0, 2h'). \end{cases}$$

It follows that $g' = s \cdot g$ for some $s \in \mathbb{R}_+^*$ satisfying

$$s = \frac{\lambda}{\lambda'} = \frac{w}{w'} = \frac{t}{t'} = \frac{h}{h'} = \frac{p}{q} \text{ with } p, q > 0, \gcd(p, q) = 1.$$

In particular the tuple (w, h, t) (respectively, (w', h', t')) is divisible by p (respectively, q).

Recall that $\lambda^2 = e\lambda + 2wh$ and $\lambda'^2 = e'\lambda' + 2w'h'$. Hence

$$e = \frac{\lambda^2 - 2wh}{\lambda}, \quad \text{and} \quad e' = \frac{\lambda'^2 - 2w'h'}{\lambda'}.$$

Thus we have

$$e = \frac{p}{q} e'.$$

Therefore e is divisible by p and e' is divisible by q . Putting this together with $\gcd(w, h, t, e) = \gcd(w', h', t', e') = 1$ we draw $p = q = 1$. In conclusion $(w, h, t, e) = (w', h', t', e')$ and $\lambda = \lambda'$. Thus $D = D'$ and one can define a ring isomorphism $j : O_D \rightarrow O_{D'}$ by setting $j(T') = T$. Clearly, the isomorphism j satisfies the desired relation $i' = i \circ j$. This ends the proof of the theorem. \square

As an immediate consequence we draw:

Corollary 5.2. *If $D_1 \neq D_2$ then $\Omega E_{D_1}(4) \cap \Omega E_{D_2}(4) = \emptyset$.*

6. CASE D ODD

In this section, we show that when D is odd, the locus $\Omega E_D(4)$ consists of at least two distinct $\mathrm{GL}^+(2, \mathbb{R})$ -orbits.

Theorem 6.1. *Suppose that $D \equiv 1 \pmod{8}$, and let $p = (w, h, t, e) \in \mathcal{P}_D$ be an incomplete prototype. Then the two translation surfaces constructed from the complete prototypes $(p, +)$ and $(p, -)$ do not belong to the same $\mathrm{GL}^+(2, \mathbb{R})$ -orbit.*

Recall that we denote by \langle, \rangle the restriction of the intersection form to $H_1(X, \mathbb{Z})^-$. Theorem 6.1 follows from the next lemma.

Lemma 6.2. *Let T^+ (respectively, T^-) be the generator of O_D associated to the prototype $(p, +)$ (respectively, $(p, -)$). Then:*

$$\begin{aligned} \langle, \rangle|_{\mathrm{Im}(T^+)} &\neq 0 \pmod{2} \quad \text{and,} \\ \langle, \rangle|_{\mathrm{Im}(T^-)} &= 0 \pmod{2}, \end{aligned}$$

where $\mathrm{Im}(T^+)$ (respectively, $\mathrm{Im}(T^-)$) is the image of T^+ (respectively, T^-) in $H_1(X, \mathbb{Z})^-$.

Proof. Using the notations in Proposition 4.2 and Proposition 4.5, we have

$$T^+ = \begin{pmatrix} e & 0 & 2w & 2t \\ 0 & e & 0 & 2h \\ h & -t & 0 & 0 \\ 0 & w & 0 & 0 \end{pmatrix} = \begin{pmatrix} e & 0 & 0 & 0 \\ 0 & e & 0 & 0 \\ h & -t & 0 & 0 \\ 0 & w & 0 & 0 \end{pmatrix} \pmod{2},$$

and

$$T^- = \begin{pmatrix} e & 0 & w & t \\ 0 & e & 0 & h \\ 2h & -2t & 0 & 0 \\ 0 & 2w & 0 & 0 \end{pmatrix} = \begin{pmatrix} e & 0 & w & t \\ 0 & e & 0 & h \\ 0 & 0 & 0 & 0 \\ 0 & 0 & 0 & 0 \end{pmatrix} \pmod{2},$$

in the bases $(\alpha_1^+, \beta_1^+, \alpha_2^+, \beta_2^+)$ and $(\alpha_1^-, \beta_1^-, \alpha_2^-, \beta_2^-)$, respectively. Since by assumption D is odd, e is also odd, and

$$\begin{aligned} \mathrm{Im}(T^+) &= \langle \alpha_1^+ + h\alpha_2^+, \beta_1^+ - t\alpha_2^+ + w\beta_2^+ \rangle \pmod{2}, \\ \mathrm{Im}(T^-) &= \langle \alpha_1^-, \beta_1^- \rangle \pmod{2} \end{aligned}$$

By construction, in the case of $(p, +)$, $\langle \alpha_1^+, \beta_1^+ \rangle = 1$ and $\langle \alpha_2^+, \beta_2^+ \rangle = 0 \pmod{2}$, and in the case of $(p, -)$, $\langle \alpha_1^-, \beta_1^- \rangle = 0$, and $\langle \alpha_2^-, \beta_2^- \rangle = 1 \pmod{2}$. The lemma is now a straightforward computation. \square

Proof of Theorem 6.1. Suppose that the surfaces constructed from $(p, +)$ and $(p, -)$ belong to the same $\mathrm{GL}^+(2, \mathbb{R})$ -orbit of some Prym eigenform (X, ω) . Then Theorem 5.1 implies that there is a unique Prym involution $\rho : X \rightarrow X$, and a unique proper subring of $\mathrm{End}(\mathrm{Prym}(X, \rho))$ isomorphic to O_D consisting of self-adjoint endomorphisms for which ω is an eigenform. It follows, in particular, both T^+ and T^- belong to that subring.

Let S denote the subspace of $H^1(X, \mathbb{R})^- \cong \Omega(X, \rho)^-$ generated by $\{\mathrm{Re}(\omega), \mathrm{Im}(\omega)\}$, and S' denote the orthogonal complement of S with respect to the intersection form on $H^1(X, \mathbb{R})^-$ (dual to the symplectic form \langle, \rangle). Recall that by construction T^+ and T^- satisfy the same quadratic equation given by the polynomial $X^2 - eX - 2wh$, and $T_{|S}^+ = T_{|S}^- = \lambda \cdot \mathrm{Id}_S$, where λ is the unique positive root of this polynomial. If $\lambda' = e - \lambda$ is the other negative root then λ' is also an eigenvalue of both T^+ and T^- . Since T^\pm are self-adjoint, it follows that $T_{|S'}^+ = T_{|S'}^- = \lambda' \cdot \mathrm{Id}_{S'}$, and therefore $T^+ = T^-$. But this is a contradiction with Lemma 6.2, and Theorem 6.1 is proved. \square

Remark 6.3. *The proof of Theorem 6.1 actually shows that the two-dimensional subspaces of $H^1(X, \mathbb{R})^-$ generated by the eigenforms constructed from $(p, +)$ and $(p, -)$ are distinct.*

7. PROTOTYPES AND BUTTERFLY MOVES

Fix a discriminant D such that $D \equiv 0, 1, 4 \pmod{8}$. Following the previous sections, we naturally define the two sets \mathcal{P}_D and \mathcal{Q}_D as follows

$$\mathcal{P}_D := \left\{ (w, h, t, e) \in \mathbb{Z}^4, \begin{array}{l} w > 0, h > 0, 0 \leq t < \gcd(w, h), 2h + e < w, \\ \gcd(w, h, t, e) = 1, \text{ and } D = e^2 + 8hw. \end{array} \right\},$$

and

$$\mathcal{Q}_D := \{(w, h, t, e, \varepsilon) \in \mathbb{Z}^5, (w, h, t, e) \in \mathcal{P}_D, \text{ and } \varepsilon \in \{\pm 1\}\}.$$

Remark 7.1. *Observe that the condition $\lambda = \frac{e + \sqrt{D}}{2} < w$ is equivalent to $2h + e < w$.*

We call an element of \mathcal{P}_D (respectively, \mathcal{Q}_D) an *incomplete prototype* (respectively, a *complete prototype*) for the discriminant D . By Propositions 4.2 and 4.5, we know that a complete prototype $(w, h, t, e, \varepsilon)$ produces a Prym eigenform in $\Omega E_D(4)$, and from By Theorem 4.1 the number of components of $\Omega E_D(4)$ is bounded from above by $\#\mathcal{Q}_D$. The goal of this section is to introduce an equivalence relation \sim , called *Butterfly moves*, on \mathcal{Q}_D such that

$$\#\{\text{Components of } \Omega E_D(4)\} \leq \#(\mathcal{Q}_D / \sim).$$

7.1. Splitting and switching. We describe two moves, called *Butterfly Moves*, to pass from Model $A+$ to Model $A-$, and vice et versa.

7.1.1. Passing from Model $A+$ to Model $A-$. Let Σ be the flat surface associated to some Prym eigenform $(X, \omega) \in \Omega E_D(4)$. Let us assume that Σ admits a three-cylinder decomposition in Model $A+$, and let $(C_i)_{i=1,2,3}$ the cylinders (C_0 is the cylinder fixed by ρ and C_1, C_2 are exchanged by ρ). Observe that there are 3 saddle connections homologous to the core curve of C_0 : there are I_1, I_2 , the boundaries of the cylinder C_0 , and $J = \partial C_1 \cap \partial C_2$ the intersection of the two cylinders C_1 and C_2 . Cutting Σ along I_1, I_2 , and J , we get three connected components corresponding to the cylinders C_0, C_1, C_2 . The component corresponding to C_1 is a torus minus two discs whose boundary circles meet at one point, the two boundary circles correspond respectively to I_1 and J . We can split the common point of the two circles into two points, and then glue the two segments arising from the former circles together. The resulting surface is a torus T_1 with a simple geodesic segment I_1 joining two distinct points.

We can now describe the move that will switch to a decomposition into Model $A-$. Let γ_1 be a simple closed geodesic in T_1 which does not meet the interior of I_1 , then γ_1 corresponds to a simple closed geodesic on Σ which is contained in $\overline{C_1}$. The simple closed geodesics homotopic to γ_1 in Σ fill out a simple cylinder C_{γ_1} which is included in $\overline{C_1}$. Since $C_2 = \rho(C_1)$, we also have a simple cylinder C_{γ_2} in the same direction included in $\overline{C_2}$. It follows that Σ admits a decomposition of type $A-$ in the direction of γ_1 .

7.1.2. *Passing from Model A− to Model A+.* Conversely, if we have a decomposition of Σ of type A−, then cutting Σ along the boundaries of C_1 and C_2 , we also get three connected components. The one corresponding to C_0 is a torus minus 4 discs whose boundary circles meet at one point. We can split this common point into 4 points, we then get a once holed torus whose boundary consists of 4 segments divided into two pairs. Gluing two segments in each pair we finally obtain a flat torus with two marked geodesic segments having a common endpoint. Note that the two geodesic segments are parallel, and have the same length. We call the (closed) flat torus T and the union of the two segments I . Let γ be a simple closed geodesic in T which does not meet the interior of I , then γ corresponds to a simple closed geodesic on Σ , which is contained in $\overline{C_0}$. The simple closed geodesics homotopic to γ fill out a simple cylinder in Σ which is invariant by the involution ρ , it follows that Σ admits a decomposition of type A+ in the same direction than γ .

We call the operations of switching between decompositions of type A+ and A− described above *Butterfly moves*. Here we borrow the terms from [McM05a], even though the geometric interpretation is less clear in our situation.

The switching from a decomposition of type A+ to another one of type A− will be called a *Butterfly move of first kind*, the inverse switching will be called a *Butterfly move of second kind*.

7.2. **Admissibility.** We first need to know when a Butterfly move can be carried out. If we are to make a Butterfly move of first kind, let $\alpha_1, \beta_2, \alpha_{2,i}, \beta_{2,i}$ be as in Proposition 4.2. Then there exists a unique pair $(p, q) \in \mathbb{Z}^2$, with $\gcd(p, q) = 1$, such that $\gamma = p\alpha_{2,1} + q\beta_{2,1}$. Similarly, if we are to make a Butterfly move of second kind, then letting $\alpha_{1,i}, \beta_{1,i}, \alpha_2, \beta_2$ as in Proposition 4.5, one has $\gamma = p\alpha_2 + q\beta_2$. In both cases, we call (p, q) the parameter of the Butterfly move. The following lemma is an elementary observation.

Lemma 7.2. *The Butterfly move of both kinds can be carried out if and only if the prototype $(w, h, t, e, \varepsilon)$ and the parameter (p, q) satisfy*

$$0 < \lambda|q| < w,$$

or equivalently $(e + 4|q|h)^2 < D$. In this case, we say that the Butterfly move is admissible.

Proof. Identifying any flat torus with a quotient \mathbb{C}/L , where $L \simeq \mathbb{Z}^2$ is a lattice, we can associate to every oriented path on the torus a unique vector in $\mathbb{R}^2 \simeq \mathbb{C}$. For a Butterfly move of the first kind (respectively, second kind), the vector associated to the segment I_1 (respectively, I) is $(\lambda, 0)$, and the vector associated to γ_1 (respectively, γ) is $(pw + qt, qh)$. Recall that the Butterfly move is admissible if and only if γ_1 (respectively, γ) does not meet I_1 (respectively, I). In both situations, this condition is equivalent to

$$0 < \left| \det \begin{pmatrix} \lambda & pw + qt \\ 0 & qh \end{pmatrix} \right| < \left| \det \begin{pmatrix} w & t \\ 0 & h \end{pmatrix} \right| \Leftrightarrow 0 < \lambda|q| < w.$$

To see that this condition is equivalent to $(e + 4|q|h)^2 < D$, recall that $0 < 2\lambda = e + \sqrt{D}$. Thus $-\sqrt{D} < e < e + 4|q|h$. To see that $e + 4|q|h < \sqrt{D}$, we write $8wh = D - e^2 = 2\lambda(\sqrt{D} - e)$, therefore

$$\begin{aligned} 8\lambda|q|h &< 8wh = 2\lambda(\sqrt{D} - e) \\ \Leftrightarrow e + 4|q|h &< \sqrt{D}. \end{aligned}$$

□

Definition 7.3. For $q \in \mathbb{N} \setminus \{0\}$ we define B_q the Butterfly move with parameter $(1, q)$. We also define B_∞ as the Butterfly move with parameter $(0, 1)$.

Remark 7.4. The Butterfly moves B_1 and B_∞ are always admissible.

7.3. Coding Butterfly moves. Having a Butterfly move B_q admissible for some complete prototype $(w, h, t, e, \varepsilon)$, we obtain a new complete prototype $(w', h', t', e', -\varepsilon)$. The goal of this section is to give a formula to compute the new prototype from the former one and the parameter of the Butterfly move.

Proposition 7.5. Let $(w, h, t, e, +) \in \mathcal{Q}_D$ be a complete prototype. Suppose that the Butterfly move B_q is admissible for this prototype and let $(w', h', t', e', -)$ be the complete prototype associated to the new decomposition.

(1) If $q \neq \infty$ then

$$\begin{cases} e' = -e - 4qh, \\ h' = \gcd(qh, w + qt). \end{cases}$$

(2) If $q = \infty$ then

$$\begin{cases} e' = -e - 4h, \\ h' = \gcd(t, h). \end{cases}$$

In both cases w' is determined by the relation $D = e^2 + 8wh = e'^2 + 8w'h'$.

Proof. Let $\gamma_1 = \alpha_{2,1} + q\beta_{2,1}$ ($\gamma_1 = \beta_{2,1}$ if $q = \infty$) and C_{γ_1} be the cylinder in \overline{C}_1 filled out by simple closed geodesic freely homotopic to γ_1 . Let I_{γ_1} be a saddle connection such that $I_{\gamma_1} \subset \overline{C}_{\gamma_1}$. Remark that $I_1 \cup I_{\gamma_1}$ is freely homotopic to a simple closed curve $\eta_1 \subset \overline{C}_1$ such that $\mathbb{Z}\gamma_1 + \mathbb{Z}\eta_1 = \mathbb{Z}\alpha_{2,1} + \mathbb{Z}\beta_{2,1}$. We choose the orientation for η_1 so that $(\omega(\gamma_1), \omega(\eta_1))$ defines the same orientation as $(\omega(\alpha_{2,1}), \omega(\beta_{2,1}))$. First, we set

- $\tilde{\alpha}_{2,1} = \gamma_1, \tilde{\alpha}_{2,2} = -\rho(\gamma_1), \tilde{\alpha}_2 = \tilde{\alpha}_{2,1} + \tilde{\alpha}_{2,2}$, and
- $\tilde{\beta}_{1,1} = \eta_1, \tilde{\beta}_{2,2} = -\rho(\eta_1), \tilde{\beta}_2 = \tilde{\beta}_{2,1} + \tilde{\beta}_{2,2}$.

Then $(\alpha_1, \beta_1, \tilde{\alpha}_2, \tilde{\beta}_2)$ is a symplectic basis of $H_1(X, \mathbb{Z})^-$. Next, we set

- $\alpha'_1 = \tilde{\alpha}_2$,
- $\beta'_1 = \tilde{\beta}_2 + 2\alpha_1$,
- $\tilde{\alpha}'_2 = \alpha_1$,
- $\tilde{\beta}'_2 = \beta_1 + \tilde{\alpha}_2$.

Then $(\alpha'_1, \beta'_1, \tilde{\alpha}'_2, \tilde{\beta}'_2)$ is another symplectic basis of $H_1(X, \mathbb{Z})^-$. Observe that in this basis the intersection form is written as $\begin{pmatrix} 2J & 0 \\ 0 & J \end{pmatrix}$.

Recall that we have associated to $(w, h, t, e, +)$ a unique generator of \mathcal{O}_D which is written in the basis $(\alpha_1, \beta_1, \alpha_2, \beta_2)$ as $T = \begin{pmatrix} e & 0 & 2w & 2t \\ 0 & e & 0 & 2h \\ h & -t & 0 & 0 \\ 0 & w & 0 & 0 \end{pmatrix}$ such that $T^*\omega = \lambda\omega$, with $\lambda = \frac{e+\sqrt{D}}{2} > 0$. We now consider separately the two cases $q \in \mathbb{N} \setminus \{0\}$ first and then $q = \infty$.

(1) If $q \in \mathbb{N}, q > 0$, then $\tilde{\alpha}_2 = \alpha_2 + q\beta_2$. One can choose η_1 so that $\tilde{\beta}_2 = \beta_2$. Thus, we have

$$T = \begin{pmatrix} e & 0 & 2w + 2qt & 2t \\ 0 & e & 2qh & 2h \\ h & -t & 0 & 0 \\ -qh & w + qt & 0 & 0 \end{pmatrix}_{(\alpha_1, \beta_1, \tilde{\alpha}_2, \tilde{\beta}_2)}$$

and

$$T = \begin{pmatrix} -2qh & 0 & h & -e - t - 2qh \\ 0 & -2qh & -qh & w + qt \\ 2w + 2qt & 2e + 2t + 4qh & e + 2qh & 0 \\ 2qh & 2h & 0 & e + 2qh \end{pmatrix}_{(\alpha'_1, \beta'_1, \tilde{\alpha}'_2, \tilde{\beta}'_2)}$$

As a matter of fact, the matrix of the basis change from $(\alpha_1, \beta_1, \tilde{\alpha}_2, \tilde{\beta}_2)$ to $(\alpha'_1, \beta'_1, \tilde{\alpha}'_2, \tilde{\beta}'_2)$ is $\begin{pmatrix} 0 & 2 & 1 & 0 \\ 0 & 0 & 0 & 1 \\ 1 & 0 & 0 & 1 \\ 0 & 1 & 0 & 0 \end{pmatrix}$. Let $(\alpha'_1, \beta'_1, \alpha'_2, \beta'_2)$ be the symplectic basis of $H_1(X, \mathbb{Z})^-$ associated to the cylinder decomposition in the direction of $\omega(\alpha'_1)$ (see Figure 4 and Proposition 4.5). Since (α'_2, β'_2) and $(\tilde{\alpha}'_2, \tilde{\beta}'_2)$ are related by an element of $SL(2, \mathbb{Z})$, the matrix of T in the basis $(\alpha'_1, \beta'_1, \alpha'_2, \beta'_2)$ has the form $\begin{pmatrix} -2qh \cdot \text{id}_2 & B \\ 2B^* & (e + 2qh) \cdot \text{id}_2 \end{pmatrix}$.

We set $T' = T - (e + 2qh)$, then $T^*(\omega) = (\lambda - (e + 2qh))\omega$. Let us show that $\lambda - (e + 2qh) > 0 \Leftrightarrow \lambda - e > 2qh$. Since λ is an eigenvalue of T , we have $\lambda^2 = e\lambda + 2wh \Leftrightarrow \lambda(\lambda - e) = 2wh$, therefore

$$\begin{aligned} \lambda - e &> 2qh \\ \Leftrightarrow 2wh/\lambda &> 2qh \\ \Leftrightarrow w &> q\lambda \end{aligned}$$

Since the last inequality is warranted by the admissibility of the Butterfly move (Lemma 7.2), we can conclude that $\lambda - (e + 2qh) > 0$. It follows that T' is the unique generator of O_D associated to the decomposition in direction $\omega(\alpha'_1)$. Therefore, by Proposition 4.5, up to some appropriate Dehn twists $\beta'_1 \mapsto \beta'_1 + n\alpha'_1$, and $\beta'_2 \mapsto \beta'_2 + m\alpha'_2$, the matrix of T' in the basis $(\alpha'_1, \beta'_1, \alpha'_2, \beta'_2)$ has the form

$$T' = T - (e + 2qh) = \begin{pmatrix} e' & 0 & w' & t' \\ 0 & e' & 0 & h' \\ 2h' & -2t' & 0 & 0 \\ 0 & 2w' & 0 & 0 \end{pmatrix}_{(\alpha'_1, \beta'_1, \alpha'_2, \beta'_2)}$$

where $e' = -e - 4qh$, and (w', h', t', e') satisfies the conditions in (\mathcal{P}) . Note that we must have $h' = \gcd(qh, w + qt)$.

(2) If $q = \infty$ then $\gamma_1 = \beta_{2,1}$ and one can choose $\eta_1 = -\alpha_{2,1}$. Using the same notations as above we have

$$T = \begin{pmatrix} e & 0 & 2t & -2w \\ 0 & e & 2h & 0 \\ 0 & w & 0 & 0 \\ -h & t & 0 & 0 \end{pmatrix}_{(\alpha_1, \beta_1, \tilde{\alpha}_2, \tilde{\beta}_2)},$$

and

$$T = \begin{pmatrix} -2h & 0 & 0 & -e+w-2h \\ 0 & -2h & -h & t \\ 2t & 2e-2w+4h & e+2h & 0 \\ 2h & 0 & 0 & e+2h \end{pmatrix}_{(\alpha'_1, \beta'_1, \tilde{\alpha}'_2, \tilde{\beta}'_2)}.$$

Then $T' = T - (e+2h)$ is the generator of \mathcal{O}_D associated to the cylinder decomposition in direction $\omega(\alpha'_1)$. Let $(\alpha'_1, \beta'_1, \alpha'_2, \beta'_2)$ be the symplectic basis of $H_1(X, \mathbb{Z})^-$ associated to the new decomposition. In this basis, we have

$$T' = \begin{pmatrix} e' & 0 & w' & t' \\ 0 & e' & 0 & h' \\ 2h' & -2t' & 0 & 0 \\ 0 & 2w' & 0 & 0 \end{pmatrix}_{(\alpha'_1, \beta'_1, \alpha'_2, \beta'_2)}$$

where $e' = -e - 4h$, $h' = \gcd(t, h)$, and $(w', h', t', e') \in \mathcal{P}_D$. To see that $\lambda' = \lambda - (e+2h) > 0$, it suffices to follow the same lines as above, and recall that by construction we always have $\lambda < w$. This completes the proof of the proposition. \square

For Butterfly moves of second kind, we have the same result,

Proposition 7.6. *Let $(w, h, t, e, -) \in \mathcal{Q}_D$ be a complete prototype. Suppose that the Butterfly move B_q is admissible for this prototype. Let $(w', h', t', e', +)$ be the complete prototype associated to the new decomposition.*

(1) *If $q \neq \infty$ then*

$$\begin{cases} e' = -e - 4qh, \\ h' = \gcd(qh, w + qt). \end{cases}$$

(2) *If $q = \infty$ then*

$$\begin{cases} e' = -e - 4h, \\ h' = \gcd(t, h). \end{cases}$$

In both cases w' is determined by the relation $D = e^2 + 8wh = e'^2 + 8w'h'$.

Proof. We briefly sketch the proof since it is similar to the one of the previous proposition. Let $\gamma = \alpha_{2,1} + q\beta_{2,1}$ (or $\gamma = \beta_{2,1}$ if $q = \infty$). There exists a saddle connection I_γ which is contained in the cylinder C_γ such that $I_1 * I_2 * I_\gamma$ is homotopic to a simple closed curve η satisfying $\mathbb{Z}\gamma + \mathbb{Z}\eta = \mathbb{Z}\alpha_2 + \mathbb{Z}\beta_2$. We choose the orientation for η so that $(\omega(\gamma), \omega(\eta))$ defines the same orientation as $(\omega(\alpha_2), \omega(\beta_2))$. We set $\tilde{\alpha}_2 = \gamma$, $\tilde{\beta}_2 = \eta$, and

- $\alpha'_1 = \tilde{\alpha}_2$,
- $\beta'_1 = \tilde{\beta}_2 + \alpha_1$,
- $\tilde{\alpha}'_2 = \alpha_1$,
- $\tilde{\beta}'_2 = \beta_1 + 2\tilde{\alpha}_2$.

Then $(\alpha_1, \beta_1, \tilde{\alpha}_2, \tilde{\beta}_2)$ and $(\alpha'_1, \beta'_1, \tilde{\alpha}'_2, \tilde{\beta}'_2)$ are symplectic bases of $H_1(X, \mathbb{Z})^-$. Recall that we have associated to the prototype $(w, h, t, e, -)$ a generator T of O_D represented in the basis $(\alpha_1, \beta_1, \alpha_2, \beta_2)$ by the matrix $\begin{pmatrix} e & 0 & w & t \\ 0 & e & 0 & h \\ 2h & -2t & 0 & 0 \\ 0 & 2w & 0 & 0 \end{pmatrix}$. Now, we have two cases

- (1) **Case $q \in \mathbb{N}$:** in this case $\tilde{\alpha}_2 = \gamma = \alpha_2 + q\beta_2$, so we can choose $\tilde{\beta}_2 = \eta = \beta_2$. In the basis $(\alpha'_1, \beta'_1, \tilde{\alpha}'_2, \tilde{\beta}'_2)$, the matrix of T becomes $\begin{pmatrix} -2qh & 0 & 2h & -2e-2t-4qh \\ 0 & -2qh & -2qh & 2w+2qt \\ w+qt & e+t+2qh & e+2qh & 0 \\ qh & h & 0 & e+2qh \end{pmatrix}$. Set $T' = T - (e + 2qh)$, then T' is the generator of O_D associated to the cylinder decomposition in direction $\omega(\alpha'_1)$. Let $(\alpha'_1, \beta'_1, \alpha'_2, \beta'_2)$ be the symplectic basis of $H_1(X, \mathbb{Z})^-$ associated this decomposition (see Proposition 4.2). Then up to some Dehn twists $\beta'_1 \mapsto \beta'_1 + m\alpha'_1$, and $\beta'_2 \mapsto \beta'_2 + n\alpha'_2$, the matrix of T' in this basis has the form

$$T' = T - (e + 2qh) = \begin{pmatrix} e' & 0 & 2w' & 2t' \\ 0 & e' & 0 & 2h' \\ h' & -t' & 0 & 0 \\ 0 & w' & 0 & 0 \end{pmatrix}_{(\alpha'_1, \beta'_1, \alpha'_2, \beta'_2)},$$

where $e' = -e - 4qh$, $h' = \gcd(qh, w + qt)$, and (w', h', t', e') satisfies (\mathcal{P}) .

- (2) **Case $q = \infty$:** in this case $\tilde{\alpha}_2 = \gamma = \beta_2$, and we can take $\tilde{\beta}_2 = \eta = -\alpha_2$. The rest of the proof follows the same lines as in Proposition 7.5 Case (2). This completes the proof of the proposition. \square

7.4. Butterfly moves on incomplete prototypes. It turns out that the equivalence relation on Q_D generated by the Butterfly moves descends to an equivalence relation on \mathcal{P}_D . Indeed, we can define $p \sim p'$ if there exist $\varepsilon, \varepsilon' \in \{\pm\}$ such that $(p, \varepsilon) \sim (p', \varepsilon')$ in Q_D . In the next section we will be interested in the classification of the equivalence classes of this equivalence relation. For that we will only consider the Butterfly moves B_q , $q \in \{1, 2, \dots\} \cup \{\infty\}$. *A priori*, we have much more possible Butterfly moves, namely with parameters (p, q) , $p \neq 1$, but as we will see, the Butterfly moves B_q are sufficient for our purpose.

From Lemma 7.2, Propositions 7.5 and 7.6, we see that the admissibility condition, and the transformation rules are the same for Butterfly moves of both kinds, therefore, we can regard B_q as a transformation in \mathcal{P}_D , which is defined only on the subset $\{(w, h, t, e) \in \mathcal{P}_D, e + 4qh < \sqrt{D}\}$. This simple observation allows us to work exclusively on \mathcal{P}_D , and to use the McMullen's approach in order to obtain an upper bound of the number of equivalence classes.

8. COMPONENTS OF THE SPACE OF PROTOTYPES

The main goal of this section is to set a bound on the number of classes of the equivalence relation generated by Butterfly moves in \mathcal{P}_D . This section is rather independent from the others and can be read separately. For the reader's convenience, we briefly recall here the relevant definitions.

The set \mathcal{P}_D is the family of quadruples of integers (w, h, t, e) satisfying

$$(\mathcal{P}) \begin{cases} D = e^2 + 8wh, & 0 \leq t < \gcd(w, h), & 2h + e < w, \\ 0 < w, & 0 < h, & \gcd(w, h, t, e) = 1. \end{cases}$$

The elements of \mathcal{P}_D are called prototypes.

The Butterfly moves introduced in Section 7 define a map B_q that can be regarded as a transformation acting on a subset of \mathcal{P}_D . We recall the properties of B_q .

- (1) The Butterfly move B_q is defined (we will say *admissible*) for all prototypes $p \in \mathcal{P}_D$ satisfying $e + 4qh < \sqrt{D}$ (see Lemma 7.2).
- (2) If $B_q(w, h, t, e) = (w', h', t', e')$ then
 - (a) $\begin{cases} e' = -e - 4qh & \text{and } h' = \gcd(qh, w + qt), & \text{if } q \neq \infty \\ e' = -e - 4h & \text{and } h' = \gcd(h, t), & \text{if } q = \infty. \end{cases}$
 - (b) w' is determined by the relation $D = e^2 + 8wh = e'^2 + 8w'h'$.

See Figure 10 for examples of Butterfly move transformations.

Remark 8.1. *We do not have a formula for t' , but it is often possible to compute t' using the conditions $\gcd(w', h', t', e') = 1$ and $0 \leq t' < \gcd(w', h')$. In particular, if $\gcd(w', h') = 1$, then $t' = 0$.*

The maps B_q generate an equivalence relation \sim on \mathcal{P}_D : two prototypes are equivalent if one can pass from one prototype to the other one by a sequence of Butterfly moves. We will call an equivalence class of \sim a *component* of \mathcal{P}_D .

We can now state the main result of this section

Theorem 8.2. *Let $D > 16$ be a discriminant with $D \equiv 0, 1, 4 \pmod{8}$. Let us assume that*

$$D \notin \{41, 68, 100\}.$$

The set \mathcal{P}_D has only one component. The sets \mathcal{P}_{41} , \mathcal{P}_{68} and \mathcal{P}_{100} have exactly two components.

Remark 8.3. *It is straightforward to check that \mathcal{P}_D has two components for $D \in \{41, 68, 100\}$, see Section 9.2 for more details. We present in Figure 10 the action of Butterfly Moves on \mathcal{P}_{68} and \mathcal{P}_{100} .*

8.1. Reduced prototypes. When D is large, the set \mathcal{P}_D is very big so that it is not easy to work directly with \mathcal{P}_D . This problem is avoided by using reduced prototypes: We say that $p = (w, h, t, e) \in \mathcal{P}_D$ is *reduced* if $h = 1$ (in particular $t = 0$). There is no loss of generality since we have

Proposition 8.4. *Every prototype is equivalent to a reduced prototype.*

Proof. The proof parallels the one of Theorem 8.2 in McMullen [McM05a]. For the sake of completeness we briefly give the details here. Let $p = (w, h, t, e)$ that minimize the value of h in a given component. We claim that p is reduced. For that we will show that h divides w, t and e so that h divides $\gcd(w, h, t, e) = 1$ by definition of \mathcal{P}_D .

- Since $B_1(p) = (w', h', t', e')$ where $h' = \gcd(w, h) \geq h$ one has $h = h'$ divides w .
- Since $B_\infty(p) = (w', h', t', e')$ where $h' = \gcd(t, h) \geq h$ one has $t < h = h'$ and $t = 0$.

Let $B_1(p) = (w', h, t', -e - 4h)$. Now from the relation $e'^2 + 8w'h' = e^2 + 8wh$ one can deduce $w' = w - e - 2h$. But since h divides w and w' , h divides also e . The claim is then proven. \square

It will be useful to parametrize the set of reduced prototypes as follows:

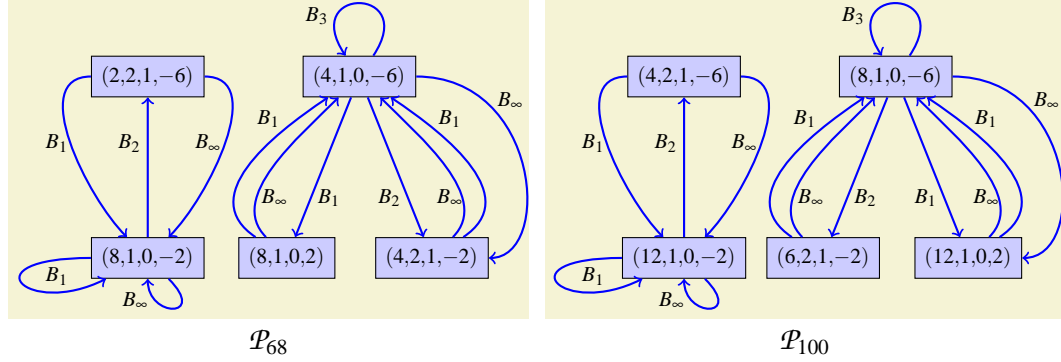

FIGURE 10. Action of Butterfly moves on the set of prototypes \mathcal{P}_D for $D = 68$ and $D = 100$.

Definition 8.5. Let $\mathcal{S}_D = \{e \in \mathbb{Z}, e^2 \equiv D \pmod{8}, e^2 \text{ and } (e+4)^2 < D\}$. Each element $e \in \mathcal{S}_D$ gives rise to a reduced prototype $[e] := (w, 1, 0, e) \in \mathcal{P}_D$, where $w = (D - e^2)/8$.

We equip \mathcal{S}_D with the relation $e \sim e'$ if $[e'] = B_q([e])$, for some $q \in \mathbb{N} \cup \{\infty\}$. Note that this condition implies that $e' = -e - 4q$, and $\gcd(w, q) = 1$, where $w = (D - e^2)/8$, when $q \in \mathbb{N} \setminus \{0\}$, and $e' = -e - 4$, when $q = \infty$. An equivalence class of the equivalence relation generated by this relation is called a *component* of \mathcal{S}_D . Clearly, if $e \sim e'$ in \mathcal{S}_D , then $[e]$ and $[e']$ are equivalent in \mathcal{P}_D . Note that the converse is not necessarily true, it can happen that $[e] \sim [e']$ in \mathcal{P}_D , but e and e' do not belong to the same equivalence class in \mathcal{S}_D . Theorem 8.2 follows mainly from the following

Theorem 8.6. Let $D > 16$ be a discriminant with $D \equiv 0, 1, 4 \pmod{8}$. Let us assume that

$$D \notin \{20, 36, 41, 73, 97, 112, 148, 196, 244, 292, 304, 436, 484, 676, 1684\}.$$

Then the set \mathcal{S}_D is non empty and has either

- two components: $\{e \in \mathcal{S}_D, e \equiv 2 \pmod{8}\}$ and $\{e \in \mathcal{S}_D, e \equiv -2 \pmod{8}\}$, if $D \equiv 4 \pmod{16}$, or
- only one component.

Remark 8.7. There is a simple congruence condition that explains why \mathcal{S}_D has (at least) two components when $D \equiv 4 \pmod{16}$. Indeed in that case if $e \sim f$ then $e \equiv f \pmod{8}$.

8.2. Exceptional cases. Our number-theoretic analysis of the connectedness of \mathcal{S}_D only applies when D is sufficiently large (e.g. $D \geq 83^2$). On one hand it is feasible to compute the number of components of \mathcal{S}_D when D is reasonably small. This reveals the 15 exceptional cases of Theorem 8.6, listed in Table 2. On the other hand, using computer assistance, one can easily prove the following

Lemma 8.8. Theorem 8.6 is true for all $D \leq 83^2 = 6889$.

8.3. Proof of Theorem 8.2.

We first show how Theorem 8.6 implies Theorem 8.2.

D	Components of \mathcal{S}_D	D	Components of \mathcal{S}_D	D	Components of \mathcal{S}_D
20	1	112	2	304	2
36	1	148	3	436	3
41	2	196	3	484	3
73	2	244	3	676	3
97	2	292	3	1684	3

TABLE 2. Exceptional cases of Theorem 8.6.

Proof of Theorem 8.2. Obviously when \mathcal{S}_D has only one component, there is nothing to prove. Thus we only need to consider the cases

$$\begin{cases} D > 16 & \text{and} & D \equiv 4 \pmod{16}, \\ D \in \{73, 97, 112, 148, 196, 244, 292, 304, 436, 484, 676, 1684\}. \end{cases}$$

We first examine the general case, and then the exceptional cases. Since for $D \leq 100$, Theorem 8.2 can be checked by hand, let us assume $D > 100$ and $D \equiv 4 \pmod{16}$. The idea is to connect the two components of \mathcal{S}_D by using non-reduced elements of \mathcal{P}_D . To be more precise one needs to connect $e \in \mathcal{S}_D$ to some $e' \in \mathcal{S}_D$ where $e \not\equiv e' \pmod{8}$, by using butterfly moves B_q , $q \in \mathbb{N} \cup \{\infty\}$ (compare with Remark 8.7).

(1) **First case:** $D = 4 + 16k$, k odd.

Since $D > 100$, we have $k \geq 7$. We start from the reduced prototype $(2k - 4, 1, 0, -6) \in \mathcal{P}_D$ or equivalently $e = -6 \in \mathcal{S}_D$. Observe that B_2 is admissible since $e + 4 \cdot 2 = 2 < \sqrt{16} < \sqrt{D}$. Applying the followings Butterfly moves: B_2 , B_∞ and B_1 in this order gives:

$$(2k - 4, 1, 0, -6) \xrightarrow{B_2} (k, 2, 0, -2) \xrightarrow{B_\infty} (k - 2, 2, 0, -6) \xrightarrow{B_1} (2k, 1, 0, -2).$$

Thus $[-6]$ and $[-2]$ are equivalent in \mathcal{P}_D , and $-6 \not\equiv -2 \pmod{8}$ as desired.

(2) **Second case:** $D = 4 + 32k$, k odd.

We have $k \geq 5$, since $D > 100$. This time we will start from the reduced prototype $(4k, 1, 0, 2) \in \mathcal{P}_D$ or equivalently $e = 2 \in \mathcal{S}_D$. We apply the followings Butterfly Moves: B_2 , B_2 and B_1 in this order. For the first move $q = 2$ is admissible since $e + 4 \cdot 2 = 10 < \sqrt{D}$. For the second move $q = 2$ is also admissible: $e + 4 \cdot 2 = -2 < \sqrt{D}$.

$$(4k, 1, 0, 2) \xrightarrow{B_2} (2k - 6, 2, 1, -10) \xrightarrow{B_2} (2k - 2, 2, 1, -6) \xrightarrow{B_1} (4k, 1, 0, -2).$$

Thus $[2]$ is connected to $[-2]$ in \mathcal{P}_D , and $2 \not\equiv -2 \pmod{8}$ as desired.

(3) **Third case:** $D = 4 + 32k$, k even.

We have $k \geq 4$. In this case, since $D \notin \{68, 100\}$, one has $D > 100$. This time we will start from the reduced prototype $(4k - 4, 1, 0, -6) \in \mathcal{P}_D$ or equivalently $e = -6 \in \mathcal{S}_D$. We apply the followings Butterfly moves: B_4 , B_∞ and B_1 in this order. The first move corresponding to $q = 4$ is admissible since $e + 4 \cdot 4 = 10 < \sqrt{D}$.

$$(4k - 4, 1, 0, -6) \xrightarrow{B_4} (k - 3, 4, 0, -10) \xrightarrow{B_\infty} (k - 1, 4, 0, -6) \xrightarrow{B_1} (4k - 12, 1, 0, -10)$$

Thus $[-6]$ is connected to $[-10]$ in \mathcal{P}_D , and $-6 \not\equiv -10 \pmod{8}$ as desired.

(4) **Exceptional cases:** $D \in \{73, 97, 112, 148, 196, 244, 292, 304, 436, 484, 676, 1684\}$.

The strategy is the same as above. We have collected the information into Table 3 in Appendix A page 43. We explain here the first line of this table.

D	Components of \mathcal{S}_D	Butterfly Moves
73	$\{1, -5\}$ and $\{-1, -3, 3, -7\}$	$[-5] \xrightarrow{B_3} (1, 3, 0, -7) \xrightarrow{B_\infty} (2, 3, 0, -5) \xrightarrow{B_1} [-7]$

The first two columns represent the discriminant $D = 73$ and the components of \mathcal{S}_{73} : a representative elements are *e.g.* $e = -5$ and $e = -7$. In the last column we encode the moves connecting the two corresponding reduced prototypes in \mathcal{P}_D . Hence, whereas \mathcal{S}_{73} has two components, \mathcal{P}_{73} has only one.

The proof of our theorem is now complete. \square

We can now turn into the proof of Theorem 8.6. To prove this theorem, we use almost the same ideas as the proof of Theorem 10.1 in [McM05a], and do not wish to claim any originality.

8.4. Small values of q . Surprisingly it is possible to show that Theorem 8.6 holds for most values of D only by using Butterfly moves B_q with small q , namely $q \in \{1, 2, 3, 5, 7\}$. If q is a prime number, we will use the following two operations

$$\begin{cases} F_q(e) &= e + 4(q-1), \\ F_{-q}(e) &= e - 4(q-1). \end{cases}$$

These two maps are useful to us, since we have

Proposition 8.9. *Let $e \in \mathcal{S}_D$, and assume that q is an odd prime.*

- (1) *If $F_q(e) \in \mathcal{S}_D$ and $D \not\equiv e^2 \pmod{q}$ then $e \sim F_q(e)$.*
- (2) *If $F_{-q}(e) \in \mathcal{S}_D$ and $D \not\equiv (e+4)^2 \pmod{q}$ then $e \sim F_{-q}(e)$.*

Proof. It suffices to remark that $[F_q(e)]$ (resp. $[F_{-q}(e)]$) is obtained from $[e]$ by the sequence of Butterfly moves (B_q, B_∞) (resp. (B_∞, B_q)), and the respective conditions ensure the admissibility of the corresponding sequence. \square

The next proposition guaranties that, under some rather mild assumptions, one has $e \sim F_3(e) = e + 8$.

Proposition 8.10. *Let $e \in \mathcal{S}_D$ and let us assume that $e - 24$ and $e + 32$ also belong to \mathcal{S}_D . Then one of the following two holds:*

- (1) *$e \sim e + 8$, or*
- (2) *(D, e) is congruent to $(4, -10)$ or $(4, -2)$ when reduced modulo $105 = 3 \cdot 5 \cdot 7$.*

Proof. We say that a sequence of integers (q_1, q_2, \dots, q_n) is a strategy for (D, e) if for any $i = 1, \dots, n-1$ the following holds:

$$\begin{cases} e_{i+1} = F_{q_i}(e_i) \in e + \{-24, -16, -8, 0, 8, 16, 24, 32\} \text{ (where } e_1 = e), \text{ and} \\ q_i \text{ is admissible for } (D, e_i), \\ e_n = e + 8. \end{cases}$$

For instance, if $(D, e) \equiv (0, 3) \pmod{105}$ then $(5, -3)$ is a strategy. Indeed letting $e = 3$ we see that $3 \sim F_5(3) = 19$ since 5 is admissible for $(D, 3)$. And $19 \sim F_{-3}(19) = 11 = 3 + 8$ since -3 is admissible for $(D, 19)$. Hence $3 \sim 3 + 8$.

Thus in order to prove the proposition we only need to give a strategy for every pair $(D, e) \pmod{105}$ with the two exceptions stated in the theorem. In fact each of the $105^2 - 2$ cases can be handled by one of the following 12 strategies.

- (1) There are 7350 pairs (D, e) for which $q = 3$ is admissible (i.e. $D \not\equiv e^2 \pmod{3}$). Since $F_3(e) = e + 8$ the sequence (3) is a strategy for all of these cases.
- (2) Among the $105^2 - 2 - 7350 = 3673$ remaining pairs, there are 1960 pairs (D, e) for which the sequence $(5, -3)$ is a common strategy.
- (3) We can continue in order to find strategies for all remaining pairs (D, e) but two: $(4, -10)$ and $(4, -2)$. We find respectively the strategies:

$$\begin{aligned} &(7, -5), (-3, 5), (-5, 7), \\ &(5, 3, -5), (-5, 3, 5), (5, 5, -7), (-7, 5, 5), (-3, 7, -3), \\ &(-5, 3, 7, -3), (-3, 7, 3, -5). \end{aligned}$$

Note that the conditions that $e - 24$ and $e + 32$ belong to S_D guaranty the admissibility of the strategies. This completes the proof of the proposition. \square

Remark 8.11. *Since for $(D, e) \equiv (4, -2) \pmod{105}$ one has $D \equiv (e + 4)^2 \pmod{105}$, even though one can enlarge the set of primes to be used in the strategies, there is no hope to get a similar conclusion to Proposition 8.10 without the second case.*

Remark 8.12. *A simple criterion to be not close to the ends of S_D is the following.*

$$\text{If } f \in S_D \text{ then for any } e > f, \quad (e + 36 < \sqrt{D}) \implies (e + 32 \in S_D).$$

Indeed $e + 32 \in S_D$ if and only if $(e + 32)^2 < D$ and $(e + 36)^2 < D$. Thus the claim is obvious if $e + 32 \geq 0$. Now if $e < -32$ then since $e > f$ the inequalities

$$0 > e + 32 > f + 32 > f \quad \text{and} \quad -(f + 4) > 4 > e + 36 > f + 36 > f + 4$$

implies

$$(e + 32)^2 < f^2 < D \quad \text{and} \quad (e + 36)^2 < (f + 4)^2 < D.$$

Let us define $\mathcal{T}_D = \{e \in S_D, e - 24 \text{ and } e + 32 \in S_D\}$. The next proposition asserts that if D is large then assumption of Proposition 8.10 actually holds.

Proposition 8.13. *If $D \geq 55^2$ then every element of S_D is equivalent to an element of \mathcal{T}_D .*

The proof will use the following theorem (the notations have been adapted to our situation)

Theorem (McMullen [McM05a] Theorem 9.1). *For any integer $w > 1$ there is an integer $q > 1$ relatively prime to w with*

$$1 < q < \frac{3 \log(w)}{\log(2)}.$$

Proof of Proposition 8.13. Let $f \in S_D$. Since $f \sim -f - 4$ we can assume $f \leq -2$. If $f > -6$ then the proposition is clearly true, therefore we only have to consider the case $f \leq -6$. Observe that if $f \leq -6$ then $(f + 32)^2 \leq (f - 20)^2$ and $(f + 36)^2 \leq (f - 24)^2$, hence $f - 24 \in S_D$ which implies $f + 32 \in S_D$. Assume that

$$(8) \quad f^2 < D \leq (f - 24)^2.$$

We will show that there always exists $e > f$ with $e \sim f$ and $e + 32 \in \mathcal{S}_D$, or equivalently $e + 36 < \sqrt{D}$ by Remark 8.12. If $e - 24 \notin \mathcal{S}_D$ then by definition, e satisfies the inequalities (8) and thus we can repeat the argument by replacing f by e .

Since $D \geq 55^2$ we have $f \leq 24 - 55 = -31$. Now assume that there exists some prime $q \leq 13$ such that $\gcd(w, q) = 1$. Then $f \sim F_q(f) > f$ and

$$F_q(f) + 36 = f + 4(q - 1) + 36 \leq -31 + 48 + 36 = 53 < 55 \leq \sqrt{D}.$$

Hence $e = F_q(f)$ is convenient.

Thus assume that w is divisible by all primes $p \leq 13$. Then $D \geq 8 \cdot w \geq 10^5$. Pick an integer q relatively prime to w such that

$$1 < q < \frac{3 \log(w)}{\log(2)} \leq 5 \log(D).$$

Now $f \sim F_q(f)$ where

$$f < F_q(f) = f + 4(q - 1) < 20 \cdot \log(D).$$

Since for $D \geq 10^5$, we have

$$F_q(f) + 36 < 20 \cdot \log(D) + 36 < \sqrt{D}.$$

This completes the proof of Proposition 8.13. \square

8.5. Case $D \equiv 4 \pmod{105}$. From Proposition 8.10, we know that, if $D \not\equiv 4 \pmod{105}$, then $e \sim e + 8$, whenever $e \in \mathcal{T}_D$, but if $D \equiv 4 \pmod{105}$, we do not have this property for all $e \in \mathcal{T}_D$, namely when $e \equiv -10, -2 \pmod{105}$. Assume that $D \equiv 4 \pmod{105}$, we define

$$\mathcal{U}_D = \{e \in \mathcal{T}_D, e \not\equiv -2 \pmod{105}\},$$

Lemma 8.14. *For $D > 83^2 = 6889$ all elements of \mathcal{S}_D are equivalent to an element of \mathcal{U}_D .*

Proof. Let $e \in \mathcal{S}_D$. Since $D > 83^2$, Proposition 8.13 implies that one can assume $e \in \mathcal{T}_D$. Let us assume $e \notin \mathcal{U}_D$, i.e. $e \equiv -2 \pmod{105}$, one can assume $e \leq -2$ since $e \sim -e - 4$. To prove the lemma, we need the following

Lemma 8.15. *For $D > 83^2$ there exists $q \not\equiv 1 \pmod{105}$ such that*

$$\gcd(w, q) = 1, \text{ and } 4q + 31 < \sqrt{D}.$$

Let us first complete the proof of Lemma 8.14. According to Lemma 8.15, we can pick some q such that

$$\gcd(w, q) = 1 \text{ and } F_q(e) + 36 = e + 4(q - 1) + 36 = e + 4q + 32 \leq 4q + 30 < \sqrt{D}$$

Thanks to Remark 8.12, we know that $F_q(e) + 36 < \sqrt{D}$ implies $F_q(e) + 32 \in \mathcal{S}_D$. Consequently $F_q(e) \in \mathcal{T}_D$. Since $F_q(e) - e \equiv 4(q - 1) \not\equiv 0 \pmod{105}$ we have $F_q(e) \not\equiv -2 \pmod{105}$ i.e. $F_q(e) \in \mathcal{U}_D$. We conclude by noting that $\gcd(w, q) = 1$, which implies $e \sim F_q(e)$. Lemma 8.14 is now proven. \square

To complete the proof of our statement, it remains to show

Proof of Lemma 8.15. One has to show that

$$(9) \quad \begin{cases} \gcd(w, q) = 1, \\ q \not\equiv 1 \pmod{105}, \\ 4q + 31 < \sqrt{D}. \end{cases}$$

Since $D > 83^2$ the last two conditions of (9) are automatic for $q = 2, 3, 5, 7, 11$ and 13 . Thus one can assume w is divisible by $30030 = 2 \cdot 3 \cdot 5 \cdot 7 \cdot 11 \cdot 13$. But in this case $\sqrt{D} = \sqrt{e^2 + 8 \cdot w \cdot h} > 490$.

Again, the last two conditions are fulfilled for all primes less than 114; thus the claim is proven unless w is divisible by all of these 30 primes, in which case we have $w \geq 10^{46}$.

To find a good q satisfying the first condition of (9), we will use the Jacobsthal's function $J(n)$, that is defined to be largest gap between consecutive integers relatively prime to n (e.g. $J(10) = 7 - 3 = 4$). A convenient estimate for $J(n)$ is provided by Kanold [Kan67]: If none of the first k primes divide n , then one has $J(n) \leq n^{\log(2)/\log(p_{k+1})}$ where p_{k+1} is the $(k+1)$ th prime.

We will also use the following inequality that can be found in [McM05a] (Theorem 9.4): For any $a, w, n \geq 1$ with $\gcd(a, n) = 1$ there is a positive integer $q \leq nJ(w//n)$ such that

$$q \equiv a \pmod{n} \text{ and } \gcd(q, w) = 1,$$

where $w//n$ is obtained by removing from w all primes that divide n .

Applying the above inequality with $a = 13$ and $n = 210$, one can find a positive integer q satisfying

$$q \leq 210J(w//210),$$

with $\gcd(w, q) = 1$ and $q \equiv 13 \pmod{210}$. In particular $q \not\equiv 1 \pmod{105}$ and thus the first two conditions of (9) are satisfied. Let us see for the last condition.

Since the first prime p_{k+1} that divide $w//210$ is at least 13, Kanold's estimates gives

$$J(w//210) \leq (w//210)^{\log(2)/\log(p_{k+1})} \leq (w//210)^{1/3} \leq w^{1/3}.$$

Hence

$$4 \cdot q + 31 \leq 4 \cdot 210 \cdot w^{1/3} + 31.$$

But since $w > 10^{46}$ we have:

$$4 \cdot 210 \cdot w^{1/3} + 31 \leq w^{1/2} \leq \sqrt{D}.$$

The lemma is proven. □

8.6. Proof of Theorem 8.6. One can assume that $D \geq 83^2$, since by Lemma 8.8 the theorem is true for $D < 83^2$.

8.6.1. *Case $D \not\equiv 4 \pmod{105}$.*

Proof. Thanks to Proposition 8.13, every component of \mathcal{S}_D meets \mathcal{T}_D . Since $D = e^2 + 8w$ the possible values of D modulo 8 are

$$D \equiv 0, 1, 4 \pmod{8}.$$

We will examine each case separately.

Case one: $D \equiv 0 \pmod{8}$. Let us consider the partition $\mathcal{T}_D = \mathcal{T}_D^0 \sqcup \mathcal{T}_D^1$ where

$$\mathcal{T}_D^i = \{e \in \mathcal{T}_D, e \equiv 4i \pmod{8}\}.$$

By Proposition 8.10 we have $e \sim e + 8$ whenever e and $e + 8$ are both in \mathcal{T}_D . Therefore all elements of \mathcal{T}_D^0 are equivalent, as are all elements of \mathcal{T}_D^1 . Thus Proposition 8.13 implies \mathcal{S}_D has at most two components. But $B_1(0) \sim 0 - 4 \times 1 = -4$ thus $0 \in \mathcal{T}_D^0$ is connected to $-4 \in \mathcal{T}_D^1$.

Case two: $D \equiv 4 \pmod{8}$. Let us consider the partition $\mathcal{T}_D = \mathcal{T}_D^0 \sqcup \mathcal{T}_D^1$ where

$$\mathcal{T}_D^i = \{e \in \mathcal{T}_D, e \equiv 6 + 4i \pmod{8}\}.$$

Again Propositions 8.10 and 8.13 imply \mathcal{S}_D has at most two components. There are two sub-cases: $D \equiv 4$ or $12 \pmod{16}$. In the first case there are actually two components (see Remark 8.7). So assume $D \equiv 12 \pmod{16}$. Then $2 \in \mathcal{T}_D^1$ and since $w = (D - 2^2)/8$ is odd, one has $B_2(2) \sim -2 - 4 \times 8 = -10$. Hence we have connected $2 \in \mathcal{T}_D^1$ to $-10 \in \mathcal{T}_D^0$.

Case three: $D \equiv 1 \pmod{8}$. Let us consider the partition $\mathcal{T}_D = \mathcal{T}_D^0 \sqcup \mathcal{T}_D^1 \sqcup \mathcal{T}_D^2 \sqcup \mathcal{T}_D^3$ where

$$\mathcal{T}_D^i = \{e \in \mathcal{T}_D, e \equiv 1 + 2i \pmod{8}\}.$$

Again Propositions 8.10 and 8.13 imply \mathcal{S}_D has at most four components. We will connect each of these sets by specific butterfly moves. First observe that $B_1(1) \sim -1 - 4 \times 1 = -5 \in \mathcal{T}_D^1$. This shows that \mathcal{T}_D^0 is connected to \mathcal{T}_D^1 .

The same argument shows $B_1(5) \sim -5 - 4 \times 1 = -9 \in \mathcal{T}_D^3$. Thus \mathcal{T}_D^2 is connected to \mathcal{T}_D^3 .

We need now to connect $\mathcal{T}_D^0 \cup \mathcal{T}_D^1$ with $\mathcal{T}_D^2 \cup \mathcal{T}_D^3$. We have two cases

- If $D \equiv 9 \pmod{16}$ then for $e = 1$, one has $w = (D - 1^2)/8$ is odd. Thus $\gcd(w, q) = 1$ for $q = 2$ and $B_2(1) = -1 - 4 \times 2 = -9$. This connects \mathcal{T}_D^0 to \mathcal{T}_D^3 .
- If $D \equiv 1 \pmod{16}$ then for $e = 3$ one has $w = (D - 3^2)/8$ is odd. Thus $\gcd(w, q) = 1$ for $q = 2$ and $B_2(3) = -3 - 4 \times 2 = -11$. This connects \mathcal{T}_D^1 to \mathcal{T}_D^2 .

This finishes the proof of Theorem 8.6 in the case $D \not\equiv 4 \pmod{105}$.

□

8.6.2. Case $D \equiv 4 \pmod{105}$.

Proof. Recall that in this case we have defined $\mathcal{U}_D := \{e \in \mathcal{T}_D, e \not\equiv -2 \pmod{105}\}$. We define the sets \mathcal{T}_D^i in the same way as the previous case, namely

$$\begin{aligned} \mathcal{T}_D^i &= \{e \in \mathcal{T}_D, e \equiv 4i \pmod{8}\} & i = 0, 1, & \text{if } D \equiv 0 \pmod{8}, \\ \mathcal{T}_D^i &= \{e \in \mathcal{T}_D, e \equiv 6 + 4i \pmod{8}\} & i = 0, 1, & \text{if } D \equiv 4 \pmod{8}, \\ \mathcal{T}_D^i &= \{e \in \mathcal{T}_D, e \equiv 1 + 2i \pmod{8}\} & i = 0, 1, 2, 3, & \text{if } D \equiv 1 \pmod{8}. \end{aligned}$$

and consider the partition of \mathcal{U}_D by $\mathcal{U}_D^i = \mathcal{U}_D \cap \mathcal{T}_D^i$.

Lemma 8.16. *All elements of \mathcal{U}_D^i are equivalent in \mathcal{S}_D .*

Proof of the lemma. We will apply Proposition 8.10. Since $D \equiv 4 \pmod{105}$ and $e \not\equiv -2 \pmod{105}$, if we can not conclude directly that $e \sim e + 8$ then this means that $e \equiv -10 \pmod{105}$. But in this case, since

$$e^2 \equiv 0 \not\equiv D \equiv 1 \pmod{5}$$

one can apply the move F_q with $q = 5$. This gives $e \sim F_5(e) = e + 16$. This proves the lemma. \square

By Lemma 8.14 and Lemma 8.16, we only need to connect elements in \mathcal{U}_D^i , with different i . Actually, we can use the same strategies as the case $D \not\equiv 4 \pmod{105}$ since they do not involve any element $e \in \mathcal{T}_D^i$ such that $e \equiv -2 \pmod{105}$. This completes the proof of Theorem 8.6. \square

9. COMPONENTS OF THE PRYM EIGENFORMS LOCUS

In this section, we give the proof of our main result (Theorem 2.8) announced in Section 2. Since the fact that the Prym eigenform loci of different discriminants are disjoint follows from Theorem 5.1 (see Corollary 5.2), it remains to show that $\Omega E_D(4)$ has one component when $D \equiv 0, 4 \pmod{8}$, and two components when $D \equiv 1 \pmod{8}$.

By Theorem 4.1 and Theorem 8.2, when $D \notin \{41, 68, 100\}$, we have

$$\# \{\text{Components of } \Omega E_D(4)\} \leq \# (Q_D / \sim) \leq 2 \cdot \# (P_D / \sim) = 2.$$

When D is odd, by Theorem 6.1, we know that $\Omega E_D(4)$ has at least two $\text{GL}^+(2, \mathbb{R})$ -orbits, therefore Theorem 2.8 is proven for $D \equiv 1 \pmod{8}$, and $D \neq 41$.

Remark 9.1. *There exists a simple congruence relation that explains why it is not possible to connect $(p, +)$ to $(p, -)$ by Butterfly moves B_q , $q \in \mathbb{N} \cup \{\infty\}$ when D is odd. Indeed, if it is the case, then we would have a sequence of Butterfly moves in \mathcal{P}_D connecting p to itself by an odd number of steps. But this is impossible since $e \equiv \pm 1 \pmod{4}$ (since $D = e^2 + 8wh$), and a Butterfly move sends e to $e' = -e - 4qh \equiv -e \not\equiv e \pmod{4}$.*

For the remaining cases, Theorem 2.8 follows from

Theorem 9.2 (Generic even discriminants). *Let $D > 16$ be an even discriminant with $D \equiv 0, 4 \pmod{8}$. If $D \notin \{48, 68, 100\}$ then Q_D has only one component.*

and

Theorem 9.3 (Exceptional discriminants).

- (1) $\Omega E_{48}(4)$, $\Omega E_{68}(4)$ and $\Omega E_{100}(4)$ consist of a single $\text{GL}^+(2, \mathbb{R})$ -orbit;
- (2) $\Omega E_{41}(4)$ consists of two $\text{GL}^+(2, \mathbb{R})$ -orbits.

9.1. **Proof of Theorem 9.2.** We will show that there exists $e \in \mathcal{S}_D$ which can be connected to itself by a sequence of 1 or 3 Butterfly moves. Consider four different cases.

- (1) $D \equiv 4 \pmod{8}$ and $D \notin \{68, 100\}$. Then $-2 \in \mathcal{S}_D$ and $B_1(-2) = -2$. Since \mathcal{P}_D has only one component, so is Q_D , and we are done.
- (2) $D = 8 + 16k$, $k \geq 1$. Then $-4 \in \mathcal{S}_D$. Note that $[-4] = (2k - 1, 1, 0, -4)$. Since $e + 4 \cdot 2 = 4 < \sqrt{D}$, $q = 2$ is admissible, and $B_2(-4) = -4$.
- (3) $D = 32k$. Then $-4 \in \mathcal{S}_D$, we have $[-4] = (4k - 2, 1, 0, -4)$. Since $e + 4 \cdot 2 = 4 < \sqrt{D}$, $q = 2$ is admissible, and

$$(4k - 2, 1, 0, -4) \xrightarrow{B_2} (2k - 1, 2, 0, -4) \xrightarrow{B_\infty} (2k - 1, 2, 0, -4) \xrightarrow{B_1} (4k - 2, 1, 0, -4)$$

is a sequence of three Butterfly moves connecting -4 to itself.

- (4) $D = 16 + 32k$ and $k > 1$. Since $k \geq 2$, $-8 \in \mathcal{S}_D$ and $[-8] = (4k - 6, 1, 0, -8)$. This time we use the sequence

$$(4k - 6, 1, 0, -8) \xrightarrow{B_2} (2k + 1, 2, 0, 0) \xrightarrow{B_\infty} (2k - 3, 2, 0, -8) \xrightarrow{B_2} (4k - 6, 1, 0, -8)$$

to connect -8 to itself with three steps. Observe that $q = 2$ is admissible in both cases. \square

9.2. Proof of Theorem 9.3.

9.2.1. $D = 100$. Since $D = 100 = 10^2$ the surfaces in $\Omega E_{100}(4)$ are arithmetic surfaces (square-tiled surfaces). The set Q_D has exactly two components, represented by the complete prototypes $(12, 1, 0, -2, +)$ and $(12, 1, 0, 2, +)$ (see also Figure 10 page 31 for the action of Butterfly Moves on \mathcal{P}_{100}). Let Σ_{-2} and Σ_2 be the surface constructed from the prototypes $(12, 1, 0, -2, +)$ and $(12, 1, 0, 2, +)$, respectively. Observe that normalizing by $\mathrm{GL}^+(2, \mathbb{Q})$, Σ_{-2} and Σ_2 are square-tiled surfaces, made of 10 squares.

It turns out there are exactly 135 square-tiled surfaces (made of 10 squares) in $\Omega \mathcal{M}(4)$ and they all belong to the same Teichmüller curve. To be more precise, if we denote by $L = \begin{pmatrix} 1 & 1 \\ 0 & 1 \end{pmatrix}$ and $R = \begin{pmatrix} 1 & 0 \\ 1 & 1 \end{pmatrix}$ the standard generators of $\mathrm{SL}(2, \mathbb{Z})$, then

$$R^2 \cdot (R \cdot L)^3 \cdot \Sigma_{-2} = \Sigma_2.$$

This shows that $\Omega E_{100}(4)$ is connected.

9.2.2. $D = 48$. In this case

$$Q_{48} = \{(2, 2, 1, -4, \pm), (4, 1, 0, -4, \pm), (6, 1, 0, 0, \pm)\}.$$

The Butterfly moves connect all the incomplete prototypes, that is \mathcal{P}_{48} has only one component (see Figure 11), but Q_{48} has two components since none of prototypes in \mathcal{P}_{48} can be connected to itself by an odd number of Butterfly moves.

We label the components of Q_{48} as follows:

$$\begin{aligned} Q_{48}^1 &= \{(2, 2, 1, -4, +), (4, 1, 0, -4, -), (6, 1, 0, 0, +)\}, \\ Q_{48}^2 &= \{(2, 2, 1, -4, -), (4, 1, 0, -4, +), (6, 1, 0, 0, -)\} \end{aligned}$$

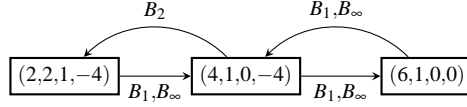
FIGURE 11. Action of the Butterfly moves on \mathcal{P}_{48} .

We will show that there is actually only one $\mathrm{GL}^+(2, \mathbb{R})$ -orbit in $\Omega E_{48}(4)$. To see this we pick a prototype for Model B , that is, a quadruplet (w, h, t, e) of integers satisfying Property (\mathcal{P}') , and show that the surface constructed from this prototype admits two decompositions, one corresponds to a prototype in Q_{48}^1 , and the other corresponds to a prototype in Q_{48}^2 . Note that, for $D = 48$ there are 4 solutions to (\mathcal{P}') , listed below

$$S'_{48} = \{(3, 2, 0, 0), (4, 1, 0, 4), (2, 3, 0, 0), (1, 4, 0, -4)\}.$$

Let Σ be the surface constructed from the prototype $(3, 2, 0, 0)$ following Model B (see Figure 12). We have $\lambda = \frac{e + \sqrt{D}}{2} = \frac{\sqrt{48}}{2} = 2\sqrt{3}$. The surface Σ admits decompositions following Model A — in the directions $v_1 = (\lambda/2, h + \lambda/2)$, and $v_2 = (w, -h - \lambda/2)$. Direct computations show that the decomposition in the direction v_1 corresponds to the prototype $(6, 1, 0, 0, -) \in Q_{48}^2$, while the decomposition in direction v_2 corresponds to the prototype $(4, 1, 0, -4, -) \in Q_{48}^1$. Remark that in this case, to determine the corresponding prototypes, it suffices to compute the ratio of the heights of the cylinders in directions v_1, v_2 .

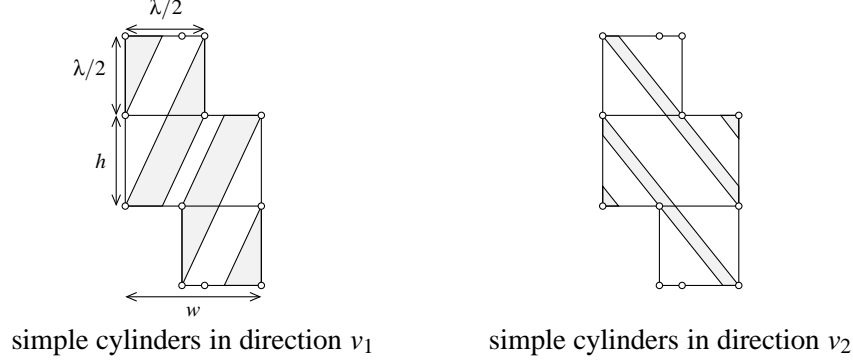
FIGURE 12. Two periodic directions corresponding to two prototypes in Q_{48}^1 and Q_{48}^2 on the surface constructed from the prototype $(3, 2, 0, 0)$.

9.2.3. $D = 68$. Q_{68} has two components

$$\begin{aligned} Q_{68}^1 &= \{(2, 1, 2, -6, \pm), (8, 0, 1, -2, \pm)\}, \\ Q_{68}^2 &= \{(4, 0, 1, -6, \pm), (8, 0, 1, 2, \pm), (4, 1, 2, -2, \pm)\} \end{aligned}$$

The strategy is the same: we connect the two components of Q_{68} using two directions on a surface obtained with Model B . We have

$$\mathcal{S}'_{68} = \{(4, 1, 2, 2), (1, 0, 4, -6), (4, 0, 1, 6), (2, 1, 4, -2)\}.$$

Let Σ be the surface constructed from the prototype $(4, 2, 1, 2)$ of Model B . We have $\lambda = 1 + \sqrt{17}$. This surface admits decompositions into cylinders in directions $v_1 = (t, h + \lambda/2)$, and $v_2 = (t + \lambda/2, h + \lambda/2)$. Direct computations show that the prototype corresponding to the decomposition in direction v_1 is $(8, 1, 0, -2, -) \in Q_{68}^1$, and the prototype corresponding to the decomposition in direction v_2 is $(8, 1, 0, 2, -) \in Q_{68}^2$ (see Figure 13 for details).

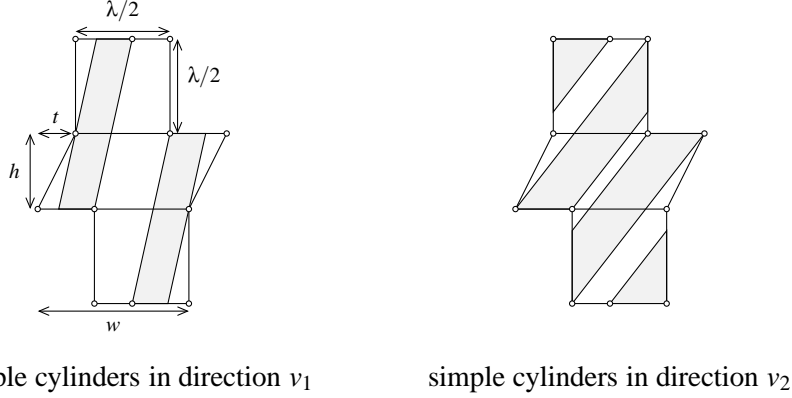

FIGURE 13. Surface constructed from the prototype $(4, 2, 1, 2)$: two periodic directions corresponding to prototypes in Q_{68}^1 and Q_{68}^2 .

9.2.4. $D = 41$. In this case, the Butterfly Moves do not connect all the incomplete prototypes in \mathcal{P}_{41} , therefore $Q_{41}(4)$ has four components:

$$\begin{aligned} Q_{41}^1 &= \{(2, 2, 0, -3, +), (1, 2, 0, -5, -), (4, 1, 0, -3, +), (5, 1, 0, -1, -)\}, \\ Q_{41}^2 &= \{(2, 1, 0, -5, -), (5, 1, 0, 1, +), (2, 2, 1, -3, +)\}, \\ Q_{41}^3 &= \{(2, 2, 0, -3, -), (1, 2, 0, -5, +), (4, 1, 0, -3, -), (5, 1, 0, -1, +)\}, \\ Q_{41}^4 &= \{(2, 1, 0, -5, +), (5, 1, 0, 1, -), (2, 2, 1, -3, -)\}. \end{aligned}$$

We have shown that when D is odd, there are at least two $\mathrm{GL}^+(2, \mathbb{R})$ -orbits in $\Omega E_D(4)$. We will show that there are exactly two $\mathrm{GL}^+(2, \mathbb{R})$ -orbits in $\Omega E_{41}(4)$. Let Σ_1 be the surface constructed from the prototype $(4, 1, 0, 3)$ of Model B . We have $\lambda = \frac{3 + \sqrt{41}}{2}$. This surface admits decompositions into cylinders in directions $v_1 = (\lambda, -\lambda - h)$, and $v_2 = (w + \lambda/2, -\lambda/2 - h)$. The decomposition in direction v_1 corresponds to the prototype $(4, 1, 0, -3, +) \in Q_{41}^1$, and the decomposition in direction v_2 corresponds to the prototype $(2, 1, 0, -5, -) \in Q_{41}^2$. Therefore, the prototypes in Q_{41}^1 and Q_{41}^2 give rise to the same $\mathrm{GL}^+(2, \mathbb{R})$ -orbit (see Figure 14 for details).

Let Σ_2 be the surface constructed from the prototype $(1, 4, 0, -3)$ of Model B . We have $\lambda = \frac{-3 + \sqrt{41}}{2}$. This surface admits decompositions into cylinders in directions $v_1 = (w, -h - \lambda/2)$, and $v_2 = (3w, h + \lambda)$. The decomposition in direction v_1 corresponds to the prototype $(4, 1, 0, -3, -) \in Q_{41}^3$, and the decomposition in direction v_2 corresponds to the prototype $(2, 1, 0, -5, +) \in Q_{41}^4$. Therefore the prototypes in

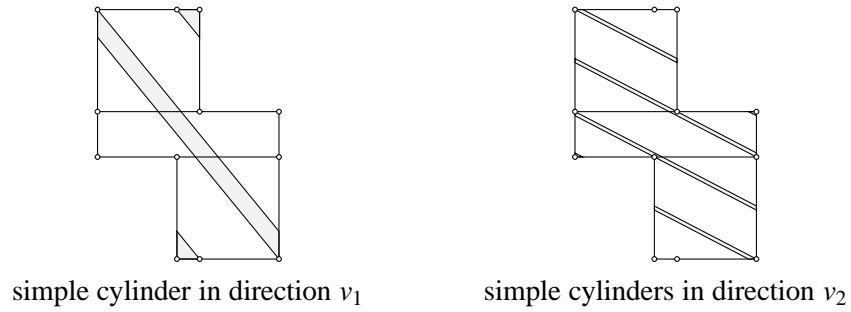

FIGURE 14. Surface constructed from the prototype $(4, 1, 0, 3)$: two periodic directions corresponding to prototypes in Q_{41}^1 and Q_{41}^2 .

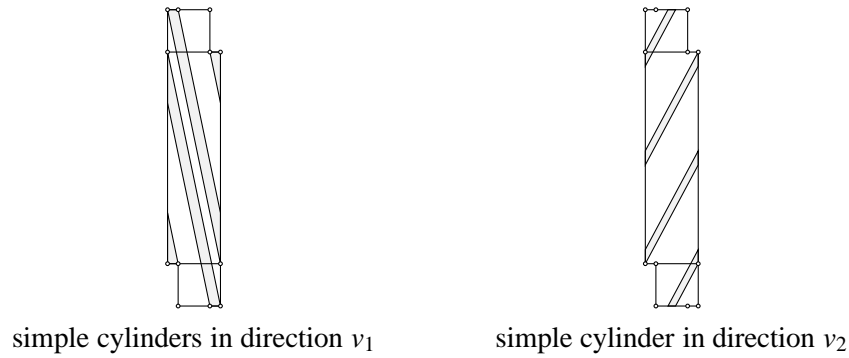

FIGURE 15. Surface constructed from the prototype $(1, 4, 0, -3)$: two periodic directions corresponding to prototypes in Q_{41}^3 and Q_{41}^4 .

Q_{41}^3 and Q_{41}^4 give rise to the same $GL^+(2, \mathbb{R})$ -orbit. We can then conclude that $\Omega E_{41}(4)$ consists of two $GL^+(2, \mathbb{R})$ -orbits (see Figure 15 for details). The proof of Theorem 9.3 is now complete. Theorem 2.8 is then proven \square

APPENDIX A. EXCEPTIONAL CASES IN THEOREM 8.2

The table below encodes the strategies that connect the different orbits in the proof of Theorem 8.2 for exceptional cases: $D \in \{73, 97, 112, 148, 196, 244, 292, 304, 436, 484, 676, 1684\}$. See page 33 for an explain of this table.

D	Components of \mathcal{S}_D	Butterfly Moves
73	$\{1, -5\}$ and $\{-1, -3, 3, -7\}$	$[-5] \xrightarrow{B_3} (1, 3, 0, -7) \xrightarrow{B_\infty} (2, 3, 0, -5) \xrightarrow{B_1} [-7]$
97	$\{-7, 3\}$ and $\{-9, -5, -3, -1, 1, 5\}$	$[-7] \xrightarrow{B_4} (1, 2, 0, -9) \xrightarrow{B_1} [1]$
112	$\{-8, 4\}$ and $\{-4, 0\}$	$[0] \xrightarrow{B_2} (3, 2, 0, -8) \xrightarrow{B_2} [-8]$
148	$\{-2\}$, $\{-6, 2\}$ and $\{-10, 6\}$	$[-2] \xrightarrow{B_2} (7, 2, 0, -6) \xrightarrow{B_2} [-10]$ $[-6] \xrightarrow{B_4} (3, 2, 0, -10) \xrightarrow{B_\infty} (9, 2, 0, 2) \xrightarrow{B_1} [-10]$
196	$\{-2\}$, $\{-6, 2\}$ and $\{-10, 6\}$	$[-2] \xrightarrow{B_3} (4, 3, 0, -10) \xrightarrow{B_\infty} (8, 3, 0, -2) \xrightarrow{B_1} [-10]$ $[-6] \xrightarrow{B_4} (3, 4, 0, -10) \xrightarrow{B_\infty} (5, 4, 0, -6) \xrightarrow{B_1} [-10]$
244	$\{-2\}$, $\{-14, -6, 2, 10\}$ and $\{-10, 6\}$	$[-2] \xrightarrow{B_\infty} (13, 2, 0, -6) \xrightarrow{B_1} [-14]$ $[6] \xrightarrow{B_3} (3, 2, 0, -14) \xrightarrow{B_2} [-2]$
292	$\{-2\}$, $\{-14, -6, 2, 10\}$ and $\{-10, 6\}$	$[2] \xrightarrow{B_2} (12, 2, 1, -10) \xrightarrow{B_2} (16, 2, 1, -6) \xrightarrow{B_1} [-2]$ $[-6] \xrightarrow{B_2} (6, 2, 1, -14) \xrightarrow{B_2} (9, 4, 0, -2) \xrightarrow{B_1} [-14]$
304	$\{-5, 4\}$ and $\{-16, -12, -4, 0, 8, 12\}$	$4 \xrightarrow{B_3} (2, 3, 0, -16) \xrightarrow{B_2} (15, 2, 0, -8) \xrightarrow{B_1} 0$
436	$\{-18, -10, -2, 6, 14\}$, $\{-6, 2\}$, and $\{-14, 10\}$	$[-6] \xrightarrow{B_4} (21, 2, 0, -10) \xrightarrow{B_\infty} (27, 2, 0, 2) \xrightarrow{B_1} [-10]$ $[-6] \xrightarrow{B_2} (27, 2, 0, -2) \xrightarrow{B_2} [-14]$
484	$\{-2\}$, $\{-14, -6, 2, 10\}$, and $\{-18, -10, 6, 14\}$	$[2] \xrightarrow{B_2} (24, 2, 1, -10) \xrightarrow{B_2} (28, 2, 1, -6) \xrightarrow{B_1} [-2]$ $[-6] \xrightarrow{B_2} (30, 2, 1, -2) \xrightarrow{B_2} (9, 4, 0, -14) \xrightarrow{B_1} [-2]$
676	$\{-18, -10, -2, 6, 14\}$, $\{-14, 10\}$, and $\{-22, -6, 2, 18\}$	$[2] \xrightarrow{B_2} (36, 2, 1, -10) \xrightarrow{B_2} (40, 2, 1, -6) \xrightarrow{B_1} [-2]$ $[-6] \xrightarrow{B_2} (42, 2, 1, -2) \xrightarrow{B_2} (15, 4, 0, -14) \xrightarrow{B_1} [-2]$
1684	$\{-2\}$, $\{-34, -26, -18, -10, 6, 14, 22, 30\}$, and $\{-38, -34, -30, -22, -14, -6, 2, 10, 18, 26, 34\}$	$[-6] \xrightarrow{B_2} (105, 2, 0, -2) \xrightarrow{B_\infty} (103, 2, 0, -6) \xrightarrow{B_1} [-2]$ $[-6] \xrightarrow{B_2} (105, 2, 0, -2) \xrightarrow{B_\infty} (103, 2, 0, -6) \xrightarrow{B_2} [-10]$

TABLE 3. Connecting components of \mathcal{S}_D through \mathcal{P}_D for exceptional cases of Theorem 8.6. Recall that for $e \in \mathcal{S}_D$ we define an incomplete prototype $[e] = (w, 1, 0, e) \in \mathcal{P}_D$, where $w = (D^2 - e^2)/8$.

APPENDIX B. SQUARE-TILED SURFACES

A square-tiled surface is a form (X, ω) such that $\omega(\gamma) \in \mathbb{Z}^2$ for any $\gamma \in H_1(X, \mathbb{Z})$. For such a surface, integration of the form ω gives a holomorphic map $X \rightarrow \mathbb{C}/\mathbb{Z}^2$ which can be normalized so it is branched only the origin. The n preimages of the square $[0, 1]^2$ provide a tiling of the surface X . We say that (X, ω) is primitive if $\{\omega(\gamma), \gamma \in H_1(X, \mathbb{Z})\} = \mathbb{Z}^2$. Observe that a surface $(X, \omega) \in \Omega E_D(4)$ is square-tiled if and only if $D = d^2$ is a square. The following elementary proposition relates d and n .

Proposition B.1. *Let $(X, \omega) \in \Omega E_{d^2}(4)$ be a Prym eigenform. Assume that (X, ω) is a primitive square-tiled surface made of n squares, then*

- (1) $n = d$, if d is even;
- (2) $n = d$ or $n = 2d$ depending on the $\mathrm{GL}^+(2, \mathbb{R})$ -orbit of (X, ω) , if d is odd.

Theorem 1.1 allows us to get properties for the topology of the branched covers:

Corollary B.2. *Fix $n \geq 5$. If $n \equiv 2 \pmod{4}$ then there are exactly two $\mathrm{GL}^+(2, \mathbb{R})$ -orbits of degree n , primitive square-tiled surfaces which are Prym eigenforms in $\Omega\mathfrak{M}(4)$, otherwise there is only one $\mathrm{GL}^+(2, \mathbb{R})$ -orbit.*

Proof. From Proposition B.1 and Theorem 1.1, the only possibility to get two $\mathrm{GL}^+(2, \mathbb{R})$ -orbits of square-tiled surfaces made of n squares is given when n is even, and $n/2$ is odd, i.e. $n \equiv 2 \pmod{4}$. \square

APPENDIX C. CUSPS OF THE TEICHMÜLLER CURVES IN GENUS 3

The projection of the $\mathrm{GL}^+(2, \mathbb{R})$ -orbit of a Veech surface (X, ω) into the moduli space \mathfrak{M}_g of Riemann surfaces is a Teichmüller curve. Let $\mathrm{SL}(X, \omega)$ denote the Veech group of (X, ω) which is a lattice of $\mathrm{SL}(2, \mathbb{R})$. A Teichmüller curve can never be compact, since any periodic direction of (X, ω) gives rise to a cusp, each cusp corresponds to the $\mathrm{SL}(X, \omega)$ -orbits of a periodic direction of (X, ω) .

Let $W_D(4)$ denote the projection of $\Omega E_D(4)$ into \mathfrak{M}_3 . By Theorem 2.8, we know that $W_D(4)$ is either a single Teichmüller curve, or the union of two Teichmüller curves. In both cases, we denote by $C(W_D(4))$ the total number of cusps in W_D , and by $C^{(k)}(W_D(4))$, $k = 1, 2, 3$, the number of cusps corresponding to decompositions into k cylinders. Recall that each decomposition into three cylinders is characterized by a prototype in Q_D , or in \mathcal{P}'_D up to the action of $\mathrm{GL}^+(2, \mathbb{R})$, and clearly, if two cylinder decompositions correspond to the same prototype then they are related by an element of $\mathrm{SL}(X, \omega)$. It follows that we have a bijection from the set of prototypes $(Q_D \cup \mathcal{P}'_D)$ and the set of cusps corresponding to decompositions into three cylinders.

If D is not a square, since (X, ω) does not admit any decomposition into one or two cylinders, we have

$$C(W_D(4)) = C^{(3)}(W_D(4)) = |Q_D| + |\mathcal{P}'_D| = 2|\mathcal{P}_D| + |\mathcal{P}'_D|.$$

When $D = d^2$, $d \in \mathbb{N}$, the curve(s) in $W_D(4)$ has cusps corresponding to decompositions into one or two cylinders. It turns out that one can characterize the decompositions into one or two cylinders in a similar manner to the decompositions into three cylinders, and therefore we can associate to each of such decompositions a prototype.

Theorem C.1. *Let us define*

$$\mathcal{P}_D^s := \{(p, q) \in \mathbb{N}^2; 0 < q < p < d/2 \quad \text{and} \quad \gcd(p, q, d) = 1\}.$$

Then $C^{(1)}(W_D(4)) = C^{(2)}(W_D(4)) = |\mathcal{P}_D^s|$. In particular:

$$C(W_D(4)) = 2|\mathcal{P}_D| + |\mathcal{P}'_D| + 2|\mathcal{P}_D^s|.$$

To prove Theorem C.1 we introduce the prototype for cylinder decompositions into 1 and 2 cylinders:

Proposition C.2. *Let (X, ω) be a surface in $\Omega E_{d^2}(4)$ for which the horizontal direction is completely periodic.*

(1) Suppose that (X, ω) has only one cylinder in the horizontal direction.

Let $\alpha_1, \beta_1, \alpha_{2,1}, \beta_{2,1}, \alpha_{2,2}, \beta_{2,2}$ be as in Figure 16. Set $\alpha_2 = \alpha_{2,1} + \alpha_{2,2}, \beta_2 = \beta_{2,1} + \beta_{2,2}$. Observe that $(\alpha_1, \beta_1, \alpha_2, \beta_2)$ is a symplectic basis for $H_1(X, \mathbb{Z})^-$. Then there exists a unique generator T of \mathcal{O}_D such that $T^*(\omega) = \lambda(T) \cdot \omega$, with $\lambda(T) > 0$, and T is written in the basis $(\alpha_1, \beta_1, \alpha_2, \beta_2)$ by the matrix $\begin{pmatrix} e & 0 & 2p & 2q \\ 0 & e & 0 & 2s \\ s & -q & 0 & 0 \\ 0 & p & 0 & 0 \end{pmatrix}$, where $(e, p, q, s) \in \mathbb{Z}^4$ satisfies

$$(\mathcal{P}_D^s) \begin{cases} e + 4p = \sqrt{D}, \\ \lambda(T) = s = e + 2p > 0, \\ 0 < q < p, \gcd(e, p, q, s) = 1. \end{cases}$$

Up to the action of $\mathrm{GL}^+(2, \mathbb{R})$, we have

$$\begin{cases} \omega(\alpha_1) = (1, 0), \omega(\beta_1) = (0, 1) \\ \omega(\alpha_2) = (2p/s, 0), \omega(\beta_2) = (2q/s, 2). \end{cases}$$

(2) Suppose that (X, ω) is decomposed into two cylinders in the horizontal direction.

Let $\alpha_{1,1}, \beta_{1,1}, \alpha_{1,2}, \beta_{1,2}, \alpha_2, \beta_2$ be as in Figure 17. Set $\alpha_1 = \alpha_{1,1} + \alpha_{1,2}, \beta_1 = \beta_{1,1} + \beta_{1,2}$. Observe that $(\alpha_1, \beta_1, \alpha_2, \beta_2)$ is a symplectic basis for $H_1(X, \mathbb{Z})^-$. Then there exists a unique generator T of \mathcal{O}_D such that $T^*(\omega) = \lambda(T) \cdot \omega$, with $\lambda(T) > 0$, and T is written in the basis $(\alpha_1, \beta_1, \alpha_2, \beta_2)$ by the following matrix $\begin{pmatrix} e & 0 & p & q \\ 0 & e & 0 & s \\ 0 & 2s & -2q & 0 \\ 0 & 2p & 0 & 0 \end{pmatrix}$, where $(e, p, q, s) \in \mathbb{Z}^4$ also satisfies

(\mathcal{P}_D^s) . Up to the action of $\mathrm{GL}^+(2, \mathbb{R})$, we have

$$\begin{cases} \omega(\alpha_1) = (1, 0), \omega(\beta_1) = (0, 1) \\ \omega(\alpha_2) = (p/s, 0), \omega(\beta_2) = (q/s, 1). \end{cases}$$

Conversely, let (X, ω) be an Abelian differential in $\Omega\mathfrak{M}(4)$ having a cylinder decomposition into Models presented above. Suppose that there exists (p, q, s, e) satisfying (\mathcal{P}_D^s) such that, after normalizing by $\mathrm{GL}^+(2, \mathbb{R})$, all the conditions are satisfied, then (X, ω) belongs to $\Omega E_D(4)$.

Proof of Proposition C.2. We distinguish the two cases separately.

Case 1: decomposition into one cylinder.

In the basis $(\alpha_1, \beta_1, \alpha_2, \beta_2)$ of $H_1(X, \mathbb{Z})^-$, the intersection form is given by $\begin{pmatrix} J & 0 \\ 0 & 2J \end{pmatrix}$. There exists a unique generator T of \mathcal{O}_D such that $T^*(\omega) = \lambda \cdot \omega$, with $\lambda > 0$, which is written in this basis by a matrix of the form $\begin{pmatrix} e & 0 & 2p & 2q \\ 0 & e & 2r & 2s \\ s & -q & 0 & 0 \\ -r & p & 0 & 0 \end{pmatrix}$ (see Proposition 4.2). Using $\mathrm{GL}^+(2, \mathbb{R})$ we can assume that

$$\begin{cases} \omega(\alpha_1) = (1, 0), \omega(\beta_1) = (0, 1), \\ \omega(\alpha_2) = (x + y, 0), \omega(\beta_2) = (x, 2), \text{ with } x > 0, y > 0 \end{cases}$$

In other words, $\mathrm{Re}(\omega) = (1, 0, x + y, x)$ and $\mathrm{Im}(\omega) = (0, 1, 0, 2)$ in the basis dual to $(\alpha_1, \beta_1, \alpha_2, \beta_2)$. We must have

$$(10) \quad (1, 0, x + y, x) \cdot T = \lambda(1, 0, x + y, x)$$

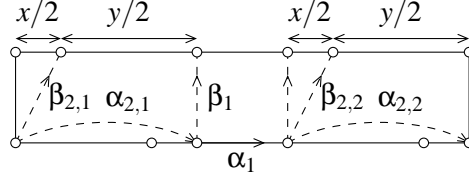

FIGURE 16. Decomposition into one cylinder: $(\alpha_1, \beta_1, \alpha_2, \beta_2)$, where $\alpha_2 = \alpha_{2,1} + \alpha_{2,2}, \beta_2 = \beta_{2,1} + \beta_{2,2}$, is a symplectic basis for $H_1(X, \mathbb{Z})^-$.

and

$$(11) \quad (0, 1, 0, 2) \cdot T = \lambda(0, 1, 0, 2)$$

It follows immediately from (11) that $r = 0$ and $e + 2p = s = \lambda$. Note that λ is the positif root of the characteristic polynomial of T , therefore $\lambda^2 = e\lambda + 2ps$. The condition (10) then implies that $2p = \lambda(x+y)$ and $2q = \lambda x$ from which we deduce in particular that $0 < q < p$. Since T is a generator of \mathcal{O}_D , we have $D = e^2 + 8ps = (e + 4p)^2$, and by the properness of \mathcal{O}_D in $\text{End}(\text{Prym}(X, \rho))$, we have $\gcd(e, p, q, s) = 1$. All the conditions in (\mathcal{P}_D^s) are now fulfilled.

Case 2: decomposition into two cylinders.

In the basis $(\alpha_1, \beta_1, \alpha_2, \beta_2)$ of $H_1(X, \mathbb{Z})^-$, the intersection form is given by $\begin{pmatrix} 2 & 0 \\ 0 & j \end{pmatrix}$. There exists a unique generator T of \mathcal{O}_D such that $T^*(\omega) = \lambda \cdot \omega$, with $\lambda > 0$, which is written in this basis by a matrix of the form $\begin{pmatrix} e & 0 & p & q \\ 0 & e & r & s \\ 2s & -2q & 0 & 0 \\ -2r & 2p & 0 & 0 \end{pmatrix}$ (see Proposition 4.5).

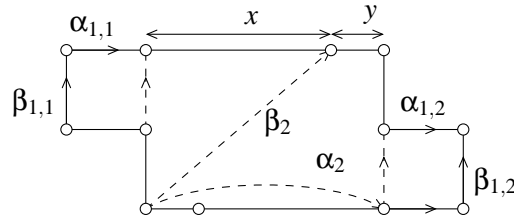

FIGURE 17. Decomposition into two cylinders: $(\alpha_1, \beta_1, \alpha_2, \beta_2)$, where $\alpha_1 = \alpha_{1,1} + \alpha_{1,2}, \beta_1 = \beta_{1,1} + \beta_{1,2}$, is a symplectic basis for $H_1(X, \mathbb{Z})^-$.

Using $\text{GL}^+(2, \mathbb{R})$ we can assume that

$$\begin{cases} \omega(\alpha_1) = (1, 0), \omega(\beta_1) = (0, 1), \\ \omega(\alpha_2) = (x+y, 0), \omega(\beta_2) = (x, 1), \text{ with } x > 0, y > 0 \end{cases}$$

The remainder of the proof for this case follows the same lines as the previous case. \square

We are now ready to prove Theorem C.1:

Proof of Theorem C.1. Let $s = \sqrt{D} - 2p > 0$ and $e = \sqrt{D} - 4p > 0$. It is easy to check that the tuple $(e, p, q, s) \in \mathbb{Z}^4$ satisfies the conditions in (\mathcal{P}_D^s) if and only if $(p, q) \in \mathcal{P}_D^s$. From Proposition C.2, we know that each decomposition into one or two cylinders of the surfaces in $\Omega E_D(4)$ gives rise

to an element of \mathcal{P}_D^s . If two decompositions (with the same number of cylinders) give the same element in \mathcal{P}_D^s then there exists an element of the Veech group which maps one decomposition to other. Conversely, given a pair (p, q) in \mathcal{P}_D^s , we can construct a surface in $\Omega E_D(4)$ which admits a decomposition into one or two cylinders in the horizontal direction. Therefore, we have a bijection from \mathcal{P}_D^s to the set of cusps corresponding to decomposition into one cylinder, and a bijection from \mathcal{P}_D^s to the set of cusps corresponding to decompositions into two cylinders of $W_D(4)$. \square

APPENDIX D. COMPONENTS OF THE PRYM EIGENFORMS LOCUS IN GENUS 4

The approach we use in this paper, namely prototypes and Butterfly moves, can also be employed to investigate the connectedness of the locus $\Omega E_D(6)$. Recall that $\Omega E_D(6)$ is the intersection of the Prym eigenform locus and the stratum $\Omega\mathcal{M}(6)$. Following [McM06b] $\Omega E_D(6)$ is the union of finitely many $\mathrm{GL}^+(2, \mathbb{R})$ -orbits of Veech surfaces. We provide the following classification:

Theorem D.1. *For any $D \in \mathbb{N}$, $D \equiv 0, 1 \pmod{4}$, and $D \notin \{4, 9\}$, the loci $\Omega E_D(6)$ are non empty and pairwise disjoint. Moreover if $D \notin \{8, 12, 16, 36, 41, 52, 68, 84, 100\}$ then $\Omega E_D(6)$*

- (1) *is connected if D is odd,*
- (2) *has at most two components if D is even.*

For the exceptional cases $D = 41, 52, 68, 84$ the locus $\Omega E_D(6)$ has at most three components.

For the exceptional cases $D = 8, 12, 16, 6^2, 10^2$ the locus $\Omega E_D(6)$ is connected.

D.1. Strategy of a proof. We briefly sketch a proof of Theorem D.1. Surfaces in $\Omega E_D(6)$ admit two types of decomposition into four cylinders, which will be called Model A, and Model B. The Model A is characterized by the existence of simple cylinders (see Figure 18) while the Model B is characterized by the absence of such cylinders (see Figure 19).

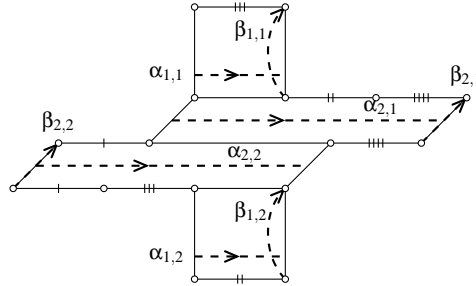
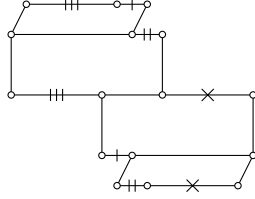

FIGURE 18. Cylinder decomposition in $\Omega E_D(6)$: Model A. For $i = 1, 2$, setting $\alpha_i := \alpha_{i,1} + \alpha_{i,2}$ and $\beta_i := \beta_{i,1} + \beta_{i,2}$ observe that $\{\alpha_1, \beta_1, \alpha_2, \beta_2\}$ is a basis of $H_1(X, \mathbb{Z})^-$.

We first need to normalize the decompositions in model A.

Proposition D.2. *Let $(X, \omega) \in \Omega E_D(6)$ be a Prym eigenform which admits a cylinders decomposition of Model A, equipped with the symplectic basis presented in Figure 18.*

- (i) *There exists a unique generator T of \mathcal{O}_D such that the matrix of T in the basis $(\alpha_1, \beta_1, \alpha_2, \beta_2)$ has the form $\begin{pmatrix} e^{-\mathrm{id}_2} & B \\ B^* & 0 \end{pmatrix}$, and $T^*(\omega) = \lambda(T)\omega$ with $\lambda(T) > 0$.*

FIGURE 19. Cylinder decomposition in $\Omega E_D(6)$: Model B.

- (ii) Up to the action $\mathrm{GL}^+(2, \mathbb{R})$ and Dehn twists, there exist $w, h, t \in \mathbb{N}$ such that the tuple (w, h, t, e) satisfies

$$(\tilde{\mathcal{P}}) \begin{cases} w > 0, h > 0, 0 \leq t < \mathrm{gcd}(w, h), \\ \mathrm{gcd}(w, h, t, e) = 1, \\ D = e^2 + 4wh, \\ 0 < \lambda := \frac{e + \sqrt{D}}{2} < \frac{w}{2} \text{ (or, equivalently, } w > 2(e + 2h)) \end{cases},$$

and the matrix of T in the basis $\{\alpha_1, \beta_1, \alpha_2, \beta_2\}$ is $\begin{pmatrix} e & 0 & w & t \\ 0 & e & 0 & h \\ h & -t & 0 & 0 \\ 0 & w & 0 & 0 \end{pmatrix}$. Moreover, in these coordinates we have

$$\begin{cases} \omega(\mathbb{Z}\alpha_{2,1} + \mathbb{Z}\beta_{2,1}) = \omega(\mathbb{Z}\alpha_{2,2} + \mathbb{Z}\beta_{2,2}) = \mathbb{Z}(\frac{w}{2}, 0) + \mathbb{Z}(\frac{t}{2}, \frac{h}{2}) \\ \omega(\mathbb{Z}\alpha_{1,1} + \mathbb{Z}\beta_{1,1}) = \omega(\mathbb{Z}\alpha_{1,2} + \mathbb{Z}\beta_{1,2}) = \frac{\lambda}{2} \cdot \mathbb{Z}^2 \end{cases}$$

Conversely, let $(X, \omega) \in \Omega \mathcal{M}(6)$ having a four-cylinder decomposition. Assume there exists $(w, h, t, e) \in \mathbb{Z}^4$ satisfying $(\tilde{\mathcal{P}})$, such that after normalizing by $\mathrm{GL}^+(2, \mathbb{R})$, all the above conditions are fulfilled. Then $(X, \omega) \in \Omega E_D(6)$.

The proof of Proposition D.2 is analogous to the proof of Proposition 4.5, the only difference is that the intersection form in $H_1(X, \mathbb{Z})^-$ is now given by $\begin{pmatrix} 2J & 0 \\ 0 & 2J \end{pmatrix}$.

Remark D.3. One can also provide prototypes for Model B as

$$(\tilde{\mathcal{P}}') \begin{cases} w > 0, h > 0, 0 \leq t < \mathrm{gcd}(w, h), \\ \mathrm{gcd}(w, h, t, e) = 1, \\ D = e^2 + 4wh, \\ \frac{w}{2} < \lambda := \frac{e + \sqrt{D}}{2} < w \end{cases},$$

Putting prototypes for Model A and Model B together, we get a parametrisation for cusps associated to Models A and B (compare with [McM05a]):

Proposition D.4. For any surface of $\Omega E_D(6)$, the set of periodic directions associated to Models A and B is parametrised by

$$\left\{ (w, h, t, e) \in \mathbb{Z}^4, \begin{array}{l} w > 0, h > 0, 0 \leq t < \mathrm{gcd}(w, h), h + e < w, \\ \mathrm{gcd}(w, h, t, e) = 1, \text{ and } D = e^2 + 4hw. \end{array} \right\}$$

The next proposition tells us that, except the case $D = 5$, the surfaces in $\Omega E_D(6)$ always admit a decomposition in Model A, its proof is similar to Proposition 4.7.

Proposition D.5. *Let (X, ω) be an eigenform in $\Omega E_D(6)$. Then the flat surface associated to (X, ω) has no decompositions in model A if and only if $D = 5$.*

For a fixed D , we denote by $\tilde{\mathcal{P}}_D$ the set of (w, h, t, e) satisfying $(\tilde{\mathcal{P}})$, the elements of $\tilde{\mathcal{P}}_D$ are called *prototypes*. We can define the *Butterfly moves* $B_{q, q} \in \mathbb{N} \cup \{\infty\}$, for decompositions of type A in the same way as in Section 7. Note that in this case the Butterfly moves preserve the type of the decomposition. The admissibility condition now becomes

$$0 < \lambda q < \frac{w}{2} \Leftrightarrow (e + 4qh)^2 < D$$

The actions of the Butterfly moves on $(\tilde{\mathcal{P}})$ are the same as the case $\Omega E_D(4)$ (see Propositions 7.5 and 7.6), namely

(1) If $q \in \mathbb{N}$ then

$$\begin{cases} e' &= -e - 4qh, \\ h' &= \gcd(qh, w + qt) \end{cases}$$

(2) If $q = \infty$ then

$$\begin{cases} e' &= -e - 4h, \\ h' &= \gcd(t, h) \end{cases}$$

We can parametrize the set of *reduced prototypes* (see Section 8.1), by the set

$$\tilde{S}_D = \{e \in \mathbb{Z} : e \equiv D \pmod{2} \text{ and } e^2, (e+4)^2 < D\}.$$

We call an equivalence class of the equivalence relation generated by the Butterfly moves on $\tilde{\mathcal{P}}_D$ (respectively, \tilde{S}_D) a component of $\tilde{\mathcal{P}}_D$ (respectively, \tilde{S}_D). We then have

Theorem D.6. *Let $D \geq 12$ be a discriminant. Let us assume that*

$$D \notin \left\{ \begin{array}{l} 12, 16, 17, 20, 25, 28, 36, 73, 88, 97, 105, 112, 121, 124, 136, 145, 148, \\ 169, 172, 184, 193, 196, 201, 217, 220, 241, 244, 265, 268, 292, 304, \\ 316, 364, 385, 436, 484, 556, 604, 676, 796, 844, 1684 \end{array} \right\}.$$

Then the set \tilde{S}_D is non empty and has either

- *three components, $\{e \in \tilde{S}_D, e \equiv 0 \text{ or } 4 \pmod{8}\}$, $\{e \in \tilde{S}_D, e \equiv 2 \pmod{8}\}$ and $\{e \in \tilde{S}_D, e \equiv -2 \pmod{8}\}$, if $D \equiv 4 \pmod{8}$,*
- *two components,*
 - *$\{e \in \tilde{S}_D, e \equiv 1 \text{ or } 3 \pmod{8}\}$ and $\{e \in \tilde{S}_D, e \equiv -1 \text{ or } -3 \pmod{8}\}$ if $D \equiv 1 \pmod{8}$,*
 - *$\{e \in \tilde{S}_D, e \equiv 0 \text{ or } 4 \pmod{8}\}$ and $\{e \in \tilde{S}_D, e \equiv +2 \text{ or } -2 \pmod{8}\}$ if $D \equiv 0 \pmod{8}$,*
- *only one component, otherwise.*

Remark D.7. *There is a simple congruence condition that explains why \tilde{S}_D is not connected for some values of D .*

As a corollary we draw:

Theorem D.8. *Let $D \geq 12$ be a discriminant. If $D \notin \{36, 41, 52, 68, 84, 100\}$ then $\tilde{\mathcal{P}}_D$ is non empty and has either*

- *only one component if $D = 12$ or $D = 16$,*

- two components, $\{p \in \mathcal{P}_D, e \equiv 0 \pmod{4}\}$ and $\{p \in \tilde{\mathcal{P}}_D, e \equiv 2 \pmod{4}\}$, if D is even, or
- only one component otherwise.

For the exceptional cases mentioned above, $\tilde{\mathcal{P}}_D$ has three components.

Remark D.9. Again there is a simple congruence relation that explain why there is (at least) two components when D is even. Indeed since $e' = -e - 4qh$ and e is even, the value of e modulo 4 is constant.

To prove the previous theorems, we use similar ideas to the proofs of Theorem 8.6 and Theorem 8.2. This is straightforward. Theorem D.1 is then a direct consequence of these results.

REFERENCES

- [BM10] M. BAINBRIDGE and M. MÖLLER – “Deligne-Mumford compactification of the real multiplication locus and Teichmueller curves in genus three”, arXiv:0911.4677.
- [Cal04] K. CALTA – “Veech surfaces and complete periodicity in genus two”, *J. Amer. Math. Soc.* **17** (2004), no. 4, pp. 871–908.
- [EM10] A. ESKIN and M. MIRZAKHANI – “On invariant and stationary measures for the $SL(2, \mathbb{R})$ action on moduli space”, <http://www.math.uchicago.edu/~eskin/> (2010).
- [HM79] J. HUBBARD and H. MASUR – “Quadratic differentials and foliations”, *Acta Math.* **142** (1979), no. 3-4, p. 221–274.
- [HS08] F. HERRLICH and G. SCHMITHÜSEN – “An extraordinary origami curve”, *Math. Nachr.* **281** (2008), no.2, pp. 219-237.
- [Kan67] H.-J. KANOLD – “Über eine zahlentheoretische Funktion von Jacobsthal”, *Math. Ann.* **170** (1967), pp.31–326.
- [KZ97] M. KONTSEVICH, and A. ZORICH – “Lyapunov exponents and Hodge theory”, arXiv:hep-th/9701164v1 (1997).
- [KZ03] ———, “Connected components of the moduli spaces of Abelian differentials with prescribed singularities”, *Invent. Math.* **153** (2003), no. 3, pp.631–678.
- [LN11] E. LANNEAU and D.-M. NGUYEN, “A Ratner theorem for $SL(2, \mathbb{R})$ on Prym varieties”, *in preparation* (2011).
- [Mas82] H. MASUR – “Interval exchange transformations and measured foliations”, *Ann of Math.* **141** (1982) 169–200.
- [MaTa02] H. MASUR, S. TABACHNIKOV – “Rational billiards and flat structures”, *Handbook of dynamical systems*, **1A**, North-Holland, Amsterdam (2002), pp. 1015–1089.
- [McM03a] C. MCMULLEN – “Billiards and Teichmüller curves on Hilbert modular surfaces”, *J. Amer. Math. Soc.* **16** (2003), no. 4, pp. 857–885.
- [McM03b] ———, “Teichmüller geodesics of infinite complexity”, *Acta Math.* **191** (2003), no. 2, pp. 191–223.
- [McM05a] ———, “Teichmüller curves in genus two: Discriminant and spin”, *Math. Ann.* **333** (2005), pp. 87–130.
- [McM05b] ———, “Teichmüller curves in genus two: The decagon and beyond”, *J. reine angew. Math.* **582** (2005), pp. 173–200.
- [McM06a] ———, “Teichmüller curves in genus two: Torsion divisors and ratios of sines”, *Invent. Math.* **165** (2006), pp. 651–672.
- [McM06b] ———, “Prym varieties and Teichmüller curves”, *Duke Math. J.* **133** (2006), pp. 569–590.
- [McM07] ———, “Dynamics of $SL_2(\mathbb{R})$ over moduli space in genus two”, *Ann. of Math. (2)* **165** (2007), no. 2, 397–456.
- [Möl06] M. Möller, *Variations of Hodge structure of Teichmüller curves*, *J. Amer. Math. Soc.* **19** no. 2, (2006) 327–344.
- [Möl08] ———, *Linear manifolds in the moduli space of one-forms*, *Duke Math. J.* **144** (2008), pp. 447–487.
- [Möl11] ———, *Prym covers, theta functions and Kobayashi geodesics in Hilbert modular surfaces*, (2011), in preparation.
- [SW06] J. SMILLIE and B. WEISS – “Finiteness results for flat surfaces: a survey and problem list, (2006) in Partially hyperbolic dynamics, laminations, and Teichmueller flow” *Proceedings of a conference, Fields Institute, Toronto Jan 2006*, *G. Forni (ed.)* (2006).
- [Ste09] W. A. STEIN ET AL – “Sage Mathematics Software (Version 4.2.1)”, The Sage Development Team, 2009, <http://www.sagemath.org>.

- [Thu88] W. THURSTON – “On the geometry and dynamics of homeomorphisms of surfaces”, *Bull. A.M.S.* **19** (1988), pp. 417–431.
- [Tro86] M. TROYANOV – “Les surfaces euclidiennes à singularités coniques”, *Enseign. Math.* **32** (1986), pp. 79–94.
- [Vee82] W. VEECH – “Gauss measures for transformations on the space of interval exchange maps”, *Ann. of Math. (2)* **115** (1982), no. 1, pp. 201–242.
- [Vee89] ———, *Teichmüller curves in modular space, Eisenstein series, and an application to triangular billiards*, *Inv. Math.* **97**, (1989) 553–583.
- [Vee92] ———, “Geometric realizations of hyperelliptic curves”, *Algorithms, fractals, and dynamics (Okayama/Kyoto, 1992)* Plenum, New York (1992), pp. 217–226.
- [Vee90] ———, “Moduli spaces of quadratic differentials”, *J. Analyse Math.* **55** (1990), pp. 117–170.
- [Zor06] A. ZORICH – “Flat surfaces”, *Frontiers in number theory, physics, and geometry* 437–583, Springer, Berlin, 2006.

UNITÉ MIXTE DE RECHERCHE (UMR 6207) DU CNRS ET DE L’UNIVERSITÉ D’AIX-MARSEILLE
ET DE L’UNIVERSITÉ DU SUD TOULON-VAR. UNITÉ AFFILIÉE À LA FRUMAM FÉDÉRATION DE RECHERCHE 2291
DU CNRS.

LUMINY, CASE 907, F-13288 MARSEILLE CEDEX 9, FRANCE

E-mail address: `lanneau@cpt.univ-mrs.fr`

IMB BORDEAUX-UNIVERSITÉ BORDEAUX 1

351, COURS DE LA LIBÉRATION

33405 TALENCE CEDEX, FRANCE

E-mail address: `duc-manh.nguyen@math.u-bordeaux1.fr`