

Elliptic dihedral covers in dimension 2, geometry of sections of elliptic surfaces, and Zariski pairs for line-conic arrangements

Hiro-o TOKUNAGA¹

Introduction

In this article, all varieties are defined over the field of complex numbers, \mathbb{C} . Let X and Y be normal projective varieties. We call X a dihedral cover of Y if there exists a finite surjective morphism $\pi : X \rightarrow Y$ such that the induced field extension of the rational function fields $\mathbb{C}(X)/\mathbb{C}(Y)$ is a Galois extension whose Galois group is isomorphic to a dihedral group.

Let D_{2n} be the dihedral group of order $2n$. In order to present D_{2n} , we use the notation

$$D_{2n} = \langle \sigma, \tau \mid \sigma^2 = \tau^n = (\sigma\tau)^2 = 1 \rangle.$$

By D_{2n} -covers, we mean a Galois cover whose Galois group is isomorphic to D_{2n} . Given a D_{2n} -cover, we obtain a double cover, $D(X/Y)$, canonically by considering the $\mathbb{C}(X)^\tau$ -normalization of Y , where $\mathbb{C}(X)^\tau$ denotes the fixed field of the subgroup generated by τ . We denote these covering morphisms by $\beta_1(\pi) : D(X/Y) \rightarrow Y$ and $\beta_2(\pi) : X \rightarrow D(X/Y)$, respectively.

In [19], we introduce a notion of an elliptic D_{2n} -cover, whose definition is as follows:

Definition 0.1 *A D_{2n} -cover $\pi : X \rightarrow Y$ is called an elliptic D_{2n} -cover if it satisfies the following condition:*

- *$D(X/Y)$ has a structure of an elliptic fiber space $\varphi : D(X/Y) \rightarrow S$ over a projective variety S with a section $O : S \rightarrow D(X/Y)$.*
- *The covering transformation $\sigma_{\beta_1(\pi)}$ coincides with the inversion with respect to the group law on the generic fiber $D(X/Y)_\eta$. Here the group law on $D(X/Y)_\eta$ is given by regarding O as the zero element.*

In this article, as a continuation of [19], we study an elliptic D_{2p} -cover (p : odd prime) of a rational ruled surface Σ_d (d : even). Our main results are Theorems 3.1 and 4.1. As an application, we study some Zariski pairs of degree 7 for line-conic arrangements. Let us recall the definition of a Zariski pair.

Definition 0.2 *A pair (B_1, B_2) of reduced plane curves B_i ($i = 1, 2$) of degree n is called a Zariski pair of degree n if it satisfies the following condition:*

- (i) *B_i ($i = 1, 2$) are curves of degree n . The combinatorial type (see Definition 0.3 below) of B_1 is the same as that of B_2*

¹Research partly supported by the research grant 22540052 from JSPS

(ii) (\mathbb{P}^2, B_1) is not homeomorphic to (\mathbb{P}^2, B_2) .

Definition 0.3 ([1]) The *combinatorial type* of a curve B is given by a 7-tuple

$$(\text{Irr}(B), \text{deg}, \text{Sing}(B), \Sigma_{\text{top}}(B), \sigma_{\text{top}}, \{B(P)\}_{P \in \text{Sing}(B)}, \{\beta_P\}_{P \in \text{Sing}(B)}),$$

where:

- $\text{Irr}(B)$ is the set of irreducible components of B and $\text{deg} : \text{Irr}(B) \rightarrow \mathbb{Z}$ assigns to each irreducible component its degree.
- $\text{Sing}(B)$ is the set of singular points of B , $\Sigma_{\text{top}}(B)$ is the set of topological types of $\text{Sing}(B)$, and $\sigma_{\text{top}} : \text{Sing}(B) \rightarrow \Sigma_{\text{top}}(B)$ assigns to each singular point its topological type.
- $B(P)$ is the set of local branches of B at $P \in \text{Sing}(B)$, (a local branch can be seen as an arrow in the dual graph of the minimal resolution of B at P , see [5, Chapter II.8] for details) and $\beta_P : B(P) \rightarrow \text{Irr}(B)$ assigns to each local branch the global irreducible component containing it.

Two curves B_1 and B_2 is said to have the *same combinatorial type* (or simply the *same combinatorics*) if their data of combinatorial types

$$(\text{Irr}(B_i), \text{deg}_i, \text{Sing}(B_i), \Sigma_{\text{top}}(B_i), \sigma_{\text{top}_i}, \{\beta_{i,P}\}_{P \in \text{Sing}(B_i)}, \{B_i(P)\}_{P \in \text{Sing}(B_i)}), \quad i = 1, 2,$$

are equivalent, that is, if $\Sigma_{\text{top}}(B_1) = \Sigma_{\text{top}}(B_2)$, and there exist bijections $\varphi_{\text{Sing}} : \text{Sing}(B_1) \rightarrow \text{Sing}(B_2)$, $\varphi_P : B_1(P) \rightarrow B_2(\varphi_{\text{Sing}}(P))$ (restriction of a bijection of dual graphs) for each $P \in \text{Sing}(B_1)$, and $\varphi_{\text{Irr}} : \text{Irr}(B_1) \rightarrow \text{Irr}(B_2)$ such that $\text{deg}_2 \circ \varphi_{\text{Irr}} = \text{deg}_1$, $\sigma_{\text{top}_2} \circ \varphi_{\text{Sing}} = \sigma_{\text{top}_1}$, and $\beta_{2, \varphi_{\text{Sing}}(P)} \circ \varphi_P = \varphi_{\text{Irr}} \circ \beta_{1,P}$.

Note that when B_i ($i = 1, 2$) are irreducible, B_1 and B_2 have the same combinatorics if they have the same degree and the same local topological types for singularities. On the other extreme, for line arrangements, B_1 and B_2 have the same combinatorial type if they have the same set of incidence relations. The first example of a Zariski pair is given by Zariski ([23, 24]), which is as follows:

Example 0.1 Let (B_1, B_2) be a pair of irreducible sextics such that (i) both of B_1 and B_2 have six cusps as their singularities, and (ii) the six cusp of B_1 are on a conic, while no such conic for B_2 . Then (B_1, B_2) is a Zariski pair.

For these twenty years, Zariski pairs have been studied by many mathematicians and many examples have been found (see [1] and its reference). Among them, Zariski pairs for line arrangements of degrees 9 and 11 are considered by Artal Bartolo, Carmona Ruber, Cogolludo Agustin and Marco Buzunariz ([2, 3]), Rybnikov ([13]) and those for conic arrangements of degree 8 are considered by Namba and Tsuchihashi ([10]). In this article, we study Zariski pairs for line-conic arrangement.

As we explain in [1], the study of Zariski pairs, in general, consists of two parts:

- (I) To give curves B_1 and B_2 having the same combinatorics, but some “*different property*,” e.g., the location of singularities as in Example 0.1.

(II) To show (\mathbb{P}^2, B_1) is not homeomorphic to (\mathbb{P}^2, B_2) .

One of our goals in this article is to add another method to find two curves with the same combinatorics. Namely we make use of geometry of sections of the Mordell-Weil group of an elliptic surface as follows:

Let $\varphi : S \rightarrow \mathbb{P}^1$ be an elliptic surface with a section O and let

$$\begin{array}{ccc} S' & \xleftarrow{\mu} & S \\ f' \downarrow & & \downarrow f \\ \Sigma_d & \xleftarrow{q} & \widehat{\Sigma}_d. \end{array}$$

be the double cover diagram for S (see 2.2). Let Δ_1 and Δ_2 be sections of Σ_d with $\Delta_i^2 = d$ ($i = 1, 2$). Suppose that $(q \circ f)^*(\Delta_i)$ consists of two sections $s_{\Delta_i}^{\pm}$ for each i and $\widehat{\Sigma}_d$ can be blow down to \mathbb{P}^2 , which we denote by $\bar{q} : \widehat{\Sigma}_d \rightarrow \mathbb{P}^2$. Let $[2]s_{\Delta_i}^+$ be the duplication of $s_{\Delta_i}^+$ in $\text{MW}(S)$. In order to produce two reduced curves B_1 and B_2 with the same combinatorics, we use $\bar{q} \circ f(s_{\Delta_i}^+)$ ($i = 1, 2$), $\bar{q} \circ f([2]s_{\Delta_i}^+)$, and $\bar{q}(\Delta(S/\widehat{\Sigma}_d))$, where $\Delta(S/\widehat{\Sigma}_d)$ is the branch locus of f . The author hopes that this method add a new viewpoint to the study of elliptic surfaces and their Mordell-Weil groups.

As for (II), we also make use of theory of dihedral covers and elementary arithmetic on the Mordell-Weil group of an elliptic surface as in our previous papers ([17, 18, 19]).

Now let us explain line-conic arrangements of degree 7 considered in this article.

Line-conic arrangement 1

Let C_i ($i = 1, 2$) be smooth conics and let L_j ($i = 1, 2, 3, 4$) be lines as follows:

- (i) Both L_1 and L_2 meet C_1 transversely. We put $C_1 \cap L_1 = \{P_1, P_2\}$, $C_1 \cap L_2 = \{P_3, P_4\}$.
- (ii) C_2 is tangent to C_1 at two distinct points $\{Q_1, Q_2\}$ or at one point $\{Q\}$. We call the former type (a) and the latter type (b).
- (iii) The tangent lines at $C_1 \cap C_2$ do not pass through $L_1 \cap L_2$.
- (iv) C_2 is tangent to L_1 and L_2 .
- (v) L_3 passes through P_1 and P_3 .
- (vi) L_4 passes through P_1 and P_4 .
- (vii) Both L_3 and L_4 meet C_2 transversely.

We put $B_1 := C_1 + C_2 + L_1 + L_2 + L_3$ and $B_2 := C_1 + C_2 + L_1 + L_2 + L_4$. Then B_1 and B_2 have the same combinatorics.

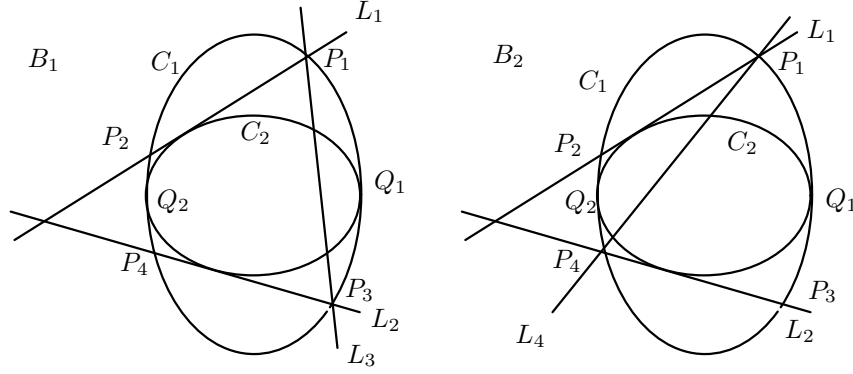

Line-conic arrangement 1 of type (a)

Line-conic arrangement 2

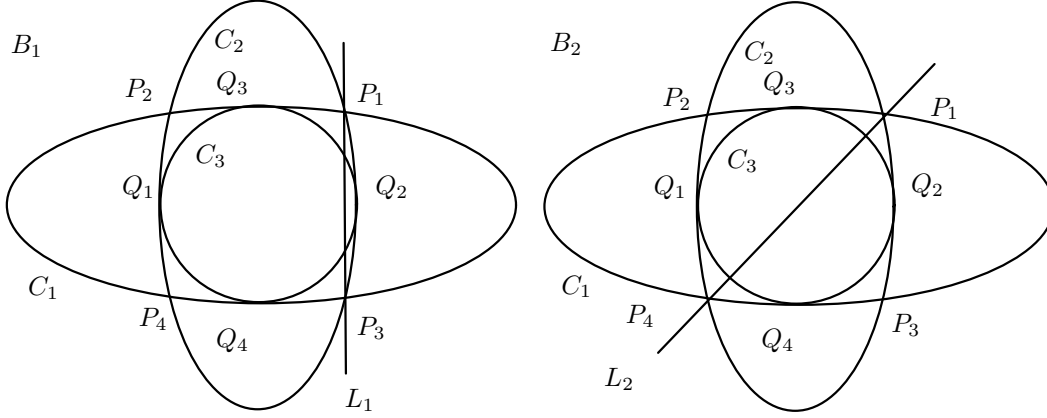

Line-conic arrangement 2 of type (a)

Let C_1, C_2 and C_3 be smooth conics and L_1 and L_2 be lines as follows:

- (i) C_1 and C_2 meet transversely. We put $C_1 \cap C_2 = \{P_1, P_2, P_3, P_4\}$.
- (ii) C_3 is tangent to both C_1 and C_2 such that the intersection multiplicities at intersection points are all even. By exchanging C_1 and C_2 if necessary, we may assume that there are three possibilities:
 - (a) $C_3 \cap C_1 = \{Q_1, Q_2\}, C_3 \cap C_2 = \{Q_3, Q_4\}$,
 - (b) $C_3 \cap C_1 = \{Q_1\}, C_3 \cap C_2 = \{Q_2, Q_3\}$ or
 - (c) $C_3 \cap C_1 = \{Q_1\}, C_3 \cap C_2 = \{Q_2\}$.
- (iii) No tangent line at Q_i is bitangent of $C_1 + C_2$.
- (iv) L_1 passes through P_1 and P_3 .
- (v) L_2 passes through P_1 and P_4 .

(vi) Both of L_1 and L_2 meet C_3 transversely.

We put $B_1 := C_1 + C_2 + C_3 + L_1$ $B_2 := C_1 + C_2 + C_3 + L_2$. Then B_1 and B_2 have the same combinatorics.

Theorem 0.1 (i) *Let (B_1, B_2) be the pair of Line-conic arrangement 1. Then (B_1, B_2) is a Zariski pair.*

(ii) *Let C_1 and C_2 be conics intersecting four distinct points, P_1, P_2, P_3 and P_4 and let L_0, L_1 and L_2 be lines through $\{P_1, P_2\}, \{P_1, P_3\}$ and $\{P_1, P_4\}$, respectively. Choose a point z_o on C_1 such that the tangent line at z_o to C_1 is not tangent to C_2 . Then there exist just three conics $C_3^{(0)}, C_3^{(1)}$ and $C_3^{(2)}$ satisfying the following conditions:*

- $z_o \in C_3^{(i)}$ for each i ,
- For each i , $C_3^{(i)}$ is tangent to both C_1 and C_2 such that the intersection multiplicities $I_x(C_3^{(i)}, C_j)$ ($j = 1, 2$) at $\forall x \in C_3^{(i)} \cap C_j$ ($j = 1, 2$) are all even.
- For $i = 1, 2$, if both of $C_1 + C_2 + C_3^{(i)} + L_1$ and $C_1 + C_2 + C_3^{(i)} + L_2$ have the combinatoric for Line-conic arrangement 2 of the same type, then $(C_1 + C_2 + C_3^{(i)} + L_1, C_1 + C_2 + C_3^{(i)} + L_2)$ is a Zariski pair.

Remark 0.1 The triple $(C_1 + C_2 + C_3^{(i)} + L_0, C_1 + C_2 + C_3^{(i)} + L_1, C_1 + C_2 + C_3^{(i)} + L_2)$ may be a candidate for a Zariski triple. Our method in this article, however, does not work to see whether it is or not.

This article consists of 5 sections. In §1 and §2, we summarize some facts and results for theory of elliptic surfaces and D_{2n} -covers, which we need to prove our theorem. We prove Theorem 3.1 in §3 and Theorem 4.1 in §4. In §5, we prove Theorem 0.1 and give another example of a Zariski pair.

Acknowledgement. Some part of this article was done during author's visit to Universidad de Zaragoza and Ruhr Universität Bochum in September 2011. He thanks for Professors E. Artal Bartolo, J.-I. Cogolludo and P. Heinzner for their hospitality.

1 D_{2n} -covers

In this section, we summarize some facts on Galois covers. We refer to [15] and [1, §3] for details.

We start with terminology on Galois covers. Let X and Y be normal projective varieties with finite morphism $\pi : X \rightarrow Y$. We say X is a Galois cover of Y if the induced field extension $\mathbb{C}(X)/\mathbb{C}(Y)$ by π^* is Galois, where $\mathbb{C}(\bullet)$ means the rational function field of \bullet . Note that the Galois group acts on X such that Y is obtained as the quotient space with respect to this action (cf. [16, §1]). If the Galois group $\text{Gal}(\mathbb{C}(X)/\mathbb{C}(Y))$ is isomorphic to a finite group G , we call X a G -cover of Y . The branch locus of $\pi : X \rightarrow Y$, which we denote by Δ_π or $\Delta(X/Y)$, is the subset of Y consisting of points y of Y , over which π is not locally

isomorphic. It is well-known that Δ_π is an algebraic subset of pure codimension 1 if Y is smooth ([25]).

Suppose that Y is smooth. Let B be a reduced divisor on Y with irreducible decomposition $B = \sum_{i=1}^r B_i$. A G -cover $\pi : X \rightarrow Y$ is said to be branched at $\sum_{i=1}^r e_i B_i$ if (i) $\Delta_\pi = B$ (here we identify B with its support) and (ii) the ramification index along B_i is e_i for each i , where the ramification index mean the one along the smooth part of B_i for each i . Note that the study of G -covers is related to that of Zariski pairs, since we have the following proposition (see [1] for details):

Proposition 1.1 ([1, Proposition 3.6]) *Let γ_i be a meridian around B_i , and $[\gamma_i]$ denote its class in the topological fundamental group $\pi_1(Y \setminus B, p_o)$. Let Y be a smooth projective variety and let $B = B_1 + \cdots + B_r$ be the decomposition into irreducible components of a reduced divisor B on Y . If there exists a G -cover $\pi : X \rightarrow Y$ branched at $e_1 B_1 + \cdots + e_r B_r$, then there exists a normal subgroup H_π of $\pi_1(Y \setminus B, p_o)$ such that:*

- (i) $[\gamma_i]^{e_i} \in H_\pi, [\gamma_i]^k \notin H_\pi, (1 \leq k \leq e_i - 1)$, and
- (ii) $\pi_1(Y \setminus B, p_o)/H_\pi \cong G$.

Conversely, if there exists a normal subgroup H of $\pi_1(Y \setminus B, p_o)$ satisfying the above two conditions for H_π , then there exists a G -cover $\pi_H : X_H \rightarrow Y$ branched at $e_1 B_1 + \cdots + e_r B_r$.

We keep our notation for D_{2n} -covers in Introduction. Here are two propositions for later use.

Proposition 1.2 *Let n be an odd integer ≥ 3 . Let Z be a smooth double cover of a smooth projective variety Y . We denote its covering morphism and covering transformation by f and σ_f , respectively. Let D be an effective divisor on Z satisfying the following condition:*

- (i) D and $\sigma_f^* D$ have no common component.
- (ii) If $D = \sum_i a_i D_i$ denotes its irreducible decomposition, then $\gcd(a_i, n) = 1$ for every i .
- (iii) $D - \sigma_f^* D$ is n -divisible in $\text{Pic}(Z)$.

Then there exists a D_{2n} -cover $\pi : X \rightarrow Y$ such that

- (a) $\beta_2(\pi)$ is branched at $n((D + \sigma_f^* D)_{\text{red}})$.
- (b) $D(X/Y) = Z$ and $f = \beta_2(\pi)$.

Proof. By [15, Proposition 0.4], our statements except the ramification indices are straightforward. As for the ramification indices, it follows from the last line of the proof of [15, Proposition 0.4]. \square

Proposition 1.3 *Let n be an odd integer ≥ 3 . Let $\pi : X \rightarrow Y$ be a D_{2n} -cover such that both Y and $D(X/Y)$ are smooth. Let σ_{β_1} be the covering transform of $\beta_1(\pi)$. If $\beta_2(\pi)$ is branched at $n\mathcal{D}$ for some non-zero reduced divisor \mathcal{D} on $D(X/Y)$, then there exists an effective divisor D , whose irreducible decomposition is $\sum_i a_i D_i$ satisfying the following conditions:*

- (i) D and $\sigma_{\beta_1}^* D$ have no common component.

(ii) $D - \sigma_{\beta_1}^* D$ is n -divisible in $\text{Pic}(D(X/Y))$.

(iii) For every i , $\gcd(a_i, n) = 1$.

(iv) $\mathcal{D} = (D + \sigma_{\beta_1}^* D)_{\text{red}}$.

Proof. The statement essentially follows from Proposition 0.5 and its proof in [15]. We, however, give another simple proof based on the idea of versal D_{2n} -covers (see [20, 22] for versal Galois covers). By [22], there exists an element $\xi \in \mathbb{C}(X)$ such that the action of D_{2n} on ξ is given in such a way that:

$$\begin{cases} \xi^\sigma &= \frac{1}{\xi} \\ \xi^\tau &= \zeta_n \xi, \quad \zeta_n = \exp\left(\frac{2\pi i}{n}\right). \end{cases}$$

By using ξ , we have $\mathbb{C}(D(X/Y)) = \mathbb{C}(Y)(\xi^n)$, $\mathbb{C}(X) = \mathbb{C}(Y)(\xi)$. Put $\theta = \xi^n \in \mathbb{C}(D(X/Y))$. Let (θ) , $(\theta)_0$ and $(\theta)_\infty$ be the divisor of θ , the zero and polar divisors of θ , respectively. Write $(\theta)_0$ in such a way that

$$(\theta)_0 = \sum_i a_i D_i + nD',$$

where D_i 's are irreducible divisor on $D(X/Y)$ with $1 \leq a_i < n$ and D' is an effective divisor on $D(X/Y)$. Since σ induces σ_{β_1} on $D(X/Y)$ and $\theta^\sigma (= \theta^{\sigma_{\beta_1}}) = 1/\theta$, we have equalities of divisors:

$$\begin{aligned} (\theta)_\infty &= \sum_i a_i \sigma_{\beta_1}^* D_i + n\sigma_{\beta_1}^* D' \\ (\theta) &= (\varphi)_0 - (\varphi)_\infty \\ &= \sum_i a_i (D_i - \sigma_{\beta_1}^* D_i) + n(D' - \sigma_{\beta_1}^* D'). \end{aligned}$$

Now we put $D = \sum_i a_i D_i$. Since we may assume that $(\theta)_0$ and $(\theta)_\infty$ have no common components, our statements (i) and (ii) follow. As X is the $\mathbb{C}(D(X/Y))(\sqrt[n]{\theta})$ -normalization of $D(X/Y)$ and the ramification index along D_i is $n/\gcd(a_i, n)$, our statements (iii) and (iv) follow. □

Corollary 1.1 *Under the same assumption of Proposition 1.3, if D is an irreducible divisor on Y such that $(\beta_1(\pi))^{-1}(D) \subset \Delta_{\beta_2(\pi)}$, then $\beta_1(\pi)^* D$ consists of two irreducible components. In particular, in the case of $\dim Y = 2$, $I_x(D, \Delta_{\beta_1(\pi)})$ is even for $\forall x \in D \cap \Delta_{\beta_1(\pi)}$*

Proof. The first statement is immediate from Proposition 1.3. For the second statement, let \tilde{D} be the normalization of D . If there exists $x \in D \cap \Delta_{\beta_1(\pi)}$ such that $I_x(D, \Delta_{\beta_1(\pi)})$ is odd, $\beta_1(\pi)$ induces a branched double cover of \tilde{D} . This means $\beta_1(\pi)^* D$ is irreducible. □

2 Elliptic surfaces

2.1 General Facts

We first summarize some facts on the theory of elliptic surfaces. As for details, we refer to [7], [8], [9] and [14].

In this article, the term, an *elliptic surface*, always means a smooth projective surface S equipped with a structure of a fiber space $\varphi : S \rightarrow C$ over a smooth projective curve, C , as follows:

- (i) There exists a non-empty finite subset, $\text{Sing}(\varphi)$, of C such that $\varphi^{-1}(v)$ is a smooth curve of genus 1 for $v \in C \setminus \text{Sing}(\varphi)$, while $\varphi^{-1}(v)$ is not a smooth curve of genus 1 for $v \in \text{Sing}(\varphi)$.
- (ii) φ has a section $O : C \rightarrow S$ (we identify O with its image).
- (iii) There is no exceptional curve of the first kind in any fiber.

For $v \in \text{Sing}(\varphi)$, we put $F_v = \varphi^{-1}(v)$. We denote its irreducible decomposition by

$$F_v = \Theta_{v,0} + \sum_{i=1}^{m_v-1} a_{v,i} \Theta_{v,i}$$

where m_v is the number of irreducible components of F_v and $\Theta_{v,0}$ is the irreducible component with $\Theta_{v,0}O = 1$. We call $\Theta_{v,0}$ the *identity component*. The types of singular fibers are classified as follows ([7]):

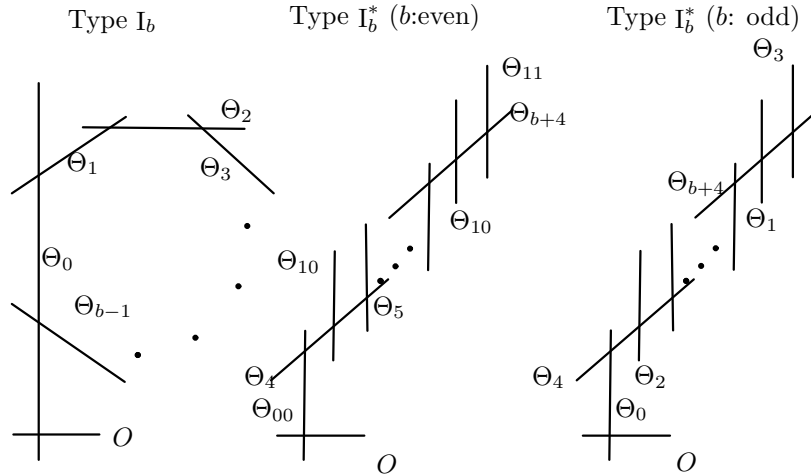

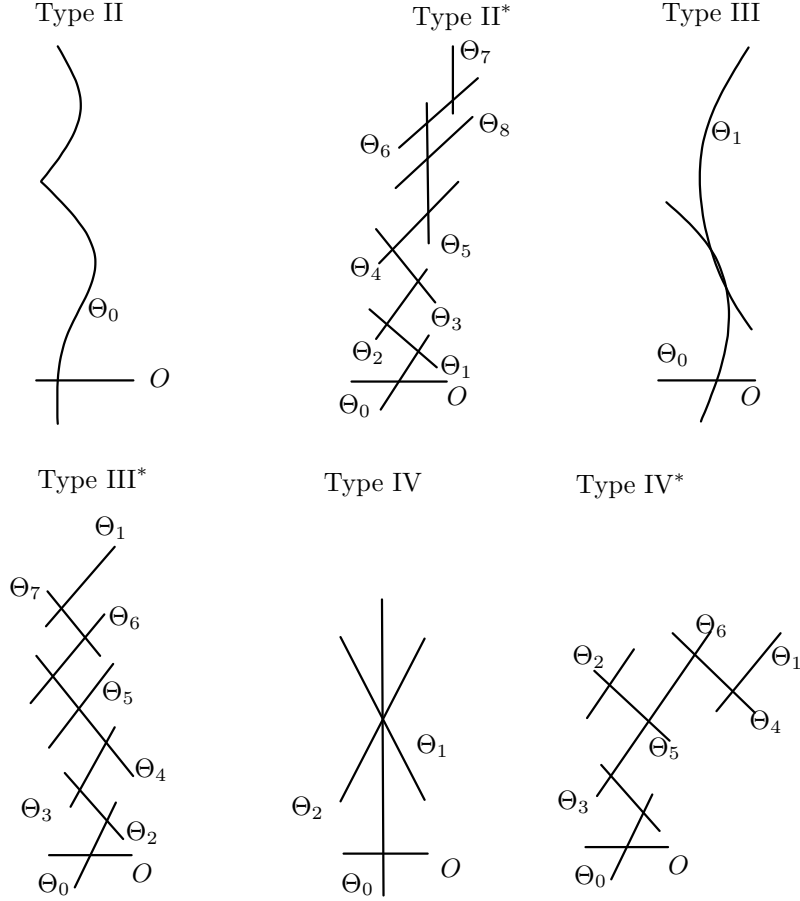

Note that every smooth irreducible component is a rational curve with self-intersection number -2 .

We also define a subset of $\text{Sing}(\varphi)$ by $\text{Red}(\varphi) := \{v \in \text{Sing}(\varphi) \mid F_v \text{ is reducible}\}$. Let $\text{MW}(S)$ be the set of sections of $\varphi : S \rightarrow C$. From our assumption, $\text{MW}(S) \neq \emptyset$. By regarding O as the zero element of $\text{MW}(S)$ and considering fiberwise addition (see [7, §9] or [21, §1] for the addition on singular fibers), $\text{MW}(S)$ becomes an abelian group. We denote its addition by $\dot{+}$.

Also for $k \in \mathbb{Z}$ and $s \in \text{MW}(S)$, we write

$$[k]s := \begin{cases} k\text{-times addition of } s & \text{if } k \geq 0 \\ k\text{-times addition of the inverse of } s & \text{if } k < 0. \end{cases}$$

Let $\text{NS}(S)$ be the Néron-Severi group of S and let T_φ be the subgroup of $\text{NS}(S)$ generated by O, F and $\Theta_{v,i}$ ($v \in \text{Red}(\varphi)$, $1 \leq i \leq m_v - 1$). Then we have the following theorems:

Theorem 2.1 [14, Theorem 1.2]) *Under our assumption, $\text{NS}(S)$ is torsion free.*

Theorem 2.2 ([14, Theorem 1.3]) *Under our assumption, there is a natural map $\tilde{\psi} : \text{NS}(S) \rightarrow \text{MW}(S)$ which induces an isomorphisms of groups*

$$\psi : \text{NS}(S)/T_\varphi \cong \text{MW}(S).$$

In particular, $\text{MW}(S)$ is a finitely generated abelian group.

In the following, by the rank, $\text{rank MW}(S)$, of $\text{MW}(S)$, we mean that of the free part of $\text{MW}(S)$. By Theorem 2.2, we may regard the addition of two sections in $\text{NS}(S)$ as that in $\text{MW}(S)$. We, however, use the notation \dagger in order to distinguish them. For a divisor on S , we put $s(D) = \psi(D)$. Then we have

Lemma 2.1 ([14, Lemma 5.1]) *D is uniquely written in the form:*

$$D \approx s(D) + (d-1)O + nF + \sum_{v \in \text{Red}(\varphi)} \sum_{i=1}^{m_v-1} b_{v,i} \Theta_{v,i},$$

where \approx denotes the algebraic equivalence of divisors, and d, n and $b_{v,i}$ are integers defined as follows:

$$d = DF \quad n = (d-1)\chi(\mathcal{O}_S) + OD - s(D)O,$$

and

$$\begin{pmatrix} b_{v,1} \\ \vdots \\ b_{v,m_v-1} \end{pmatrix} = A_v^{-1} \begin{pmatrix} D\Theta_{v,1} - s_D\Theta_{v,1} \\ \vdots \\ D\Theta_{v,m_v-1} - s_D\Theta_{v,m_v-1} \end{pmatrix}$$

Here A_v is the intersection matrix $(\Theta_{v,i}\Theta_{v,j})_{1 \leq i,j \leq m_v-1}$.

For a proof, see [14].

Put $\text{NS}_\mathbb{Q} := \text{NS}(S) \otimes \mathbb{Q}$ and $T_{\varphi,\mathbb{Q}} := T_\varphi \otimes \mathbb{Q}$. Since $\text{NS}(S)$ is torsion free under our setting, there is no harm in considering $\text{NS}_\mathbb{Q}$. By using the intersection pairing, we have the orthogonal decomposition $\text{NS}_\mathbb{Q} = T_{\varphi,\mathbb{Q}} \oplus (T_{\varphi,\mathbb{Q}})^\perp$. In [14], the homomorphism $\phi : \text{MW}(S) \rightarrow (T_{\varphi,\mathbb{Q}})^\perp \subset \text{NS}_\mathbb{Q}$ is defined as follows:

$$\begin{aligned} \phi : \text{MW}(S) \ni s &\mapsto s - O - (sO + \chi(\mathcal{O}_S))F \\ &+ \sum_{v \in \text{Red}(\varphi)} (\Theta_{v,1}, \dots, \Theta_{v,m_v-1})(-A_v)^{-1} \begin{pmatrix} s\Theta_{v,1} \\ \vdots \\ s\Theta_{v,m_v-1} \end{pmatrix} \in (T_{\varphi,\mathbb{Q}})^\perp. \end{aligned}$$

Also, in [14], a \mathbb{Q} -valued bilinear form \langle , \rangle on $\text{MW}(S)$ is defined by $\langle s_1, s_2 \rangle := -\phi(s_1)\phi(s_2)$, where the right hand side means the intersection pairing in $\text{NS}_\mathbb{Q}$. Here are two basic properties of \langle , \rangle :

- $\langle s, s \rangle \geq 0$ for $\forall s \in \text{MW}(S)$ and the equality holds if and only if s is an element of finite order in $\text{MW}(S)$.

- An explicit formula for $\langle s_1, s_2 \rangle$ ($s_1, s_2 \in \text{MW}(S)$) is given as follows:

$$\langle s_1, s_2 \rangle = \chi(\mathcal{O}_S) + s_1 O + s_2 O - s_1 s_2 - \sum_{v \in \text{Red}(\varphi)} \text{Contr}_v(s_1, s_2),$$

where $\text{Contr}_v(s_1, s_2)$ is given by

$$\text{Contr}_v(s_1, s_2) = (s_1 \Theta_{v,1}, \dots, s_1 \Theta_{v,m_v-1})(-A_v)^{-1} \begin{pmatrix} s_2 \Theta_{v,1} \\ \vdots \\ s_2 \Theta_{v,m_v-1} \end{pmatrix}.$$

As for explicit values of $\text{Contr}_v(s_1, s_2)$, we refer to [14, (8.16)].

2.2 Double cover construction of an elliptic surface

For details about this subsection, see [8, Lectures III and IV]. Let $\varphi : S \rightarrow C$ be an elliptic surface. By our assumption, the generic fiber of φ can be considered as an elliptic curve over $\mathbb{C}(C)$, the rational function field of C . The inverse morphism with respect to the group law induces an involution $[-1]_\varphi$ on S . Let $S/\langle [-1]_\varphi \rangle$ be the quotient by $[-1]_\varphi$. The quotient surface $S/\langle [-1]_\varphi \rangle$ is known to be smooth and $S/\langle [-1]_\varphi \rangle$ can be blown down to its relatively minimal model W over C satisfying the following condition:

Let us denote

- $f : S \rightarrow S/\langle [-1]_\varphi \rangle$: the quotient morphism,
- $q : S/\langle [-1]_\varphi \rangle \rightarrow W$: the blow down, and
- $S \xrightarrow{\mu} S' \xrightarrow{f'} W$: the Stein factorization of $q \circ f$.

Then we have:

1. The branch locus $\Delta_{f'}$ of f' consists of a section Δ_0 and the trisection T such that its singularities are at most simple singularities (see [4, Chapter II, §8] for simple singularities and their notation) and $\Delta_0 \cap T = \emptyset$.
2. $\Delta_0 + T$ is 2-divisible in $\text{Pic}(W)$.
3. The morphism μ is obtained by contracting all the irreducible components of singular fibers not meeting O .

Conversely, if Δ_0 and T on W satisfy the above condition, we obtain an elliptic surface $\varphi : S \rightarrow \mathbb{P}^1$, as the canonical resolution of a double cover $f' : S' \rightarrow W$ with $\Delta_{f'} = \Delta_0 + T$, and the diagram (see [6] for the canonical resolution):

$$\begin{array}{ccc} S' & \xleftarrow{\mu} & S \\ f' \downarrow & & \downarrow f \\ W & \xleftarrow{q} & \widehat{W}. \end{array}$$

Here q is a composition of blowing-ups so that $\widehat{W} = S/\langle [-1]_\varphi \rangle$. Hence any elliptic surface is obtained as above. In the following, we call the diagram above *the double cover diagram for S* .

In the case of $C = \mathbb{P}^1$, W is the Hirzebruch surface, Σ_d , of degree $d = 2\chi(\mathcal{O}_S)$ and $\Delta_{f'}$ is of the form $\Delta_0 + T$, where Δ_0 is a section with $\Delta_0^2 = -d$ and $T \sim 3(\Delta_0 + d\mathfrak{f})$, \mathfrak{f} being a fiber of the ruling $\Sigma_d \rightarrow \mathbb{P}^1$.

Remark 2.1 • For each $v \in \text{Sing}(\varphi)$, the type of $\varphi^{-1}(v)$ is determined by the type of singularity of T on \mathfrak{f}_v and the relative position between \mathfrak{f}_v and T (see [9, Table 6.2]).

- Note that the covering transformation, σ_f , of f coincides with $[-1]_\varphi$. Also, by [7, Theorem 9.1], the action of σ_f on irreducible components of singular fibers is described as follows:

Type of a singular fiber	The action on irreducible component
I_n	$\Theta_0 \mapsto \Theta_0$ $\Theta_i \mapsto \Theta_{n-i} \quad i = 1, \dots, n-1$
I_n^* ($n : \text{even}$)	$\Theta_i \mapsto \Theta_i \quad \forall i$ $\Theta_{ij} \mapsto \Theta_{ij} \quad \forall i, j$
I_n^* ($n : \text{odd}$)	$\Theta_i \mapsto \Theta_i \quad i \neq 1, 3$ $\Theta_1 \mapsto \Theta_3 \quad \Theta_3 \mapsto \Theta_1$
II, II*, III, III*	$\Theta_i \mapsto \Theta_i \quad \forall i$
IV	$\Theta_0 \mapsto \Theta_0$ $\Theta_1 \mapsto \Theta_2 \quad \Theta_2 \mapsto \Theta_1$
IV*	$\Theta_i \mapsto \Theta_i \quad i = 0, 3, 6$ $\Theta_1 \mapsto \Theta_2 \quad \Theta_2 \mapsto \Theta_1$ $\Theta_4 \mapsto \Theta_5 \quad \Theta_5 \mapsto \Theta_4$

3 Elliptic D_{2p} -cover over rational ruled surface

Let $\varphi : S \rightarrow \mathbb{P}^1$ be an elliptic surface over \mathbb{P}^1 . Let $S \rightarrow \widehat{\Sigma}_d$ be the double cover appearing in the double cover diagram for S in §2.2.

We first note that any elliptic D_{2p} -cover (p : odd prime) $\pi_p : X_p \rightarrow \widehat{\Sigma}_d$ satisfies the following conditions:

- $S = D(X_p/\widehat{\Sigma}_d)$ and $\beta_1(\pi_p) = f$.
- The branch locus of $\beta_2(\pi_p)$ is of the form

$$\mathcal{D} + \sigma_f^* \mathcal{D} + \Xi + \sigma_f^* \Xi$$

where

1. all irreducible components of \mathcal{D} are horizontal and there is no common component between \mathcal{D} and $\sigma_f^* \mathcal{D}$, and
2. all irreducible component of Ξ are vertical and there is no common component between Ξ and $\sigma_f^* \Xi$.

Remark 3.1 Under the above notation, the case when $\mathcal{D} = \emptyset$ (resp. $=$ a section) is considered in the author's previous work([15, 16, 17, 18]) (resp. [19]).

In the following, we always assume that

$$(*) \mathcal{D} \neq \emptyset.$$

The proposition below, which is a generalization of [19, Propositions 4.1 and 4.2], plays an important role in this article:

Theorem 3.1 *Let p be an odd prime. Let C_1, \dots, C_r be irreducible horizontal divisors on S such that $\sum_{i=1}^r C_i$ and $\sum_{i=1}^r \sigma_f^* C_i$ have no common component. Then (I) and (II) in the below are equivalent:*

(I) Put $\mathcal{C} = \sum_{i=1}^r C_i$. There exists an elliptic D_{2p} -cover $\pi_p : X_p \rightarrow \widehat{\Sigma}_d$ such that

- $D(X_p/\widehat{\Sigma}_d) = S$ and $\beta_1(\pi_p) = f$.
-

$$\Delta_{\beta_2(\pi_p)} = \text{Supp}(\mathcal{C} + \sigma_f^* \mathcal{C} + \Xi + \sigma_f^* \Xi)$$

where all irreducible components of Ξ are vertical and there is no common component between Ξ and $\sigma_f^* \Xi$.

(II) Let $s(C_i) = \tilde{\psi}(C_i)$ ($i = 1, \dots, r$). There exist integers a_i ($i = 1, \dots, r$) such that

- $1 \leq a_i < p$ ($i = 1, \dots, r$) and
-

$$\sum_{i=1}^r [a_i]s(C_i) \in [p]\text{MW}(S) := \{[p]s \mid s \in \text{MW}(S)\}.$$

Proof. (I) \Rightarrow (II) Let D be the effective divisor in Proposition 1.3. We put $D = D_{\text{hor}} + D_{\text{ver}}$, where the irreducible components of D_{hor} are all horizontal, while those of D_{ver} are all in fibers of φ . By Proposition 1.3 (iv), $(D_{\text{hor}} + \sigma_f^* D_{\text{hor}})_{\text{red}} = \sum_{i=1}^r C_i + \sum_{i=1}^r \sigma_f^* C_i$.

Claim. We may assume that $D_{\text{hor}} = \sum_{i=1}^r a_i C_i$.

Proof of Claim. If $\sigma_f^* C_i$ is an irreducible component of D_{hor} , then we consider

$$D'_{\text{hor}} := D_{\text{hor}} + (p - a_i)C_i - a_i \sigma_f^* C_i,$$

and put $D' = D'_{\text{hor}} + D_{\text{ver}}$. Then we infer that D' also satisfies all four conditions in Proposition 1.3. After repeating this process finitely many times, we may assume that $D_{\text{hor}} = \sum_{i=1}^r a_i C_i$.

By Claim and Proposition 1.3 (iii), there exists $\mathcal{L} \in \text{Pic}(S)$ such that

$$\sum_{i=1}^r a_i(C_i - \sigma_f^* C_i) + D_{\text{ver}} - \sigma_f^* D_{\text{ver}} \sim p\mathcal{L},$$

where \sim means linear equivalence of divisors (Note that linear equivalence coincides with algebraic equivalence on S). This implies

$$\tilde{\psi}\left(\sum_{i=1}^r a_i(C_i - \sigma_f^* C_i)\right) = [p]\tilde{\psi}(\mathcal{L}) \quad \text{in MW}(S).$$

As $\tilde{\psi}(\sigma_f^* C_i) = [-1]s(C_i)$, we have

$$\tilde{\psi}\left(\sum_{i=1}^r a_i(C_i - \sigma_f^* C_i)\right) = [2]([a_1]s(C_1) \dot{+} \dots \dot{+} [a_r]s(C_r)).$$

Since p is an odd prime, we infer that $[a_1]s(C_1) \dot{+} \dots \dot{+} [a_r]s(C_r) \in [p]\text{MW}(S)$.

(II) \Rightarrow (I) Our proof is similar to that of [19, Proposition 4.2]. By Lemma 2.1, we have

$$C_i \sim s(C_i) + (d_i - 1)O + n_i F + \sum_{v \in \text{Red}(\varphi)} \sum_{j=1}^{m_v-1} b_{v,j}^{(i)} \Theta_{v,i}.$$

This implies

$$\sum_{i=1}^r a_i C_i \sim \sum_{i=1}^r a_i s(C_i) + \sum_{i=1}^r a_i \left((d_i - 1)O + n_i F + \sum_{v \in \text{Red}(\varphi)} \sum_{j=1}^{m_v-1} b_{v,j}^{(i)} \Theta_{v,j} \right).$$

By our assumption, there exists s_o such that $\sum_{i=1}^r [a_i]s(C_i) = [p]s_o$ in $\text{MW}(S)$. By Theorem 2.2, this implies that

$$\sum_{i=1}^r a_i s(C_i) \sim p s_o + \left(-p + \sum_{i=1}^r a_i \right) O + n_o F + \sum_{v \in \text{Red}(\varphi)} \sum_{j=1}^{m_v-1} c_{v,j} \Theta_{v,j}$$

for some integers $n_o, c_{v,j}$. Hence we have

$$\begin{aligned} \sum_{i=1}^r a_i C_i &\sim p s_o + \left(-p + \sum_{i=1}^r a_i d_i \right) O + \left(n_o + \sum_i a_i n_i \right) F \\ &\quad + \sum_{v \in \text{Red}(\varphi)} \sum_{j=1}^{m_v-1} \left(c_{v,j} + \sum_{i=1}^r a_i b_{v,j}^{(i)} \right) \Theta_{v,j}, \end{aligned}$$

and put

$$D' := \sum_{i=1}^r a_i C_i + \sum_{v \in \text{Red}(\varphi)} \sum_{j=1}^{m_v-1} \left(c_{v,j} + \sum_{i=1}^r a_i b_{v,j}^{(i)} \right) \sigma_f^* \Theta_{v,j}.$$

Then we have

$$D' - \sigma_f^* D' \sim p (s_o - \sigma_f^* s_o).$$

The left hand side of the above equivalence contains some redundancy in the sum for $\Theta_{v,i}$ and $\sigma_f^* \Theta_{v,i}$. By taking the action of σ_f on $\Theta_{v,i}$'s (see Remark 2.1) into account, we can find a divisor $D = \sum_{i=1}^r a_i C_i + \sum_j k_j \Xi_j$ and Ξ' on S such that

- (i) all Ξ_j and all irreducible components of Ξ' are those in fibers not meeting O ,
- (ii) D and σ_f^*D have no common component,
- (iii) $1 \leq k_j < p$, and
- (iv) $D' - \sigma_f^*D' = D - \sigma_f^*D + p\Xi'$.

Now we easily infer that D satisfies the three conditions in Proposition 1.2 for p . \square

Fix an isomorphism $\text{MW}(S) = M_o \oplus \text{MW}_{\text{tor}}$, $M_o \cong \mathbb{Z}^{\oplus r}$, $r = \text{rank MW}(S)$. By Theorem 3.1, we have the following proposition:

Proposition 3.1 *Choose $s \in M_o$ such that $M_o/\mathbb{Z}s$ is free. For any finite number of odd prime numbers p_1, \dots, p_l , there exists a section s_{p_1, \dots, p_l} satisfying the following conditions:*

- (i) $\langle s_{p_1, \dots, p_l}, s_{p_1, \dots, p_l} \rangle = (p_1 \cdots p_l)^2 \langle s, s \rangle$.
- (ii) *For any prime $p \notin \{p_1, \dots, p_l\}$, there exists an elliptic D_{2p} -cover $\pi_p : X_p \rightarrow \widehat{\Sigma}_d$ such that*
 - $D(X_p/\widehat{\Sigma}_d) = S$, $\beta_1(\pi_p) = f$, and
 - $\beta_2(\pi_p)$ is branched at $p(s + s_{p_1, \dots, p_l} + \sigma_f^*(s + s_{p_1, \dots, p_l}) + \Xi_o)$, where all irreducible components of Ξ_o are those in fibers not meeting O .
- (iii) *For $p \in \{p_1, \dots, p_l\}$, there exists no elliptic D_{2p} -cover $\pi_p : X_p \rightarrow \widehat{\Sigma}_d$ as in (ii)*
- (iv) $\{s_{p_1, \dots, p_l}, [-1]s_{p_1, \dots, p_l}\}$ is unique up to torsion elements.

Proof. Define $s_{p_1, \dots, p_l} := [\prod_{i=1}^l p_i]s$. By Theorem 3.1, our statements (i), (ii) and (iii) are immediate. Suppose that $s' \in \text{MW}(S)$ satisfies the statements (i), (ii) and (iii). Put $s' = s'_o + t'_o$, $s'_o \in M_o, t'_o \in \text{MW}_{\text{tor}}$. By Theorem 3.1, for $p \notin \{p_1, \dots, p_l\}$, there exists an integer k ($1 \leq k < p$) such that

$$s \dot{+} [k]s'_o = 0$$

in M_o/pM_o . This implies that there exist integers l and l' with $\gcd(l, l') = 1$ such that $[l]s \dot{+} [l']s'_o = 0$ in $\text{MW}(S)$. Choose integers m, m' with $ml + m'l' = 1$. Then

$$0 = [m]([l]s \dot{+} [l']s'_o) = s \dot{+} [-m'l']s \dot{+} [ml']s'_o = s \dot{+} [l']([-m'l]s + [m]s'_o).$$

Since $M_o/\mathbb{Z}s$ is free, we infer that $l' = 1$ and $s'_o = [-l]s$. Thus

$$\langle s'_o, s'_o \rangle = l^2 \langle s_o, s_o \rangle = (p_1 \cdots p_l)^2 \langle s, s \rangle.$$

Since $\langle s, s \rangle \neq 0$ by the basic properties of \langle, \rangle (see §1), we have $l = \pm p_1 \cdots p_l$. Hence s' is equal to $[\pm 1]s_{p_1, \dots, p_l}$ up to torsion elements. \square

4 Applications

Let $\varphi : S \rightarrow \mathbb{P}^1$ be an elliptic surface and we keep our notation for the double cover construction for S in §2.2. We fix an isomorphism $\text{MW}(S) \cong M_o \oplus \text{MW}_{\text{tor}}$ $M_o \cong \mathbb{Z}^{\oplus r}$, $r = \text{rank MW}(S)$. Choose $s_1, s_2 \in M_o$ so that s_1 and s_2 are a part of a basis of $\mathbb{Z}^{\oplus r}$, i.e., $M_o/\mathbb{Z}s_1 + \mathbb{Z}s_2$ is free of rank $r - 2$. Put $s_3 := [2]s_1$.

Theorem 4.1 *For any odd prime p , there exists an elliptic D_{2p} -cover $\pi_p : X_p \rightarrow \widehat{\Sigma}_d$ such that the horizontal part of the branch locus, $\Delta_{\beta_2(\pi_p)}$, of $\beta_2(\pi_p)$ is of the form*

$$s_1 + s_3 + \sigma_f^*(s_1 + s_3),$$

while there exists no elliptic D_{2p} -cover $\pi_p : X_p \rightarrow \widehat{\Sigma}_d$ such that the horizontal part of the branch locus of $\beta_2(\pi_p)$ is $s_2 + s_3 + \sigma_f^(s_2 + s_3)$*

Proof. Since $[p - 2]s_1 + s_3 \in [p] \text{MW}(S)$, we have the first statement by Theorem 3.1. Since s_1 and s_2 are a part of basis, their image in M_o/pM_o are linearly independent over $\mathbb{Z}/p\mathbb{Z}$. Hence our second statement follows from Theorem 3.1. \square

By Proposition 1.1 and Theorem 3.1, we have

Corollary 4.1 *Let T be the trisection on Σ_d appearing in the double cover diagram for S . Put $\Delta_i := q \circ f(s_i)$ ($i = 1, 2, 3$). Then there exists a D_{2p} -cover of Σ_d branched at $2(\Delta_0 + T) + p(\Delta_1 + \Delta_3)$, while there exists no D_{2p} -cover of Σ_d branched at $2(\Delta_0 + T) + p(\Delta_2 + \Delta_3)$.*

We end this section by considering the case when S is a rational elliptic surface. In this case, we have the double cover diagram for S as follows:

$$\begin{array}{ccc} S' & \xleftarrow{\mu} & S \\ f' \downarrow & & \downarrow f \\ \Sigma_2 & \xleftarrow{q} & \widehat{\Sigma}_2. \end{array}$$

Write $q := q_1 \circ \dots \circ q_r : \widehat{\Sigma}_2 = \Sigma_2^{(r)} \rightarrow \dots \rightarrow \Sigma_2^{(1)} \rightarrow \Sigma_2^{(0)} = \Sigma_2$, where q_i is a blowing up at a point at $\Sigma_2^{(i-1)}$. Put $\Delta_{f'} = \Delta_0 + T$. In the following, we assume that

T has a node x_o .

Note that this is equivalent to the fact that S has a singular fiber of type I_2 or II by [9, Table 6.2]. We may assume that q_1 is a blowing up at x_o . Let E_1 be the exceptional divisor of q_1 and let \widehat{f}_o and \overline{T} be the proper transforms of a fiber, f_o , through x_o and T , respectively. Then we have the following picture:

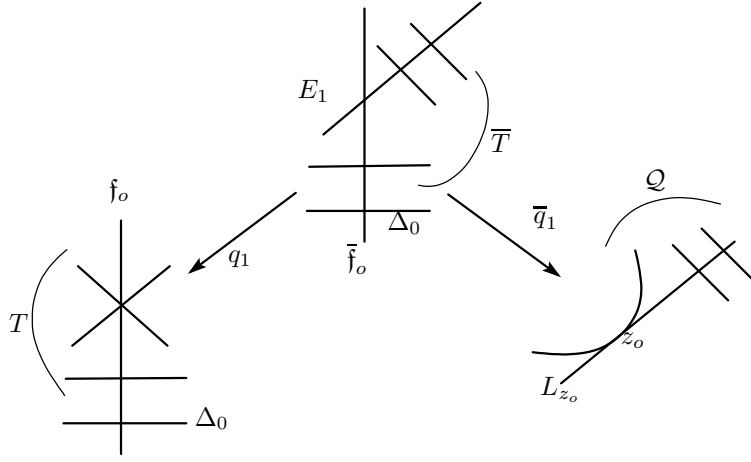

The case (a)

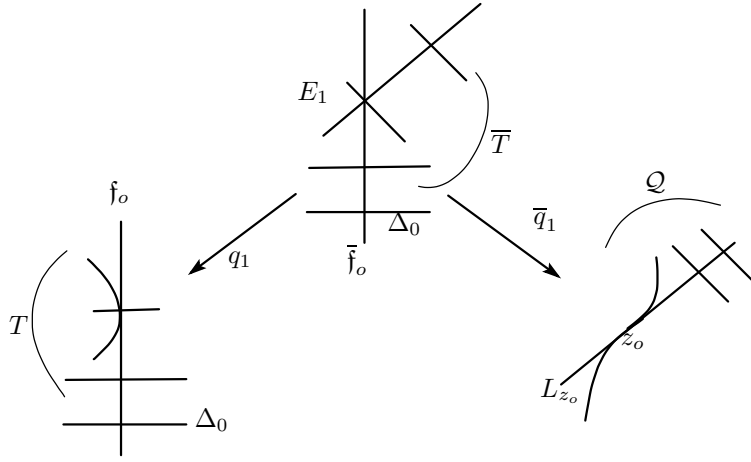

The case (b)

Note that if f_o meets both of the local branches of T at x_o transversely, we have the case (a), while if f_o is tangent to one of the local branches of T at x_o , we have the case (b).

Blow down \bar{f}_o and Δ_0 in this order. Then the resulting surface is \mathbb{P}^2 . We denote this composition of blowing downs by $\bar{q}_1 : \Sigma_2^{(1)} \rightarrow \mathbb{P}^2$ and put $\mathcal{Q} := \bar{q}_1(T)$. Then \mathcal{Q} is a reduced quartic with the distinguished point $z_o := \bar{q}_1(f_o \cup \Delta_0)$. Note that $\bar{q}_1(E_1)$ is the tangent line L_{z_o} of \mathcal{Q} at z_o . Put $\bar{q} := \bar{q}_1 \circ q_2 \circ \dots \circ q_r$ and we have the following diagram:

$$\begin{array}{ccc}
 S'' & \xleftarrow{\bar{\mu}} & S \\
 f'' \downarrow & & \downarrow f \\
 \mathbb{P}^2 & \xleftarrow{\bar{q}} & \widehat{\Sigma}_2.
 \end{array}$$

Here S'' is the Stein factorization of $\bar{q} \circ f$. Note that S'' is a double cover with branch locus \mathcal{Q} and that the pencil of lines through z_o gives rise to the elliptic fibration of S . Now we have the following proposition.

Proposition 4.1 *Let s_1, s_2 and s_3 be sections as in the beginning of this section and put $C_i := \bar{q}(s_i)$ ($i = 1, 2, 3$). If $(\mathcal{Q} + C_1 + C_3)$ and $(\mathcal{Q} + C_2 + C_3)$ have the same combinatorics, then $(\mathcal{Q} + C_1 + C_3, \mathcal{Q} + C_2 + C_3)$ is a Zariski pair.*

Proof. Our statement is immediate from Proposition 1.1, Theorem 4.1 and the following lemma. \square

Lemma 4.1 *Let p be an odd prime. For $i = 1, 2$, there exists a D_{2p} -cover $\varpi_p : \mathcal{X}_p \rightarrow \mathbb{P}^2$ of \mathbb{P}^2 branched at $2\mathcal{Q} + p(C_i + C_3)$ if and only if there exists an elliptic D_{2p} -cover $\pi_p : X_p \rightarrow \widehat{\Sigma}_2$ of $\widehat{\Sigma}_2$ such that the horizontal part of $\Delta_{\beta_2(\pi_p)}$ is $s_i + s_3 + \sigma_f^*(s_i + s_3)$.*

Proof. Suppose that there exists a D_{2p} -cover $\varpi_p : \mathcal{X}_p \rightarrow \mathbb{P}^2$ branched at $2\mathcal{Q} + p(C_i + C_3)$. Let $\varpi_p^{(i)} : \mathcal{X}_p^{(i)} \rightarrow \Sigma_2^{(i)}$ be the induced D_{2p} -cover, i.e., $\mathcal{X}_p^{(i)}$ is the $\mathbb{C}(\mathcal{X}_p)$ -normalization of $\Sigma_2^{(i)}$. Since $D(\mathcal{X}_p/\mathbb{P}^2) = S''$ and $\beta_1(\varpi_p) = f''$, $D(\mathcal{X}_p^{(1)}/\Sigma_2^{(1)})$ is the $\mathbb{C}(S'')$ -normalization of $\Sigma_2^{(1)}$. Hence $\Delta_{\beta_1(\varpi_p^{(1)})} = \Delta_0 + \bar{T}$ as $\bar{q}_1^* \mathcal{Q} = \Delta_0 + \bar{T} + 2\tilde{f}_o$. This implies that $D(\mathcal{X}_p^{(r)}/\widehat{\Sigma}_2) = S$ and $\beta_1(\varpi_p^{(r)}) = f$. As $C_i = \bar{q} \circ f(s_i)$ ($i = 1, 2, 3$), $\varpi_p^{(r)} : \mathcal{X}_p^{(r)} \rightarrow \widehat{\Sigma}_2$ is an elliptic D_{2p} -cover such that the horizontal part of $\Delta_{\beta_2(\varpi_p^{(r)})}$ is $s_i + s_3 + \sigma_f^*(s_i + s_3)$.

Conversely, suppose that there exists an elliptic D_{2p} -cover $\pi_p : X_p \rightarrow \widehat{\Sigma}_2$ such that the horizontal part of $\Delta_{\beta_2(\pi_p)}$ is $s_i + s_3 + \sigma_f^*(s_i + s_3)$. Since E_1 gives rise to an irreducible component “ Θ_1 ” of singular fiber of type I_2 or II , the preimage of E_1 in $\widehat{\Sigma}_2$ is not contained in the branch locus of π_p by Corollary 1.1 and Remark 2.1. Now let \overline{X}_p be the Stein factorization of $\bar{q} \circ \pi_p$. Then the induced D_{2p} -cover $\overline{\pi}_p : \overline{X}_p \rightarrow \mathbb{P}^2$ is branched at $2\mathcal{Q} + p(C_i + C_3)$. \square

5 Proof of Theorem 0.1

Proof of Theorem 0.1 (i). Put $\mathcal{Q} = C_1 + L_1 + L_2$ and choose a point $z_o \in C_1 \cap C_2$ as the distinguished point. Let $f''_{\mathcal{Q}} : S''_{\mathcal{Q}} \rightarrow \mathbb{P}^2$ be a double cover with branch locus \mathcal{Q} and let $\varphi_{z_o} : S_{(\mathcal{Q}, z_o)} \rightarrow \mathbb{P}^1$ be the rational elliptic surface as in §4. By our construction of $S_{\mathcal{Q}, z_o}$, both L_3 and L_4 give rise to sections, which we denote by $s_{L_i}^+$ and $s_{L_i}^- (= \sigma_f^* s_{L_i}^+ = [-1]s_{L_i})$ ($i = 3, 4$), respectively. By labeling singular fibers suitably, we may assume that $s_{L_i}^+$ ($i = 3, 4$) and reducible singular fibers meet as in the following picture:

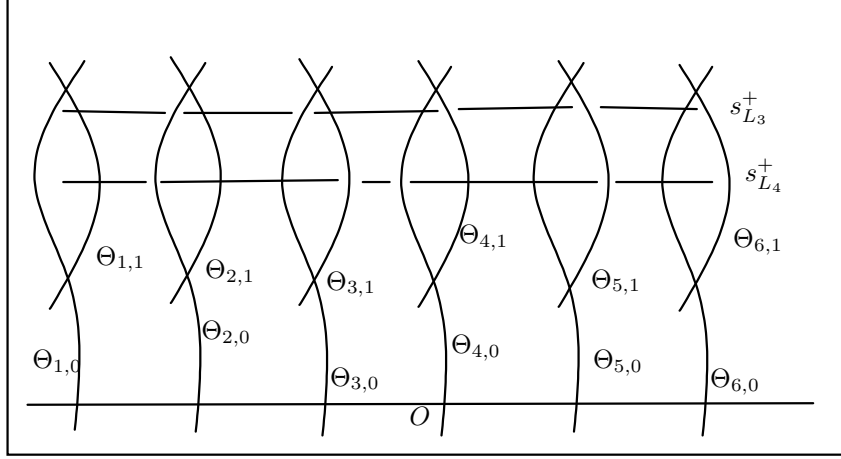

Here we assume that $\Theta_{1,0}$ and O come from z_o . By the explicit formula of $\langle \cdot, \cdot \rangle$, we have

$$\langle s_{L_i}^\pm, s_{L_i}^\pm \rangle = \frac{1}{2}, (i = 3, 4) \quad \langle s_{L_3}^+, s_{L_4}^+ \rangle = 0.$$

By [11], $\text{MW}(S_{(\mathcal{Q}, z_o)}) \cong (A_1^*)^{\oplus 2} \oplus (\mathbb{Z}/2\mathbb{Z})^{\oplus 2}$ and we may assume that

$$(A_1^*)^{\oplus 2} \cong \mathbb{Z}s_{L_3}^+ \oplus \mathbb{Z}s_{L_4}^+,$$

and that the 2-torsions sections arise from C_1, L_1 and L_2 .

As for $(\bar{q} \circ f)^*(C_2)$, it also gives rise to two sections $s_{C_2}^\pm$. Since C_2 does not pass through any singularities of $C_1 + L_1 + L_2$ and $s_{C_2}^\pm O = 0$, we have $\langle s_{C_2}^\pm, s_{C_2}^\pm \rangle = 2$.

On the other hand, any element $s \in \text{MW}(S_{(\mathcal{Q}, z_o)})$ with $\langle s, s \rangle = 2$ is of the form

$$[2]s_{L_i}^\pm + \tau, \quad (i = 3, 4) \quad \tau \in \text{MW}(S_{(\mathcal{Q}, z_o)})_{\text{tor}}.$$

If $\tau \neq 0$, then $s_{C_2}^\pm$ meets $\Theta_{i,1}$ for some i by considering the addition on singular fibers (see [7, Theorem 9.1] or [21, §1]). Hence, by the explicit formula for $\langle \cdot, \cdot \rangle$, we have $s_{C_2}^\pm O \neq 0$. On the other hand, $s_{C_2}^\pm O = 0$ by our construction. Thus we infer $\tau = 0$ and we may assume that $s_{C_2}^\pm = [2]s_{L_3}^\pm$ after relabeling \pm, L_3 and L_4 , if necessary. Therefore

$$s_{C_2}^\pm + [p-2]s_{L_3}^\pm \in [p] \text{MW}(S_{(\mathcal{Q}, z_o)})$$

for any odd prime p , while

$$s_{C_2}^\pm + [k]s_{L_4}^\pm \notin [p] \text{MW}(S_{(\mathcal{Q}, z_o)})$$

for any odd prime p and $1 \leq k \leq p-1$. By Proposition 4.1, we infer that $(C_1 + C_2 + L_1 + L_2 + L_3, C_1 + C_2 + L_1 + L_2 + L_4)$ is a Zariski pair. \square

Proof for Theorem 0.1 (ii). Put $\mathcal{Q} = C_1 + C_2$ and choose a point $z_o \in C_1 \cap C_3$ as the distinguished point. Let $f''_{\mathcal{Q}} : S''_{\mathcal{Q}} \rightarrow \mathbb{P}^2$ be a double cover with branch locus \mathcal{Q} and let

$\varphi_{z_o} : S_{(\mathcal{Q}, z_o)} \rightarrow \mathbb{P}^1$ be the rational elliptic surface as in §4. By our construction of $S_{\mathcal{Q}, z_o}$, L_0 , L_1 and L_2 give rise to sections, which we denote by $s_{L_i}^+$ and $s_{L_i}^- (= \sigma_f^* s_{L_i}^+ = [-1]s_{L_i}^+)$ ($i = 0, 1, 2$), respectively. By labeling singular fibers suitably, we may assume that $s_{L_i}^+$ ($i = 0, 1, 2$) and reducible singular fibers meet as in the following picture:

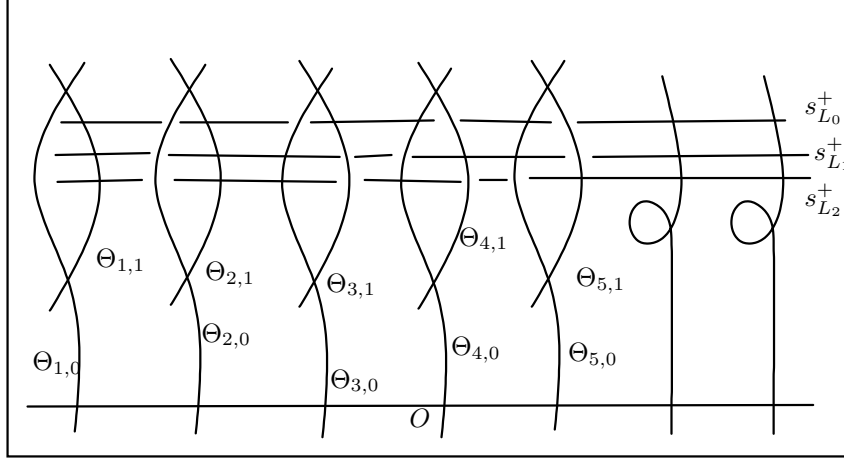

Here we assume that $\Theta_{1,0}$ and O come from z_o . By the explicit formula of $\langle \cdot, \cdot \rangle$, we have

$$\langle s_{L_i}^\pm, s_{L_i}^\pm \rangle = \frac{1}{2}, \quad (i = 0, 1, 2) \quad \langle s_{L_i}^+, s_{L_j}^+ \rangle = 0. \quad (i, j = 0, 1, 2, i \neq j)$$

By [11], $\text{MW}(S_{(\mathcal{Q}, z_o)}) \cong (A_1^*)^{\oplus 3} \oplus (\mathbb{Z}/2\mathbb{Z})$ and we may assume that

$$(A_1^*)^{\oplus 2} \cong \mathbb{Z}s_{L_0}^+ \oplus \mathbb{Z}s_{L_1}^+ \oplus \mathbb{Z}s_{L_2}^+,$$

and that the unique 2-torsion section arises from C_1 .

By [7, Theorem 9.1], $[2]s_{L_i}^\pm$ ($i = 0, 1, 2$) meet the identity component at each singular fiber. Hence by the explicit formula for $\langle \cdot, \cdot \rangle$, we have $[2]s_{L_i}^\pm O = 0$ for each i . This implies that, for each i , $C_{L_i} := \bar{q} \circ f([2]s_{L_i}^\pm)$ is a conic not passing through P_j ($j = 1, 2, 3, 4$). If C_{L_i} and $C_1 + C_3$ has an intersection point at which intersection multiplicity is odd, then we easily see that the closure of $(\bar{q} \circ f)^{-1}(C_{L_i} \setminus z_o)$ is irreducible. This is impossible, as C_{L_i} is the image of $[2]s_{L_i}^\pm$. Hence we have three conic satisfying the first two conditions.

Conversely, suppose that there exists a conic C_o satisfying the first two conditions. We infer that C_o gives rise to two sections $s_{C_o}^\pm$. Since C_o does not pass through any singularities of $C_1 + C_2$ and $s_{C_o}^\pm O = 0$, we have $\langle s_{C_o}^\pm, s_{C_o}^\pm \rangle = 2$. On the other hand, any element $s \in \text{MW}(S_{(\mathcal{Q}, z_o)})$ with $\langle s, s \rangle = 2$ is of the form

$$[2]s_{L_i}^\pm + \tau, \quad (i = 0, 1, 2) \quad \tau \in \text{MW}(S_{(\mathcal{Q}, z_o)})_{\text{tor}}.$$

By a similar argument to that in the case of Line-conic arrangement 1, we infer $\tau = 0$. Hence we infer that C_{L_i} are all conics satisfying the first two conditions. Now put $C_3^{(i)} := C_{L_i}$, $s_{C_3^{(i)}} := [2]s_{L_i}^\pm$ ($i = 1, 2$). For $(i, j) = (1, 2), (2, 1)$, we have

$$s_{C_3^{(i)}} + [p-2]s_{L_i}^+ \in [p] \text{MW}(S_{(\mathcal{Q}, z_o)})$$

for any odd prime p , while

$$s_{C_3^{(i)}} + [k]s_{L_j}^+ \notin [p] \text{MW}(S_{(\mathcal{Q}, z_o)})$$

for any odd prime p and $1 \leq k \leq p-1$.

By Proposition 4.1, if both of $C_1 + C_2 + C_3^{(i)} + L_1$ and $C_1 + C_2 + C_3^{(i)} + L_2$ have the combinatorics for Line-conic arrangement 2 of the same type, then $(C_1 + C_2 + C_3^{(i)} + L_1, C_1 + C_2 + C_3^{(i)} + L_2)$ is a Zariski pair for each $i = 1, 2$. \square

Remark 5.1 Let B be the line-conic arrangement as in Theorem 0.1. By Corollary 1.1, if there exists a D_{2p} -cover $\pi : X \rightarrow \mathbb{P}^2$ with branch locus B , then $\Delta_{\beta_1(\pi)} = L_1 + L_2 + C_1$ (resp. $C_1 + C_2$) for Line-conic arrangement 1 (resp. 2). This means that the D_{2p} -covers in our proof of Theorem 0.1 are only possible ones. Therefore for the fundamental group $\pi_1(\mathbb{P}^2 \setminus B, *)$, we infer that

$$\pi_1(\mathbb{P}^2 \setminus (L_1 + L_2 + L_3 + C_1 + C_2), *) \not\cong \pi_1(\mathbb{P}^2 \setminus (L_1 + L_2 + L_4 + C_1 + C_2), *)$$

for Line-conic arrangement 1, and

$$\pi_1(\mathbb{P}^2 \setminus (L_1 + C_1 + C_2 + C_3^{(i)}), *) \not\cong \pi_1(\mathbb{P}^2 \setminus (L_2 + C_1 + C_2 + C_3^{(i)}), *)$$

for Line-conic arrangement 2.

Example 5.1 Let $[T, X, Z]$ be homogeneous coordinates of \mathbb{P}^2 and let $(t, x) := (T/Z, X/Z)$ be affine coordinates of \mathbb{P}^2 and consider a conic and four lines as follows:

$$\begin{aligned} C_1 : x - t^2 = 0, & \quad L_1 : x - 3t + 2 = 0, & \quad L_2 : x + 3t + 2 = 0, \\ L_3 : x - t - 2 = 0, & \quad L_4 : x - 1 = 0. \end{aligned}$$

Note that $C_1 \cap (L_1 \cup L_2) = \{[\pm 1, 1, 1], [\pm 2, 4, 1]\}$. Put $\mathcal{Q} = C_1 + L_1 + L_2$ and choose $[0, 1, 0]$ as the distinguished point z_o . Let $S_{(\mathcal{Q}, z_o)}$ be the rational elliptic surface obtained as in §4. Then its generic fiber is an elliptic curve over $\mathbb{C}(t)$ given by the Weierstrass equation:

$$y^2 = (x - t^2)(x - 3t + 2)(x + 3t + 2).$$

Under this setting, we may assume that the sections $s_{L_i}^\pm$ ($i = 3, 4$) are as follows:

$$s_{L_3}^\pm = (t + 2, \pm 2\sqrt{2}(t - 2)(t + 1)) \quad s_{L_4}^\pm = (1, \pm 3(t + 1)(t - 1)).$$

Hence we have

$$[2]s_{L_3}^+ = \left(\frac{9}{8}t^2, \frac{1}{32}t\sqrt{2}(9t^2 - 16)\right), \quad [2]s_{L_4}^+ = \left(t^2 + \frac{1}{4}, \frac{1}{2}t^2 - \frac{9}{8}\right)$$

Now put

$$C_2 : x - \frac{9}{8}t^2 = 0, \quad C_2' : x - t^2 - \frac{1}{4} = 0.$$

Then $(\mathcal{Q} + C_2 + L_3, \mathcal{Q} + C_2 + L_4)$ is a Zariski pair for Line-conic arrangement 1 of type (a), and $(\mathcal{Q} + C_2' + L_3, \mathcal{Q} + C_2' + L_4)$ is a Zariski pair for Line-conic arrangement 1 of type (b).

Example 5.2 We keep the same coordinates as Example 5.1.

Line-conic arrangement 2 of type (a). Consider two conics and two lines:

$$\begin{aligned} C_1 : x - t^2 + 2 = 0, & \quad C_2 : x^2 - 2x + t^2 - 4 = 0, \\ L_1 : x - t = 0, & \quad L_2 : x - 3t + 4 = 0. \end{aligned}$$

Note that $C_1 \cap C_2 = \{[\pm 2, 2, 1], [\pm 1, -1, 1]\}$. Put $\mathcal{Q} = C_1 + C_2$ and choose $[0, 1, 0]$ as the distinguished point z_o . Let $S_{(\mathcal{Q}, z_o)}$ be the rational elliptic surface obtained as before. Then its generic fiber is an elliptic curve over $\mathbb{C}(t)$ given by the Weierstrass equation:

$$y^2 = (x - t^2 + 2)(x^2 - 2x + t^2 - 4).$$

Then we may assume that the sections $s_{L_2}^\pm (i = 1, 2)$ are as follows:

$$s_{L_1}^\pm = (t, \pm\sqrt{-2}(t+1)(t-2)), \quad s_{L_2}^\pm = (3t-4, \pm\sqrt{-10}(t-1)(t-2)).$$

Thus we have

$$[2]s_{L_1}^+ = \left(\frac{1}{2}t^2 - 2, -\frac{1}{4}\sqrt{-2}t(t^2 - 4)\right), \quad [2]s_{L_2}^+ = \left(\frac{1}{10}t^2 - 2, -\frac{3}{100}\sqrt{-10}t(t^2 + 20)\right).$$

Now we put

$$C_3 : x - \frac{1}{2}t^2 + 2 = 0, \quad C'_3 : x - \frac{1}{10}t^2 + 2 = 0$$

Then both $(\mathcal{Q} + C_3 + L_1, \mathcal{Q} + C_3 + L_2)$ and $(\mathcal{Q} + C'_3 + L_1, \mathcal{Q} + C'_3 + L_2)$ are Zariski pairs for Line-conic arrangement 2 of type (a).

Line-conic arrangement 2 of type (b). Consider two conics and two lines:

$$\begin{aligned} C_1 : x - t^2 + 2 = 0, & \quad C_2 : x^2 - 2x + t^2 - 4 = 0, \\ L_1 : x - t = 0, & \quad L_2 : x + 1 = 0. \end{aligned}$$

Put $\mathcal{Q} = C_1 + C_2$ and choose $[0, 1, 0]$ as the distinguished point z_o . Let $S_{(\mathcal{Q}, z_o)}$ be the rational elliptic surface obtained as before. Then its generic fiber is an elliptic curve over $\mathbb{C}(t)$ given by the Weierstrass equation:

$$y^2 = (x - t^2 + 2)(x^2 - 2x + t^2 - 4).$$

Then we may assume that the sections $s_{L_2}^\pm (i = 1, 2)$ is as follows:

$$s_{L_2}^\pm = (-1, \pm\sqrt{-1}(t-1)(t+1)).$$

Thus we have

$$[2]s_{L_2}^+ = \left(t^2 - \frac{17}{4}, \frac{3}{8}\sqrt{-1}(4t^2 - 19)\right).$$

Now we put

$$C_3 : x - t^2 + \frac{17}{4} = 0.$$

As C_3 is tangent to C_1 (resp. C_2) at one point (resp. two distinct points), we infer that $(\mathcal{Q} + C_3 + L_1, \mathcal{Q} + C_3 + L_2)$ is a Zariski pair for Line-conic arrangement 2 of type (b).

Line-conic arrangement 2 of type (c). Consider two conics and two lines:

$$\begin{aligned} C_1 : x - t^2 + \frac{1}{2} = 0, & \quad C_2 : x^2 - x + t^2 = 0, \\ L_1 : x = \frac{1}{\sqrt{2}}, & \quad L_2 : \frac{\sqrt{2}}{4} (\sqrt{-1}c_1 - c_2) x + t - \frac{1}{4} (\sqrt{-1}c_1 + c_2) = 0, \end{aligned}$$

where $c_1 = \sqrt{2 + 2\sqrt{2}}$, $c_2 = \sqrt{-2 + 2\sqrt{2}}$. Note that

$$C_1 \cap C_2 = \left\{ \left[\pm \sqrt{-1/2 + 1/\sqrt{2}}, 1/\sqrt{2}, 1 \right], \left[\pm \sqrt{-1/2 - 1/\sqrt{2}}, -1/\sqrt{2}, 1 \right] \right\}.$$

Put $\mathcal{Q} = C_1 + C_2$ and choose $[0, 1, 0]$ as the distinguished point z_o . Let $S_{(\mathcal{Q}, z_o)}$ be the rational elliptic surface obtained as before. Then its generic fiber is an elliptic curve over $\mathbb{C}(t)$ given by the Weierstrass equation:

$$y^2 = \left(x - t^2 - \frac{1}{2} \right) (x^2 - x + t^2).$$

Then we may assume that the sections $s_{L_1}^\pm$ are as follows:

$$s_{L_1}^\pm = \left(\frac{1}{\sqrt{2}}, \pm \frac{\sqrt{-1}}{2} (-2t^2 - 1 + \sqrt{2}) \right).$$

Thus we have

$$[2]s_{L_1}^+ = \left(t^2, \sqrt{-\frac{1}{2}}t^2 \right).$$

Now we put

$$C_3 : x - t^2 = 0$$

Then $(\mathcal{Q} + C_3 + L_1, \mathcal{Q} + C_3 + L_2)$ is a Zariski pair for Line-conic arrangement 2 of type (c).

We end this section by giving another example:

Proposition 5.1 *Let \mathcal{Q} be an irreducible quartic with a \mathbb{D}_4 singularity, P . Let z_o be a point on \mathcal{Q} such that the tangent line L_{z_o} at z_o meets \mathcal{Q} with two other distinct points. Let L_1, L_2 and L_3 be three tangent lines which meet \mathcal{Q} at P with multiplicity 4. Then the following statements hold:*

- (i) *For each L_i , there exists a unique conic C_i such that (a) $z_o \in C_i$, (b) $P \notin C_i$ and (c) for $\forall x \in C_i \cap \mathcal{Q}$, $I_x(C_i, \mathcal{Q})$ is even.*
- (ii) *For any odd prime p , there exists a D_{2p} -cover of \mathbb{P}^2 branched at $2\mathcal{Q} + p(C_i + L_i)$ for each $i = 1, 2, 3$, while there exists no D_{2p} -cover of \mathbb{P}^2 branched at $2\mathcal{Q} + p(C_i + L_j)$ for any i, j ($i \neq j$).*

Proof. (i) Let $f''_{\mathcal{Q}} \rightarrow \mathbb{P}^2$ be a double cover with branch locus \mathcal{Q} and let $\varphi_{z_o} : S_{(\mathcal{Q}, z_o)} \rightarrow \mathbb{P}^1$ be the rational elliptic surface obtained as in §4. By our assumption on \mathcal{Q} and z_o , the configuration of reducible singular fiber of φ_{z_o} is I_0^*, I_2 and three lines L_i ($i = 1, 2, 3$) give rise to sections $s_{L_i}^\pm$ ($i = 1, 2, 3$), respectively. By labeling irreducible components of singular fibers suitably, we have the following picture for $s_{L_i}^\pm$ ($i = 1, 2, 3$):

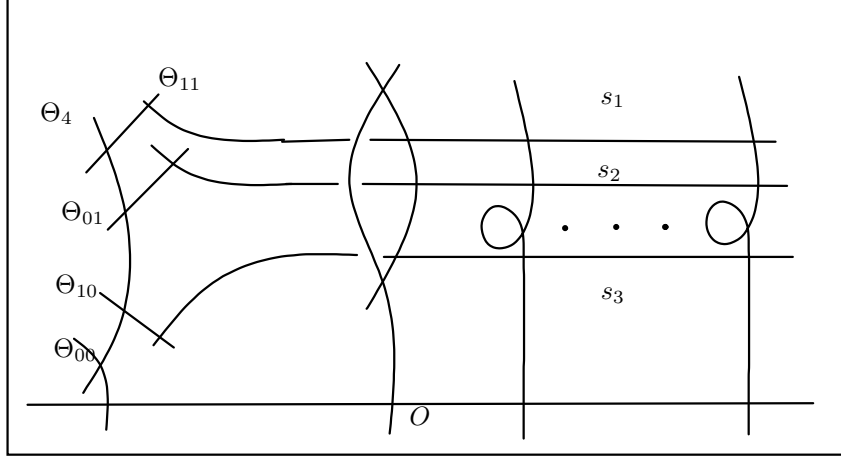

By the explicit formula for $\langle \cdot, \cdot \rangle$, we have

$$\langle s_{L_i}^+, s_{L_i}^+ \rangle = \frac{1}{2} (i = 1, 2, 3), \quad \langle s_{L_i}^+, s_{L_j}^+ \rangle = 0 \quad (i \neq j).$$

By [11], we have $\text{MW}(S_{(\mathcal{Q}, z_o)}) \cong (A_1^*)^{\oplus 3}$. Hence we may assume that

$$\text{MW}(S_{(\mathcal{Q}, z_o)}) \cong \mathbb{Z}s_{L_1}^+ \oplus \mathbb{Z}s_{L_2}^+ \oplus \mathbb{Z}s_{L_3}^+.$$

By the lattice structure of $\text{MW}(S_{(\mathcal{Q}, z_o)})$, all elements $s \in \text{MW}(S_{(\mathcal{Q}, z_o)})$ with $\langle s, s \rangle = 2$ given by $[2]s_{L_i}^\pm$ ($i = 1, 2, 3$). By [7, Theorem 9.1], $[2]s_{L_i}^\pm$ ($i = 1, 2, 3$) meet the identity component at each singular fiber. Hence, $[2]s_{L_i}^\pm O = 0$ ($i = 1, 2, 3$) by the explicit formula for $\langle \cdot, \cdot \rangle$. By our construction of $S_{(\mathcal{Q}, z_o)}$, $\Delta_i := q \circ f([2]s_{L_i}^\pm) \sim \Delta_0 + 2f$ ($i = 1, 2, 3$). Hence $C_i := \bar{q} \circ f([2]s_{L_i}^\pm)$ ($i = 1, 2, 3$) are all conic and $z_o \in C_i, P \notin C_i$. Moreover as $[2]s_{L_i}^+ \neq [2]s_{L_i}^-$ ($i = 1, 2, 3$), our assertion for the intersection multiplicities follows.

(ii) By Theorem 4.1 and Lemma 4.1, our statement follows. \square

Corollary 5.1 *If L_i and L_j ($i \neq j$) meet C_i transversely, then $(\mathcal{Q} + L_i + C_i, \mathcal{Q} + L_j + C_i)$ is a Zariski pair.*

Proof. Since the combinatorics of $\mathcal{Q} + L_i + C_i$ and $\mathcal{Q} + L_j + C_i$ are the same, our assertion follows from Proposition 5.1. \square

Example 5.3 We keep the same coordinates as in Examples 5.1 and 5.2. Consider \mathcal{Q}, L_1 and L_2 as follows:

$$\mathcal{Q} : f_{\mathcal{Q}}(t, x) := x^3 + \frac{343}{64} \left(\frac{121}{49}t^2 + \frac{768}{2401}t \right) x^2 + \frac{343}{64} \left(\frac{384}{2401}t^2 + \frac{92}{49}t^3 \right) x + \frac{35}{16}t^4 + \frac{1}{7}t^3 = 0$$

$$L_1 : x + t = 0, \quad L_2 : x - \frac{\zeta_3 - 2}{7}t = 0, \quad \zeta_3 = \exp(2\pi i/3)$$

\mathcal{Q} is irreducible and has a \mathbb{D}_4 singularity at $(0, 0)$. Both L_1 and L_2 meet \mathcal{Q} at $(0, 0)$ with multiplicity 4. Choose $[0, 1, 0]$ as the distinguished point z_o . Let $S_{(\mathcal{Q}, z_o)}$ be the rational elliptic surface obtained as before. Then its generic fiber is an elliptic curve over $\mathbb{C}(t)$ given by the Weierstrass equation $y^2 = f_{\mathcal{Q}}(t, x)$. Under these circumstances, we have

$$s_{L_1}^{\pm} = \left(-t, \pm \frac{\sqrt{343}}{8} t^2 \right), \quad s_{L_2}^{\pm} = \left(\frac{\zeta_3 - 2}{7} t, \pm \frac{\sqrt{71 + 39\sqrt{-3}}}{8\sqrt{14}} t^2 \right)$$

Then we have

$$[2]s_{L_1}^{\pm} = \left(\frac{144}{16807} - \frac{127}{343}t - \frac{19}{28}t^2, -\frac{\sqrt{7}(55296 + 1947456t + 1450204t^2 + 167649825t^3)}{184473632} \right).$$

Now put

$$C : x - \frac{144}{16807} + \frac{127}{343}t + \frac{19}{28}t^2.$$

Since one can see that both of L_1 and L_2 meet C with two distinct points, $\mathcal{Q} + C + L_1$ and $\mathcal{Q} + C + L_2$ have the same combinatorics. By Corollary 5.1, $(\mathcal{Q} + C + L_1, \mathcal{Q} + C + L_2)$ is a Zariski pair.

References

- [1] E. Artal Bartolo, J.-I. Cogolludo and H. Tokunaga: *A survey on Zariski pairs*, Adv.Stud.Pure Math., **50**(2008), 1-100.
- [2] E. Artal, J. Carmona, J.I. Cogolludo, and M.Á. Marco: *Topology and combinatorics of real line arrangements*, Compos. Math. **141** (2005), no. 6, 1578–1588.
- [3] E. Artal, J. Carmona, J.I. Cogolludo, and M.Á. Marco: *Invariants of combinatorial line arrangements and Rybnikov's example*, Singularity theory and its applications, Adv. Stud. Pure Math. **43** (2007), 1–34.
- [4] W. Barth, K. Hulek, C.A.M. Peters and A. Van de Ven: *Compact complex surfaces*, Ergebnisse der Mathematik und ihrer Grenzgebiete **4** 2nd Enlarged Edition, Springer-Verlag (2004).
- [5] D. Eisenbud and W. Neumann: *Three-dimensional link theory and invariants of plane curve singularities*, Ann. of Math. Stud. **110**, Princeton Univ. Press (1985).
- [6] E. Horikawa: *On deformation of quintic surfaces*, Invent. Math. **31** (1975), 43 – 85.
- [7] K. Kodaira: *On compact analytic surfaces II*, Ann. of Math. **77** (1963), 563-626.
- [8] R. Miranda: *Basic theory of elliptic surfaces*, Dottorato di Ricerca in Matematica, ETS Editrice, Pisa, 1989.
- [9] R. Miranda and U. Persson: *On extremal rational elliptic surfaces*, Math. Z. **193**(1986), 537-558.

- [10] M. Namba and H. Tsuchihashi, *On the fundamental groups of Galois covering spaces of the projective plane*, *Geom. Dedicata* **104** (2004), 97–117.
- [11] K. Oguiso and T. Shioda: *The Mordell-Weil lattice of Rational Elliptic surface*, *Comment. Math. Univ. St. Pauli* **40**(1991), 83-99.
- [12] U. Persson: *Configurations of Kodaira fibers on rational elliptic surfaces*, *Math. Z.*, **205**(1990), 1-49.
- [13] G. Rybnikov: *On the fundamental group of the complement of a complex hyperplane arrangement*, preprint available at <http://arXiv.org/math.AG/9805056>.
- [14] T. Shioda: *On the Mordell-Weil lattices*, *Comment. Math. Univ. St. Pauli* **39** (1990), 211-240.
- [15] H. Tokunaga: *On dihedral Galois coverings*, *Canadian J. of Math.* **46** (1994), 1299 - 1317.
- [16] H. Tokunaga: *Dihedral coverings branched along maximizing sextics*, *Math. Ann.* **308** (1997) 633-648.
- [17] H. Tokunaga: *Some examples of Zariski pairs arising from certain elliptic K3 surfaces*, *Math. Z.* **227** (1998), 465-477
- [18] H. Tokunaga: *Some examples of Zariski pairs arising from certain elliptic K3 surfaces II: Degtyarev's conjecture*, *Math.Z.* **230** (1999), 389-400
- [19] H. Tokunaga: *Dihedral covers and an elementary arithmetic on elliptic surfaces*, *J. Math. Kyoto Univ.* **44**(2004), 55-270.
- [20] H. Tokunaga: *2-dimensional versal G-covers and Cremona embeddings of finite groups*, *Kyushu J. of Math.* **60**(2006), 439-456.
- [21] H. Tokunaga: *Some sections on rational elliptic surfaces and certain special conic-quartic configurations*, to appear in *Kodai Math. J.*
- [22] H. Tsuchihashi: *Galois coverings of projective varieties for dihedral and symmetric groups*, *Kyushu J. Math.* **57**(2003), 411-427.
- [23] O. Zariski: *On the problem of existence of algebraic functions of two variables possessing a given branch curve*, *Amer. J. Math.* **51** (1929), 305–328.
- [24] O. Zariski: *The topological discriminant group of a Riemann surface of genus p*, *Amer. J. Math.* **59** (1937), 335–358.
- [25] O. Zariski: *On the purity of the branch locus of algebraic functions*, *Proc. Nat. Acad. USA* **44** (1958), 791-796.

Hiro-o TOKUNAGA
 Department of Mathematics and Information Sciences
 Graduate School of Science and Engineering,
 Tokyo Metropolitan University
 1-1 Minami-Ohsawa, Hachiohji 192-0397 JAPAN
 tokunaga@tmu.ac.jp