

# AN EFFICIENT ALGORITHM FOR FINDING A BASIS OF THE FIXED POINT SUBGROUP OF AN AUTOMORPHISM OF A FREE GROUP

OLEG BOGOPOLSKI\* AND OLGA MASLAKOVA†

ABSTRACT. We prove that for any automorphism  $\alpha$  of a free group  $F$  of finite rank, one can efficiently compute a basis of the fixed point subgroup  $\text{Fix}(\alpha)$ .

## CONTENTS

1. Introduction	2
2. Preliminaries	4
3. Sketch of the proof	5
4. Relative train tracks for outer automorphisms of free groups	10
5. Relative train tracks for automorphisms of free groups	13
6. Auxiliary statements	15
7. Graphs $D_f$ and $CoRe(C_f)$ for a homotopy equivalence $f : \Gamma \rightarrow \Gamma$	16
8. $r$ -cancellation points in paths in $G_r$	28
9. $r$ -cancellation areas	31
10. Stable paths and their $A$ -decompositions	34
11. Splitting lemma	39
12. Subdivided relative train track	40
13. $r$ -superstable, $r$ -perfect, and $A$ -perfect paths	42
14. $\mu$ -subgraphs in the case where $\mu$ and $[\mu f(\mu)]$ are $r$ -legal	44
15. $\mu$ -subgraphs in the case where $\mu$ is $r$ -legal, but $[\mu f(\mu)]$ is not	47
16. $\mu$ -subgraphs in the case where $\mu$ is not $r$ -legal, but $r$ -superstable	50
17. Cones over vertices of $D_f$	54
18. $r$ -perfect and $A$ -perfect vertices in $\mu$ -subgraphs	59
19. $E$ -perfect vertices in $\mu$ -subgraphs	62
20. Finiteness and Membership problems for $\mu$ -subgraphs	64
References	67

---

\*Mathematisches Institut, Düsseldorf University, Düsseldorf, Germany  
and Sobolev Institute of Mathematics of SB RAS, Novosibirsk, Russia.  
e-mail: [bogopolski@math.uni-duesseldorf.de](mailto:bogopolski@math.uni-duesseldorf.de).

†Sobolev Institute of Mathematics of SB RAS, Novosibirsk, Russia.  
e-mail: [o.s.maslakova@gmail.com](mailto:o.s.maslakova@gmail.com).

## 1. INTRODUCTION

Let  $F_n$  be the free group of finite rank  $n$ . For any endomorphism  $\varphi$  of  $F_n$  the *fixed point subgroup* of  $\varphi$  is

$$\text{Fix}(\varphi) = \{x \in F_n \mid \varphi(x) = x\}.$$

More generally, if  $S$  is a set of endomorphisms of  $F_n$ , the *fixed point subgroup* of  $S$  is  $\text{Fix}(S) = \bigcap_{\varphi \in S} \text{Fix}(\varphi)$ .

Dyer and Scott showed in [18] that if  $\varphi$  is an automorphism of finite order of  $F_n$ , then  $\text{Fix}(\varphi)$  is a free factor of  $F_n$ , in particular the rank of  $\text{Fix}(\varphi)$  does not exceed  $n$ . Scott later (1978) conjectured that

$$\text{rk Fix}(\varphi) \leq n$$

for any automorphism of  $F_n$ .

Gersten [22, 23], Goldstein and Turner [25], and Cooper [16] independently proved a weaker form of this conjecture that the group  $\text{Fix}(\varphi)$  is finitely generated. In [32], Thomas generalized this result for an arbitrary set of automorphisms of  $F_n$ . In [31], Stallings proved that the equalizer subgroup

$$\text{Eq}(\varphi, \psi) := \{x \in F_n \mid \varphi(x) = \psi(x)\}$$

is finitely generated for any two monomorphisms  $\varphi, \psi$  from  $F_n$  into a free group  $G$ . Goldstein and Turner [24] showed that the same holds in case where  $\varphi$  is a homomorphism and  $\psi$  is a monomorphism from  $F_n$  to  $F_n$ .

In the seminal paper [7], Bestvina and Handel proved the Scott conjecture for automorphisms of free groups completely. The relative train track technique developed in this paper enabled the solution of a sequel of difficult problems about automorphisms of free groups, see [4, 5, 6, 14, 11, 13, 12]. Later Gaboriau, Levitt and Lustig [21] gave a dendrological proof of the Scott conjecture. A stronger inequality, which also takes into account infinite fixed words, is given in [19]. Another dendrological proof was given by Sela in [30]. A short dendrological proof of the Scott conjecture based on papers [21], [30], and [29] is given in the survey [3] of Bestvina on  $\mathbb{R}$ -trees.

Imrich and Turner [26] proved that  $\text{rk Fix}(\varphi) \leq n$  for an arbitrary endomorphism  $\varphi$  of  $F_n$ . Dicks and Ventura [17] proved that,  $\text{rk Fix}(S) \leq n$  for any set  $S$  of injective endomorphisms of  $F_n$ . Bergman, using derivations in group rings, proved that the same holds for an arbitrary set of endomorphisms of  $F_n$ . However, the following problem has been open for almost 20 years.

**Problem A.** Find an efficient algorithm for computing a basis of  $\text{Fix}(\varphi)$ , where  $\varphi$  is an automorphism of a free group  $F$  of finite rank.

Variations of this problem are formulated in the book of Dicks and Ventura [17, pages 71-72]; see a commentary there. A weaker form of this problem is formulated in [34, Problem (F1) (a)].

Problem A has been solved in three special cases: for positive automorphisms in the paper [15] of Cohen and Lustig, for special irreducible automorphisms in the paper of Turner [33, Proposition B], and for all automorphisms of  $F_2$  in the paper of Bogopolski [9].

In 1999, Maslakova, a former PhD student of the first named author, attempted to solve this problem in general case. However, her proof published in [27], see also [28], was not complete. So, we have decided to give a full and correct proof. The main result of this paper is the following.

**Theorem 1.1.** *Let  $F_n$  be the free group of a finite rank  $n$ . There exists an efficient algorithm which, given an automorphism  $\varphi$  of  $F_n$  finds a basis of its fixed point subgroup*

$$\text{Fix}(\varphi) = \{x \in F_n \mid \varphi(x) = x\}.$$

We fix a basis  $X = \{x_1, \dots, x_n\}$  of  $F_n$ . The length of a word  $w \in F$  with respect to  $X$  is denoted by  $|w|$ . The *norm* of the automorphism  $\varphi$  with respect to  $X$  is the number  $\|\varphi\| := \max\{|\varphi(x_1)|, \dots, |\varphi(x_n)|\}$ .

The input of this algorithm is the sequence of words  $\varphi(x_1), \dots, \varphi(x_n)$  in the alphabet  $X^\pm$ ; the output are words in  $X^\pm$  which freely generate  $\text{Fix}(\varphi)$ .

Under efficient algorithm we understand an algorithm for which one can write down a recursive function estimating the number of steps in terms of input. We don't consider algorithms which use two processes, one of which eventually terminates, and we don't use diagonalization methods.

As in [7], we use the relative train track techniques. A relative train track is a homotopy equivalence  $f : \Gamma \rightarrow \Gamma$  of a finite graph  $\Gamma$  with certain good properties, see Section 4. In [7, Theorem 5.12]), Bestvina and Handel proved that for any outer automorphism  $\mathcal{O}$  of  $F_n$ , there exists a relative train track  $f : \Gamma \rightarrow \Gamma$  representing  $\mathcal{O}$ .

However, to start our algorithm, we need to represent the automorphism  $\varphi$  (and not its outer class) by a relative train track  $f : (\Gamma, v) \rightarrow (\Gamma, v)$ , see Definition 3.1. This is done in Theorem 5.4.

We use  $f$  to define an auxiliary graph  $D_f$  (first introduced in [24] in another setting, see also [33]). The fundamental group of one of the components of  $D_f$ , denoted  $D_f(\mathbf{1}_v)$ , can be identified with  $\text{Fix}(\varphi)$  (see Section 7). Thus, to compute a basis of  $\text{Fix}(\varphi)$ , we need to construct the core  $\text{Core}(D_f(\mathbf{1}_v))$  of this component.

At all but finite number of the vertices of  $D_f$  there is a preferable outgoing direction. This determines a flow on almost all of  $D_f$ . The inverse automorphism  $\varphi^{-1}$  determines its own flow on almost all of  $D_f$ . According to [33] (see also [15]), there is a procedure for constructing a part of  $\text{Core}(D_f)$  which contains  $\text{Core}(D_f(\mathbf{1}_v))$  if the latter is non-contractible: one should start from a finite number of computable

exceptional edges and follow the first flow for sufficiently long. Theoretically we could arrive at a dead vertex, or get a loop, or arrive at a vertex where two rays of this flow meet, or none of these may occur. To convert this procedure into an algorithm, we must detect at the beginning, which possibility occurs. For that, we must solve the Finiteness and the Membership problems for vertices and certain subgraphs of  $D_f$  (see Sections 3 and 7). We solve these problems in this paper. A sketch of the proof is given in Section 3.

## 2. PRELIMINARIES

Let  $\Gamma$  be a finite connected graph,  $\Gamma^0$  be the set of its vertices,  $\Gamma^1$  be the set of its edges. The initial vertex of an edge  $E$  is denoted by  $\alpha(E)$ , the terminal by  $\omega(E)$ , the inverse edge to  $E$  is denoted by  $\overline{E}$ .

The geometric realization of  $\Gamma$  is obtained by identification of each edge of  $\Gamma$  with a real segment  $[a, b]$  of length 1. This realization is denoted again by  $\Gamma$ . Using this realization, we can work with partial edges and compute distances between points inside edges without passing to a subdivision. *Partial edges* in  $\Gamma$  are identified with subsegments  $[a_1, b_1] \subset [a, b]$ . Let  $l$  be the corresponding metric on  $\Gamma$ .

For algorithmic aims, we work only with piecewise linear maps. For brevity, we skip the wording *piecewise linear*, e.g. we say a path instead of a piecewise linear path.

A *nontrivial path* in  $\Gamma$  is a continuous map  $\tau : [0, 1] \rightarrow \Gamma$  with the following property: there exist numbers  $0 = s_1 < s_2 < \dots < s_k < s_{k+1} = 1$  and a sequence of (possibly partial) edges  $E_1, E_2, \dots, E_k$ , such that  $\tau|_{[s_i, s_{i+1}]}$  is a linear map onto  $E_i$  for each  $i = 1, \dots, k$ . We will not usually distinguish between  $\tau$  and the concatenation of (partial) edges  $E_1 E_2 \dots E_k$ . The *length* of  $\tau$  is  $l(\tau) := \sum_{i=1}^k l(E_i)$ . For any two occurrences of points  $u, v$  in  $\tau$ , let  $l_\tau(u, v)$  be the  $l$ -length of the subpath of  $\tau$  connecting  $u$  and  $v$ . A *trivial path* in  $\Gamma$  is a map  $\tau : [0, 1] \rightarrow \Gamma$  whose image consists of a single point. The trivial path whose image is  $\{u\}$  is denoted by  $\mathbf{1}_u$ ; we set  $l(\mathbf{1}_u) = 0$ . An *edge-path* in  $\Gamma$  is either a path of the form  $E_1 E_2 \dots E_k$ , where all  $E_i$  are full edges, or a trivial path  $\mathbf{1}_u$ , where  $u$  is a vertex.

The initial and the terminal points of a path  $\tau$  are denoted by  $\alpha(\tau)$  and  $\omega(\tau)$ , respectively. The inverse path to  $\tau$  is denoted by  $\overline{\tau}$ . The concatenation of two paths, a reduced path, and homotopic paths are defined in a usual way. By  $[\tau]$  we denote the reduced path in  $\Gamma$  which is homotopic to  $\tau$  relative to the endpoints of  $\tau$ . Let  $[[\tau]]$  be the class of paths homotopic to  $\tau$  relative to the endpoints of  $\tau$ . For two paths  $\tau, \mu$ , we write  $\tau = \mu$  if these paths are homotopic and  $\tau \equiv \mu$  if they coincide. The concatenation of  $\tau$  and  $\mu$  (if exists) is denoted by  $\tau\mu$  or  $\tau \cdot \mu$ .

Let  $\mathcal{PLHE}$  be the class of all homotopy equivalences  $f : \Gamma \rightarrow \Gamma$  such that  $\Gamma$  is a finite connected graph,  $f(\Gamma^0) \subseteq \Gamma^0$ , and for each edge  $E$  the following is satisfied:  $f(E) \equiv E_1 E_2 \dots E_k$ , where each  $E_i$  is an edge and  $E$  has a subdivision into segments,  $E \equiv e_1 e_2 \dots e_k$ , such that  $f|_{e_i} : e_i \rightarrow E_i$  is surjective and linear

with respect to the metric  $l$ . The abbreviation  $\mathcal{PLHE}$  stands for *piecewise linear homotopy equivalence*.

The homotopy equivalence  $f : \Gamma \rightarrow \Gamma$  is called *tight* (resp. *nondegenerate*) if for each edge  $E$  in  $\Gamma$  the path  $f(E)$  is reduced (resp. nontrivial). The *norm* of  $f$  is the number  $\|f\| := \max\{l(f(E)) \mid E \text{ is an edge of } \Gamma\}$ .

Let  $f : \Gamma \rightarrow \Gamma$  be a homotopy equivalence from  $\mathcal{PLHE}$ . Then for every path  $\tau$  in  $\Gamma$  the map  $f \circ \tau$  is also a path in  $\Gamma$ . We denote this path by  $f(\tau)$ . If  $v$  is a distinguished vertex of  $\Gamma$ , we write  $f_* : \pi_1(\Gamma, v) \rightarrow \pi_1(\Gamma, f(v))$  for the isomorphism given by  $[[\tau]] \mapsto [[f(\tau)]]$ , where  $[[\tau]] \in \pi_1(\Gamma, v)$ . We use the following rule for composition of two maps:  $x(\varphi\psi) = (x\varphi)\psi$ .

### 3. SKETCH OF THE PROOF

In this section we give a sketch of the proof of the main theorem. Some definitions we use here are given in the following sections. At this point, it suffices to know the definition of a PL-relative train track (see Section 4).

**A.** Let  $\varphi$  be an automorphism of a free group  $F$  of finite rank.

**Definition 3.1.** We say that  $\varphi$  is *represented* by a homotopy equivalence  $f : \Gamma \rightarrow \Gamma$ , where  $\Gamma$  is a finite connected graph, if there is a vertex  $v$  in  $\Gamma$  fixed by  $f$  and there is an isomorphism  $j : F \rightarrow \pi_1(\Gamma, v)$  such that the automorphism  $j^{-1}\varphi j$  of the group  $\pi_1(\Gamma, v)$  coincides with the induced automorphism  $f_* : \pi_1(\Gamma, v) \rightarrow \pi_1(\Gamma, v)$ . We also say that  $f$  *represents*  $\varphi$ .

By Theorem 5.4, we may assume that  $\varphi$  is algorithmically represented by a homotopy equivalence  $f : (\Gamma, v) \rightarrow (\Gamma, v)$  which is a PL-relative train track. Let  $\emptyset = G_0 \subset \dots \subset G_N = \Gamma$  be the fixed maximal filtration for  $f$ ; this gives us exponential, polynomial, or zero strata  $H_i := \text{cl}(G_i \setminus G_{i-1})$ ,  $i = 1, \dots, N$ .

In Section 4 we recall that for each exponential stratum  $H_r$ , there exist an algebraic real number  $\lambda_r > 1$  and a pseudo-metric  $L_r$  on  $G_r$  with the following properties:

- if  $E$  is an edge in  $G_r$ , then  $L_r(E) > 0$  if and only if  $E$  is an edge in  $H_r$ ;
- if  $p$  is a path in  $G_r$ , then  $L_r(f(p)) = \lambda_r L_r(p)$ ;
- if  $p$  is a reduced  $r$ -legal path in  $G_r$ , then  $L_r([f(p)]) = \lambda_r L_r(p)$ .

**B.** In Section 9, we define  $r$ -cancelation areas. To avoid technical details, we give here an equivalent easier definition: Let  $H_r$  be an exponential stratum. Let  $\tau$  be a reduced path in  $G_r$ . An occurrence of a vertex  $y$  in  $\tau$  is called an  *$r$ -cancelation point in  $\tau$*  if  $\tau$  contains a subpath  $\bar{a}b$ , where  $a$  and  $b$  are nontrivial partial edges such that  $\alpha(a) = \alpha(b) = y$  and the full edges containing  $a$  and  $b$  form an illegal  $r$ -turn. A reduced path  $\tau$  in  $G_r$  is called an  *$r$ -cancelation area* if, for each  $k \in \mathbb{N} \cup \{0\}$ , there is exactly one  $r$ -cancelation point in  $[f^k(\tau)]$  and if each proper subpath of  $\tau$  does not have this property. These areas are important for describing splittings of the so-called  $r$ -stable paths (see Section 10).

One can prove that the set of  $r$ -cancellation areas coincides with the set  $P_r$  defined before Lemma 4.2.5 in [4]. This lemma asserts that the set  $P_r$  is finite and that if  $\tau \in P_r$ , then  $[f(\tau)] \in P_r$ . However, the proof of this lemma does not give a method for finding the elements of  $P_r$ . In Section 9, we show that all  $r$ -cancellation areas can be efficiently found (Theorem 9.8).

The  $r$ -cancellation areas closely related to the indivisible periodic Nielsen paths in  $G_r$  intersecting  $\text{int}(H_r)$ . (Recall that a nontrivial reduced path  $\sigma$  in  $\Gamma$  is called a *periodic Nielsen path* for  $f : \Gamma \rightarrow \Gamma$  if  $[f^k(\sigma)] = \sigma$  for some  $k \geq 1$ . A periodic Nielsen path  $\sigma$  is called *indivisible* if it cannot be written as a concatenation of periodic Nielsen paths, see Definition 5.1.1 in [4].) Indeed, if  $N(r)$  is the number of  $r$ -cancellation areas for  $f$ , then the set  $\{[f^{N(r)}(A)] \mid A \text{ is an } r\text{-cancellation area}\}$  coincides with the set of all indivisible periodic Nielsen paths in  $G_r$  intersecting  $\text{int}(H_r)$ .

In Section 10 we define  $r$ -stable paths: A reduced path  $\tau \subset G_r$  is called  *$r$ -stable* if the number of  $r$ -cancellation points in  $[f^k(\tau)]$  is the same for each  $k \in \mathbb{N} \cup \{0\}$ . We prove that given a reduced edge path  $\tau \subset G_r$ , one can efficiently check, whether  $\tau$  is  $r$ -stable or not. If not, we show how to efficiently find  $i_0 \in \mathbb{N}$  such that the path  $[f^{i_0}(\tau)]$  is  $r$ -stable (Theorems 10.4 and 10.6).

The following lemma is important for describing the splittings of paths in  $G_r$ . A variation of this lemma for  $r$ -stable paths is given in [4, Lemma 4.2.6]. Another variation is given in [12, Proposition 6.2]. However, the proof there, which is pretended to be constructive, is not correct. We give a correct proof in Section 11.

**Splitting lemma.** *For any PL-relative train track  $f : \Gamma \rightarrow \Gamma$ , the following is satisfied:*

*Let  $H_r$  be an exponential stratum of  $\Gamma$  and let  $\tau$  be a reduced edge path in  $G_r$ . Then, for all  $L > 0$ , one can efficiently find an exponent  $S > 0$  such that at least one of the three possibilities occurs:*

- 1)  $[f^S(\tau)]$  contains an  $r$ -legal subpath of  $r$ -length greater than  $L$ .
- 2)  $[f^S(\tau)]$  contains fewer illegal  $r$ -turns than  $\tau$ .
- 3)  $[f^S(\tau)]$  is a trivial path or a concatenation of paths each of which is either an indivisible periodic Nielsen path intersecting  $\text{int}(H_r)$  or an edge path in  $G_{r-1}$ .

In Section 12, we subdivide  $\Gamma$  at the so called  *$r$ -exceptional points* to obtain a new PL-relative train track  $f' : \Gamma' \rightarrow \Gamma'$  representing  $\varphi$  and satisfying the following additional condition:

(RTT-iv) There is a computable natural number  $P = P(f)$  such that for each exponential strata  $H_r$  and each  $r$ -cancellation area  $A$  of  $f$ , the  $r$ -cancellation area  $[f^P(A)]$  is an edge path.

Such relative train tracks are more convenient for solving algorithmic problems.

**C.** Let  $\Gamma$  be a finite connected graph with a distinguished vertex  $v$  and let  $f : \Gamma \rightarrow \Gamma$  be a homotopy equivalence such that  $f(\Gamma^0) \subseteq \Gamma^0$ ,  $f$  maps edges of  $\Gamma$  to reduced edge paths, and  $f(v) = v$ . Thus,  $f$  is not necessarily a (subdivided) relative train track. In Section 7 and here we define a graph  $D_f$  and describe a procedure which helps to compute a basis of the group

$$\overline{\text{Fix}}(f) := \{[[p]] \in \pi_1(\Gamma, v) \mid f(p) = p\}.$$

In Sections 13-20, we will convert this procedure into an algorithm in case where  $f$  is a subdivided relative train track. From this we will deduce an algorithm for computing  $\text{Fix}(\varphi)$ .

**A definition of the graph  $D_f$ .** An  $f$ -path in  $\Gamma$  is an edge path  $\mu$  in  $\Gamma$  (possibly trivial) such that  $f$  maps the initial point of  $\mu$  to the terminal point of  $\mu$ . Thus, if  $\mu$  is an  $f$ -path in  $\Gamma$ , the path  $\mu f(\mu)$  is well defined. Moreover, if  $\mu$  is an  $f$ -path and  $E$  is an edge in  $\Gamma$  satisfying  $\alpha(E) = \alpha(\mu)$ , then  $[\overline{E}\mu f(E)]$  is also an  $f$ -path.

The vertices of the graph  $D_f$  are reduced  $f$ -paths. A vertex  $\mu$  of  $D_f$  is called *dead* if  $\mu = \mathbf{1}_u$  for some vertex  $u$  of  $\Gamma$  fixed by  $f$ ; otherwise  $\mu$  is called *alive*. Two vertices  $\mu$  and  $\tau$  in  $D_f$  are connected by an edge (from  $\mu$  to  $\tau$ ) with label  $E$  if  $E$  is an edge in  $\Gamma$  satisfying  $[\overline{E}\mu f(E)] = \tau$ .

We set  $\widehat{f}(\mu) := [\overline{E}\mu f(E)]$  if  $E$  is the first edge of the  $f$ -path  $\mu$  (in particular,  $\mu$  must be alive). Clearly,  $\mu$  and  $\widehat{f}(\mu)$ , considered as vertices of  $D_f$ , are connected by an edge with the label  $E$ . The direction of this edge is called *preferable* at the vertex  $\mu$  (see Figure 3). Observe that there is a unique preferable direction at each alive vertex of  $D_f$ . Preferable directions at all alive vertices determine a flow in  $D_f$ . Starting at  $\mu$  and moving along this flow, we get the vertices  $\mu = \mu_1, \mu_2, \dots$ , where  $\mu_{i+1} = \widehat{f}(\mu_i)$ ,  $i \geq 1$ . These vertices together with the directed edges we pass form a subgraph in  $D_f$  which we call the  $\mu$ -subgraph. The  $\mu$ -subgraph is either a finite segment, or a finite segment with a cycle, or a ray (see Figure 5). We set  $\widehat{f}^0(\mu) := \mu$  and  $\widehat{f}^i(\mu) := \widehat{f}(\widehat{f}^{i-1}(\mu))$  if  $\widehat{f}^{i-1}(\mu)$  is defined and alive.

An edge  $e$  connecting two vertices  $u, w$  in  $D_f$  is called *repelling* if the direction of  $e$  is not preferable at  $u$  and the direction of the opposite edge  $\bar{e}$  is not preferable at  $w$ . In Figure 1, the repelling edges are red. Endpoints of repelling edges are called *repelling vertices*. By Proposition 7.2, there exist only finitely many repelling edges in  $D_f$  and they can be algorithmically found.

**D.** Let  $v$  be a distinguished vertex of  $\Gamma$  and  $f(v) = v$ . Since  $\mathbf{1}_v$  is an  $f$ -path, we can consider  $\mathbf{1}_v$  as a vertex of  $D_f$ . Let  $D_f(\mathbf{1}_v)$  be the component of  $D_f$  containing  $\mathbf{1}_v$ . The fundamental group  $\pi_1(D_f(\mathbf{1}_v), \mathbf{1}_v)$  can be identified with  $\overline{\text{Fix}}(f)$ , see Lemma 7.3.

A component of  $D_f$  is called *repelling* if it contains at least one repelling edge. Let  $C_1, \dots, C_n$  be all repelling components of  $D_f$ . For each  $C_i$ , let  $\text{CoRe}(C_i)$  be

the minimal connected subgraph of  $C_i$  which contains all repelling edges of  $C_i$  and carries  $\pi_1(C_i)$ . We set  $C_f := \cup_{i=1}^n C_i$  and  $CoRe(C_f) := \cup_{i=1}^n CoRe(C_i)$ .

By Proposition 7.6, to compute a basis of  $\pi_1(D_f(\mathbf{1}_v), \mathbf{1}_v)$ , it suffices to construct  $CoRe(C_f)$  and decide, whether the vertex  $\mathbf{1}_v$  lies in the  $\mu$ -subgraph for some repelling vertex  $\mu$ .

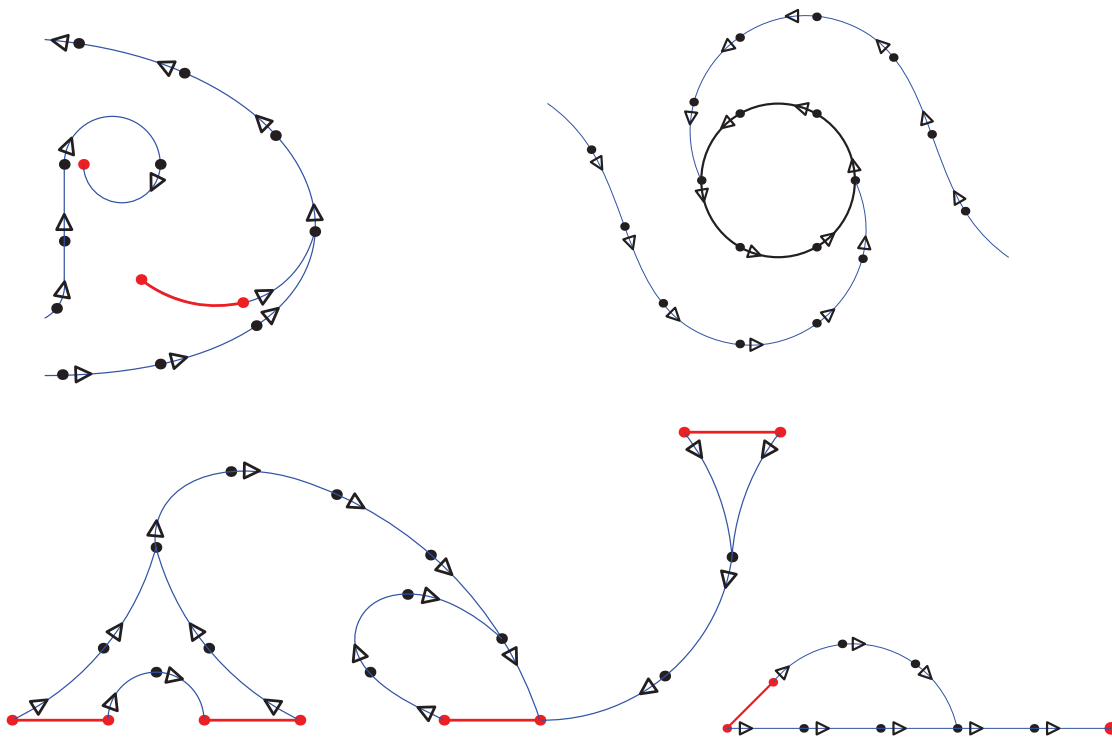

Figure 1.

An example of a graph  $D_f$  with three repelling components. One of them is contractible.

**E.** It turns out that  $CoRe(C_f)$  is contained in the union of the repelling edges and the  $\mu$ -subgraphs, where  $\mu$  runs over the set of repelling vertices. So, to construct  $CoRe(C_f)$ , it suffices to do the following:

- (1) Find all repelling edges in  $D_f$ .
- (2) For each alive repelling vertex  $\mu$  determine, whether the  $\mu$ -subgraph is finite or not.
- (3) Compute all elements of all finite  $\mu$ -subgraphs from (2).
- (4) For each two repelling vertices  $\mu$  and  $\tau$  with infinite  $\mu$ - and  $\tau$ -subgraphs determine, whether these subgraphs intersect.



- (5) If the  $\mu$ -subgraph and the  $\tau$ -subgraph from (4) intersect, find their first intersection point and compute their initial segments up to this point.

As it was mentioned above, Step (1) can be done algorithmically. In Section 7 we show that Steps (2)-(5) can be done algorithmically if the following two problems are solvable:

**Finiteness problem.** Given a vertex  $\mu$  of the graph  $D_f$ , determine whether the  $\mu$ -subgraph is finite or not. If the  $\mu$ -subgraph is finite, construct it.

**Membership problem.** Given two vertices  $\mu$  and  $\tau$  of the graph  $D_f$ , verify whether  $\tau$  is contained in the  $\mu$ -subgraph.

In the part F, we sketch solutions of these problems in the case where  $f$  is a PL-relative train track satisfying (RTT-iv). Hence, for such  $f$  we can compute a basis of  $\overline{\text{Fix}}(f)$ . By the parts A and B, we may assume that  $\varphi$  is represented by such  $f$ . Using this, we can compute a basis of  $\text{Fix}(\varphi)$ .

**F.** From now on and to the end of this section, we assume that  $f : (\Gamma, v) \rightarrow (\Gamma, v)$  is a PL-relative train track satisfying (RTT-iv). Let  $\emptyset = G_0 \subset \dots \subset G_N = \Gamma$  be the maximal filtration associated with  $f$ .

To solve the Finiteness and the Membership problems, we investigate the  $\mu$ -subgraphs of  $D_f$  in details. Let  $\mu \equiv E_1 E_2 \dots E_s$  be a nontrivial reduced  $f$ -path, and suppose that  $\mu$  lies in  $G_m$ , but not in  $G_{m-1}$ . There may be cancelations in computing  $\widehat{f}(\mu) \equiv [E_2 \dots E_s \cdot f(E_1)]$ .

To control these cancelations, we introduce the notions *r-perfect*, *A-perfect*, and *E-perfect* vertices in  $D_f$ , see Definitions 13.3, 13.5, and 19.1, respectively. These definitions imply that if  $\mu$  is *r-perfect* or *A-perfect*, then there are no cancelations in passing from  $\mu$  to  $\widehat{f}(\mu)$ , and if  $\mu$  is *E-perfect*, then such cancelations are possible only between edges which lie in  $G_{m-1}$ .

Propositions 18.4 and 19.2.(3) imply that, given a vertex  $\mu$  in  $D_f$ , one can either efficiently prove that the  $\mu$ -subgraph is finite, or find a perfect vertex  $v_1 \neq \mu$  in the  $\mu$ -subgraph. In the second case we still have to decide, whether the  $\mu$ -subgraph is finite or not.

*Case 1.* Suppose that  $v_1$  is *r-perfect*.

Let  $\lambda_r > 1$  be the Perron-Frobenius eigenvalue corresponding to  $H_r$ . Then, by Lemma 20.1 we have the following:

- (1)  $L_r(\widehat{f}^{i+1}(v_1)) \geq L_r(\widehat{f}^i(v_1)) > 0$  for all  $i \geq 0$ .
- (2) There exist computable natural numbers  $m_1 < m_2 < \dots$ , such that  $L_r(\widehat{f}^{m_i}(v_1)) = \lambda_r^i L_r(v_1)$  for all  $i \geq 1$ .

Hence, the  $v_1$ -subgraph is infinite, and so the  $\mu$ -subgraph is infinite, that solves the Finiteness problem in this case. Also the Membership problem for the  $v_1$ -subgraph, and hence for the  $\mu$ -subgraph, can be easily solved with the help of  $L_r$ .

*Case 2.* Suppose that  $v_1$  is  $A$ -perfect.

By Proposition 13.6, we can efficiently find a finite set  $\{v_1, v_2, \dots, v_k\}$  of  $A$ -perfect vertices in the  $v_1$ -subgraph such that the following holds:

- (1) All  $A$ -perfect vertices in the  $v_1$ -subgraph are  $[f^i(v_j)]$ ,  $i \geq 0$ ,  $1 \leq j \leq k$ .
- (2)  $[f^i(v_j)] = \widehat{f}^{m_{i,j}}(v_1)$  for some computable  $m_{i,j}$ . Moreover,  $m_{i,j}$  are different for different  $(i, j)$ .
- (3) Given a vertex  $u$  in the  $v_1$ -subgraph, we can find  $\ell$  such that  $\widehat{f}^\ell(u)$  is an  $A$ -perfect vertex. The least  $\ell$  does not exceed the number of edges in the  $f$ -path  $u$ .

Using this, the Finiteness and the Membership problems for the  $v_1$ -subgraph can be reduced to the following problems:

**FIN**( $v_1$ ). Do there exist  $p > q \geq 0$  such that  $[f^p(v_1)] = [f^q(v_1)]$ ?

**MEM**( $v_1$ ). Given a reduced  $f$ -path  $\tau$ , does there exist  $p \geq 0$  such that  $[f^p(v_j)] = \tau$  for some  $1 \leq j \leq k$ ?

These problems are solvable by Corollaries 6.3 and 6.2, which we deduce from a theorem of Brinkmann, see [13, Theorem 0.1].

*Case 3.* Suppose that  $v_1$  is  $E$ -perfect.

Then the solution is similar to that given in Case 2, see Sections 19 and 20.

#### 4. RELATIVE TRAIN TRACKS FOR OUTER AUTOMORPHISMS OF FREE GROUPS

First we recall the definition of a relative train track from [7]. Since we are interested in algorithmic problems, we will work only with homotopy equivalences from the class  $\mathcal{PLHE}$  defined in Section 2.

Let  $\Gamma$  be a finite connected graph and let  $f : \Gamma \rightarrow \Gamma$  be a tight and nondegenerate homotopy equivalence from the class  $\mathcal{PLHE}$ .

A *turn* in  $\Gamma$  is an unordered pair of edges of  $\Gamma$  originating at a common vertex. A turn is *nondegenerate* if these edges are distinct, and it is *degenerate* otherwise. The map  $f : \Gamma \rightarrow \Gamma$  induces a map  $Df : \Gamma^1 \rightarrow \Gamma^1$  which sends each edge  $E \in \Gamma^1$  to the first edge of the path  $f(E)$ . This induces a map  $Tf$  on turns in  $\Gamma$  by the rule  $Tf(E_1, E_2) = (Df(E_1), Df(E_2))$ . A turn  $(E_1, E_2)$  is *legal* if the turns  $(Tf)^n(E_1, E_2)$  are nondegenerate for all  $n \geq 0$ ; a turn is *illegal* if it is not legal. An edge path  $E_1 E_2 \dots E_m$  in  $\Gamma$  is *legal* if all its turns  $(\overline{E}_i, E_{i+1})$  are legal. Clearly, a legal edge path is reduced.

From each pair of mutually inverse edges of the graph  $\Gamma$  we choose one edge. Let  $\{E_1, \dots, E_k\}$  be the ordered set of chosen edges. The *transition matrix* of the map  $f$  (with respect to this ordering) is the matrix  $M(f)$  of the size  $k \times k$  such that the  $ij^{\text{th}}$  entry of  $M(f)$  is equal to the total number of occurrences of the edges  $E_i$  and  $\overline{E}_i$  in the path  $f(E_j)$ .

A *filtration* for  $f : \Gamma \rightarrow \Gamma$  is an increasing sequence of (not necessarily connected)  $f$ -invariant subgraphs  $\emptyset = G_0 \subset \dots \subset G_N = \Gamma$ . The subgraph  $H_i = \text{cl}(G_i \setminus G_{i-1})$  is called the  *$i$ -th stratum*. Edges in  $H_i$  are called  *$i$ -edges*. A turn with both edges in  $H_i$  is called an  *$i$ -turn*. A turn with one edge in  $H_i$  and another in  $G_{i-1}$  is called *mixed* in  $(G_i, G_{i-1})$ . We assume that the edges of  $\Gamma$  are ordered so that the edges from  $H_i$  precede the edges from  $H_{i+1}$ . The edges from  $H_i$  define a square submatrix  $M_{[i]}$  of  $M(f)$ .

If the filtration is maximal, then each matrix  $M_{[i]}$  is irreducible. If  $M_{[i]}$  is nonzero and irreducible, then it has the associated Perron-Frobenius eigenvalue  $\lambda_i \geq 1$ . If  $\lambda_i > 1$ , then the stratum  $H_i$  is called *exponential*. If  $\lambda_i = 1$ , then  $H_i$  is called *polynomial*. In this case  $M_{[i]}$  is a permutation matrix, hence for every edge  $E \in H_i^1$  the path  $f(E)$  contains exactly one edge of  $H_i$ , all other edges of  $f(E)$  lie in  $G_{r-1}$ . A stratum  $H_i$  is called a *zero stratum* if  $M_{[i]}$  is a zero matrix. In this case  $f(E)$  lies in  $G_{i-1}$  for every edge  $E \in H_i^1$ .

**Definition 4.1.** Let  $\Gamma$  be a finite connected graph and let  $f : \Gamma \rightarrow \Gamma$  be a tight and nondegenerate homotopy equivalence from the class  $\mathcal{PLHE}$ . The map  $f$  is called a *PL-relative train track* if there exists a maximal filtration  $\emptyset = G_0 \subset \dots \subset G_N = \Gamma$  for  $f$  such that each exponential stratum  $H_r$  of this filtration satisfies the following conditions:

- (RTT-i)  $Df$  maps the set of edges of  $H_r$  to itself; in particular all mixed turns in  $(G_r, G_{r-1})$  are legal.
- (RTT-ii) If  $\rho \subset G_{r-1}$  is a reduced nontrivial edge path with endpoints in  $H_r \cap G_{r-1}$ , then  $[f(\rho)]$  is a nontrivial edge path with endpoints in  $H_r \cap G_{r-1}$ .
- (RTT-iii) For each legal edge path  $\rho \subset H_r$ , the path  $f(\rho)$  does not contain any illegal turns in  $H_r$ .

**Definition 4.2.** We use the above notations. Let  $H_r$  be an exponential stratum. A nontrivial reduced path  $\rho$  in  $G_r$  is called  *$r$ -legal* if the minimal edge path containing  $\rho$  does not contain any illegal turns in  $H_r$ .

The following proposition will be often used in the further proof.

**Proposition 4.3.** (see [7, Lemma 5.8]) *Suppose that  $f : \Gamma \rightarrow \Gamma$  is a relative train track and  $H_r$  is an exponential stratum of  $\Gamma$ . Let  $\rho$  be a reduced  $r$ -legal path:*

$$\rho \equiv b_0 \cdot a_1 \cdot b_1 \cdot \dots \cdot a_k \cdot b_k,$$

where  $k \geq 1$ ,  $a_1, \dots, a_k$  are paths in  $H_r$ , and  $b_0, \dots, b_k$  are paths in  $G_{r-1}$ , and all these paths except maybe  $b_0$  and  $b_k$  are nontrivial. Then

$$[f(\rho)] \equiv [f(b_0)] \cdot f(a_1) \cdot [f(b_1)] \cdot \dots \cdot f(a_k) \cdot [f(b_k)]$$

and this path is  $r$ -legal. Moreover, for all  $i \geq 1$  we have

$$[f^i(\rho)] \equiv [f^i(b_0)] \cdot [f^i(a_1)] \cdot [f^i(b_1)] \cdot \dots \cdot [f^i(a_k)] \cdot [f^i(b_k)]$$

and these paths are  $r$ -legal.

**The  $r$ -length function  $L_r$ .** Let  $f : \Gamma \rightarrow \Gamma$  be a PL-relative train track and  $H_r$  be an exponential stratum. Choose a positive vector  $\vec{v}$  satisfying  $\vec{v}M_{[r]} = \lambda_r \vec{v}$ . Since  $M_{[r]}$  is an integer matrix, we can choose  $\vec{v}$  so that the coordinates of  $\vec{v}$  are rational functions of  $\lambda_r$  over  $\mathbb{Q}$ . If  $E_i$  is the  $i^{\text{th}}$  edge of  $H_r$ , define  $L_r(E_i) = v_i$ ; if  $E$  is an edge of  $G_{r-1}$ , define  $L_r(E) = 0$ . For an arbitrary edge path  $\tau$  in  $G_r$ , we define its  $r$ -length  $L_r(\tau)$  as the sum of  $r$ -lengths of edges of  $\tau$ . Then we have  $L_r(f(E)) = \lambda_r L_r(E)$ .

We extend this definition to all paths (not necessarily edge paths) in  $G_r$ , as it was done in Lemma 5.10 in [7]. For an arbitrary path  $\mu$  in  $G_r$ , let  $L_r^\bullet(\mu)$  be the sum of  $L_r$ -lengths of full  $r$ -edges which occur in  $\mu$  if they exist and zero if not. For any path  $\rho$  in  $G_r$ , we set

$$L_r(\rho) := \lim_{k \rightarrow \infty} \lambda_r^{-k} L_r^\bullet(f^k(\rho)).$$

**Lemma 4.4.** *The function  $L_r$  has the following properties:*

- 1)  $L_r(f(\rho)) = \lambda_r L_r(\rho)$  for any path  $\rho$  in  $G_r$ .
- 2)  $L_r([f(\rho)]) = \lambda_r L_r(\rho)$  for any reduced  $r$ -legal path  $\rho$  in  $G_r$ .
- 3) If  $\rho$  is a nontrivial initial or terminal segment of an  $r$ -edge, then  $L_r(\rho) > 0$ .
- 4) If  $\rho$  is a nontrivial segment of an  $r$ -edge, then there exists  $k \in \mathbb{N}$  such that  $f^k(\rho)$  does not lie in an  $r$ -edge.
- 5) If  $\rho$  is a nontrivial path in  $G_r$  with  $L_r(\rho) = 0$ , then there exists  $k \in \mathbb{N}$  such that  $f^k(\rho)$  lies in  $G_{r-1}$ .

*Proof.* 1) follows from the definition of  $L_r$ , 2) from Proposition 4.3, and 3) from (RTT-i) and 4). We prove 4). For that we use the following claims:

- i) For each  $k \in \mathbb{N}$ , the map  $f^k$  restricted to each component of  $\Gamma \setminus f^{-k}(\Gamma^0)$  is linear with respect to the metric  $l$ .
- ii) Let  $k_0$  be the number of  $r$ -edges in  $H_r$  plus 1. Then for each  $r$ -edge  $E$  the path  $f^{k_0}(E)$  contains at least two  $r$ -edges.

The first claim follows from the assumption that  $f$  lies in the class  $\mathcal{PLHE}$ , the second one from the assumption that the stratum  $H_r$  is irreducible and exponential.

Below we define a number  $0 < a < 1$  satisfying the following property: if  $\rho$  is a nontrivial segment of an  $r$ -edge and  $f^{k_0}(\rho)$  lies in an  $r$ -edge, then  $l(f^{k_0}(\rho)) \geq l(\rho)/a$ .

Let  $E$  be an  $r$ -edge and suppose that  $f^{k_0}(E) \equiv E_1 b_1 E_2 \dots b_{s-1} E_s$ , where  $E_1, \dots, E_s$  are  $r$ -edges and  $b_1, \dots, b_{s-1}$  are paths in  $G_{r-1}$  or trivial. Write  $E \equiv E'_1 b'_1 E'_2 \dots b'_{s-1} E'_s$ , where  $f^{k_0}(E'_i) \equiv E_i$  and  $f^{k_0}(b'_i) \equiv b_i$ . Since  $s \geq 2$ , the number

$$a_E := \max\{l(E'_i) \mid i = 1, \dots, s\}$$

is smaller than 1. Let  $a$  be the maximum of  $a_E$  over all  $r$ -edges  $E$ . Then  $a$  has the desired property.

To complete 4), we take the minimal  $m \in \mathbb{N}$  with  $l(\rho) > a^m$ . Then  $f^{k_0 m}(\rho)$  does not lie in an  $r$ -edge.

Now we prove 5). Since  $L_r(\rho) = 0$ , the statement 3) implies that  $\rho$  lies either in  $G_{r-1}$ , or in the interior of an  $r$ -edge. In the first case we are done. In the second case, by 4), there exists  $k \in \mathbb{N}$  such that  $f^k(\rho)$  does not lie in an  $r$ -edge. Again 3) implies that  $f^k(\rho)$  lies in  $G_{r-1}$ .  $\square$

**A representation of an outer automorphism of  $F_n$  by a PL-relative train track.** The rose with  $n$  petals  $R_n$  is the graph with one vertex  $*$  and  $n$  geometric edges. We assume that the free group on  $n$  letters  $F_n$  is identified with  $\pi_1(R_n, *)$ . Obviously, every automorphism  $\varphi$  of  $F_n$  can be represented by a homotopy equivalence  $R_n \rightarrow R_n$ .

In [7, Theorem 5.12]), Bestvina and Handel proved that every outer automorphism  $\mathcal{O}$  of  $F_n$  can be represented by a relative train track  $f : \Gamma \rightarrow \Gamma$ . One can show that this proof can be organized in a constructive way. Also, we may assume that  $f$  is a PL-relative train track. Thus, we have the following start-point for our algorithm.

**Theorem 4.5.** (see [7, Theorem 5.12]) *Let  $F_n$  be the free group of finite rank  $n$ . There is an efficient algorithm which, given an outer automorphism  $\mathcal{O}$  of  $F$ , constructs a PL-relative train track  $f : \Gamma \rightarrow \Gamma$  and a homotopy equivalence (a marking)  $\tau : R_n \rightarrow \Gamma$  such that  $f$  represents  $\mathcal{O}$  with respect to  $\tau$ .*

The latter means that for any homotopy equivalence  $\sigma : \Gamma \rightarrow R_n$  which is a homotopy inverse to  $\tau$ , the map  $(\tau f \sigma)_* : \pi_1(R_n, *) \rightarrow \pi_1(R_n, *)$  represents  $\mathcal{O}$ . Below we give a reformulation of this theorem, see Theorem 5.3.

### 5. RELATIVE TRAIN TRACKS FOR AUTOMORPHISMS OF FREE GROUPS

Let  $F$  be a free group of finite rank,  $\varphi$  be an automorphism of  $F$ , and  $\mathcal{O}$  be the outer automorphism class of  $\varphi$ . Theorem 4.5 gives a representation of  $\mathcal{O}$  by a PL-relative train track. However this is not sufficient for our aims. The purpose of this section is to show that  $\varphi$  itself can be represented by a PL-relative train track, see Theorem 5.4.

**Notation 5.1.** Let  $\Gamma$  be a finite connected graph and  $f : \Gamma \rightarrow \Gamma$  be a homotopy equivalence. For each vertex  $v \in \Gamma^0$  we define the isomorphism

$$f_v : \pi_1(\Gamma, v) \rightarrow \pi_1(\Gamma, f(v)),$$

$$[[\mu]] \mapsto [[f(\mu)]], \text{ where } [[\mu]] \in \pi_1(\Gamma, v).$$

For each path  $p$  in  $\Gamma$  from  $v$  to  $f(v)$  we define the automorphism

$$f_{v,p} : \pi_1(\Gamma, v) \rightarrow \pi_1(\Gamma, v),$$

$$[[\mu]] \mapsto [[pf(\mu)\bar{p}]], \text{ where } [[\mu]] \in \pi_1(\Gamma, v).$$

**Remark 5.2.** By Theorem 4.5, given an automorphism  $\varphi$  of  $F$ , one can construct a finite connected graph  $\Gamma$ , a PL-relative train track  $f : \Gamma \rightarrow \Gamma$ , and an isomorphism  $i : F \rightarrow \pi_1(\Gamma, v)$ , where  $v$  is a vertex of  $\Gamma$ , such that the automorphism  $i^{-1}\varphi i : \pi_1(\Gamma, v) \rightarrow \pi_1(\Gamma, v)$  coincides with  $f_{v,p}$  for an appropriate path  $p \subset \Gamma$  from  $v$  to  $f(v)$ .

We claim that  $p$  can be computed. Indeed, if  $q$  is an arbitrary path in  $\Gamma$  from  $v$  to  $f(v)$ , then  $f_{v,q}$  differs from  $f_{v,p}$  by an inner automorphism of  $\pi_1(\Gamma, v)$ . Comparing  $f_{v,q}$  with  $i^{-1}\varphi i$ , we can compute this inner automorphism and hence  $p$ . This gives us the following form of Theorem 4.5.

**Theorem 5.3.** *Let  $F$  be a free group of finite rank. There is an efficient algorithm which, given an automorphism  $\varphi$  of  $F$ , constructs a PL-relative train track  $f : \Gamma \rightarrow \Gamma$  and indicates a vertex  $v \in \Gamma^0$ , a path  $p \subset \Gamma$  from  $v$  to  $f(v)$ , and an isomorphism  $i : F \rightarrow \pi_1(\Gamma, v)$  such that the automorphism  $i^{-1}\varphi i : \pi_1(\Gamma, v) \rightarrow \pi_1(\Gamma, v)$  coincides with  $f_{v,p}$ .*

The following theorem says that in Theorem 5.3 we can provide  $f(v) = v$  and choose  $p$  equal to the trivial path at  $v$ .

**Theorem 5.4.** *Let  $F$  be a free group of finite rank. There is an efficient algorithm which, given an automorphism  $\varphi$  of  $F$ , constructs a PL-relative train track  $f_1 : \Gamma_1 \rightarrow \Gamma_1$  with a vertex  $v_1 \in \Gamma_1^0$  fixed by  $f_1$ , and indicates an isomorphism  $j : F \rightarrow \pi_1(\Gamma_1, v_1)$  such that  $j^{-1}\varphi j = (f_1)_{v_1}$ .*

*Proof.* Let  $f : \Gamma \rightarrow \Gamma$ ,  $v$ ,  $p$ , and  $i : F \rightarrow \pi_1(\Gamma, v)$  be the PL-relative train track, the vertex, the path, and the isomorphism from Theorem 5.3, respectively. Then we have  $\varphi i = i f_{v,p}$ . Hence, for every  $w \in F$ , we have

$$i(\varphi(w)) = [[p]] [[f(i(w))]] [[\bar{p}]]. \quad (5.1)$$

Let  $\Gamma_1$  be the graph obtained from  $\Gamma$  by adding a new vertex  $v_1$  and a new edge  $E$  connecting  $v_1$  and  $f(v)$ . We extend the homotopy equivalence  $f : \Gamma \rightarrow \Gamma$  to a map  $f_1 : \Gamma_1 \rightarrow \Gamma_1$  by the rule  $f_1(v_1) = v_1$  and  $f_1(E) := Ef(p)$ . Clearly,  $f_1$  is a homotopy equivalence. We define a maximal filtration for  $f_1$  by extending the maximal filtration for  $f$  with the help of the new top polynomial stratum consisting of the edges  $E$  and  $\bar{E}$ . Finally, we define the isomorphism  $j : F \rightarrow \pi_1(\Gamma_1, v_1)$  by the rule

$$j(w) := [[E]] [[f(i(w))]] [[\bar{E}]], \quad w \in F. \quad (5.2)$$

To complete the proof, we verify that the automorphism  $j^{-1}\varphi j$  of the group  $\pi_1(\Gamma_1, v_1)$  coincides with the induced automorphism  $(f_1)_{v_1} : \pi_1(\Gamma_1, v_1) \rightarrow \pi_1(\Gamma_1, v_1)$ . It suffices to check that  $(f_1)_{v_1}(j(w)) = j(\varphi(w))$  for any  $w \in F$ :

$$\begin{aligned} (f_1)_{v_1}(j(w)) &\stackrel{(5.2)}{=} (f_1)_{v_1}([[E]] [[f(i(w))]] [[\bar{E}]]) = [[f_1(E)]] [[f^2(i(w))]] [[f_1(\bar{E})]] = \\ &[[Ef(p)]] [[f^2(i(w))]] [[f(\bar{p})\bar{E}]] = [[E]] [[f(pf(i(w))\bar{p})]] [[\bar{E}]] \stackrel{(5.1)}{=} \end{aligned}$$

$$[[E]] [[f(i(\varphi(w)))] [[\bar{E}]] \stackrel{(5.2)}{=} j(\varphi(w)).$$

□

Thus, for computing a basis of  $\text{Fix}(\varphi)$ , it suffices to compute a basis of the group

$$\overline{\text{Fix}}(f_1) = \{[[\mu]] \in \pi_1(\Gamma_1, v_1) \mid f_1(\mu) = \mu\},$$

where  $\Gamma_1$  is the graph,  $v_1$  is the vertex, and  $f_1$  is the PL-relative train track from Theorem 5.4. In Section 12, we will show that we may assume that  $f_1$  satisfies (RTT-iv).

### 6. AUXILIARY STATEMENTS

Let  $F$  be a free group of finite rank with a fixed basis  $X$ . For any element  $w \in F$  let  $|w|$  be the length of  $w$  with respect to  $X$ .

The following theorem was proven by P. Brinkmann in [13, Theorem 0.1].

**Theorem 6.1.** *There exists an efficient algorithm which, given an automorphism  $\varphi$  of a free group  $F$  of finite rank and given elements  $u, v \in F$ , verifies, whether there exists a natural  $N$  such that  $\varphi^N(u) = v$ . If such  $N$  exists, then the algorithm computes  $N$  as well.*

**Corollary 6.2.** *There exists an efficient algorithm which, given a finite connected graph  $\Gamma$  and a homotopy equivalence  $f : \Gamma \rightarrow \Gamma$  with  $f(\Gamma^0) \subseteq \Gamma^0$ , and given two edge paths  $\rho, \tau$  in  $\Gamma$ , decides whether there exists a natural number  $k$  such that  $f^k(\rho) = \tau$ . If such  $k$  exists, then the algorithm computes it.*

*Proof.* First we reduce the problem to the case, where  $f$  fixes the endpoints of  $\rho$ . Let  $u_i$  and  $v_i$  be the initial and the terminal vertices of  $\rho_i := f^i(\rho)$ . Since  $f$  acts on the finite set  $\Gamma^0 \times \Gamma^0$ , there exist natural numbers  $r, n$  such that  $(u_i, v_i) = (u_{i+n}, v_{i+n})$  for  $i \geq r$ .

First we check, whether  $f^k(\rho) = \tau$  for  $k < r$ . If yes, we are done, if no we investigate the case  $k \geq r$ . Given such  $k$ , we can write  $k = i + \ell n$  for some  $\ell \geq 0$  and  $r \leq i < r + n$ . So, we have  $f^k(\rho) = g^\ell(\rho_i)$ , where  $g := f^n$ . Thus we have to investigate  $n$  problems: does there exist  $\ell \geq 0$  such that  $g^\ell(\rho_i) = \tau$ ,  $r \leq i < r + n$ . Note that  $g$  fixes the endpoints of  $\rho_i$ .

So, from the beginning, we may assume that  $f$  fixes the endpoints of  $\rho$  and  $\alpha(\rho) = \alpha(\tau)$ , and  $\omega(\rho) = \omega(\tau)$ .

Let  $\Gamma_1$  be the graph obtained from  $\Gamma$  by adding a new vertex  $v$  and two new oriented edges:  $E_1$  from  $v$  to  $\alpha(\rho)$  and  $E_2$  from  $v$  to  $\omega(\rho)$ . Let  $f_1 : \Gamma_1 \rightarrow \Gamma_1$  be the extension of  $f$  mapping  $E_1$  to  $E_1$  and  $E_2$  to  $E_2$ . Clearly,  $f_1$  is a homotopy equivalence which fixes  $v$ . Let  $(f_1)_v : \pi_1(\Gamma_1, v) \rightarrow \pi_1(\Gamma_1, v)$  be the induced automorphism. We have

$$f^k(\rho) = \tau \iff f_1^k(E_1\rho\bar{E}_2) = E_1\tau\bar{E}_2 \iff (f_1)_v^k([[E_1\rho\bar{E}_2]]) = [[E_1\tau\bar{E}_2]].$$

Thus, the problem is solvable by Theorem 6.1.  $\square$

**Corollary 6.3.** *There exists an efficient algorithm which, given a finite connected graph  $\Gamma$  and a homotopy equivalence  $f : \Gamma \rightarrow \Gamma$  with  $f(\Gamma^0) \subseteq \Gamma^0$ , and given two edge paths  $\rho, \tau$  in  $\Gamma$ , decides whether there exist natural numbers  $k > s$  such that  $f^k(\rho) = f^s(\tau)$ . If such  $k$  and  $s$  exist, then the algorithm computes them.*

*Proof.* Let  $u_i$  and  $v_i$  be the initial and the terminal vertices of  $f^i(\rho)$ ,  $i \geq 0$ , and let  $u'_j$  and  $v'_j$  be the initial and the terminal vertices of  $f^j(\tau)$ ,  $j \geq 0$ . First we can decide, whether there exist  $i, j$  such that  $(u_i, v_i) = (u'_j, v'_j)$ . If such  $i, j$  don't exist, then the desired  $k, s$  don't exist. If such  $i, j$  exist, we can algorithmically find natural  $i, j, n$  with the following properties:

- 1)  $(u_i, v_i) = (u'_j, v'_j)$ ;
- 2)  $(u_i, v_i) = (u_{i+n}, v_{i+n})$  and  $n$  is minimal;
- 3)  $i > j$ ;
- 4)  $i - j$  is the minimal possible for 1)-3).

So, we reduce the problem to the following: does there exist  $p \geq q \geq 0$  such that  $f^{i+pn}(\rho) = f^{j+qn}(\tau)$ ? We set  $\rho_1 := f^i(\rho)$ ,  $\tau_1 := f^j(\tau)$ ,  $g := f^n$ . Then the endpoints of  $\rho_1$  and  $\tau_1$  coincide and are fixed by  $g$ . In this setting we have to decide, whether there exist  $p \geq q \geq 0$  such that  $g^p(\rho_1) = g^q(\tau_1)$ .

We extend  $\Gamma$  to  $\Gamma'$  by adding an edge  $E$  from  $v_i$  to  $u_i$  and we extend  $g$  to  $g' : \Gamma' \rightarrow \Gamma'$  by setting  $g'|_{\Gamma} = g$  and  $g'(E) = E$ . Then the problem is equivalent to the following: does there exist  $p \geq q \geq 0$  such that  $g'^p(\rho_1 E) = g'^q(\tau_1 E)$ ?

Since  $g'$  is a homotopy equivalence and  $\rho_1 E$  and  $\tau_1 E$  are loops based at the same point, and this point is fixed by  $g'$ , we have

$$g'^p(\rho_1 E) = g'^q(\tau_1 E) \iff g'^{p-q}(\rho_1 E) = \tau_1 E.$$

Thus, the problem can be reformulated as follows: does there exist  $m \geq 0$  such that  $g'^m(\rho_1 E) = \tau_1 E$ ? This can be decided by Theorem 6.1.  $\square$

We need the following bounded cancellation lemma from [16], where it is credited to Grayson and Thurston.

**Lemma 6.4.** *Let  $\Gamma$  be a finite connected graph and  $f : \Gamma \rightarrow \Gamma$  be a homotopy equivalence sending edges to edge paths. Let  $\tau_1, \tau_2$  be reduced paths in  $\Gamma$  such that  $\omega(\tau_1) = \alpha(\tau_2)$  and the path  $\tau_1 \tau_2$  is reduced. Then*

$$l([f(\tau_1 \tau_2)]) \geq l([f(\tau_1)]) + l([f(\tau_2)]) - 2C_*,$$

where  $C_* > 0$  is an algorithmically computable constant which depends only on  $f$ .

## 7. GRAPHS $D_f$ AND $CoRe(C_f)$ FOR A HOMOTOPY EQUIVALENCE $f : \Gamma \rightarrow \Gamma$

Let  $\Gamma$  be a finite connected graph with a distinguished vertex  $v_*$ . Let  $f : \Gamma \rightarrow \Gamma$  be a homotopy equivalence which maps vertices of  $\Gamma$  to vertices and edges to



reduced edge paths, and suppose that  $f$  fixes  $v_*$ . We consider the group

$$\overline{\text{Fix}}(f) := \{[[p]] \in \pi_1(\Gamma, v_*) \mid f(p) = p\}.$$

In papers [24, 33], the authors suggest a procedure for computation of a basis of  $\overline{\text{Fix}}(f)$  with the help of a graph  $D_f$ . This procedure is not an algorithm in general case, since one cannot determine from the beginning, whether it terminates or not. We give a description of this procedure. We also show that the procedure can be converted into an algorithm if the Membership and the Finiteness problems can be algorithmically solved.

First, we recall some constructions and facts from [24, 33] and [15].

**A. Definition of  $f$ -paths.** An edge path  $\mu$  in  $\Gamma$  is called an  $f$ -path if the last point of  $\mu$  coincides with the first point of  $f(\mu)$ .

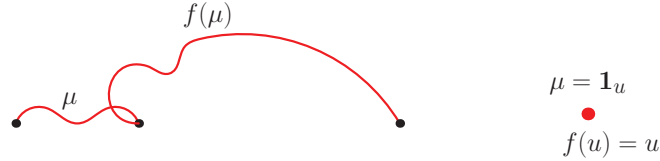

Figure 2.  
Nontrivial and trivial  $f$ -paths  $\mu$ .

We note the following properties of  $f$ -paths:

- the trivial path at a vertex  $u$  of  $\Gamma$ , denoted  $\mathbf{1}_u$ , is an  $f$ -path if and only if  $u$  is fixed by  $f$ ;
- if  $\mu$  is an  $f$ -path, then  $[\mu]$  is also an  $f$ -path;
- if  $\mu$  is an  $f$ -path and  $E$  is an edge in  $\Gamma$  such that  $\alpha(E) = \alpha(\mu)$ , then  $\overline{E}\mu f(E)$  is also an  $f$ -path.

**B. Definition of the graph  $D_f$ .** The vertices of  $D_f$  are *reduced  $f$ -paths* in  $\Gamma$ . Let  $\mu$  be a reduced  $f$ -path in  $\Gamma$  and let  $E_1, \dots, E_n$  be all edges in  $\Gamma$  outgoing from  $\alpha(\mu)$ . Then we connect the vertex  $\mu$  of  $D_f$  to the vertices  $[\overline{E_1}\mu f(E_1)], \dots, [\overline{E_n}\mu f(E_n)]$  by edges with labels  $E_1, \dots, E_n$ , respectively, see Figure 3. The label of a nontrivial edge path in the graph  $D_f$  is the product of labels of consecutive edges of this path. The label of a trivial edge path at a vertex  $\mu$  of  $D_f$  is  $\mathbf{1}_{\alpha(\mu)}$ .

In general, the graph  $D_f$  can have infinitely many connected components and some of them can be infinite. For a vertex  $\mu$  of  $D_f$ , let  $D_f(\mu)$  be the component of  $D_f$  containing  $\mu$ . Lemma 7.3 says that  $\pi_1(D(\mathbf{1}_{v_*}), \mathbf{1}_{v_*}) \cong \overline{\text{Fix}}(f)$ . This was first proved in [24] with the help of preferable directions at vertices of  $D_f$ .

**C. Preferable directions at vertices of  $D_f$ , dead and alive vertices of  $D_f$ .** For a reduced nontrivial  $f$ -path  $\mu$  in  $\Gamma$ , we set  $\widehat{f}(\mu) := [\overline{E}\mu f(E)]$ , where  $E$  is the first edge of  $\mu$ . Then  $\mu$  and  $\widehat{f}(\mu)$  are vertices of the graph  $D_f$  connected by the edge

with the label  $E$ . The direction of this edge is called *preferable* at the vertex  $\mu$ . We will put the symbol  $\triangleright$  on this edge near the vertex  $\mu$ .

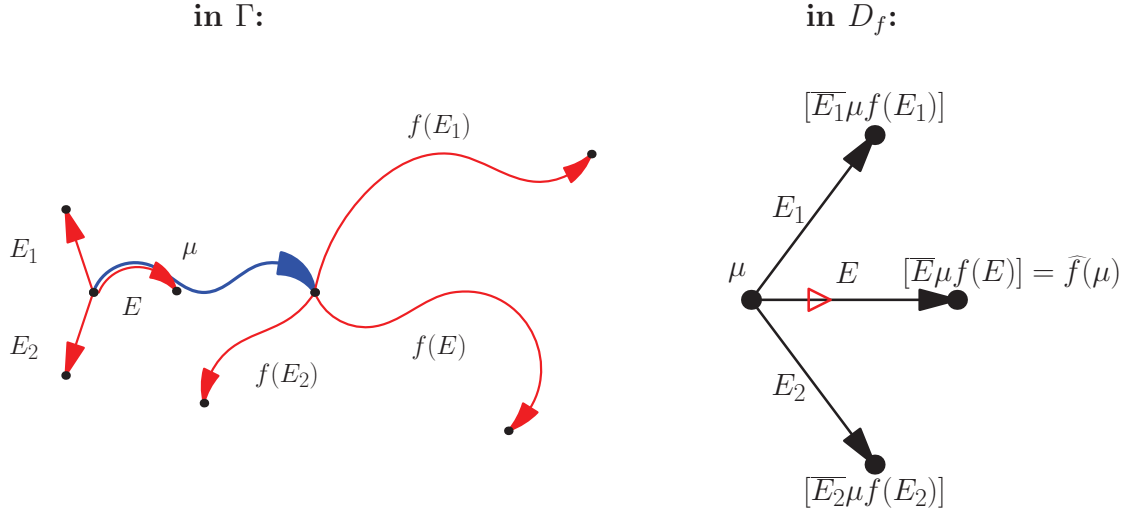

Figure 3.

From the graph  $\Gamma$  to the graph  $D_f$ . On the left we consider  $\mu$  as a path in  $\Gamma$ , on the right as a vertex in  $D_f$ . The red triangle on the right shows the preferable direction at the vertex  $\mu$ .

Note that only the vertices  $\mathbf{1}_w$ , where  $w \in \Gamma^0$  and  $f(w) = w$ , do not admit a preferable direction. We call such vertices *dead* and all other vertices of  $D_f$  *alive*. Observe that at each vertex of  $D_f$ , there is at most one outwardly  $\triangleright$ -directed edge.

#### D. Ordinary, repelling and attracting edges of $D_f$ .

The following definition is illustrated by Figure 4.

**Definition 7.1.** Let  $e$  be an edge of  $D_f$ , let  $p, q$  be the initial and the terminal vertices of  $e$ , and let  $E \in \Gamma^1$  be the label of  $e$ .

- (1) The edge  $e$  is called *ordinary* in  $D_f$  if one of the following holds:
  - (a)  $E$  is the first edge of the path  $p$  in  $\Gamma$  and  $\overline{E}$  is not the first edge of the path  $q$  in  $\Gamma$ .
  - (b)  $E$  is not the first edge of the path  $p$  in  $\Gamma$  and  $\overline{E}$  is the first edge of the path  $q$  in  $\Gamma$ .
- (2) The edge  $e$  is called *repelling* in  $D_f$  if  $E$  is not the first edge of the path  $p$  in  $\Gamma$  and  $\overline{E}$  is not the first edge of the path  $q$  in  $\Gamma$ .  
A vertex of  $D_f$  is called *repelling* if it is the initial or the terminal vertex of a repelling edge.

- (3) The edge  $e$  is called *attracting* in  $D_f$  if  $E$  is the first edge of the path  $p$  in  $\Gamma$  and  $\overline{E}$  is the first edge of the path  $q$  in  $\Gamma$ .

An edge of  $D_f$  is called *exceptional* if it is attracting or repelling.

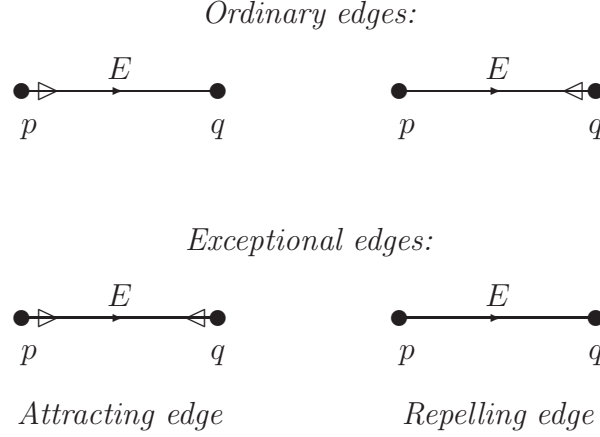
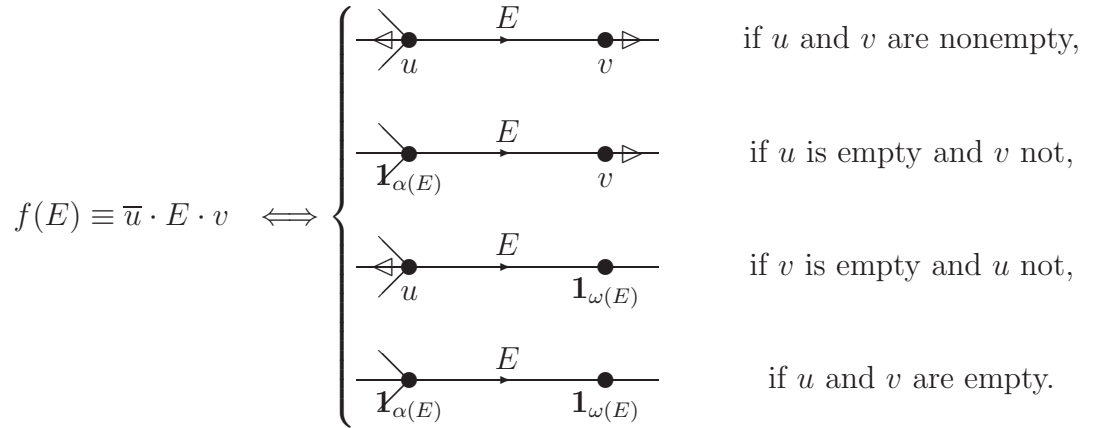
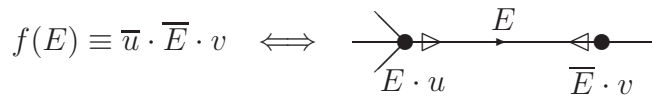

Figure 4. Different types of edges in  $D_f$ .

**Proposition 7.2.** (see [24, 33] and [15]) (a) *The repelling edges of  $D_f$  are in 1-1 correspondence with the occurrences of edges  $E$  in  $f(E)$ , where  $E \in \Gamma^1$ . More precisely, there exists a bijection of the type:*



(b) *The attracting edges of  $D_f$  are in 1-1 correspondence with the occurrences of edges  $\overline{E}$  in  $f(E)$ , where  $E \in \Gamma^1$ . More precisely, there exists a bijection of the type:*



(c) *There exist only finitely many exceptional edges in  $D_f$  and they can be algorithmically found.*

The following fundamental lemma was first proved by Goldstein and Turner in [24]. We reproduce here their nice proof for completeness.

**Lemma 7.3.** (see [24]) *The fundamental group of each component of  $D_f$  is finitely generated. Moreover,  $\pi_1(D_f(\mathbf{1}_{v_*}), \mathbf{1}_{v_*}) \cong \overline{\text{Fix}}(f)$ .*

*Proof.* Observe that a connected locally finite graph has finite rank if and only if the edges of this graph can be directed so that at all but a finite number of vertices, there is at most one outwardly directed edge.

Let  $D'_f$  be the graph obtained from  $D_f$  by removing all exceptional edges. Each component of  $D'_f$  has only ordinary edges, and these edges carry preferable directions which satisfy the above observation. Hence each component of  $D'_f$  has finite rank. Since there is only finitely many exceptional edges in  $D_f$ , each component of  $D_f$  has finite rank.

Let us prove the second claim in a more general context. Let  $\mu$  be a vertex in  $D_f$  and suppose that  $c$  is a closed path in  $D_f$  based at  $\mu$ . Let  $\ell = E_1 E_2 \dots E_k$  be the label of  $c$ ; so all  $E_i$  are edges in  $\Gamma$ . Then

$$\mu, [\overline{E_1} \mu f(E_1)], [\overline{E_2} \overline{E_1} \mu f(E_1) f(E_2)], \dots, [\overline{\ell} \mu f(\ell)]$$

are consecutive vertices of  $c$  and we have  $[\overline{\ell} \mu f(\ell)] = \mu$ .

So,  $\ell$  is a closed edge path in  $\Gamma$  based at  $\alpha(\mu)$  and satisfying  $[\mu f(\ell) \overline{\mu}] = [\ell]$ . The correspondence  $c \mapsto \ell$  induces the isomorphism

$$\pi_1(D_f(\mu), \mu) \cong \{[[p]] \in \pi_1(\Gamma, \alpha(\mu)) \mid [[\mu f(p) \overline{\mu}]] = [[p]]\}.$$

Setting  $\mu := \mathbf{1}_{v_*}$ , we obtain the second claim of the lemma.  $\square$

**E. Definition of a  $\mu$ -subgraph of  $D_f$ .** Let  $\mu$  be a vertex in  $D_f$ . If  $\mu$  is not a dead vertex, i.e. if  $\mu \equiv E_1 E_2 \dots E_m$  for some edges  $E_i \in \Gamma^1$ ,  $m \geq 1$ , we can pass from  $\mu$  to the vertex  $\widehat{f}(\mu) \equiv [E_2 \dots E_m f(E_1)]$  by using the direction which is preferable at  $\mu$ .

The vertices of the  $\mu$ -subgraph are the vertices  $\mu_1, \mu_2, \dots$  of  $D_f$  such that  $\mu_1 = \mu$  and  $\mu_{i+1} = \widehat{f}(\mu_i)$  if the vertex  $\mu_i$  is not dead,  $i \geq 1$ . The edges of the  $\mu$ -subgraph are those which connect  $\mu_i$  with  $\mu_{i+1}$  and carry the preferable direction at  $\mu_i$ .

Note that the  $\mu$ -subgraph is finite if and only if starting from  $\mu$  and moving along the preferable directions we will come to a dead vertex or to a vertex which

we have seen earlier. If the  $\mu$ -subgraph is infinite, we call it a  $\mu$ -ray. Thus, any  $\mu$ -subgraph is one of the following four types:

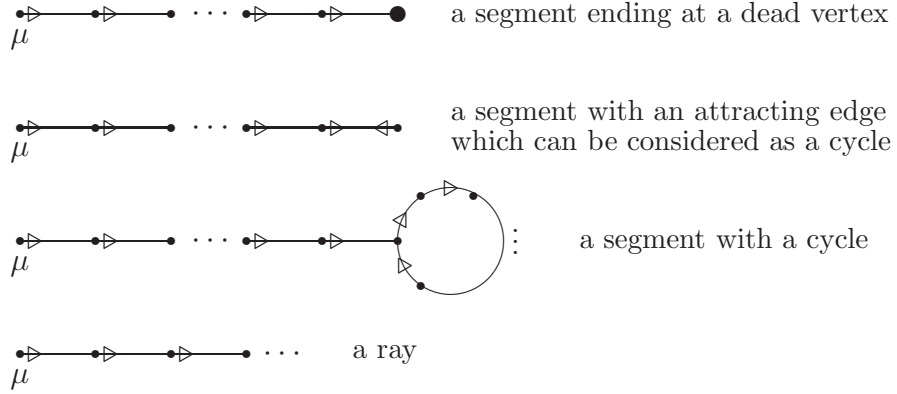

Figure 5.

The types of  $\mu$ -subgraphs in  $D_f$ .

Let  $\mu$  and  $\tau$  be two vertices of  $D_f$ . Clearly, if the  $\mu$ -subgraph and the  $\tau$ -subgraph intersect, then they differ only by their finite “initial subsegments”. The vertex  $\mu_i$  from this intersection with minimal  $i$  is called the *intersection point* of these subgraphs.

Note the following properties of  $\mu$ -subgraphs:

- if  $\mu_0$  is a vertex of a  $\mu$ -subgraph, then the  $\mu_0$ -subgraph is contained in the  $\mu$ -subgraph;
- if  $\mu_0$  is a vertex of a  $\mu$ -subgraph and  $\tau_0$  is a vertex of a  $\tau$ -subgraph, then the  $\mu$ -subgraph and the  $\tau$ -subgraph intersect if and only if the  $\mu_0$ -subgraph and the  $\tau_0$ -subgraph intersect;
- a  $\mu$ -ray does not intersect a finite  $\tau$ -subgraph.

From this point, we start to develop the above approach.

**F. Definitions of the graphs  $C_f$  and  $CoRe(C_f)$ .** A component of  $D_f$  is called *repelling* if it contains at least one repelling edge. Let  $C_1, \dots, C_n$  be all repelling components of  $D_f$ . For each  $C_i$ , let  $CoRe(C_i)$  be the minimal connected subgraph of  $C_i$  which contains all repelling edges of  $C_i$  and carries  $\pi_1(C_i)$ . We set  $C_f := \bigcup_{i=1}^n C_i$  and  $CoRe(C_f) := \bigcup_{i=1}^n CoRe(C_i)$ .

Below we show how to compute a basis of the group  $\pi_1(D_f(\mathbf{1}_{v_*}), \mathbf{1}_{v_*})$  if we know how to construct the graph  $CoRe(C_f)$ .

**Lemma 7.4.** *Let  $\mathbf{1}_u$  be a dead vertex of  $D_f$ . If the component  $D_f(\mathbf{1}_u)$  is non-contractible, then it lies in  $C_f$ .*

*Proof.* Suppose that  $D_f(\mathbf{1}_u)$  is non-contractible. Then there exists an edge path  $p = E_1 E_2 \dots E_k$  in  $D_f(\mathbf{1}_u)$  such that  $\omega(E_k) = \mathbf{1}_u$ , the edges of  $p$  are distinct, and  $\alpha(E_1) = \omega(E_s)$  for some  $1 \leq s \leq k$ . We show that  $p$  contains a repelling edge. Suppose not, then the direction of  $E_k$  is preferable at  $\alpha(E_k)$ . By induction, the direction of  $E_i$  is preferable at the point  $\alpha(E_i)$  for every  $i = 1, \dots, k$  (see Figure 6). In particular,  $\alpha(E_1) \neq \mathbf{1}_u$ , and hence  $k > s$ . Then there are two preferable directions at  $\alpha(E_1)$ , namely the direction of  $E_1$  and the direction of  $E_{s+1}$ , a contradiction. Thus,  $p$  must contain a repelling edge.  $\square$

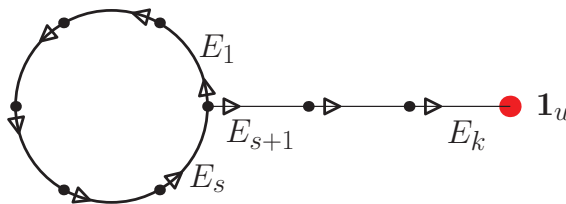

Figure 6.

**Lemma 7.5.** *Let  $\mathbf{1}_u$  be a dead vertex of  $D_f$ . The vertex  $\mathbf{1}_u$  lies in  $C_f$  if and only if it lies in the  $\mu$ -subgraph for some repelling vertex  $\mu$ .*

*Proof.* Suppose that  $\mathbf{1}_u$  lies in  $C_f$ . Then there exists a shortest path  $E_1 E_2 \dots E_k$ , where the edge  $E_1$  is repelling and  $\omega(E_k) = \mathbf{1}_u$ . If  $k = 1$ , then  $\mathbf{1}_u$  is repelling as a vertex of a repelling edge, and we are done. If  $k \geq 2$ , the edges  $E_2, \dots, E_k$  are not repelling. In particular, the preferable direction at  $\alpha(E_k)$  coincides with the direction of  $E_k$ . By induction one can prove that the preferable direction at  $\alpha(E_i)$  coincides with the direction of  $E_i$  for  $i \geq 2$ . Then  $\mathbf{1}_u$  lies in the  $\mu$ -subgraph for  $\mu := \omega(E_1)$  and the vertex  $\mu$  is repelling. The converse claim is clear.  $\square$

**Proposition 7.6.** *Suppose we can algorithmically construct  $CoRe(C_f)$  and decide whether there exists a repelling vertex  $\mu$  such that the  $\mu$ -subgraph contains the vertex  $\mathbf{1}_{v_*}$ , and if such  $\mu$  exists, we can compute the  $\mu$ -subgraph. Then we can compute a basis of  $\pi_1(D_f(\mathbf{1}_{v_*}), \mathbf{1}_{v_*})$ .*

*Proof.* Suppose that  $\mathbf{1}_{v_*}$  does not lie in the  $\mu$ -subgraph for any repelling vertex  $\mu$ . Then, by Lemma 7.5,  $\mathbf{1}_{v_*} \notin C_f$  and, by Lemma 7.4,  $D_f(\mathbf{1}_{v_*})$  is contractible.

Now suppose that  $\mathbf{1}_{v_*}$  lies in the  $\mu$ -subgraph for some repelling vertex  $\mu$ . Since  $CoRe(C_f)$  is supposed to be constructible and each repelling vertex lies in  $CoRe(C_f)$ , we can find the component of  $CoRe(C_f)$  containing  $\mu$ . Let  $\Delta$  be the union of

this component and the  $\mu$ -subgraph; note that the  $\mu$ -subgraph terminates at  $\mathbf{1}_{v_*}$ . Then  $\Delta$  is a core of  $D_f(\mathbf{1}_{v_*})$  containing  $\mathbf{1}_{v_*}$ . In particular, we can compute a basis of  $\pi_1(D_f(\mathbf{1}_{v_*}), \mathbf{1}_{v_*})$ .  $\square$

**G. To construct the graph  $CoRe(C_f)$ , it suffices to do the following:**

- (1) Find all repelling edges of  $D_f$ .
- (2) For each alive repelling vertex  $\mu$  determine, whether the  $\mu$ -subgraph is finite or not.
- (3) Compute all elements of all finite  $\mu$ -subgraphs from (2).
- (4) For each two repelling vertices  $\mu$  and  $\tau$  with infinite  $\mu$ - and  $\tau$ -subgraphs determine, whether these subgraphs intersect.
- (5) If the  $\mu$ -subgraph and the  $\tau$ -subgraph from (4) intersect, find their first intersection point and compute their initial segments up to this point.

To convert this procedure to an algorithm, we shall construct algorithms for steps (2) and (4). In papers [15] and [33] these algorithms are given only in some special cases (for positive automorphisms and for irreducible automorphisms represented by train tracks for which each fixed point is a vertex). The main idea in these papers is to use an *inverse preferred direction* at vertices in the graph  $D_f$ . This direction can be constructed algorithmically (in general case) with the help of a homotopic inverse to  $f$ . It determines its own repelling edges and repelling and dead vertices; they can be algorithmically found.

**H. Inverse preferred directions in  $D_f$ .** We will realize the following plan. First we define a map  $g : \Gamma \rightarrow \Gamma$  which is a homotopy inverse to  $f : \Gamma \rightarrow \Gamma$ . Then we show that there is a label preserving graph map  $\Phi : D_f \rightarrow D_g$ . Finally we define the inverse preferred directions at vertices in  $D_f$  by pulling back the preferred directions in  $D_g$  by  $\Phi$ . This idea is due to Turner [33], and has sources in the paper of Cohen and Lustig [15]. Note that in [33], the map  $\Phi$  is claimed to be locally injective (see Proposition in Section 3 there), and we claim that  $\Phi$  is an isomorphism.

**Definition 7.7.** For the given homotopy equivalence  $f : \Gamma \rightarrow \Gamma$ , we can efficiently construct a homotopy equivalence  $g : \Gamma \rightarrow \Gamma$  such that  $g$  maps vertices of  $\Gamma$  to vertices, edges to edge paths, and the maps  $h := g \circ f$  and  $f \circ g$  are homotopic to the identity on  $\Gamma$ . From now on, we fix  $g$ . Let  $H : \Gamma \times [0, 1] \rightarrow \Gamma$  be a homotopy from the identity  $id$  to  $h$ . For each point  $u$  in  $\Gamma$ , let  $p_u$  be the path from  $u$  to  $h(u)$  determined by the homotopy  $H$ : namely  $p_u(t) = H(u, t)$ ,  $t \in [0, 1]$ . We set  $K_*(f) := \max\{l(p_u) : u \in \Gamma^0\}$ .

First we define a map  $\Phi$  from the set of vertices of  $D_f$  to the set of vertices of  $D_g$ . Let  $\mu$  be a vertex in  $D_f$ . We consider  $\mu$  as a reduced  $f$ -path in  $\Gamma$  and let  $u$  be the initial vertex of  $\mu$ . Then we set  $\Phi(\mu) = [p_u g(\bar{\mu})]$ . Clearly,  $\Phi(\mu)$  is a reduced  $g$ -path in  $\Gamma$ . Hence  $\Phi(\mu)$  can be considered as a vertex in  $D_g$ .

**Lemma 7.8.** *The map  $\Phi$  can be continued to a graph map  $\Phi : D_f \rightarrow D_g$  preserving the labels of edges.*

*Proof.* Let  $\mu$  and  $\mu_1$  be two vertices in  $D_f$  connected by an edge with label  $E$ , i.e.  $\mu_1 = [\overline{E}\mu f(E)]$ . We must show that  $\Phi(\mu)$  and  $\Phi(\mu_1)$  are connected by an edge with the label  $E$ , i.e.  $\Phi(\mu_1) = [\overline{E}\Phi(\mu)g(E)]$ . Let  $u$  and  $w$  be the initial and the terminal vertices of  $E$ . Then  $u$  and  $w$  are the initial vertices of  $\mu$  and  $\mu_1$ , respectively. We have

$$\Phi(\mu_1) = [p_w g(f(\overline{E})\overline{\mu}E)] = [p_w h(\overline{E})g(\overline{\mu})g(E)] = [\overline{E}p_u g(\overline{\mu})g(E)] = [\overline{E}\Phi(\mu)g(E)].$$

Here we use the fact that  $H$  is a homotopy and hence

$$[h(\ell)] = [\overline{p}_{\alpha(\ell)}\ell p_{\omega(\ell)}] \quad (7.1)$$

for any path  $\ell$  in  $\Gamma$ . □

**Remark 7.9.** Let  $\mu$  be a vertex in  $D_f$ . Then the following holds:

- 1) The  $f$ -path  $\mu$  and the  $g$ -path  $\Phi(\mu)$  have the same initial vertices in  $\Gamma$ .
- 2) Let  $E_1, \dots, E_n$  be the edges outgoing from  $\alpha(\mu)$  in  $\Gamma$ . Then the vertices  $\mu$  and  $\Phi(\mu)$  of the graphs  $D_f$  and  $D_g$  have degree  $n$  and the labels of edges outgoing from each of these vertices are  $E_1, \dots, E_n$ .
- 3)  $\Phi$  maps the star of the vertex  $\mu$  to the star of the vertex  $\Phi(\mu)$  bijectively and label preserving.

**Proposition 7.10.** *The map  $\Phi : D_f \rightarrow D_g$  is an isomorphism of graphs.*

*Proof.* By Remark 7.9. 3), it suffices to show that  $\Phi$  is bijective on vertices.

First we show that  $\Phi$  is injective on vertices. Let  $\mu_1, \mu_2$  be two different vertices of  $D_f$ . If the  $f$ -paths  $\mu_1$  and  $\mu_2$  have different initial vertices in  $\Gamma$ , then, by Remark 7.9. 1), the  $g$ -paths  $\Phi(\mu_1)$  and  $\Phi(\mu_2)$  have different initial vertices in  $\Gamma$  too, hence  $\Phi(\mu_1) \neq \Phi(\mu_2)$ .

Suppose that the initial vertices of the  $f$ -paths  $\mu_1$  and  $\mu_2$  coincide and equal to  $u$ . Then their terminal vertices also coincide and equal to  $f(u)$ . Since the  $f$ -paths  $\mu_1, \mu_2$  are reduced,  $\mu_1 \neq \mu_2$ , and  $g$  is a homotopy equivalence, we have  $[g(\mu_1)] \neq [g(\mu_2)]$ , hence  $\Phi(\mu_1) = [p_u g(\overline{\mu}_1)] \neq [p_u g(\overline{\mu}_2)] = \Phi(\mu_2)$ .

Now we show that  $\Phi$  is surjective on vertices. Let  $\tau$  be a vertex in  $D_g$ , i.e.  $\tau$  is a reduced  $g$ -path in  $\Gamma$ . Let  $u$  be the initial vertex of the path  $\tau$ . We will find a reduced  $f$ -path  $\mu$  in  $\Gamma$  such that  $\Phi(\mu) = \tau$ . Let  $\mu_1$  be an arbitrary path in  $\Gamma$  from  $u$  to  $f(u)$ . Then the paths  $\tau$  and  $p_u g(\overline{\mu}_1)$  have the same endpoints, so  $\overline{\tau} p_u g(\overline{\mu}_1)$  is a loop based at  $g(u)$ . Hence, there exists a loop  $\sigma$  in  $\Gamma$  based at  $u$  such that  $g(\sigma) = \overline{\tau} p_u g(\overline{\mu}_1)$ . We set  $\mu := [\sigma \mu_1]$ . Then  $\mu$  is an  $f$ -path and  $\Phi(\mu) = [p_u g(\overline{\mu})] = [p_u g(\overline{\mu}_1)g(\overline{\sigma})] = \tau$ . □

**Definition 7.11.** The *inverse preferred direction* at a vertex  $\mu$  in  $D_f$  is the preimage of the preferred direction at the vertex  $\Phi(\mu)$  in  $D_g$  under  $\Phi$ .



We formulate this more detailed. Recall that  $\Phi(\mu) = [p_u g(\bar{\mu})]$ , where  $u$  is the initial vertex of the  $f$ -path  $\mu$ . First suppose that the  $g$ -path  $\Phi(\mu)$  is nontrivial and let  $E$  be the first edge of this path. Then the inverse preferred direction at the vertex  $\mu$  of  $D_f$  is the direction of the edge of  $D_f$  which starts at  $\mu$  and has the label  $E$ .

If the  $g$ -path  $\Phi(\mu)$  is trivial in  $\Gamma$ , the inverse preferred direction at  $\mu$  in  $D_f$  is not defined.

**Proposition 7.12.** *The inverse preferred direction is defined at almost all vertices of  $D_f$ .*

*Proof.* If the inverse preferred direction at a vertex  $\mu$  in  $D_f$  is not defined, then  $\Phi(\mu)$  lies in the finite set  $\{\mathbf{1}_u \mid u \in \Gamma^0\}$ . Since  $\Phi$  is injective, the number of such  $\mu$  is finite. □

**Definition 7.13.** Preimages, with respect to  $\Phi$ , of repelling edges, repelling vertices and dead vertices of  $D_g$  are called *inv-repelling* edges, *inv-repelling* vertices and *inv-dead* vertices of  $D_f$ , respectively.

By Proposition 7.2 applied to  $g$ , there are only finitely many inv-repelling edges and inv-repelling and inv-dead vertices in  $D_f$ , and they can be algorithmically found.

### I. Normal vertices

**Definition 7.14.** A vertex of  $D_f$  is called *normal* if the preferred and the inverse preferred directions at this vertex exist and do not coincide.

The main purpose of this subsection are Propositions 7.18 and 7.19; they will help us to decide, whether two rays in  $D_f$  (given by their initial vertices) meet.

The following lemma easily follows from Lemma 6.4.

**Lemma 7.15.** *Let  $\Gamma$  be a finite connected graph and  $f : \Gamma \rightarrow \Gamma$  be a homotopy equivalence sending edges to edge paths. Let  $p$  be an initial subpath of a reduced path  $q$ . Write  $[f(p)] \equiv ab$ , where  $a$  is the maximal common initial subpath of  $[f(p)]$  and  $[f(q)]$ . Then  $l(b) \leq C_*(f)$ .*

The source of the following lemma is Proposition (4.3) in [15].

**Lemma 7.16.** *Let  $R$  be a  $\mu$ -subgraph with consecutive vertices  $\mu = \mu_0, \mu_1, \dots$ , and with labels of consecutive edges  $E_1, E_2, \dots$ . For each  $j \geq 0$  with alive vertex  $\mu_j$ , let  $k(j)$  be the maximal natural number such that  $\mu_j \equiv E_{j+1} \dots E_{j+k(j)} \cdot Z_j$  for some  $Z_j$ . If  $j > l(\mu_0)$  and  $R$  has at least  $j + k(j) + 2$  vertices, then  $l(Z_j) \leq C_*(f)$ .*

*Proof.* With notation  $X_j = E_1 E_2 \dots E_j$ , we have  $\mu_j \equiv [\bar{X}_j \mu_0 f(X_j)]$ . Hence,  $f(X_j) = \bar{\mu}_0 X_j \mu_j$ . Therefore  $[f(X_j)] \equiv [\bar{\mu}_0 X_j] \cdot E_{j+1} \dots E_{j+k(j)} \cdot Z_j$ . Indeed, the

condition  $j > l(\mu_0)$  guarantees that the last edge of  $[\bar{\mu}_0 X_j]$  is  $E_j$  which is not inverse to  $E_{j+1}$ . Applying the same arguments to  $\mu_{j+k(j)}$ , we have

$$\begin{aligned} [f(X_{j+k(j)})] &\equiv [\bar{\mu}_0 X_{j+k(j)}] \cdot E_{j+k(j)+1} \cdots E_{j+k(j)+k(j+k(j))} \cdot Z_{j+k(j)} \\ &\equiv [\bar{\mu}_0 X_j] \cdot E_{j+1} \cdots E_{j+k(j)} \cdot E_{j+k(j)+1} \cdots E_{j+k(j)+k(j+k(j))} \cdot Z_{j+k(j)}. \end{aligned}$$

From Lemma 7.15 applied to  $X_j$  and  $X_{j+k(j)}$ , we deduce that  $l(Z_j) \leq C_*(f)$ .  $\square$

The source of the following lemma is Proposition (4.10) from [33]. The map  $g$  and the constant  $K_*(f)$  were defined in Definition 7.7.

**Lemma 7.17.** *Let  $R$  be a  $\mu$ -subgraph with consecutive vertices  $\mu = \mu_0, \mu_1, \dots$ , and with labels of consecutive edges  $E_1, E_2, \dots$ . Suppose that  $j > l(\mu_0)$  and  $l(\mu_j) > C_*(f) \cdot (\|g\| + 1) + K_*(f)$ . If  $R$  has at least  $j + k(j) + 2$  vertices, then  $\mu_{j+k(j)}$  is normal. (Here  $k(j)$  is as in Lemma 7.16.)*

*Proof.* It suffices to show that the first edge of the  $g$ -path  $\Phi(\mu_{j+k(j)})$  is  $\overline{E_{j+k(j)}}$ . Then, by Definition 7.11, the inv-preferred direction at  $\mu_{j+k(j)}$  in  $D_f$  will coincide with the direction of the edge outgoing from  $\mu_{j+k(j)}$  and having the label  $\overline{E_{j+k(j)}}$ . On the other hand, the (direct) preferred direction at  $\mu_{j+k(j)}$  in  $D_f$  coincides with the direction of the edge outgoing from  $\mu_{j+k(j)}$  and having the label  $E_{j+k(j)+1}$ . Since these labels do not coincide, the vertex  $\mu_{j+k(j)}$  is normal.

By Lemma 7.16, we have

$$\mu_j \equiv E_{j+1} \cdots E_{j+k(j)} \cdot Z_j \quad \text{with } l(Z_j) \leq C_*(f). \quad (7.2)$$

This implies

$$\mu_{j+k(j)} = \overline{E_{j+1} \cdots E_{j+k(j)}} \mu_j f(E_{j+1} \cdots E_{j+k(j)}) = Z_j f(E_{j+1} \cdots E_{j+k(j)}).$$

Recall that  $\Phi(\mu) = [p_{\alpha(\mu)} g(\bar{\mu})]$ . Then, using (7.1), where  $h = g \circ f$ , we have

$$\begin{aligned} \Phi(\mu_{j+k(j)}) &\equiv [p_{\omega(E_{j+k(j)})} (g \circ f) (\overline{E_{j+1} \cdots E_{j+k(j)}}) g(\overline{Z_j})] \\ &\equiv [\overline{E_{j+1} \cdots E_{j+k(j)}} p_{\alpha(E_{j+1})} g(\overline{Z_j})]. \end{aligned}$$

From (7.2) and the assumption in this lemma, we have

$$\begin{aligned} l(\overline{E_{j+1} \cdots E_{j+k(j)}}) = k(j) &\geq l(\mu_j) - C_*(f) \\ &> K_*(f) + C_*(f) \cdot \|g\| \\ &\geq l(p_{\alpha(E_{j+1})}) + l(g(\overline{Z_j})). \end{aligned}$$

Therefore the first edge of  $\Phi(\mu_{j+k(j)})$  is  $\overline{E_{j+k(j)}}$ .  $\square$

**Proposition 7.18.** *There exists an efficient algorithm which, given an  $f$ -path  $\mu$ , either proves that the  $\mu$ -subgraph  $R$  is finite or finds a normal vertex in  $R$ .*

*Proof.* Computing consecutive vertices of  $R$ ,  $\mu = \mu_0, \mu_1, \dots$ , we either prove that  $R$  is finite, or find the first  $j$  with  $j > l(\mu_0)$  and  $l(\mu_j) > C_\star(f) \cdot (\|g\| + 1) + K_\star(f)$ . If we find such  $j$ , we compute  $k(j)$  (note that  $k(j) \leq l(\mu_j)$ ) and check, whether  $\mu_0, \mu_1, \dots, \mu_{j+k(j)+1}$  exist and different. If the result is negative, then  $R$  is finite; if positive, then the vertex  $\mu_{j+k(j)}$  is normal by Lemma 7.17.  $\square$

The following proposition is contained in Claim b) in the proof of Theorem A in [33]. This claim was inspired by Lemma (4.8) and Proposition (4.10) from [15]. The proof of this proposition is valid in general situation, i.e. for any homotopy equivalence  $f : \Gamma \rightarrow \Gamma$  sending edges to edge paths. We give it for completeness.

**Proposition 7.19.** *Let  $R_1$  and  $R_2$  be a  $\mu_1$ -ray and a  $\mu_2$ -ray in  $D_f$ , respectively. Suppose that they do not contain inv-repelling vertices and that their initial vertices  $\mu_1$  and  $\mu_2$  are normal. Then  $R_1$  and  $R_2$  are either disjoint or one of them is contained in the other.*

*Proof.* Figure 7 illustrates the proof. Suppose that the rays  $R_1$  and  $R_2$  intersect and none of them is contained in the other. We indicate the preferred directions by red triangles and the inv-preferred directions by blue triangles. Since  $\mu_1$  and  $\mu_2$  are normal, the blue and the red triangles at  $\mu_1$  and at  $\mu_2$  look in different directions, see Figure 7 (a). Since  $R_1$  and  $R_2$  do not contain inv-repelling vertices, we can inductively reconstruct the inv-preferred directions at the vertices of  $R_1$  and  $R_2$  until the first intersection point of these rays, see Figure 7 (b). We obtain two inv-preferred directions at this point, a contradiction.  $\square$

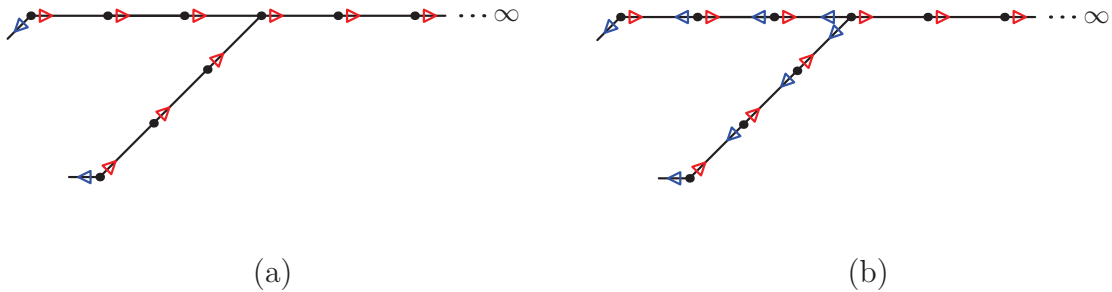

Figure 7.

**J. How to convert the procedure (1)-(5) for construction of the graph  $CoRe(C_f)$  into an algorithm**

As it was observed, it suffices to find algorithms for steps (2) and (4).

Using Propositions 7.18 and 7.19, Step (4) can be replaced by the following three steps.

- (4.1) For each repelling vertex  $\mu$  whose  $\mu$ -subgraph is a ray, find in this  $\mu$ -ray a vertex  $\mu'$  such that the  $\mu'$ -ray does not contain inv-repelling vertices.
- (4.2) Find a normal vertex  $\mu''$  in the  $\mu'$ -ray.

(4.3) For every two repelling vertices  $\mu$  and  $\tau$  whose  $\mu$ - and  $\tau$ -subgraphs are rays, verify whether  $\tau''$  is contained in the  $\mu''$ -ray or  $\mu''$  is contained in the  $\tau''$ -ray.

Step (4.2) can be done algorithmically by Proposition 7.18. Steps (4.1) and (4.3) can be done if we find an algorithm for the following problem.

**Membership problem.** Given two vertices  $\mu$  and  $\tau$  of the graph  $D_f$ , verify whether  $\tau$  is contained in the  $\mu$ -subgraph.

Indeed, for Step (4.1) we first find all inv-repelling vertices in  $D_f$ . Then we detect those of them which lie in the  $\mu$ -ray. Let  $I$  be the minimal initial segment of the  $\mu$ -ray which contains all these vertices. We can take  $\mu'$  equal to the first vertex in the  $\mu$ -ray which lies outside  $I$ . Step (4.3) is a partial case of the above problem.

Step (2) can be done if we find an algorithm for the following problem:

**Finiteness problem.** Given a vertex  $\mu$  of the graph  $D_f$ , determine whether the  $\mu$ -subgraph is finite or not. If the  $\mu$ -subgraph is finite, construct it.

Thus, to construct  $CoRe(C_f)$  algorithmically, it suffices to find algorithms for these problems. Moreover, using the solvability of the Membership problem, we can decide whether the vertex  $\mathbf{1}_{v_*}$  lies in the  $\mu$ -subgraph for some repelling vertex  $\mu$ . Then, by Proposition 7.6, we can compute a basis of  $\pi_1(D_f(\mathbf{1}_{v_*}), \mathbf{1}_{v_*})$ . Lemma 7.3 identifies this group with  $\overline{\text{Fix}}(f)$ .

In Section 20 we will present algorithms for the above problems in case where  $f : \Gamma \rightarrow \Gamma$  is a PL-relative train track satisfying (RTT-iv). As explained in Section 5, this will provide an algorithm for computing a basis of  $\text{Fix}(\varphi)$ .

## 8. $r$ -CANCELATION POINTS IN PATHS IN $G_r$

Let  $f : \Gamma \rightarrow \Gamma$  be a PL-relative train track with the maximal filtration  $\emptyset = G_0 \subset \cdots \subset G_N = \Gamma$ .

**Definition 8.1.** 1) Let  $p, q$  be reduced paths in  $\Gamma$  with the same initial point. By  $I(p, q)$  we denote the largest common initial subpath of  $p$  and  $q$ . Then  $p \equiv I(p, q) \cdot p'$  and  $q \equiv I(p, q) \cdot q'$  for some reduced paths  $p', q'$ . We denote by  $\Lambda(p, q)$  the ordered pair of paths  $(p', q')$ . These notations are motivated by the figure



2) Let  $\tau \equiv \bar{p} \cdot q$  be a reduced path in  $\Gamma$ . For  $k \geq 1$ , we set

$$(p_k, q_k) \equiv \Lambda([f^k(p)], [f^k(q)]) \quad \text{and} \quad I_k \equiv I([f^k(p)], [f^k(q)])$$

Then  $[f^k(\tau)] \equiv \bar{p}_k \cdot q_k$ . The occurrence  $y^k := \alpha(p_k) = \alpha(q_k)$  in  $[f^k(\tau)]$  is called the  $k$ -successor of  $y := \alpha(q)$ .

**Definition 8.2.** Let  $H_r$  be an exponential stratum. Let  $\tau \equiv \bar{p} \cdot q$  be a reduced path in  $G_r$ , where  $p$  and  $q$  are  $r$ -legal paths.

For  $k \in \mathbb{N}$ , let  $c_k$  be the maximal initial subpath of  $p$  such that  $[f^k(c_k)]$  is a subpath of  $I_k$  and the terminal (possibly partial) edge of  $c_k$  lies in  $H_r$  if it exists. Clearly,  $c_1 \subseteq c_2 \subseteq \dots \subseteq p$ . Let  $(p)_{\max}$  be the minimal path containing all  $c_k$ . Note that the terminal point of  $(p)_{\max}$  is not necessarily a vertex. We define  $(q)_{\max}$  analogously.

If  $\sigma$  is a subpath of some  $c_k$ , then we say that  $\sigma$  can be *virtually moved* into  $I_k$  in  $k$  steps. The same notion is defined for subpaths of  $(q)_{\max}$ .

**Remark 8.3.** (a) In Definition 8.2, we use the word *virtually*, since only for non-trivial subpaths of  $[f^k(\sigma)]$  which lie in  $H_r$ , we can guarantee that they lie in  $I_k$ .

(b) If  $\sigma$  is a subpath of  $(p)_{\max}$  with  $\omega(\sigma) \neq \omega((p)_{\max})$ , then there exists  $k \geq 1$  such that  $\sigma$  can be virtually moved in  $I_k$  in  $k$  steps.

**Definition 8.4.** Let  $H_r$  be an exponential stratum. Let  $\tau$  be a reduced path in  $G_r$ . An occurrence of a vertex  $y$  in  $\tau$  is called an  *$r$ -cancellation point* in  $\tau$  if  $\tau$  contains a subpath  $\bar{a}b$ , where  $a$  and  $b$  are nontrivial partial edges such that  $\alpha(a) = \alpha(b) = y$  and the full edges containing  $a$  and  $b$  form an illegal  $r$ -turn.

**Lemma 8.5.** *Let  $H_r$  be an exponential stratum. Suppose that  $\tau \equiv \bar{p}q$  is a reduced path in  $G_r$  such that the paths  $p$  and  $q$  are  $r$ -legal and the common initial point of  $p$  and  $q$  is an  $r$ -cancellation point in  $\tau$ . Then the following statements hold:*

1) *The initial and the terminal (possibly partial) edges of the paths  $(p)_{\max}$  and  $(q)_{\max}$  lie in  $H_r$ .*

2) *The number of  $r$ -edges in  $(p)_{\max}$  and in  $(q)_{\max}$ , including their terminal (possibly partial)  $r$ -edges, is bounded from above by a computable natural number  $n_{\text{critical}}$  depending only on  $f$ . In particular,  $L_r((p)_{\max}) < L_{\text{critical}}$  and  $L_r((q)_{\max}) < L_{\text{critical}}$ , where*

$$L_{\text{critical}} := \max\{L_r(E) \mid E \in H_r^1\} \cdot n_{\text{critical}}.$$

*Proof.* 1) The initial (partial) edges of the paths  $(p)_{\max}$  and  $(q)_{\max}$  lie in  $H_r$ , since the common initial vertex of these paths is an  $r$ -cancellation point in  $\tau$ . The terminal (partial) edges of  $(p)_{\max}$  and  $(q)_{\max}$  lie in  $H_r$  by definition of these paths.

2) We claim that this statement holds for  $n_{\text{critical}} := 2\lceil K \rceil + 2$ , where  $K$  is the protection constant defined in the proof of [4, Lemma 4.2.2]. Suppose the contrary. Then there exists a  $K$ -protected  $r$ -edge  $E$  in the interior of  $(p)_{\max}$ , and by this lemma,  $[f^n(E)]$  is a subpath of  $[f^n(\tau)]$  for any  $n \in \mathbb{N}$ . This contradicts Remark 8.3 (b). Note that  $K$  is computable and depends only on  $f$ .  $\square$

**Remark 8.6.** Let  $H_r$  be an exponential stratum. Let  $\mu, \tau \subset G_r$  be reduced paths with  $\alpha(\mu) = \alpha(\tau)$ . Let  $y_1, \dots, y_k$  and  $z_1, \dots, z_s$  be consequent  $r$ -cancellation points

in  $\mu$  and in  $\tau$ , respectively. Let  $t$  be the terminal vertex of  $I(\mu, \tau)$ . Then we have one of the following four cases for the path  $\bar{\mu}\tau$  (see Figure 8).

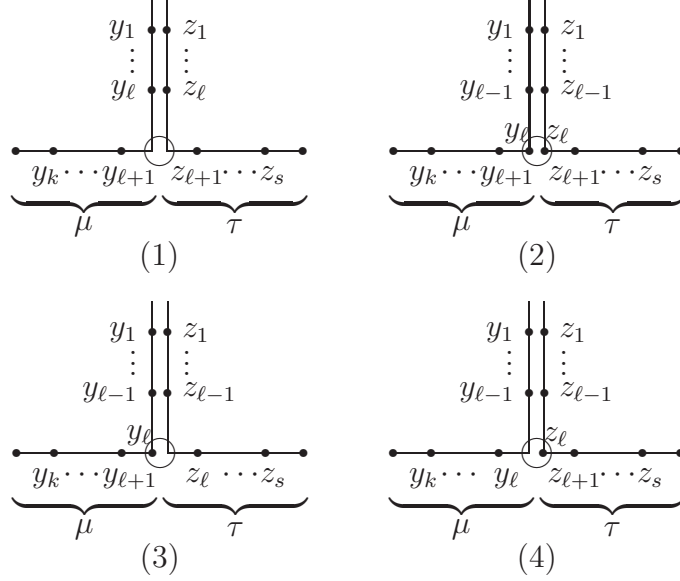

Figure 8.

(1) Suppose that  $t \notin \{y_1, \dots, y_k, z_1, \dots, z_s\}$  and that  $y_1 = z_1, \dots, y_{\ell} = z_{\ell}$ , are all  $r$ -cancellation points in  $I(\mu, \tau)$ . Then all  $r$ -cancellation points in  $[\bar{\mu}\tau]$  are  $y_k, \dots, y_{\ell+1}, z_{\ell+1}, \dots, z_s$  and, possibly,  $t$  (see Figure 8 (1)).

(2) Suppose that  $t = y_{\ell} = z_{\ell}$  for some  $\ell$ . Then  $t$  is an  $r$ -cancellation point in  $[\bar{\mu}\tau]$ . This follows from the fact that the turns at  $t$  in  $\mu$  and in  $\tau$  are illegal and have a common (partial) edge. So, all  $r$ -cancellation points in  $[\bar{\mu}\tau]$  are  $y_k, \dots, y_{\ell+1}, t, z_{\ell+1}, \dots, z_s$  (see Figure 8 (2)).

(3) Suppose that  $t = y_{\ell}$  for some  $\ell$  and that  $t \notin \{z_1, \dots, z_s\}$ . Then  $y_1 = z_1, \dots, y_{\ell-1} = z_{\ell-1}$  are all  $r$ -cancellation points in the path  $I(\mu, \tau)$ . Moreover,  $t$  is not an  $r$ -cancellation point in  $[\bar{\mu}\tau]$ . This follows from the fact that the turn at  $t$  in  $\mu$  is  $r$ -illegal, while the turn at  $t$  in  $\tau$  is not and these turns have a common (partial) edge. So, all  $r$ -cancellation points in  $[\bar{\mu}\tau]$  are  $y_k, \dots, y_{\ell+1}, z_{\ell}, \dots, z_s$  (see Figure 8 (3)).

(4) Suppose that  $t = z_{\ell}$  for some  $\ell$  and that  $t \notin \{y_1, \dots, y_k\}$  (see Figure 8 (4)). This case is analogous to Case (3). In particular,  $t$  is not an  $r$ -cancellation point in  $[\bar{\mu}\tau]$ .

Thus, the maximal possible number of  $r$ -cancellation points in  $[\bar{\mu}\tau]$  is  $k + s + 1$  (it can be achieved only in Case (1) for  $\ell = 0$ ). If at least one of the  $r$ -cancellation points in  $\mu$  or in  $\tau$  lies in  $I(\mu, \tau)$ , then the number of  $r$ -cancellation points in  $[\bar{\mu}\tau]$  is strictly less than  $k + s$ .

9.  $r$ -CANCELATION AREAS

Let  $f : \Gamma \rightarrow \Gamma$  be a PL-relative train track with the maximal filtration  $\emptyset = G_0 \subset \dots \subset G_N = \Gamma$ .

**Definition 9.1.** Let  $H_r$  be an exponential stratum. Suppose that  $\tau \equiv \bar{p}q$  is a reduced path in  $G_r$  such that the paths  $p$  and  $q$  are  $r$ -legal and the common initial point  $y$  of  $p$  and  $q$  is an  $r$ -cancelation point in  $\tau$ . We say that  $y$  is *non-deletable* in  $\tau$  if for every  $k \geq 1$  the  $k$ -successor  $y^k$  is an  $r$ -cancelation point in  $[f^k(\tau)]$ . We say that  $y$  is *deletable* in  $\tau$  if this does not hold.

If  $y$  is non-deletable in  $\tau$ , we call the path  $A := \overline{(p)}_{\max}(q)_{\max}$  the  *$r$ -cancelation area* (in  $\tau$ ). The number  $a := L_r((p)_{\max}) = L_r((q)_{\max})$  is called the  *$r$ -cancelation radius* of  $A$ .

**Remark 9.2.** Let  $\tau$  be a reduced path in  $G_r$  with a unique  $r$ -cancelation point  $y$ . Then the point  $y$  is a non-deletable  $r$ -cancelation point in  $\tau$  if and only if  $y^k$  is a non-deletable  $r$ -cancelation point in  $[f^k(\tau)]$  for some natural  $k$ .

**Lemma 9.3.** Each  $r$ -cancelation area  $A$  satisfies the following properties:

- 1) Each  $[f^k(A)]$  is an  $r$ -cancelation area. In particular, each  $[f^k(A)]$  contains exactly one  $r$ -cancelation point.
- 2) The initial and the terminal (possibly partial) edges of each  $[f^k(A)]$  are contained in  $H_r$ .
- 3) The number of  $r$ -edges in  $[f^k(A)]$  is bounded independently of  $k$ .

*Proof.* 1) follows from the above definition, 2) and 3) from Lemma 8.5. □

**Remark 9.4.** 1) The set of  $r$ -cancelation areas coincides with the set  $P_r$  defined before Lemma 4.2.5 in [4].

2) Let  $E$  be an edge of  $\Gamma$ . We write  $f(E) \equiv E_1E_2 \dots E_k$ , where  $E_1, \dots, E_k$  are edges of  $\Gamma$ . Then there is a subdivision  $\bar{E} \equiv e_1e_2 \dots e_k$  such that  $f(e_i) \equiv E_i$ . By assumption, the numbers  $l(e_i)$  for each  $i$  are given and the restriction of  $f$  to each  $e_i$  is linear. Therefore, for each given  $m \in \mathbb{N}$ , we can compute the  $l$ -lengths of the closures of connected components of  $E \setminus f^{-m}(\Gamma^0)$ .

**Proposition 9.5.** *Let  $H_r$  be an exponential stratum.*

1) *Given two  $r$ -legal paths  $\beta, \gamma$  in  $G_r$  with  $L_r(\beta) > 0$  and  $L_r(\gamma) > 0$ , there exists at most one  $r$ -cancelation area  $A$  such that  $\bar{\beta}$  and  $\gamma$  are some initial and terminal subpaths of  $A$ .*

2) *The number of  $r$ -cancelation areas is at most  $M_r := m_r^2 n_r^2$ , where  $m_r$  is the number of edges in  $H_r$  and  $n_r$  is the number of sequences  $(p_1, p_2, \dots, p_s)$ , where all  $p_i$  are  $r$ -legal edge paths in  $H_r$  with  $\sum_{i=1}^s L_r(p_i) \leq L_{\text{critical}}$ ,  $s \in \{0\} \cup \mathbb{N}$ .*

*Proof.* 1) Without loss of generality, we may assume that  $L_r(\beta) = L_r(\gamma)$ . Suppose that  $A \equiv \bar{p}q$  is an  $r$ -cancelation area, where  $p$  and  $q$  are  $r$ -legal and  $\beta$  and

$\gamma$  are terminal subpaths of  $p$  and  $q$ , respectively. Let  $k$  be the minimal natural number such that

$$\lambda_r^k \cdot L_r(\beta) > L_{\text{critical}}.$$

Then  $L_r([f^k(\beta)]) = L_r([f^k(\gamma)]) > L_{\text{critical}}$ . This implies that  $[f^k(\bar{p}q)] = [\bar{b}c]$ , where  $b$  is obtained from  $[f^k(\beta)]$  by deleting the maximal initial subpath lying in  $G_{r-1}$  and  $c$  is obtained analogously from  $[f^k(\gamma)]$ . Hence  $[f^k(\bar{p}q)]$  and so  $\bar{p}q$  are completely determined by  $\beta$  and  $\gamma$ .

2) First we introduce notations. For any reduced path  $\tau$  in  $G_r$ , we can write  $\tau \equiv c_0\tau_1c_1\dots\tau_sc_s$ , where the paths  $c_1, c_2, \dots, c_{s-1}$  lie in  $G_{r-1}$  and are nontrivial, the paths  $\tau_1, \tau_2, \dots, \tau_s$  lie in  $H_r$  and are nontrivial, and  $c_0, c_s$  lie in  $G_{r-1}$  or are trivial. We denote  $\tau \cap H_r := (\tau_1, \tau_2, \dots, \tau_s)$ .

Let  $\tau'_s$  is obtained from  $\tau_s$  by deleting the terminal partial edge of  $\tau_s$  if it exists. We set  $[\tau \cap H_r] := (\tau_1, \dots, \tau_{s-1}, \tau'_s)$  if  $\tau'_s$  is not empty and  $[\tau \cap H_r] := (\tau_1, \dots, \tau_{s-1})$  if  $\tau'_s$  is empty.

The following claim is proven in the proof of Lemma 4.2.5 in [4]:

For any two sequences  $\mu := (\mu_1, \mu_2, \dots, \mu_s)$ ,  $\sigma := (\sigma_1, \sigma_2, \dots, \sigma_t)$  where  $\mu_1, \dots, \mu_s, \sigma_1, \dots, \sigma_t$  are  $r$ -legal edge paths in  $H_r$ , and for any two edges  $E_1, E_2$  in  $H_r$ , there exists at most one  $r$ -cancellation area  $A \equiv \bar{p}q$  such that the paths  $p$  and  $q$  are  $r$ -legal,  $[p \cap H_r] = \mu$ ,  $[q \cap H_r] = \sigma$ , and the terminal (possibly partial) edge of  $p$  is a part of  $E_1$ , and the terminal (possibly partial) edge of  $q$  is a part of  $E_2$ .

Clearly, this claim and Lemma 8.5.2) imply the statement 2).  $\square$

**Definition 9.6.** Let  $H_r$  be an exponential stratum. Let  $x$  be a point in an  $r$ -edge  $E$ . The  $(l, L_r)_E$ -coordinates of  $x$  is the pair  $(l(p), L_r(p))$ , where  $p$  is the initial segment of  $E$  with  $\omega(p) = x$ .

**Lemma 9.7.** Let  $H_r$  be an exponential stratum. For each  $r$ -edge  $E$  and each  $m \in \mathbb{N}$ , the set  $\{x \in E \mid f^m(x) = x\}$  is finite. Given such  $E$  and  $m$ , we can efficiently compute the set of  $(l, L_r)_E$ -coordinates of all points of this set.

*Proof.* We show how to compute the  $(l, L_r)_E$ -coordinates of points of the set

$$V := \{x \in E \mid f^m(x) = x\} \setminus \{\alpha(E), \omega(E)\}.$$

Let  $x \in V$  and let  $p$  be the initial segment of  $E$  with  $\omega(p) = x$ . Write  $f^m(E) \equiv E_1E_2\dots E_k$ , where all  $E_i$  are edges and write  $E \equiv e_1e_2\dots e_k$ , where  $f^m(e_i) = E_i$  for  $i = 1, \dots, k$ . Note that all  $l(e_i)$  can be computed. Suppose that  $x$  is contained in  $e_i$ . Then  $E_i = E$  or  $E_i = \bar{E}$ . First we consider the case  $E_i = E$ . We have

$$l(p) = l_{e_i}(\alpha(e_i), x) + \sum_{j=1}^{i-1} l(e_j). \quad (9.1)$$



Using  $E = E_i$  and the linearity of  $f|_{e_i} : e_i \rightarrow E_i$ , we obtain

$$l(p) = l_{E_i}(\alpha(E_i), x) = \frac{l(E_i)}{l(e_i)} \cdot l_{e_i}(\alpha(e_i), x). \tag{9.2}$$

Then, using  $l(E_i) = 1$ , we deduce from (9.1) and (9.2)

$$l(p) = \frac{1}{1 - l(e_i)} \cdot \sum_{j=1}^{i-1} l(e_j). \tag{9.3}$$

It is easy to see that

$$\lambda_r^m \cdot L_r(p) = L_r(p) + \sum_{j=1}^{i-1} L_r(E_j),$$

hence

$$L_r(p) = \frac{1}{\lambda_r^m - 1} \cdot \sum_{j=1}^{i-1} L_r(E_j). \tag{9.4}$$

In case  $E_i = \bar{E}$  we have the following analogous of (9.3) and (9.4):

$$l(p) = \frac{1}{1 + l(e_i)} \cdot \sum_{j=1}^i l(e_j), \tag{9.3'}$$

$$L_r(p) = \frac{1}{\lambda_r^m + 1} \cdot \sum_{j=1}^i L_r(E_j). \tag{9.4'}$$

□

**Theorem 9.8.** *There is an efficient algorithm finding all  $r$ -cancellation areas of  $f$ .*

*Proof.* Let  $\mathcal{A}$  be the set of all  $r$ -cancellation areas. Let  $U$  be the set of all endpoints of all  $r$ -cancellation areas. The set  $U$  is  $f$ -invariant and lies in  $H_r$  by Lemma 9.3, and  $|U| \leq M_r$  by Proposition 9.5. We consider the subset  $U' := \{f^{M_r}(u) \mid u \in U\}$  of  $U$ . Then each point of  $U'$  is fixed by  $f^m$  for some  $0 < m \leq M_r$ . Therefore  $U'$  is contained in the set

$$\bar{U}' := \bigcup_{E \in H_r^1} \bigcup_{m=1}^{M_r} \{x \in E \mid f^m(x) = x\}$$

that is finite and computable by Lemma 9.7. Then the set

$$\bar{U} := \{u \in H_r \mid f^{M_r}(u) \in \bar{U}'\}$$

is finite and computable, and contains  $U$ .

Let  $\mathcal{P}$  be the set of nontrivial initial segments  $\rho$  of  $r$ -edges with  $\omega(\rho) \in \bar{U}$ . Suppose that  $A$  is an  $r$ -cancellation area. We write  $A \equiv \bar{p}q$ , where  $p$  and  $q$  are

$r$ -legal paths. Then  $p$  and  $q$  have terminal segments  $\beta$  and  $\gamma$ , respectively, which lie in  $\mathcal{P}$ . By Proposition 9.5.1),  $A$  is completely determined by  $\beta$  and  $\gamma$ . The proof of this proposition gives us the following algorithm constructing all elements of  $\mathcal{A}$ :

- (a) Compute  $\mathcal{L} = \min\{L_r(\rho) \mid \rho \in \mathcal{P}\}$  and the minimal  $k \in \mathbb{N}$  such that  $\lambda_r^k \cdot \mathcal{L} > L_{\text{critical}}$ . Denote  $\mathcal{A}_k := \{[f^k(A)] \mid A \in \mathcal{A}\}$ . Clearly,  $\mathcal{A}_k \subseteq \mathcal{A}$ .
- (b) Compute the set  $\Psi_k$  of all paths of the form  $\bar{b}c$ , where  $\alpha(b) = \alpha(c)$  is a vertex,  $b$  and  $c$  are nontrivial terminal subpaths of  $[f^k(\beta)]$  and of  $[f^k(\gamma)]$  for some  $\beta, \gamma \in \mathcal{P}$ ,  $L_r(b) = L_r(c) \leq L_{\text{critical}}$ , and the first (possibly partial) edges of  $b$  and  $c$  form a nondegenerate illegal  $r$ -turn. Then  $\mathcal{A}_k \subseteq \Psi_k$ .
- (c) Compute the set  $\Psi$  of reduced paths  $d \subset G_r$  such that  $[f^k(d)] \in \Psi_k$  and  $d$  contains exactly one  $r$ -cancellation point. Then  $\mathcal{A} \subseteq \Psi$ .
- (d) Compute the set  $\tilde{\Psi} = \{\tau \in \Psi \mid [f^i(\tau)] \in \Psi, i = 1, \dots, |\Psi|\}$ . This is possible since  $\Psi$  is finite. Then  $\mathcal{A} = \tilde{\Psi}$ .  $\square$

## 10. STABLE PATHS AND THEIR $A$ -DECOMPOSITIONS

Let  $f : \Gamma \rightarrow \Gamma$  be a PL-relative train track with the maximal filtration  $\emptyset = G_0 \subset \dots \subset G_N = \Gamma$ . We use notations from Definition 8.1. The following lemma is an immediate consequence of Definition 8.2.

**Lemma 10.1.** *Let  $H_r$  be an exponential stratum in  $\Gamma$ . Let  $\tau \equiv \bar{p}_0q_0$  be a reduced path in  $G_r$  such that the paths  $p_0$  and  $q_0$  are  $r$ -legal, and the common initial point of  $p_0$  and  $q_0$  is an  $r$ -cancellation point in  $\tau$ . Suppose that, for some  $k \geq 1$ , the path  $[f^k(\tau)] \equiv \bar{p}_kq_k$  has an  $r$ -cancellation point and this point is the common initial point of  $p_k$  and  $q_k$ . Then*

$$((p_k)_{\max}, (q_k)_{\max}) = \Lambda([f^k((p_0)_{\max})], [f^k((q_0)_{\max})]).$$

**Proposition 10.2.** *Let  $H_r$  be an exponential stratum in  $\Gamma$ . There exists a computable integer number  $T \geq 0$  (depending only on  $f$ ) with the following property:*

*Suppose that  $\tau \equiv \bar{p}_0q_0$  is a reduced edge path in  $G_r$  such that the paths  $p_0$  and  $q_0$  are  $r$ -legal, and the common initial point of  $p_0$  and  $q_0$  is an  $r$ -cancellation point in  $\tau$ . Then either  $[f^T(\tau)]$  is  $r$ -legal, or  $y$  is a non-deletable  $r$ -cancellation point in  $\tau$ .*

*Proof.* We define the following constants:

$k_0$ is the minimal natural number such that $\lambda_r^{k_0} \min\{L_r(E) \mid E \in H_r^1\} > L_{\text{critical}}$ . $N_0$ is the number of edge paths in $G_r$ of $l$ -length at most $\ f\ ^{k_0}$ . $k_1 := k_0 + N_0^2$ . $N_1$ is the number of edge paths in $G_r$ of $l$ -length at most $\ f\ ^{k_1} n_{\text{critical}}$ . $k_2 := k_1 + N_0 \cdot N_1$ . $N_2$ is the number of edge paths in $G_r$ of $l$ -length at most $\ f\ ^{k_2} n_{\text{critical}}$ .
--

We prove that the proposition is valid for  $T := k_2 + N_2^2$ . Suppose that  $[f^T(\tau)]$  is not  $r$ -legal. Then

$$[f^i(\tau)] \text{ contains an } r\text{-cancelation point for each } 0 \leq i \leq T. \quad (10.1)$$

We use the following definition: Let  $\mu$  be a path in  $G_r$ . Then any maximal nontrivial subpath of  $\mu$  which lies in  $G_{r-1}$  is called a  $G_{r-1}$ -piece of  $\mu$ .

By Lemma 8.5. 1), we can write  $(p_0)_{\max} \equiv a_1 b_1 \dots a_s b_s a_{s+1}$  and  $(q_0)_{\max} \equiv a'_1 b'_1 \dots a'_t b'_t a'_{t+1}$ , where  $s \geq 0$ ,  $t \geq 0$ , all paths  $a_i$  and  $a'_i$  are nontrivial and lie in  $H_r$ , and all paths  $b_i$  and  $b'_i$  are nontrivial and lie in  $G_{r-1}$ .

Recall that  $[f^k(p_0)] \equiv I_k p_k$  and  $[f^k(q_0)] \equiv I_k q_k$ , where  $I_k = I([f^k(p_0)], [f^k(q_0)])$ . The initial (but not necessarily the terminal) point of  $(p_k)_{\max}$  is a vertex. Let  $(p_k)_{e-\max}$  be the minimal edge path containing  $(p_k)_{\max}$ . We define  $(q_k)_{e-\max}$  analogously.

**Claim 1.** For each  $k \geq k_0$  such that  $[f^k(\tau)]$  contains an  $r$ -cancelation point, and for each  $b_i$ ,  $i = 1, \dots, s$ , one of the following is satisfied:

- 1)  $[f^k(b_i)]$  is a subpath of  $I_k$ .
- 2)  $[f^k(b_i)]$  is a  $G_{r-1}$ -piece of  $p_k$ . Moreover,  $p_k \equiv p_{k,i,1}[f^k(b_i)]p_{k,i,2}$  for some paths  $p_{k,i,1}$ ,  $p_{k,i,2}$  such that  $0 < l(p_{k,i,1}) \leq \|f\|^{k_0}$ .  
(We stress that the last number does not depend on  $k$ .)

The same alternative holds for each  $b'_j$ ,  $j = 1, \dots, t$ .

*Proof.* We fix  $k$  and  $i$  in the above intervals. Let  $e$  be the last edge of  $a_i$ , so  $e$  is an  $r$ -edge and  $\omega(e) = \alpha(b_i)$ . Let  $E$  be the last edge of  $[f^{k-k_0}(e)]$ . Then  $E$  satisfies the following properties:

- $E$  is an  $r$ -edge and  $\omega([f^{k_0}(E)]) = \alpha([f^k(b_i)])$ .
  - $[f^{k_0}(E)]$  is a subpath of  $[f^k(e)]$ , which is a subpath of  $[f^k(p_0)] \equiv I_k p_k$ .
  - $[f^{k_0}(E)]$  does not lie in  $p_k$ .
- (10.2)

The first two properties are evident. We prove the last one. Suppose that  $[f^{k_0}(E)]$  lies in  $p_k$ . Since  $\omega(e) \neq \omega((p_0)_{\max})$ ,  $e$  can be virtually moved into some  $I_\ell$  in  $\ell$  steps. Then  $[f^{k_0}(E)]$  can be virtually moved into  $I_{k+\ell}$  in  $\ell$  steps. Therefore  $[f^{k_0}(E)]$  lies in  $(p_k)_{\max}$ . From this we have  $L_r([f^{k_0}(E)]) \leq L_r((p_k)_{\max}) < L_{\text{critical}}$  by Lemma 8.5, that contradicts the definition of  $k_0$ . Now we are ready to finish the proof of Claim 1.

*Case 1.* Suppose that  $[f^{k_0}(E)]$  lies in  $I_k$ . Then  $\alpha([f^k(b_i)])$  lies in  $I_k$ . We prove that the whole path  $[f^k(b_i)]$  lies in  $I_k$ . Suppose the contrary, then  $[f^k(b_i)]$  covers the first edge of  $p_k$ , hence this edge lies in  $G_{r-1}$ , a contradiction to the assumption that  $[f^k(\tau)]$  contains an  $r$ -cancelation point. Thus, in this case the statement 1) holds.

*Case 2.* Suppose that  $[f^{k_0}(E)]$  does not lie in  $I_k$ . By (10.2),  $[f^{k_0}(E)]$  does not lie in  $p_k$ . Hence the first edge of  $[f^{k_0}(E)]$  lies in  $I_k$  and the last edge lies in  $p_k$ . Since  $\omega([f^{k_0}(E)]) = \alpha([f^k(b_i)])$ , we can write  $p_k \equiv p_{k,i,1}[f^k(b_i)]p_{k,i,2}$  for some paths

$p_{k,i,1}, p_{k,i,2}$ . Moreover,

$$0 < l(p_{k,i,1}) \leq l([f^{k_0}(E)]) \leq \|f\|^{k_0}.$$

Thus, in this case the statement 2) is valid.  $\square$

**Claim 2.** If both paths  $b_s$  and  $b'_t$  exist, then at least one of them can be virtually moved into  $I_{k_1}$  in  $k_1$  steps.

*Proof.* Suppose the contrary. Then, for each  $k = k_0, k_0 + 1, \dots, k_1$ , and for  $i = s$  (for  $j = t$ ) the second statement of Claim 1 is valid:

$$p_k \equiv X_k[f^k(b_s)]Y_k, \quad \text{where } 0 < l(X_k) \leq \|f\|^{k_0} \text{ and } [f^k(b_s)] \text{ is a } G_{r-1}\text{-piece of } p_k;$$

$$q_k \equiv X'_k[f^k(b'_t)]Y'_k, \quad \text{where } 0 < l(X'_k) \leq \|f\|^{k_0} \text{ and } [f^k(b'_t)] \text{ is a } G_{r-1}\text{-piece of } q_k.$$

Then the pairs of paths  $(X_k, X'_k)$  repeat, hence, for any  $\ell \geq 1$ , the paths  $b_s$  and  $b'_t$  cannot be virtually moved into  $I_\ell$  in  $\ell$  steps. This contradicts Remark 8.3 (b).  $\square$

**Claim 3.** Let  $(p_0)_{\max} \equiv X_0 b_j Y_0$ , where  $b_j$  is a  $G_{r-1}$ -piece of  $(p_0)_{\max}$ . Suppose that  $b_j$  cannot be virtually moved into  $I_{k_1}$  in  $k_1$  steps. Then the following statements are satisfied.

$$1) (p_{k_1})_{\max} \equiv X_{k_1}[f^{k_1}(b_j)]Y_{k_1} \text{ for some paths } X_{k_1}, Y_{k_1} \text{ such that}$$

$$0 < l(X_{k_1}) \leq \|f\|^{k_0}.$$

Moreover,  $[f^{k_1}(b_j)]$  is a  $G_{r-1}$ -piece of  $(p_{k_1})_{\max}$ .

$$2) l((q_{k_1})_{\max}) \leq \|f\|^{k_1} n_{\text{critical}}.$$

*Proof.* The first statement follows from Claim 1. We prove the second one. First we consider the case where  $b'_t$  does not exist, i.e.  $(q_0)_{\max} \equiv a'_1$ . By Lemma 10.1,  $(q_{k_1})_{\max}$  is a subpath of  $[f^{k_1}((q_0)_{\max})]$ , hence (using Lemma 8.5)

$$l((q_{k_1})_{\max}) \leq l([f^{k_1}(a'_1)]) \leq \|f\|^{k_1} [l(a'_1)] \leq \|f\|^{k_1} n_{\text{critical}},$$

and the statement 2) in this case is valid.

Now we consider the case where  $b'_t$  exists. The assumption of Claim 3 imply that  $b_s$  cannot be virtually moved into  $I_{k_1}$  in  $k_1$  steps. By Claim 2, the path  $b'_t$  can be virtually moved into  $I_{k_1}$  in  $k_1$  steps. Then the initial vertex of  $[f^{k_1}(a'_{t+1})]$  lies in  $I_{k_1}$ . Observe that  $[f^{k_1}(a'_{t+1})]$  is a terminal subpath of  $[f^{k_1}((q_0)_{\max})]$ . Then, by Lemma 10.1,  $(q_{k_1})_{\max}$  is a subpath of  $[f^{k_1}(a'_{t+1})]$ , and we complete as above.  $\square$

**Claim 4.** Each of the paths  $b_s, b'_t$  can be virtually moved into  $I_{k_2}$  in  $k_2$  steps.

*Proof.* We assume that  $b_s$  exists and prove the claim for  $b_s$ . If  $b_s$  can be virtually moved into  $I_{k_1+i}$  in  $k_1+i$  steps for some  $0 \leq i \leq N_0 N_1$ , we are done. So, suppose that this is not valid. Then we apply Claim 3 consequently to  $(p_i)_{\max} \equiv X_i[f^i(b_s)]Y_i$  for  $i = 0, 1, \dots, N_0 N_1$ . The inequalities in Claim 3 and the choice of  $N_0, N_1$  imply that there must be a repetition in the sequence of pairs  $(X_{k_1+i}, (q_{k_1+i})_{\max})$ ,  $i =$

$0, 1, \dots, N_0N_1$ . Then  $b_s$  cannot be virtually moved into  $I_j$  in  $j$  steps for  $j = 1, 2, \dots$ . This contradicts Remark 8.3 (b).  $\square$

**Claim 5.** The paths  $(p_{k_2})_{\max}$  and  $(q_{k_2})_{\max}$  coincide with some terminal subpaths of  $[f^{k_2}(a_{s+1})]$  and  $[f^{k_2}(a'_{t+1})]$ , respectively.

*Proof.* By Claim 4, the initial vertices of the paths  $[f^{k_2}(a_{s+1})]$  and  $[f^{k_2}(a'_{t+1})]$  lie in  $I_{k_2}$ , and their terminal points coincide with the terminal points of the paths  $[f^{k_2}((p_0)_{\max})]$  and  $[f^{k_2}((q_0)_{\max})]$ , respectively. Then  $\Lambda([f^{k_2}(a_{s+1})], [f^{k_2}(a'_{t+1})]) \equiv \Lambda([f^{k_2}((p_0)_{\max})], [f^{k_2}((q_0)_{\max})])$ , and the claim follows from Lemma 10.1.  $\square$

**Claim 6.** The chosen constant  $T$  satisfies the proposition.

*Proof.* Since  $a_{s+1}, a'_{t+1} \subset H_r$  are subpaths of  $(p_0)_{\max}$  and  $(q_0)_{\max}$ , respectively, we have  $l(a_{s+1}) \leq n_{\text{critical}}$  and  $l(a'_{t+1}) \leq n_{\text{critical}}$  by Lemma 8.5. From this and from Claim 5, we deduce

$$l((p_{k_2})_{\max}) \leq \|f\|^{k_2} n_{\text{critical}}, \quad l((q_{k_2})_{\max}) \leq \|f\|^{k_2} n_{\text{critical}}.$$

For any  $0 \leq i \leq N_2^2$ , if we start from  $[f^i(\tau)] \equiv \bar{p}_i q_i$  instead of  $\tau \equiv \bar{p}_0 q_0$ , we obtain analogously

$$l((p_{i+k_2})_{\max}) \leq \|f\|^{k_2} n_{\text{critical}}, \quad l((q_{i+k_2})_{\max}) \leq \|f\|^{k_2} n_{\text{critical}}.$$

This and the definition of  $N_2$  imply that there exist  $0 \leq i < j \leq N_2^2$  such that  $(p_{i+k_2})_{\text{e-max}} \equiv (p_{j+k_2})_{\text{e-max}}$  and  $(q_{i+k_2})_{\text{e-max}} \equiv (q_{j+k_2})_{\text{e-max}}$ . Then  $y$  is a non-deletable  $r$ -cancelation point in  $\tau$ .  $\square$

Now we analyze cancelations in  $f$ -images of paths in  $G_r$  with several  $r$ -cancelation points.

**Definition 10.3.** Let  $H_r$  be an exponential stratum in  $\Gamma$ . For any reduced path  $\tau \subset G_r$ , let  $P_r(\tau)$  be the number of  $r$ -cancelation points in  $\tau$ . Clearly,  $P_r([f^i(\tau)]) \geq P_r([f^{i+1}(\tau)])$  for any  $i \geq 0$ . We say that  $\tau$  is  $r$ -stable if  $P_r([f^i(\tau)]) = P_r(\tau)$  for all  $i \geq 1$ . If  $\tau$  is  $r$ -stable, we call the  $r$ -cancelation points of  $\tau$  *non-deletable*. Clearly, there exists a nonnegative integer  $i_0$  such that the path  $[f^{i_0}(\tau)]$  is  $r$ -stable. We denote by  $N_r(\tau)$  the number of  $r$ -cancelation points in  $[f^{i_0}(\tau)]$ .

**Theorem 10.4.** *Let  $H_r$  be an exponential stratum in  $\Gamma$ . There exists an efficient algorithm which, given a reduced edge path  $\tau \subset G_r$ , computes  $i_0 \geq 0$  such that the path  $[f^{i_0}(\tau)]$  is  $r$ -stable. In particular, one can check, whether  $\tau$  is  $r$ -stable or not.*

*Proof.* Let  $y_1, \dots, y_k$  be all  $r$ -cancelation points in  $\tau$ . Let  $y_0$  and  $y_{k+1}$  be the initial and the terminal points of  $\tau$ , respectively. Let  $\tau_i$  be the subpath of  $\tau$  from  $y_i$  to  $y_{i+1}$ ,  $i = 0, \dots, k$ .

First we note that  $y_i$  is the unique  $r$ -cancelation point in the edge path  $\tau_{i-1}\tau_i$ . For each  $1 \leq i \leq k$ , we can check in  $T$  steps, by Proposition 10.2, whether the point  $y_i$  in  $\tau_{i-1}\tau_i$  is deletable or not. If it is deletable for some  $i$ , then  $P_r([f^T(\tau)]) < P_r(\tau)$

and we can proceed by induction restarting from  $[f^T(\tau)]$ . Suppose that  $y_i$  is a non-deletable  $r$ -cancellation point in  $\tau_{i-1}\tau_i$  for each  $1 \leq i \leq k$ . We compute the  $r$ -cancellation area  $A_i \equiv \bar{p}_i q_i$  in  $\tau_{i-1}\tau_i$  and the number  $a_i := L_r(p_i) = L_r(q_i)$ .

If  $L_r(\tau_i) \geq a_i + a_{i+1}$  for  $i = 1, \dots, k-1$ , then the path  $\tau$  is  $r$ -stable and the points  $y_1, \dots, y_k$  are non-deletable.

Suppose that for some  $i$  we have  $L_r(\tau_i) < a_i + a_{i+1}$ . Then there exists a point  $x \in \tau_i$  in the middle between  $\alpha(A_{i+1})$  and  $\omega(A_i)$  with respect to  $L_r$ , i.e.  $L_r(\alpha(A_{i+1}), x) = L_r(x, \omega(A_i)) = a$ , where  $a := \frac{a_i + a_{i+1} - L_r(\tau_i)}{2}$ . The points  $\alpha(A_{i+1})$ ,  $x$  and  $\omega(A_i)$  divide  $\tau_i$  into four subpaths:  $\tau_i \equiv u_1 u_2 u_3 u_4$ . Let  $m$  be the minimal natural number such that  $\lambda_r^m \cdot a > L_{\text{critical}}$ .

Since  $q_i \equiv u_1 u_2 u_3$  and  $L_r(u_3) = a$ , the path  $[f^m(\tau_{i-1} u_1 u_2)]$  is  $r$ -legal. Analogously,  $[f^m(u_3 u_4 \tau_{i+1})]$  is  $r$ -legal. Then  $[f^m(\tau_{i-1} \tau_i \tau_{i+1})]$  is the product of two  $r$ -legal paths, hence  $P_r([f^m(\tau)]) < P_r(\tau)$ . Induction by  $k$  completes the proof.  $\square$

For convenience, we reformulate a part of Definition 10.3.

**Definition 10.5.** Let  $H_r$  be an exponential stratum in  $\Gamma$ . Let  $\tau$  be a reduced path in  $G_r$  and  $y_1, \dots, y_k$  be all  $r$ -cancellation points in  $\tau$ . We say that these  $r$ -cancellation points in  $\tau$  are *non-deletable* if the number of  $r$ -cancellation points in  $[f^i(\tau)]$  is equal to  $k$  for every  $i \geq 0$ .

**Theorem 10.6.** (*Criterion of  $r$ -stability*) Let  $H_r$  be an exponential stratum in  $\Gamma$ . Let  $\tau$  be a reduced edge path in  $G_r$  and  $y_1, \dots, y_k$  be all  $r$ -cancellation points in  $\tau$ . Let  $y_0 := \alpha(\tau)$ ,  $y_{k+1} := \omega(\tau)$ , and let  $\tau_i$  be the subpath of  $\tau$  from  $y_i$  to  $y_{i+1}$ . Then the  $r$ -cancellation points  $y_1, \dots, y_k$  are non-deletable in  $\tau$  if and only if each of  $y_i$  is non-deletable in  $\tau_{i-1}\tau_i$  for  $i = 1, \dots, k$  and  $L_r(\tau_i) \geq a_i + a_{i+1}$  for  $i = 1, \dots, k-1$ , where  $a_i$  is the  $r$ -cancellation radius for the  $r$ -cancellation area in  $\tau_{i-1}\tau_i$ .

The proof follows from the proof of Theorem 10.4.

**Definition 10.7.** Let  $H_r$  be an exponential stratum in  $\Gamma$ . Let  $\tau$  be a reduced  $r$ -stable path in  $G_r$ . Then  $\tau$  can be written as  $\tau \equiv b_0 \cdot A_1 \cdot b_1 \cdot \dots \cdot A_k \cdot b_k$ , where  $b_0, \dots, b_k$  are  $r$ -legal or trivial paths in  $G_r$  and  $A_1, \dots, A_k$  are all  $r$ -cancellation areas in  $\tau$ . We call such decomposition the *A-decomposition* of  $\tau$ .

**Remark 10.8.** Suppose that  $\tau$  has the *A-decomposition*

$$\tau \equiv b_0 \cdot A_1 \cdot b_1 \cdot \dots \cdot A_k \cdot b_k.$$

Then, for every  $i \geq 1$ , the path  $[f^i(\tau)]$  has the *A-decomposition*

$$[f^i(\tau)] \equiv b_0^i \cdot A_1^i \cdot b_1^i \cdot \dots \cdot A_k^i \cdot b_k^i,$$

where  $b_j^i \equiv [f^i(b_j)]$  and  $A_j^i \equiv [f^i(A_j)]$  for all possible  $j$ .

11. SPLITTING LEMMA

**Notation 11.1.** Let  $f : \Gamma \rightarrow \Gamma$  be a PL-relative train track. For any exponential stratum  $H_r$ , let  $\mathcal{E}_r$  be the set of endpoints of all  $r$ -cancelation areas.

**Lemma 11.2.** *Let  $f : \Gamma \rightarrow \Gamma$  be a PL-relative train track and  $H_r$  be an exponential stratum.*

- 1) *The set  $\mathcal{E}_r$  lies in  $H_r$ , is  $f$ -invariant, computable, and  $|\mathcal{E}_r| \leq M_r$ .*
- 2) *If  $b$  is a nontrivial path in  $G_r$  with endpoints in  $\mathcal{E}_r$  and with  $L_r(b) = 0$ , then  $f^{M_r}(b)$  is an edge path in  $G_{r-1}$ .*

*Proof.* 1) follows from Lemma 9.3, Theorem 9.8 and Proposition 9.5.2). We prove 2). By Lemma 4.4.5), there exists  $k$  such that  $f^k(b)$  lies in  $G_{r-1}$ . The endpoints of  $b$  and hence of  $f^k(b)$  lie in  $\mathcal{E}_r$ , and  $\mathcal{E}_r$  lies in  $H_r$ . Therefore the endpoints of  $f^k(b)$  are vertices. Since  $\mathcal{E}_r$  is  $f$ -invariant and  $|\mathcal{E}_r| \leq M_r$ , and since the  $f$ -images of vertices are vertices, we have that the endpoints of  $f^{M_r}(b)$  are vertices. Since  $L_r(b) = 0$ , the path  $f^{M_r}(b)$  lies in  $G_{r-1}$ .  $\square$

**Lemma 11.3.** (Splitting lemma) *For any PL-relative train track  $f : \Gamma \rightarrow \Gamma$ , the following is satisfied:*

*Let  $H_r$  be an exponential stratum of  $\Gamma$  and let  $\tau$  be a reduced edge path in  $G_r$ . Then, for all  $L > 0$ , one can efficiently find an exponent  $S > 0$  such that at least one of the three possibilities occurs:*

- 1)  *$[f^S(\tau)]$  contains an  $r$ -legal subpath of  $r$ -length greater than  $L$ .*
- 2)  *$[f^S(\tau)]$  contains fewer illegal  $r$ -turns than  $\tau$ .*
- 3)  *$[f^S(\tau)]$  is a trivial path or a concatenation of paths each of which is either an indivisible periodic Nielsen path intersecting  $\text{int}(H_r)$  or an edge path in  $G_{r-1}$ .*

*Proof.* By Theorem 10.4, we can efficiently find the minimal nonnegative integer  $i_0$  such that  $[f^{i_0}(\tau)]$  is  $r$ -stable. If  $i_0 > 0$ , then  $\tau$  is not  $r$ -stable and we have 2) with  $S := i_0$ .

Suppose that  $i_0 = 0$ . We may assume that  $\tau$  is nontrivial. Then  $\tau$  is  $r$ -stable and there exists the  $A$ -decomposition  $\tau \equiv b_0 \cdot A_1 \cdot b_1 \cdot \dots \cdot A_k \cdot b_k$  as in Definition 10.7. (Note that we can recognize all non-deletable  $r$ -cancelation points in  $\tau$  and compute the  $r$ -cancelation radii for all  $A_j$ ; hence, we can compute all  $L_r(b_j)$ .) Then, for all  $i \geq 0$ , we have the  $A$ -decomposition

$$[f^i(\tau)] \equiv b_0^i \cdot A_1^i \cdot b_1^i \cdot \dots \cdot A_k^i \cdot b_k^i$$

with notations from Remark 10.8. Since all  $b_j$  are  $r$ -legal or trivial, we have

$$L_r(b_j^i) = \lambda_r^i \cdot L_r(b_j).$$

If  $L_r(b_j) > 0$  for some  $j$ , we compute the minimal natural  $S$  with  $\lambda_r^S \cdot L_r(b_j) > L$ . Then we have 1) for this  $S$ .

Suppose that  $L_r(b_j) = 0$  for all  $j$ . We assume that  $k \geq 1$ , otherwise  $\tau \equiv b_0$  is an edge path which lies in  $G_{r-1}$  and we are done.

First we prove that  $b_k$  is trivial or is an edge path in  $G_{r-1}$ . Since  $\omega(b_k) = \omega(\tau)$  is a vertex, it suffices to prove that  $\alpha(b_k)$  is a vertex too. Note that  $\alpha(b_k)$  lies in an  $r$ -edge  $E$ ; this follows from  $\alpha(b_k) = \omega(A_k)$  and from the fact that the endpoints of  $r$ -cancellation areas lie in  $H_r$ . Suppose that  $\alpha(b_k)$  is not a vertex. Then the first partial edge of  $b_k$  is a nontrivial terminal segment of  $E$ , hence  $L_r(b_k) > 0$ , a contradiction.

Thus,  $b_k$  is a (possibly trivial) edge path with  $L_r(b_k) = 0$ . Then  $b_k$  is trivial or is an edge path in  $G_{r-1}$ . Analogously  $b_0$  is trivial or is an edge path in  $G_{r-1}$ .

Now consider  $b_j$  with  $j \in \{1, \dots, k-1\}$ . Suppose that  $b_j$  is nontrivial. Since  $L_r(b_j) = 0$ , Lemma 11.2.2 implies that  $[f^{M_r}(b_j)]$  is an edge path in  $G_{r-1}$ . Clearly, each  $r$ -cancellation area  $[f^{M_r}(A_j)]$  is an indivisible periodic Nielsen path. Thus, we have the statement 3) with  $S = M_r$  in this case.  $\square$

## 12. SUBDIVIDED RELATIVE TRAIN TRACK

It is technically convenient to start the proof of the main theorem in the situation where the following condition is satisfied:

(RTT-iv) There is a computable natural number  $P = P(f)$  such that for each exponential strata  $H_r$  and each  $r$ -cancellation area  $A$  of  $f$ , the  $r$ -cancellation area  $[f^P(A)]$  is an edge path.

We will show that this condition is satisfied for a map  $f' : \Gamma' \rightarrow \Gamma'$  obtained from  $f : \Gamma \rightarrow \Gamma$  by using subdivisions of edges of  $\Gamma$  at exceptional points (see Definition 12.1). Moreover,  $f'$  will satisfy the properties (RTT-i) – (RTT-iii) of a relative train track with respect to a natural filtration on  $\Gamma'$ .

**Definition 12.1.** Let  $f : \Gamma \rightarrow \Gamma$  be a PL-relative train track and  $H_r$  be an exponential stratum. Recall that  $\mathcal{E}_r$  is the set of endpoints of all  $r$ -cancellation areas. A point  $v \in \mathcal{E}_r$  is called an  $r$ -exceptional point if  $f^n(v)$  is not a vertex for all  $n \in \mathbb{N}$ .

**Lemma 12.2.** *Let  $f : \Gamma \rightarrow \Gamma$  be a PL-relative train track and  $H_r$  be an exponential stratum. Then the following statements are valid:*

- 1) *The set of  $r$ -exceptional points is  $f$ -invariant. The  $r$ -exceptional points lie in the interiors of  $r$ -edges.*
- 2) *An endpoint  $v$  of an  $r$ -cancellation area is not an  $r$ -exceptional point if and only if  $f^i(v)$  is a vertex of  $\Gamma$  for some  $0 \leq i < |\mathcal{E}_r|$ .*
- 3) *One can efficiently find the set of  $r$ -exceptional points.*

*Proof.* 2) is obvious, 1) and 3) follow from Lemma 11.2.1).  $\square$

**Definition 12.3.** Let  $f : \Gamma \rightarrow \Gamma$  be a PL-relative train track. Let  $\Gamma'$  be the graph obtained from  $\Gamma$  by subdivision at all  $r$ -exceptional points for all exponential strata



$H_r$ . If  $E \equiv e_1 e_2 \dots e_k$ ,  $k \geq 2$ , is the result of subdivision of an  $r$ -edge  $E$ , we call each  $e_i$  an  $r$ -exceptional partial edge. By the statement 3) of Lemma 12.2, we can construct the graph  $\Gamma'$  efficiently. By the statement 1), the map  $f : \Gamma \rightarrow \Gamma$  induces a natural map  $f' : \Gamma' \rightarrow \Gamma'$ .

We also define a natural filtration  $\emptyset = G'_0 \subset \dots \subset G'_N = \Gamma'$ : for each exponential stratum  $H_r$  the corresponding stratum  $H'_r$  consists of all  $r$ -edges which were not subdivided and of all  $r$ -exceptional partial edges; all other strata remain unchanged.

- Lemma 12.4.** 1) If  $e$  is an  $r$ -exceptional partial edge in  $\Gamma$ , then  $L_r(e) > 0$ .  
 2) The filtration  $\emptyset = G'_0 \subset \dots \subset G'_N = \Gamma'$  is maximal.  
 3) The homotopy equivalence  $f' : \Gamma' \rightarrow \Gamma'$  is a PL-relative train track.

*Proof.* 1) If we had  $L_r(e) = 0$ , then by Lemma 11.2. 2), both endpoints of  $f^{M_r}(e)$  were vertices that contradicts the fact that at least one endpoint of  $e$  is  $r$ -exceptional.

2) Let  $E'_1, E'_2$  be two edges in  $H'_r$ , where  $H_r$  is an exponential stratum. It suffices to show that  $(f')^k(E'_1)$  contains  $E'_2$  for some  $k \in \mathbb{N}$ .

We consider  $E'_1$  and  $E'_2$  as (partial)  $r$ -edges in  $\Gamma$ . By 1), we have  $L_r(E'_1) > 0$ . By definition of  $L_r$ , there exists  $n \in \mathbb{N}$  such that  $f^n(E'_1)$  contains a full  $r$ -edge  $E$  in  $\Gamma$ . Since the filtration for  $f$  is maximal, there exists  $m \in \mathbb{N}$  such that  $f^m(E)$  contains  $E'_2$ , and we are done.

3) If  $H_r$  is a nonexponential stratum in  $\Gamma$ , then the transition matrices for  $H_r$  and  $H'_r$  coincide. If  $H_r$  is an exponential stratum in  $\Gamma$ , then the Perron-Frobenius eigenvalues for  $H_r$  and  $H'_r$  coincide. Thus,  $H_r$  is exponential, polynomial, or zero stratum if and only if  $H'_r$  is exponential, polynomial, or zero stratum, respectively.

Property (RTT-i) for  $f'$  follows from the same property for  $f$  with the help of Lemma 12.2.1). Properties (RTT-ii) and (RTT-iii) for  $f'$  obviously follow from the corresponding properties for  $f$ . □

**Definition 12.5.** The PL-relative train track  $f' : \Gamma \rightarrow \Gamma'$  constructed from  $f : \Gamma \rightarrow \Gamma$  as above is called the *subdivided PL-relative train track* associated with  $f$ .

**Remark 12.6.** After appropriate identification of  $\Gamma$  and  $\Gamma'$ , the length functions  $L_r$  and  $L'_r$  coincide and the  $r$ -cancelation areas of  $f$  and  $f'$  coincide. By Lemma 12.2.2), the property (RTT-iv) is satisfied for  $f'$  with

$$P := \max\{|\mathcal{E}_r| \mid H_r \text{ is an exponential stratum of } \Gamma\}.$$

This number is computable by Lemma 11.2.1).

**Agreement.** From now on we will work with  $f'$  and never with the old  $f$ . So, we will simplify notation and skip dashes by writing  $f, \Gamma, G_i, H_i$  instead of  $f', \Gamma', G'_i, H'_i$ , respectively.

Below we collect the properties of the new  $f$  which we will use later.

**Proposition 12.7.** *The subdivided PL-relative train track  $f : \Gamma \rightarrow \Gamma$  satisfies the following properties:*

- 1) *This  $f$  represents the same automorphism of  $F$  as the original one.*
- 2) *For each exponential stratum  $H_r$ , there exists only finitely many  $r$ -cancelation areas. These areas can be computed.*
- 3) *Each  $r$ -cancelation area has an initial and a terminal subpaths which lie in  $H_r$  and have nonzero  $r$ -lengths.*
- 4) *If  $A$  is an  $r$ -cancelation area in a reduced  $r$ -stable path  $\tau \subset G_r$ , then  $[f(A)]$  is an  $r$ -cancelation area in the reduced  $r$ -stable path  $[f(\tau)]$ .*
- 5) *One can compute a natural number  $R_\star = R_\star(f)$  such that for each  $r$ -cancelation area  $A = \bar{p}q$  where  $p$  and  $q$  are  $r$ -legal, we have  $l(p) \leq R_\star$  and  $l(q) \leq R_\star$ .*
- 6) *One can compute a natural number  $P = P(f)$  such that for every exponential stratum  $H_r$  and every  $r$ -cancelation area  $A$ , the  $r$ -cancelation area  $[f^P(A)]$  is an edge path.*

*Proof.* The statement 1) is obvious. The statements 2), 3), and 4) follow from Theorem 9.8, Lemma 9.3, and Lemma 4.4.3). The statement 5) follows from 2). The statement 6) is contained in Remark 12.6.  $\square$

### 13. $r$ -SUPERSTABLE, $r$ -PERFECT, AND $A$ -PERFECT PATHS

in Sections 16 and 18 we need a stronger version of  $r$ -stability of paths, which we call  $r$ -superstability.

**Definition 13.1.** Let  $H_r$  be an exponential stratum. A reduced  $f$ -path  $\tau \subset G_r$  is called  $r$ -superstable if all  $r$ -cancelation points in  $\tau$  and in  $[\tau f(\tau)]$  are non-deletable and all  $r$ -cancelation areas in these paths are edge paths.

Note that if  $\tau$  is  $r$ -superstable, then  $[f^i(\tau)]$  is  $r$ -superstable for all  $i \geq 0$ .

**Lemma 13.2.** *Let  $H_r$  be an exponential stratum. For any reduced  $f$ -path  $\tau \subset G_r$ , one can efficiently compute a natural number  $S = S(\tau)$  such that the path  $[f^S(\tau)]$  is  $r$ -superstable.*

*Proof.* By Theorem 10.4 and Proposition 12.7.6), we can compute a number  $S_1$  such that all  $r$ -cancelation points in  $[f^{S_1}(\tau)]$  are non-deletable and all  $r$ -cancelation areas in  $[f^{S_1}(\tau)]$  are edge paths. Also, we can compute a number  $S_2$  such that all  $r$ -cancelation points in  $[f^{S_2}([\tau f(\tau)])]$  are non-deletable and all  $r$ -cancelation areas in  $[f^{S_2}([\tau f(\tau)])]$  are edge paths. We set  $S = \max\{S_1, S_2\}$ . Then the path  $[f^S(\tau)]$  is  $r$ -superstable.  $\square$

**Definition 13.3.** Let  $H_r$  be an exponential stratum. An edge path  $\tau \subset G_r$  is called  $r$ -perfect if the following conditions are satisfied:

- (i)  $\tau$  is a reduced  $f$ -path and its first edge belongs to  $H_r$ ,
- (ii)  $\tau$  is  $r$ -legal,
- (iii)  $[\tau f(\tau)] \equiv \tau \cdot [f(\tau)]$  and the turn of this path at the point between  $\tau$  and  $[f(\tau)]$  is legal.

A vertex in  $D_f$  is called  $r$ -perfect if the corresponding  $f$ -path in  $\Gamma$  is  $r$ -perfect.

Note that these conditions imply that  $[\tau f(\tau)]$  is  $r$ -legal. In the following proposition we formulate some important properties of  $r$ -perfect paths; they can be proved directly from the above definition.

**Proposition 13.4.** *Let  $H_r$  be an exponential stratum and let  $\tau$  be an  $r$ -perfect path in  $G_r$ . Then the following statements are satisfied:*

- (1) *For every  $i \geq 0$ , the path  $[f^i(\tau)]$  is  $r$ -perfect.*
- (2) *For every  $i \geq 0$ , the vertex  $[f^i(\tau)]$  of  $D_f$  lies in the  $\tau$ -subgraph. Moreover,  $[f^i(\tau)] \equiv \widehat{f}^{m_i}(\tau)$  for some computable  $m_i$  satisfying  $m_0 = 0$ ,  $m_i < m_{i+1}$ .*
- (3) *For every  $i \geq 0$ , the path  $\widehat{f}^i(\tau) \subset G_r$  is  $r$ -legal, contains edges from  $H_r$ , and  $L_r(\widehat{f}^{i+1}(\tau)) \geq L_r(\widehat{f}^i(\tau))$ .*

**Definition 13.5.** Let  $H_r$  be an exponential stratum. A reduced  $f$ -path  $\tau \subset G_r$  containing edges from  $H_r$  is called  $A$ -perfect if

- (i) all  $r$ -cancelation points in  $\tau$  are non-deletable, the corresponding  $r$ -cancelation areas are edge paths,
  - (ii) the  $A$ -decomposition of  $\tau$  begins with an  $A$ -area, i.e. it has the form  $\tau \equiv A_1 b_1 \dots A_k b_k$ ,  $k \geq 1$ ,
  - (iii)  $[\tau f(\tau)] \equiv \tau \cdot [f(\tau)]$  and the turn at the point between  $\tau$  and  $[f(\tau)]$  is legal.
- A vertex in  $D_f$  is called  $A$ -perfect if the corresponding  $f$ -path in  $\Gamma$  is  $A$ -perfect.

Note that the first edge of such  $\tau$  lies in  $H_r$ . The following proposition can be proved straightforward and we leave it for the reader.

**Proposition 13.6.** *Let  $H_r$  be an exponential stratum and let  $\tau$  be an  $A$ -perfect path in  $G_r$  with the  $A$ -decomposition  $\tau \equiv A_1 b_1 \dots A_k b_k$ .*

*For  $1 \leq j \leq k$ , we set  $\tau_{0,j} \equiv [A_j b_j \dots A_k b_k f(A_1 b_1 \dots A_{j-1} b_{j-1})]$  and for  $i \geq 1$  we set  $\tau_{i,j} \equiv [f^i(\tau_{0,j})]$ . Then the following statements are satisfied:*

- (1) *For any  $1 \leq j \leq k$  and  $i \geq 0$  the path  $\tau_{i,j}$  is  $A$ -perfect.*
- (2) *For any  $1 \leq j \leq k$  and  $i \geq 0$  the vertex  $\tau_{i,j}$  of  $D_f$  lies in the  $\tau$ -subgraph. Moreover  $\tau_{i,j} \equiv \widehat{f}^{m_{i,j}}(\tau)$  for some computable  $m_{i,j}$  satisfying  $m_{0,1} = 0$ ,  $m_{i,j} < m_{i,j+1}$ , and  $m_{i,k} < m_{i+1,1}$ .*

- (3) All  $A$ -perfect vertices of the  $\tau$ -subgraph are  $\tau_{i,j}$ ,  $1 \leq j \leq k$ ,  $i \geq 0$ .
- (4) For every vertex  $\sigma$  in the  $\tau$ -subgraph, at least one of the paths  $\sigma, \widehat{f}(\sigma), \dots, \widehat{f}^{l(\sigma)}(\sigma)$  coincides with  $\tau_{i,j}$  for some  $i, j$ .

#### 14. $\mu$ -SUBGRAPHS IN THE CASE WHERE $\mu$ AND $[\mu f(\mu)]$ ARE $r$ -LEGAL

**Proposition 14.1.** *Let  $H_r$  be an exponential stratum. Let  $\mu$  be a reduced  $r$ -legal  $f$ -path with endpoints in  $H_r$  and with the first edge in  $G_{r-1}$ , and the last edge in  $H_r$ . Then the  $\mu$ -subgraph of  $D_f$  contains a vertex which is an  $r$ -perfect path in  $G_r$ . This vertex can be efficiently found.*

*Proof.* We write  $\mu \equiv \sigma\tau$ , where  $\sigma$  is a nontrivial path in  $G_{r-1}$  and  $\tau$  is a nontrivial path in  $G_r$  with the first and the last edges from  $H_r$ . We prove that  $\mu' := \widehat{f}^{l(\sigma)}(\mu)$  is  $r$ -perfect.

Clearly,  $\mu' \equiv \tau[f(\sigma)]$ ,  $\mu'$  is  $r$ -legal and lies in the  $\mu$ -subgraph. It remains to prove that the turn between  $\mu'$  and  $[f(\mu')]$  in  $\mu' \cdot [f(\mu')]$  is legal.

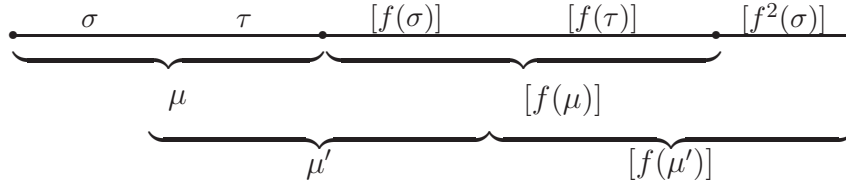

Figure 9.

By (RTT-ii),  $[f(\sigma)]$  is a nontrivial path in  $G_{r-1}$ . So, the last edge of  $\mu'$  lies in  $G_{r-1}$ . On the other hand, the first edge of  $[f(\mu')] \equiv [f(\tau)][f^2(\sigma)]$  lies in  $H_r$ . Therefore, the turn under consideration is mixed and hence legal.  $\square$

**Proposition 14.2.** *Let  $H_r$  be an exponential stratum and let  $\mu \subset G_r$  be a reduced  $f$ -path such that  $\mu$  is  $r$ -legal and  $[\mu f(\mu)]$  is  $r$ -legal or trivial. Then the  $\mu$ -subgraph of  $D_f$  contains a vertex  $\mu'$  for which at least one of the following statements is satisfied:*

- (1) the corresponding path  $\mu'$  lies in  $G_{r-1}$ ;
- (2) the corresponding path  $\mu'$  is  $r$ -perfect;
- (3) the  $\mu'$ -subgraph is finite.

Moreover, there exists an efficient algorithm which constructs such a vertex  $\mu'$  and indicates one of the statements (1)-(3) which is satisfied for  $\mu'$ .

*Proof.* We proceed by induction on the number of  $r$ -edges in  $\mu$ . We assume that  $\mu$  contains an  $r$ -edge, otherwise (1) is satisfied for  $\mu' := \mu$ . Write  $\mu \equiv b_1 \cdot b_2 \cdot b_3$ , where the (possibly trivial) edge paths  $b_1, b_3$  lie in  $G_{r-1}$  and the path  $b_2$  begins and ends with  $r$ -edges. We claim that the path  $\tilde{\mu} := b_2 \cdot [b_3 f(b_1)]$  satisfies the following properties:

- i) The path  $\tilde{\mu}$  is a reduced  $f$ -path which begins with an  $r$ -edge; it has the same number of  $r$ -edges as  $\mu$ .
- ii) The vertex  $\tilde{\mu}$  of  $D_f$  lies in the  $\mu$ -subgraph.
- iii) The path  $\tilde{\mu}$  is  $r$ -legal and the path  $[\tilde{\mu} f(\tilde{\mu})]$  is  $r$ -legal or trivial.

Indeed, i) is obvious; ii) is valid since  $\tilde{\mu} \equiv \hat{f}^{l(b_1)}(\mu)$ .

The claim iii) follows from the formulas

$$\tilde{\mu} \equiv [\bar{b}_1 \mu f(b_1)], \quad [\tilde{\mu} f(\tilde{\mu})] \equiv [\bar{b}_1 [\mu f(\mu)] f^2(b_1)].$$

Indeed, the  $r$ -legality of  $\tilde{\mu}$  follows from the assumption that  $\mu$  is  $r$ -legal and from the fact that the product of an  $r$ -legal path with a path from  $G_{r-1}$  followed by tightening is  $r$ -legal or trivial. Note that  $\tilde{\mu}$  is nontrivial since  $\mu$  contains an  $r$ -edge. Analogously, the path  $[\tilde{\mu} f(\tilde{\mu})]$  is  $r$ -legal or trivial, since, by assumption,  $[\mu f(\mu)]$  is  $r$ -legal or trivial.

Thus, replacing  $\mu$  by  $\tilde{\mu}$ , we may additionally assume that  $\mu$  begins with an edge  $E$  from  $H_r$ . Since  $\mu$  is  $r$ -legal,  $f(E)$  is an initial subpath of  $[f(\mu)]$ . Let  $\tau$  be the initial subpath of  $\mu$  such that  $\mu \equiv \tau \cdot \overline{I(\bar{\mu}, [f(\mu)])}$ . We consider the following four cases (see Figure 10).

**Case (1)** The path  $\tau$  is nontrivial (hence, it contains  $E$ ) and  $f(E)$  is an initial subpath of  $I(\bar{\mu}, [f(\mu)])$ .

**Case (2)** The path  $\tau$  is nontrivial (hence, it contains  $E$ ) and  $I(\bar{\mu}, [f(\mu)])$  is a proper initial subpath of  $f(E)$ .

**Case (3)** The path  $\tau$  is trivial (hence,  $\mu \equiv \overline{I(\bar{\mu}, [f(\mu)])}$ ) and  $f(E)$  is a proper initial subpath of  $I(\bar{\mu}, [f(\mu)])$ .

**Case (4)** The path  $\tau$  is trivial (hence,  $\mu \equiv \overline{I(\bar{\mu}, [f(\mu)])}$ ) and  $I(\bar{\mu}, [f(\mu)])$  is an initial subpath of  $f(E)$ .

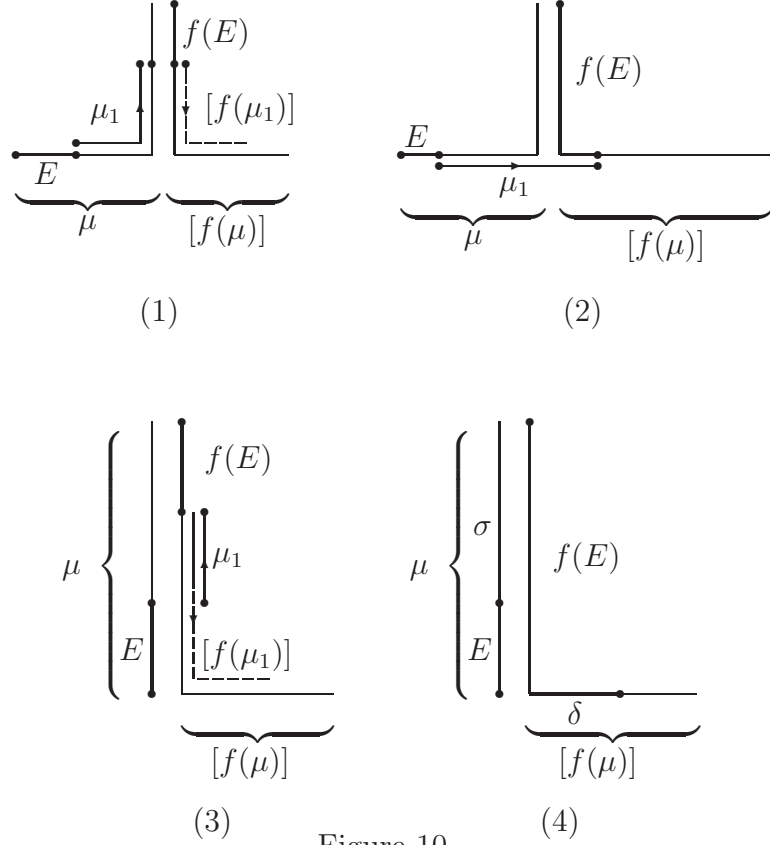

Figure 10.

In (1) and (2), the path  $\mu$  is depicted by the large left corner, and in (3), (4), it is depicted by a vertical line. The path  $[f(\mu)]$  is depicted by the large right corner.

**Consider Cases (1) and (3).**

Let  $\mu_1 := [\overline{E}\mu f(E)]$ . Clearly,  $\mu_1$  lies in the  $\mu$ -subgraph. Moreover, the paths  $\mu_1$  and  $[\mu_1 f(\mu_1)]$  are  $r$ -legal or trivial. Indeed:

in both cases  $\mu_1$  is a subpath of the  $r$ -legal path  $\mu$ ;

in Case (1),  $[\mu_1 f(\mu_1)]$  is a subpath of one of the  $r$ -legal paths  $\mu$  or  $[\mu f(\mu)]$ ;

in Case (3),  $[\mu_1 f(\mu_1)]$  is a subpath of one of the  $r$ -legal paths  $\mu$  or  $[f(\mu)]$ .

We may assume that  $\mu_1$  is nontrivial, otherwise the statement (3) is valid for  $\mu' := \mu_1$ . Since the number of  $r$ -edges in  $\mu_1$  is less than in  $\mu$ , we can proceed by induction and find the desired  $\mu'$  in the  $\mu_1$ -subgraph.

**Consider Case (2).** Let  $E_1$  be the second edge of  $[\mu f(\mu)]$ . In Figure 11, we distinguish the cases where  $\tau$  contains at least two edges (picture (1)) and where  $\tau$  contains exactly one edge (picture (2)).

We set  $\mu_1 := [\overline{E}\mu f(E)]$ . The path  $\mu_1$  is  $r$ -legal as a subpath of  $[\mu f(\mu)]$ , it begins with  $E_1$  and ends with the last edge of  $f(E)$ , and it lies in the  $\mu$ -subgraph.

Suppose that  $E_1$  is an  $r$ -edge. Then  $[f(\mu_1)]$  begins with the first edge of  $f(E_1)$ . Therefore the turn between  $\mu_1$  and  $[f(\mu_1)]$  coincides with the turn between  $f(E)$  and  $f(E_1)$ . This turn is legal, since the turn between  $E$  and  $E_1$  is an  $r$ -turn in the  $r$ -legal path  $[\mu f(\mu)]$ . Hence,  $\mu_1$  is  $r$ -perfect and we have the statement (2) for  $\mu' := \mu_1$ .

Now suppose that  $E_1$  lies in  $G_{r-1}$ . By Proposition 14.1 applied to  $\mu_1$ , we can construct  $\mu'$  satisfying the statement (2).

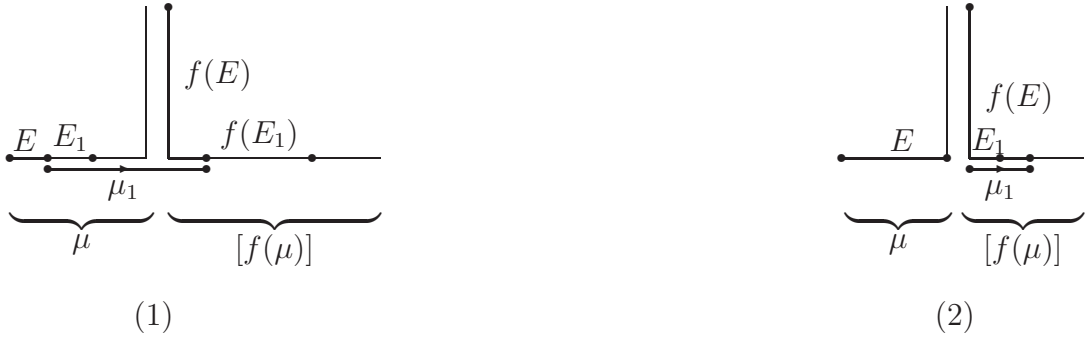

Figure 11.

Consider Case (4). Let  $\mu \equiv E \cdot \sigma$ , then  $f(E) \equiv \bar{\sigma} \cdot \overline{E} \cdot \delta$  for some path  $\delta$ . This implies  $\widehat{f}(\mu) \equiv \overline{E} \cdot \delta$  and  $\widehat{f}^2(\mu) \equiv \mu$ . Hence, the  $\mu$ -subgraph is finite and for  $\mu' := \mu$  we have the statement (3).  $\square$

15.  $\mu$ -SUBGRAPHS IN THE CASE WHERE  $\mu$  IS  $r$ -LEGAL, BUT  $[\mu f(\mu)]$  IS NOT

Recall that  $C_\star$  is the constant from Lemma 6.4 and  $R_\star$  is the constant from Proposition 12.7.5).

**Proposition 15.1.** *Let  $H_r$  be an exponential stratum. Let  $\mu \subset G_r$  be a reduced  $f$ -path which is  $r$ -legal. Suppose that  $[\mu f(\mu)]$  contains a non-deletable  $r$ -cancelation point and the  $r$ -cancelation area in  $[\mu f(\mu)]$  is an edge path. Then the  $\mu$ -subgraph contains a vertex  $\mu'$  for which at least one of the following statements is satisfied:*

- (1)  $l(\mu') \leq 3C_\star + 2R_\star + \|f\|$ ;
- (2) the path  $\mu'$  in  $\Gamma$  is  $A$ -perfect.

Moreover, there exists  $k \leq l(\mu)$  such that  $\mu' := \widehat{f}^k(\mu)$  satisfies (1) or (2). In particular, such  $\mu'$  can be efficiently found.

*Proof.* For  $i = 0, 1$ , let  $z^i$  be the unique non-deletable  $r$ -cancelation point in the path  $[f^i(\mu)f^{i+1}(\mu)]$  and let  $A(z^i)$  be the  $r$ -cancelation area in this path. We have

$A(z^1) \equiv [f(A(z^0))]$ . Let  $a$  and  $b$  be the initial and the terminal vertices of  $A(z^0)$ . Then  $f(a)$  and  $f(b)$  are the initial and the terminal vertices of  $A(z^1)$ .

Let  $\mu \equiv E_1 \dots E_n$ , and let  $\mu_m \equiv E_1 \dots E_m$  be the initial subpath of  $\mu$  until the vertex  $z^0$ . Thus  $I(\bar{\mu}, [f(\mu)]) \equiv \bar{E}_n \dots \bar{E}_{m+1}$ . Denote  $\mu_i := E_1 \dots E_i$  for  $i = 1, \dots, n$ .

**Case 1.** Suppose that there exists  $i \in \{1, \dots, m\}$  such that  $E_i \dots E_n$  cancels out in  $E_i \dots E_n \cdot [f(E_1 \dots E_{i-1})]$  and that  $i$  is minimal with this property.

Then, using induction, one can show that

$$\widehat{f}^{i-1}(\mu) \equiv [E_i \dots E_n \cdot [f(E_1 \dots E_{i-1})]].$$

By definition of  $i$ , we have  $[f(E_1 \dots E_{i-1})] \equiv \bar{E}_n \dots \bar{E}_i \ell$  for some edge path  $\ell$ . Since  $i \leq m$ , we can write  $[f(\mu_{i-1})] \equiv \bar{E}_n \dots \bar{E}_{m+1} \bar{E}_m \dots \bar{E}_i \ell$ . Hence, the maximal common initial subpath of  $[f(\mu_{i-1})]$  and  $[f(\mu)]$  is  $\bar{E}_n \dots \bar{E}_{m+1}$ . By Lemma 7.15, we have  $l(\bar{E}_m \dots \bar{E}_i \ell) \leq C_\star$ , and hence  $l(\ell) \leq C_\star$ . Since  $\widehat{f}^{i-1}(\mu) \equiv \ell$ , we have the statement (1) for  $\mu' := \widehat{f}^{i-1}(\mu)$ .

**Case 2.** Suppose that cancelations in  $E_i \dots E_n \cdot [f(E_1 \dots E_{i-1})]$  don't meet  $E_i$  for each  $i = 1, \dots, m$ . Then, for these  $i$ , one can deduce by induction that

$$\widehat{f}^i(\mu) \equiv [E_{i+1} \dots E_n \cdot [f(E_1 \dots E_i)]]. \quad (15.1)$$

*Notation.* For two vertices  $u, v$  in  $[f(\mu)]$ , we write  $u \prec v$  if  $u$  and  $v$  are the initial and the terminal vertices of some nontrivial subpath of  $[f(\mu)]$ .

*Case 2.1.* Let  $z^0 \preccurlyeq f(z^0)$ .

We write  $\mu \equiv p \cdot q$ , where  $p \equiv E_1 E_2 \dots E_s$  is the initial subpath of  $\mu$  until the vertex  $a$ , and  $q$  is the terminal subpath of  $\mu$  starting from the vertex  $a$ . Since  $s < m$ , the equation (15.1) implies  $\widehat{f}^s(\mu) \equiv [qf(p)]$ . We show that  $\mu' := \widehat{f}^s(\mu)$  satisfies the proposition. Consider three variants for the position of  $f(a)$  in  $[f(\mu)]$ .

*Variant 1.* Suppose that  $b \prec f(a)$  (see Figure 12).

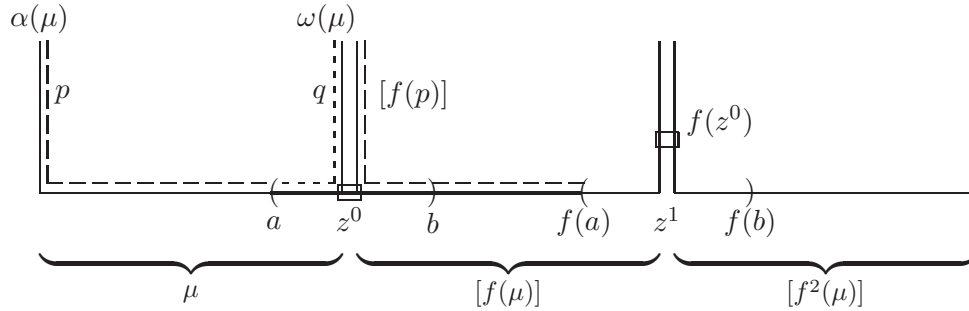

Figure 12.



Then  $\mu'$  is the subpath of  $[\mu f(\mu)]$  from  $a$  to  $f(a)$ . We prove that  $\mu'$  is  $A$ -perfect. Then the statement (2) will be fulfilled. First note that  $\mu'$  has the  $A$ -decomposition  $\mu' \equiv A(z^0) \cdot \ell$ , where  $\ell$  is the subpath of  $[f(\mu)]$  from  $b$  to  $f(a)$ . We have  $[f(\mu')] \equiv A(z^1) \cdot [f(\ell)]$ . By Proposition 12.7.3), the first edge of the  $r$ -cancellation area  $A(z^1)$  lies in  $H_r$ . Then, in  $\mu' \cdot [f(\mu')]$ , the turn at the point between  $\mu'$  and  $[f(\mu')]$  is either mixed in  $(G_{r-1}, G_r)$  or an  $r$ -turn. In the first case, this turn is legal. In the second case it is  $r$ -legal, since it belongs to the  $r$ -legal path  $[f(\mu)]$ . Thus,  $\mu'$  is  $A$ -perfect.

For two vertices  $u, v$  in a reduced edge path  $\sigma$ , let  $l_\sigma(u, v)$  be the number of edges in the subpath of  $\sigma$  from  $u$  to  $v$ .

*Variant 2.* Suppose that  $z^0 \preceq f(a) \preceq b$ . Then  $l(\mu') = l_{[\mu f(\mu)]}(a, f(a)) \leq l_{[\mu f(\mu)]}(a, b) \leq 2R_\star$ , hence  $\mu'$  satisfies the statement (1).

*Variant 3.* Suppose that  $\alpha([f(\mu)]) \preceq f(a) \prec z^0$ . Then

$$\begin{aligned} l(\mu') &\leq l_\mu(a, z^0) + l_{[f(\mu)]}(f(a), z^0) \\ &\leq l_\mu(a, z^0) + l_{[f(\mu)]}(f(a), f(z^0)) \\ &\leq l_\mu(a, z^0) + l_{[f(\mu)]}(f(a), z^1) + l_{[f(\mu)]}(z^1, f(z^0)) \leq 2R_\star + C_\star. \end{aligned}$$

Hence,  $\mu'$  satisfies the statement (1).

*Case 2.2.* Suppose that  $f(z^0) \prec z^0$ . We show how to find  $\mu'$  satisfying (1). By Lemma 7.15, for each initial subpath  $\mu_j$  of  $\mu$ , we have  $[f(\mu_j)] \equiv \tau_j \ell_j$ , where  $\tau_j$  is the maximal common initial subpath of  $[f(\mu_j)]$  and  $[f(\mu)]$ , and  $l(\ell_j) \leq C_\star$ . Recall that  $\mu_m \equiv E_1 \dots E_m$  is the initial subpath of  $\mu$  which terminates at  $z^0$ . Since  $E_m$  is an  $r$ -edge and  $\mu$  is  $r$ -legal,  $[f(\mu_m)] \equiv \tau_m$  is the initial subpath of  $[f(\mu)]$  which terminates at  $f(z^0)$ . Observe:

- (a)  $\omega(\mu_m) \succ \omega(\tau_m)$  (since  $z^0 \succ f(z^0)$ ),
- (b)  $\omega(\mu_n) \prec \omega(\tau_n)$  (since  $\omega(\mu_n) = \alpha([f(\mu)]) \prec \omega([f(\mu)]) = \omega(\tau_n)$ ),
- (c) the  $l$ -distance in  $[f(\mu)]$  between  $\omega(\tau_j)$  and  $\omega(\tau_{j+1})$  is at most  $2C_\star + \|f\|$ .

Indeed, (c) follows from  $\tau_{j+1} \ell_{j+1} = f(\mu_{j+1}) = f(\mu_j E_{j+1}) = \tau_j \ell_j f(E_{j+1})$ .

Claims (a)-(c) imply that there exists  $m \leq k < n$  such that, for all  $m \leq j \leq k$ , we have  $\omega(\mu_j) \succ \omega(\tau_j)$ , but  $\omega(\mu_{k+1}) \preceq \omega(\tau_{k+1})$ . From this and (c), we have:

- (d) the  $l$ -distance in  $[f(\mu)]$  between  $\omega(\mu_k)$  and  $\omega(\tau_k)$  is at most  $2C_\star + \|f\| + 1$ .
- (e) For  $m \leq j \leq k$ , we have  $\widehat{f}^j(\mu) \equiv [E_{j+1} \dots E_n \cdot \tau_j \ell_j]$ .

We prove (e) by induction. For  $j = m$  this is valid by (15.1). Suppose (e) is valid for some  $m \leq j < k$  and we prove it for  $j + 1$ . Since  $\omega(\mu_j) \succ \omega(\tau_j)$ , the first edge of

$\widehat{f}^j(\mu)$  is  $E_{j+1}$ . Then  $\widehat{f}^{j+1}(\mu) \equiv [\bar{E}_{j+1}\widehat{f}^j(\mu)f(E_{j+1})] \equiv [\bar{E}_{j+1}[\bar{\mu}_j\mu f(\mu_j)]f(E_{j+1})] \equiv [\bar{\mu}_{j+1}\mu f(\mu_{j+1})] \equiv [\bar{\mu}_{j+1}\mu\tau_{j+1}\ell_{j+1}] \equiv [E_{j+2} \dots E_n\tau_{j+1}\ell_{j+1}]$ , and we are done.

From (e) we have  $\widehat{f}^k(\mu) \equiv [E_{k+1} \dots E_n \cdot \tau_k\ell_k]$ , and from (d) we conclude that  $l(\widehat{f}^k(\mu)) = l([E_{k+1} \dots E_n \cdot \tau_k]) + l(\ell_k) \leq 3C_\star + \|f\| + 1 \leq 3C_\star + R_\star + \|f\|$ . Thus, the statement (1) is satisfied for  $\mu' := \widehat{f}^k(\mu)$ .  $\square$

## 16. $\mu$ -SUBGRAPHS IN THE CASE WHERE $\mu$ IS NOT $r$ -LEGAL, BUT $r$ -SUPERSTABLE

Let  $H_r$  be an exponential stratum. Recall that a reduced path  $\tau \subset G_r$  is called  $r$ -stable if all  $r$ -cancellation points in  $\tau$  are non-deletable. By Theorem 10.4, for any reduced edge path  $\tau \subset G_r$ , one can compute a natural number  $i_0$  such that  $[f^{i_0}(\tau)]$  is  $r$ -stable. The number of  $r$ -cancellation points in  $[f^{i_0}(\tau)]$  is denoted by  $N_r(\tau)$ . Note that  $N_r(\tau)$  is the minimum of the numbers of  $r$ -cancellation points in the paths  $[f^i(\tau)]$ ,  $i \geq 0$ . The  $r$ -superstable paths were introduced in Definition 13.1.

**Proposition 16.1.** *Let  $H_r$  be an exponential stratum. Suppose that  $\mu$  is an  $r$ -superstable reduced  $f$ -path in  $G_r$  with  $N_r(\mu) \geq 1$ . Then the  $\mu$ -subgraph contains a vertex  $\mu_1$  for which at least one of the following statements is satisfied:*

- (1)  $l(\mu_1) \leq C_\star + 2R_\star$ ;
- (2)  $N_r(\mu_1) < N_r(\mu)$ ;
- (3) the path  $\mu_1$  in  $\Gamma$  is  $A$ -perfect.

Moreover, there exists  $s \leq l(\mu)$  such that  $\mu_1 := \widehat{f}^s(\mu)$  satisfies (1), (2), or (3). In particular, such  $\mu_1$  can be efficiently found.

*Proof.* Let  $y_1, \dots, y_k$  ( $k \geq 1$ ) be all  $r$ -cancellation points in  $\mu$  (they are non-deletable, since  $\mu$  is  $r$ -stable) and let  $y_1^1, \dots, y_k^1$  be their 1-successors in  $[f(\mu)]$ . The terminal point of  $I_0 := I(\bar{\mu}, [f(\mu)])$  is denoted by  $z^0$ . For two vertices  $v, u \in \mu$ , we denote by  $l_\mu(v, u)$  the length of the subpath of  $\mu$  from  $v$  to  $u$ .

*Case 1.* Suppose that  $y_k$  lies in  $I_0$ .

The proof is illustrated by Figure 13, where we distinguish two cases:

- (a)  $y_k$  lies in the interior of  $I_0$ . In this case  $y_k = y_1^1$ .
- (b)  $y_k$  coincides with the terminal vertex of  $I_0$ .

The point  $y_1$  divides  $\mu$  into two subpaths, say  $p$  and  $q$ , so  $\mu \equiv pq$ .

*Claim.* For every decomposition  $p \equiv p_1p_2$ , where  $p_1$  is a proper initial edge-subpath of  $p$ , cancellations in the product  $p_2q \cdot [f(p_1)]$  don't touch the first edge of  $p_2$ .

To prove this claim, it suffices to note that  $[f(p_1)]$  is  $r$ -legal, but  $p_2q$  is not. The first follows from the fact that  $p$ , and hence  $p_1$ , are  $r$ -legal; the second follows from the fact that  $p_2q$  contains the  $r$ -cancellation point  $y_k$ .

Now we set  $\mu_1 := \widehat{f}^{l(p)}(\mu)$ . Clearly,  $\mu_1$  lies in the  $\mu$ -subgraph. We assert that  $N_r(\mu_1) < N_r(\mu)$ . To prove this, we describe the path  $\mu_1$  precisely. First, by the above claim we have  $\mu_1 \equiv [qf(p)]$ . Second, we observe that  $\mu_1 \equiv \mu_{y_1 y_k} \cdot \ell$ , where  $\mu_{y_1 y_k}$  is the initial subpath of  $q$  from  $y_1$  to  $y_k$  and  $\ell$  is the final subpath of  $[f(p)]$  from  $y_k$  to  $f(y_1)$ . Since  $[f(p)]$  and hence  $\ell$  are  $r$ -legal, the  $r$ -cancellation points of  $\mu_1$  are contained in the set  $\{y_1, \dots, y_k\} \setminus \{y_1\}$ . Hence,  $N_r(\mu_1) < N_r(\mu)$ .

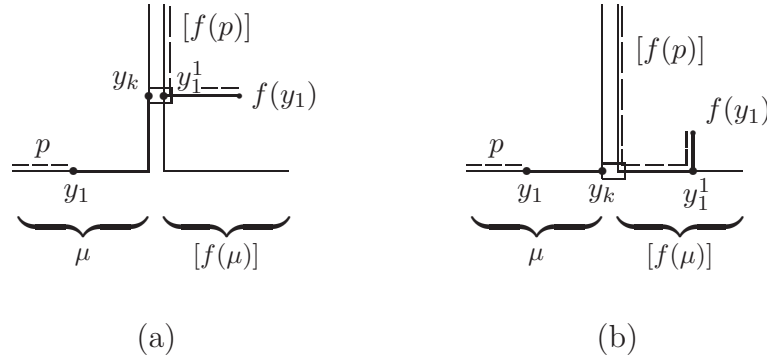

Figure 13.

The path  $\mu_1$  from  $y_1$  to  $f(y_1)$  is depicted by the bold line. The point  $y_1$  on the left picture can lie in  $I_0$ . The point  $y_1^1$  on the right picture can coincide with  $y_k$ . The case  $k = 1$  is possible.

*Case 2.* Suppose that  $y_k$  does not lie in  $I_0$ , but  $y_1^1$  lies in  $I_0$ . In this case  $y_1^1 = z^0$ , where  $z^0$  is the terminal vertex of  $I_0$ .

*Case 2.1.* Suppose that  $l_\mu(y_1, y_1^1) > R_\star + C_\star$ . The proof in this case is illustrated by Figure 14.

Let  $u$  be the terminal vertex of the  $r$ -cancellation area  $A(y_1)$  in  $\mu$ . The point  $u$  divides  $\mu$  into two subpaths, say  $p$  and  $q$ , so  $\mu \equiv pq$ .

By definition of  $R_\star$ , we have  $l_\mu(y_1, u) \leq R_\star$ , hence  $l_\mu(u, y_1^1) > C_\star$  and  $u$  lies in  $\mu$  between  $y_1$  and  $y_1^1$ .

*Claim.* For every decomposition  $p \equiv p_1 p_2$ , where  $p_1$  is a proper initial edge-subpath of  $p$ , cancellations in the product  $p_2 q \cdot [f(p_1)]$  don't touch  $p_2$ .

Indeed, since  $p_1$  is an initial subpath of  $\mu$ , by Lemma 7.15, we have  $[f(p_1)] = ab$  for some initial subpath  $a$  of  $[f(\mu)]$  and some path  $b$  of length at most  $C_\star$ . This and the fact that  $l_\mu(u, y_1^1) > C_\star$  imply the claim.

Let  $\mu_1 := \widehat{f}^{l(p)}(\mu)$ . Clearly,  $\mu_1$  lies in the  $\mu$ -subgraph. We assert that  $N_r(\mu_1) < N_r(\mu)$ . To prove this, we describe the path  $\mu_1$  precisely. First, by the above claim we have  $\mu_1 \equiv [qf(p)]$ . Then  $\mu_1 \equiv \mu_{u y_1^1} \cdot \ell$ , where  $\ell$  is the subpath of  $[f(\mu)]$  from

$y_1^1 = z^0$  to  $f(u)$ . Since  $\ell$  is  $r$ -legal, the  $r$ -cancellation points of  $\mu_1$  are contained in the set  $\{y_1, \dots, y_k, y_1^1\} \setminus \{y_1\}$ . However,  $y_1^1$  is not an  $r$ -cancellation point of  $\mu_1$ , see Case (4) in Remark 8.6. Hence,  $N_r(\mu_1) < N_r(\mu)$ .

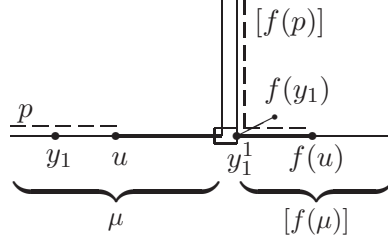

Figure 14.

The path  $\mu_1$  is depicted by the bold line from  $u$  to  $f(u)$ .

*Case 2.2.* Suppose that  $l_\mu(y_1, y_1^1) \leq R_\star + C_\star$ .

Let  $p$  be the initial subpath of  $\mu$  which terminates at  $y_1$  (see Figure 15); then  $\mu \equiv pq$  for some  $q$ . We set  $\mu_1 := \widehat{f}^{l(p)}(\mu)$ . As in Case 1, one can prove that  $\mu_1 \equiv [qf(p)]$ , and hence  $\mu_1 \equiv [\mu_{y_1 y_1^1} \cdot \ell]$ , where  $\mu_{y_1 y_1^1}$  is the initial subpath of  $q$  from  $y_1$  to  $y_1^1$  and  $\ell$  is the final subpath of  $[f(p)]$  from  $y_1^1$  to  $f(y_1)$ . Using Lemma 7.15, we deduce that  $l(\ell) \leq C_\star$ , hence

$$l(\mu_1) \leq l_\mu(y_1, y_1^1) + l(\ell) \leq R_\star + 2C_\star,$$

and we have the statement (1).

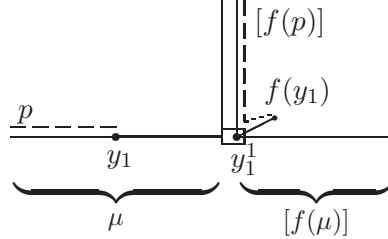

Figure 15.

The path  $\mu_1$  is depicted by the bold line from  $y_1$  to  $f(y_1)$ .

*Case 3.* Suppose that both,  $y_k$  and  $y_1^1$  don't lie in  $I_0$ .

Then  $y_1, \dots, y_k, y_1^1, \dots, y_k^1$  don't lie in  $I_0$ .

We may assume that  $z^0$  is an  $r$ -cancellation point in  $[\mu f(\mu)]$ .

Indeed, suppose the opposite. We set  $\mu_1 := \widehat{f}^{l(p)}(\mu)$ , where  $p$  is the initial subpath of  $\mu$  with the endpoint  $y_1$  (see Figure 16). Then  $\mu_1$  lies in the  $\mu$ -subgraph

and the  $r$ -cancellation points of  $\mu_1$  are contained in the set  $\{y_2, \dots, y_k, z^0\}$ . But  $z^0$  is not an  $r$ -cancellation point in  $\mu_1$ , since we have supposed that  $z^0$  is not an  $r$ -cancellation point in  $[\mu f(\mu)]$ . So,  $N_r(\mu_1) = N_r(\mu) - 1$  and we were done.

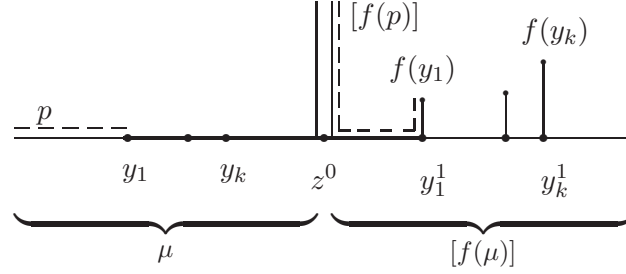

Figure 16.

The path  $\mu_1$  is depictedured by the bold line from  $y_1$  to  $f(y_1)$ .

Thus, we may assume that  $y_1, \dots, y_k, z^0, y_1^1, \dots, y_k^1$  are all  $r$ -cancellation points in  $[\mu f(\mu)]$ . Since  $\mu$  is  $r$ -superstable, they are non-deletable there.

Let  $A(y_1^1)$  be the  $r$ -cancellation area in  $[f(\mu)]$  containing  $y_1^1$ . Let  $A'(z^0)$  and  $A'(y_1^1)$  be the  $r$ -cancellation areas in  $[\mu f(\mu)]$  containing  $z^0$  and  $y_1^1$ , respectively.

*Claim.* We have  $A(y_1^1) = A'(y_1^1)$ . In particular,  $\alpha(A(y_1^1))$  lies to the right from  $z^0$  in  $[\mu f(\mu)]$ .

Indeed, since the interiors of  $A'(z^0)$  and  $A'(y_1^1)$  don't intersect,  $A'(y_1^1)$  lies to the right from  $z^0$  in  $[\mu f(\mu)]$ . Hence  $A'(y_1^1)$  lies in  $[f(\mu)]$ . Therefore  $A(y_1^1) = A'(y_1^1)$ .

The further proof is illustrated by Figure 17.

Let  $u$  be the initial vertex of the  $r$ -cancellation area  $A(y_1)$  in  $\mu$ . The point  $u$  divides  $\mu$  into two subpaths, say  $p$  and  $q$ , so  $\mu \equiv pq$ . We set  $\mu_1 := \widehat{f}^{l(p)}(\mu)$ . Clearly,  $\mu_1$  lies in the  $\mu$ -subgraph. As in Case 1, we can prove that  $\mu_1 \equiv [qf(p)]$  and hence  $\mu_1$  is the subpath of  $[\mu f(\mu)]$  from  $\alpha(A(y_1))$  to  $\alpha(A(y_1^1))$ .

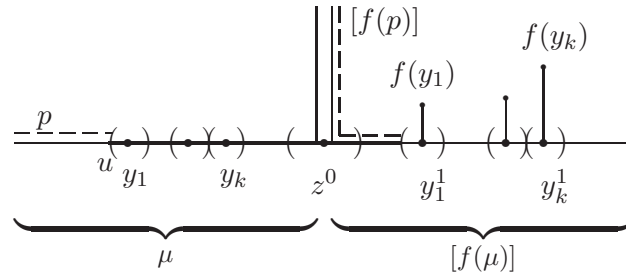

Figure 17.

The path  $\mu_1$  is depictedured by the bold line from  $u$  to the endpoint of  $[f(p)]$ .

We prove that  $\mu_1$  is  $A$ -perfect. Obviously, the  $A$ -decomposition of  $\mu_1$  starts with the  $r$ -cancellation area  $A(y_1)$ . It remains to prove that the turn in  $\mu_1 \cdot [f(\mu_1)]$  between  $\mu_1$  and  $[f(\mu_1)]$  is legal. The first edge of  $[f(\mu_1)]$  is the first edge of  $[f(A(y_1))] = A(y_1^1)$ , so this edge lies in  $H_r$ . If the last edge of  $\mu_1$  lies in  $G_{r-1}$ , then the turn is mixed and hence legal. If the last edge of  $\mu_1$  lies in  $H_r$ , then this turn is an  $r$ -turn. But this turn lies in the  $r$ -legal subpath of  $[\mu f(\mu)]$  from  $z^0$  to  $y_1^1$ , hence it is  $r$ -legal. Thus,  $\mu_1$  is  $A$ -perfect and lies in the  $\mu$ -subgraph; the proof is completed.  $\square$

## 17. CONES OVER VERTICES OF $D_f$

The main purpose of this section is to define the  $\mu$ -cone,  $\mathbf{Cone}(\mu)$ , for a vertex  $\mu \in D_f$  (see Definition 17.6 and Figure 21), and to prove Corollary 17.12. This corollary implies that if the associated function  $B_\mu$  is constant, then the  $\mu$ -cone is  $(f \text{ or } f^2)$ -invariant, i.e. for each  $\sigma \in \mathbf{Cone}(\mu)$ , at least one of the vertices  $[f(\sigma)]$  or  $[f^2(\sigma)]$  lies in  $\mathbf{Cone}(\mu)$ .

**Notation 17.1.** 1) For any vertex  $\tau \in D_f$ , there is a unique path in  $D_f$  from  $\tau$  to  $[f(\tau)]$  with the label  $\tau$ . We denote this path by  $p_\tau$ .

2) If  $p$  is a reduced path in  $D_f$  from  $\tau$  to  $\sigma$  with the label  $E_1 E_2 \dots E_k$ , then there is a reduced path in  $D_f$  from  $[f(\tau)]$  to  $[f(\sigma)]$  with the label  $[f(E_1 E_2 \dots E_k)]$ . We denote this path by  $f_\bullet(p)$ .

**Proposition 17.2.** *If  $\tau$  is an alive vertex in  $D_f$ , then the first edge of  $p_\tau$  coincides with the first edge of the  $\tau$ -subgraph.*

*Proof.* Let  $\tau \equiv E_1 E_2 \dots E_k$ . Then the path  $p_\tau \subset D_f$  starts at  $\tau$  and the labels of consecutive edges of  $p_\tau$  are  $E_1, \dots, E_k$ . The  $\tau$ -subgraph also starts at  $\tau$ , and the first edge of the  $\tau$ -subgraph is labeled by  $E_1$ . Therefore the first edges coincide.  $\square$

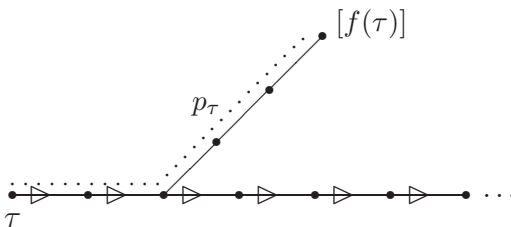

Figure 18.

**Remark.** The second edge of the  $\tau$ -subgraph and the second edge of the path  $p_\tau$  can be different. Indeed, the second vertex of the  $\tau$ -subgraph is  $[\bar{E}_1 \tau f(E_1)] = [E_2 E_3 \dots E_k f(E_1)]$ . The label of the second edge of the  $\tau$ -subgraph is the first edge of the  $f$ -path  $[\bar{E}_1 \tau f(E_1)]$ . This label is not necessarily  $E_2$ ; however the label of the second edge of  $p_\tau$  is  $E_2$ .

**Definition 17.3.** A path  $p$  in  $D_f$  is called *directed* if either  $p$  is a vertex in  $D_f$  or  $p \equiv E_1 E_2 \dots E_n$ , where  $E_1, \dots, E_n$  are edges in  $D_f$  and the preferable direction at  $\alpha(E_i)$  is the direction of  $E_i$  for each  $i = 1, 2, \dots, n$ .

The set of all repelling vertices of  $D_f$  is denoted by  $\mathbf{Rep}(D_f)$ .

**Lemma 17.4.** Let  $\mu$  and  $\sigma$  be two vertices in  $D_f$ . Suppose that  $p$  is a reduced path in  $D_f$  from  $\sigma$  to a vertex  $\tau$  in the  $\mu$ -subgraph and that the inverse to the last edge of  $p$  does not lie in the  $\mu$ -subgraph. Then there exists a vertex  $\sigma_1 \in \{\sigma\} \cup \mathbf{Rep}(D_f)$  such that  $\sigma_1$  lies in  $p$  and the subpath of  $p$  from  $\sigma_1$  to  $\tau$  is directed.

*Proof.* We may assume that  $p$  is nontrivial. Let  $p \equiv E_1 E_2 \dots E_n$ . If  $E_n$  is a repelling edge, we take  $\sigma_1 := \omega(E_n)$ . If not, then the preferable direction at  $\alpha(E_n)$  is carried by  $E_n$  (see Figure 19). If  $E_{n-1}$  is a repelling edge, we take  $\sigma_1 := \omega(E_{n-1})$ . If not, then the preferable direction at  $\alpha(E_{n-1})$  is carried by  $E_{n-1}$ . Continuing by induction, we complete the proof.  $\square$

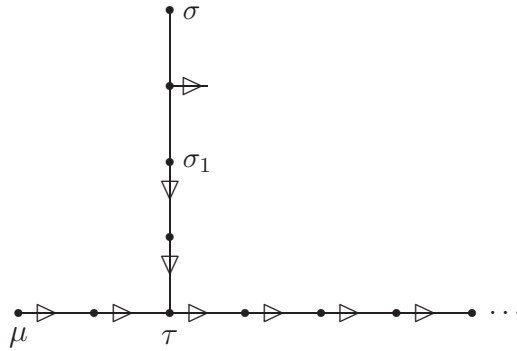

Figure 19.

**Definition 17.5.** Let  $\mu$  and  $\sigma$  be two vertices in  $D_f$  and let  $k \geq 1$  and  $\ell \geq 0$  be integer numbers. We say that  $\sigma$  is  $(k, \ell)$ -close to  $\mu$  if there exist a vertex  $\tau$  in  $D_f$ , a directed path of length  $k$  from  $\mu$  to  $\tau$ , and a directed path of length  $\ell$  from  $\sigma$  to  $\tau$  such that the last edges of these paths do not coincide.

Such  $\tau$  is called a  $\sigma$ -entrance into the  $\mu$ -subgraph.

**Remark.** The vertex  $\sigma$  can be  $(k, \ell)$ -close to  $\mu$  for several pairs  $(k, \ell)$ . Also there can be several  $\sigma$ -entrances into the  $\mu$ -subgraph for given  $\sigma$  and  $\mu$ .

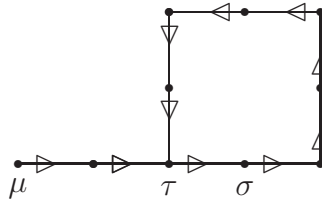

Figure 20.

For example, in Figure 20,  $\sigma$  is simultaneously  $(3 + 8k, 0)$ -close and  $(2, 7 + 8k)$ -close to  $\mu$  for each  $k = 0, 1, \dots$ . Moreover,  $\sigma$  and  $\tau$  are  $\sigma$ -entrances into the  $\mu$ -subgraph. If the  $\mu$ -subgraph is a ray and  $\sigma \in D_f^0$  is given, then the set of  $\sigma$ -entrances into the  $\mu$ -subgraph is either empty or consists of a single element. We stress that  $k \geq 1$  in the above definition.

**Definition 17.6.** Given two vertices  $\mu, \sigma \in D_f^0$ , we define  $\mathbf{Entr}(\sigma, \mu)$  as the set of all  $\sigma$ -entrances into the  $\mu$ -subgraph. The set

$$\mathbf{Cone}(\mu) = \{\sigma \in D_f^0 \mid \mathbf{Entr}(\sigma, \mu) \neq \emptyset\}$$

is called the  $\mu$ -cone. For each  $k \geq 1$ , the set

$$\mathbf{Cone}^{(k)}(\mu) = \{\sigma \in \mathbf{Cone}(\mu) \mid \sigma \text{ is } (k, \ell)\text{-close to } \mu \text{ for some } \ell \geq 0\}$$

is called the  $k$ -branch of the  $\mu$ -cone.

Observe that if  $\sigma \in \mathbf{Cone}(\mu)$  and  $\sigma$  is not dead, then  $\widehat{f}(\sigma) \in \mathbf{Cone}(\mu)$ . The  $\mu$ -cone is the union of its  $\mu$ -branches.

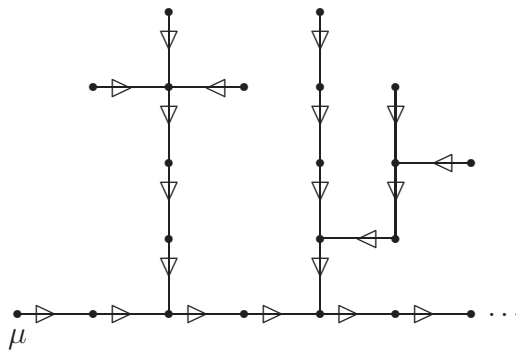

Figure 21.

All vertices on this figure, except of  $\mu$ , lie in  $\mathbf{Cone}(\mu)$ .

**Notation 17.7.** Let  $\mu, \tau$  be vertices in  $D_f$ . We write  $\mu \preceq \tau$  if there exists  $i \geq 0$  with  $\widehat{f}^i(\mu) = \tau$ . We also write  $\mu \prec \tau$  if there exists  $i > 0$  with  $\widehat{f}^i(\mu) = \tau$ . Clearly, the relation  $\preceq$  is reflexive and transitive, but not necessarily antisymmetric (see Figure 20).

Recall that each vertex in  $D_f$  is an  $f$ -path in  $\Gamma$ , hence it has an  $l$ -length. The following proposition implies that  $\mathbf{Cone}(\mu)$  is  $(f$  or  $f^2)$ -invariant if all vertices of the  $\mu$ -subgraph have  $l$ -lengths larger than  $C_\star$  and if the  $\mu$ -cone does not contain repelling vertices.

**Proposition 17.8.** Let  $\mu$  be a vertex in  $D_f$ ,  $\sigma \in \mathbf{Cone}(\mu)$  and  $\tau \in \mathbf{Entr}(\sigma, \mu)$ . If  $l(\tau) > C_\star$ , then there exist  $\sigma_1 \in \mathbf{Cone}(\mu)$  and  $\tau_1 \in \mathbf{Entr}(\sigma_1, \mu)$  such that



- 1)  $\sigma_1 \in \{[f(\sigma)], [f^2(\sigma)]\} \cup \mathbf{Rep}(D_f)$ ;
- 2)  $\tau \preceq \tau_1$ ;
- 3) there are directed paths from  $\tau$  to  $\tau_1$  and from  $\sigma_1$  to  $\tau_1$  of lengths at most
 
$$\max\{l(\sigma) + \text{dist}(\sigma, \tau), l(\tau) + l([f(\sigma)]) + C_\star\},$$

where  $\text{dist}(\sigma, \tau)$  is the number of edges in the shortest directed path from  $\sigma$  to  $\tau$ .

*Proof.* We consider the path  $p_\sigma$  from  $\sigma$  to  $[f(\sigma)]$  with the label  $\sigma$ . Note that  $f_\bullet(p_\sigma)$  is the path from  $[f(\sigma)]$  to  $[f^2(\sigma)]$  with the label  $[f(\sigma)]$ . Also we consider the shortest directed path  $p_{\sigma, \tau}$  from  $\sigma$  to  $\tau$ .

*Case 1.* Suppose that the maximal common initial subpath of  $p_{\sigma, \tau}$  and  $p_\sigma$  is a proper subpath of  $p_{\sigma, \tau}$  (see Figure 22).

We write  $p_{\sigma, \tau} \equiv p_1 p_2$  and  $p_\sigma \equiv p_1 p_3$ , where  $p_1$  is the maximal common initial subpath of  $p_{\sigma, \tau}$  and  $p_\sigma$ . By Lemma 17.4, there exists a vertex  $\sigma_1 \in \{[f(\sigma)]\} \cup \mathbf{Rep}(D_f)$  in  $\bar{p}_3$ , such that the subpath of  $\bar{p}_3$  from  $\sigma_1$  to the end of  $\bar{p}_3$  is directed. Let  $\bar{p}_4$  be this subpath. Then  $\bar{p}_4 p_2$  is the directed path from  $\sigma_1$  to  $\tau$ , and we can set  $\tau_1 := \tau$ . In this case the statements 1) and 2) are evident. The statement 3) is valid since  $\text{dist}(\sigma_1, \tau_1) \leq l(\bar{p}_4 p_2) \leq l(p_\sigma) + \text{dist}(\sigma, \tau) = l(\sigma) + \text{dist}(\sigma, \tau)$ .

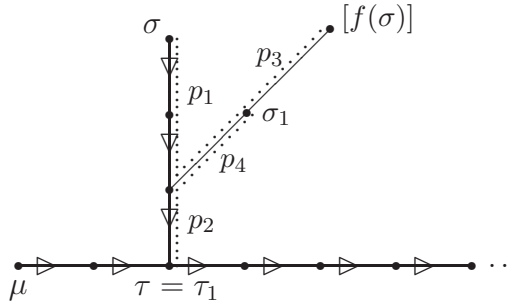

Figure 22.

*Case 2.* Suppose that  $p_{\sigma, \tau}$  is an initial segment of  $p_\sigma$ .

Then the vertex  $\tau$  lies on the reduced path  $p_\sigma$ . By Lemma 6.4,  $[f(\tau)]$  lies in the  $C_\star$ -neighborhood of some vertex  $\nu$  on the reduced path  $f_\bullet(p_\sigma)$  from  $[f(\sigma)]$  to  $[f^2(\sigma)]$  (see Figure 23). Let  $p_1$  be a path from  $[f(\tau)]$  to  $\nu$  of length at most  $C_\star$ . Recall that  $p_\tau$  is the reduced path from  $\tau$  to  $[f(\tau)]$  with the label  $\tau$ . Hence,  $l(p_\tau) = l(\tau) > C_\star$  by assumption. By Proposition 17.2, the first edge of  $p_\tau$  carries the preferable direction at  $\tau$ .

Let  $q_{\tau, \nu}$  be the reduced form of the path  $p_\tau p_1$ . Then  $q_{\tau, \nu}$  is a path from  $\tau$  to  $\nu$ , it has length at most  $l(\tau) + C_\star$ , and the first edge of  $q_{\tau, \nu}$  coincides with the first edge of  $p_\tau$ , i.e. with the directed edge emanating from  $\tau$ .

The vertex  $\nu$  divides the reduced path  $f_\bullet(p_\sigma)$  into two subpaths, say  $f_\bullet(p_\sigma) \equiv q_1 q_2$ . Then one of the paths  $q_{\tau, \nu} q_1$  or  $q_{\tau, \nu} q_2$  is reduced. W.l.o.g., we may assume

that  $q_{\tau,\nu}q_2$  is reduced. This path terminates at  $[f^2(\sigma)]$  and its first edge is the directed edge emanating from  $\tau$ . We write  $q_{\tau,\nu}q_2 \equiv qp$ , where  $q$  is the maximal initial subpath of  $q_{\tau,\nu}q_2$  that lies in the  $\tau$ -subgraph. By Lemma 17.4, there is a vertex  $\sigma_1 \in \{[f^2(\sigma)]\} \cup \mathbf{Rep}(D_f)$  such that  $\sigma_1$  lies in  $\bar{p}$  and the subpath of  $\bar{p}$  from  $\sigma_1$  to  $\tau_1 := \omega(q)$  is directed. Clearly,  $\sigma_1 \in \mathbf{Cone}(\mu)$  and  $\tau_1 \in \mathbf{Entr}(\sigma_1, \mu)$ , and  $\tau \prec \tau_1$ . The statement 3) follows from the estimate

$$\begin{aligned} l(q_{\tau,\nu}q_2) &\leq l(p_\tau) + l(p_1) + l(q_2) \\ &\leq l(p_\tau) + l(p_1) + l(q_1q_2) \\ &\leq l(\tau) + C_\star + l([f(\sigma)]). \end{aligned}$$

We use here that the label of  $p_\tau$  is  $\tau$  and the label of  $f_\bullet(p_\sigma)$  is  $[f(\sigma)]$ .  $\square$

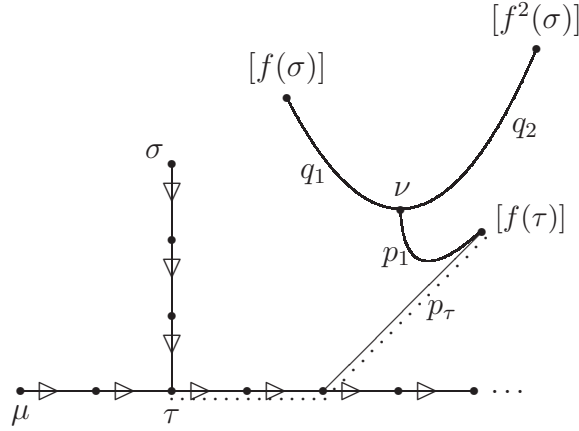

Figure 23.

Proposition 17.8 can be applied only if the assumption  $l(\tau) > C_\star$  is satisfied. In Section 18, we need to control the stronger inequality  $l(\tau) > 3C_\star + 2R_\star + \|f\|$ . Therefore we introduce a function  $B_\mu$  which counts the number of cases where this inequality fails.

**Definition 17.9.** Let  $\mu$  be a vertex in  $D_f$ .

- 1) A  $k$ -branch of the  $\mu$ -cone is called *thin* if it contains a vertex  $\sigma \in D_f$  which is repelling or satisfies  $l(\sigma) \leq 3C_\star + 2R_\star + \|f\|$ .
- 2) For each  $n \in \mathbb{N}$ , let  $B_\mu(n)$  be the number of thin  $k$ -branches in the  $\mu$ -cone, where  $1 \leq k < n$ .

**Definition 17.10.** Let  $\mathcal{B}$  be the total number of repelling vertices in  $D_f$  and of  $f$ -paths in  $\Gamma$  of  $l$ -length at most  $3C_\star + 2R_\star + \|f\|$ .

**Remark 17.11.** The function  $B_\mu$  is nondecreasing and the constant  $\mathcal{B}$  is computable by Proposition 7.2. If the  $\mu$ -subgraph is a ray,  $B_\mu$  is bounded from above

by the constant  $\mathcal{B}$ . Therefore if there exists  $n \in \mathbb{N}$  with  $B_\mu(n) > \mathcal{B}$ , then the  $\mu$ -subgraph is finite.

**Corollary 17.12.** *Let  $\mu$  be a vertex of  $D_f$  and let  $\sigma \in \mathbf{Cone}(\mu)$ . Suppose that we know the numbers  $k, \ell$  such that  $\sigma$  is  $(k, \ell)$ -close to  $\mu$ . Then at least one of the following holds:*

- i) *There exists a computable number  $k_1 > k$  such that  $B_\mu(k_1) > B_\mu(k)$ .*
- ii) *There exist computable numbers  $k', \ell'$  such that  $k' \geq k$  and at least one of the vertices  $[f(\sigma)], [f^2(\sigma)]$  is  $(k', \ell')$ -close to  $\mu$ .*

Moreover, we can efficiently determine which of these cases occurs.

*Proof.* Let  $\tau := \widehat{f}^k(\mu)$ . If  $l(\tau) \leq C_*$ , then we have i) for  $k_1 = k + 1$ . If  $l(\tau) > C_*$ , then there exist  $\sigma_1 \in \mathbf{Cone}(\mu)$  and  $\tau_1 \in \mathbf{Entr}(\sigma_1, \mu)$  satisfying the claims 1)-3) of Proposition 17.8. By 1), we have  $\sigma_1 \in \{[f(\sigma)], [f^2(\sigma)]\} \cup \mathbf{Rep}(D_f)$ . By 2) and 3), we can compute  $k' \geq k$  and  $\ell'$  such that  $\sigma_1$  is  $(k', \ell')$ -close to  $\mu$ . If  $\sigma_1 \in \{[f(\sigma)], [f^2(\sigma)]\}$ , we have ii). If  $\sigma_1 \in \mathbf{Rep}(D_f)$ , then the  $k'$ -branch of the  $\mu$ -cone is thin and we have i) with  $k_1 := k' + 1$ .  $\square$

### 18. $r$ -PERFECT AND $A$ -PERFECT VERTICES IN $\mu$ -SUBGRAPHS

Until the end of this section we will assume that  $H_r$  is a fixed exponential stratum. For any vertex  $\mu$  in  $D_f$ , we define the  $r$ -cone over  $\mu$  as follows:

$$\mathbf{Cone}_r(\mu) := \{\sigma \in \mathbf{Cone}(\mu) \mid \text{the } f\text{-path } \sigma \text{ lies in } G_r\}.$$

Observe that if  $\sigma \in \mathbf{Cone}_r(\mu)$  and  $\sigma$  is not dead, then  $\widehat{f}(\sigma) \in \mathbf{Cone}_r(\mu)$ .

**Definition 18.1.** Let  $\mu$  be a vertex in  $D_f$ . With each pair  $(\sigma, k) \in \mathbf{Cone}_r(\mu) \times \mathbb{N}$ , where  $\sigma$  is  $(k, \ell)$ -close to  $\mu$  for some  $\ell \geq 0$ , we associate the *complexity* of  $(\sigma, k)$  with respect to  $\mu$ :

$$\mathit{Compl}_\mu((\sigma, k)) = (\mathcal{B} - B_\mu(k), N_r(\sigma)).$$

Here  $N_r(\sigma)$  is the number from Definition 10.3.

We use the symbol  $\preceq_{lex}$  for the usual lexicographical order on  $\mathbb{Z} \times \mathbb{Z}$ .

**Remark 18.2.** 1) The first component of the complexity is bounded from above by the computable constant  $\mathcal{B}$ . By Remark 17.11, this component is nonnegative if the  $\mu$ -subgraph is a ray. It can be negative if the  $\mu$ -subgraph is finite. We don't claim that this component is computable.

2) The second component is computable by Theorem 10.4. It is nonnegative and can be roughly bounded from above by a function depending only on  $k, \ell$ , and  $l(\mu)$ :

$$N_r(\sigma) \leq l(\sigma) \leq l(\mu) + (k + \ell)(\|f\| + 1).$$

Indeed, the first inequality is obvious. The second follows from  $\widehat{f}^k(\mu) = \widehat{f}^\ell(\sigma)$  by induction with the help of the inequality  $|l(\widehat{f}(\tau)) - l(\tau)| \leq \|f\| + 1$  which holds for each non-dead vertex  $\tau \in D_f$ .

3)  $N_r(\sigma) = N_r([f^i(\sigma)])$  for all  $i \geq 1$ . This follows directly from the definition of  $N_r$ .

**Lemma 18.3.** *Let  $\mu$  be a vertex in  $D_f$  such that the  $f$ -path  $\mu$  lies in  $G_r$ , and let  $\sigma \in \mathbf{Cone}_r(\mu)$ . Suppose that we know the numbers  $k, \ell$  such that  $\sigma$  is  $(k, \ell)$ -close to  $\mu$ . Then at least one of the following holds:*

- (1) *the  $\mu$ -subgraph is finite;*
- (2) *there exists an  $r$ -superstable  $\sigma' \in \mathbf{Cone}_r(\mu)$  such that  $\sigma'$  is  $(k', \ell')$ -close to  $\mu$  for some  $k' \geq k$  and  $\ell' \geq 0$ , and*

$$\text{Compl}_\mu((\sigma', k')) \preceq_{\text{lex}} \text{Compl}_\mu((\sigma, k)).$$

Moreover, there is an efficient algorithm deciding which of these cases occurs; in Case (1) it computes the vertices of the  $\mu$ -subgraph, and in Case (2) it computes  $\sigma', k', \ell'$ .

*Proof.* We apply Corollary 17.12. In Case i), we can compute  $k_1 > k$  with  $B_\mu(k_1) > B_\mu(k)$ . We may assume that  $\widehat{f}^{k_1}(\mu)$  exists, otherwise we have (1). Set  $\sigma_1 := \widehat{f}^{k_1}(\mu)$ . Clearly,  $\sigma_1$  is  $(k_1, 0)$ -close to  $\mu$ , hence  $\sigma_1 \in \mathbf{Cone}_r(\mu)$ . Moreover,

$$\text{Compl}_\mu((\sigma_1, k_1)) \prec_{\text{lex}} \text{Compl}_\mu((\sigma, k)).$$

If  $\sigma_1$  is  $r$ -superstable, we are done. If not, we restart with  $\sigma := \sigma_1$  and  $(k, \ell) := (k_1, 0)$ . By Remark 17.11, if we restart more than  $\mathcal{B}$  times and each time have Case i), then the  $\mu$ -subgraph is finite.

Thus, we may assume that, from the beginning and in the further process, we have Case ii). We start with  $\sigma_0 := \sigma$  and  $(k_0, \ell_0) := (k, \ell)$ , and compute the number  $S$  such that  $[f^S(\sigma)]$  is  $r$ -superstable, see Lemma 13.2. By Case ii), for  $i = 0, \dots, S$ , we compute consequently  $\sigma_{i+1} \in \{[f(\sigma_i)], [f^2(\sigma_i)]\}$  and numbers  $k_{i+1}, \ell_{i+1}$  such that  $k_{i+1} \geq k_i$  and  $\sigma_{i+1}$  is  $(k_{i+1}, \ell_{i+1})$ -close to  $\mu$ . We have  $\sigma_{i+1} \in \mathbf{Cone}_r(\mu)$ . Observe that  $\sigma_S \in \{[f^S(\sigma)], \dots, [f^{2^S}(\sigma)]\}$ . Hence,  $\sigma_S$  is  $r$ -superstable. Moreover,  $N_r(\sigma) = N_r(\sigma_S)$  by definition of  $N_r$ . Since  $k_S \geq k_0 = k$ , we have

$$\text{Compl}_\mu((\sigma_S, k_S)) \preceq_{\text{lex}} \text{Compl}_\mu((\sigma, k)),$$

and we obtain (2) with  $\sigma' := \sigma_S$  and  $(k', \ell') := (k_S, \ell_S)$ .  $\square$

**Proposition 18.4.** *Let  $H_r$  be an exponential stratum. There exists an efficient algorithm which, given a reduced  $f$ -path  $\mu \subset G_r$ , finds a vertex  $\mu'$  in the  $\mu$ -subgraph with one of the following properties:*

- 1) *the  $f$ -path  $\mu'$  lies in  $G_{r-1}$ ;*

- 2)  $\mu'$  is  $r$ -perfect;
- 3)  $\mu'$  is  $A$ -perfect;
- 4) the  $\mu'$ -subgraph is finite.

Moreover, the algorithm indicates which of these cases occurs. In Case 4) it efficiently computes all vertices of the  $\mu$ -subgraph.

*Proof.* We may assume that  $\mu$  is not a dead vertex in  $D_f$ . Moreover, we may assume that all vertices in  $\mathbf{Cone}_r(\mu)$  which we construct in the process below are non-dead. Otherwise we have Case 4).

Suppose that we can find a vertex  $\mu'' \in \mathbf{Cone}_r(\mu)$  which satisfies one of the properties 1)-4) and that we can find numbers  $k'', \ell''$  such that  $\mu''$  is  $(k'', \ell'')$ -close to  $\mu$ . Then we will be able to find the desired  $\mu'$  just by following along the  $\mu''$ -subgraph until the  $\mu$ -subgraph and then along the  $\mu$ -subgraph (see the statements (1) and (2) in Propositions 13.4 and 13.6). We show how to find such  $\mu''$ .

*Step 1.* We go to Step 2 with  $\sigma := \widehat{f}(\mu)$ . Clearly,  $\sigma \in \mathbf{Cone}_r(\mu)$ .

*Step 2.* Let  $\sigma \in \mathbf{Cone}_r(\mu)$  and we know the numbers  $(k, \ell)$  such that  $\sigma$  is  $(k, \ell)$ -close to  $\mu$ . By Lemma 18.3 we can either prove that the  $\mu$ -subgraph is finite, or find an  $r$ -superstable vertex  $\mu_0 \in \mathbf{Cone}_r(\mu)$  and numbers  $k_0 \geq k$  and  $\ell_0$  such that  $\mu_0$  is  $(k_0, \ell_0)$ -close to  $\mu$  and

$$\text{Compl}_\mu((\mu_0, k_0)) \preceq_{lex} \text{Compl}_\mu((\sigma, k)).$$

We may assume that the second possibility occur. If  $N_r(\mu_0) = 0$ , we go to Step 3. If  $N_r(\mu_0) \geq 1$ , we go to Step 4.

*Step 3.* Suppose that  $N_r(\mu_0) = 0$ . Recall that  $\mu_0$  is  $r$ -superstable.

If  $N_r([\mu_0 f(\mu_0)]) = 0$ , we can find the desired  $\mu''$  by Proposition 14.2.

If  $N_r([\mu_0 f(\mu_0)]) = 1$ , we can apply Proposition 15.1 to  $\mu_0$  and find  $\mu_1$  in the  $\mu_0$ -subgraph such that one of the following cases holds:

- (3a)  $l(\mu_1) \leq 3C_* + 2R_* + \|f\|$ ;
- (3b) the path  $\mu_1$  in  $\Gamma$  is  $A$ -perfect.

By Step 2 we know that  $\mu_0$  is  $(k_0, \ell_0)$ -close to  $\mu$ , hence  $\mu_1$  is  $(k_1, \ell_1)$ -close to  $\mu$  for some computable  $k_1 \geq k_0$  and  $\ell_1$ .

In Case (3a) we have  $B_\mu(k_1 + 1) > B_\mu(k_1) \geq B_\mu(k_0)$ . Hence,

$$\text{Compl}_\mu((\sigma, k_1 + 1)) \prec_{lex} \text{Compl}_\mu((\mu_0, k_0))$$

for  $\sigma := \widehat{f}^{k_1+1}(\mu)$ . We go to Step 2 with this  $\sigma$  and  $(k, \ell) := (k_1 + 1, 0)$ .

In Case (3b) we are done for  $\mu'' := \mu_1$ .

*Step 4.* Suppose that  $N_r(\mu_0) \geq 1$ .

By Proposition 16.1, we can find a vertex  $\mu_1$  in the  $\mu_0$ -subgraph such that one of the following holds:

- (4a)  $l(\mu_1) \leq 3C_* + 2R_* + \|f\|$ ;
- (4b)  $N_r(\mu_1) < N_r(\mu_0)$ ;
- (4c) the path  $\mu_1$  in  $\Gamma$  is  $A$ -perfect.

In Case (4c) we are done for  $\mu'' := \mu_1$ . In Case (4a) we proceed as in Case (3a).

Consider Case (4b). By Step 2 we know that  $\mu_0$  is  $(k_0, \ell_0)$ -close to  $\mu$ , hence  $\mu_1$  is  $(k_1, \ell_1)$ -close to  $\mu$  for some computable  $k_1 \geq k_0$  and  $\ell_1$ . Since the function  $B_\mu$  is nondecreasing and  $N_r(\mu_1) < N_r(\mu_0)$ , we have

$$\text{Compl}_\mu((\mu_1, k_1)) \prec_{lex} \text{Compl}_\mu((\mu_0, k_0)),$$

and we go to Step 2 with  $\sigma := \mu_1$  and  $(k, \ell) := (k_1, \ell_1)$ .

Note that the new pair  $(\sigma, k)$  in Steps 3 and 4 has smaller complexity than the old one. If the first component of the complexity falls more than  $\mathcal{B}$  times, then the  $\mu$ -subgraph is finite by Remark 17.11. If the first component remains unchanged, the second component can fall only finitely many times since it is nonnegative. We can compute or estimate the second component by Remark 18.2. Thus, the process stops in a finite (and computable) number of steps.  $\square$

## 19. $E$ -PERFECT VERTICES IN $\mu$ -SUBGRAPHS

Let  $H_r$  be a polynomial stratum. There exists a permutation  $\sigma$  on the set of  $r$ -edges and, for each  $r$ -edge  $E$ , there exists an edge path  $c_E$  (which is trivial or is an edge path in  $G_{r-1}$ ) such that  $f(E) = c_E \cdot \sigma(E) \cdot \bar{c}_{\bar{E}}$ . Then, for each  $i \geq 0$  and for each  $r$ -edge  $E$ , one can compute a path  $c_{i,E}$  (which is trivial or is an edge path in  $G_{r-1}$ ) such that  $f^i(E) \equiv c_{i,E} \cdot \sigma^i(E) \cdot \bar{c}_{i,\bar{E}}$ . For any edge path  $\mu \subset G_r$ , let  $\mathcal{N}(\mu)$  be the number of  $r$ -edges in  $\mu$ . Clearly, if  $\mu$  is a reduced nontrivial  $f$ -path in  $G_r$ , then  $\mathcal{N}(\hat{f}(\mu)) \leq \mathcal{N}(\mu)$ .

**Definition 19.1.** Let  $H_r$  be a polynomial stratum. A vertex  $\mu \in D_f$  is called  $E$ -perfect if  $\mu \equiv E_1 b_1 E_2 \dots E_k b_k$ , where  $k \geq 1$ ,  $E_1, \dots, E_k$  are  $r$ -edges,  $b_1, \dots, b_k$  are paths which lie in  $G_{r-1}$  or trivial, and  $\mathcal{N}(\mu') = \mathcal{N}(\mu)$  for every vertex  $\mu'$  in the  $\mu$ -subgraph.

**Proposition 19.2.** Let  $H_r$  be a polynomial stratum. Let  $\mu \equiv E_1 b_1 \dots E_k b_k$  be a reduced  $f$ -path in  $G_r$ , where  $k \geq 1$ ,  $E_1, \dots, E_k$  are  $r$ -edges, and  $b_1, \dots, b_k$  are paths which lie in  $G_{r-1}$  or trivial. For  $1 \leq j \leq k$  and  $i \geq 1$ , we set

$$\begin{aligned} \mu_{0,j} &\equiv [E_j b_j \dots E_k b_k f(E_1 b_1 \dots E_{j-1} b_{j-1})], \\ \mu_{i,j} &\equiv [\bar{c}_{i,E_j} f^i(\mu_{0,j}) f(c_{i,E_j})]. \end{aligned}$$

The elements of the sequence  $\mu_{0,1}, \dots, \mu_{0,k}, \mu_{1,1}, \dots, \mu_{1,k}, \dots$  will be denoted by  $\mu_1, \mu_2, \dots$ . (Clearly, all these elements are reduced  $f$ -paths in  $G_r$ .) Then the following statements are satisfied.

- (1)  $\mu$  is  $E$ -perfect if and only if  $\mathcal{N}(\widehat{f}(\mu)) = \mathcal{N}(\mu)$ .
- (2) One can efficiently find a vertex in the  $\mu$ -subgraph which is  $E$ -perfect or lies in  $G_{r-1}$  (considered as an  $f$ -path), or is dead.
- (3) If  $\mu$  is  $E$ -perfect, then  $\mu_1, \mu_2, \dots$  are all  $E$ -perfect vertices in the  $\mu$ -subgraph.

*Proof.* (1) If  $k = 1$ , then  $\mu$  is  $E$ -perfect. Suppose that  $k \geq 2$ . Then (1) follows by induction from the next claim.

*Claim.* The condition (a) below implies the condition (b).

- (a)  $\mathcal{N}(\mu) = \mathcal{N}(\widehat{f}(\mu)) = k$ .
- (b)  $\mathcal{N}(\mu') = \mathcal{N}(\widehat{f}(\mu')) = k$ , where  $\mu' := \widehat{f}^{1+l(b_1)}(\mu)$ .

*Proof.* We have  $\widehat{f}(\mu) \equiv [b_1 E_2 b_2 \dots E_k \cdot b_k c_{1,E_1} \cdot \sigma(E_1) \cdot \bar{c}_{1,\bar{E}_1}]$ . If (a) is valid, then  $b_1$  is an initial subpath of  $\widehat{f}(\mu)$  and we have  $\mu' \equiv [E_2 b_2 \dots E_k \cdot b_k c_{1,E_1} \cdot \sigma(E_1) \cdot \bar{c}_{1,\bar{E}_1} f(b_1)]$ , hence  $\mathcal{N}(\mu') = \mathcal{N}(\widehat{f}(\mu)) = k$ . Then

$$\widehat{f}(\mu') = [b_2 E_3 \dots E_k \cdot b_k c_{1,E_1} \cdot \sigma(E_1) \cdot \bar{c}_{1,\bar{E}_1} f(b_1) c_{1,E_2} \cdot \sigma(E_2) \cdot \bar{c}_{1,\bar{E}_2}].$$

Suppose that (b) is not valid, i.e.  $\mathcal{N}(\widehat{f}(\mu')) < k$ . Then  $[\sigma(E_1) \cdot \bar{c}_{1,\bar{E}_1} f(b_1) c_{1,E_2} \cdot \sigma(E_2)]$  is trivial. This is possible only if  $E_2 = \bar{E}_1$  (hence  $b_1$  is a loop) and  $[\bar{c}_{1,\bar{E}_1} f(b_1) c_{1,\bar{E}_1}]$  is trivial. The latter is equivalent that  $b_1$  is trivial. But then  $[E_1 b_1 E_2]$  is trivial and  $\mu$  is not reduced, a contradiction.  $\square$

(2) follows from (1), and (3) can be proved by direct computations.  $\square$

**Proposition 19.3.** *Let  $H_r$  be a polynomial stratum. For every two  $E$ -perfect vertices  $\mu, \tau$  in  $D_f$  one can efficiently decide, whether  $\tau$  lies in the  $\mu$ -subgraph.*

*Proof.* By Proposition 19.2.(3),  $\tau$  lies in the  $\mu$ -subgraph if and only if  $\tau \equiv \mu_{i,j}$  for some  $i \geq 0$  and  $1 \leq j \leq k$ , where  $k = \mathcal{N}(\mu)$ .

Let  $m$  be the number of edges in  $H_r$  including the inverses. Since the filtration for  $f$  is maximal, we have  $\sigma^m = id$ . Then, for each  $r$ -edge  $E$  we have

$$f^m(E) \equiv c_{m,E} \cdot E \cdot \bar{c}_{m,\bar{E}}. \tag{19.1}$$

Since  $f$ , restricted to any edge, is a piecewise-linear map, we can find a subdivision  $E = E' E''$  such that  $f^m(E') \equiv c_{m,E'} E'$  and  $f^m(E'') \equiv E'' \bar{c}_{m,\bar{E}}$ . This implies

$$c_{m,E} = f^m(E') \bar{E}'. \tag{19.2}$$

*Claim.* For any integer  $a, b, s, t \geq 0$  and for each  $r$ -edge  $E$  the following is satisfied:

- 1)  $c_{a+b,E} = f^b(c_{a,E}) c_{b,\sigma^a(E)}$ .
- 2)  $c_{ms,E} = f^{ms}(E') \bar{E}'$ .
- 3)  $c_{ms+t,E} = f^{ms+t}(E') f^t(\bar{E}') c_{t,E}$ .

*Proof.* 1) follows from the definition of  $c_{i,E}$ . From 1) and using  $\sigma^m = id$ , we have

$$c_{ms,E} = f^{m(s-1)}(c_{m,E}) \cdots f^m(c_{m,E})c_{m,E}.$$

This and the equation (19.2) imply 2). 3) follows from 1) and 2).  $\square$

Using Claim 3), we deduce

$$\begin{aligned} \mu_{ms+t,j} &\equiv [\bar{c}_{ms+t,E_j} f^{ms+t}(\mu_{0,j}) f(c_{ms+t,E_j})] \\ &\equiv [\bar{c}_{t,E_j} f^t(E'_j) \cdot f^{ms+t}(\bar{E}'_j \mu_{0,j} f(E'_j)) \cdot f^{t+1}(\bar{E}'_j) f(c_{t,E_j})]. \end{aligned} \quad (19.3)$$

Thus,  $\tau \equiv \mu_{i,j}$  for some  $i \geq 0$  and  $1 \leq j \leq k$  if and only if there exist  $s \geq 0$ ,  $0 \leq t < m$ , and  $1 \leq j \leq k$ , such that

$$[f^t(\bar{E}'_j) c_{t,E_j} \tau f(\bar{c}_{t,E_j}) f^{t+1}(E'_j)] = [f^{ms}(f^t(\bar{E}'_j \mu_{0,j} f(E'_j)))].$$

For fixed  $t, j$ , and using Corollary 6.2 for  $f^m$ , we can efficiently decide whether there exists  $s \geq 0$  satisfying the above equation. Hence, we can efficiently decide whether there exist  $i, j$  with  $\tau \equiv \mu_{i,j}$ .  $\square$

## 20. FINITENESS AND MEMBERSHIP PROBLEMS FOR $\mu$ -SUBGRAPHS

We continue to work with the PL-relative train track  $f : \Gamma \rightarrow \Gamma$  satisfying (RTT-iv). For such  $f$  we prove Propositions 20.2 and 20.5 which solve the Finiteness and the Membership problems from Section 7. This will complete the proof of the main Theorem 1.1.

**Lemma 20.1.** *Let  $H_r$  be an exponential stratum in  $\Gamma$  with the Perron-Frobenius eigenvalue  $\lambda_r$  and let  $\mu \subset G_r$  be an  $r$ -perfect path. Let  $\mu = \mu_0, \mu_1, \dots$  be consecutive vertices of the  $\mu$ -subgraph in  $D_f$ . Then, for all  $i \geq 0$ , we have*

$$L_r(\mu_{i+1}) \geq L_r(\mu_i) > 0$$

and

$$L_r(\mu_{m_i}) = \lambda_r^i L_r(\mu),$$

where  $0 = m_0 < m_1 < m_2 < \dots$  are computable numbers from Proposition 13.4. In particular, the  $\mu$ -subgraph is infinite.

*Proof.* By Proposition 13.4. (3),  $\mu_i$  contains edges from  $H_r$  for each  $i \geq 0$ . Hence  $L_r(\mu_i) > 0$ . The other formulas follow from the statements (3) and (2) of Proposition 13.4. These formulas and  $\lambda_r > 1$  imply that the  $\mu$ -subgraph is infinite.  $\square$

**Proposition 20.2.** *Given a vertex  $\mu$  in  $D_f$ , one can efficiently decide, whether the  $\mu$ -subgraph is finite or not. Moreover, one can efficiently compute the vertices of the  $\mu$ -subgraph if it is finite.*



*Proof.* Let  $r$  be the minimal number such that the  $f$ -path  $\mu$  lies in  $G_r$ .

First suppose that  $H_r$  is an exponential stratum. By Proposition 18.4, we can efficiently find a vertex  $\mu'$  in the  $\mu$ -subgraph with one of the following properties:

- 1) the  $f$ -path  $\mu'$  lies in  $G_{r-1}$ ;
- 2)  $\mu'$  is  $r$ -perfect;
- 3)  $\mu'$  is  $A$ -perfect;
- 4) the  $\mu'$ -subgraph is finite.

Moreover, the algorithm indicates which of these cases occurs, and in Case 4) it efficiently computes the vertices of the  $\mu$ -subgraph. Note that in Cases 1)-3) the  $\mu'$ -subgraph, and hence the  $\mu$ -subgraph, can be finite or infinite. So, we analyze these cases.

In Case 1) we apply induction. In Case 2) the  $\mu'$ -subgraph (and hence the  $\mu$ -subgraph) is infinite by Lemma 20.1.

Consider Case 3). By Proposition 13.6. (2), there exist natural numbers  $m_{1,1} < m_{2,1} < m_{3,1} < \dots$  such that  $\widehat{f}^{m_{i,1}}(\mu') \equiv [f^i(\mu')]$ ,  $i > 0$ . Hence, the  $\mu'$ -subgraph is finite if and only if there exist  $0 < i < j$  such that  $[f^i(\mu')] = [f^j(\mu')]$ . This problem is efficiently decidable by Corollary 6.3. In Case 4) we are done.

Now suppose that  $H_r$  is a polynomial stratum. By Proposition 19.2. (2), we can efficiently find a vertex  $\mu'$  in the  $\mu$ -subgraph with one of the following properties:

- 1) the  $f$ -path  $\mu'$  lies in  $G_{r-1}$  or is trivial;
- 2)  $\mu'$  is  $E$ -perfect.

In Case 1) we apply induction. Consider Case 2). Let  $m$  be the number of edges in  $H_r$  including the inverses. Let  $\mu' \equiv E_1 b_1 \dots E_k b_k$ , where  $k \geq 1$ ,  $E_1, \dots, E_k$  are  $r$ -edges, and  $b_1, \dots, b_k$  are paths which lie in  $G_{r-1}$  or trivial. By Proposition 19.2. (3), the  $\mu'$ -subgraph contains the vertices  $\mu'_{ms,1}$ ,  $s \geq 0$ . Hence, the  $\mu'$ -subgraph is finite if and only if there exist  $0 \leq s_1 < s_2$  such that  $\mu'_{ms_1,1} \equiv \mu'_{ms_2,1}$ . (Recall that  $\mu'_{0,1} \equiv \mu'$ .) By the formula (19.3), this is equivalent to

$$[f^{ms_1}(\overline{E'_1} \mu' f(E'_1))] = [f^{ms_2}(\overline{E'_1} \mu' f(E'_1))].$$

The problem of existence of such  $s_1, s_2$  is efficiently decidable by Corollary 6.3.

If  $H_r$  is a zero stratum, then following along the  $\mu$ -subgraph at most  $l(\mu)$  steps, we can find a vertex  $\mu'$  in the  $\mu$ -subgraph such that the  $f$ -path  $\mu'$  lies in  $G_{r-1}$  or is trivial. Then we apply induction.

It follows from the above proof that if the  $\mu$ -subgraph is finite, then we can efficiently compute its vertices.  $\square$

**Proposition 20.3.** *For every two vertices  $\mu, \tau$  in  $D_f$ , where  $\mu$  is  $r$ -perfect, one can efficiently decide whether  $\tau$  lies in the  $\mu$ -subgraph.*

*Proof.* We may assume that the  $f$ -path  $\tau$  lies in  $G_r$  (otherwise  $\tau$  does not lie in the  $\mu$ -subgraph). Let  $\mu = \mu_0, \mu_1, \dots$ , be consecutive vertices of the  $\mu$ -subgraph. Using Lemma 20.1, we can compute the minimal  $i$  such that  $L_r(\mu_i) > L_r(\tau)$ . Then  $\tau$  lies in the  $\mu$ -subgraph if and only if  $\tau$  coincides with one of the vertices  $\mu_0, \mu_1, \dots, \mu_{i-1}$ .  $\square$

**Proposition 20.4.** *For every two vertices  $\mu, \tau$  in  $D_f$ , where  $\mu$  is  $A$ -perfect, one can efficiently decide whether  $\tau$  lies in the  $\mu$ -subgraph.*

*Proof.* Due to Proposition 20.2, we may assume that the  $\mu$ -subgraph is infinite. Let  $\mu \equiv A_1 b_1 \dots A_k b_k$  be the  $A$ -decomposition of  $\mu$ . We use the following notation from Proposition 13.6:

$$\begin{aligned} \mu_{0,j} &\equiv [A_j b_j \dots A_k b_k f(A_1 b_1 \dots A_{j-1} b_{j-1})], \\ \mu_{i,j} &\equiv [f^i(\mu_{0,j})], \end{aligned} \tag{20.1}$$

where  $1 \leq j \leq k$  and  $i \geq 1$ . By Proposition 13.6. (4), for every vertex  $\sigma$  in the  $\mu$ -subgraph, at least one of the paths  $\sigma, \widehat{f}(\sigma), \dots, \widehat{f}^{l(\sigma)}(\sigma)$  coincides with  $\mu_{i,j}$  for some  $i, j$ .

Thus, we first decide, whether one of the paths  $\tau, \widehat{f}(\tau), \dots, \widehat{f}^{l(\tau)}(\tau)$  coincides with  $\mu_{i,j}$  for some  $i, j$ . In view of (20.1), this can be done with the help of Corollary 6.2. If the answer is negative, then  $\tau$  does not lie in the  $\mu$ -subgraph. If it is positive, then we can find  $t, i, j$  such that  $\widehat{f}^t(\tau) \equiv \mu_{i,j}$ . Recall that by Proposition 13.6. (2),  $\mu_{i,j} \equiv \widehat{f}^{m_{i,j}}(\mu)$  for computable  $m_{i,j}$ . Then  $\tau$  lies in the  $\mu$ -subgraph if and only if  $m_{i,j} \geq t$  and  $\tau \equiv \widehat{f}^{m_{i,j}-t}(\mu)$ .  $\square$

**Proposition 20.5.** *Given two vertices  $\mu, \tau$  in  $D_f$ , one can efficiently decide whether  $\tau$  lies in the  $\mu$ -subgraph.*

*Proof.* By Proposition 20.2, we can efficiently decide whether the  $\mu$ -subgraph and the  $\tau$ -subgraph are finite or not. If the  $\mu$ -subgraph is finite, we can compute all its vertices and verify, whether  $\tau$  is one of them. Suppose that the  $\mu$ -subgraph is infinite. Then, if the  $\tau$ -subgraph is finite, the vertex  $\tau$  cannot lie in the  $\mu$ -subgraph. So, we may assume that the  $\tau$ -subgraph is also infinite. Let  $r$  be the minimal number such that the  $f$ -path  $\mu$  lies in  $G_r$ . We will use induction on  $r$ .

First suppose that  $H_r$  is an exponential stratum. Then, by Proposition 18.4, we can efficiently find a vertex  $\mu'$  in the  $\mu$ -subgraph with one of the following properties:

- 1) the  $f$ -path  $\mu'$  lies in  $G_{r-1}$ ;
- 2)  $\mu'$  is  $r$ -perfect;
- 3)  $\mu'$  is  $A$ -perfect.

First we check, whether  $\tau$  belongs to the segment of the  $\mu$ -subgraph from  $\mu$  to  $\mu'$ . If yes, we are done. If not, we replace  $\mu$  by  $\mu'$  and consider the above cases. In

Case 1) we proceed by induction, in Case 2) by Proposition 20.3, and in Case 3) by Proposition 20.4.

Now suppose that  $H_r$  is a polynomial stratum. Then, by Proposition 19.2. (2), we can efficiently find a vertex  $\mu'$  in the  $\mu$ -subgraph with one of the following properties:

- 1) the  $f$ -path  $\mu'$  lies in  $G_{r-1}$  or is trivial;
- 2)  $\mu'$  is  $E$ -perfect.

In Case 1) we proceed by induction. Suppose we have Case 2). We may assume that the  $f$ -path  $\tau$  lies in  $G_r$ , otherwise  $\tau$  does not lie in the  $\mu$ -subgraph. By Proposition 19.2, there exists  $k \leq l(\tau)$  such that either  $\widehat{f}^k(\tau)$  lies in  $G_{r-1}$  or is dead, or  $\widehat{f}^k(\tau)$  is  $E$ -perfect. If  $\widehat{f}^k(\tau)$  lies in  $G_{r-1}$  or is dead, then  $\tau$  does not lie in the  $\mu$ -subgraph. Suppose that  $\widehat{f}^k(\tau)$  is  $E$ -perfect. By Proposition 19.3, we can decide, whether  $\widehat{f}^k(\tau)$  lies in the  $\mu'$ -subgraph, and hence in the  $\mu$ -subgraph (these subgraphs differ by a finite segment). If  $\widehat{f}^k(\tau)$  does not lie in the  $\mu$ -subgraph, then  $\tau$  does not lie in the  $\mu$ -subgraph. If  $\widehat{f}^k(\tau)$  lies in the  $\mu$ -subgraph, say  $\widehat{f}^k(\tau) = \widehat{f}^t(\mu)$ , then  $\tau$  lies in the  $\mu$ -subgraph if and only if  $t \geq k$  and  $\tau = \widehat{f}^{t-k}(\mu)$ .

Finally, if  $H_r$  is a zero stratum, we follow along the  $\mu$ -subgraph at most  $l(\mu)$  steps until we arrive at a vertex  $\mu' \in D_f$  which, considered as an  $f$ -path, lies in  $G_{r-1}$ . Then we apply induction.  $\square$

## REFERENCES

- [1] G. Baumslag, A. G. Myasnikov, V. Shpilrain, *Open problems in combinatorial group theory*. Second edition, (Contemp. Math., **296**), Providence, RI, Am. Math. Soc., 2002.
- [2] G. M. Bergman, *Supports of derivations, free factorizations, and ranks of fixed subgroups in free groups*, Trans. Am. Math. Soc. **351**, N 4 (1999), 1531-1550.
- [3] M. Bestvina,  *$\mathbb{R}$ -trees in topology, geometry, and group theory*, Handbook of geometric topology, 5591, North-Holland, Amsterdam, 2002.
- [4] M. Bestvina, M. Feighn, M. Handel, *The Tits alternative for  $\text{Out}(F_n)$  I: Dynamics of exponentially-growing automorphisms*, Ann. Math., **151**, N 2 (2000), 517-623.
- [5] M. Bestvina, M. Feighn, M. Handel, *The Tits alternative for  $\text{Out}(F_n)$  II: A Kolchin type theorem*, Ann. Math., **161**, N 1 (2005) Pages 1-59.
- [6] M. Bestvina, M. Feighn, M. Handel, *Solvable subgroups of  $\text{Out}(F_n)$  are virtually abelian*, Geometriae Dedicata, **104**, N 1 (2004), 71-96.
- [7] M. Bestvina, M. Handel, *Train tracks and automorphisms of free groups*, Ann. Math. (2), **135**, N 1 (1992), 1-53.
- [8] O. Bogopolski, *Introduction to group theory*, EMS publishing house, 2008 (see Section 3 there).
- [9] O. Bogopolski, *Classification of automorphisms of the free group of rank 2 by ranks of fixed-point subgroups*, J. Group Theory, **3**, N 3 (2000), 339-351.
- [10] O. Bogopolski, A. Martino, O. Maslakova, E. Ventura, *Free-by-cyclic groups have solvable conjugacy problem*, Bulletin of the London Math. Soc., **38**, part 5 (2006), 787-794.
- [11] M.R. Bridson, D. Groves, *The quadratic isoperimetric inequality for mapping tori of free group automorphisms*, Mem. Am. Math. Soc. 955, xii, 152 pp. (2010).

- [12] P. Brinkmann, *Hyperbolic automorphisms of free groups*, Geom. Funct. Anal. **10**, N 5 (2000), 1071–1089.
- [13] P. Brinkmann, *Detecting automorphic orbits in free groups*, Journal of Algebra, **324** (2010), 1083–1097.
- [14] D.J. Collins, E.C. Turner, *All automorphisms of free groups with maximal rank fixed subgroups*, Math. Proc. Camb. Philos. Soc. **119**, N 4 (1996), 615–630.
- [15] M. M. Cohen, M. Lustig, *On the dynamics and the fixed subgroup of a free group automorphism*, Invent. Math., **96**, N 3 (1989), 613–638.
- [16] D. Cooper, *Automorphisms of free groups have finitely generated fixed point sets*, J. Algebra, **111**, N 2 (1987), 453–456.
- [17] W. Dicks, E. Ventura, *The group fixed by a family of injective endomorphisms of a free group* (Contemp. Math., **195**), Providence, RI, Am. Math. Soc., 1996.
- [18] J. L. Dyer, G. P. Scott, *Periodic automorphisms of free groups*, Commun. Algebra, **3**, N 3 (1975), 195–201.
- [19] D. Gaboriau, A. Jaeger, G. Levitt, M. Lustig, *An index for counting fixed points of automorphisms of free groups*, Duke Math. J., **93**, N 3 (1998), 425–452.
- [20] D. Gaboriau, G. Levitt, *The rank of actions on R-trees*, Ann. Sci. Ecole Norm. Sup. **28** (1995), 549–570.
- [21] D. Gaboriau, G. Levitt, M. Lustig, *A dendrological proof of the Scott conjecture for automorphisms of free groups*, Proc. Edinburgh Math. Soc. (2), **41**, N 2 (1998), 325–332.
- [22] S. M. Gersten, *On fixed points of automorphisms of finitely generated free groups*, Bull. Amer. Math. Soc., New Ser. **8** (1983), 451–454.
- [23] S. M. Gersten, *Fixed points of automorphisms of free groups*, Adv. in Math., **64**, N 1 (1987), 51–85.
- [24] R. Z. Goldstein, E. C. Turner, *Fixed subgroups of homomorphisms of free groups*, Bull. London Math. Soc., **18** (1986), 468–470.
- [25] R. Z. Goldstein, E. C. Turner, *Automorphisms of free groups and their fixed points*, Inv. Math., **78**, N 1 (1984), 1–12.
- [26] W. Imrich, E. C. Turner, *Endomorphisms of free groups and their fixed points*, Math. Proc. Cambridge Philos. Soc., **105** (1989), 421–422.
- [27] O. S. Maslakova, *Fixed point subgroup of an automorphism of a free group*, Algebra and Logic, **42**, N 4 (2003), 422–472 (in Russian).
- [28] O. S. Maslakova, *Fixed point subgroup of an automorphism of a free group*, Ph.D Thesis (2004) (in Russian).
- [29] F. Paulin, *Sur les automorphismes extérieurs des groupes hyperboliques*, Ann. Inst. Fourier **39** (1989), 651–662.
- [30] Z. Sela, *The Nielsen-Thurston classification and automorphisms of a free group I*, Duke Math. J., **84**, N 2 (1996), 379–397.
- [31] J.R. Stallings, *Graphical theory of automorphisms of free groups*, Ann. Math. Stud. **111** (1987), 79–106.
- [32] S. Thomas, *Fixed points of automorphisms of finitely generated free groups*, Proc. Amer. Math. Soc., **103** (1988), 333.
- [33] E. C. Turner, *Finding indivisible Nielsen paths for a train tracks map*, Proc. of a workshop held at Heriot-Watt Univ., Edinburg, 1993 (Lond. Math. Soc. Lect. Note Ser., **204**), Cambridge, Cambridge Univ. Press., 1995, 300–313.
- [34] Open problems in combinatorial and geometric group theory,  
<http://www.grouptheory.info/>