

# Weak subordination breaking for the quenched trap model

S. Burov, E. Barkai

*Department of Physics, Institute of Nanotechnology and Advanced Materials, Bar Ilan University, Ramat-Gan 52900, Israel*

We map the problem of diffusion in the quenched trap model onto a new stochastic process: Brownian motion which is terminated at the coverage “time”  $\mathcal{S}_\alpha = \sum_{x=-\infty}^{\infty} (n_x)^\alpha$  with  $n_x$  being the number of visits to site  $x$ . Here  $0 < \alpha = T/T_g < 1$  is a measure of the disorder in the original model. This mapping allows us to treat the intricate correlations in the underlying random walk in the random environment. The operational “time”  $\mathcal{S}_\alpha$  is changed to laboratory time  $t$  with a Lévy time transformation. Investigation of Brownian motion stopped at “time”  $\mathcal{S}_\alpha$  yields the diffusion front of the quenched trap model which is favorably compared with numerical simulations. In the zero temperature limit of  $\alpha \rightarrow 0$  we recover the renormalization group solution obtained by C. Monthus. Our theory surmounts critical slowing down which is found when  $\alpha \rightarrow 1$ . Above the critical dimension two mapping the problem to a continuous time random walk becomes feasible though still not trivial.

PACS numbers: 05.40.Jc, 02.50.-r, 05.20.-y, 46.65.+g

## I. INTRODUCTION

Random walks in disordered systems with a diverging expected waiting time have attracted vast interest over many decades. Two approaches in this field are the annealed continuous time random walk (CTRW) model and the quenched trap model (QTM). Starting in the 70’s, the Scher-Montroll CTRW approach was used to model sub-diffusive photo-currents in amorphous materials [1–4] and for contaminants transport in hydrology [5]. Bouchaud showed that the trap model is a useful tool for the description of aging phenomena in glasses [6–8]. Then fractional kinetic equations which describe CTRW dynamics became a popular tool [9]. More recently these models were used to describe non self averaging [10, 11] and weak ergodicity breaking [6, 12] which is important for the statistical description of dynamics of single quantum dots [13] and single molecules in living cells [14, 15].

This manuscript presents a new approach for random walks in a quenched random environment i.e. site disorder at each lattice point is fixed in time. In its generality this topic has attracted tremendous interest in Physics [9, 16–22] and Mathematics [23–25]. For the QTM the critical dimension is two [17, 26–29]. Above two dimensions the Scher-Montroll continuous time random walk (CTRW), which is a mean field theory, qualitatively describes the sub-diffusive process. According to Polya’s theorem [30, 31] on a simple lattice and in dimension three, a random walk is non recurrent. Hence in a disordered system the particle (roughly speaking) tends to visit new lattice points along its path. In contrast in one dimension the random walk is recurrent, and a particle visits the same lattice point many times. Thus above the critical dimension the CTRW approach works well, but fails in one dimension, due to correlations of the random walk with the disorder. In other words renewal theory used within the annealed CTRW framework is not a valid description of the QTM [17]. Beyond mean field renormalization group methods are used to tackle

the problem of random walks in quenched environments [20, 26, 32, 33]. For example Machta [26] found the scaling exponents of the QTM and Monthus [32] investigated its diffusion front in the limit of zero temperature (see details below). While the renormalization group method is powerful, it has its limitations: a simple approach which can predict the diffusion front of random walkers in the QTM is still missing.

We provide a new approach for random walks in the QTM which we call weak subordination breaking. For CTRW it is well known that one may decompose the process into ordinary Brownian motion and a Lévy time process, an approach called subordination [34–38]. In this scheme normal Brownian motion takes place in an operational time  $s$ . The disorder is effectively described by a Lévy time transformation from operational time  $s$  to laboratory time  $t$  (see details below). This method is not intended for random walks in fixed random environments since it is based on the renewal assumption. The latter implies the neglect of correlations in the sense that waiting times are not specific to a lattice site. So a new approach capable of dealing with quenched disorder is now investigated. A brief summary of our results was published in [39].

This manuscript is organized as follows. After presenting the QTM in Sec. (II) we briefly review the standard subordination scheme in Sec. (III). The concept of random time in the QTM is presented in IV which leads to weak sub-ordination breaking in Sec V. General properties of the diffusion front  $\langle P(x, t) \rangle$  are found in Sec. VI while Sec. VII and VIII deal with the limits strong and weak disorder respectively. Sec. IX discusses critical slowing down. All along the work we compare theory with numerical simulations.

## II. QUENCHED TRAP MODEL [17, 29, 40, 41]

We consider a random walk on a one dimensional lattice with lattice spacing equal one. For each lattice site

$x$  there is a quenched random variable  $\tau_x$  which is the waiting time between jump events for a particle situated on  $x$ . After time  $\tau_x$  has elapsed the particle jumps to one of its two nearest neighbors with equal probability. The particle starts on the origin  $x = 0$  at time  $t = 0$ , waits for time  $\tau_0$ , then jumps (with probability 1/2) to  $x = 1$ , waits there for  $\tau_1$  etc. Note that if the particle returns to  $x = 0$  it will wait there again for a time interval  $\tau_0$ . The  $\{\tau_x\}$ s are positive independent identically distributed random variables with a common PDF  $\psi(\tau_x)$ . The goal of this paper is to find the long time behavior of  $\langle P(x, t) \rangle$ , the probability of finding the particle on  $x$  at time  $t$  averaged over the disorder.

In the literature two related models are usually considered. The first model, which we use in simulations presented below, assumes that for a given lattice site  $x$  a particle will wait for a fixed waiting time  $\tau_x$ . A slightly more physical approach is to assume that waiting times on lattice point  $x$  are exponentially distributed with a mean  $\tau_x$ . Bertin and Bouchaud [40], showed that the two approaches yield the same asymptotic results in the limit of long measurement times.

In this manuscript our main interest is with power law waiting times

$$\psi(\tau_x) \sim \frac{A}{|\Gamma(-\alpha)|} (\tau_x)^{-(1+\alpha)} \quad (1)$$

for  $\tau \rightarrow \infty$  and  $0 < \alpha < 1$ . The mean waiting time  $\langle \tau_x \rangle = \infty$  and in this sense the diffusion is scale free. According to Tauberian theorem [30] the Laplace transform of the waiting time PDF is

$$\hat{\psi}(u) \sim 1 - Au^\alpha + \dots \quad (2)$$

when  $u \rightarrow 0$ . In the QTM the physical mechanism leading to these power laws is based on trapping dynamics [17]. On a lattice points  $x$  we randomly assign traps. The energy depth of the trap on  $x$  is  $E_x$  and the process of activation from a trap is thermal. According to Arrhenius law  $\tau_x \propto \exp(E_x/T)$  where  $T$  is the temperature. Then assume that the PDF of  $E_x > 0$  is exponential  $f(E_x) = \exp(-E_x/T_g)/T_g$  where  $T_g$  is a measure of the energy disorder. One easily finds

$$\alpha = \frac{T}{T_g} \quad \text{and} \quad A = |\Gamma(-\alpha)|\alpha. \quad (3)$$

Due to the Boltzmann factor  $\tau_x \propto \exp(E/T)$  small changes in energy lead to exponential changes in waiting times, thus it is enough to have an exponential distribution of energy traps to obtain power law waiting times. Experimental observation of the linear dependence of  $\alpha$  on temperature, in photocurrent spectroscopy in a -As<sub>2</sub>Se<sub>3</sub> can be found in Fig. 3 in [42]. We note that the stochastic dynamics under investigation describes several other mechanisms of anomalous diffusion beyond the QTM [10]. For example random walks on comb structures with power law distributed lengths of the comb's

teeth which mimics a random walk on the percolation cluster. Thus the trap model describes both energetic disorder and spatial disorder.

In what follows we will also consider the limit  $\alpha \rightarrow 1$ . This limit is meant in the sense that  $\hat{\psi}(u) \sim 1 - Au\dots$  which means that the average waiting time is finite (Gaussian diffusion front). The very special border case  $\psi(\tau_x) \propto \tau^{-2}$  was treated by Bertin and Bouchaud [40]. It yields Gaussian diffusion with logarithmic corrections and is not treated here.

### III. SUBORDINATION IN THE ANNEALED TRAP MODEL (=CTRW)

We now briefly review the annealed version of the model: the well investigated Scher-Montroll-Weiss continuous time random walk (CTRW) [9, 17, 30] in particular we discuss the concept of time subordination [34–38]. Later we contrast the CTRW approach with the intricate problem of the quenched type. The CTRW model considered here is for a one dimensional random walk on a lattice with lattice spacing equal unity. Starting on the origin  $x = 0$  at time  $t = 0$  the particle waits for a time  $t_1$  it then jumps to one of its nearest neighbors (lattice points  $x = +1$  or  $x = -1$ ) with equal probability. The process is then renewed, namely the particle waits on lattice point  $+1$  (for example) for time  $t_2$  until it jumps back to 0 or  $+2$  etc. The waiting times  $\{t_1, t_2, \dots, t_n, \dots\}$  are independent, identically distributed random variables with a common PDF  $\phi_\alpha(t)$ . Here  $t_n$  is the  $n$ th waiting time, which is not correlated with a specific lattice point  $x$  and hence clearly the CTRW model is very different from the quenched case. Similar to the quenched case we consider waiting time PDFs with a diverging averaged waiting times  $\int_0^\infty t\phi_\alpha(t)dt = \infty$  namely

$$\phi_\alpha(t) \sim \frac{A_\alpha}{|\Gamma(-\alpha)|} t^{-(1+\alpha)}, \quad (4)$$

with  $0 < \alpha < 1$  and  $A_\alpha > 0$ . The corresponding Laplace transform of the waiting time PDF behaves like

$$\hat{\phi}_\alpha(u) \sim 1 - A_\alpha u^\alpha + \dots \quad (5)$$

when  $u$  is small. As well known the diffusion is anomalous  $\langle x^2 \rangle \propto t^\alpha$  [9, 17].

Let  $P(x, t)$  be the probability of finding the particle on  $x$  at time  $t$ . By conditioning on the number of jumps  $s$  performed till time  $t$

$$P(x, t) = \sum_{s=0}^{\infty} n_t(s)q(x, s) \quad (6)$$

where  $n_t(s)$  is the probability of performing  $s$  jumps in time interval  $(0, t)$  and  $q(x, s)$  is the probability that after  $s$  steps the particle is located on  $x$ . In the limit of large  $t$  the number of jumps  $s$  is also large. Following [17] we

apply the Gaussian central limit theorem

$$q(x, s) \sim \frac{1}{\sqrt{2\pi s}} e^{-\frac{x^2}{2s}} \quad (7)$$

which is valid when  $s \rightarrow \infty$ . Here we used the model assumption that the variance of the jump lengths is unity i.e. the lattice spacing is equal 1.

To find  $n_t(s)$  we consider the random time

$$t = \sum_{i=1}^s t_i. \quad (8)$$

In the limit of large  $s$  the time is a sum of many independent identically distributed random variables with a diverging mean waiting time (since  $0 < \alpha < 1$ ). Hence Lévy's limit theorem applies. Let

$$\eta = \frac{t}{s^{1/\alpha}} \quad (9)$$

then in the  $s \rightarrow \infty$  limit

$$\langle e^{-u\eta} \rangle = \hat{\phi}_\alpha^s \left( \frac{u}{s^{1/\alpha}} \right) = \left( 1 - \frac{A_\alpha u^\alpha}{s} + \dots \right)^s \rightarrow e^{-A_\alpha u^\alpha}. \quad (10)$$

Namely the PDF of  $\eta > 0$  is a one sided Lévy function denoted with  $l_{\alpha, A_\alpha, 1}(\eta)$  which is defined via its Laplace pair

$$\int_0^\infty e^{-u\eta} l_{\alpha, A_\alpha, 1}(\eta) d\eta = e^{-A_\alpha u^\alpha}. \quad (11)$$

These Lévy PDFs are well investigated: their series expansion, asymptotic behaviors, and graphical presentations can be found in [43–45]. Information on these PDFs essential for our work are summarized in Appendix A. From the PDF of  $\eta$  we find the PDF of  $s$ . Since both  $s$  and  $t$  are increasing along the process the transformation is straight forward. Using Eq. (10) and  $\eta^{-\alpha} = s/t^\alpha$  we find the well known PDF of  $s$  [17]

$$n_t(s) \sim \frac{t}{\alpha} s^{-\frac{1}{\alpha}-1} l_{\alpha, A_\alpha, 1} \left( \frac{t}{s^{1/\alpha}} \right). \quad (12)$$

In the long time limit the Green function of the CTRW process is thus given by [17, 34]

$$P(x, t) \sim \int_0^\infty n_t(s) \frac{e^{-\frac{x^2}{2s}}}{\sqrt{2\pi s}} ds \quad (13)$$

where we switched from a summation in Eq. (6) to integration.

The time transformation Eq. (13) maps normal Gaussian diffusion to anomalous diffusion. In [35]  $P(x, t)$  was obtained in  $d$  dimension by solving the integral transformation which applies more generally to solutions of the fractional time Fokker-Planck equation [46]. More importantly, we may think of  $s$  as an operational time in which usual Brownian motion is performed. The operational time  $s$  is a random variable whose statistics is

determined by the PDF  $n_t(s)$  where  $t$  is a laboratory time. In other words the annealed disorder turns the operational time to a random variable. We note that subordination scheme can be formulated for the trajectories of the corresponding paths, in a continuum limit of the walk and was the topic of extensive research [47–54].

Not surprisingly subordination of this type does not work for the QTM in one dimension. As mentioned in the introduction the process of a random walk in a QTM is clearly not a simple renewal process. The particle returning to a lattice point visited already, “remembers” its waiting time there. Mathematicians have rigorously shown that in dimensions higher than one [28] or in the presence of a bias [55] (see also [56–58]) the CTRW approach describes well the quenched dynamics since the particle does not tend to revisit the same lattice points many times, thus confirming physical insight in [16, 17, 26] (for dimension  $d = 2$  logarithmic corrections are also important). While the three dimensional QTM belongs to the domain of attraction of the CTRW the calculation of the anomalous diffusion constant is not trivial (see discussion in the summary). Here we focus our attention on the unsolved case: the QTM in one dimension since there the Scher-Montroll CTRW picture [9, 17, 30] breaks down.

#### IV. TIME IN THE QUENCHED TRAP MODEL

The time  $t$  in the QTM is

$$t = \sum_{x=-\infty}^{\infty} n_x \tau_x \quad (14)$$

where  $n_x$  is the number of visits to lattice point  $x$  which we call the visitation number of site  $x$ . Since we are interested in  $\langle P(x, t) \rangle$  where the brackets are for an average over the disorder, we will consider ensembles of paths on a large ensemble of realizations of disorder. As mentioned the  $\{\tau_x\}$ s are independent identically distributed random variables with a common PDF  $\psi(\tau_x)$  and the  $\{n_x\}$ s are also random variables.

Let us consider the random variable

$$\eta = \frac{t}{(\mathcal{S}_\alpha)^{1/\alpha}} \quad (15)$$

where

$$\mathcal{S}_\alpha = \sum_{x=-\infty}^{\infty} (n_x)^\alpha \quad (16)$$

and we call  $\mathcal{S}_\alpha$  the  $\alpha$  coverage time. At this stage it is convenient to consider paths where  $\mathcal{S}_\alpha$  is fixed and  $t$  is random and later we will switch to the opposite situation (similar to the arguments for  $s$  and  $t$  in the CTRW model). When  $\alpha = 1$ ,  $\mathcal{S}_\alpha$  is the total number of jumps made  $\sum_{x=-\infty}^{\infty} n_x = s$ . In the opposite limit  $\alpha \rightarrow 0$ , the

$\alpha$  coverage time  $\mathcal{S}_0$  is the distinct number of sites visited by the random walker which is called the span of the random walk. Notice that  $t$  in Eq. (14) is a sum of non independent and non identical random variables.

We show that the PDF of  $\eta$ , in the limit  $\mathcal{S}_\alpha \rightarrow \infty$  is a one sided Lévy stable function

$$\text{The PDF of } \eta \text{ is: } l_{\alpha,A,1}(\eta). \quad (17)$$

Namely the heavy tailed distribution of the waiting times  $\tau_x$  determines the statistics of  $\eta$  through the characteristic exponent  $\alpha$ , while the visitation numbers  $\{n_x\}$  determine the scaling through  $\mathcal{S}_\alpha$ . By definition the Laplace  $\eta \rightarrow u$  transform of the PDF of  $\eta$  is

$$\langle e^{-\eta u} \rangle = \left\langle \exp \left[ - \sum_{i=-\infty}^{\infty} \frac{n_i \tau_i}{(\mathcal{S}_\alpha)^{1/\alpha}} u \right] \right\rangle. \quad (18)$$

We average with respect to the disorder, namely with respect to the independent and identically distributed random waiting times  $\tau_x$ , and obtain

$$\langle e^{-\eta u} \rangle = \Pi_{x=-\infty}^{\infty} \hat{\psi} \left[ \frac{n_x u}{(\mathcal{S}_\alpha)^{1/\alpha}} \right] \quad (19)$$

where  $\hat{\psi}(u)$  is the Laplace transform of the PDF of waiting times  $\psi(\tau_x)$ . Now assume  $\hat{\psi}(u) = \exp(-Au^\alpha) \sim 1 - Au^\alpha + \dots$ . Then using Eq. (19) we have

$$\langle e^{-\eta u} \rangle = \Pi_{x=-\infty}^{\infty} \exp \left[ - \frac{A(n_x)^\alpha u^\alpha}{\mathcal{S}_\alpha} \right] = e^{-Au^\alpha}. \quad (20)$$

Hence if the waiting PDF is a one sided Lévy PDF, i.e.  $\hat{\psi}(u) = \exp(-Au^\alpha)$ , so is the PDF of  $\eta$ . In Appendix B we consider the general case where  $\psi(\tau_x)$  belongs to the domain of attraction Lévy PDFs (i.e. families of PDFs satisfying Eq.  $\hat{\psi}(u) \sim 1 - Au^\alpha + \dots$ ). We there prove that the statement in Eq. (17) is valid.

From Eq. (17) we learn that the CTRW operational time  $s$ , that is the number of jumps made in the random walk, loses its importance in the quenched model. *In the QTM the operational time is the  $\alpha$  coverage time  $\mathcal{S}_\alpha$ .* We now invert the process fixing time  $t$  to find the PDF of  $\mathcal{S}_\alpha$

$$n_t(\mathcal{S}_\alpha) \sim \frac{t}{\alpha} (\mathcal{S}_\alpha)^{-1/\alpha-1} l_{\alpha,A,1} \left[ \frac{t}{(\mathcal{S}_\alpha)^{1/\alpha}} \right]. \quad (21)$$

In the next section we explain how to use the operational time  $\mathcal{S}_\alpha$  to obtain the desired diffusion front of the QTM.

## V. WEAK SUBORDINATION BREAKING

To find the solution of the problem, namely find  $\langle P(x,t) \rangle$  for the QTM we follow the following steps:

1. Choose the laboratory time  $t$  which is a fixed parameter.

2. Use a random number generator and draw the stable random variable  $\eta$  from the one sided Lévy law  $l_{\alpha,A,1}(\eta)$ .
3. With  $\eta$  and  $t$  determine the hitting target  $\mathcal{S}_\alpha$  which according to Eq. (15) is  $\mathcal{S}_\alpha = (t/\eta)^\alpha$ .
4. Generate a Binomial random walk on a lattice, with probability 1/2 for jumping left and right. Stop the process once its  $\mathcal{S}_\alpha$  crosses the hitting target set in step 3.
5. Record the position  $x$  of the particle at the end of the previous step.
6. Go to step 2. After this loop is repeated many times, we generate a histogram of  $x$ .

The histogram once normalized yields  $\langle P(x,t) \rangle$  when  $t$  is large. Notice that in this scheme there is no disorder. The second step is implemented with a simple algorithm provided by Chambers et al [59]. These authors show how to generate stable random variables like  $\eta$  using two independent uniformly distributed random variables and for convenience their formula is provided in Appendix A.

More importantly we can now start treating the problem analytically, and find the diffusion front. So far we have replaced the problem of random walks in the QTM, with a new stochastic process: Brownian motion which is stopped when the hitting target  $\mathcal{S}_\alpha$  is crossed. In other words we got rid of the disorder. Notice that the CTRW process and standard subordination [34–38] are reached once we replace  $\mathcal{S}_\alpha$  with  $s$ . In this sense the QTM exhibits what we call weak sub-ordination breaking: the operational time is now  $\mathcal{S}_\alpha$  still the Lévy time transformation used already in the usual subordination scheme Eq. (13) remains a useful tool.

## VI. THE DIFFUSION FRONT OF THE QUENCHED TRAP MODEL

Let  $P_B(x, \mathcal{S}_\alpha)$  be the PDF of  $x$  for a binomial random walk on a lattice at operational time  $\mathcal{S}_\alpha$ . The subscript  $B$  indicates that the underlying motion is Brownian. The corresponding paths are generated from a random walk on a one dimensional lattice, with equal probability of jumping left and right, which is stopped when  $\mathcal{S}_\alpha$  is reached (or crossed for the first time). The averaged over disorder propagator of the QTM is found using Eq. (21) and the scheme presented in the last section:

$$\langle P(x,t) \rangle \sim \int_0^\infty P_B(x, \mathcal{S}_\alpha) n_t(\mathcal{S}_\alpha) d\mathcal{S}_\alpha, \quad (22)$$

which is valid in the long time limit. Eq. (22) is a generalization of the subordination equation (13). Namely it transforms Brownian motion stopped at the coverage time  $\mathcal{S}_\alpha$  to the QTM dynamics in laboratory time  $t$ .

From Eq. (22) we may find general properties of the Green function  $\langle P(x,t) \rangle$  in terms of its corresponding

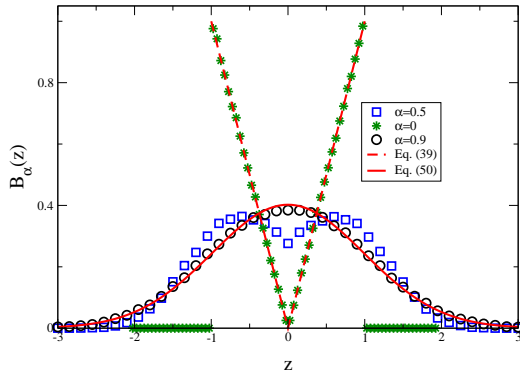

FIG. 1: The PDF  $B_\alpha(z)$  exhibits a transition between a Gaussian shape when  $\alpha \rightarrow 1$  to a  $V$  shape when  $\alpha \rightarrow 0$ . Simulations of Brownian motion on a lattice yield excellent agreement with theoretical predictions Eqs. (39, 50) without fitting.

Brownian partner  $P_B(x, \mathcal{S}_\alpha)$ . For example the Laplace  $t \rightarrow u$  transform

$$\langle \hat{P}(x, u) \rangle = Au^{\alpha-1} \hat{P}_B(x, Au^\alpha). \quad (23)$$

Less formal relations are found if we exploit the scaling behavior of Brownian motion as now explained.

### A. Scaling arguments

Brownian motion follows the usual diffusive scaling  $x^2 \propto s$  where  $s$  is the number of steps. In Appendix C we show that  $s \propto (\mathcal{S}_\alpha)^{2/(1+\alpha)}$  which is now explained using simple arguments. For Brownian motion the particle explores a region which scales like  $s^{1/2}$ . The visitation number  $n_x$  within this region (i.e. roughly  $|x| < s^{1/2}$ ) is the number of jumps made ( $s$ ) divided by the number of sites in the explored region ( $s^{1/2}$ ) so  $n_x \propto s/s^{1/2} = s^{1/2}$ . Since particles typically visit  $|x| \gg s^{1/2}$  only rarely  $n_x \propto 0$  there. Hence  $\mathcal{S}_\alpha \propto \sqrt{s}(n_x)^\alpha \propto s^{(1+\alpha)/2}$ . Indeed in Appendix C we show that

$$\langle \mathcal{S}_\alpha \rangle = \mathcal{C}_\alpha s^{\frac{1+\alpha}{2}} \quad (24)$$

with

$$\mathcal{C}_\alpha = \frac{2^{\frac{\alpha+3}{2}} \Gamma(1 + \frac{\alpha}{2})}{\sqrt{\pi} (1 + \alpha)}. \quad (25)$$

When  $\alpha = 1$  we have  $\mathcal{C}_1 = 1$  since  $\mathcal{S}_1 = \sum_{x=-\infty}^{\infty} n_x = s$ . In the opposite limit  $\alpha = 0$  we find a well known result obtained by Dvoretzky and Erdős [60]

$$\langle \mathcal{S}_0 \rangle = \sqrt{\frac{8s}{\pi}}. \quad (26)$$

$\alpha$	$\langle z^2 \rangle$	$B_\alpha(z=0)$
0	0.5	0
0.1	0.592	0.08
0.2	0.673	0.15
0.3	0.746	0.2
0.4	0.808	0.24
0.5	0.859	0.28
0.6	0.907	0.3
0.7	0.929	0.33
0.8	0.961	0.35
0.9	0.986	0.38
1	1	$1/\sqrt{2\pi}$

TABLE I: Brownian simulations on a lattice give  $\langle z^2 \rangle$  and  $B_\alpha(z=0)$  which in turn provide the corresponding solution of the QTM with Eqs. (32, 33).

By definition  $\langle \mathcal{S}_0 \rangle$  is the averaged number of distinct sites visited by an unbiased random walker [30].

Using  $x \propto s^{1/2}$  and  $\mathcal{S}_\alpha \propto s^{(1+\alpha)/2}$  scalings we have  $x \propto (\mathcal{S}_\alpha)^{1/(1+\alpha)}$ . We emphasize that this is a property of simple binomial random walks which we can now exploit to investigate the solution of the QTM. More specifically this scaling implies

$$P_B(x, \mathcal{S}_\alpha) = \frac{1}{(\mathcal{S}_\alpha)^{1/(1+\alpha)}} B_\alpha \left[ \frac{x}{(\mathcal{S}_\alpha)^{1/(1+\alpha)}} \right]. \quad (27)$$

Here  $B_\alpha(z)$  is a non negative function normalized according to  $\int_{-\infty}^{\infty} B_\alpha(z) dz = 1$ . Further from symmetry of the walk  $B_\alpha(z) = B_\alpha(-z)$ . As shown in Fig. 1, the PDF  $B_\alpha(z)$  exhibits an interesting transition between a  $V$  shape for  $\alpha \rightarrow 0$  and a Gaussian shape when  $\alpha \rightarrow 1$ . In the following sections we will investigate  $B_\alpha(z)$  in detail.

With  $B_\alpha(z)$  we obtain useful relations between the diffusion front of the trap model and Brownian motion. Define the dimensionless time  $\tilde{t} = t/A^{1/\alpha}$  and the scaling variable

$$\xi = \frac{x}{(\tilde{t})^{\frac{\alpha}{1+\alpha}}}. \quad (28)$$

Then it is easy to show that

$$\langle P(x, t) \rangle \sim \frac{g_\alpha(\xi)}{(\tilde{t})^{\frac{\alpha}{1+\alpha}}} \quad (29)$$

and using Eq. (22)

$$g_\alpha(\xi) = \int_0^\infty dy y^{\frac{\alpha}{1+\alpha}} B_\alpha(\xi y^{\frac{\alpha}{1+\alpha}}) l_{\alpha,1,1}(y). \quad (30)$$

For the behavior of  $\langle P(x, t) \rangle$  on the origin we use

$$\int_0^\infty dy y^q l_{\alpha,1,1}(y) = \begin{cases} \infty & \text{if } q/\alpha > 1 \\ \frac{\Gamma(1-q/\alpha)}{\Gamma(1-q)} & \text{if } q/\alpha < 1 \end{cases} \quad (31)$$

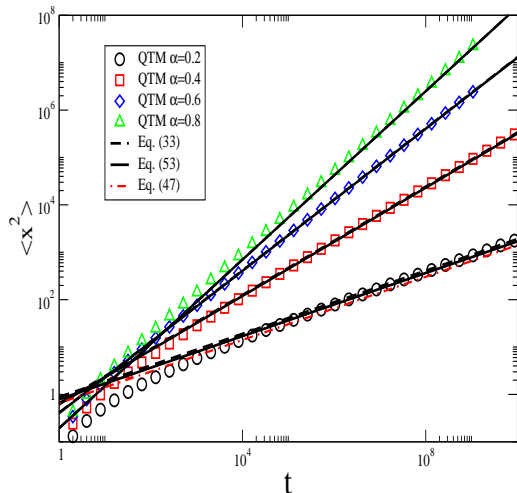

FIG. 2: The mean square displacement versus time. Numerical data obtained from direct simulations of the QTM match perfectly the theory based on weak subordination breaking (the lines plotted using Eq. (33) and Table I). Analytical predictions for  $\langle x^2 \rangle$  Eq. (47) for  $\alpha = 0.2$  and Eq. (53) for  $\alpha = 0.4, 0.6, 0.8$  perfectly match direct simulations and weak subordination scheme (based on Brownian simulations) and hence the corresponding curves fall one on top of the other.

and then find

$$\langle P(x=0, t) \rangle \sim B_\alpha(0) \frac{\Gamma\left(\frac{\alpha}{1+\alpha}\right)}{\Gamma\left(\frac{1}{1+\alpha}\right) (\tilde{t})^{\frac{\alpha}{1+\alpha}}}. \quad (32)$$

This is a useful result since the behavior of  $B_\alpha(z)$  on the origin  $z=0$  gives the corresponding behavior of  $\langle P(x=0, t) \rangle$  without the need to solve any integral. Further Eq. (32) hints to an interesting behavior when  $\alpha \rightarrow 0$ . The ratio of the  $\Gamma$  functions diverges in that limit, hence as shown in Fig. 1  $B_\alpha(z=0)$  must go to zero when  $\alpha \rightarrow 0$  for  $\langle P(x=0, t) \rangle$  to remain finite. Such a behavior is analytically investigated in the following section.

Another useful relation is found between the moments  $\langle |x|^q \rangle = \langle \int_{-\infty}^{\infty} |x|^q P(x, t) dx \rangle$  of the original QTM and the moments  $\langle |z|^q \rangle = \int_{-\infty}^{\infty} |z|^q B_\alpha(z) dz$ . Using Eqs. (30, 31) we find

$$\langle |x|^q \rangle = \langle |z|^q \rangle \frac{\Gamma\left(\frac{q}{1+\alpha}\right)}{\alpha \Gamma\left(\frac{q\alpha}{1+\alpha}\right)} (\tilde{t})^{\frac{\alpha q}{1+\alpha}}. \quad (33)$$

The scaling  $x^2 \propto (\tilde{t})^{\frac{2\alpha}{1+\alpha}}$  was obtained long ago in [17, 27] using elegant scaling arguments and in [26] using renormalization group approach. The new content of Eqs. (30, 32, 33) is that once we obtain  $B_\alpha(z)$  either from theory

or simulations of Brownian trajectories, we have a useful method to obtain exact statistical properties of the diffusion front.

On a computer our approach is very useful. For example we have numerically generated Brownian trajectories on a lattice and obtained  $B_\alpha(z)$  in Fig. 1 while  $\langle z^2 \rangle$  and  $B_\alpha(0)$  are reported in Table I. With  $\langle z^2 \rangle$  given in Table I and Eq. (33) we get the mean square displacement of the QTM  $\langle x^2 \rangle$ . Direct simulations of the QTM are favorably compared with the predictions of our theory in Fig. 2.

Finally the cumulative distribution function  $G_\alpha(\xi < \Xi) = \int_{-\infty}^{\Xi} g_\alpha(\xi) d\xi$ , the probability that the random variable  $\xi$  attains a value less than  $\Xi$  is found using Eq. (27)

$$G_\alpha(\xi < |\Xi|) = 1 - \int_0^\infty dz B_\alpha(z) L_\alpha \left[ \left( \frac{z}{|\Xi|} \right)^{\frac{1+\alpha}{\alpha}} \right]. \quad (34)$$

Here  $L_\alpha(y) = \int_0^y l_{\alpha,1,1}(y) dy$  is the cumulative distribution of a one sided stable random variable. From symmetry  $G_\alpha(\xi, -|\Xi|) = 1 - G_\alpha(\xi < |\Xi|)$ . The integral representation of the distribution  $L_\alpha(y)$  can be found in [59].

## VII. LIMIT $\alpha \rightarrow 0$

As mentioned in the introduction the diffusion front  $\langle P(x, t) \rangle$  was treated using a renormalization group method by Monthus [32]. We will now investigate this interesting limit using our new approach. For that we must first find  $B_\alpha(z)$  in the limit  $\alpha \rightarrow 0$ .

### A. $\lim_{\alpha \rightarrow 0} B_\alpha(z)$ has a V shape

We consider Brownian motion on a lattice which is stopped once the distinct number of sites visited by the walker reaches the threshold  $\mathcal{S}_0$  and as a reminder  $\mathcal{S}_0$  is called the span. The position of the particle is then  $x$  and we are interested in the probability  $P(x, \mathcal{S}_0)$  of finding the particle on  $x$ .

The particle starts on the origin, hence clearly we have  $|x| \leq \mathcal{S}_0$ . Further  $P(x=0, \mathcal{S}_0) = 0$ , since a particle starting on the origin cannot reach the threshold  $\mathcal{S}_0$  when it is on the origin: i.e. a particle returning to the origin is not increasing  $\mathcal{S}_0$  since the origin is not a new site visited by the walker. From symmetry  $P(-x, \mathcal{S}_0) = P(x, \mathcal{S}_0)$ .

Consider first  $P(x=\mathcal{S}_0, \mathcal{S}_0)$ . After the first step the particle can be either on  $x=1$  with probability  $1/2$  or on  $x=-1$  with the same probability. Clearly a trajectory going through  $x=-1$  cannot contribute to  $P(x=\mathcal{S}_0, \mathcal{S}_0)$  since to reach  $x=\mathcal{S}_0$  through  $x=-1$  the span must be at-least of length  $\mathcal{S}_0+1$ . So we consider only trajectories going through  $x=1$ . Trajectories going through  $x=1$  are divided into three non-intersecting categories. Trajectories that (i) never reach the origin  $x=0$  along their path, (ii) trajectories that reach the

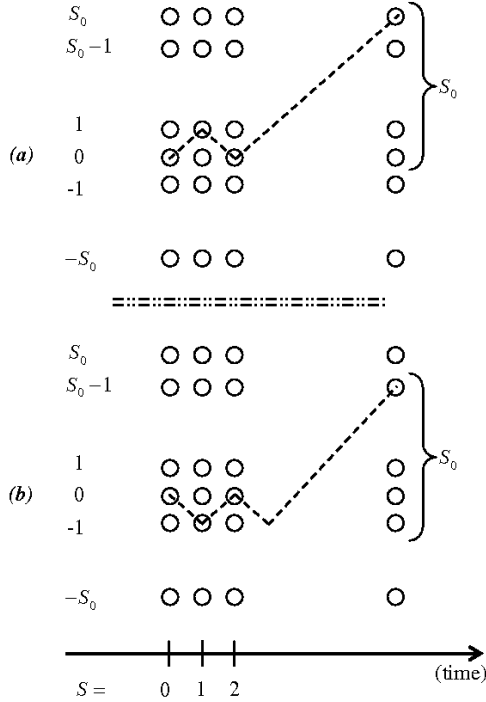

FIG. 3: (a) Trajectory with a span  $\mathcal{S}_0$ . The particle returns to the origin along its path [category (ii) in text], hence in the time interval  $s > 1$  (excluding the first step) the displacement is  $\mathcal{S}_0 - 1$  and the span  $\mathcal{S}_0$ . (b) A random walker with span  $\mathcal{S}_0$  reaching  $x = \mathcal{S}_0 - 1$  must pass through  $x = -1$ . Here the first jump event brings the particle to  $x = -1$  and hence the span in  $s > 1$  is  $\mathcal{S}_0$  and the displacement  $\mathcal{S}_0$ .

origin but never cross it see Fig. 3(a) and (iii) trajectories that go below  $x = 0$ . The latter will have a total span greater than  $\mathcal{S}_0$  and hence do not contribute. For class (i) the span (after stepping into  $x = 1$  in the first step) is  $\mathcal{S}_0 - 1$ . Similarly for class (ii) the span is  $\mathcal{S}_0$ . For both cases the displacement (from  $x = 1$  to  $\mathcal{S}_0$ ) is clearly  $\mathcal{S}_0 - 1$ . Hence we have

$$P(x = \mathcal{S}_0, \mathcal{S}_0) =$$

$$\frac{1}{2} [P(x = \mathcal{S}_0 - 1, \mathcal{S}_0) + P(x = \mathcal{S}_0 - 1, \mathcal{S}_0 - 1)] \quad (35)$$

where the first (second) term on the right hand side describes trajectories returning (never returning) to the origin. The half in front of the square brackets is due to the displacement in the first jump event.

Continuing with similar reasoning consider  $P(x = \mathcal{S}_0 - 1, \mathcal{S}_0)$ . The particle after the first step can be either on  $x = 1$  or  $x = -1$ . As shown in Fig. 3(b), if it is on  $x = -1$  it must travel a distance  $\mathcal{S}_0$  to reach its destination  $\mathcal{S}_0 - 1$  while keeping the span  $\mathcal{S}_0$ .

On the other hand if it jumps to  $x = 1$  the distance the particle must travel is  $\mathcal{S}_0 - 2$  and the span is  $\mathcal{S}_0$ . Hence we have

$$P(x = \mathcal{S}_0 - 1, \mathcal{S}_0) = \frac{1}{2}P(x = \mathcal{S}_0, \mathcal{S}_0) + \frac{1}{2}P(x = \mathcal{S}_0 - 2, \mathcal{S}_0) \quad (36)$$

where the first (second) term on the right hand side describes trajectories starting on the origin and in the first step jumping to  $x = -1$  ( $x = 1$ ) respectively. Similarly for  $\mathcal{S}_0 - n > 0$  with  $n > 0$  being an integer we have

$$P(x = \mathcal{S}_0 - n, \mathcal{S}_0) =$$

$$\frac{1}{2}P(x = \mathcal{S}_0 - n - 1, \mathcal{S}_0) + \frac{1}{2}P(x = \mathcal{S}_0 - n + 1, \mathcal{S}_0). \quad (37)$$

Eqs. (35,37) are easily solved

$$P(x, \mathcal{S}_0) = \frac{|x|}{\mathcal{S}_0(\mathcal{S}_0 + 1)} \quad \text{for} \quad -\mathcal{S}_0 \leq x \leq \mathcal{S}_0 \quad (38)$$

and  $x \in \mathbf{Z}$ . In the limit  $\mathcal{S}_0 \gg 1$  we have for the scaled variable  $z = x/\mathcal{S}_0$  the PDF

$$\lim_{\alpha \rightarrow 0} B_\alpha(z) = \begin{cases} |z| & \text{for } |z| < 1 \\ 0 & \text{otherwise} \end{cases} \quad (39)$$

We see that  $B_{\alpha=0}(z)$  has a V shape. This reflects the observation that the particle reaching a large span  $\mathcal{S}_0$  is most likely far from the origin, and the probability of reaching the span  $\mathcal{S}_0$  for the first time, while the particle is on the origin being zero. We now use this property of Brownian motion to solve the quenched trap model in the limit  $\alpha \rightarrow 0$ .

## B. Diffusion front in the $\alpha \rightarrow 0$ limit

Define the Fourier transform of the scaling function  $g_\alpha(\xi)$  Eq. (29)

$$g_\alpha(k_\xi) = \int_{-\infty}^{\infty} e^{ik_\xi \xi} g_\alpha(\xi) d\xi \quad (40)$$

which as usual is also the moment generating function

$$g_\alpha(k_\xi) = \sum_{q=0}^{\infty} \frac{(ik_\xi)^{2q} \langle \xi^{2q} \rangle}{(2q)!}. \quad (41)$$

According to our theory the moments  $\langle (\xi)^{2q} \rangle = \int_{-\infty}^{\infty} g_\alpha(\xi) \xi^{2q} d\xi$  and similarly  $\langle x^{2q} \rangle$  for the QTM are determined by Brownian motion with the help of the PDF  $B_\alpha(z)$  Eq. (33). In the limit  $\alpha \rightarrow 0$  we find using Eq. (39)

$$\langle z^{2q} \rangle = 2 \int_0^1 z^{2q} z dz = \frac{1}{1+q} \quad (42)$$

and hence for  $\alpha \rightarrow 0$  Eqs. (28,33) give

$$\langle \xi^{2q} \rangle = \frac{(2q)!}{q+1}. \quad (43)$$

Therefore

$$\lim_{\alpha \rightarrow 0} g_\alpha(k_\xi) = \sum_{q=0}^{\infty} (-1)^q \left( \frac{1}{q+1} \right) (k_\xi)^{2q}, \quad (44)$$

summing this series we find

$$\lim_{\alpha \rightarrow 0} g_\alpha(k_\xi) = \frac{\ln [1 + (k_\xi)^2]}{(k_\xi)^2}. \quad (45)$$

Inverse Fourier transform yields

$$\lim_{\alpha \rightarrow 0} g_\alpha(\xi) = e^{-|\xi|} - |\xi| E_1(|\xi|) \quad (46)$$

where  $E_1(\xi) = \int_\xi^\infty (e^{-t}/t) dt$  is the tabulated exponential integral [61]. This result (written in a different but equivalent form) was obtained by C. Monthus [32] using the renormalization group method, which is exact in the limit  $\alpha \rightarrow 0$ . In Fig. 4 we show  $g_\alpha(\xi)$  for simulations of the QTM ( $\alpha = 0.1$ ), Brownian simulations using weak subordination breaking outlined in Sec. V and analytical curve Eq. (46). We see that the theory which is exact when  $\alpha \rightarrow 0$  works well also for small values of  $\alpha$ .

When  $\alpha$  is small we find a useful approximation for the moments. Inserting  $\langle |z|^q \rangle$  Eq. (42) in Eq. (33) we have

$$\langle |x|^q \rangle \simeq \frac{2}{2+q} \frac{\Gamma\left(\frac{q}{1+\alpha}\right)}{\alpha \Gamma\left(\frac{\alpha q}{1+\alpha}\right)} \left( \frac{t}{A^{1/\alpha}} \right)^{\frac{\alpha q}{1+\alpha}}. \quad (47)$$

Notice that in this limit  $\Gamma[q/(1+\alpha)]/\{\alpha \Gamma[\alpha q/(1+\alpha)]\} \simeq \Gamma(1+q)$  hence for  $q=0$  we have  $\langle |x|^0 \rangle = 1$  as expected from normalization. In Fig. 2 we show  $\langle x^2 \rangle$  versus time for  $\alpha = 0.2$ . Numerical simulation of the QTM perfectly match Eq. (47). Note that the theory based on Table I and Eq. (33) does a slightly better job since that approach is not limited to the  $\alpha \ll 1$  regime.

## VIII. APPROACHING THE GAUSSIAN LIMIT $\alpha = 1$

In this section we consider the case  $\alpha \rightarrow 1$  from below. We now find an approximation for  $B_\alpha(z)$  which yields the solution of the QTM in this limit.

### A. $B_\alpha(z)$ is Gaussian when $\alpha \rightarrow 1$

As before to find  $B_\alpha(z)$  we consider Brownian motion. The probability of finding the particle on  $x$  at time  $s$  is a Gaussian

$$P(x, s) = \frac{\exp\left(-\frac{x^2}{2s}\right)}{\sqrt{2\pi s}} \quad (48)$$

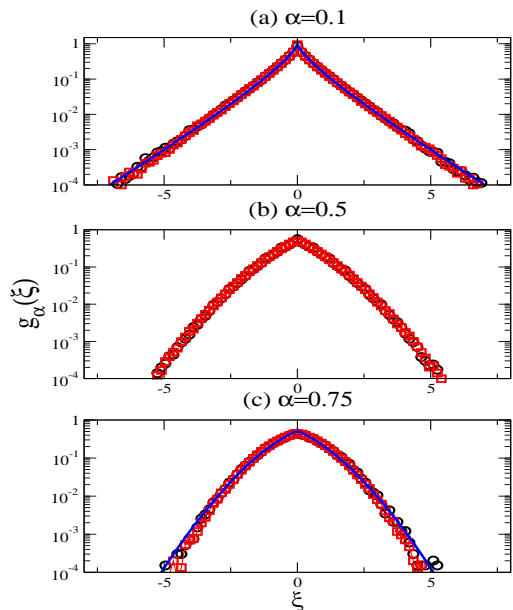

FIG. 4: The diffusion front of QTM (simulations) nicely matches our theory based on weak subordination breaking [the algorithm in Sec. (V)] and analytical predictions Eqs. (46, 52) for  $\alpha = 0.1, 0.75$  respectively.

as is well known. For  $\alpha = 1$  we have  $\mathcal{S}_1 = \sum_{x=-\infty}^{\infty} n_x = s$ , namely  $\mathcal{S}_1$  is not a random variable at all since it is equal to the number of steps made in the underlying random walk. In other words the PDF of  $\mathcal{S}_1$  is a delta function centered on  $s$ . Therefore when  $\alpha$  is close enough to 1 we may neglect fluctuations. This means that we omit the average in Eq. (25) and use  $\mathcal{S}_\alpha = \mathcal{C}_\alpha s^{\frac{1+\alpha}{2}}$ . This approach together with Eq. (48) gives the PDF of finding the particle on  $x$  for a random walk stopped at the  $\alpha$  coverage time  $\mathcal{S}_\alpha$

$$P_B(x, \mathcal{S}_\alpha) \simeq \frac{\exp\left[-\frac{x^2}{2(\mathcal{S}_\alpha/\mathcal{C}_\alpha)^{\frac{2}{1+\alpha}}}\right]}{\left[2\pi(\mathcal{S}_\alpha/\mathcal{C}_\alpha)^{\frac{2}{1+\alpha}}\right]^{1/2}}. \quad (49)$$

Hence

$$B_\alpha(z) \simeq \frac{\exp\left[-\frac{(\mathcal{C}_\alpha)^{\frac{2}{1+\alpha}} z^2}{2}\right]}{\left[2\pi/(\mathcal{C}_\alpha)^{\frac{2}{1+\alpha}}\right]^{1/2}}, \quad (50)$$

and it follows that

$$\langle z^2 \rangle = (\mathcal{C}_\alpha)^{-\frac{2}{1+\alpha}}. \quad (51)$$

In Fig. 1  $B_\alpha(z)$  obtained from Brownian simulations is compared with the analytical prediction Eq. (50) for  $\alpha = 0.9$ .



## B. $\langle P(x, t) \rangle$ when $\alpha \simeq 1$

From Eqs. (22,49) we have

$$\langle P(x, t) \rangle \simeq \int_0^\infty d\mathcal{S}_\alpha \frac{\exp\left[-\frac{x^2}{2(\mathcal{S}_\alpha/\mathcal{C}_\alpha)^{\frac{2}{1+\alpha}}}\right]}{\left[2\pi(\mathcal{S}_\alpha/\mathcal{C}_\alpha)^{\frac{2}{1+\alpha}}\right]^{1/2}} n(\mathcal{S}_\alpha, t). \quad (52)$$

From Eq. (52) it is easy to get  $g_\alpha(\xi)$  which is given in Eq. (91) in Appendix D. In Fig. 4 we compare between the scaling function obtained analytically and numerical simulations of the QTM, and with Brownian simulations according to the disorder free algorithm in Sec. V. The theory works reasonably well even for  $\alpha = 0.75$ .

Using Eqs. (33,51) we find the mean square displacement of the QTM

$$\langle x^2 \rangle \simeq (\mathcal{C}_\alpha)^{-\frac{2}{1+\alpha}} \frac{\Gamma\left(\frac{2}{1+\alpha}\right)}{\alpha\Gamma\left(\frac{2\alpha}{1+\alpha}\right)} \left(\frac{t}{A^{1/\alpha}}\right)^{\frac{2\alpha}{1+\alpha}}. \quad (53)$$

Calculation of other moments is as simple, since the reader may easily obtain  $\langle |z|^q \rangle$  from the Gaussian PDF Eq. (50) and then apply Eq. (33). The behavior on the origin is found using Eqs. (32,50)

$$\langle P(x=0, t) \rangle \simeq \frac{(\mathcal{C}_\alpha)^{\frac{1}{1+\alpha}} \Gamma\left(\frac{\alpha}{1+\alpha}\right)}{\sqrt{2\pi} \Gamma\left(\frac{1}{1+\alpha}\right)} (\tilde{t})^{-\frac{\alpha}{1+\alpha}}. \quad (54)$$

When  $\alpha = 1$  we get the expected behavior  $\langle P(x=0, t) \rangle = (2\pi\tilde{t})^{-1/2}$ , which is normal diffusion.

The scaling function  $g_\alpha(\xi)$  is analyzed in Appendix D. Using properties of stable PDFs, we show that when  $\xi \ll 1$

$$g_\alpha(\xi) \sim g_\alpha(0) - 2^{\frac{\alpha-1}{2}} \left(\frac{1+\alpha}{\alpha}\right) \frac{\mathcal{C}_\alpha}{\Gamma\left(\frac{1-\alpha}{2}\right)} \xi^\alpha + \dots \quad (55)$$

with

$$g_\alpha(0) = \frac{(\mathcal{C}_\alpha)^{\frac{1}{1+\alpha}} \Gamma\left(\frac{\alpha}{1+\alpha}\right)}{\sqrt{2\pi} \Gamma\left(\frac{1}{1+\alpha}\right)}. \quad (56)$$

In the limit  $\alpha \rightarrow 1$  we use  $\lim_{\alpha \rightarrow 1} \mathcal{C}_\alpha = 1$  and Eq. (55) gives

$$\lim_{\alpha \rightarrow 1} g_\alpha(\xi) \sim \frac{1}{\sqrt{2\pi}} - \lim_{\alpha \rightarrow 1} \frac{2}{\Gamma\left(\frac{1-\alpha}{2}\right)} \xi^\alpha + \dots \quad (57)$$

The first term clearly reflects an ordinary Gaussian diffusion front. The second term vanishes in the limit  $\alpha = 1$  since  $\Gamma(0) = \infty$ . This is because  $g_1(\xi)$  is Gaussian and hence the second term in the expansion must be a  $\xi^2$  term. So the  $1/\Gamma(0)$  kills the  $\xi^\alpha$  in Eq. (57) as  $\alpha \rightarrow 1$ . In the opposite limit of  $\xi \gg 1$  a steepest descent method gives

$$g_\alpha(\xi) \sim b_1 \xi^{-2\frac{1-\alpha}{3-\alpha}} e^{-b_2 \xi^{2\frac{1+\alpha}{3-\alpha}}} \quad (58)$$

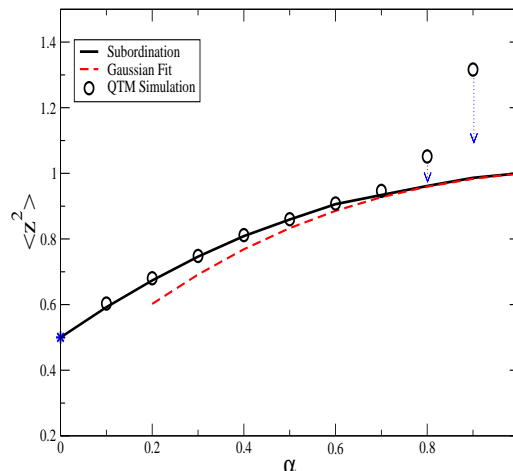

FIG. 5: We show  $\langle z^2 \rangle$  versus  $\alpha$ . According to theory  $\langle z^2 \rangle = 1/2$  for  $\alpha \rightarrow 0$  and  $\langle z^2 \rangle = 1$  when  $\alpha \rightarrow 1$ . We compute  $\langle z^2 \rangle$  using Brownian simulations as in Table I (solid curve) and with the QTM. For  $\alpha = 0.8$  and  $\alpha = 0.9$  the finite time simulations of the QTM did not converge, as shown in Fig. 6. However extrapolating the data (see Fig. 6) we get excellent agreement between simulations of the trap model and our theory based on weak sub-ordination breaking.

where  $b_1$  and  $b_2$  are found in Appendix D. In the limit we find

$$\lim_{\alpha \rightarrow 1} g_\alpha(\xi) = \frac{1}{\sqrt{2\pi}} e^{-\frac{\xi^2}{2}} \quad (59)$$

the expected Gaussian behavior.

## IX. CRITICAL SLOW DOWN $\alpha \rightarrow 1$

As discussed in [40] close to the critical point  $\alpha = 1$  convergence of direct simulations of the QTM is extremely slow. In contrast simulations of Brownian trajectories, using weak sub-ordination scheme converges in reasonable time, at least on our computer. In this sense our approach is much more efficient compared with direct simulation of the QTM. In fact we believe that our scheme is the only numerical tool available today for the investigation of the limit  $\alpha \rightarrow 1$ .

In Fig. 5 we show  $\langle z^2 \rangle$  versus  $\alpha$ .  $\langle z^2 \rangle$  was obtained by several means: i) simulation of the QTM which give  $\langle x^2 \rangle$ , and then with Eq. (33) we extract  $\langle z^2 \rangle$  (ii) Brownian simulations on a lattice (results in Table I), and (iii) analytical theory Eqs. (42, 51). For  $\alpha > 0.8$  our simulations of the QTM did not converge even for  $t = 10^9$ . To

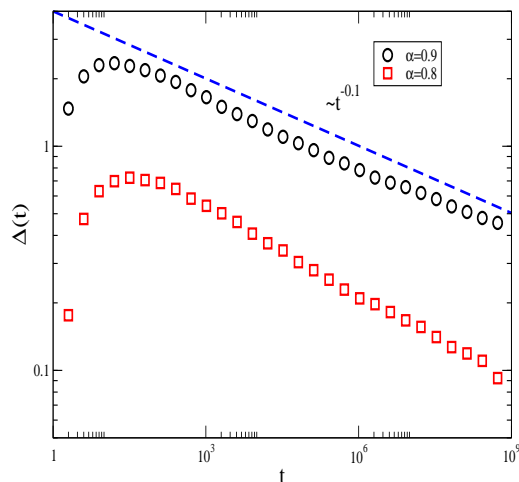

FIG. 6: Here we show that  $\Delta$  defined in Eq. (60) approaches zero extremely slowly when  $\alpha = 0.8$  and  $\alpha = 0.9$ . Following the observation of Bertin and Bouchaud, close to the transition from anomalous to normal types of diffusion we find critical slowing down. We see that  $\Delta(t) \simeq 0.1$  at times  $10^9$  when  $\alpha = 0.8$  and hence simulations did not converge at a time scale which is on the verge of our numerical capabilities (for  $\alpha = 0.9$  the situations is worse). By extrapolation the figure shows that the asymptotic theory is reached albeit slowly. The dashed line is a guide to the eye with a  $t^{-0.1}$  behavior.

check this issue better we define the deviation

$$\Delta(t) \equiv \left| \frac{\langle x^2 \rangle \alpha \Gamma\left(\frac{2\alpha}{1+\alpha}\right)}{\Gamma\left(\frac{2}{1+\alpha}\right) (t/A^{1/\alpha})^{\frac{2\alpha}{1+\alpha}}} - \langle z^2 \rangle \right|. \quad (60)$$

According to Eq. (33)  $\lim_{t \rightarrow \infty} \Delta(t) = 0$ . In Fig. 6 we present  $\Delta(t)$  versus time. Here  $\langle x^2 \rangle$  is obtained from QTM simulations and  $\langle z^2 \rangle$  from Brownian trajectories (see Table I). In Fig. 6 we show that  $\Delta(t) \sim t^{\alpha-1}$  for  $\alpha = 0.9$  and observe a very slow decay towards the asymptotic value  $\Delta(t) \rightarrow 0$ . Simulations of the QTM did not converge (even for  $t = 10^9$ ) however extrapolating the data (assuming nothing dramatic happens for times larger than  $10^9$ ) we can conclude that  $\Delta(t) \rightarrow 0$  and in that sense our theory is consistent with the simulations.

To overcome critical slow down in the region  $\alpha \rightarrow 1$  we use weak subordination scheme Sec. V instead of direct numerical simulations of the QTM. In Fig. 7 we show the diffusion front. Good agreement between analytical predictions (valid for  $\alpha \rightarrow 1$ ) Eqs. (52, 55, 58) and weak subordination breaking algorithm is presented for  $\alpha = 0.9$ .

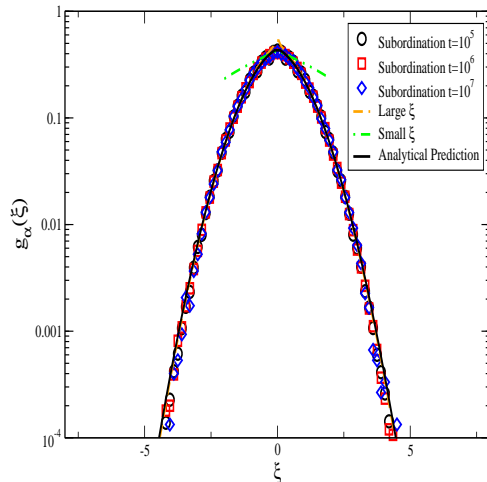

FIG. 7: For the case  $\alpha = 0.9$  we present the scaling PDF  $g_\alpha(\xi)$  obtained using weak subordination scheme Sec. V together with analytical curve Eq. (52) and large and small  $\xi$  expansions Eqs. (55, 58). Similar direct simulation of the quenched trap model do not converge even when  $t = 10^9$  (see Figs. 5,6) The figure demonstrates that with our approach based on weak sub-ordination breaking reasonable converges is found already for  $t = 10^5$ . Hence close to the critical point  $\alpha = 1$  weak subordination breaking can deal with the critical slow down.

## X. DISCUSSION

The main focus of this paper was on the diffusion front  $\langle P(x, t) \rangle$  of random walkers in the quenched trap model in one dimension. We showed that  $\langle P(x, t) \rangle$  is found with a Lévy time transformation acting on Brownian motion stopped at the operational time  $\mathcal{S}_\alpha$ . Thus we map the random walk in disordered environment to a Brownian motion which is stopped at the  $\alpha$  coverage time  $\mathcal{S}_\alpha$ . This new type of Brownian motion is interesting on its own right. For example we have found a transition from a V shape to a Gaussian behavior for the scaling function  $B_\alpha(z)$  describing this motion. Properties of this function determine the statistics of diffusion in the QTM. For  $\alpha$  close to 1 and 0 we obtained analytical expressions for  $B_\alpha(z)$  and  $\langle P(x, t) \rangle$  while numerical information easily obtained from Brownian simulations provide a detailed description of the diffusion front in the range  $0 < \alpha < 1$ .

For  $\alpha \rightarrow 0$  our formulas reduce to the renormalization group results obtained by C. Monthus [32]. The approach presented here is an alternative to the renormalization group method. Its advantage is that it is capable of dealing with the whole spectrum of  $\alpha$ , at least numerically, including in the critically slowed down regime of  $\alpha \rightarrow 1$ .

Is our method general or is it limited to the one dimen-

sional quenched trap model? Clearly our approach can be extended to higher dimensions, or for random walks with biases. As mentioned in the introduction beyond the critical dimension, the QTM belongs to the domain of attraction of the CTRW. Hence for an ordinary random walk on a lattice in dimension three we expect that  $\mathcal{S}_\alpha$  is non-random and equal to  $c_\alpha s$  when time  $s$  is large, and  $c_\alpha$  is a constant so far not determined. In that case usual subordination method works for the corresponding trap model. Hence once the constant  $c_\alpha$  and the diffusion coefficient of the corresponding discrete time random walk are determined we have the statistical information needed for the determination the diffusion front of the QTM. Detailed analysis of the QTM for dimensions higher than one and for biased processes, using methods developed here, are left for future work.

**Acknowledgement** This work was supported by the Israel science foundation. We thank Satya Majumdar for his correspondence on the Feynman-Kac approach which can be used to derive Eq. (89). Special thanks to Zvi Shemer for many discussion along this project.

## XI. APPENDIX A

Here we summarize some known results on one sided Lévy stable random variables, which are used all along this work. By definition  $l_{\alpha,1,1}(t)$  is the inverse Laplace transform of  $\exp(-u^\alpha)$ . The large  $t$  series expansion

$$l_{\alpha,1,1}(t) = \frac{1}{\pi} \sum_{n=1}^{\infty} \frac{\Gamma(1+n\alpha)}{n!} (-1)^{n-1} \sin(\pi n\alpha) t^{-(\alpha n+1)}. \quad (61)$$

The asymptotic small  $t$  behavior is [43]

$$l_{\alpha,1,1}(t) \sim B t^{-\sigma} e^{-\kappa t^{-\tau}} \quad (62)$$

where

$$\tau = \frac{\alpha}{1-\alpha}, \quad \kappa = (1-\alpha)\alpha^{\alpha/(1-\alpha)}, \quad \sigma = \frac{2-\alpha}{2(1-\alpha)},$$

$$B = \{[2\pi(1-\alpha)]^{-1} \alpha^{1/(1-\alpha)}\}^{1/2}. \quad (63)$$

Closed form PDFs are found by summing the series Eq. (61) for specific choices of  $\alpha$  [35, 45]. For example we insert the series Eq. (61) in Mathematica and use the command Simplify to get Lévy PDFs in terms of a combination of Hypergeometric functions (e.g. for  $\alpha = 1/4$ ). Similarly Lévy's PDFs with  $\alpha = 1/4, 1/3, 1/2, 2/3, 9/10$  can be expressed in terms of special functions. In this way we construct stable distributions. Some care must be practiced since in some occasions we found that for extremely small  $t$  Mathematica yields wrong results [35]. This problem is easily fixed since we can use Eq. (62) in that regime. Further the problem is not crucial in the sense that it is found for so small  $t$  that practically the PDF there is zero, though if one is not aware of this issue solving integral transformations like Eq. (49) can lead to wrong results. A useful special case is  $\alpha = 1/2$  since

$$l_{1/2,1,1}(t) = \frac{1}{2\sqrt{\pi}} t^{-3/2} \exp\left(-\frac{1}{4t}\right). \quad (64)$$

Chambers et al [59] show how to generate a stable random variable we call  $\eta$  from a one sided Lévy PDF  $l_{\alpha,1,1}(\eta)$ . Let

$$a(\theta) = \frac{\sin((1-\alpha)\theta) (\sin(\alpha\theta))^{\alpha/(1-\alpha)}}{(\sin\theta)^{1/(1-\alpha)}}, \quad 0 < \theta < \pi. \quad (65)$$

Then  $\eta = [a(\theta)/W]^{(1-\alpha)/\alpha}$  where  $\theta$  is a uniform random number on  $(0, \pi)$  and  $W$  is a random variable drawn from a standard exponential distribution:  $W = -\ln(x)$  were  $x$  is uniform on  $(0, 1)$ .

## XII. APPENDIX B

In this Appendix we obtain the distribution of  $\eta$  defined in Eq. (15). We are interested in random walks with

fixed  $\mathcal{S}_\alpha$  and in the limit  $\mathcal{S}_\alpha \rightarrow \infty$ . A large  $\mathcal{S}_\alpha$  implies also a large number of steps (denoted with  $s$ ), however since  $\mathcal{S}_\alpha$  is fixed  $s$  remains random. Our starting point is Eq. (19)

$$\langle e^{-u\eta} \rangle = \Pi_{x=-\infty}^{\infty} \hat{\psi} \left[ \frac{n_x u}{(\mathcal{S}_\alpha)^{1/\alpha}} \right]. \quad (66)$$

It is important to notice that the visitation numbers  $\{n_x\}$  are determined by the probabilities of jumping left and right (equal 1/2 in our model) and that these random numbers do not depend on the waiting times since here  $\mathcal{S}_\alpha$  is fixed. Hence statistics of these visitation numbers are determined by simple binomial random walks.

The Laplace  $\tau \rightarrow u$  transform of a rather general wait-

ing time PDF is in the small  $u$  limit

$$\hat{\psi}(u) = 1 - Au^\alpha + Bu^\beta + \dots \quad (67)$$

where as mentioned  $0 < \alpha < 1$ ,  $A > 0$  and  $\beta > \alpha$ . The goal is to show that when  $\mathcal{S}_\alpha \rightarrow \infty$  parameters like  $B$  and  $\beta$  are not important. To see this insert Eq. (67) in Eq. (66) and find

$$\langle e^{-u\eta} \rangle = \Pi_{x=-\infty}^{\infty} \left[ 1 - A \frac{(n_x)^\alpha}{(\mathcal{S}_\alpha)} u^\alpha + B \frac{(n_x)^\beta}{(\mathcal{S}_\alpha)^{\beta/\alpha}} u^\beta + \dots \right]. \quad (68)$$

This can be rewritten as

---

$$\langle e^{-u\eta} \rangle = 1 - Au^\alpha + \sum_{x=-\infty}^{\infty} \sum_{y=-\infty, y \neq x}^{\infty} \frac{A^2 (n_x)^\alpha (n_y)^\alpha}{2 (\mathcal{S}_\alpha)^2} u^{2\alpha} + B \frac{\sum_{x=-\infty}^{\infty} (n_x)^\beta}{(\mathcal{S}_\alpha)^{\beta/\alpha}} u^\beta + \dots \quad (69)$$

We note that

$$\sum_{x=-\infty}^{\infty} \sum_{y=-\infty, y \neq x}^{\infty} (n_x)^\alpha (n_y)^\alpha = \sum_{x=-\infty}^{\infty} \sum_{y=-\infty}^{\infty} (n_x)^\alpha (n_y)^\alpha - \sum_{x=-\infty}^{\infty} (n_x)^{2\alpha} = (\mathcal{S}_\alpha)^2 - \mathcal{S}_{2\alpha}, \quad (70)$$

hence

$$\langle e^{-u\eta} \rangle = 1 - Au^\alpha + \frac{A^2 (\mathcal{S}_\alpha)^2 - \mathcal{S}_{2\alpha}}{2 (\mathcal{S}_\alpha)^2} u^{2\alpha} + B \frac{\mathcal{S}_\beta}{(\mathcal{S}_\alpha)^{\beta/\alpha}} u^\beta + \dots \quad (71)$$

We use  $\mathcal{S}_{2\alpha}/(\mathcal{S}_\alpha)^2 \rightarrow 0$  which is justified at the end of this Appendix and hence

$$\frac{(\mathcal{S}_\alpha)^2 - \mathcal{S}_{2\alpha}}{(\mathcal{S}_\alpha)^2} \rightarrow 1 \quad (72)$$

when  $\mathcal{S}_\alpha \rightarrow \infty$ . Similarly  $\mathcal{S}_\beta/(\mathcal{S}_\alpha)^{\beta/\alpha} \rightarrow 0$  for  $\alpha < \beta$ . Summarizing we find

$$\langle e^{-\eta u} \rangle \sim 1 - Au^\alpha + \frac{A^2 u^{2\alpha}}{2} + \dots = e^{-Au^\alpha} \quad (73)$$

The parameters  $B$  and  $\beta$  are unimportant. Further for a typical path there is no trace of the random variables  $\{n_x\}$  in the final expression Eq. (73). The latter Eq. implies that the PDF of  $\eta$  is a one side Lévy PDF as stated in Eq. (17).

To better estimate the convergence to this law we use a result obtained in Appendix C. There we show that for a binomial random walk with  $s$  steps we have

$$\langle \mathcal{S}_\alpha \rangle = \mathcal{C}_\alpha s^{(1+\alpha)/2} \quad (74)$$

where  $\mathcal{C}_\alpha$  is a constant Eq. (90). We then assume the following relation to hold

$$\mathcal{S}_\alpha = r s^{(1+\alpha)/2} \quad (75)$$

---

where  $r$  is a random variable which is independent of the number of steps  $s$ . Since in the QTM jumps to nearest neighbors have probability 1/2 like the binomial random walk and since the statistics of the visitations numbers  $\{n_x\}$  are independent of the waiting times (for fixed  $\mathcal{S}_\alpha$ ) we may use Eq. (74) derived for the binomial random walk to analyze the QTM. We have  $\mathcal{S}_{2\alpha} \propto s^{(1+2\alpha)/2}$  and hence  $\mathcal{S}_{2\alpha} \propto (\mathcal{S}_\alpha)^{(1+2\alpha)/(1+\alpha)}$  so  $\mathcal{S}_{2\alpha}/(\mathcal{S}_\alpha)^2 \propto (\mathcal{S}_\alpha)^{-1/(1+\alpha)}$  which goes to zero in the scaling limit  $\mathcal{S}_\alpha \rightarrow \infty$  as we stated. Similarly  $\mathcal{S}_\beta/(\mathcal{S}_\alpha)^{\beta/\alpha} \propto s^{(1+\beta)/2}/s^{\beta(1+\alpha)/2\alpha} = s^{(\alpha-\beta)/(2\alpha)}$  which approaches zero since  $\alpha < \beta$ .

### XIII. APPENDIX C

We consider a binomial random walk on a one dimensional lattice. Time  $s$  is discrete  $s = 0, 1, 2, \dots$  and the particle has probability one half to jump to its nearest neighbors on its left or right. The walk starts on the origin  $x = 0$ . We now calculate the average  $\langle \mathcal{S}_\alpha \rangle$  for an  $s$  step random walk. For that aim we obtain  $\langle (n_x)^\alpha \rangle$  and

then sum over  $x$

$$\langle \mathcal{S}_\alpha \rangle = \sum_{x=-\infty}^{\infty} \langle (n_x)^\alpha \rangle. \quad (76)$$

We consider this problem in the continuum limit of the model, namely we consider Brownian motion (see details below). Thus our final expression for  $\langle \mathcal{S}_\alpha \rangle$  describes the limit of large  $s$ .

Let  $P_{s,x}(n_x)$  be the probability of making  $n_x$  visits on lattice point  $x$  in the time interval  $(0, s)$ . As usual in these problems the Laplace transform

$$\hat{P}_{u,x}(n_x) = \int_0^\infty e^{-us} P_{s,x}(n_x) ds. \quad (77)$$

is useful. Here we already started taking the continuum limit, since in the discrete time random walk  $s$  is not a continuous variable. We avoid a formal transition from a discrete random walk to the continuum limit, to save space and time.

For a random walk starting on the origin let  $\tau$  be the first time the particle reaches lattice point  $x$  and  $f_x(\tau)$  its PDF.  $\tau$  is a first passage time for an unbiased random walk and its distribution is well known [31]. From symmetry  $f_{-x}(\tau) = f_x(\tau)$ . The number of visits on lattice point  $x$ ,  $n_x$ , is determined by a first passage time from the origin to point  $x$ , and then by the probability to revisit point  $x$ . Due to translation symmetry of the random walk the probability of  $n_x - 1$  revisits to a lattice point  $x$ , in a time interval  $s - \tau$  (once reaching that point at  $\tau$ ) is identical to the probability of  $n_x - 1$  visits on the origin (starting on the origin) within the same time interval. Hence translation symmetry gives

$$P_{s,x}(n_x) = \int_0^s f_x(\tau) P_{s-\tau,0}(n_x - 1) d\tau. \quad (78)$$

Using convolution theorem  $\hat{P}_{u,x}(n_x) = f_x(u) \hat{P}_{u,0}(n_x - 1)$ . Here  $P_{s,0}(n_0)$  is the probability to visit the origin  $n_0$  times in the time interval  $(0, s)$ .

For the origin  $x = 0$  we have

$$\hat{P}_{u,x=0}(n_0) = \begin{cases} \frac{1-\hat{f}_1(u)}{u} & n_0 = 0 \\ \hat{f}_1(u) n_0 \frac{1-\hat{f}_1(u)}{u} & n_0 \neq 0. \end{cases} \quad (79)$$

Here  $\hat{f}_1(u)$  is the Laplace transform of  $f_1(\tau)$ . To reason for Eq. (79) note that if  $n_0 = 0$  we have  $P_{s,x=0}(n_0 = 0) = 1 - \int_0^s f_1(\tau) d\tau$  which is the probability of not returning to the origin. To see this note that after one jump the particle is either on  $x = 1$  or  $x = -1$  and hence for  $n_0$  to remain zero the particle must not return to origin (of-course  $f_1(\tau)$  is the PDF of first passage times from  $x = 1$  or  $x = -1$  to the origin). Applying the convolution theorem of Laplace transform to  $P_{s,x=0}(n_0 = 0) = 1 - \int_0^s f_1(\tau) d\tau$  we get the first line in Eq. (79). Note that the original stay on the origin; at time  $s = 0$ , is not counted so we may have  $n_0 = 0$  once the particle

never returns to origin. The probability that  $n_0 = 1$  is given by

$$P_{s,1}(n_0 = 1) = \int_0^s f_1(\tau) P_{s-\tau,0}(n_0 = 0) d\tau. \quad (80)$$

Again using the convolution theorem we find Eq. (79) for  $n_0 = 1$ . Similarly for  $n_0 > 1$ . Using Eq. (78) it is easily shown that for  $x \neq 0$

$$\hat{P}_{u,x}(n_x) = \begin{cases} \frac{1-\hat{f}_x(u)}{u} & n_x = 0 \\ \hat{f}_x(u) \hat{f}_1(u)^{n_x-1} \frac{1-\hat{f}_1(u)}{u} & n_x \neq 0. \end{cases} \quad (81)$$

The Laplace transform of the first passage time PDF is

$$\hat{f}_x(u) = \exp\left(-\sqrt{2}xu^{1/2}\right). \quad (82)$$

The  $\sqrt{2}$  comes from the fact that the diffusion constant is equal  $1/2$ , since the variance of jump lengths is unity. In time  $\tau$ ,  $f_x(\tau)$  is the one sided Lévy PDF with index  $1/2$  [see Eq. (64)] and  $f_x(\tau) \sim \tau^{-3/2}$  as well known [31].

We now calculate  $\langle (n_0)^\alpha \rangle_u$ : the Laplace transform of  $\langle (n_0)^\alpha \rangle_s$

$$\langle (n_0)^\alpha \rangle_u = \int_0^\infty (n_0)^\alpha \hat{P}_{u,0}(n_0) dn_0 \quad (83)$$

where the integration (instead of summation) implies that we are considering the continuum limit of the random walk (i.e. Brownian motion). Inserting in Eq. (83) Eqs. (79,82) we find

$$\langle (n_0)^\alpha \rangle_u \sim \left(\frac{1}{\sqrt{2}}\right)^\alpha \Gamma(1 + \alpha) u^{-1-\frac{\alpha}{2}}, \quad (84)$$

which is valid for small  $u$  corresponding to large  $s$ . Using Eqs. (81,82) we get the  $\alpha$  moment of the visitation number for lattice point  $x$

$$\langle (n_x)^\alpha \rangle_u = e^{-x\sqrt{2}u^{1/2}} \Gamma(1 + \alpha) \left(\frac{1}{\sqrt{2}}\right)^\alpha u^{-1-\alpha/2}. \quad (85)$$

Notice that  $\langle (n_x)^\alpha \rangle_u \sim \hat{f}_x(u) \langle (n_0)^\alpha \rangle_u$  reflecting the first arrival at  $x$  and the translation symmetry of the lattice.

Denote  $\langle \mathcal{S}_\alpha \rangle_u$  as the Laplace  $s \rightarrow u$  transform of  $\langle \mathcal{S}_\alpha \rangle_s$ . In the Brownian limit we replace the summation in Eq. (76) with integration

$$\langle \mathcal{S}_\alpha \rangle_u = 2 \int_0^\infty \langle (n_x)^\alpha \rangle_u dx, \quad (86)$$

and with the help of Eq. (85)

$$\langle \mathcal{S}_\alpha \rangle_u \sim \sqrt{2}^{1-\alpha} \Gamma(1 + \alpha) u^{-3/2-\alpha/2}. \quad (87)$$

Using the Laplace pair

$$u^{-\frac{3+\alpha}{2}} \rightarrow \frac{s^{\frac{\alpha+1}{2}}}{\Gamma\left(\frac{\alpha+3}{2}\right)}, \quad (88)$$

we find with simple identities for the Gamma function [61], the main result of this Appendix

$$\langle \mathcal{S}_\alpha \rangle = \mathcal{C}_\alpha s^{\frac{1+\alpha}{2}} \quad (89)$$

with

$$\mathcal{C}_\alpha = \frac{2^{\frac{\alpha+3}{2}} \Gamma(1 + \frac{\alpha}{2})}{\sqrt{\pi}(1 + \alpha)}. \quad (90)$$

For  $\alpha = 1$  we have  $\mathcal{S}_1 = \sum_{x=-\infty}^{\infty} n_x = s$  a result that is retrieved from Eq. (89) since  $\mathcal{C}_1 = 1$ . In the limit  $\alpha = 0$  we have  $\mathcal{S}_0$  equal to the span of the random walk, namely to the number of distinct sites visited by the walker. As mentioned in the main text, in this limit we retrieve Eq. (26) found a long time ago in [60].

#### XIV. APPENDIX D

Here we investigate the function  $g_\alpha(\xi)$  in the limit where  $\alpha < 1$  is close to unity with the Gaussian approximation for  $B_\alpha(z)$ . Changing variables in Eq. (49) according to  $\mathcal{S}_\alpha = t^\alpha \eta^{-(1+\alpha)/2}$  we find using the definition in Eq. (29)

$$g_\alpha(\xi) = \frac{(\mathcal{C}_\alpha)^{1/(1+\alpha)}}{\sqrt{2\pi}} \frac{1+\alpha}{2\alpha} \int_0^\infty e^{-u\eta} \eta^{1/(2\alpha)} l_{\alpha,1,1}(\eta^{(1+\alpha)/(2\alpha)}) d\eta \quad (91)$$

where

$$u = \xi^2 (\mathcal{C}_\alpha)^{2/(1+\alpha)} / 2. \quad (92)$$

Eq. (91) is a Laplace transform. Inserting in Eq. (91)  $\xi = 0$ , changing variables according to  $y = \eta^{(1+\alpha)/(2\alpha)}$  and using Eq. (31) we get  $g_\alpha(\xi = 0)$  Eq. (56). The small  $u$  limit (corresponding to small  $\xi$ ) of Eq. (91) is controlled by the large  $\eta$  behavior of

$$\eta^{1/(2\alpha)} l_{\alpha,1,1}(\eta^{(1+\alpha)/(2\alpha)}) \sim \frac{\sin \pi \alpha}{\pi} \Gamma(1 + \alpha) \eta^{-1-\alpha/2} \quad (93)$$

where we used the large  $\eta$  expansion of stable PDFs Eq. (61). Using the Tauberian theorem, noting that  $u^{\alpha/2}$  and  $\eta^{-(1+\alpha/2)}/|\Gamma(-\alpha/2)|$  are Laplace pairs, Eqs. (91,93) together with some identities of the Gamma function [61] give Eq. (55).

In the opposite limit of large  $\xi$  (i.e. large  $u$ ) we use the small  $\eta$  behavior of  $\eta^{1/(2\alpha)} l_{\alpha,1,1}(\eta^{(1+\alpha)/(2\alpha)})$  in Eq. (91). For that aim we use the small  $\eta$  behavior of one sided stable PDFs Eq. (62). We get

$$g_\alpha(\xi) = \bar{C} \int_0^\infty e^{-u\eta} \eta^{-\gamma} e^{-\kappa \eta^{-\delta}} d\eta \quad (94)$$

where  $\kappa$  is defined in Appendix B Eq. (63),

$$\gamma = \frac{3-\alpha}{4(1-\alpha)}, \quad \delta = \frac{1+\alpha}{2(1-\alpha)}$$

$$\bar{C} = B \frac{(\mathcal{C}_\alpha)^{1/(1+\alpha)}}{\sqrt{2\pi}} \frac{1+\alpha}{2\alpha} \quad (95)$$

and  $B$  is defined in Eq. (63).

We now use steepest descent method. Let  $h(\eta) = u\eta + \kappa \eta^{-\delta}$ . The extremum is on  $\eta_e$  which is determined usual from  $\partial h / \partial \eta = 0$  so  $\eta_e = (u/\kappa \delta)^{-1/(1+\delta)}$ . Using the expansion

$$h(\eta) = h(\eta_e) + \frac{1}{2} \kappa \delta (\delta + 1) (\eta_e)^{-\delta-2} \Delta^2 + \dots \quad (96)$$

where  $\Delta = \eta - \eta_e$  is small. We then have after extending the domain of integration

$$g_\alpha(\xi) \sim$$

$$\bar{C} (\eta_e)^{-\gamma} e^{-h(\eta_e)} \int_{-\infty}^{\infty} \exp[-\delta(1+\delta)\kappa(\eta_e)^{-\delta-2}\Delta^2/2] d\Delta. \quad (97)$$

Solving this Gaussian integral

$$g_\alpha(\xi) = \tilde{C} u^{-\mu} e^{-\bar{\kappa} u^{\delta/(1+\delta)}}, \quad (98)$$

where  $\tilde{C} = \bar{C} \sqrt{2\pi} [\delta(1+\delta)\kappa]^{-1/2} (\kappa \delta)^\mu$ ,  $\bar{\kappa} = (\kappa \delta)^{1/(1+\delta)} + \kappa (\kappa \delta)^{-\delta/(\delta+1)}$  and  $\mu = (1-\alpha)/(3-\alpha)$ . Changing back to the variable  $\xi$  (instead of  $u$ ) using Eq. (92) we get Eq. (58)

$$g_\alpha(\xi) =$$

$$\tilde{C} \left[ \frac{\xi^2 (\mathcal{C}_\alpha)^{\frac{2}{1+\alpha}}}{2} \right]^{-\mu} \exp \left\{ -\bar{\kappa} \left[ \frac{(\mathcal{C}_\alpha)^{\frac{2}{1+\alpha}} \xi^2}{2} \right]^{\frac{1+\alpha}{3-\alpha}} \right\}. \quad (99)$$

To prepare for the limit  $\alpha \rightarrow 1$  we rewrite

$$\tilde{C} = (\mathcal{C}_\alpha)^{\frac{1}{1+\alpha}} \frac{1+\alpha}{2\alpha} \frac{B}{\sqrt{\delta(1+\delta)} \kappa}. \quad (100)$$

Using  $\lim_{\alpha \rightarrow 1} \mathcal{C}_\alpha = 1$ ,

$$\lim_{\alpha \rightarrow 1} \frac{B}{\sqrt{\delta(1+\delta)} \kappa} = \frac{1}{\sqrt{2\pi}} \quad (101)$$

and  $\lim_{\alpha \rightarrow 1} \bar{\kappa} = 1$  we find the expected Gaussian behavior Eq. (59). Rewriting

$$g_\alpha(\xi) \sim b_1 \xi^{-2\frac{1-\alpha}{3-\alpha}} e^{-b_2 \xi^{2\frac{1+\alpha}{3-\alpha}}} \quad (102)$$

when  $\xi \gg 1$  with  $b_1 = \sqrt{(1+\alpha)/[2\pi\alpha(3-\alpha)]} D$ ,  $b_2 = [(3-2\alpha)/2] D^2$  and  $D = [(1+\alpha)^{1-\alpha} \alpha^\alpha \mathcal{C}_\alpha]^{1/(3-\alpha)}$ .

- 
- [1] H. Scher, E. W. Montroll *Phys. Rev. B* **12** 2455 (1975).
- [2] M. F. Shlesinger *J. Stat. Phys.* **10** 421 (1974).
- [3] J. Klafter, and R. Silbey *Phys. Rev. Lett.* **44** 55 (1980).
- [4] H. Scher, M. F. Shlesinger, and J. T. Bendler *Physics Today* **44** 26 January (1991)
- [5] B. Berkowitz, A. Cortis, M. dentz, and H. Scher *Review of Geophysics* **40** RG2003 49 (2006).
- [6] J. P. Bouchaud, *J. Phys.* I France **2**, 1705 (1992).
- [7] C. Monthus and J.-P. Bouchaud, *J. Phys. A* **29**, 3847 (1996).
- [8] For a recent review see: L. Berthier, G. Biroli *Rev. Mod. Phys.* **83** 587 (2011).
- [9] R. Metzler, J. Klafter, *Phys. Rep.* **339**, 1 (2000).
- [10] S. Burov, E. Barkai, *Phys. Rev. Lett.* **98** 250601 (2007).
- [11] T. Miyaguchi, and T. Akimoto *Phys. Rev. E* **83**, 031926 (2011).
- [12] G. Bel, E. Barkai *Phys. Rev. Lett.* **94** 240602 (2005).
- [13] F. D. Stefani, J. P. Hoogenboom, and E. Barkai *Beyond Quantum Jumps: Blinking Nano-scale Light Emitters* *Physics Today* **62** nu. 2, p. 34 (February 2009).
- [14] Y. He, S. Burov, R. Metzler, E. Barkai *Physical Review Letters* **101**, 058101 (2008).
- [15] I. M. Sokolov, *Physics* **1**, 8 (2008).
- [16] S. Alexander, J. Bernasconi, W. R. Schneider, and R. Orbach *Rev. of Modern Physics* **53** 175 (1981).
- [17] J. P. Bouchaud, and A. Georges, *Phys. Rep.* **195**, 127 (1990).
- [18] J. P. Bouchaud, A. Comtet, A. Georges, and P. Le Doussal *Annals of Physics* **201** 285 (1990).
- [19] B. D. Hughes *Random Walks and Random Environments* Vol. 2 Clarendon Press Oxford (1996).
- [20] D. S. Fisher, P. Le Doussal and C. Monthus *Phys. Rev. Lett.* **80** 3539 (1998).
- [21] D. ben-Avraham and S. Havlin *Diffusion and Reactions in Fractals and Disordered Systems* Cambridge University Press, Cambridge (2000).
- [22] E. Ben-Naim, and P. L. Krapivsky *Phys. Rev. Lett.* **102** 190602 (2009).
- [23] Y. G. Sinai, *Theory Probab. Appl.* **27** 256 (1983)
- [24] A. O. Golosov. *Commun. Math. Phys.* **92**, 491 (1984).
- [25] H. Kesten, *Physica A* **138**, 299 (1986).
- [26] J. Machta, *J. Phys. A: Math. Gen.* **18** no. 9, L531 (1985).
- [27] S. Alexander *Phys. Rev. B* **23** 2951 (1981).
- [28] G. Ben Arous, G. and J. Cerný, *The Annals of Probability* **35**, 23562384 (2007). G. Ben Arous, J. Cerný, and T. Mountford *Probab. Theory Related Fields* **134**, 143 (2006).
- [29] G. Ben Arous and J. Černý Lecture Notes for Les Houches Summer School Mathematical statistical physics, arXiv:math/0603344 (2008).
- [30] G. H. Weiss, *Aspects and Applications of the Random Walk* North-Holland Amsterdam (1994).
- [31] S. Redner *A Guide to First-Passage Processes* Cambridge University Press (2001).
- [32] C. Monthus *Phys. Rev. E* **68** 036114 (2003).
- [33] R. L. Jack and P. Sollich *J. Stat. Mech.* P11011 (2009).
- [34] A. I. Saichev, and G. M. Zaslavsky *Chaos* **7** 753 (1997).
- [35] E. Barkai *Phys. Rev. E* **63**, 046118 (2001).
- [36] M. M. Meerschaert and H.-P. Scheffler, *J. Appl. Probab.* **41** no. 3, 623638 (2004).
- [37] I. M. Sokolov, and J. Klafter *Chaos* **15**, 026103 (2005).
- [38] S. B. Yutse, and K. Lindenberg *Phys. Rev. E.* **72** 061103 (2005).
- [39] S. Burov, E. Barkai *Phys. Rev. Lett.* **106**, 140602 (2011).
- [40] E. M. Bertin and J. P. Bouchaud, *Phys. Rev. E.* **67** 026128 (2003).
- [41] E. M. Bertin, and J. P. Bouchaud, *Phys. Rev. E* **67**, 065105. (2003).
- [42] J. Orenstein, and M. Kastner *Phys. Rev. Lett.* **46** 1421 (1981).
- [43] W. R. Schneider, in *Stochastic Processes in Classical and Quantum Systems* (Lecture Notes in Physics, vol 262), edited by S. Albeverio, G. Casati, and D. Merlini (Springer, Berlin, 1986).
- [44] G. Samorodnitsky, and M. S. Taqqu *Stable Non-Gaussian Random Processes* Chapman and Hall/CRC (1994)
- [45] K. A. Penson, and K. Gorska *Phys. Rev. Lett.* **105** 210604 (2010).
- [46] R. Metzler, E. Barkai, and J. Klafter, *Phys. Rev. Lett.* **82**, 3563 (1999). E. Barkai, R. Metzler and J. Klafter, *Phys. Rev. E* **61** 132 (2000).
- [47] H. C. Fogedby *Phy. Rev. E* **50** 1657 (1994).
- [48] E. Heinsalu, M. Patriarca, I. Goychuk, G. Schmid, and P. Hänggi *Phys. Rev. E* **73** 046133 (2006). *ibid* *Phys. Rev. Lett.* **99** 120602 (2007).
- [49] M. Magdziarz, A. Weron, and K. Weron *Phys. Rev. E* **75** 016708 (2007).
- [50] M. Magdziarz, A. Weron, and J. Klafter *Phys. Rev. Lett.* **101**, 210601 (2008)
- [51] B. J. West, E. L. Geneston, P. Grigolini *Physics Reports* **468** 1 2008. Note that these authors extend the concept of subordination beyond the Lévy time process considered here.
- [52] S. Eule, R. Friedrich *Europhysics Letters* **86**, 30008 (2009)
- [53] B. Dybiec, and E. Gudowska-Nowak *Chaos* **20** 043129 (2010).
- [54] B. I. Henry, T. A. M. Langlands, P. Straka *Phys. Rev. Lett.* **105**, 170602 (2010).
- [55] O. Zindy, *Markov Processes and Related Fields* **15** 31, (2009).
- [56] M. Dentz and D. Bolster *Phys. Rev. Lett.* **105**, 244301 (2010).
- [57] S. I. Denisov, E. S. Denisova, and H. Kantz *European Physical Journal B* **76** 1 (2010).
- [58] M. Houry, A. M. Lacasta, J. M. Sancho, and K. Lindenberg *Phys. Rev. Lett.* **106**, 090602 (2011).
- [59] J. M. Chambers, C. L. Mallows and B. W. Stuck *J. of the American Statistical Association* **71** (354) 340 (1976).
- [60] A. Dvoretzky and E. Erdős in Proc. 2nd Berkeley Symp. Math. Stat. and Prob. (University of California Press) 33 (1951). See also: E. W. Montroll and B. J. West, *On an Enriched Collection of Stochastic Processes* in Fluctuation Phenomena E. W. Montroll and J. L. Lebowitz editors North Holland Publishing Company (1979).
- [61] *Handbook of Mathematical Functions* M. Abramovitz and I. A. Stegun Editors Dover Publications New York 1972.