

Performances of silicone coated high resistive bakelite RPC

S. Biswas^{a,*}, Purba Bhattacharya^b, S. Bhattacharya^b, S. Bose^b, S. Chattopadhyay^a, N. Majumdar^b,
S. Mukhopadhyay^b, S. Saha^b, Y.P. Vijoyi^a

^a Variable Energy Cyclotron Centre, 1/AF Bidhan Nagar, Kolkata-700 064, India

^b Saha Institute of Nuclear Physics, 1/AF Bidhan Nagar, Kolkata-700 064, India

Abstract

Performances of several single gap (gas gap 2 mm) prototype Resistive Plate Chambers (RPC) made of high resistive ($\rho \sim 10^{10}$ - 10^{12} Ω cm) bakelite, commercially available in India have been studied in recent times. To make the inner electrode surfaces smooth, a thin coating of silicone has been applied. An efficiency $> 90\%$ and time resolution ~ 2 ns (FWHM) have been obtained for both the streamer and the avalanche mode. The induced charge distributions of those silicone coated RPC are studied and the results are presented. A numerical study on the effect of surface roughness of the resistive electrodes on the electric field of the device has been carried out using Garfield-neBEM code. A few results for a simplified model representing surface roughness, measured using a surface profilometer for the bakelite surfaces, have also been presented.

Key words: RPC; Streamer mode; Avalanche mode; Bakelite; Cosmic rays; Silicone; Charge distribution; Garfield-neBEM; Roughness
PACS: 29.40.Cs

1. Introduction

High resistive ($\rho \sim 10^{10}$ - 10^{12} Ω cm) bakelite RPCs [1], prepared with a silicone compound coating on the inner electrode surfaces, were studied in a cosmic ray test bench to characterize its long term stability of operation [2]. Need for the silicone compound coating had been illustrated through the measurement of variation of efficiency with applied high voltage (HV) in our earlier work [2]. Study of variation of time resolution and cross-talk between neighbouring pick-up strips with applied HV were also reported earlier [3,4]. Such high resistive electrode-based RPCs are being explored as active elements of a large scale iron calorimeter for the proposed India-based Neutrino Observatory (INO) [5].

One of the limitations of the streamer mode operation of high resistive bakelite RPCs is that the rate handling capability is relatively worse than that in the avalanche mode. For the same energetic particle falling on the RPC, the charge content contributing to the resulting pulses in the two modes differ by orders of magnitude. This, as well as the physical extent of the streamer and the electron avalanche,

may result in variation of the pulse timing properties. These aspects need to be studied both through experiment and through simulation.

Stability of operation of the RPCs and its dependence on the detector parameters are the other important aspects which need to be studied in detail. It is established that a rough inner electrode surface of an RPC is prone to cause field emission, which is a source of high dark current [6]. In this context, it is relevant to investigate the effect of surface roughness on the detector dynamics. It is conceivable that imperfections on the bakelite surface may be responsible to cause local non-uniformity of the electric field. Depending upon their shape and size, they may often lead to discharge severely degrading the performance of the device.

In this article, some experimental results on operation of our bakelite RPC in the avalanche mode, systematic studies and comparison of charge contents of the resulting pulses in the avalanche mode and the streamer mode operation of the same RPCs are reported. In our endeavor of corroboration of experimental results with simulation, preliminary results of numerical simulation of the effect of roughness of the resistive bakelites on the field configuration are also reported. Using Garfield-neBEM [7,8] code, the field calculation has been done for several models designed on the basis of measurements of the bakelite surface profiles [2].

* *Email address:* saikatb@veccal.ernet.in (S. Biswas).

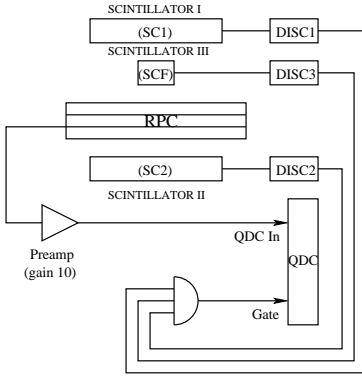

Fig. 1. Schematic representation of the charge spectrum measurement setup. Phillips Scientific 7186 Charge to Digital Converter (QDC) was used.

2. Test setup

All the RPCs were tested in a cosmic ray test bench described in Ref. [2]. The cosmic ray telescope was constructed using three scintillators, two placed above the RPC and one below. Triple coincidence of the signals, obtained from these three scintillators was used to select a cosmic ray event (master trigger). The signals obtained from the pick-up strips were put in coincidence with the master trigger obtained as above. This is referred to as the coincidence trigger. Finally, the efficiency was calculated as the ratio of the coincidence trigger to the master trigger.

Premixed gas of argon, isobutane and tetrafluoroethane (R-134a) in the volume ratio of 55/7.5/37.5 (equivalent to a mass mixing ratio of 34/7/59) was used in the streamer mode, while in the avalanche mode, R-134a/isobutane in 95/5, R-134a/isobutane/SF₆ in 95/4.5/0.5 and 95/2.5/2.5 volume mixing ratio were used. A typical flow rate of 0.4 ml per minute was maintained by the gas delivery system [9], resulting in ~ 3 changes of gas gap volume per day.

Charge content of the pulses were measured using a charge to digital converter, referred to as QDC. The set-up is shown in Fig. 1, which is very similar to that used in Ref. [10]. The master trigger gate of width 1.5 μ s was also used as gate to the QDC. It was observed that the charge spectrum and the measured mean charge were independent of gate width over a range of 150 ns to 1.5 μ s. The pulse height in the streamer mode was noted to be a few hundred mV, while that in the avalanche mode was found to be < 10 mV. A 10 \times voltage pre-amplifier was used for the avalanche mode operation of the RPCs.

3. Results

In the avalanche mode, the RPCs were tested using different gas mixtures mentioned as above. The efficiency and time resolution of the RPCs were studied by varying the applied HV. The efficiency plateau was obtained at $> 90\%$ for all the gas mixtures, and it was found to be marginally higher for gas mixtures containing less amount of SF₆. At

the plateau region, the time resolution was found to be ~ 2.5 ns (FWHM) and the average signal arrival time decreased with the increase of HV, which is a common feature of any gas filled detector.

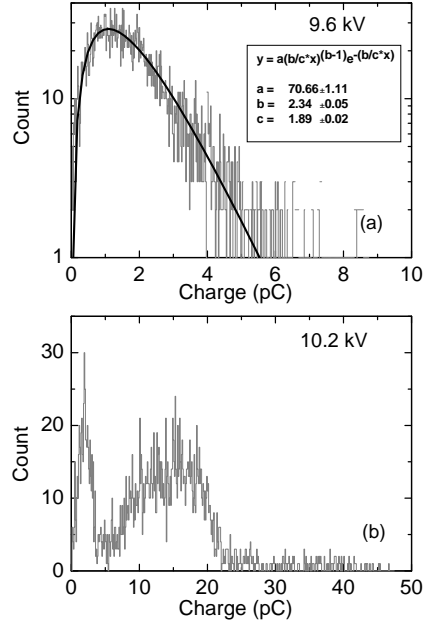

Fig. 2. The charge spectrum of the RPC operated in the avalanche mode using the gas mixture of R-134a/isobutane/SF₆ in 95/4.5/0.5 ratio, at two different high voltages.

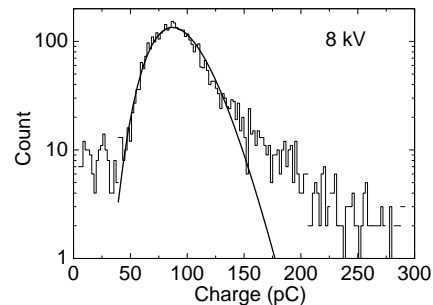

Fig. 3. The charge distribution spectrum in the streamer mode with a gas mixture of Argon/isobutane/R-134a in 55/7.5/37.5 ratio.

In Fig. 2 (a), a typical charge spectrum of the RPC operated in the avalanche mode (HV = 9.6 kV) using the gas mixture of R-134a/isobutane/SF₆ in 95/4.5/0.5 ratio, together with the Polya distribution fitting curve is shown. At higher HV values, a streamer peak appears after the avalanche as shown in Fig. 2 (b). The charge distribution spectrum in the streamer mode with a gas mixture of Ar, isobutane and R-134a in 55/7.5/37.5 ratio is shown in Fig. 3. Corresponding best-fit Polya distribution curve to the streamer charge spectrum is also shown in the same plot. It is clear that the fitted curve underpredicts the pulse charge content at the higher charge tail of the spectrum.

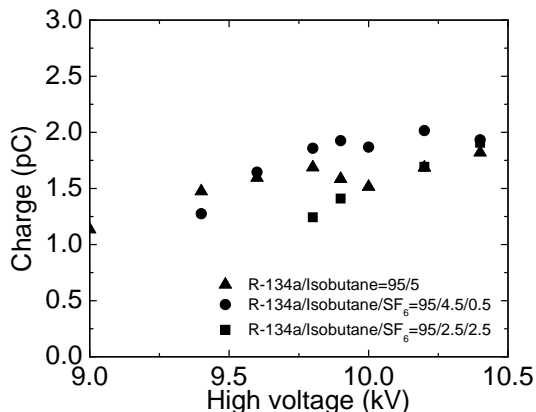

Fig. 4. The induced charge as a function of HV for a silicone coated RPC in the avalanche mode using three different gas mixtures.

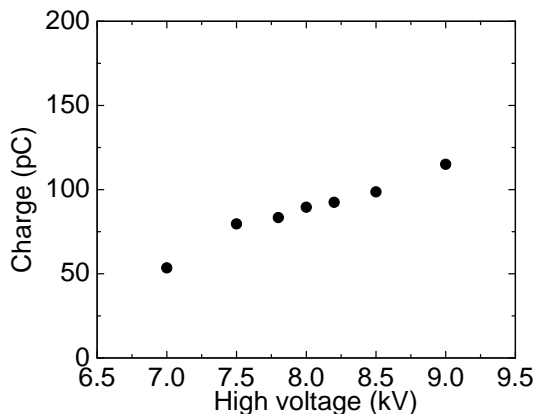

Fig. 5. The induced charge as a function of HV for a silicone coated RPC in the streamer mode with a gas mixture of Argon/isobutane/R-134a in 55/7.5/37.5 ratio.

100 This possibly indicates the onset of a breakdown mechanism responsible for the excess streamer charge beyond that
 101 can be predicted by the clustering model.

102
 103 The induced charge as a function of the applied HV in
 104 the avalanche mode is shown in Fig. 4, whereas that in
 105 the streamer mode is shown in Fig. 5. For the RPC, when
 106 operated in the avalanche mode with the gas mixtures of
 107 R-134a/isobutane in 95/5 and R-134a/isobutane/SF₆ in
 108 95/4.5/0.5 ratio it was observed that at higher voltages a
 109 substantial streamer peak appears. But the charge shown
 110 in Fig. 4 is the mean charge of the avalanche peak only. It
 111 is clear from the figures that the charge saturates at ~ 1-
 112 2 pC in the avalanche mode for all the gas compositions,
 113 while in the streamer mode, the charge is ~ 100 pC.

114 4. Surface roughness and its effect on the electric 115 field

116 A preliminary calculation of the electric field to simulate
 117 the effect of surface roughness in bakelite RPC has been

118 done as a proof of concept. The surface profile of the bakelite
 119 sheet (Grade P120) has been studied using a DEKTAK
 120 117 profilometer which sampled 2500 times over a small
 121 span of 5 cm at three arbitrary locations. Fig. 6 shows the
 122 measurement taken at one of these locations where a least
 123 square fit has been done in order to define the baseline of the
 124 surface. In Fig. 6 the residuals of the data with respect to
 125 the baseline are depicted as well to indicate the amplitudes
 of the roughness. The amplitudes of one such measurement

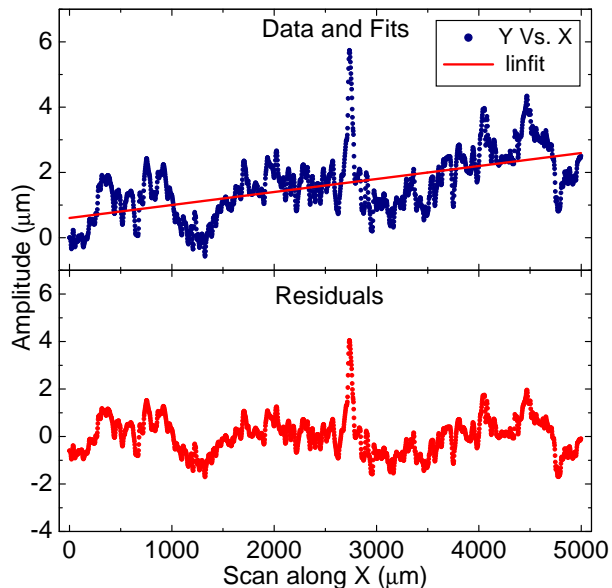

Fig. 6. A typical surface profile of bakelite P120 measured with DEKTAK 117 profilometer. The least square fit to the data and the residuals w.r.t the fit are shown.

126
 127 is represented in histogram as shown in Fig. 7. It can be
 128 found that the maximum amplitudes of the roughness in
 129 positive (upward) and negative (downward) directions can
 130 be of the order of 4 μm and 2 μm, respectively.

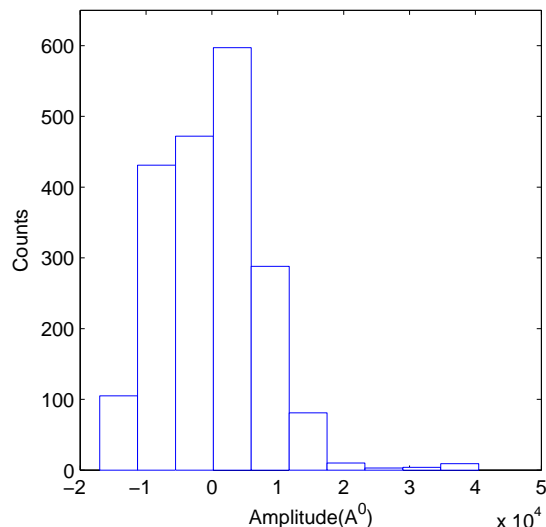

Fig. 7. Histogram of amplitudes with a maximum of 4 μm.

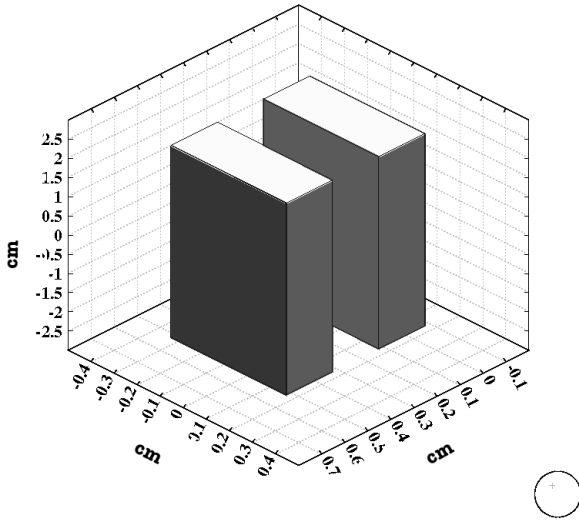

Fig. 8. The model RPC considered in the calculation.

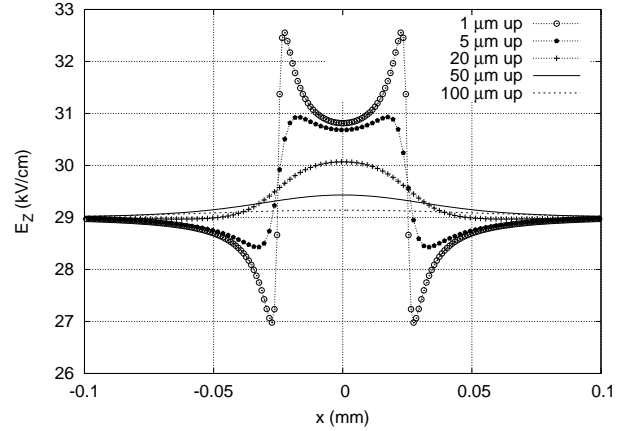

Fig. 9. Variation of electric field with distance away from the positive roughness.

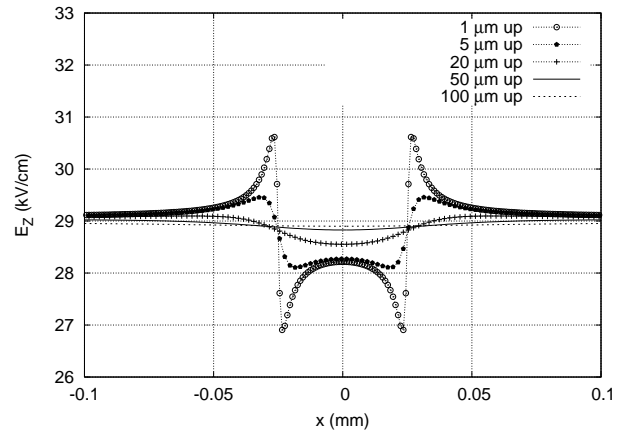

Fig. 10. Variation of electric field with distance near the negative roughness.

131 For studying the effect of roughness, a device has been
 132 modeled following the geometry of an RPC. The device
 133 comprises of two bakelite slabs, each with thickness 2 mm
 134 (in Z-direction). A gas layer of the same height is inter-
 135 posed between. A fine layer of graphite with thickness 20
 136 μm has been considered on other sides of the bakelites. The
 137 overall dimension of the RPC has been taken to be 5 mm
 138 (in X-direction) \times 50 mm (in Y-direction). Fig. 8 depicts
 139 the model described above. The roughness has been added
 140 to one of the bakelite surface by building up a tiny struc-
 141 ture with dimensions corroborated by the measurements.
 142 Two such structures have been introduced to represent the
 143 surface roughness with positive and negative amplitudes.
 144 For the preliminary calculation, the shape of the roughness
 145 has been considered as a rectangular ridge stretched along
 146 the whole length of the device in Y-direction, i.e. 50 mm,¹⁶⁵
 147 with height either 4 μm (in positive Z-direction) or 2 μm
 148 (in negative Z-direction). The cross-section of the base of
 149 the ridge has been taken to be 50 μm \times 50 mm.¹⁶⁷

150 The electric field (Z-component) has been evaluated at
 151 several positions with respect to the top edge of the struc-
 152 ture for the positive roughness as shown in Fig. 9. It can
 153 be noticed that a change of about 12% in the field value is
 154 possible within 1 μm from the structure. The distortion in
 155 the field due to the structure diminishes with the distance
 156 and it takes more than 100 μm to get nullified.¹⁷⁴

157 The same calculation has been carried out for the model
 158 with negative roughness. The results are illustrated in
 159 Fig. 10. Here the maximum change is about 5% at the
 160 closest vicinity of 1 μm from the bakelite surface which is
 161 3 μm away from the base of the roughness ridge. It may
 162 inflate upto approximately 7-8% when studied at just 1 μm
 163 above the base. Here, obviously the effect of the roughness
 164 dies down within 100 μm from the bakelite surface.¹⁸²

5. Conclusions and outlook

Systematic studies on the performances of the silicone coated bakelite RPCs were performed both in the streamer and the avalanche mode. An efficiency $> 90\%$ and time resolution ~ 2 ns (FWHM) were obtained in both the modes of operation. The measured induced charges on the RPC pick-up strips were found to be 1-2 pC in the avalanche mode, and ~ 100 pC in case of the streamer mode of operation. The preliminary calculation proves that the minute structures with straightforward shape on the bakelite surface do affect the field configuration by 5 - 12 % depending on its height or depth in its close proximity. It indicates that the structures with different shapes and sizes may be significant in distorting the nearby field configuration. A detailed study on the roughness structures is therefore required, corroborated by precise measurements to advance the investigation on the effect of roughness on the performance of the RPC.

183 **6. Acknowledgement**

184 We acknowledge the service rendered by Mr. Ganesh Das
185 of VECC for meticulously fabricating the detectors and
186 Mr. Chandranath Marick of SINP for making some of the
187 related electronic circuits.

188 **References**

- 189 [1] R. Santonico, R. Cardarelli, Nucl. Instr. and Meth. 187 (1981)
190 377.
- 191 [2] S.Biswas, et al., Nucl. Instr. and Meth. A 602 (2009) 749.
- 192 [3] S.Biswas, et al., Nucl. Instr. and Meth. A 617 (2010) 138.
- 193 [4] S.Biswas, et al., Nucl. Instr. and Meth. A 604 (2009) 310.
- 194 [5] INO Project Report, INO/2006/01, June 2006,
195 <http://www.imsc.res.in/~ino/>.
- 196 [6] Changguo Lu, Nucl. Instr. and Meth. A 602 (2009) 761.
- 197 [7] <http://garfield.web.cern.ch>
- 198 [8] <http://nebem.web.cern.ch>
- 199 [9] S.Bose, et al., Nucl. Instr. and Meth. A 602 (2009) 839.
- 200 [10] C. Lu, SNIC Symposium, Stanford, California -3-6 April 2006.