

Pion-Exchange and Fermi-Motion Effects on the Proton-Deuteron Drell-Yan Process

H. Kamano¹ and T.-S. H. Lee²

¹*Research Center for Nuclear Physics,*

Osaka University, Ibaraki, Osaka 567-0047, Japan

²*Physics Division, Argonne National Laboratory, Argonne, Illinois 60439, USA*

Abstract

Within a nuclear model that the deuteron has NN and πNN components, we derive convolution formula for investigating the Drell-Yan process in proton-deuteron (pd) reactions. The contribution from the πNN component is expressed in terms of a pion momentum distribution that depends sensitively on the πNN form factor. With a πNN form factor determined by fitting the πN scattering data up to invariant mass $W = 1.3$ GeV, we find that the pion-exchange and nucleon Fermi-motion effects can change significantly the ratios between the proton-deuteron and proton-proton Drell-Yan cross sections, $R_{pd/pp} = \sigma^{pd}/(2\sigma^{pp})$, in the region where the partons emitted from the target deuteron are in the Bjorken $x_2 \gtrsim 0.4$ region. The calculated ratios $R_{pd/pp}$ at 800 GeV agree with the available data. Predictions at 120 GeV for analyzing the forthcoming data from Fermilab are presented.

PACS numbers: 13.85.Qk, 13.60.Hb, 14.20.Dh, 13.75.Cs

I. INTRODUCTION

Since the asymmetry between the anti-up (\bar{u}) and anti-down (\bar{d}) quark distributions in the proton was revealed by the New Muon Collaboration [1] (NMC), a series of experiments [2–5] on the di-muons ($\mu^+\mu^-$) production from the Drell-Yan [6] (DY) processes in pp and pd collisions had been performed at Fermi National Accelerator Laboratory (Fermilab). The objective was to extract the \bar{d}/\bar{u} ratio of the parton distribution functions (PDFs) in the proton. The information from these experiments and the measurements [1, 7, 8] of deep inelastic scattering (DIS) of leptons from the nucleon have confirmed the NMC’s finding, $\bar{d}/\bar{u} > 1$, only in the region of low Bjorken $x \lesssim 0.35$.

The ratio $\bar{d}/\bar{u} > 1$ signals the nonperturbative nature of the sea of the proton. Its dynamical origins have been investigated [9–23] rather extensively. Precise experimental determination of \bar{d}/\bar{u} for higher $x > 0.35$ is needed to distinguish more decisively these models and to develop a deeper understanding of the the sea of the proton. This information will soon become available from a forthcoming experiment [24] at Fermilab.

In analyzing the DY data on the deuteron [2–5] and nuclei [25–28], it is common to neglect the nuclear effects that are known to be important in analyzing the DIS data. It is well established that the nuclear effect due to the nucleon Fermi motion (FM) can influence significantly the DIS cross sections, in particular in the large x region. It is also known that the contributions from the virtual pions in nuclei must be considered for a quantitative understanding of the parton distributions in nuclear medium. Thus it is interesting and also important to develop an approach to investigate these two nuclear effects on the pd DY process. This is the main purpose of this work. We will apply our formula to analyze the available data at 800 GeV [5] and make predictions for the forthcoming experiment [24].

It is instructive to describe here how the DY data were analyzed, as described in, for example, Ref. [5]. The leading-order DY cross sections from pN collision with $N = p$ (proton), n (neutron) is written as

$$\frac{d\sigma^{pN}}{dx_1 dx_2} = \frac{4\pi\alpha^2}{9M^2} \sum_q \hat{e}_q^2 [f_p^q(x_1) f_N^{\bar{q}}(x_2) + f_p^{\bar{q}}(x_1) f_N^q(x_2)], \quad (1)$$

where the sum is over all quark flavors, \hat{e}_q is the quark charge, $f_N^q(x)$ is the parton distribution of parton q in hadron N , and M is the virtual photon or di-lepton mass. Here x_1 and x_2 are the Bjorken- x of partons from the beam (p) and target (N), respectively (see Sec. V A for explicit definitions of x_1 and x_2). The DY cross section for pd is taken to be

$$\frac{d\sigma^{pd}}{dx_1 dx_2} = \frac{d\sigma^{pp}}{dx_1 dx_2} + \frac{d\sigma^{pn}}{dx_1 dx_2}. \quad (2)$$

Obviously, Eq. (2) does not account for the nucleon Fermi-motion and pion-exchange effects. To make progress, it is necessary to investigate under what assumptions Eqs. (1) and (2) can be derived from a formulation within which these two nuclear effects are properly accounted for.

We start with a nuclear model within which the deuteron wave function has NN and πNN components. Such a model was developed in the study of πNN system [29]. We will derive convolution formula to express the DY cross section in terms of the momentum distributions $\rho(\vec{p})$ calculated from the NN component and $\rho(\vec{k}_\pi)$ from πNN component. Since πNN component is much weaker, it is a good approximation to use the NN component generated

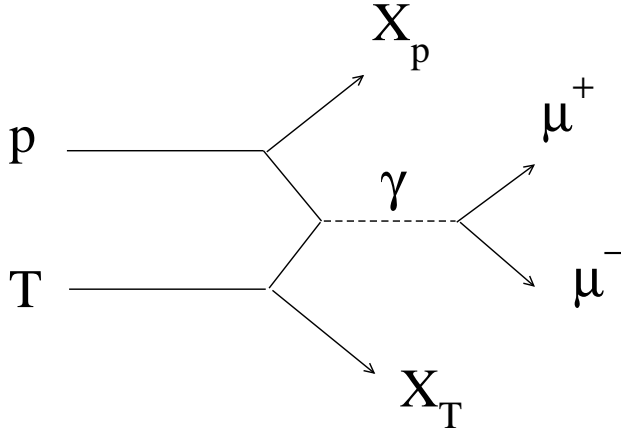

FIG. 1. DY process.

from the available realistic NN potentials [30]. In the same leading order approximation, the resulting $\rho(\vec{k}_\pi)$ depend sensitively on the πNN form factor. An essential feature of our approach is to determine this form factor from fitting the πN scattering data. This provides an empirical constraint on our predictions of the pion effects on the proton-deuteron DY cross sections in the un-explored large x region.

To see clearly the content of our approach, we will give a rather elementary derivation of our formula with all approximations specified explicitly. In Sec. II, we start with the general covariant form of the DY cross section and indicate the procedures needed to obtain the well known $q\bar{q} \rightarrow \mu^+\mu^-$ cross section $\sigma^{q\bar{q}}$. The same procedures are then used to derive formula for calculating the pp and pn DY cross sections from $\sigma^{q\bar{q}}$ and a properly defined PDFs f_N^q of the nucleon.

In Sec. III, we use the impulse approximation to derive the formula for calculating pd DY cross sections from $\sigma^{q\bar{q}}$, f_N^q , and the momentum distributions $\rho_N(p)$ for nucleon and $\rho_\pi(k)$ for pions in the deuteron. The calculations of these two momentum distributions within the considered πNN model are explained in Sec. IV.

In Sec. V, we develop the procedures for applying the developed formula to perform numerical calculations of pp and pd DY cross sections using the available PDFs [31–35] and realistic deuteron wave functions [30]. In Sec. VI, we present results to compare with the available data at 800 GeV [5] and make predictions for analyzing the forthcoming experiment [24]. A summary is given in Sec. VII.

II. FORMULA FOR DY CROSS SECTIONS

The formula presented in this section are derived from using the Bjorken-Drell [36] conventions for the Dirac matrices and the field operators for leptons, nucleons, pions, and photons. We choose the normalization that the plane-wave state $|\vec{k}\rangle$ is normalized as $\langle\vec{k}|\vec{k}'\rangle = \delta(\vec{k} - \vec{k}')$ and the bound states $|\Phi_\alpha\rangle$ of composite particles, nucleons or nuclei, are normalized as $\langle\Phi_\alpha|\Phi_\beta\rangle = \delta_{\alpha,\beta}$. To simplify the presentation, spin indices are suppressed; i.e. $|\vec{k}_a\rangle$ represents $|\vec{k}_a, \lambda_a\rangle$ for a particle a with helicity λ_a . Thus the formula presented here are only for the spin averaged cross sections which are our focus in this paper.

We consider the di-muons production from the DY processes of hadron (h)-hadron (T)

collisions:

$$h(p_h) + T(p_T) \rightarrow \mu^+(k_+) + \mu^-(k_-) + X_h(p_{X_h}) + X_T(p_{X_T}), \quad (3)$$

where X_h and X_T are the undetected fragments, and the four-momentum of each particle is given within the parenthesis. In terms of the partonic $q\bar{q} \rightarrow \gamma \rightarrow \mu^+\mu^-$ mechanism, illustrated in Fig. 1, the covariant form of the di-muons production cross section can be written as

$$d\sigma = \frac{(2\pi)^4}{4[(p_h \cdot p_T)^2 - m_h^2 m_T^2]^{1/2}} \frac{1}{(2\pi)^6} \frac{d\vec{k}_+}{2E_+} \frac{d\vec{k}_-}{2E_-} \frac{1}{q^4} f^{\mu\nu}(k_+, k_-) F_{\mu\nu}(p_h, p_T, q), \quad (4)$$

where m_h and m_T are the masses for h and T , respectively, $E_{\pm} = \sqrt{\vec{k}_{\pm}^2 + m_{\mu}^2}$ are the energies of muons μ^{\pm} , and $q = k_+ + k_-$ is the momentum of the virtual photon. The leptonic tensor is defined by

$$f^{\mu\nu}(k_+, k_-) = (2\pi)^6 (2E_+) (2E_-) \langle \vec{k}_+ \vec{k}_- | j^{\mu}(0) | 0 \rangle \langle 0 | j^{\nu}(0) | \vec{k}_+ \vec{k}_- \rangle. \quad (5)$$

Here taking summation of lepton spins is implied. The leptonic current is

$$j^{\mu}(x) = e \bar{\psi}_{\mu}(x) \gamma^{\mu} \psi_{\mu}(x), \quad (6)$$

where $\psi_{\mu}(x)$ is the field operator for muon, and $e = \sqrt{4\pi\alpha}$ with $\alpha = 1/137$. By using the definitions Eqs. (5) and (6), it is straightforward to get the following analytic form of the lepton tensor

$$f^{\mu\nu}(k_+, k_-) = -4e^2 [k_+^{\mu} k_-^{\nu} + k_+^{\nu} k_-^{\mu} - g^{\mu\nu} (k_+ \cdot k_- + m_{\mu}^2)]. \quad (7)$$

Within the parton model, the hadronic tensor in Eq. (4) is determined by the current $J_{\mu}(x)$ carried by partons q or \bar{q}

$$F_{\mu\nu}(p_h, p_T, q) = \sum_{X_h, X_T} (2\pi)^6 (2E_h) (2E_T) \int d\vec{p}_{X_h} d\vec{p}_{X_T} \delta^4(p_h + p_T - p_{X_h} - p_{X_T} - q) \\ \times \langle p_h p_T | J_{\mu}(0) | \vec{p}_{X_h} d\vec{p}_{X_T} \rangle \langle \vec{p}_{X_T} \vec{p}_{X_h} | J_{\nu}(0) | p_h p_T \rangle. \quad (8)$$

Here it is noted that, throughout this paper, we shall take the summation (average) for the spins of final (initial) particles appearing in hadronic tensors.

$$J_{\mu}(x) = \sum_q \hat{e}_q e \bar{\psi}_q(x) \gamma^{\mu} \psi_q(x), \quad (9)$$

where $\psi_q(x)$ is the field operator for a quark q with charge $\hat{e}_q e$; i.e $\hat{e}_u = 2/3$ and $\hat{e}_d = -1/3$ for up and down quarks, respectively.

The above covariant expressions are convenient for deriving the formula that can express the hadron-hadron DY cross sections in terms of the elementary partonic $q\bar{q} \rightarrow \mu^+\mu^-$ cross sections. To get such formula, we first show how the elementary $q\bar{q} \rightarrow \mu^+\mu^-$ cross section can be derived from Eq. (4) with $h = q$ and $T = \bar{q}$. We then derive the formula for calculating proton-nucleon DY cross section.

A. $q\bar{q} \rightarrow \mu^+\mu^-$ cross section

Explicitly, Eq. (4) for the $q(p_q) + \bar{q}(p_{\bar{q}}) \rightarrow \mu^+(k_+) + \mu^-(k_-)$ process is

$$d\sigma^{q\bar{q}} = \frac{(2\pi)^4}{4[(p_q \cdot p_{\bar{q}})^2 - m_q^4]^{1/2}} \left\{ \frac{1}{(2\pi)^6} \frac{d\vec{k}_+}{2E_+} \frac{d\vec{k}_-}{2E_-} \frac{1}{q^4} f^{\mu\nu}(k_+, k_-) F_{\mu\nu}^{q\bar{q}}(p_q, p_{\bar{q}}, q) \right\}. \quad (10)$$

The next step is to replace the intermediate states $|\vec{p}_{X_h}\vec{p}_{X_T}\rangle$ by the vacuum state $|0\rangle$ in evaluating the hadronic tensor Eq. (8). We thus have

$$F_{\mu\nu}^{q\bar{q}}(p_q, p_{\bar{q}}, q) = (2\pi)^6 (2E_q)(2E_{\bar{q}}) \langle p_{\bar{q}} p_q | J_\mu(0) | 0 \rangle \langle 0 | J_\nu(0) | p_q, p_{\bar{q}} \rangle \delta^4(p_q + p_{\bar{q}} - q). \quad (11)$$

Substituting parton current (9) into Eq. (11), the hadronic tensor $F_{\mu\nu}^{q\bar{q}}$ then has a form that is the same as the leptonic tensor $f^{\mu\nu}$ defined by Eqs. (5) and (6) except that the momentum variables and charges are different. By appropriately changing the momentum variables in Eq. (7), we obtain

$$F_{\mu\nu}^{q\bar{q}}(p_q, p_{\bar{q}}, q) = -(\hat{e}_q e)^2 [p_q^\mu p_{\bar{q}}^\nu + p_{\bar{q}}^\nu p_q^\mu - g^{\mu\nu} (p_q \cdot p_{\bar{q}} + m_q^2)] \delta^4(p_q + p_{\bar{q}} - q). \quad (12)$$

Here, compared with the lepton tensor case [Eq. (7)], the difference of factor 4 is because the average of quark and anti-quark spins is taken for this case. By using Eqs. (7) and (12), Eq. (10) for the cross sections of $q(p_q) + \bar{q}(p_{\bar{q}}) \rightarrow \mu^+(k_+) + \mu^-(k_-)$ can then be written as

$$d\sigma^{q\bar{q}}(p_q, p_{\bar{q}}) = \frac{(2\pi)^4}{4[(p_q \cdot p_{\bar{q}})^2 - m_q^4]^{1/2}} \frac{1}{(2\pi)^6} \frac{d\vec{k}_+}{2E_+} \frac{d\vec{k}_-}{2E_-} \frac{1}{q^4} \delta^4(p_q + p_{\bar{q}} - q) \\ \times 8\hat{e}_q^2 e^4 \left[k_+ \cdot p_q k_- \cdot p_{\bar{q}} + k_- \cdot p_q k_+ \cdot p_{\bar{q}} + m_q^2 \frac{(k_+ + k_-)^2}{2} + m_\mu^2 \frac{(p_q + p_{\bar{q}})^2}{2} \right]. \quad (13)$$

It is convenient to express the $q\bar{q}$ DY cross section in terms of the invariant function $q^2 = (p_q + p_{\bar{q}})^2 = (k_+ + k_-)^2$. After some derivations and accounting for the color degrees of freedom of quarks, we arrive

$$\frac{d\sigma^{q\bar{q}}(p_q, p_{\bar{q}})}{dq^2} = \frac{4\pi\alpha^2}{q^2} \hat{e}_q^2 \frac{1}{3N_c} \frac{[q^2 - 4m_\mu^2]^{1/2}}{[q^2 - 4m_q^2]^{1/2}} \left(1 + \frac{2m_\mu^2}{q^2}\right) \left(1 + \frac{2m_q^2}{q^2}\right) \delta(q^2 - (p_q + p_{\bar{q}})^2), \quad (14)$$

where N_c is the number of colors. Taking $N_c = 3$ and considering $q^2 \gg m_\mu^2$ and $q^2 \gg m_q^2$, we then obtain the familiar form

$$\frac{d\sigma^{q\bar{q}}(p_q, p_{\bar{q}})}{dq^2} = \frac{4\pi\alpha^2}{9q^2} \hat{e}_q^2 \delta(q^2 - (p_q + p_{\bar{q}})^2). \quad (15)$$

The above expression is identical to the commonly used expression, as given, for example, by the CTEQ group [35].

In Sec. II B, we will derive formula expressing the pN cross sections in terms of $d\sigma^{q\bar{q}}(p_q, p_{\bar{q}})/dq^2$ given in Eq. (15).

B. pN DY cross sections

To simplify the presentation, we only present formula for q in the projectile p and \bar{q} in the target N . The term from the interchange $q \leftrightarrow \bar{q}$ will be included only in the final expressions for calculations.

Equation (4) for the $p(p_p) + N(p_N) \rightarrow \mu^+(k_+) + \mu^-(k_-) + X_p(p_{X_p}) + X_N(p_{X_N})$ process is

$$d\sigma^{pN} = \frac{(2\pi)^4}{4[(p_p \cdot p_N)^2 - m_p^2 m_N^2]^{1/2}} \left\{ \frac{1}{(2\pi)^6} \frac{d\vec{k}_+ d\vec{k}_-}{2E_+ 2E_-} \frac{1}{q^4} f^{\mu\nu}(k_+, k_-) F_{\mu\nu}^{pN}(p_p, p_N, q) \right\}, \quad (16)$$

where the hadronic tensor, defined by Eq. (8), is

$$F_{\mu\nu}^{pN}(p_p, p_N, q) = (2\pi)^6 (2E_p)(2E_N) \sum_{X_p, X_N} \int d\vec{p}_{X_p} d\vec{p}_{X_N} \delta^4(p_p + p_N - p_{X_p} - p_{X_N} - q) \\ \times \langle \vec{p}_N \vec{p}_p | J_\mu(0) | \vec{p}_{X_p} \vec{p}_{X_N} \rangle \langle \vec{p}_{X_N} \vec{p}_{X_p} | J_\nu(0) | \vec{p}_p \vec{p}_N \rangle. \quad (17)$$

Within the parton model, the DY cross sections are calculated from the matrix element $\langle q\bar{q} | J_\mu(0) | 0 \rangle \langle 0 | J_\nu(0) | q\bar{q} \rangle$ which is due to the annihilation of a q (\bar{q}) from the projectile p and a \bar{q} (q) from the target N into a photon. To identify such matrix elements, we insert a complete set of $q\bar{q}$ states (omitting spin indices)

$$1 = \int d\vec{p}_q d\vec{p}_{\bar{q}} |\vec{p}_q \vec{p}_{\bar{q}} \rangle \langle \vec{p}_{\bar{q}} \vec{p}_q |,$$

into Eq. (17). We then have

$$F_{\mu\nu}^{pN}(p_p, p_N, q) = (2\pi)^6 (2E_p)(2E_N) \sum_{X_p, X_N} \int d\vec{p}_{X_p} d\vec{p}_{X_N} \delta^4(p_p + p_N - p_{X_p} - p_{X_N} - q) \\ \times \int d\vec{p}_q d\vec{p}_{\bar{q}} \int d\vec{p}'_q d\vec{p}'_{\bar{q}} \langle \vec{p}_p | \vec{p}_q \vec{p}_{X_p} \rangle \langle \vec{p}_N | \vec{p}_{\bar{q}} \vec{p}_{X_N} \rangle \langle \vec{p}_{X_p} \vec{p}'_q | \vec{p}_p \rangle \langle \vec{p}_{X_N} \vec{p}'_{\bar{q}} | \vec{p}_N \rangle \\ \times \langle \vec{p}_{\bar{q}} \vec{p}_q | J_\mu(0) | 0 \rangle \langle 0 | J_\nu(0) | \vec{p}'_q \vec{p}'_{\bar{q}} \rangle. \quad (18)$$

By momentum conservation, the overlap functions in the above equation can be written as

$$\langle \vec{p}_q \vec{p}_X | \vec{p}_p \rangle = \langle \vec{p}_X | b_{\vec{p}_q} | \vec{p}_p \rangle \\ = \phi_{\vec{p}_p}(\vec{p}_q, \vec{p}_X) \delta(\vec{p}_p - \vec{p}_q - \vec{p}_X), \quad (19)$$

where $b_{\vec{p}_q}$ is the annihilation operator of quark q .

By using the definition (19), Eq. (18) can be written as

$$F_{\mu\nu}^{pN}(p_p, p_N, q) = (2\pi)^6 (2E_p)(2E_N) \sum_{X_p, X_N} \int d\vec{p}_{X_p} d\vec{p}_{X_N} \delta^4(p_p + p_N - p_{X_p} - p_{X_N} - q) \\ \times \int d\vec{p}_q |\phi_{\vec{p}_p}(\vec{p}_q, \vec{p}_{X_p})|^2 \delta(\vec{p}_p - \vec{p}_q - \vec{p}_{X_p}) \\ \times \int d\vec{p}_{\bar{q}} |\phi_{\vec{p}_N}(\vec{p}_{\bar{q}}, \vec{p}_{X_N})|^2 \delta(\vec{p}_N - \vec{p}_{\bar{q}} - \vec{p}_{X_N}) \\ \times \langle \vec{p}_{\bar{q}} \vec{p}_q | J_\mu(0) | 0 \rangle \langle 0 | J_\nu(0) | \vec{p}_q \vec{p}_{\bar{q}} \rangle. \quad (20)$$

The evaluation of Eq. (20) needs rather detail information about the undetected fragments X_p and X_N because of the dependence of $\delta^4(p_p + p_N - p_{X_p} - p_{X_N} - q)$ on their energies $p_{X_p}^0$ and $p_{X_N}^0$. To simplify the calculation, we follow the common practice to neglect the explicit dependence of the energy $p_{X_p}^0$ and $p_{X_N}^0$ of the undetected fragments. This amounts to using the approximation $p_{X_p}^0 \sim \epsilon_1$ and $p_{X_N}^0 \sim \epsilon_2$, where ϵ_1 and ϵ_2 are some constant energies, to write

$$\delta^4(p_p + p_N - p_{X_p} - p_{X_N} - q) \sim \delta(\vec{p}_p + \vec{p}_N - \vec{p}_{X_p} - \vec{p}_{X_N} - \vec{q})\delta(p_p^0 + p_N^0 - \epsilon_1 - \epsilon_2 - q^0). \quad (21)$$

We now define

$$f_{\vec{p}_p}^q(\vec{p}_q) = \sum_{X_p} \int d\vec{p}_{X_p} |\phi_{\vec{p}_p}(\vec{p}_q, \vec{p}_{X_p})|^2 \delta(\vec{p}_p - \vec{p}_q - \vec{p}_{X_p}), \quad (22)$$

for the projectile p , and

$$f_{\vec{p}_N}^{\bar{q}}(\vec{p}_{\bar{q}}) = \sum_{X_N} \int d\vec{p}_{X_N} |\phi_{\vec{p}_N}(\vec{p}_{\bar{q}}, \vec{p}_{X_N})|^2 \delta(\vec{p}_N - \vec{p}_{\bar{q}} - \vec{p}_{X_N}), \quad (23)$$

for the target N . These two definitions and the approximation (21) allow us to cast Eq. (20) into the following form

$$\begin{aligned} F_{\mu\nu}^{pN}(p_p, p_N, q) &= (2\pi)^6 (2E_p)(2E_N) \sum_q \int d\vec{p}_q d\vec{p}_{\bar{q}} f_{\vec{p}_p}^q(\vec{p}_q) f_{\vec{p}_N}^{\bar{q}}(\vec{p}_{\bar{q}}) \\ &\quad \times \langle \vec{p}_{\bar{q}} \vec{p}_q | J_\mu(0) | 0 \rangle \langle 0 | J_\nu(0) | \vec{p}_q \vec{p}_{\bar{q}} \rangle \\ &\quad \times \delta(\vec{p}_q + \vec{p}_{\bar{q}} - \vec{q}) \delta(p_p^0 + p_N^0 - \epsilon_1 - \epsilon_2 - q^0). \end{aligned} \quad (24)$$

We next make a reasonable approximation that ϵ_1 (ϵ_2) in Eq. (24) is the difference between the energy of the projectile p (target N) and the removed parton q (\bar{q}); namely assuming

$$\begin{aligned} \delta(p_p^0 + p_N^0 - \epsilon_1 - \epsilon_2 - q^0) &= \delta((p_p^0 - \epsilon_1) + (p_N^0 - \epsilon_2) - q^0) \\ &\sim \delta(p_q^0 + p_{\bar{q}}^0 - q^0). \end{aligned} \quad (25)$$

Then Eq. (24) can be written as

$$\begin{aligned} F_{\mu\nu}^{pN}(p_p, p_N, q) &= \sum_q \int d\vec{p}_q d\vec{p}_{\bar{q}} f_{\vec{p}_p}^q(\vec{p}_q) f_{\vec{p}_N}^{\bar{q}}(\vec{p}_{\bar{q}}) \frac{E_p E_N}{E_q E_{\bar{q}}} \\ &\quad \times \{ (2\pi)^6 (2E_q)(2E_{\bar{q}}) \langle \vec{p}_{\bar{q}} \vec{p}_q | J_\mu(0) | 0 \rangle \langle 0 | J_\nu(0) | \vec{p}_q \vec{p}_{\bar{q}} \rangle \delta^4(p_q + p_{\bar{q}} - q) \}. \end{aligned} \quad (26)$$

The quantity within the bracket $\{...\}$ in the above equation is just the hadronic tensor $F_{\mu\nu}^{q\bar{q}}(p_q, p_{\bar{q}})$, defined in Eq. (11), for $q\bar{q}$ system. We thus have

$$F_{\mu\nu}^{pN}(p_p, p_N, q) = \sum_q \int d\vec{p}_q d\vec{p}_{\bar{q}} f_{\vec{p}_p}^q(\vec{p}_q) f_{\vec{p}_N}^{\bar{q}}(\vec{p}_{\bar{q}}) \frac{E_p E_N}{E_q E_{\bar{q}}} F_{\mu\nu}^{q\bar{q}}(p_q, p_{\bar{q}}). \quad (27)$$

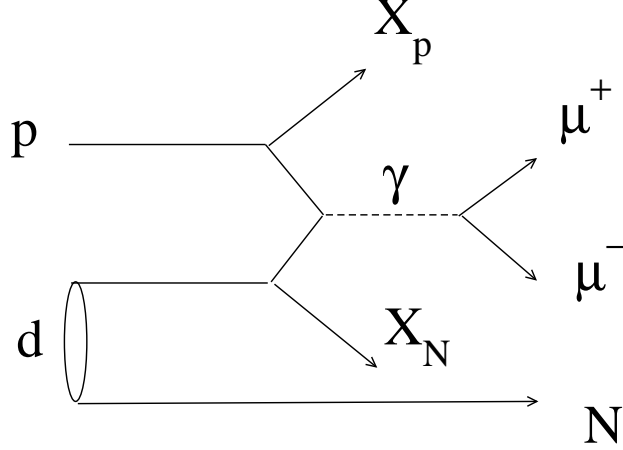

FIG. 2. Impulse approximation of pd DY process.

Substituting Eq. (27) into Eq. (16), we then have

$$d\sigma^{pN} = \sum_q \int d\vec{p}_q d\vec{p}_{\bar{q}} [f_{\vec{p}_p}^q(\vec{p}_q) f_{\vec{p}_N}^{\bar{q}}(\vec{p}_{\bar{q}})] \frac{E_p E_N}{E_q E_{\bar{q}}} \frac{(2\pi)^4}{4[(p_p \cdot p_N)^2 - m_p^2 m_N^2]^{1/2}} \times \left\{ \frac{1}{(2\pi)^6} \frac{d\vec{k}_+}{2E_+} \frac{d\vec{k}_-}{2E_-} \frac{1}{q^4} f^{\mu\nu}(k_+, k_-) F_{\mu\nu}^{q\bar{q}}(p_q, p_{\bar{q}}) \right\}. \quad (28)$$

The quantity in the bracket $\{\dots\}$ of the above equation is precisely what is in the bracket $\{\dots\}$ of Eq. (10) for the $q\bar{q} \rightarrow \mu^+ \mu^-$ process. Accounting for the difference in flux factors and extending Eq. (28) to include the $q \leftrightarrow \bar{q}$ interchange term, the full expression of the pN DY process is

$$\frac{d\sigma^{pN}(p_p, p_N)}{dq^2} = \sum_q \int d\vec{p}_q d\vec{p}_{\bar{q}} [f_{\vec{p}_p}^q(\vec{p}_q) f_{\vec{p}_N}^{\bar{q}}(\vec{p}_{\bar{q}}) + f_{\vec{p}_N}^q(\vec{p}_q) f_{\vec{p}_p}^{\bar{q}}(\vec{p}_{\bar{q}})] \times \frac{[(p_q \cdot p_{\bar{q}})^2 - m_q^4]^{1/2}}{[(p_p \cdot p_N)^2 - m_p^2 m_N^2]^{1/2}} \frac{E_p E_N}{E_q E_{\bar{q}}} \frac{d\sigma^{q\bar{q}}(p_q, p_{\bar{q}})}{dq^2}, \quad (29)$$

where $d\sigma^{q\bar{q}}(p_q, p_{\bar{q}})/dq^2$ is the $q\bar{q}$ DY cross section, as defined by Eq. (15).

We now examine the physical meaning of the functions $f_{\vec{p}_p}^q(\vec{p}_q)$ and $f_{\vec{p}_N}^{\bar{q}}(\vec{p}_{\bar{q}})$ in Eq. (29). By using the definitions (19) for $\phi_{\vec{p}_p}(\vec{p}_{\bar{q}}, \vec{p}_{X_p})$ and Eq. (22) for $f_{\vec{p}_p}^q(\vec{p}_q)$, it is straightforward to show that

$$f_{\vec{p}_p}^q(\vec{p}_q) = \frac{\langle \vec{p}_p | b_{\vec{p}_q}^\dagger b_{\vec{p}_q} | \vec{p}_p \rangle}{\langle \vec{p}_p | \vec{p}_p \rangle}. \quad (30)$$

Thus $f_{\vec{p}_p}^q(\vec{p}_q)$ is just the probability of finding a quark q with momentum \vec{p}_q in a nucleon state $|\vec{p}_p\rangle$. Note that this simple interpretation of $f_{\vec{p}_p}^q(\vec{p}_q)$ is due to the use of the approximations Eqs. (21) and (25). If we depart from these two simplifications, we then need the spectral function of the nucleon in terms of parton degrees of freedom to make calculation for DY cross sections. Such information is not available at the present time.

III. PROTON-DEUTERON DY CROSS SECTION

In this section, we derive formula to express the proton-deuteron (pd) DY cross sections in terms of $d\sigma^{q\bar{q}}(p_q, p_{\bar{q}})/dq^2$ of Eq. (15) for the elementary $q + \bar{q} \rightarrow \mu^+ + \mu^-$ process. To simplify the presentation, we only explain the derivation of the formula for a quark q emitted from the projectile p and an anti-quark \bar{q} from the target d . The terms from the interchange $q \leftrightarrow \bar{q}$ will be included only in the final expression of the cross section.

For the $p(p_p) + d(p_d) \rightarrow \mu^+(k_+) + \mu^-(k_-) + X_p + X_d$ DY process, Eq. (4) gives

$$d\sigma^{pd} = \frac{(2\pi)^4}{4[(p_p \cdot p_d)^2 - m_p^2 m_d^2]^{1/2}} \frac{1}{(2\pi)^6} \frac{d\vec{k}_+}{2E_+} \frac{d\vec{k}_-}{2E_-} \frac{1}{q^4} f^{\mu\nu}(k_+, k_-) F_{\mu\nu}^{pd}(p_p, p_d, q). \quad (31)$$

To proceed, we need to define a model for generating the deuteron wave function. Here we follow the πNN studies [29, 37] to consider a nuclear model within which the deuteron wave function has two components

$$|\Psi_d\rangle = |\Phi_d\rangle + |\phi_{\pi NN}\rangle, \quad (32)$$

where Φ_d is the NN component. In the following two subsections, we derive formulas for calculating the contribution from each component of the deuteron wave function Ψ_d to the pd DY cross sections.

A. Contribution from nucleons

We assume that the pd DY process takes place on each of the nucleons in the deuteron, as illustrated in Fig. 2. In this impulse approximation, the hadronic tensor for a deuteron target can be obtained by simply extending Eq. (17) for the pN to include a spectator nucleon state $|p_s\rangle$ in the sum over the final hadronic states. We thus have

$$F_{\mu\nu}^{pd}(p_p, p_d, q) = (2\pi)^6 (2E_p)(2E_d) \sum_{X_p, X_N} \int d\vec{p}_s d\vec{p}_{X_p} d\vec{p}_{X_N} \delta^4(p_p + p_d - p_{X_p} - p_{X_N} - p_s - q) \\ \times \langle \Phi_{p_d} \vec{p}_p | J_\mu(0) | \vec{p}_{X_p} \vec{p}_{X_N} \vec{p}_s \rangle \langle \vec{p}_s \vec{p}_{X_N} \vec{p}_{X_p} | J_\nu(0) | \vec{p}_p \Phi_{p_d} \rangle, \quad (33)$$

where $|\Phi_{p_d}\rangle$ is the NN component of a deuteron moving with a momentum p_d . We expand $|\Phi_{p_d}\rangle$ in terms of NN plane-wave states

$$|\Phi_{p_d}\rangle = \int d\vec{p}_N d\vec{p}_2 \Phi_{p_d}(\vec{p}_N) \delta(\vec{p}_d - \vec{p}_N - \vec{p}_2) |\vec{p}_N \vec{p}_2\rangle. \quad (34)$$

Keeping only the contributions due to a parton in $|\vec{p}_N\rangle$ of the above expansion of Φ_{p_d} and a parton from projectile state $|\vec{p}_p\rangle$, the current matrix element in Eq. (33) becomes

$$\langle \Phi_{p_d} \vec{p}_p | J_\mu(0) | \vec{p}_{X_p} \vec{p}_{X_N} \vec{p}_s \rangle = \int d\vec{p}_N \Phi_{p_d}^*(\vec{p}_N) \delta(\vec{p}_d - \vec{p}_N - \vec{p}_s) \langle \vec{p}_N \vec{p}_p | J_\mu(0) | \vec{p}_{X_p} \vec{p}_{X_N} \rangle. \quad (35)$$

By using Eq. (35), Eq. (33) can then be written as

$$F_{\mu\nu}^{pd}(p_p, p_d, q) = \int d\vec{p}_N |\Phi_{p_d}(p_N)|^2 \frac{(2E_p)(2E_d)}{(2E_p)(2E_N)} \\ \times \{ (2\pi)^6 (2E_p)(2E_N) \\ \times \sum_{X_p, X_N} \int d\vec{p}_{X_p} d\vec{p}_{X_N} \delta^4(p_p + p_N - p_{X_p} - p_{X_N} - q) \\ \times \langle \vec{p}_N \vec{p}_p | J_\mu(0) | \vec{p}_{X_p} \vec{p}_{X_N} \rangle \langle \vec{p}_{X_N} \vec{p}_{X_p} | J_\nu(0) | \vec{p}_p \vec{p}_N \rangle \}. \quad (36)$$

We see that the quantity within the bracket $\{\dots\}$ in the above equation is identical to $F_{\mu\nu}^{pN}(p_p, p_N, q)$ of Eq. (17). We then have

$$F_{\mu\nu}^{pd}(p_p, p_d, q) = \int d\vec{p}_N \rho_{p_d}(\vec{p}_N) \frac{E_p E_d}{E_p E_N} F_{\mu\nu}^{pN}(p_p, p_N, q), \quad (37)$$

where

$$\rho_{p_d}(\vec{p}_N) = |\Phi_{p_d}(\vec{p}_N)|^2. \quad (38)$$

By using Eq. (34), one can show that

$$\rho_{p_d}(\vec{p}_N) = \langle \Phi_{p_d} | b_{\vec{p}_N}^\dagger b_{\vec{p}_N} | \Phi_{p_d} \rangle, \quad (39)$$

where $b_{\vec{p}_N}^\dagger$ is the creation operator for a nucleon with momentum \vec{p}_N . Thus $\rho_{p_d}(\vec{p}_N)$ is the nucleon momentum distribution in a *moving* deuteron with momentum p_d . We will present formula for calculating $\rho_{p_d}(\vec{p}_N)$ in Sec. IV.

By using Eq. (37), Eq. (31) becomes

$$d\sigma^{pd} = \frac{(2\pi)^4}{4[(p_p \cdot p_d)^2 - m_p^2 m_d^2]^{1/2}} \sum_{N=p,n} \int d\vec{p}_N \rho_{p_d}(\vec{p}_N) \frac{E_p E_d}{E_p E_N} \times \left\{ \frac{1}{(2\pi)^6} \frac{d\vec{k}_+}{2E_+} \frac{d\vec{k}_-}{2E_-} \frac{1}{q^4} f^{\mu\nu}(k_+, k_-) F_{\mu\nu}^{pN}(p_p, p_N, q) \right\}. \quad (40)$$

The quantity within the bracket $\{\dots\}$ of the above equation is exactly what is in the bracket $\{\dots\}$ of Eq. (16). Accounting for the difference in flux factor, we obviously can write

$$\frac{d\sigma^{pd}(p_p, p_d)}{dq^2} = \sum_{N=p,n} \int d\vec{p}_N \rho_{p_d}(\vec{p}_N) \frac{[(p_p \cdot p_N)^2 - m_p^2 m_N^2]^{1/2}}{[(p_p \cdot p_d)^2 - m_p^2 m_d^2]^{1/2}} \frac{E_p E_d}{E_p E_N} \frac{d\sigma^{pN}(p_p, p_N)}{dq^2}, \quad (41)$$

where $d\sigma^{pN}(p_p, p_N)/dq^2$ are given in Eq. (29).

Substituting Eq. (29) into Eq. (41), we have

$$\frac{d\sigma^{pd}(p_p, p_d)}{dq^2} = \sum_{N=p,n} \int d\vec{p}_N \rho_{p_d}(\vec{p}_N) \sum_q \int d\vec{p}_q d\vec{p}_{\bar{q}} \frac{[(p_q \cdot p_{\bar{q}})^2 - m_q^4]^{1/2}}{[(p_p \cdot p_d)^2 - m_p^2 m_d^2]^{1/2}} \frac{E_p E_d}{E_q E_{\bar{q}}} \times [f_{\vec{p}_p}^q(\vec{p}_q) f_{\vec{p}_N}^{\bar{q}}(\vec{p}_{\bar{q}}) + f_{\vec{p}_N}^q(\vec{p}_q) f_{\vec{p}_p}^{\bar{q}}(\vec{p}_{\bar{q}})] \frac{d\sigma^{q\bar{q}}(p_q, p_{\bar{q}})}{dq^2}. \quad (42)$$

B. Contribution from pions

In the impulse approximation, the contribution from the πNN component of Eq. (32) to the pd DY cross sections can be derived by using the similar procedures detailed in the previous subsection. We find that the resulting formula can be obtained from Eq. (42) by changing the momentum distribution and parton distributions for the nucleon to those for the pion. Explicitly, we have

$$\frac{d\sigma_{\pi}^{pd}(p_p, p_d)}{dq^2} = \int d\vec{k}_{\pi} \rho_{p_d}(\vec{k}_{\pi}) \sum_q \int d\vec{p}_q d\vec{p}_{\bar{q}} \frac{[(p_q \cdot p_{\bar{q}})^2 - m_q^4]^{1/2}}{[(p_p \cdot p_d)^2 - m_p^2 m_d^2]^{1/2}} \frac{E_p E_d}{E_q E_{\bar{q}}} \times [f_{\vec{p}_p}^q(\vec{p}_q) f_{\vec{k}_{\pi}}^{\bar{q}}(\vec{p}_{\bar{q}}) + f_{\vec{k}_{\pi}}^q(\vec{p}_q) f_{\vec{p}_p}^{\bar{q}}(\vec{p}_{\bar{q}})] \frac{d\sigma^{q\bar{q}}(p_q, p_{\bar{q}})}{dq^2}, \quad (43)$$

where $f_{\vec{k}_\pi}^q$ and $f_{\vec{k}_\pi}^{\bar{q}}$ are the PDFs for the pion, and the pion momentum distribution in a moving deuteron with momentum p_d is defined by

$$\rho_{p_d}(\vec{k}_\pi) = \langle \phi_{\pi NN, p_d} | a_{\vec{k}_\pi}^\dagger a_{\vec{k}_\pi} | \phi_{\pi NN, p_d} \rangle. \quad (44)$$

where $a_{\vec{k}_\pi}^\dagger$ is the creation operator for a pion with momentum \vec{k}_π . The calculation of $\rho_{p_d}(\vec{k}_\pi)$ from a πNN model will be given in the next section.

IV. CALCULATIONS OF NUCLEON AND PION MOMENTUM DISTRIBUTIONS

We first describe a nuclear model within which the procedure for calculating the nucleon and pion momentum distributions in the rest frame of the deuteron is described. We then explain how these distributions can be used to calculate the momentum distributions in a fast moving deuteron, which are the input to our calculations of Eqs. (42) and (43).

A. πNN Model

We follow the πNN studies [29, 37] to consider a nuclear model defined by the following Hamiltonian

$$H = H_0 + V_{NN} + [H_{\pi NN} + H_{\pi NN}^\dagger], \quad (45)$$

where H_0 is the sum of free energy operators for N and π , V_{NN} is a nucleon-nucleon potential, and $H_{\pi NN}$ defines the virtual $N \rightarrow \pi N$ transition

$$H_{\pi NN} = \sum_{i=1,2} h_{\pi NN}(i), \quad (46)$$

where i denotes the i -th nucleon. Starting with the standard pseudo-vector coupling, the vertex interaction takes the following familiar form (omitting the spin-isospin indices)

$$h_{\pi NN}(i) = \int d\vec{k} d\vec{p}_i d\vec{p}'_i \delta(\vec{p}_i + \vec{k} - \vec{p}'_i) [|\vec{p}_i \vec{k}\rangle F_{\pi NN}(\vec{p}_i, \vec{k}) \langle \vec{p}'_i |], \quad (47)$$

where $|\vec{p}_i\rangle$ and $|\vec{k}\rangle$ are the plane wave states of the i -th nucleon and pion, respectively, and

$$F_{\pi NN}(\vec{p}, \vec{k}) = -\frac{i}{(2\pi)^{3/2}} \frac{f_{\pi NN}}{m_\pi} \frac{1}{\sqrt{2E_\pi(\vec{k})}} \sqrt{\frac{m_N}{E_N(\vec{p})}} \sqrt{\frac{m_N}{E_N(\vec{p} + \vec{k})}} \bar{u}_{\vec{p}} \not{k} \gamma_5 u_{\vec{p} + \vec{k}} F(\Lambda_{\pi NN}, \vec{k}), \quad (48)$$

Here $F(\Lambda_{\pi NN}, k)$ is a form factor that satisfies $F(\Lambda_{\pi NN}, k) = 1$ at $k = i\kappa$ with $\kappa = m_\pi \sqrt{1 - m_\pi^2/(4m_N^2)}$ being the pion momentum at the nucleon pole of the πN amplitude, and its cutoff parameter $\Lambda_{\pi NN}$ can be determined in the fit to the πN scattering data.

It follows from Eqs. (45)-(47) that the bound state $|\Psi_d\rangle$ in the deuteron rest frame ($\vec{p}_d = 0$) is defined by

$$H|\Psi_d\rangle = E_d|\Psi_d\rangle, \quad (49)$$

where the deuteron wave function is normalized to $\langle \Psi_d | \Psi_d \rangle = 1$ and has two components

$$|\Psi_d\rangle = \frac{1}{Z^{1/2}} [|\phi_{NN}\rangle + a|\phi_{\pi NN}\rangle]. \quad (50)$$

Here Z is a normalization factor and each component of the wave function is normalized to 1: $\langle \phi_{NN} | \phi_{NN} \rangle = 1$ and $\langle \phi_{\pi NN} | \phi_{\pi NN} \rangle = 1$. By using the orthogonality condition $\langle \phi_{NN} | \phi_{\pi NN} \rangle = 0$, Eqs. (49) and (50) lead to

$$a\langle \phi_{\pi NN} | (H_0 + V_{NN}) | \phi_{\pi NN} \rangle + \langle \phi_{\pi NN} | H_{\pi NN} | \phi_{NN} \rangle = aE_d, \quad (51)$$

$$\langle \phi_{NN} | (H_0 + V_{NN}) | \phi_{NN} \rangle + a\langle \phi_{NN} | H_{\pi NN}^\dagger | \phi_{\pi NN} \rangle = E_d. \quad (52)$$

From Eq. (51), we have

$$a = \frac{\langle \phi_{\pi NN} | H_{\pi NN} | \phi_{NN} \rangle}{E_d - \langle \phi_{\pi NN} | (H_0 + V_{NN}) | \phi_{\pi NN} \rangle}. \quad (53)$$

It is a difficult three-body problem to solve Eqs. (51) and (52) exactly and find a model of V_{NN} to fit the NN scattering data and the deuteron bound state properties. Here we are simply guided by the results from the previous πNN studies [29, 37]. It was found that in the low energy region, the πNN component is much weaker than the NN component, and it is a good approximation to neglect the matrix element of $\langle \phi_{\pi NN} | V_{NN} | \phi_{\pi NN} \rangle$ in Eq. (53). We then have from Eq. (52),

$$\langle \phi_{NN} | (H_0 + V_{NN}) | \phi_{NN} \rangle + \frac{\langle \phi_{NN} | H_{\pi NN}^\dagger | \phi_{\pi NN} \rangle \langle \phi_{\pi NN} | H_{\pi NN} | \phi_{NN} \rangle}{E_d - \langle \phi_{\pi NN} | H_0 | \phi_{\pi NN} \rangle} = E_d, \quad (54)$$

and the coefficient a of the total wave function (50) is

$$a = \frac{\langle \phi_{\pi NN} | H_{\pi NN} | \phi_{NN} \rangle}{E_d - \langle \phi_{\pi NN} | H_0 | \phi_{\pi NN} \rangle}. \quad (55)$$

If we further assume that the pion loop (pion is emitted and absorbed by the same nucleon) in the second term of Eq. (54) can be absorbed in the physical nucleon mass, Eq. (54) is equivalent to the following Schrödinger equation

$$[H_0 + V_{NN} + V_{NN}^{\text{opep}}(E_d)] |\phi_{NN}\rangle = E_d |\phi_{NN}\rangle, \quad (56)$$

with the one-pion-exchange potential defined by

$$V_{NN}^{\text{opep}}(E_d) = \sum_{i \neq j} h_{\pi NN}^\dagger(i) \frac{|\phi_{\pi NN}\rangle \langle \phi_{\pi NN}|}{E_d - \langle \phi_{\pi NN} | H_0 | \phi_{\pi NN} \rangle} h_{\pi NN}(j). \quad (57)$$

By using Eq. (46) for $H_{\pi NN}$, Eq. (55) leads to

$$|a|^2 = \langle \phi_{NN} | [\rho_\pi^{\text{loop}}(E_d) + \rho_\pi^{\text{exc}}(E_d)] | \phi_{NN} \rangle, \quad (58)$$

where

$$\rho_\pi^{\text{exc}}(E_d) = \sum_{i \neq j} h_{\pi NN}^\dagger(i) \frac{|\phi_{\pi NN}\rangle \langle \phi_{\pi NN}|}{(E_d - \langle \phi_{\pi NN} | H_0 | \phi_{\pi NN} \rangle)^2} h_{\pi NN}(j), \quad (59)$$

$$\rho_\pi^{\text{loop}}(E_d) = \sum_i h_{\pi NN}^\dagger(i) \frac{|\phi_{\pi NN}\rangle \langle \phi_{\pi NN}|}{(E_d - \langle \phi_{\pi NN} | H_0 | \phi_{\pi NN} \rangle)^2} h_{\pi NN}(i). \quad (60)$$

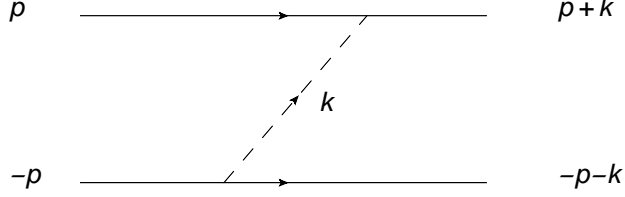

FIG. 3. One-pion-exchange interaction in the center of mass frame of NN .

From Eqs. (57) and (59), we then have the following interesting relation

$$\rho_{\pi}^{\text{exc}}(E_d) = -\frac{d}{dE_d} V_{NN}^{\text{opep}}(E_d). \quad (61)$$

Note that the relation Eq. (61) is identical to that used in Ref. [38] to calculate the so-called pion-excess, except that a non-relativistic form of V_{NN}^{opep} is used in their calculations.

To see the physical meaning of $\rho_{\pi}^{\text{loop}}(E_d)$ and $\rho_{\pi}^{\text{exc}}(E_d)$, we define the pion number N_{π} in the deuteron rest frame as

$$N_{\pi} = \int d\vec{k} \rho_{\pi}(\vec{k}), \quad (62)$$

with

$$\rho_{\pi}(\vec{k}) = \langle \Psi_d | a_{\vec{k}}^{\dagger} a_{\vec{k}} | \Psi_d \rangle, \quad (63)$$

From Eq. (50), we then get

$$N_{\pi} = \frac{1}{Z} |a|^2. \quad (64)$$

By using Eqs. (58) and (64), we can define

$$N_{\pi} = N_{\pi}^0 + N_{\pi}^{\text{exc}}, \quad (65)$$

where

$$\begin{aligned} N_{\pi}^0 &= \frac{1}{Z} \langle \phi_{NN} | \rho_{\pi}^{\text{loop}}(E_d) | \phi_{NN} \rangle \\ &= \int d\vec{k} \rho_{\pi}^0(\vec{k}), \end{aligned} \quad (66)$$

$$\begin{aligned} N_{\pi}^{\text{exc}} &= \frac{1}{Z} \langle \phi_{NN} | \rho_{\pi}^{\text{exc}}(E_d) | \phi_{NN} \rangle \\ &= \int d\vec{k} \rho_{\pi}^{\text{exc}}(\vec{k}). \end{aligned} \quad (67)$$

In the DY and DIS calculations, the contributions from $\rho_{\pi}^0(\vec{k})$ are included in the meson cloud contributions to the nucleon parton distributions. Only $\rho_{\pi}^{\text{exc}}(\vec{k})$ is needed in our calculation of pion contribution to proton-deuteron DY process. This assumption is similar to that used in the calculation of pion-excess contribution [38] to DIS cross sections [39].

To calculate $\rho_\pi^{\text{exc}}(\vec{k})$, we use Eq. (61) by first calculating the matrix element of one-pion-exchange potential (57) in the rest frame of the deuteron. From the kinematics shown in Fig. 3, we have

$$\langle \phi_{NN} | V_{NN}^{\text{opep}}(E_d) | \phi_{NN} \rangle = \int d\vec{k} \langle \phi_{NN} | V_{NN}^{\text{opep}}(\vec{k}, E_d) | \phi_{NN} \rangle \quad (68)$$

where the contribution from the pion with momentum \vec{k} is

$$\begin{aligned} \langle \phi_{NN} | V_{NN}^{\text{opep}}(\vec{k}, E_d) | \phi_{NN} \rangle &= \int d\vec{p} \phi_{NN}^*(\vec{p} + \vec{k}) F_{\pi NN}^*(\vec{p}, \vec{k}) \frac{1}{E_d - E_N(\vec{p}) - E_N(\vec{p} + \vec{k}) - E_\pi(\vec{k})} \\ &\quad \times F_{\pi NN}(-\vec{p} - \vec{k}, \vec{k}) \phi_{NN}(\vec{p}). \end{aligned}$$

By using Eqs. (61) and (48) and including spin-isospin indices, we readily get

$$\begin{aligned} \rho_\pi^{\text{exc}}(\vec{k}) &= \frac{1}{Z} \left[-\frac{d}{dE_d} \langle \phi_{NN} | V_{NN}^{\text{opep}}(\vec{k}, E_d) | \phi_{NN} \rangle \right] \\ &= \frac{2}{Z} \int d\vec{p} \frac{1}{(2\pi)^3} \left(\frac{f_{\pi NN}}{m_\pi} \right)^2 \frac{1}{2E_\pi(\vec{k})} \frac{m_N}{E_N(\vec{p})} \frac{m_N}{E_N(\vec{p} + \vec{k})} \left[\frac{1}{E_d - E_N(\vec{p}) - E_N(\vec{p} + \vec{k}) - E_\pi(\vec{k})} \right]^2 \\ &\quad \times \sum_{m_{s_1} m_{s_2} m_{s'_1} m_{s'_2}} \phi_{NN}^{J_d M_{J_d} *}(\vec{p} + \vec{k}, m_{s_1}, m_{s_2}) \bar{u}_{\vec{p} + \vec{k}, m_{s_1}} \not{k} \gamma_5 u_{\vec{p}, m_{s'_1}} \bar{u}_{-\vec{p} - \vec{k}, m_{s_2}} \not{k} \gamma_5 u_{-\vec{p}, m_{s'_2}} \\ &\quad \times [F(\Lambda_{\pi NN}, \vec{k})]^2 \phi_{NN}^{J_d M_{J_d}}(\vec{p}, m_{s'_1}, m_{s'_2}) \langle T_d M_d | I(\tau_1, \tau_2) | T_d M_d \rangle, \end{aligned} \quad (69)$$

where the overall factor 2 comes from summing up two possible pion-exchange diagrams. The isospin matrix element is

$$\begin{aligned} \langle T_d M_d | I(\tau_1, \tau_2) | T_d M_d \rangle &= \sum_{\alpha=-1,0,+1} \sum_{T' M'_T} \langle T_d M_d | \tau_\alpha(1) | [\pi_\alpha N_1 N_2]_{T' M'_T} \rangle \\ &\quad \times \langle [\pi_\alpha N_1 N_2]_{T' M'_T} | \tau_{-\alpha}(2) | T_d M_d \rangle (-1)^\alpha, \end{aligned}$$

with

$$\begin{aligned} |T M_T\rangle &= \sum_{m_1, m_2} \langle \frac{1}{2} \frac{1}{2} m_1 m_2 | T M_T \rangle |m_1, m_2\rangle, \quad (70) \\ |[\pi_\alpha N_1 N_2]_{T' M'_T}\rangle &= \sum_t |[\pi_\alpha [N_1 N_2]_t]_{T' M'_T}\rangle \\ &= \sum_t \sum_{m_1, m_2} \langle \frac{1}{2} \frac{1}{2} m_1 m_2 | t m_t \rangle \langle t 1 m_t m_\alpha | T' M'_T \rangle |m_1, m_2\rangle, \quad (71) \end{aligned}$$

where $\langle j_1 j_2 m_1 m_2 | j m \rangle$ is the Clebsch-Gordon coefficient.

For deuteron $T = M_T = 0$ and only $T' = M'_T = 0$ for πNN should be kept, we then get $\langle T_d M_d | I(\tau_1, \tau_2) | T_d M_d \rangle = -1/3$. The spin-orbital part of the deuteron wave function in Eq. (69) can be expanded as

$$\phi_{NN}^{J_d M_{J_d}}(\vec{p}, m_{s_1}, m_{s_2}) = \sum_{LM_L} \langle L S M_L m_s | J_d M_{J_d} \rangle \langle \frac{1}{2} \frac{1}{2} m_{s_1} m_{s_2} | S m_S \rangle u_L(p) Y_{LM_L}(\hat{p}), \quad (72)$$

where the radial wave functions are normalized as

$$\int_0^\infty p^2 dp [u_0^2(p) + u_2^2(p)] = 1. \quad (73)$$

Because the πNN component is much smaller, the normalization factor is $Z \sim 1$. We will use $Z = 1$ for calculating $\rho_\pi^{\text{exc}}(\vec{k})$ of Eq. (69). In the same approximation, we will use the deuteron radial wave functions $u_0(p)$ and $u_2(p)$ generated from the available realistic NN potentials such as ANL-V18 [30].

Neglecting the small contribution from πNN component, the nucleon momentum distribution in the rest frame of the deuteron can be written as

$$\begin{aligned} \rho_N(\vec{p}) &= \langle \Phi_d | b_{\vec{p}}^\dagger b_{\vec{p}} | \Phi_d \rangle \\ &\sim \frac{1}{Z} \langle \phi_{NN} | b_{\vec{p}}^\dagger b_{\vec{p}} | \phi_{NN} \rangle. \end{aligned} \quad (74)$$

By using Eq. (72) and setting $Z \sim 1$, we obtain

$$\rho_N(\vec{p}) \sim \frac{1}{4\pi} [u_0^2(p) + u_2^2(p)]. \quad (75)$$

B. Momentum distributions in a moving deuteron

In the calculation of proton-deuteron DY cross sections, the momentum distributions $\rho_{p_d}(\vec{p}_N)$ in Eq. (42) and $\rho_{p_d}(\vec{k}_\pi)$ in Eq. (43) are defined in a fast moving deuteron with a momentum p_d . To calculate such momentum distributions, we first note that the particle number in a system is independent of the frame. We thus have the following frame independent normalization condition

$$N_a = \int d\vec{p}' \rho_{p_d}(\vec{p}') = \int d\vec{p} \rho_{p_d}(\vec{p}), \quad (76)$$

where N_a is the number of the considered particle $a = N$ or π in the deuteron, and the deuteron momenta (set \vec{p}_d in the z-direction) in the moving frame and the rest frame are, respectively,

$$p_d = (E_d(\vec{p}_d), 0, 0, p_d^z), \quad (77)$$

$$p_d^o = (m_d, 0, 0, 0). \quad (78)$$

The nucleon momenta in Eq. (76) are related by the Lorentz transformation defined by the velocity $\beta = P_z/E_d(\vec{P}_d)$ of the moving frame. Explicitly, we have

$$p_z = \frac{E_d(\vec{p}_d)}{m_d} \left[p'_z - \frac{p_d^z}{E_d(\vec{p}_d)} E_N(\vec{p}') \right], \quad (79)$$

$$E_N(p) = \frac{E_d(\vec{p}_d)}{m_d} \left[E_N(\vec{p}') - \frac{p_d^z}{E_d(\vec{p}_d)} p'_z \right], \quad (80)$$

$$\vec{p}_\perp = \vec{p}'_\perp. \quad (81)$$

The above equations lead to the following Lorentz invariant relation

$$\frac{d\vec{p}'}{E_N(\vec{p}')} = \frac{d\vec{p}}{E_N(\vec{p})}. \quad (82)$$

By using Eqs. (76) and (82), we thus have

$$\rho_{pd}(\vec{p}') = \frac{E_N(\vec{p})}{E_N(\vec{p}')} \rho_{p_d^o}(\vec{p}). \quad (83)$$

With Eqs. (79)-(81), we can use Eq. (83) to get $\rho_{pd}(\vec{p}')$ from the momentum distribution $\rho_{p_d^o}(\vec{p})$ in the rest frame of the deuteron; $\rho_{p_d^o}(\vec{p})$ can be calculated from the momentum distributions in the deuteron rest frame: $\rho_{\pi}^{\text{exc}}(\vec{k})$ of Eq. (69) for pions and $\rho_N(\vec{p})$ of Eq. (75) for nucleons.

Here we mention that the relation (83) for a two-nucleon system can be explicitly derived from the definition (39) within the relativistic quantum mechanics developed by Dirac, as reviewed in Ref. [40].

V. CALCULATION PROCEDURES

In this section, we develop procedures to apply the formula presented in previous sections to investigate the Fermi motion and pion-exchange effects on the ratio $R_{pd/pp} = \sigma^{pd}/(2\sigma^{pp})$ between the pd and pp DY cross sections. Our first task is to relate our momentum variables p_p , p_T and q to the variables used in the analysis [5] of the available data. This will be given in Sec. V A. The procedures for calculating DY cross sections are given for pp in Sec. V B and for pd in Sec. V C.

A. Kinematical variables for DY cross sections

It is common [5] to use the collinear approximation to define the parton momentum:

$$p_{q_p} = x_1 p_p, \quad (84)$$

$$p_{q_T} = x_2 p_T, \quad (85)$$

where p_{q_p} (p_{q_T}) is the momentum of a parton in the projectile (target), and x_1 and x_2 are scalar numbers. The momentum q of the virtual photon in the $q\bar{q} \rightarrow \gamma \rightarrow \mu^+ \mu^-$, as seen in Fig. 1. is

$$q = p_{q_p} + p_{q_T} = x_1 p_p + x_2 p_T. \quad (86)$$

In the considered very high energy region $E_p > 100$ GeV, the masses of projectile ($p_p^2 = m_p^2$) and target ($p_T^2 = m_T^2$) can be neglected and hence $s = (p_p + p_T)^2 \sim 2p_p \cdot p_T$, $p_T \cdot q \sim x_1 p_p \cdot p_T$, and $p_p \cdot q \sim x_2 p_p \cdot p_T$. We thus have the following relations

$$x_1 \sim \frac{2q \cdot p_T}{s}, \quad (87)$$

$$x_2 \sim \frac{2q \cdot p_p}{s}. \quad (88)$$

It is most convenient to perform calculations in terms of x_1 and x_2 in the center of mass system in which the projectile is in the z direction and the target in $-z$ direction:

$$p_p = (\sqrt{p^2 + m_p^2}, 0, 0, p) \sim (p, 0, 0, p), \quad (89)$$

$$p_T = (\sqrt{p^2 + m_T^2}, 0, 0, -p) \sim (p, 0, 0, -p). \quad (90)$$

With the choices (89) and (90), we have

$$\begin{aligned} s &= (p_p + p_T)^2 \sim 4p^2, \\ M^2 &= q^2 = (x_1 p_p + x_2 p_T)^2 \sim 4x_1 x_2 p^2. \end{aligned}$$

The above two equations lead the simple relation

$$x_1 x_2 \sim \frac{M^2}{s}. \quad (91)$$

By using Eqs. (87)-(90), we can define a useful variable x_F

$$\begin{aligned} x_F &= x_1 - x_2 \sim \frac{2(p_T - p_p) \cdot q}{s} \\ &\sim \frac{2\sqrt{s}\hat{z} \cdot \vec{q}}{s} = \frac{2\sqrt{s}\hat{p}_p \cdot \vec{q}}{s}. \end{aligned} \quad (92)$$

In the notation of Ref. [5], we write

$$x_F \sim \frac{p_{\parallel}^{\gamma}}{\sqrt{s}/2}, \quad (93)$$

where $p_{\parallel}^{\gamma} = \hat{p}_p \cdot \vec{q}$ is clearly the longitudinal component of the intermediate photon momentum with respect to the projectile in the center of mass frame. Experimentally, s , M , x_F , and $d\sigma/(dMdx_F)$ are measured. With the relation (91), we certainly can determine the corresponding x_1 , x_2 and $d\sigma/(dx_1 dx_2)$. We thus will only give the expression of $d\sigma/(dx_1 dx_2)$ in the following subsections.

B. Calculation of pp DY cross sections $d\sigma^{pp}/dx_1 dx_2$

We now note that with the simplifications used in defining the variable x_1 and x_2 , as described above, the flux factor associated with Eq. (29) become 1. Substituting Eq. (15) into Eq. (29), the DY cross section for $p(p_p) + N(p_N) \rightarrow \mu^+ + \mu^- + X_p + X_N$ with $N = p, n$ is then calculated from

$$\begin{aligned} \frac{d\sigma^{pN}(p_p, p_N)}{dq^2} &= \sum_q \int d\vec{p}_q d\vec{p}_{\bar{q}} [f_{p_p}^q(p_q) f_{p_N}^{\bar{q}}(p_{\bar{q}}) + f_{p_N}^q(p_q) f_{p_p}^{\bar{q}}(p_{\bar{q}})] \\ &\times \frac{4\pi\alpha^2}{9q^2} \hat{e}_q^2 \delta(q^2 - (p_q + p_{\bar{q}})^2). \end{aligned} \quad (94)$$

In the chosen center of mass frame, defined by Eqs. (89) and (90), let us consider \bar{q} in the target nucleon moving with a momentum $p_N = (p_N^z, 0, 0, p_N^z)$. In the precise collinear approximation, only z -component of the \bar{q} momentum is defined by p_N^z . As defined by Eq. (88), we thus write $\vec{p}_{\bar{q}} = (\vec{p}_{\bar{q}\perp}, p_{\bar{q}}^z)$ where

$$p_{\bar{q}}^z = x_2 p_N^z, \quad (95)$$

and $\vec{p}_{\bar{q}\perp}$ can be arbitrary. The integration over the \bar{q} momentum distribution in the target N can then be written as

$$\int d\vec{p}_{\bar{q}} f_{p_N}^{\bar{q}}(\vec{p}_{\bar{q}}) = \int dx_2 f_N^{\bar{q}}(x_2), \quad (96)$$

with

$$f_N^{\bar{q}}(x_2) = p_N^z \int d\vec{p}_{\bar{q}\perp} f_{\vec{p}_N}^{\bar{q}}(x_2 p_N^z, \vec{p}_{\bar{q}\perp}). \quad (97)$$

Similarly, we can define for the projectile proton

$$\int d\vec{p}_q f_{\vec{p}_p}^q(\vec{p}_q) = \int dx_1 f_p^q(x_1). \quad (98)$$

By using Eqs. (96) and (98), Eq. (94) can be written as

$$\begin{aligned} \frac{d\sigma^{pN}(p_p, p_N)}{dq^2} &= \sum_q \int dx_1 dx_2 [f_p^q(x_1) f_N^{\bar{q}}(x_2) + f_p^{\bar{q}}(x_1) f_N^q(x_2)] \\ &\quad \times \frac{4\pi\alpha^2}{9q^2} \hat{e}_q^2 \delta(q^2 - (p_q + p_{\bar{q}})^2). \end{aligned} \quad (99)$$

Integrating the above equation over dq^2 , we then obtain an expression of the cross section in terms of x_1 and x_2 that are defined by experimental kinematics

$$\frac{d\sigma^{pN}(p_p, p_N)}{dx_1 dx_2} = \sum_q \frac{4\pi\alpha^2}{9(p_q + p_{\bar{q}})^2} \hat{e}_q^2 [f_p^q(x_1) f_N^{\bar{q}}(x_2) + f_p^{\bar{q}}(x_1) f_N^q(x_2)], \quad (100)$$

which is the same as Eq. (1) used in the analysis of Ref. [5] since $(p_q + p_{\bar{q}})^2 = q^2 = M^2$ for the partonic process $q\bar{q} \rightarrow \gamma$. Therefore we identify $f_N^{\bar{q}}(x)$, defined by Eq. (97), with PDFs of the parton model [also for $f_N^q(x)$]. To compare with the results of Ref. [5], we use PDFs of CTEQ5m [35] in our calculations of Eq. (100).

Equation (100) for the pp then obviously takes the following form

$$\begin{aligned} \frac{d\sigma^{pp}(p_p, p_{N=p})}{dx_1 dx_2} &= \frac{4\pi\alpha^2}{9M^2} \left[\frac{4}{9} (f_p^u(x_1) f_p^{\bar{u}}(x_2) + f_p^{\bar{u}}(x_1) f_p^u(x_2)) \right. \\ &\quad \left. + \frac{1}{9} (f_p^d(x_1) f_p^{\bar{d}}(x_2) + f_p^{\bar{d}}(x_1) f_p^d(x_2)) \right]. \end{aligned} \quad (101)$$

C. Calculation of pd DY cross sections of $d\sigma^{pd}/(dx_1 dx_2)$

We first consider the contributions from the nucleon momentum distribution $\rho_{pd}(\vec{p}_N)$ to Eq. (42) for the proton-deuteron DY cross sections. With the simplifications used in defining the variable x_1 and x_2 , as described in the subsection V.A, the flux factor associated with Eqs. (42) become 1. We thus only need to consider

$$\frac{d\sigma^{pd}(p_p, p_d)}{dq^2} = \sum_q \frac{4\pi\alpha^2}{9q^2} \hat{e}_q^2 \int d\vec{p}_q \int d\vec{p}_{\bar{q}} \int d\vec{p}_N \rho_{pd}(\vec{p}_N) f_{\vec{p}_p}^q(\vec{p}_q) f_{\vec{p}_N}^{\bar{q}}(\vec{p}_{\bar{q}}) \delta(q^2 - (p_q + p_{\bar{q}})^2). \quad (102)$$

The above expression is for the contribution from an anti-quark in the nucleon N of the deuteron and a quark in the projectile proton. Other contributions have the similar expressions, just with different quark indices.

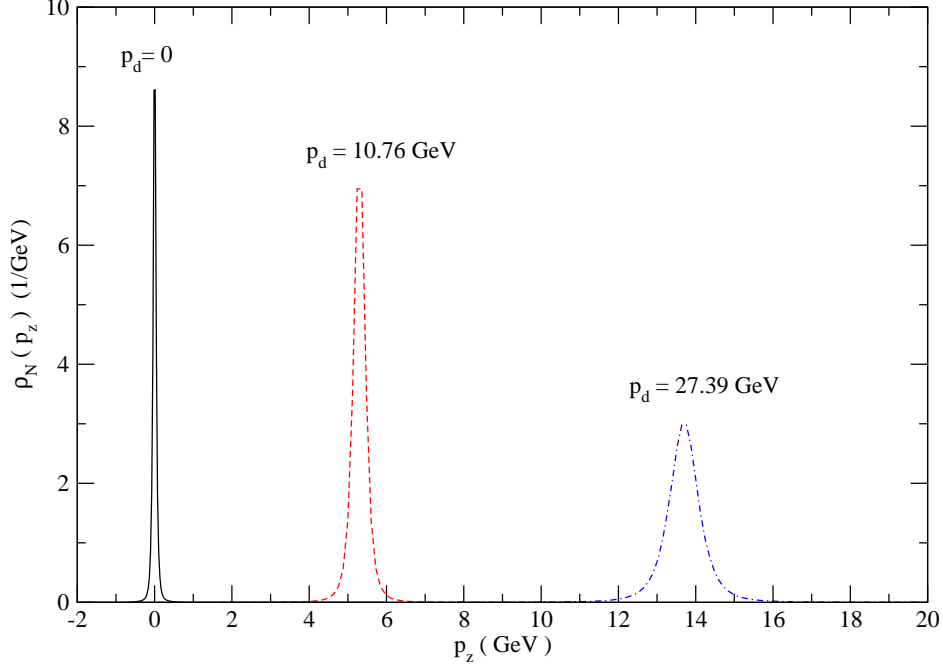

FIG. 4. (color online) Nucleon momentum distribution $\rho_{p_d}(p_z) = \int d\vec{p}_\perp \rho_{p_d}(p_z, \vec{p}_\perp)$ in a deuteron moving with momentum p_d in the z -direction. The deuteron wave function of Ref. [30] is used.

By using the definitions of the parton distributions, Eq. (96) for $f_N^q(x_2^N)$ and Eq. (98) for $f_p^q(x_1)$, Eq. (102) can be written in terms of momentum fraction variable x_1 for q in the projectile proton p and x_2^N of the nucleon N in the deuteron. We then obtain

$$\frac{d\sigma^{pd}(p_p, p_d)}{dq^2} = \sum_q \frac{4\pi\alpha^2}{9q^2} \hat{e}_q^2 \int dx_1 \int dx_2^N \int d\vec{p}_N \rho_{p_d}(\vec{p}_N) f_p^q(x_1) f_N^q(x_2^N) \delta(q^2 - (p_q + p_{\bar{q}})^2). \quad (103)$$

Similar to the pp case, the deuteron momentum is chosen to be in the z -direction: $\vec{p}_d = (p_d^z, \vec{p}_{d\perp} = \vec{0})$. Before we proceed further, it is necessary to relate the momentum fraction x_2^N in Eq. (103) to x_2 which is determined by the experimental variables M , s and x_f through the relations: $x_1 x_2 = M^2/s$ and $x_f = x_1 - x_2 = p_{\parallel}^{\gamma}/(\sqrt{s}/2)$. Since our derivation is based on the impulse approximation that the parton is emitted from the nucleon in the deuteron, it is appropriate to assume that the momentum of the emitted parton is $p_{\bar{q}}^z = x_2 p_{\text{ave}}^z$, where p_{ave}^z is the averaged nucleon momentum in the deuteron defined by

$$(p_{\text{ave}}^z)^2 = \frac{\int \rho_{p_d}(\vec{p})(p^z)^2 d\vec{p}}{\int \rho_{p_d}(\vec{p}) d\vec{p}} \quad (104)$$

Note that $\rho_{p_d}(\vec{p})$ in the above equation is calculated from the nucleon momentum distribution $\rho_N(\vec{p})$ [Eq. (75)] in the deuteron rest frame by using the relation Eq. (83). In Fig. 4, we show the dependence of the calculated $\rho_{p_d}(p^z) \equiv \int d\vec{p}_\perp \rho_{p_d}(p^z, \vec{p}_\perp)$ on a deuteron momentum p_d . As expected, we find that that $p_{\text{ave}}^z \sim p_d^z/2$ at each deuteron momentum.

Changing the integration variable by $x_2^N = p_{\bar{q}}^z/p_N^z = x_2 p_{\text{ave}}^z/p_N^z$, we can write Eq. (103)

as

$$\frac{d\sigma^{pd}(p_p, p_d)}{dq^2} = \frac{4\pi\alpha^2}{9q^2} \hat{e}_q^2 \int dx_1 \int dx_2 \int d\vec{p}_N \rho_{p_d}(\vec{p}_N) \frac{p_{\text{ave}}^z}{p_N^z} f_p^q(x_1) f_N^{\bar{q}}(x_2 p_{\text{ave}}^z / p_N^z) \times \delta(q^2 - (p_q + p_{\bar{q}})^2). \quad (105)$$

Integrating over q^2 on both sides of the above equation, we then obtain an expression of the cross section in terms of x_1 and x_2 which are defined by experimental kinematics

$$\frac{d\sigma^{pd}(p_p, p_d)}{dx_1 dx_2} = \frac{4\pi\alpha^2}{9q^2} \hat{e}_q^2 f_p^q(x_1) F_{p_d, N}^{\bar{q}}(x_2), \quad (106)$$

where the \bar{q} contribution is isolated in

$$F_{p_d, N}^{\bar{q}}(x_2) = \int d\vec{p}_N \rho_{p_d}(\vec{p}_N) \frac{p_{\text{ave}}^z}{p_N^z} f_N^{\bar{q}}(x_2 p_{\text{ave}}^z / p_N^z). \quad (107)$$

Within the parton model, we should only keep the contribution from $f_N^{\bar{q}}(x_2 p_{\text{ave}}^z / p_N^z)$ with $x_2 p_{\text{ave}}^z / p_N^z \leq 1$. The above equation can then be written as

$$F_{p_d, N}^{\bar{q}}(x_2) = \int_{(x_2 p_{\text{ave}}^z)}^{\infty} dp_N^z \frac{p_{\text{ave}}^z}{p_N^z} f_N^{\bar{q}}(x_2 p_{\text{ave}}^z / p_N^z) \rho_{p_d}(p_N^z), \quad (108)$$

with

$$\rho_{p_d}(p_N^z) = \int d\vec{p}_{N\perp} \rho_{p_d}(p_N^z, \vec{p}_{N\perp}). \quad (109)$$

The derivation of Eq. (108) can be extended to have q in deuteron and \bar{q} in the projectile proton. We finally obtain

$$\frac{d\sigma^{pd}(p_p, p_d)}{dx_1 dx_2} = \frac{4\pi\alpha^2}{9q^2} \sum_q \hat{e}_q^2 \left[f_p^q(x_1) \sum_{N=p,n} F_{p_d, N}^{\bar{q}}(x_2) + f_p^{\bar{q}}(x_1) \sum_{N=p,n} F_{p_d, N}^q(x_2) \right]. \quad (110)$$

We use the charge symmetry to calculate PDFs for the neutron from that of proton: $f_n^d = f_p^u$, $f_n^u = f_p^d$, $f_n^{\bar{d}} = f_p^{\bar{u}}$, $f_n^{\bar{u}} = f_p^{\bar{d}}$. Furthermore $\rho_{p_d}(p_N^z)$ is the same for neutron and proton. Including the charges for u and d quarks appropriately, Eq. (110) can be written as

$$\frac{d\sigma^{pd}(p_p, p_d)}{dx_1 dx_2} = \frac{4\pi\alpha^2}{9q^2} \left\{ \left[\frac{4}{9} f_p^u(x_1) + \frac{1}{9} f_p^d(x_1) \right] \left[F_{p_d, p}^{\bar{u}}(x_2) + F_{p_d, p}^{\bar{d}}(x_2) \right] + \left[\frac{4}{9} f_p^{\bar{u}}(x_1) + \frac{1}{9} f_p^{\bar{d}}(x_1) \right] \left[F_{p_d, p}^u(x_2) + F_{p_d, p}^d(x_2) \right] \right\}. \quad (111)$$

The formula for calculating the contribution from pion momentum distribution can be derived by the similar procedure. We obtain

$$\frac{d\sigma_{\pi}^{pd}(p_p, p_d)}{dx_1 dx_2} = \frac{4\pi\alpha^2}{9q^2} \left[\frac{4}{9} f_p^u(x_1) F_{p_d, \pi}^{\bar{u}}(x_2) + \frac{1}{9} f_p^d(x_1) F_{p_d, \pi}^{\bar{d}}(x_2) + \frac{4}{9} f_p^{\bar{u}}(x_1) F_{p_d, \pi}^u(x_2) + \frac{1}{9} f_p^{\bar{d}}(x_1) F_{p_d, \pi}^d(x_2) \right], \quad (112)$$

where $f_{k_\pi}^q(x)$ is PDFs for the pion taken from Ref. [28], and the convolution function for the pion is

$$F_{p_d,\pi}^q(x_2) = \int_{(x_2 k_{\text{ave}}^z)}^{\infty} dk_\pi^z \frac{k_{\text{ave}}^z}{k_\pi^z} f_\pi^q(x_2 k_{\text{ave}}^z/k_\pi^z) \rho_{p_d}(k_\pi^z), \quad (113)$$

with

$$\rho_{p_d}(k_\pi^z) = \int d\vec{k}_{\pi\perp} \rho_{p_d}(k_\pi^z, \vec{k}_{\pi\perp}). \quad (114)$$

Here the average pion momentum is defined by

$$(k_{\text{ave}}^z)^2 = \frac{\int \rho_{p_d}(\vec{k}_\pi) (k_\pi^z)^2 d\vec{k}_\pi}{\int \rho_{p_d}(\vec{k}_\pi) d\vec{k}_\pi}. \quad (115)$$

The pion momentum distribution $\rho_{p_d}(\vec{k}_\pi)$ in the above equations is calculated from $\rho_\pi^{\text{exc}}(\vec{k})$ of Eq. (69) by using the relation Eq. (83).

VI. NUMERICAL RESULTS

As discussed in Ref. [5], the ratio \bar{d}/\bar{u} in the proton can be extracted from the data of the ratios between the pd and pp DY cross sections:

$$R_{pd/pp} = \frac{d\sigma^{pd}(p, p_d)}{dx_1 dx_2} / \left(2 \frac{d\sigma^{pp}(p, p_p)}{dx_1 dx_2} \right), \quad (116)$$

where x_1 and x_2 have been defined in Sec. V A. We are interested in the effects of pion-exchange and nucleon Fermi motion on this ratio. The pp cross section $d\sigma^{pp}(p, p_p)/(dx_1 dx_2)$ can be calculated from Eq. (101). The pd cross section $d\sigma^{pd}(p, p_d)/(dx_1 dx_2)$ is the sum of the nucleon contribution calculated from Eq. (111) and the pion contribution from Eq. (112). To compare with the results of Ref. [5], the nucleon PDFs $f_p^q(x)$ of CTEQ5m [35] is used in our calculations. The PDFs $f_\pi^q(x)$ for the pion is taken from Ref. [28].

From Eq. (111), it is clear that the nucleon Fermi motion effects are in $F_{p_d,N}^q(x_2)$ defined by in Eq. (108). If we set $p_{\text{ave}}^z/p_N^z \rightarrow 1$ in Eq. (108), $F_{p_d,N}^q(x_2) \rightarrow f_N^q(x_2)$ since $\int d\vec{p}_N \rho_{p_d}(\vec{p}_N) = 1$ as defined by the normalization of states. The calculation of Eq. (111) with $F_{p_d,N}^q(x_2) \rightarrow f_N^q(x_2)$ is then identical to that based on Eq. (2) of Ref. [5]. The differences between this calculation and that from using Eqs. (111) and (108) will indicate the importance of nucleon Fermi motion effect on pd DY cross sections.

To calculate the pion contribution with Eq. (112), we need to first evaluate $F_{p_d,\pi}^q(x_2)$ defined by Eq. (113). The pion momentum $\rho_{p_d}(\vec{k}_\pi)$ in Eq. (113) is calculated from using the relation Eq. (83) and $\rho_\pi^{\text{exc}}(\vec{k})$ defined by Eq. (69). We see from Eq. (69) that the pion momentum distribution $\rho_\pi^{\text{exc}}(\vec{k})$ depends on the πNN form factor $F(\Lambda_{\pi NN}, \vec{k})$ [Eq. (48)]. Following the previous πNN studies [29, 37], this form factor must be consistent with πN scattering data. In this work, we apply the πN model formulated in Ref. [41] to determine the $F(\Lambda_{\pi NN}, k)$ by fitting the πN partial wave amplitudes [42] up to invariant mass $W = 1.3$ GeV. The πN scattering within this model has been given in Ref. [41] and will not be repeated here. Our fits are shown in Fig. 5. The resulting parameters are not relevant to

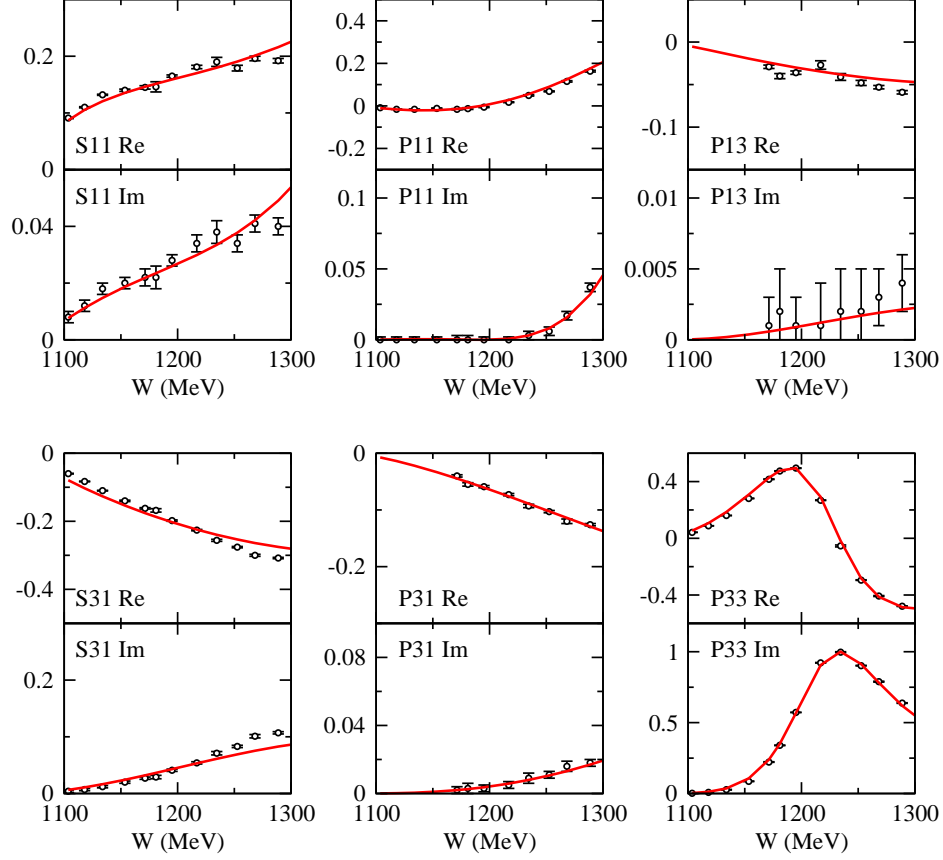

FIG. 5. (color online) Results of the fit to πN scattering amplitudes [42] up to $W = 1.3$ GeV.

this work and are therefore not presented. For our calculation, we only need the resulting πNN form factor.

We see in Fig. 6 that the resulting πNN form factor can be fitted by the following modified dipole form

$$F(\Lambda_{\pi NN}, k) = \left(\frac{\Lambda_{\pi NN}^2 - \kappa^2}{\Lambda_{\pi NN}^2 + k^2} \right)^2 [1 + a(1 + k^2/\kappa^2)] \exp[-b(1 + k^2/\kappa^2)], \quad (117)$$

where $\kappa = m_\pi \sqrt{1 - [m_\pi^2/(4m_N^2)]}$, $\Lambda_{\pi NN} = 685.7$ MeV, $a = 1.67 \times 10^{-3}$, $b = 2.79 \times 10^{-4}$. It is close to the usual dipole form $F(\Lambda_{\pi NN}, k) = \left(\frac{\Lambda_{\pi NN}^2 - \kappa^2}{\Lambda_{\pi NN}^2 + k^2} \right)^2$ with $\Lambda_{\pi NN} = 810.6$ MeV.

The pion momentum distribution $\rho_\pi^{\text{exc}}(\vec{k})$ calculated from Eq. (69) with the πNN form factor given in Eq. (117) is the dashed curve in Fig. 7. Here we also show the nucleon momentum distribution $\rho_N(p)$ (solid curve). Note that $\rho_\pi^{\text{exc}}(p)$ changes sign at $p \sim 200$ MeV. This sign change is also seen in the calculation of pion-excess in Ref. [38], except that their magnitudes are much larger because they use a much larger πNN cutoff $\Lambda \sim 1400$ MeV for a dipole form of a non-relativistic NN potential.

With the input specified above, we can calculate ratio $R_{pd/pp}$ defined by Eq. (116). We compare three results: (1) No nucleon Fermi motion (FM) and no pion-exchange (π -exc) from using Eq. (111) with $F_{pd,N}^q(x_2) \rightarrow f_N^q(x_2)$; (2) With FM and no π -exc from using Eq. (111); (3) With FM and with π -exc from adding the results from using Eq. (111) and Eq. (112).

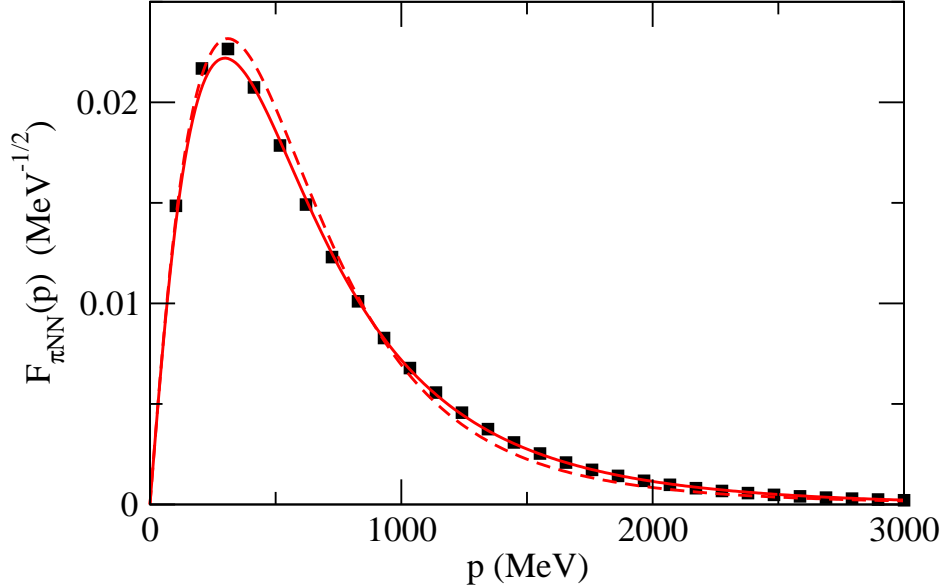

FIG. 6. (color online) Filled squares are the πNN form factor obtained from fitting the πN partial wave amplitudes [42]. Solid and dashed curves are two different fits to the form factor using the parametrization of Eqs. (117) and dipole form $F(\Lambda_{\pi NN}, k) = \left(\frac{\Lambda_{\pi NN}^2 - \kappa^2}{\Lambda_{\pi NN}^2 + k^2} \right)^2$ with $\Lambda_{\pi NN} = 810.6$ MeV

In Fig. 8, the calculated $R_{pd/pp}$ at 800 GeV are compared with the data of Ref. [5]. Our results with no Fermi motion and no pion-exchange (dot-dashed curve) are similar to that presented in Ref. [5]. The differences between the dash-dotted and dashed curves are due to the Fermi motion of nucleon inside the deuteron. The solid curve also include the pion-exchange effects. All three results are close to the data. Clearly, the nucleon Fermi motion and pion-exchange effects are small in the region covered by this experiment. Our results shown in Fig. 8 suggest that the simple formula Eq. (2) is valid to extract the \bar{d}/\bar{u} ratio in the proton in the small $x_2 \lesssim 0.3$ region.

To facilitate the analysis of the forthcoming data from Fermilab, we present our prediction at 120 GeV in Fig. 9. We see that the Fermi motion and pion-exchange effects are small in the $x_2 < 0.4$. However these two effects are significant at larger x_2 . We have observed that the rapidly raising effect due to pion-exchange is due to the fact that the parton distribution in the pion is much larger than that for the nucleon at large x , as seen in Fig. 10. Clearly, it is necessary to include the Fermi motion and pion-exchange effects to extract the ratio \bar{d}/\bar{u} in the proton from the data of $R_{pd/pp}$ in the large x_2 region.

VII. SUMMARY

For investigating the pion-exchange and nucleon Fermi-motion effects on the DY process in proton-deuteron(pd) reactions, we have derived convolution formula starting with a nuclear model within which the deuteron has NN and πNN components. The nucleon Fermi motion is included by the convolution of PDFs of the nucleon over the nucleon momentum distribution calculated from the NN component. The contribution from the πNN component is expressed in terms of a convolution of PDFs of the pion over a pion momentum

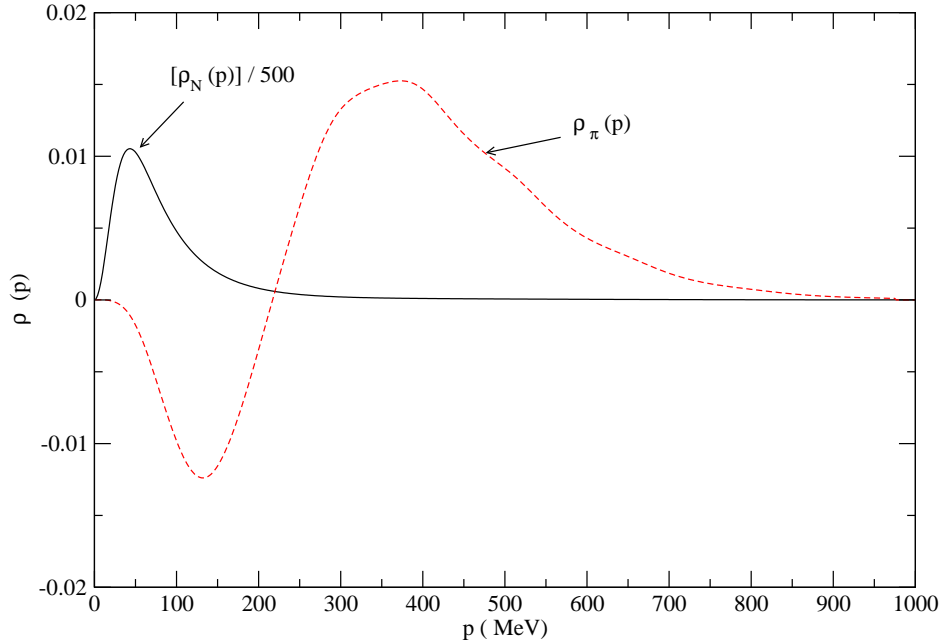

FIG. 7. (color online) The momentum distribution $4\pi p^2 \rho(p)$ of the pion (π) and the nucleon (N) in the deuteron. Note that $4\pi p^2 \rho_N(p)$ is multiplied by a factor 1/500.

distribution that depends sensitively on the πNN form factor. With a πNN form factor determined by fitting the πN scattering data up to invariant mass $W = 1.3$ GeV, we find that the pion-exchange and nucleon Fermi-motion effects can change significantly the ratios between the proton-deuteron and proton-proton DY cross sections $R_{pd/pp} = \sigma^{pd}/(2\sigma^{pp})$ in the region where the partons emitted from the target deuteron are in the Bjorken $x_2 \gtrsim 0.4$ region. The calculated ratios $R_{pd/pp}$ at 800 GeV agree with the available data. For analyzing the forthcoming data from Fermilab, we also have made predictions at 120 GeV.

ACKNOWLEDGMENTS

We would like to thank Donald Geesaman, Roy Holt, and Jen-Chieh Peng for their very helpful discussions. This work is supported by the U.S. Department of Energy, Office of Nuclear Physics Division, under Contract No. DE-AC02-06CH11357. HK acknowledges the support by the HPCI Strategic Program (Field 5 “The Origin of Matter and the Universe”) of Ministry of Education (Japan). This research used resources of the National Energy Research Scientific Computing Center, which is supported by the Office of Science of the U.S. Department of Energy under Contract No. DE-AC02-05CH11231, and resources provided on “Fusion,” a 320-node computing cluster operated by the Laboratory Computing Resource Center at Argonne National Laboratory.

-
- [1] P. Amaudruz *et al.*, (New Muon Collaboration), Phys. Rev. D **50**, R1 (1994).
 - [2] P. L. McGaughey *et al.*, Phys. Rev. Lett. **69**, 1726 (1992).
 - [3] E. A. Hawker *et al.*, Phys. Rev. Lett. **80**, 3715 (1998).

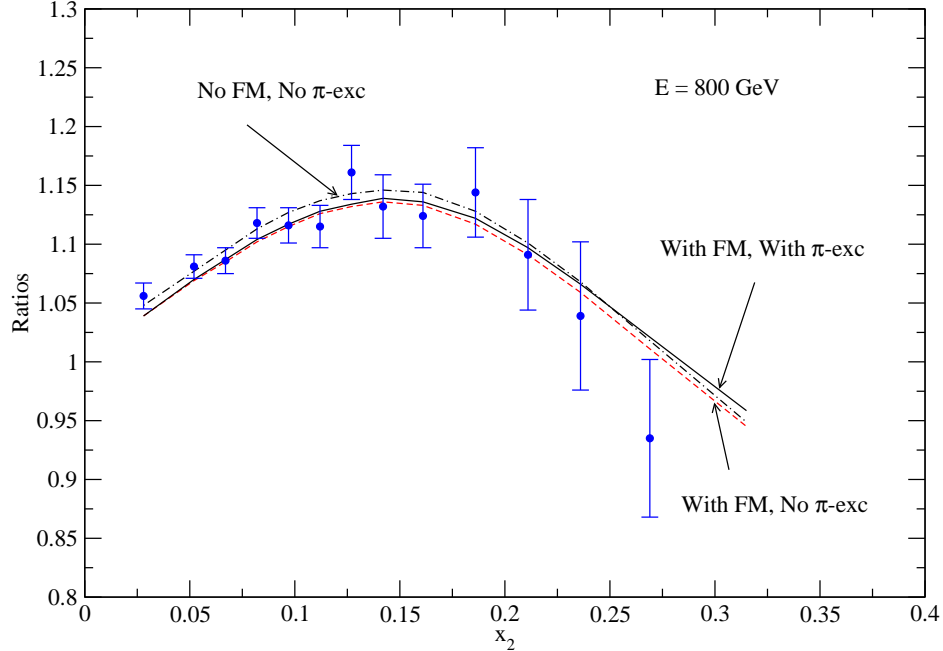

FIG. 8. (color online) Ratio $R_{pd/pp}$ at $E = 800$ GeV. Data are from Ref. [5]. With (No) FM denotes that Fermi motion is included (not included). With (No) π -exc denotes that pion-exchange is included (not included). Note that x_1 for each x_2 is determined by Eq. (93) and given in Ref. [5].

- [4] J. C Peng *et al.*, Phys. Rev. D **58**, 092004 (1998).
- [5] R. S Towell *et al.*, Phys. ReV. D **64**, 052002 (2001).
- [6] S. D. Drell and T.M. Yan, Phys. Rev. Lett. **25**, 316 (1970).
- [7] A. Baldit *et al.* (NA51 Collaboration), Phys. Lett. B **332**, 244 (1994).
- [8] K. Ackerstaff *et al.* (HERMES Collaboration), Phys. Rev. Lett. **81**, 5519 (1998).
- [9] A. W. Thomas, Phys. Lett. **126B**, 97 (1983).
- [10] J. T. Londergan and A. W. Thomas, Prog. Part. Nucl. Phys. **41**, 49 (1998).
- [11] S. Kumano, Phys. Rep. **303**, 183 (1998).
- [12] J. P. Speth and A. W. Thomas, Adv. Nucl. Phys. **24**, 83 (1997).
- [13] S. Kumano, Phys. Rev. D **43**, 59 (1991); **43**, 3067 (1991); S. Kumano and J. T. Londergan, *ibid.* **44**, 717 (1991).
- [14] W.-Y. P. Hwang, J. Speth, and G. E. Brown, Z. Phys. **A339**, 383 (1991); W.-Y. P. Hwang, G. T. Garvey, J. M. Moss, and J.-C. Peng, Phys. Rev. D **47**, 2697 (1993).
- [15] A. Szczurek, J. Speth, and G. T. Garvey, Nucl. Phys. **A570**, 765 (1994).
- [16] W. Koepf, L. L. Frankfurt, and M. Strikman, Phys. Rev. D **53**, 2586 (1996).
- [17] N. N. Nikolaev, W. Schafer, A. Szczurek, and J. Speth, Phys. Rev. D **60**, 014004 (1999).
- [18] M. Alberg, E. M. Henley, and G. A. Miller, Phys. Lett. B **471**, 396 (2000).
- [19] E. J. Eichten, I. Hinchliffe, and C. Quigg, Phys. Rev. D **45**, 2269 (1992); **47**, R747 (1993).
- [20] A. Szczurek, A. Buchmans, and A. Faessler, J. Phys. G **22**, 1741 (1996).
- [21] P. V. Pobylitsa, M. V. Polyakov, K. Goeke, T. Watabe, and C. Weiss, Phys. Rev. D **59**, 034024 (1999).
- [22] A. E. Dorokhov and N. I. Koelev, Phys. Lett. B **259**, 335 (1991); **304**, 167 (1993).
- [23] W. Melnitchouk, J. Speth, and A. W. Thomas, Phys. Rev. D **59**, 014033 (1998).

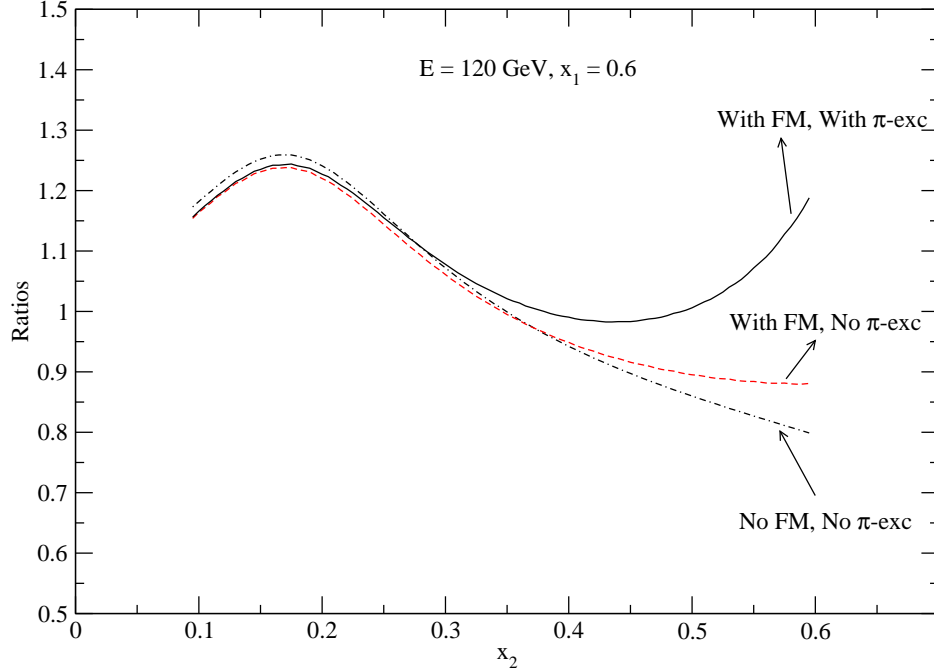

FIG. 9. (color online) Ratio $R_{pd/pp}$ at $E = 120$ GeV and $x_1 = 0.6$. With (No) FM denotes that Fermi motion is included (not included). With (No) π -exc denotes that pion-exchange is included (not included).

- [24] D. F. Geesaman *et al.* (E906 Collaboration), Fermi National Accelerator Laboratory Proposal, 906 (1999).
- [25] D. M. Alde *et al.*, Phys. Rev. Lett. **64**,2479 (1990).
- [26] M. A. Vasiliev *et al.*, Phys. Rev. Lett. **83**,2304 (1999).
- [27] J. S. Conway *et al.*, Phys. Rev. D **39**, 92 (1989).
- [28] K. Wijesooriya, P. E. Reimer and R. J. Holt, Phys. Rev. C **72**, 065203 (2005).
- [29] H. Garcilazo, T. Mizutani, πNN Systems, (World Scientific, Singapore, 1990).
- [30] R. B. Wiringa, V. G. J. Stoks, and R. Schiavilla, Phys. Rev. C **51**, 38 (1995).
- [31] H. L. Lai *et al.*, Phys. Rev. D **55**, 1280 (1997).
- [32] A. D. Martin, R. G. Roberts, and W. J. Stirling, Phys. Lett. B **387**, 419 (1996).
- [33] M. Gluck, E. Reya, and A. Vogt, Z. Phys. C **67**, 433 (1995).
- [34] H. Plothow-Besch, Int. J. Mod. Phys. A **10**, 2901 (1995); Comput. Phys. Commun. **75**, 396 (1993).
- [35] H. L. Lai *et al.*, Eur. Phys. J. C **12**, 375 (2000).
- [36] J. D. Bjorken and S. D. Drell, *Relativistic Quantum Field Theory*, (McGraw-Hill, New York, 1964).
- [37] T.-S. H. Lee and A. Matsuyama, Phys. Rev. C **32**, 516 (1985); **36**, 1459 (1987).
- [38] B. L. Friman, V. R. Pandharipande, and R. B. Wiringa, Phys. Rev. Lett. **51**, 763 (1983).
- [39] E. L. Berger, F. Coester, and R. B. Wiringa, Phys. Rev. D **29**, 398 (1984).
- [40] B. D. Keister and W. N. Polyzou, Adv. Nucl. Phys. **20**, 225 (1991).
- [41] H. Kamano, S. X. Nakamura, T.-S. H. Lee, and T. Sato, Phys. Rev. C **81** 065207 (2010).
- [42] CNS Data Analysis Center, GWU, <http://gwdac.phys.gwu.edu>.

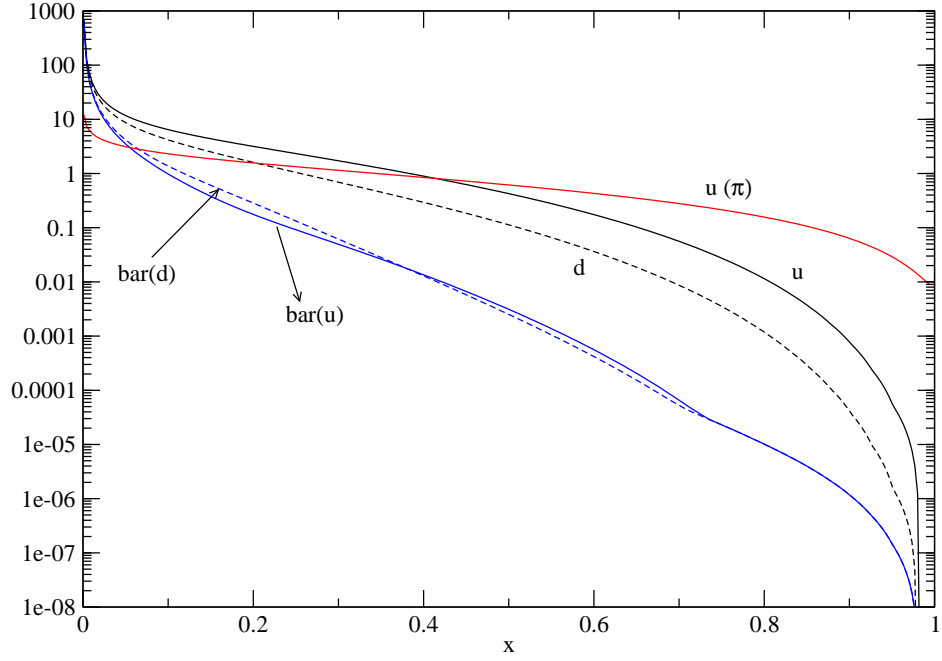

FIG. 10. (color online) Comparison of PDFs of the proton [35] [\bar{u} is denoted by $\text{bar}(u)$ and \bar{d} by $\text{bar}(d)$] with that of the pion [28] [$u(\pi)$, note that $\bar{u}(\pi) = u(\pi)$].