

# COMPUTING MATVEEV'S COMPLEXITY VIA CRYSTALLIZATION THEORY: THE BOUNDARY CASE

Maria Rita CASALI - Paola CRISTOFORI

Dipartimento di Matematica  
Università di Modena e Reggio Emilia  
Via Campi 213 B, I-41125 MODENA (Italy)

July 14, 2018

## Abstract

The notion of *Gem-Matveev complexity* (*GM-complexity*) has been introduced within crystallization theory, as a combinatorial method to estimate Matveev's complexity of closed 3-manifolds; it yielded upper bounds for interesting classes of such manifolds. In this paper we extend the definition to the case of non-empty boundary and prove that for each compact irreducible and boundary-irreducible 3-manifold it coincides with the *modified Heegaard complexity* introduced in [14]. Moreover, via GM-complexity, we obtain an estimation of Matveev's complexity for all Seifert 3-manifolds with base  $\mathbb{D}^2$  and two exceptional fibers and, therefore, for all torus knot complements.

*2010 Mathematics Subject Classification:* Primary 57M27, 57N10. Secondary 57M15, 57M25.

*Key words and phrases:* 3-manifold with boundary, Matveev's complexity, Heegaard diagram, compression body, handlebody, crystallization, torus knot, Seifert manifold.

## 1. Introduction

The *Matveev's complexity* is a well-known invariant for 3-manifolds, defined in [28] as the minimum number of true vertices among all almost simple spines of the manifold. The 3-sphere, the real projective space, the lens space  $L(3,1)$  and the spherical bundles  $\mathbb{S}^1 \times \mathbb{S}^2$  and  $\mathbb{S}^1 \tilde{\times} \mathbb{S}^2$  have complexity zero by definition. Apart from these special cases, the Matveev's complexity  $c(M)$  of

a closed prime 3-manifold  $M$  turns out to be the minimum number of tetrahedra needed to obtain  $M$  via face paring of them (see [28, Proposition 2], together with the related Remark).

The idea of estimating  $c(M)$  by using Heegaard decompositions is already suggested in the foundational paper [28]: if  $H = (S, \mathbf{v}, \mathbf{w})$  is a Heegaard diagram of  $M$ , an upper bound for  $c(M)$  is easily provided by the almost simple spines of  $M$  obtained by adding to the surface  $S$  the meridian disks corresponding to the systems of curves  $\mathbf{v}$  and  $\mathbf{w}$  and by removing the 2-disk corresponding to an arbitrary region  $\bar{R}$  of  $S \setminus (\mathbf{v} \cup \mathbf{w})$ . Obviously, the true vertices of the considered spine of  $M$  are the intersection points of the curves of the two systems, with the exception of those which lie on the boundary of the region  $\bar{R}$ ; hence

$$c(M) \leq n - m,$$

where  $n$  (resp.  $m$ ) denotes the number of intersection points between  $\mathbf{v}$  and  $\mathbf{w}$  (resp. the number of intersection points contained in  $\bar{R}$ ).

Starting from this idea, two different approaches to Matveev's complexity computation have been recently developed. The first one has been introduced in 2004 for closed 3-manifolds and is based on *crystallization theory*<sup>1</sup>: it has led to the notion of *Gem-Matveev complexity*, *GM-complexity* for short (see [8], together with subsequent papers [9] and [10]). Later, in 2010, the *modified Heegaard complexity* (*HM-complexity*) of a compact 3-manifold has been defined via *generalized Heegaard diagrams* (see [14]).<sup>2</sup> Both invariants have been proved to be upper bounds for the Matveev's complexity.

Moreover, the coincidence of Gem-Matveev complexity and modified Heegaard complexity is established in [11] for each closed 3-manifold.

The aim of the present paper is to extend the definition of Gem-Matveev complexity to the case of 3-manifolds with non-empty boundary (Section 4), and to prove that *GM-complexity* and *HM-complexity* turn out to be useful different tools to compute the same upper bound for Matveev's complexity, in the whole setting of compact irreducible and boundary irreducible 3-manifolds.

**Proposition 1 (Main result)** *For every compact irreducible and boundary-irreducible 3-manifold  $M$ ,*

$$c_{GM}(M) = c_{HM}(M),$$

*where  $c_{GM}(M)$  (resp.  $c_{HM}(M)$ ) denotes the Gem-Matveev complexity (resp. the modified Heegaard complexity) of  $M$ .*

The possibility of effectively computing GM-complexity in a direct and algorithmic way from any graph representing  $M$  or its associated singular manifold (see Section 5) allows to extend to the boundary case the search for estimations of the Matveev's complexity via  $c_{GM}(M)$ , as already obtained in the closed case for interesting classes of 3-manifolds: in particular, in [9], GM-complexity has produced significant improvements in order to estimate Matveev's complexity for two-fold branched coverings of  $\mathbb{S}^3$ , for three-fold simple branched coverings of  $\mathbb{S}^3$  and for 3-manifolds obtained by Dehn surgery on framed links in  $\mathbb{S}^3$ .

In the last section of the present paper a noteworthy estimation of Matveev's complexity is obtained for all Seifert 3-manifolds with base  $\mathbb{D}^2$  and two exceptional fibers and therefore, as a particular case, of all torus knot complements: see Proposition 13.

<sup>1</sup>Basic elements of this theory are recalled in section 3, where a wide bibliography is also indicated.

<sup>2</sup>Actually, in the original paper [14] the definition is given only in the orientable case, while the non-orientable extension is due to [11].

In some particular cases (including for example, three torus knot complements with complexity one and the orientable I-bundle over the Klein bottle, having complexity zero), the obtained estimation turns out to coincide with the exact value of Matveev's complexity (see Corollary 14).

## 2. Modified Heegaard complexity

The notion of *modified Heegaard complexity* for compact orientable 3-manifolds (either with or without boundary) has been introduced in [14], where a comparison with Matveev's complexity has been discussed. The extension to the non-orientable case has been performed in [11]. In the present section we recall the main elements of the subject, in the widest possible setting.

Let  $\Sigma_g$  be either the closed, connected orientable surface  $T_g$  of genus  $g$  (with  $g \geq 0$ ) or the closed, connected non-orientable surface  $U_{2g}$  of genus  $2g$  (with  $g \geq 1$ ). So  $\Sigma_g$  is the boundary of a handlebody  $\mathbb{X}_g$  of genus  $g$ ,  $\mathbb{X}_g$  being the orientable (resp. non orientable) 3-manifold obtained from the 3-ball  $\mathbb{D}^3$  by adding  $g$  orientable 1-handles (resp.  $g$  1-handles, of which at least one is non-orientable).

A *system of curves* on  $\Sigma_g$  is a (possibly empty) set of simple closed orientation-preserving<sup>3</sup> curves  $\mathcal{C} = \{\gamma_1, \dots, \gamma_k\}$  on  $\Sigma_g$  such that  $\gamma_i \cap \gamma_j = \emptyset$ , for  $1 \leq i \neq j \leq k$ . Moreover, we denote by  $V(\mathcal{C})$  the set of connected components of the surface obtained by cutting  $\Sigma_g$  along the curves of  $\mathcal{C}$ . The system  $\mathcal{C}$  is said to be *proper* if all elements of  $V(\mathcal{C})$  have genus zero, and *reduced* if either  $|V(\mathcal{C})| = 1$  or no element of  $V(\mathcal{C})$  has genus 0. Note that a proper reduced system of curves on  $\Sigma_g$  contains exactly  $g$  curves.

Let  $G(\mathcal{C})$  denote the graph which is dual to the one determined by  $\mathcal{C}$  on  $\Sigma_g$ ; thus, vertices of  $G(\mathcal{C})$  correspond to elements of  $V(\mathcal{C})$  and edges correspond to curves of  $\mathcal{C}$ . Note that loops and multiple edges may arise in  $G(\mathcal{C})$ .

A *compression body*  $\mathbb{Y}_g$  of genus  $g$  is a 3-manifold with boundary obtained from  $\Sigma_g \times [0, 1]$  by attaching a finite set of 2-handles along a system of curves (called *attaching circles*) on  $\Sigma_g \times \{0\}$  and filling in with balls all the spherical boundary components of the resulting manifold, except  $\Sigma_g \times \{1\}$  when  $g = 0$ . Moreover,  $\partial_+ \mathbb{Y}_g = \Sigma_g \times \{1\}$  is called the *positive* boundary of  $\mathbb{Y}_g$ , while  $\partial_- \mathbb{Y}_g = \partial \mathbb{Y}_g - \partial_+ \mathbb{Y}_g$  is called the *negative* boundary of  $\mathbb{Y}_g$ . A compression body turns out to be a handlebody if and only if  $\partial_- \mathbb{Y}_g = \emptyset$ , i.e., the system of the attaching circles on  $\Sigma_g \times \{0\}$  is proper. Obviously homeomorphic compression bodies can be obtained via (infinitely many) non-isotopic systems of attaching circles.

If a system of attaching circles  $\mathcal{C}$  yielding  $\mathbb{Y}_g$  is not reduced, then it contains at least one reduced subsystem of curves determining the same compression body  $\mathbb{Y}_g$ . Indeed, let  $V^+(\mathcal{C})$  be the set of vertices of  $G(\mathcal{C})$  corresponding to the components with genus greater than zero, and  $\mathcal{A}(\mathcal{C})$  be the set consisting of all the subgraphs  $T$  of  $G(\mathcal{C})$  such that:

- $T$  contains all vertices of  $G(\mathcal{C})$ ;
- if  $V^+(\mathcal{C}) = \emptyset$ ,  $T$  is a (maximal) tree in  $G(\mathcal{C})$ ;

---

<sup>3</sup>This means that each curve  $\gamma_i$  has an annular regular neighborhood, as it always happens if  $\Sigma_g$  is an orientable surface.

- if  $V^+(\mathcal{C}) \neq \emptyset$ , each connected component of  $T$  is a tree containing exactly one vertex of  $V^+(\mathcal{C})$ .

Then, for any  $T \in \mathcal{A}(\mathcal{C})$ , the system of curves obtained by removing from  $\mathcal{C}$  the curves corresponding to the edges of  $T$  is reduced and determines the same compression body. Note that this operation corresponds to removing complementary 2- and 3-handles. Moreover, if  $\partial_- \mathbb{Y}_g$  is orientable (resp. non-orientable) and has  $h$  boundary components with genus  $\partial g_j$  (resp.  $2 \cdot \partial g_j$ ),  $1 \leq j \leq h$ , then

$$|E(T)| = |\mathcal{C}| - g - \max\{0, h - 1\} + \sum_{j=1}^h \partial g_j$$

for each  $T \in \mathcal{A}(\mathcal{C})$ , where  $E(T)$  denotes the edge set of  $T$ .

Let  $M$  be a compact connected 3-manifold without spherical boundary components. A *Heegaard surface* for  $M$  is a surface  $\Sigma_g$  embedded in  $M$  such that  $M - \Sigma_g$  consists of two components  $X$  and  $Y$  whose closures are (homeomorphic to) a genus  $g$  handlebody and a genus  $g$  compression body, respectively.

The triple  $(\Sigma_g, X, Y)$  is called a (*generalized*) *Heegaard splitting* of genus  $g$  of  $M$ . It is a well known fact that each compact connected 3-manifold without spherical boundary components admits a Heegaard splitting.

**Remark 1** By Proposition 2.1.5 of [29], the complexity of a manifold is not affected by puncturing it. So, in order to compute complexity, no loss of generality occurs by assuming that the manifold has no spherical boundary components.

On the other hand, a triple  $\mathcal{H} = (\Sigma_g, \mathcal{C}', \mathcal{C}'')$ , where  $\mathcal{C}'$  and  $\mathcal{C}''$  are two systems of curves on  $\Sigma_g$ , such that they intersect transversally and  $\mathcal{C}'$  is proper, uniquely determines a 3-manifold  $M_{\mathcal{H}}$  corresponding to the (generalized) Heegaard splitting  $(\Sigma_g, X, Y)$ , where  $X$  and  $Y$  are respectively the handlebody and the compression body whose attaching circles correspond to the curves in the two systems. Such a triple is called a *generalized Heegaard diagram* for  $M_{\mathcal{H}}$ .<sup>4</sup>

For each generalized Heegaard diagram  $\mathcal{H} = (\Sigma_g, \mathcal{C}', \mathcal{C}'')$ , we denote by  $\Delta(\mathcal{H})$  the graph embedded in  $\Sigma_g$  defined by the curves of  $\mathcal{C}' \cup \mathcal{C}''$ , and by  $\mathcal{R}(\mathcal{H})$  the set of regions of  $\Sigma_g - \Delta(\mathcal{H})$ . Note that  $\Delta(\mathcal{H})$  may have connected components which are circles. All vertices not belonging in these components are 4-valent and they are called *singular* vertices. A diagram  $\mathcal{H}$  is called *reduced Heegaard diagram* if both systems of curves are reduced. If  $\mathcal{H}$  is non-reduced, any reduction of both its systems of curves yields a reduced Heegaard diagram, which is said to be *obtained* from  $\mathcal{H}$ .

The modified complexity of a reduced Heegaard diagram  $\mathcal{H}'$  is

$$c_{HM}(\mathcal{H}') = n(\mathcal{H}') - \max \{m(R) \mid R \in \mathcal{R}(\mathcal{H}')\},$$

where  $n(\mathcal{H}')$  is the number of singular vertices of  $\Delta(\mathcal{H}')$  and  $m(R)$  denotes the number of singular vertices contained in the region  $R$ ; while the modified complexity of a (non-reduced) generalized Heegaard diagram  $\mathcal{H}$  is

$$c_{HM}(\mathcal{H}) = \min \{c_{HM}(\mathcal{H}') \mid \mathcal{H}' \text{ reduced Heegaard diagram obtained from } \mathcal{H}\}.$$

---

<sup>4</sup>In the case of closed 3-manifolds, both systems of curves of a generalized Heegaard diagram  $\mathcal{H}$  are obviously proper; if they are also reduced,  $\mathcal{H}$  is simply a Heegaard diagram in the classical sense (see [25]).

We define the *modified Heegaard complexity* of a compact connected 3-manifold  $M$  as

$$c_{HM}(M) = \min \{c_{HM}(\mathcal{H}) \mid \mathcal{H} \text{ generalized Heegaard diagram of } M\}.$$

The significance of modified Heegaard complexity consists in its relation with Matveev's complexity  $c(M)$  (see [14] for the orientable case and [11] for the general one):

**Proposition 2** *If  $M$  is a compact connected 3-manifold, then*

$$c(M) \leq c_{HM}(M).$$

### 3. Basic notions of crystallization theory

The present section is devoted to briefly review some basic concepts of the representation theory of PL-manifolds by a particular type of edge-coloured graphs, called crystallizations.

For general PL-topology and elementary notions about graphs and embeddings, we refer to [26] and [31] respectively.

Crystallization theory is a combinatorial tool for representing compact PL-manifolds, without assumptions about dimension, connectedness, orientability or boundary properties (see the survey papers [17], [1] and [2], together with their wide bibliography). However, since this paper concerns only dimension 3, we will restrict definitions and results to this dimension, although they mostly hold for the general case; moreover, from now on all manifolds will be assumed to be compact and connected.

Given a pseudocomplex  $K$ , triangulating a 3-manifold  $M$ , a *coloration* on  $K$  is a labelling of its vertices by  $\Delta_3 = \{0, 1, 2, 3\}$ , so that:

- the labelling is injective on each simplex of  $K$ ;
- each 3-labelled vertex is internal in  $K$ .

The dual 1-skeleton of  $K$  is a (multi)graph  $\Gamma = (V(\Gamma), E(\Gamma))$  embedded in  $|K| = M$ ; we can define a map  $\gamma : E(\Gamma) \rightarrow \Delta_3$  in the following way:  $\gamma(e) = c$  iff the vertices of the face dual to  $e$  are coloured by  $\Delta_3 - \{c\}$ . The map  $\gamma$  - which is injective on each pair of adjacent edges of the graph - is called an *edge-coloration* on  $\Gamma$ , while the pair  $(\Gamma, \gamma)$  is called a *4-coloured graph representing  $M$*  or simply a *gem* (where “gem” stands for *graph encoded manifold*: see [27]). In order to avoid long notations, in the following we will often omit the edge-coloration when it is not necessary, and we will simply write  $\Gamma$  instead of  $(\Gamma, \gamma)$ .

Obviously, any 3-manifold  $M$  has a gem inducing it: just take the barycentric subdivision  $H'$  of any pseudocomplex  $H$  triangulating  $M$ , label any vertex of  $H'$  with the dimension of the open simplex containing it in  $H$ , and construct the associated 4-coloured graph as described above. Conversely, starting from  $\Gamma$ , we can always reconstruct  $K(\Gamma) = K$  and hence the manifold  $M$ :

- take a 3-simplex  $\sigma(v)$  for each vertex  $v \in V(\Gamma)$ ;

- for each  $i \in \Delta_3$  and for each pair  $v, w$  of  $i$ -adjacent vertices of  $\Gamma$ , identify the faces of  $\sigma(v)$  and  $\sigma(w)$  opposite to the  $i$ -coloured vertices, taking care to identify vertices of the same colour.

It is easy to see that, if  $M$  is a closed 3-manifold, any gem of  $M$  is a regular graph of degree 4, while any gem  $\Gamma$  of a 3-manifold  $M$  with non-empty boundary has a subset of vertices - called *boundary vertices* - of degree 3 - which lack in the 3-coloured edges and correspond to the tetrahedra of  $K(\Gamma)$  having a boundary face.

Given  $i, j \in \Delta_3$ ,  $i \neq j$ , we denote by  $(\Gamma_{i,j}, \gamma_{i,j})$  the 2-coloured graph obtained from  $\Gamma$  by deleting all edges which are not  $i$ - or  $j$ -coloured. The connected components of  $\Gamma_{i,j}$  will be called  $\{i, j\}$ -*residues* of  $\Gamma$ , and their number will be denoted by  $g_{i,j}$ .

As a consequence of the above constructions, a bijection is established between the set of  $\{i, j\}$ -residues of  $\Gamma$  and the set of 1-simplices of  $K(\Gamma)$  whose endpoints are labelled by  $\Delta_3 - \{i, j\}$ . Moreover, for each  $c \in \Delta_3$ , the connected components of the 3-coloured graph  $\Gamma_{\hat{c}}$  obtained from  $\Gamma$  by deleting all  $c$ -coloured edges will be called  $\hat{c}$ -*residues* of  $\Gamma$ ; they are in bijective correspondence with the  $c$ -labelled vertices of  $K(\Gamma)$  and their number will be denoted by  $g_{\hat{c}}$ .

Note that, given a 4-coloured graph  $(\Gamma, \gamma)$ ,  $|K(\Gamma)|$  is a 3-manifold if and only if, for every  $c \in \Delta_3$ , each connected component  $\Xi$  of  $\Gamma_{\hat{c}}$  represents<sup>5</sup> either  $\mathbb{S}^2$  or  $\mathbb{D}^2$  : in the first (resp. latter) case  $\Xi$  corresponds to a internal (resp. boundary) vertex of  $K(\Gamma)$ .<sup>6</sup>

We will call  $(\Gamma, \gamma)$  *contracted* iff  $K(\Gamma)$  has the the minimal number of vertices. This means that:

- $\Gamma_{\hat{c}}$  is connected for each  $c \in \Delta_3$ , in case  $K(\Gamma)$  has either empty or connected boundary;
- $\Gamma_{\hat{3}}$  is connected and  $\Gamma_{\hat{c}}$  (for each  $c \in \{0, 1, 2\}$ ) has exactly  $h$  connected components, in case  $K(\Gamma)$  has  $h \geq 2$  boundary components.

A contracted 4-coloured graph representing a 3-manifold  $M$  is called a *crystallization* of  $M$ . It is well-known that every 3-manifold admits a crystallization (see [17], together with its references). Any crystallization (or more generally any gem)  $\Gamma$  of  $M$  encodes in a combinatorial way the topological properties of  $M$ . For example,  $M$  is orientable iff  $\Gamma$  is bipartite.

In order to understand the strong relation existing between gems and (generalized) Heegaard splittings, even in the boundary case, a particular type of embeddings of a 4-coloured graph into a surface has to be introduced (see [21] and [22], where the following definitions and results are given in arbitrary dimension).

Let  $(\Gamma, \gamma)$  be a 4-coloured graph with non-empty boundary (representing a compact 3-manifold); we call *extended graph associated to*  $(\Gamma, \gamma)$  the 4-coloured graph  $(\Gamma^*, \gamma^*)$  obtained in the following way:

- add to  $V(\Gamma)$  a set  $V^*$  in bijective correspondence with the set of boundary vertices of  $(\Gamma, \gamma)$ ;
- add to  $E(\Gamma)$  the set of all possible 3-coloured edges having as endpoints a boundary vertex of  $(\Gamma, \gamma)$  and its corresponding vertex in  $V^*$ .

---

<sup>5</sup>By obvious adjustments of the previous notions, a 2-dimensional PL-manifold may be encoded by a 3-coloured graph, which *represents* it.

<sup>6</sup>See [19] for definitions and results about 4-coloured graphs representing polyhedra which fail to be 3-manifolds. In particular, in Section 5, we will make use also of 4-coloured graphs representing *singular 3-manifolds*, and hence we will admit a  $\hat{c}$ -residue to represent a surface with genus different from zero.

A *regular imbedding* of  $(\Gamma, \gamma)$  into a surface (with boundary)  $F$  is a cellular imbedding of  $(\Gamma^*, \gamma^*)$  into  $F$ , such that:

- the image of a vertex of  $\Gamma^*$  lies in  $\partial F$  iff the vertex belongs to  $V^*$ ;
- the boundary of any region of the imbedding is either the image of a cycle of  $(\Gamma^*, \gamma^*)$  (*internal region*) or the union of the image  $\alpha$  of a path in  $(\Gamma^*, \gamma^*)$  and an arc of  $\partial F$ , the intersection consisting of the images of two vertices belonging to  $V^*$  (*boundary region*);
- there exists a cyclic permutation  $\varepsilon = (\varepsilon_0, \varepsilon_1, \varepsilon_2, \varepsilon_3 = 3)$  of  $\Delta_3$  such that for each internal region (resp. boundary region), the edges of its boundary (resp. of  $\alpha$ ) are alternatively coloured  $\varepsilon_i$  and  $\varepsilon_{i+1}$ ,  $i \in \mathbb{Z}_4$ .

For each cyclic permutation  $\varepsilon$  of  $\Delta_3$ , a regular imbedding of  $(\Gamma, \gamma)$  into a surface (with boundary)  $F_\varepsilon$  is proved to exist.  $F_\varepsilon$  is called the *regular surface* associated to  $(\Gamma, \gamma)$  and  $\varepsilon$ ; it is orientable iff  $(\Gamma, \gamma)$  is bipartite.

In the case of  $\Gamma$  bipartite (resp. non-bipartite), the *regular genus*  $\rho_\varepsilon(\Gamma)$  of  $\Gamma$  with respect to  $\varepsilon$  is defined as the classical genus (resp. half the classical genus) of the surface  $F_\varepsilon$ .

In any dimension,  $\rho_\varepsilon(\Gamma)$  may be computed by a suitable combinatorial formula. In particular, in dimension 3, we have:

$$\rho_\varepsilon(\Gamma) = g_{\varepsilon_0\varepsilon_2} - g_{\varepsilon_1} - g_3 + 1 \quad (\text{or, equivalently: } \rho_\varepsilon(\Gamma) = g_{\varepsilon_13} - g_{\varepsilon_0} - g_{\varepsilon_2} + 1)$$

We point out that, for each compact 3-manifold  $M$ , the Heegaard genus of  $M$  coincides with the minimum value of  $\rho_\varepsilon(\Gamma)$ , where  $\Gamma$  is a gem of  $M$  and  $\varepsilon$  is a cyclic permutation of  $\Delta_3$  (see [20] for the closed case, [16] and [15] for the boundary case).<sup>7</sup>

## 4 GM-complexity for compact 3-manifolds

Let  $M$  be a compact 3-manifold and let  $\Gamma$  be a gem representing  $M$ . Since the theory concerning closed 3-manifolds has already been developed (see [8], [9] and [10]), in the following we will suppose  $\partial M \neq \emptyset$ ; let  $h \geq 1$  the number of connected components of  $\partial M$ .

If  $\alpha \in \Delta_2$  is an arbitrarily fixed colour, we set  $\Delta_3 = \{\alpha, \beta, \beta', 3\}$  and consider the cyclic permutation  $\varepsilon = (\beta, \alpha, \beta', 3)$  of  $\Delta_3$ .

We denote by  $K_{\alpha 3}$  (resp.  $K_{\beta\beta'}$ ) the 1-dimensional subcomplex of  $K = K(\Gamma)$  generated by the  $\alpha$ - and 3- (resp.  $\beta$ - and  $\beta'$ -) labelled vertices. Let  $H_\alpha$  be the largest 2-dimensional subcomplex of the first barycentric subdivision of  $K$  not intersecting the subdivisions of  $K_{\alpha 3}$  and  $K_{\beta\beta'}$ , and set  $F^{(\alpha)} = |H_\alpha|$ .

The surface (with boundary)  $F^{(\alpha)}$  splits  $K(\Gamma)$  into two polyhedra  $\mathcal{A}_{\alpha 3}$  and  $\mathcal{A}_{\beta\beta'}$  (see Figure 1). It is not difficult to check - by constructions described in [21] and [22] - that  $F^{(\alpha)}$  is the surface into which  $\Gamma$  regularly embeds with respect to the chosen permutation  $\varepsilon$ .

---

<sup>7</sup>Actually,  $\mathcal{G}(M) = \min\{\rho_\varepsilon(\Gamma) \mid (\Gamma, \gamma) \text{ gem of } M, \varepsilon \text{ cyclic permutation of } \Delta_n\}$  is an interesting PL-manifold invariant, called *regular genus*, which extends to arbitrary dimension the classical notion of Heegaard genus of a 3-manifold (see [20] for details). By means of regular genus, important classification results have been obtained within crystallization theory: see, for example, [5] and [13] for dimension four, [12], [6] and [7] for dimension five.

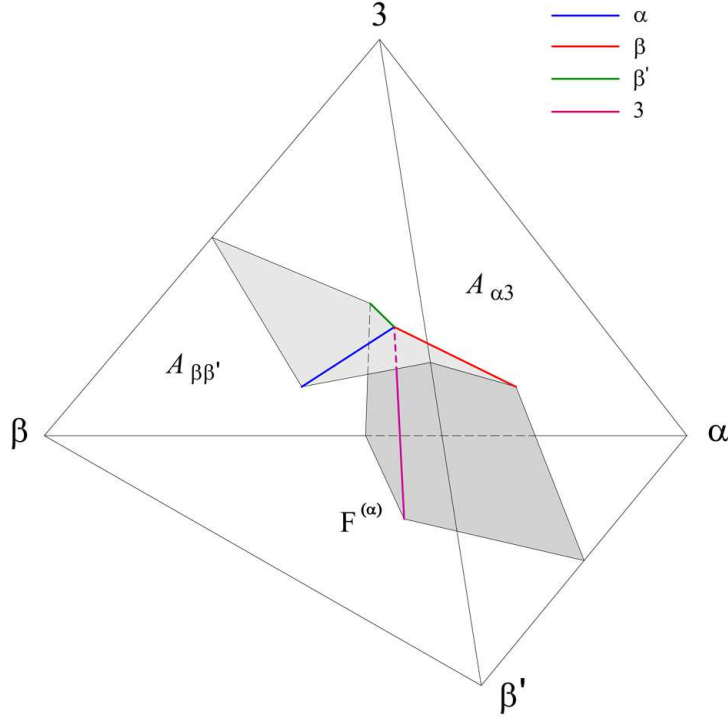

Figure 1: the local splitting of  $K(\Gamma)$  into  $\mathcal{A}_{\alpha 3}$  and  $\mathcal{A}_{\beta\beta'}$

$\mathcal{A}_{\alpha 3}$  (resp.  $\mathcal{A}_{\beta\beta'}$ ) is a handlebody, since it collapses to the graph  $K_{\alpha 3}$  (resp.  $K_{\beta\beta'}$ ).

Furthermore, note that  $\mathcal{A}_{\alpha 3} \cap \mathcal{A}_{\beta\beta'} = \partial\mathcal{A}_{\alpha 3} \cap \partial\mathcal{A}_{\beta\beta'} = F^{(\alpha)}$ .

Since  $\partial M \neq \emptyset$ , the two handlebodies do not intersect on their whole boundaries; in particular  $\partial\mathcal{A}_{\alpha 3} \cap \partial M = \bigcup_{i=1}^t \mathbb{D}_i$ , where the  $\mathbb{D}_i$ 's are 2-disks, such that  $\partial\mathbb{D}_i = lk(P_i, (\partial K)')$  for each  $i = 1, \dots, t$ , where  $P_1, P_2, \dots, P_t$  ( $t \geq h \geq 1$ ) are the  $\alpha$ -labelled vertices of  $\partial K$  and  $(\partial K)'$  denotes the first barycentric subdivision of  $\partial K$ . Moreover,  $\bigcup_{i=1}^t \partial\mathbb{D}_i = \partial F^{(\alpha)}$ .

Let  $\Sigma^{(\alpha)}$  be the closed surface obtained by adding the disks  $\mathbb{D}_1, \dots, \mathbb{D}_t$  to  $F^{(\alpha)}$  and let  $C = \Sigma^{(\alpha)} \times [-1, 1]$  be a collar of  $\Sigma^{(\alpha)}$  in  $\mathcal{A}_{\alpha 3}$ .

We set  $C^- = \Sigma^{(\alpha)} \times [-1, 0]$ ,  $C^+ = \Sigma^{(\alpha)} \times [0, 1]$  and  $S_j = \Sigma^{(\alpha)} \times \{j\}$  for each  $j \in \{-1, 0, 1\}$  (see Figure 2).

Let us define the pseudocomplexes:  $X_\alpha = \overline{\mathcal{A}_{\alpha 3}} \setminus C^-$  and  $Y_\alpha = \mathcal{A}_{\beta\beta'} \cup C^-$ .

$X_\alpha$  is obtained from  $C^+$  by attaching 2-handles to  $S_1$  along the  $\{\beta, \beta'\}$ -coloured cycles of  $\Gamma$  (dual to the 1-simplices of  $K_{\alpha 3}$ ). Hence,  $X_\alpha$  is a compression body, whose system of attaching circles is the set  $\mathbf{v}_\alpha$  of  $\{\beta, \beta'\}$ -coloured cycles of  $\Gamma$  (dual to edges of  $K$  with  $\alpha$ - and 3-coloured endpoints).  $\mathbf{v}_\alpha$  is a proper, not reduced system of curves on the surface  $S_0 \cong \Sigma^{(\alpha)}$ : in fact, all connected components of  $\Sigma^{(\alpha)} \setminus \mathbf{v}_\alpha$  have genus zero, since they are the boundaries of suitable neighborhoods either of the  $\alpha$ -labelled vertices of  $\partial K$  (hence 2-disks) or of the internal  $\alpha$ - and 3-labelled vertices (hence 2-spheres with holes). As a consequence,  $X_\alpha$  turns out to be a handlebody of genus  $g(\Sigma^{(\alpha)}) = g(F^{(\alpha)}) = g_{\beta\beta'} - g_\alpha - g_3 + 1$ . The positive boundary of  $X_\alpha$  is  $S_0$  (while its negative boundary is obviously empty).



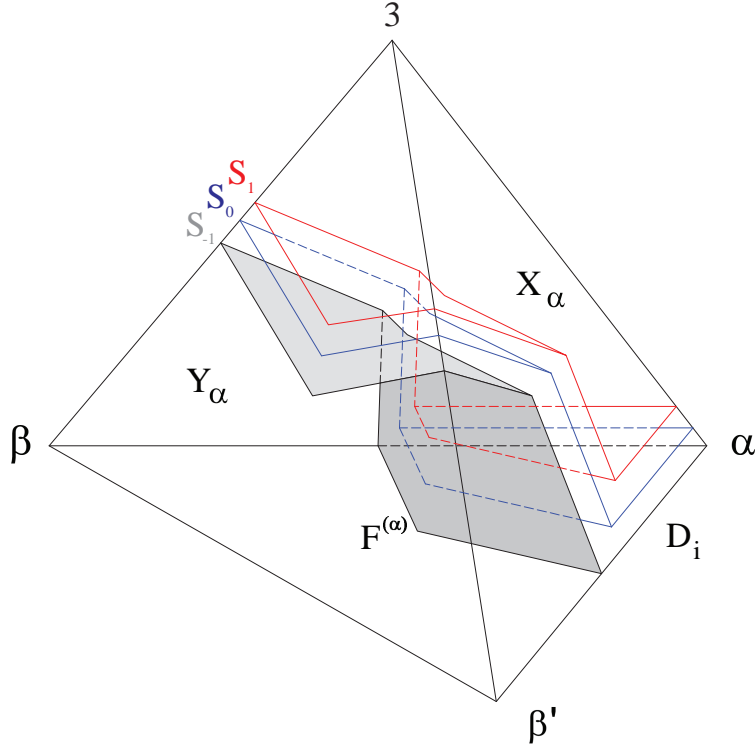

Figure 2: the “double” collar of  $\Sigma^{(\alpha)}$  in  $\mathcal{A}_{\alpha 3}$

On the other hand,  $Y_\alpha$  is a compression body, obtained from  $C^-$  by attaching 2-handles to  $\Sigma^{(\alpha)} = S_{-1}$  along the  $\{\alpha, 3\}$ -coloured cycles of  $\Gamma$  (dual to 1-simplices of  $K_{\beta\beta'}$  not belonging to  $\partial K$ ). The set  $\mathbf{w}_\alpha$  of  $\{\alpha, 3\}$ -coloured cycles of  $\Gamma$  is a not proper (if  $\partial M \neq \emptyset$  with at least one non-spherical component) and generally not reduced (unless  $\Gamma$  is a crystallization) system of curves on  $S_0 \cong \Sigma^{(\alpha)}$ .

Therefore, the triple  $(\Sigma^{(\alpha)}, X_\alpha, Y_\alpha)$  (resp.  $\mathcal{H}_\alpha = (\Sigma^{(\alpha)}, \mathbf{v}_\alpha, \mathbf{w}_\alpha)$ ) is a (generalized) Heegaard splitting (resp. generalized Heegaard diagram) of  $M$ .

In order to get reduced systems of curves, i.e. to obtain a reduced Heegaard diagram for  $M$  starting from  $\mathcal{H}_\alpha$ , let us first denote by  $G_{\beta\beta'}$  the graph obtained from  $K_{\beta\beta'}$  by contracting to one point  $Q_i$  (for each  $i = 1, \dots, h$ ) the vertices of  $K_{\beta\beta'}$  belonging to the  $i$ -th component of  $\partial K$ .

We consider the following sets of curves on  $\Sigma^{(\alpha)}$ :

- (a)  $\mathcal{D}$ , which is a set of  $\{\beta, \beta'\}$ -coloured cycles dual to a maximal tree of  $K_{\alpha 3}$ .
- (b)  $\mathcal{D}'$ , which is a set of  $\{\alpha, 3\}$ -coloured cycles dual to the edges of a subgraph  $\bar{G}$  of  $G_{\beta\beta'}$  such that  $\bar{G}$  is a union of trees containing all vertices of  $G_{\beta\beta'}$  and, for each  $i, j$ ,  $i \neq j$ , the vertices  $Q_i$  and  $Q_j$  belong to different connected components of  $\bar{G}$ .

**Proposition 3**  $\mathcal{H}_\alpha(\mathcal{D}, \mathcal{D}') = (\Sigma^{(\alpha)}, \mathbf{v}_\alpha \setminus \mathcal{D}, \mathbf{w}_\alpha \setminus \mathcal{D}')$  is a reduced Heegaard diagram of  $M$ .

*Proof.* The graph  $K_{\alpha 3}$  is isomorphic to the graph  $G(\mathbf{v}_\alpha)$ , which is the dual 1-skeleton of the cellular decomposition induced by the curves of  $\mathbf{v}_\alpha$  on  $S_0 \cong \Sigma^{(\alpha)}$ . Therefore, by removing from  $\mathbf{v}_\alpha$  the curves of  $\mathcal{D}$ , we get a reduced system of attaching curves for the 2-handles on  $S_1$ , yielding the handlebody  $X_\alpha$ .

On the other hand,  $G_{\beta\beta'}$  is isomorphic to the graph  $G(\mathbf{w}_\alpha)$ , which is the dual 1-skeleton of the cellular decomposition induced by the curves of  $\mathbf{w}_\alpha$  on  $S_0 \cong \Sigma^{(\alpha)}$ . Hence, removing the curves of  $\mathcal{D}'$  from  $\mathbf{w}_\alpha$  does not affect  $Y_\alpha$ , since it corresponds to the cancellation of complementary 2- and 3-handles. □

**Definition 1** Given a gem  $\Gamma$ , with the above notations, we define the *Gem-Matveev complexity* (*GM-complexity* for short) of  $\Gamma$  as

$$c_{GM}(\Gamma) = \min\{c_{HM}(\mathcal{H}_\alpha(\mathcal{D}, \mathcal{D}')) \mid \alpha \in \Delta_2, \mathcal{D} \subset \Gamma_{\alpha 3}, \mathcal{D}' \subset \Gamma_{\beta\beta'} \text{ satisfying (a) e (b)}\}$$

We point out that, although the above definition of GM-complexity is given through the associated generalized Heegaard diagrams, nevertheless it can be computed algorithmically and directly from the graph, as it happens in the closed case ([8]).

**Remark 2** If  $\Gamma$  is crystallization, then a reduced system of curves for the handlebody  $X_\alpha$  is obtained by considering the connected components  $\Xi_i$  ( $i = 1, \dots, h$ )<sup>8</sup> of the subgraph  $\Gamma_{\hat{\alpha}}$  containing boundary vertices and by removing from  $\mathbf{v}_\alpha$  a  $\{\beta, \beta'\}$ -coloured cycle belonging to  $\Xi_i$ , for each  $i = 1, \dots, h$ . The new system has exactly  $g_{\beta\beta'} - h = g(\Sigma^{(\alpha)})$  curves. On the other hand, in this case,  $\mathbf{w}_\alpha$  is an already reduced system.

**Definition 2** Given a compact 3-manifold  $M$ , the *Gem-Matveev complexity* (GM-complexity for short) of  $M$  is defined as

$$c_{GM}(M) = \min\{c_{GM}(\Gamma) \mid \Gamma \text{ gem of } M\}.$$

**Remark 3** Let  $\bar{M}$  be a compact 3-manifold whose boundary has only spherical components and let  $M$  be the closed manifold obtained by capping off with a 3-ball each boundary component of  $\bar{M}$ . Given a gem  $\bar{\Gamma}$  of  $\bar{M}$ , let us suppose  $c_{GM}(\bar{\Gamma}) = c_{HM}(\mathcal{H}_\alpha)$ , where  $\mathcal{H}_\alpha$  is the generalized Heegaard diagram associated to  $\bar{\Gamma}$  and  $\alpha \in \Delta_2$ . Let us fix a colour  $i \in \Delta_2 \setminus \{\alpha\}$  and consider the 4-coloured graph without boundary  $\Gamma$  obtained by joining two boundary vertices  $u$  and  $u'$  of  $\bar{\Gamma}$  by a 3-coloured edge iff there exists a  $\{i, 3\}$ -coloured path in  $\bar{\Gamma}$  having  $u$  and  $u'$  as endpoints. This is a general construction introduced in [20]: starting from a gem of a compact 3-manifold, it produces a gem of the (possibly singular) manifold obtained by capping off each boundary component by a cone. A direct computation of the Euler characteristic shows that the choice of  $i \neq \alpha$  guarantees that  $\Gamma$  regularly embeds into the closed surface  $\Sigma^{(\alpha)}$ , too. Moreover, it is easy to see that  $\Gamma$  admits a reduced Heegaard diagram, which can be obtained from  $\mathcal{H}_\alpha$  and whose HM-complexity is  $c_{HM}(\mathcal{H}_\alpha)$ . Hence  $c_{GM}(\Gamma) = c_{GM}(\bar{\Gamma})$ . Therefore, our definition of GM-complexity for 3-manifolds with non-empty boundary is consistent with the analogous definition for the closed case. Conversely, it is easy to see that, by puncturing a closed manifold, we do not change its GM-complexity, as it happens with Matveev's complexity (see Remark 1).

---

<sup>8</sup>Recall that, if  $\Gamma$  is a crystallization of  $M$  and  $\alpha \in \Delta_2$ ,  $\Gamma_{\hat{\alpha}}$  consists of exactly  $h$  connected 3-coloured graphs with non-empty boundary, where  $h$  is the number of components of  $\partial M$ .

Since the GM-complexity of a gem is, by definition, the HM-complexity of one of its associated generalized Heegaard diagrams, directly from Proposition 3 we have:

**Lemma 4** *For each compact 3-manifold  $M$ ,*

$$c_{HM}(M) \leq c_{GM}(M)$$

□

**Example 1:** Let  $M = T_1 \times I$  be the compact orientable 3-manifold obtained by making the product between the closed orientable genus one surface  $T_1$  (i.e., the torus) and the unit interval  $I$ . A crystallization  $\Gamma$  of  $M$  is given in [23, Fig. 2]. Figure 3(a) shows the regular embedding of  $\Gamma$  into the orientable surface  $F_\varepsilon$ , where  $\varepsilon = (0, 1, 2, 3)$ ; note that  $F_\varepsilon$  has genus two and two boundary components, corresponding to the two connected components of  $\partial M$ .

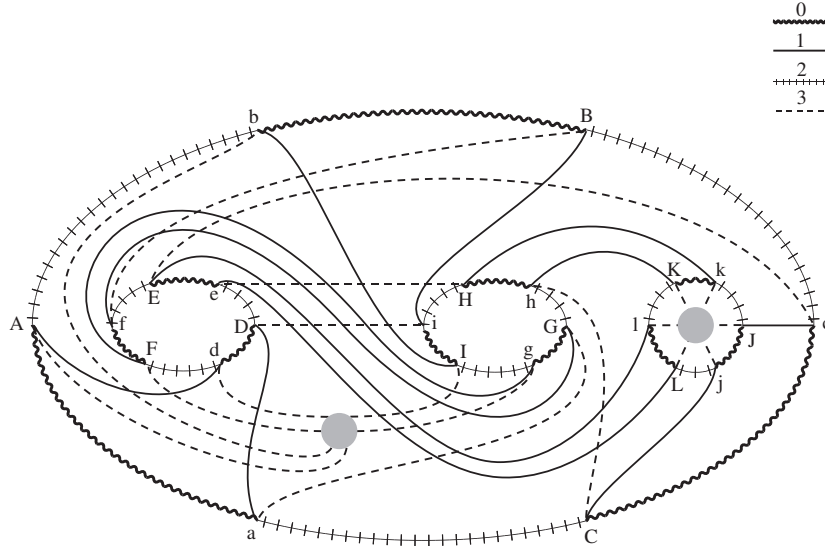

Figure 3(a): a crystallization of  $T_1 \times I$

By Definition 1 and Remark 2,  $c_{GM}(\Gamma)$  may be computed by considering, on the splitting surface  $F_\varepsilon$ , the set  $\mathbf{v}$  of all  $\{0, 2\}$ -coloured cycles of  $\Gamma$ , but one for each connected component of  $\Gamma_{\hat{3}}$ , and the set  $\mathbf{w}$  of all  $\{1, 3\}$ -coloured cycles of  $\Gamma$ . This is equivalent to considering the reduced Heegaard diagram  $\mathcal{H}_1(\mathcal{D}, \mathcal{D}')$  of Proposition 3, where  $\mathcal{D}$  consists of the  $\{0, 2\}$ -coloured cycles having as vertex sets  $\{a, A, b, B, c, C\}$  and  $\{j, J, k, K, l, L\}$  (which are dual to a maximal tree of  $K_{13}$ ) and  $\mathcal{D}' = \emptyset$ . Figure 3(b) shows the intersection points of the curves of this reduced diagram and indicates a region whose boundary contains all the intersection points; hence,  $c_{GM}(\Gamma) = 0$  follows (thus proving the sharpness of the upper bound  $c_{GM}(T_1 \times I) = c_{HM}(T_1 \times I)$  with respect to  $c(T_1 \times I)$ ).

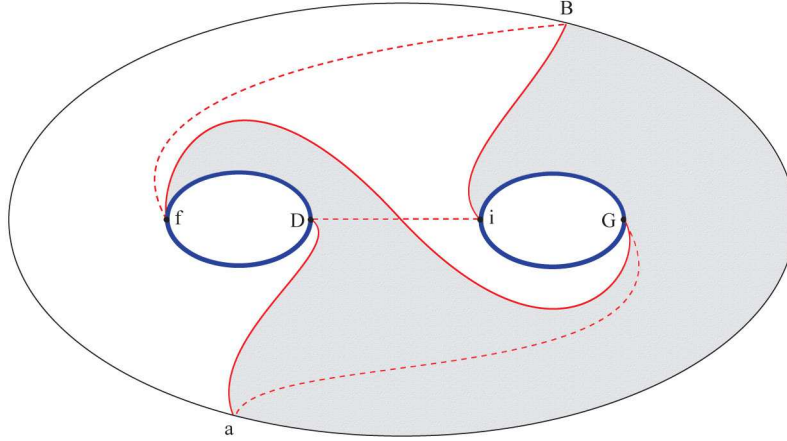

Figure 3(b): a reduced Heegaard diagram of  $T_1 \times I$

## 5. GM-complexity via singular 3-manifolds

In this section, we will extend to singular 3-manifolds some notions of sections 3 and 4; they will be a useful tool in order to prove our main result (Section 6) and to obtain an estimation of Matveev's complexity for all torus knot complements (Section 7).

Let  $\Gamma$  be a *regular* 4-coloured graph. The construction of the pseudocomplex  $K = K(\Gamma)$  described in section 3 - which can be obviously performed even if  $\Gamma$  does not encode a (closed) 3-manifold - establishes a bijective correspondence between the  $\hat{c}$ -residues ( $c \in \Delta_3$ ) of  $\Gamma$  and suitable neighborhoods of the vertices of  $K$ : in fact, any  $\hat{c}$ -residue, dual to a vertex  $v_c \in V(K)$ , represents the surface  $|lk(v_c, K')|$  (see [17]). Moreover, the cone  $v_c * lk(v_c, K')$  is a regular neighborhood of  $v_c$  in  $K$ , called the *disjoint star std*( $v_c, K$ ) of  $v_c$  in  $K$ .

Hence, for any (regular)  $\Gamma$ ,  $|K|$  turns out to be a singular 3-manifold, whose singular points are precisely the vertices of  $K$  which correspond to 3-residues of  $\Gamma$  not representing 2-spheres (see [19]).

In the following we will always suppose that all the singular vertices of  $K$  are labelled by the same colour (which is called the *singular colour* of both  $\Gamma$  and  $K$ ). For sake of simplicity, we will restrict ourselves to the class  $G^{(0)}$  of (regular) 4-coloured graphs  $\Gamma$  with singular colour 0, i.e. such that all  $\hat{c}$ -residues of  $\Gamma$  represent 2-spheres except when  $c = 0$ .

For each  $\Gamma \in G^{(0)}$ , let us denote by  $N = |K(\Gamma)|$  the associated singular 3-manifold and by  $\mathcal{S}(K)$  the (non-empty) set of singular vertices of  $K = K(\Gamma)$ .

Note that a compact 3-manifold  $M = \check{N}$  (having non-empty boundary and no spherical boundary component) is obtained by removing from  $N$  small open neighborhoods of its singular points; hence, we will say - by little abuse - that  $\Gamma \in G^{(0)}$  *represents*  $M$ , too. Conversely, the singular manifold  $N = \widehat{M}$  is (uniquely) obtained from  $M$  by capping off each component of  $\partial M$  by a cone.

Let now  $\Delta_3 = \{0, \alpha, \alpha', \beta\}$ , let  $K_{\alpha\alpha'}$ ,  $K_{0\beta}$  and  $H_\alpha$  be the analogous of the subcomplexes defined in section 4 (in order to recover those definitions, we have simply to set  $\alpha' = 3$  and  $0 = \beta'$ ) and let  $F^{(\alpha)}$  be the (closed) surface triangulated by the 2-complex  $H_\alpha$ .

Furthermore, we denote by  $\mathcal{A}_{\alpha\alpha'}$  and  $\mathcal{A}_{0\beta}$  the two subpolyhedra of  $K$  such that  $\mathcal{A}_{\alpha\alpha'} \cap \mathcal{A}_{0\beta} = F^{(\alpha)}$  and, obviously,  $K_{\alpha\alpha'} \subset \mathcal{A}_{\alpha\alpha'}$ ,  $K_{0\beta} \subset \mathcal{A}_{0\beta}$ . It is easy to see that  $\mathcal{A}_{\alpha\alpha'} \cup \mathcal{A}_{0\beta} = K$  and  $\mathcal{A}_{\alpha\alpha'} \cap \mathcal{A}_{0\beta} = \partial\mathcal{A}_{\alpha\alpha'} \cap \partial\mathcal{A}_{0\beta}$ . As in section 4, we point out that  $F^{(\alpha)}$  is the surface into which  $\Gamma$  regularly embeds with respect to the cyclic permutation  $\varepsilon = (\beta, \alpha, 0, \alpha')$ .

Note that  $X_\alpha = \mathcal{A}_{\alpha\alpha'}$  is a handlebody, since both the  $\alpha$ -coloured and the  $\alpha'$ -coloured vertices of  $K$  are not singular. The set  $\mathbf{v}_\alpha$  of  $\{\beta, 0\}$ -coloured cycles of  $\Gamma$  is a proper, not reduced system of curves on  $F^{(\alpha)}$  defining  $X_\alpha$  as a compression body. In order to get a reduced system from  $\mathbf{v}_\alpha$ , we have, exactly as in section 4, to remove a set  $\mathcal{D}$  of cycles which are dual to the edges of a maximal tree of  $K_{\alpha\alpha'}$ .

Now, for each  $v_0 \in \mathcal{S}(K)$ , let us consider a collar  $C_{v_0}$  of  $lk(v_0, K')$  in the disjoint star of  $v_0$  in  $K$ ; let us define the following subset of  $\mathcal{A}_{0\beta}$ :

$$\mathcal{U} = \bigcup_{v_0 \in \mathcal{S}(K)} (std(v_0, K) \setminus C_{v_0})$$

and  $Y_\alpha = \overline{\mathcal{A}_{0\beta} \setminus \mathcal{U}}$ . Note that  $|X_\alpha \cup Y_\alpha| \cong M$ .

$Y_\alpha$  is a compression body, since it is obtained from a suitable collar of  $F^{(\alpha)}$  in  $\mathcal{A}_{0\beta}$  by adding 2-handles which have the  $\{\alpha, \alpha'\}$ -coloured cycles of  $\Gamma$  as cores. Hence, the set  $\mathbf{w}_\alpha$  of such cycles is a non-proper (if  $K$  has at least one singular vertex) and (generally) non-reduced system of curves on  $F^{(\alpha)}$  representing  $Y_\alpha$ . In order to reduce  $\mathbf{w}_\alpha$ , we have to proceed as described in section 2, by removing a subset  $\mathcal{D}'$  whose curves are dual to the edges of a subgraph  $T$  of  $G(\mathbf{w}_\alpha)$  satisfying the conditions listed in the cited section.

As a consequence, the triple  $\mathcal{H}_\alpha(\mathcal{D}, \mathcal{D}') = (F^{(\alpha)}, \mathbf{v}_\alpha \setminus \mathcal{D}, \mathbf{w}_\alpha \setminus \mathcal{D}')$  is a reduced Heegaard diagram of  $M$ .

It is thus possible to define an upper bound for the complexity of  $M$  through the graphs representing  $\widehat{M}$  and having only one singular colour. More precisely, for each  $\Gamma \in G^{(0)}$ , we define the *GM-complexity* of  $\Gamma$  (denoted as usual by  $c_{GM}(\Gamma)$ ) as the minimum complexity of the diagrams  $\mathcal{H}_\alpha(\mathcal{D}, \mathcal{D}')$ , where  $\alpha \in \{1, 2, 3\}$  and  $\mathcal{D}, \mathcal{D}'$  are as described above.

Then, we set

$$\hat{c}_{GM}(M) = \min\{c_{GM}(\Gamma) \mid \Gamma \in G^{(0)}, |K(\Gamma)| \cong \widehat{M}\}.$$

By definition itself, we have:

**Proposition 5** *For each compact 3-manifold  $M$ ,  $c(M) \leq \hat{c}_{GM}(M)$ .*

□

At the end of the next section, as a consequence of the proof of the main result, we will establish the coincidence between GM-complexity computed on edge-coloured graphs representing 3-manifolds and GM-complexity computed on edge-coloured graphs representing the associated singular manifold (Proposition 9).

The following Lemma shows how to obtain a gem of the compact 3-manifold  $M$  directly from a graph of  $G^{(0)}$  representing the singular 3-manifold  $\widehat{M}$ ; it will be particularly useful in the next section.

**Lemma 6** [16, Lemma 3] *If  $\Gamma \in G^{(0)}$  represents  $\widehat{M}$ , then a gem  $\bar{\Gamma}$  of  $M$  exists, such that  $\rho_\varepsilon(\bar{\Gamma}) = \rho_\varepsilon(\Gamma)$ , where  $\varepsilon = (0, 1, 2, 3)$ .*

□

In order to give a precise description of the above graph  $\bar{\Gamma}$ , we have to introduce two particular types of subdivision of a coloured complex: *bisection* and *trisection* ([19]). The local effect of bisection (resp. trisection) of type  $(i, j)$  ( $i, j \in \Delta_3$ ) around an  $i$ -labelled vertex (resp. on a 1-simplex with  $i$ - and  $j$ -labelled endpoints) of a coloured complex is shown in Figure 4, arrow  $b(i, j)$  (resp. Figure 6, arrow  $t(i, j)$ ).

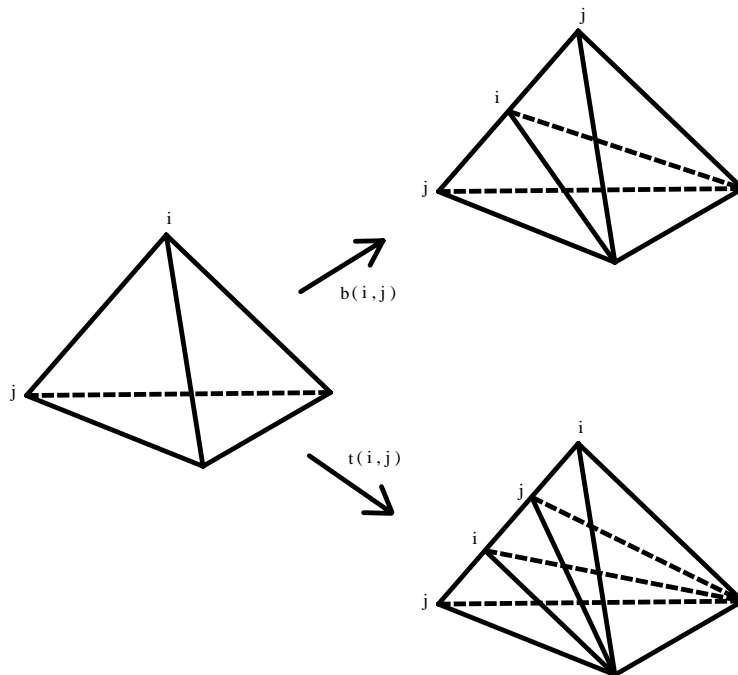

Figure 4: local effect of a bisection (resp. trisection) of type  $(i, j)$

The graph  $\bar{\Gamma}$  is obtained in the following way:

- we perform subsequently a trisection of type  $(0, 2)$ , a bisection of type  $(0, 3)$  and a trisection of type  $(3, 1)$  on each edge of  $K(\Gamma)$  having a  $(0$ -labelled) singular vertex as endpoint. The new coloured complex  $\tilde{K}$  is a coloured subdivision of  $K(\Gamma)$ , such that for each vertex  $u$  of  $\tilde{K}$ , we have that  $|st(u, \tilde{K})|$  is the cone over  $|lk(u, \tilde{K})|$ . Moreover, the singular vertices of  $\tilde{K}$ , which are exactly those of  $K(\Gamma)$ , are 3-labelled.
- we consider the coloured complex  $\bar{K}$  obtained from  $\tilde{K}$  by deleting  $st(u, \tilde{K}) \setminus lk(u, \tilde{K})$  for each singular vertex  $u$  of  $\tilde{K}$ ; then,  $\bar{\Gamma} = \Gamma(\bar{K})$ .

$\bar{\Gamma}$  turns out to be a gem of  $M$ , since the removal of open neighborhoods of the singular points of  $\widehat{M}$  yields again  $M$ .

## 6 Proof of the main result

In this section we will prove that  $GM$ -complexity and  $HM$ -complexity coincide for each compact irreducible and boundary-irreducible 3-manifold, thus extending the analogous result stated for the closed case in [11]. Hence,  $GM$ -complexity and  $HM$ -complexity turn out to be useful different tools to compute the same upper bound for Matveev's complexity.

In order to prove our main result, by Lemma 4, it is sufficient to prove that  $c_{GM}(M) \leq c_{HM}(M)$ , i.e. that each compact irreducible and boundary-irreducible 3-manifold  $M$  admits a gem whose  $GM$ -complexity is equal to  $c_{HM}(M)$ .

Let us first observe that we can take into consideration only compact manifolds without spherical boundary components, since puncturing does affect neither  $GM$ - nor  $HM$ -complexity and the case of manifolds whose boundary has only spherical components is essentially that of closed manifolds (see Remark 3), for which the equality of  $GM$ - and  $HM$ -complexity has already been established.

Therefore, from now on, we will consider only compact 3-manifolds, having non-empty boundary and no spherical boundary component.

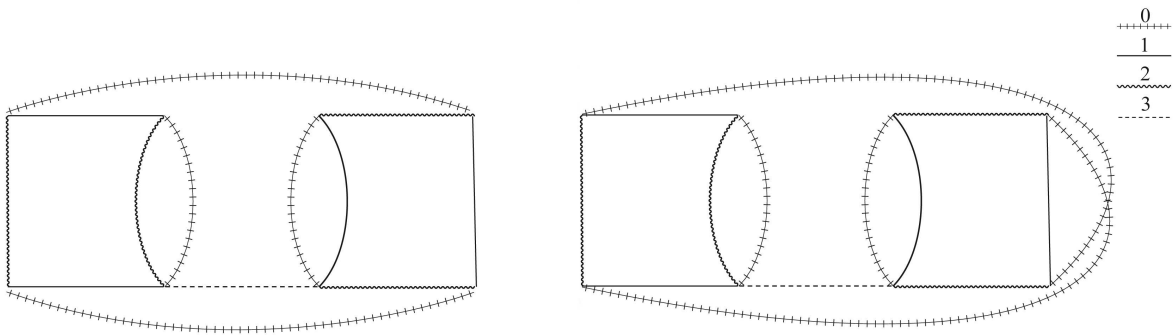

Figure 5: a gem of the orientable (resp. non-orientable) genus 1 handlebody

Let  $\mathcal{H} = (\Sigma_g, \mathbf{v}, \mathbf{w})$  be a reduced Heegaard diagram of the compact 3-manifold  $M$ , and suppose that  $c_{HM}(\mathcal{H}) = c_{HM}(M)$ .

We point out that, if  $\mathbf{w} = \emptyset$ , then  $M$  is a handlebody and a crystallization  $\Gamma$  of  $M$  exists such that  $c_{GM}(\Gamma) = c_{HM}(M) = 0$  (see Figure 5 for the cases of genus 1 handlebodies<sup>9</sup>); so, from now on, we will suppose  $\mathbf{w} \neq \emptyset$ .

Furthermore, an Heegaard diagram  $\mathcal{H} = (\Sigma_g, \mathbf{v}, \mathbf{w})$  is called *connected* iff the graph defined on  $\Sigma_g$  by the curves of  $\mathbf{v}$  and  $\mathbf{w}$  is connected, i.e. the connected components of  $\Sigma_g \setminus (\mathbf{v} \cup \mathbf{w})$  are 2-disks.

Note that if  $\mathcal{H}$  is connected, then it satisfies the following condition:

(\*) each curve of  $\mathbf{v}$  intersects at least one curve of  $\mathbf{w}$  and, conversely, each curve of  $\mathbf{w}$  intersects at least one curve of  $\mathbf{v}$ .

<sup>9</sup>Suitable crystallizations of handlebodies with higher genus may easily be obtained by graph connected sum on boundary vertices: see [17] for details.

Obviously, the converse is not always true. In the following we will always refer to the above condition as “condition (\*)”.

**Lemma 7** *Let  $\mathcal{H}$  be a not connected (reduced) Heegaard diagram of a compact 3-manifold  $M$ , such that  $c_{HM}(\mathcal{H}) = c_{HM}(M)$ . If  $\mathcal{H}_1, \mathcal{H}_2, \dots, \mathcal{H}_k$  ( $k \geq 2$ ) are the connected diagrams into which  $\mathcal{H}$  splits, then  $\sum_{i=1}^k c_{HM}(\mathcal{H}_i) \leq c_{HM}(\mathcal{H})$ .*

*Proof.* Obviously, if  $\mathcal{H} = (\Sigma_g, \mathbf{v}, \mathbf{w})$ , then  $\mathcal{H}_i = (\Sigma_{g_i}, \mathbf{v}_i, \mathbf{w}_i)$  is such that  $\sum_{i=1}^k g_i = g$ ,  $\Sigma_g = \#_{i=1}^k \Sigma_{g_i}$  and  $\cup_{i=1}^k \mathbf{v}_i = \mathbf{v}$  (resp.  $\cup_{i=1}^k \mathbf{w}_i = \mathbf{w}$ ). Moreover, let  $\bar{R} \in \mathcal{R}(\mathcal{H})$  be the region of  $\Delta(\mathcal{H})$  such that  $c_{HM}(\mathcal{H}) = n(\mathcal{H}) - m(\bar{R})$  ( $n(\mathcal{H})$  being the number of singular vertices of  $\mathcal{H}$  and  $m(\bar{R})$  being the number of singular vertices contained in  $\bar{R}$ ). Note that  $\bar{R}$  may be assumed to be the region of  $\Delta(\mathcal{H})$  obtained by “fusing” the regions  $\bar{R}_1, \bar{R}_2, \dots, \bar{R}_k$  ( $\bar{R}_i$  being a suitable region of  $\Delta(\mathcal{H}_i)$  with  $m(\bar{R}_i) \neq 0$  singular vertices, and  $\sum_{i=1}^k m(\bar{R}_i) = m(\bar{R})$ ).<sup>10</sup> In fact, if this is not the case, it is easy to check that a new Heegaard diagram  $\mathcal{H}'$  of  $M$  with this property exists, with  $c_{HM}(\mathcal{H}') < c_{HM}(\mathcal{H})$ , against the hypothesis  $c_{HM}(\mathcal{H}) = c_{HM}(M)$ . Note that the diagram  $\mathcal{H}_i$  ( $i = 1, \dots, k$ ) may fail to be reduced; however,  $c_{HM}(\mathcal{H}_i) \leq n(\mathcal{H}_i) - m(\bar{R}_i)$  trivially holds by definition itself, for each  $i = 1, \dots, k$ .

The thesis now directly follows:  $\sum_{i=1}^k c_{HM}(\mathcal{H}_i) \leq \sum_{i=1}^k n(\mathcal{H}_i) - \sum_{i=1}^k m(\bar{R}_i) = n(\mathcal{H}) - m(\bar{R}) = c_{HM}(\mathcal{H})$ . □

In order to prove our main result, we need a further lemma, which involves the singular 3-manifold  $\widehat{M}$  obtained by capping off each component of  $\partial M$  by a cone:

**Lemma 8** *If  $\mathcal{H} = (\Sigma_g, \mathbf{v} = \{v_1, v_2, \dots, v_g\}, \mathbf{w} = \{w_1, w_2, \dots, w_s\})$  is a (reduced) Heegaard diagram of a compact 3-manifold  $M$  satisfying condition (\*), then there exists a graph  $\Gamma \in G^{(0)}$  representing  $\widehat{M}$  and regularly embedding into  $\Sigma_g$ , such that  $c_{GM}(\Gamma) = c_{HM}(\mathcal{H})$ .*

*Proof.*  $\Gamma$  is obtained by applying to  $\mathcal{H}$  a construction described in [15], which is summarized briefly below:

- Consider a planar realization of  $\mathcal{H}$ , where each curve of  $\mathbf{v}$  (defining a 1-handle of  $\Sigma_g$ ) is represented by two circles lying in the upper and lower half-plane respectively. All circles in the upper half-plane may be assumed to have the same orientation; in the orientable (resp. non-orientable) case, all circles in the lower half-plane have the opposite orientation (resp. for each non-orientable 1-handle in  $\Sigma_g$ , the circle in the lower half-plane has the same orientation as its corresponding one in the upper half-plane). Let  $v_0$  be the simple closed curve in  $\Sigma_g$ , represented by the  $x$ -axis in the plane. We can suppose that  $v_0$  is disjoint from the curves of  $\mathbf{v}$  and set  $\mathbf{v}' = \mathbf{v} \cup \{v_0\}$ . Furthermore, by condition (\*) and a suitable choice of  $v_0$ , we can always assume that the diagram  $(\Sigma_g, \mathbf{v}', \mathbf{w})$  is connected.
- Let  $\mathbf{w}'$  be the system obtained from  $\mathbf{w}$  by “doubling” each of its curves. For each  $i = 1, \dots, s$ , we denote by  $\bar{w}_i$  the “double” of the curve  $w_i$ .

---

<sup>10</sup>Roughly speaking, we can say that  $\bar{R}$  is the “external” region of the planar realization of  $\mathcal{H}$ , and that  $\bar{R}_i$  is the “external” region of the planar realization of  $\mathcal{H}_i$ , for each  $i = 1, \dots, k$ .



- Let  $\Gamma$  be the 4-coloured graph obtained by coloring alternatively 0 and 2 the arcs into which each curve of  $\mathbf{v}'$  is split by  $\mathbf{w}'$  and by coloring alternatively 1 and 3 the arcs into which each curve of  $\mathbf{w}'$  is split by  $\mathbf{v}'$ . We assume to colour 0 the arcs lying between a curve of  $\mathbf{w}$  and its “double”. Furthermore we colour 1 (resp. 3) the arcs of  $\mathbf{w}'$  lying in the upper (resp. lower) half-plane of the planar realization.

Obviously,  $\mathcal{H}' = (\Sigma_g, \mathbf{v}', \mathbf{w}')$  is a generalized Heegaard diagram of  $M$ , too. Furthermore,  $\Gamma$  represents  $\widehat{M}$  in virtue of [15, Lemma 5]).

By directly computing the Euler characteristics of the disjoint links of the vertices of  $K(\Gamma)$ , it is easy to prove that all singular vertices of  $K(\Gamma)$  must be 0-labelled (see [15, Lemma 4]), i.e.  $\Gamma \in G^{(0)}$ . Hence, the equality  $c_{GM}(\Gamma) = c_{HM}(\mathcal{H})$  follows by arguments of Section 5. □

An example of the above construction is presented in Figures 6(a) and 6(b), starting from the planar realization of a genus two reduced Heegaard diagram of  $U_2 \times I$ , where all circles are assumed to have the same orientation.

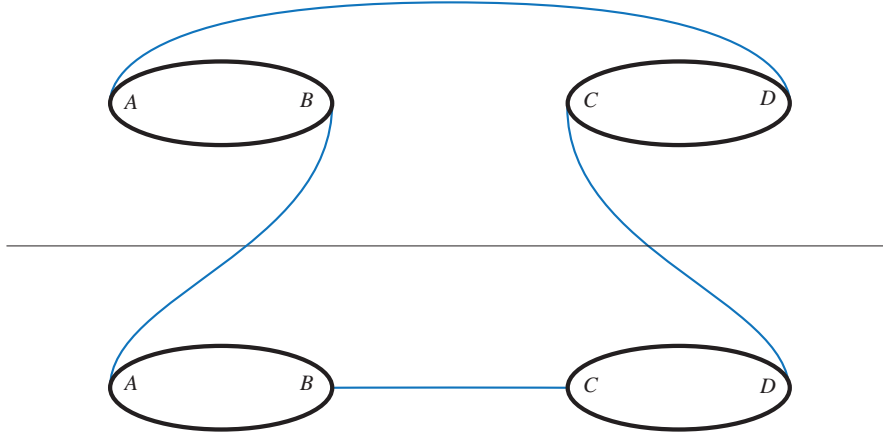

Figure 6(a):  $\mathcal{H}$ , Heegaard diagram of  $U_2 \times I$

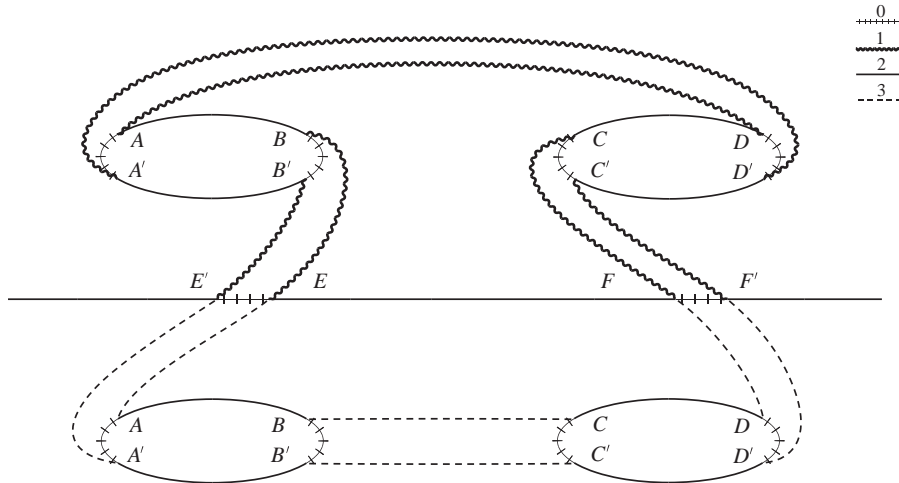

Figure 6(b):  $\Gamma \in G^{(0)}$ , representing  $\widehat{M}$ , with  $M = U_2 \times I$

**Remark 4** Note that  $K(\Gamma_{\hat{0}})$  can be obtained by cutting  $\Sigma_g$  along the curves of  $\mathbf{w}$ . So, if  $\mathbf{w}$  is reduced, each  $\hat{0}$ -residue of  $\Gamma$  represents a surface of genus  $> 0$  and hence all 0-labelled vertices of  $K(\Gamma)$  are singular.

**Proof of the main result** Let  $M$  be a compact irreducible and boundary-irreducible 3-manifold and let  $\mathcal{H} = (\Sigma_g, \mathbf{v} = \{v_1, v_2, \dots, v_g\}, \mathbf{w} = \{w_1, w_2, \dots, w_s\})$  be a reduced Heegaard diagram of  $M$  such that  $c_{HM}(\mathcal{H}) = c_{HM}(M)$ .

We will prove the statement by first assuming  $\mathcal{H}$  connected (case A), and then by taking into account a not connected  $\mathcal{H}$  (case B).

• [case A] If  $\mathcal{H}$  is assumed to be connected (and hence it satisfies condition (\*)), by applying the constructions of Lemma 8 and Lemma 6 we obtain a gem  $\bar{\Gamma}$  of  $M$ .

Let us consider the subcomplex  $K_{02}$  (resp.  $K_{13}$ ) of  $K(\Gamma)$  generated by the 0- and 2- (resp. 1- and 3-) labelled vertices. Note that the curves of the system  $\mathbf{v}'$  (resp.  $\mathbf{w}'$ ) are dual to the edges of  $K_{13}$  (resp.  $K_{02}$ ). It is obvious that, in order to reduce  $\mathbf{v}'$  (resp.  $\mathbf{w}'$ ) it is sufficient to remove the curve  $v_0$  (resp. the curve  $\bar{w}_i$ , i.e. the “double” of the curve  $w_i$  of  $\mathbf{w}$ , for each  $i = 1, \dots, s$ ).

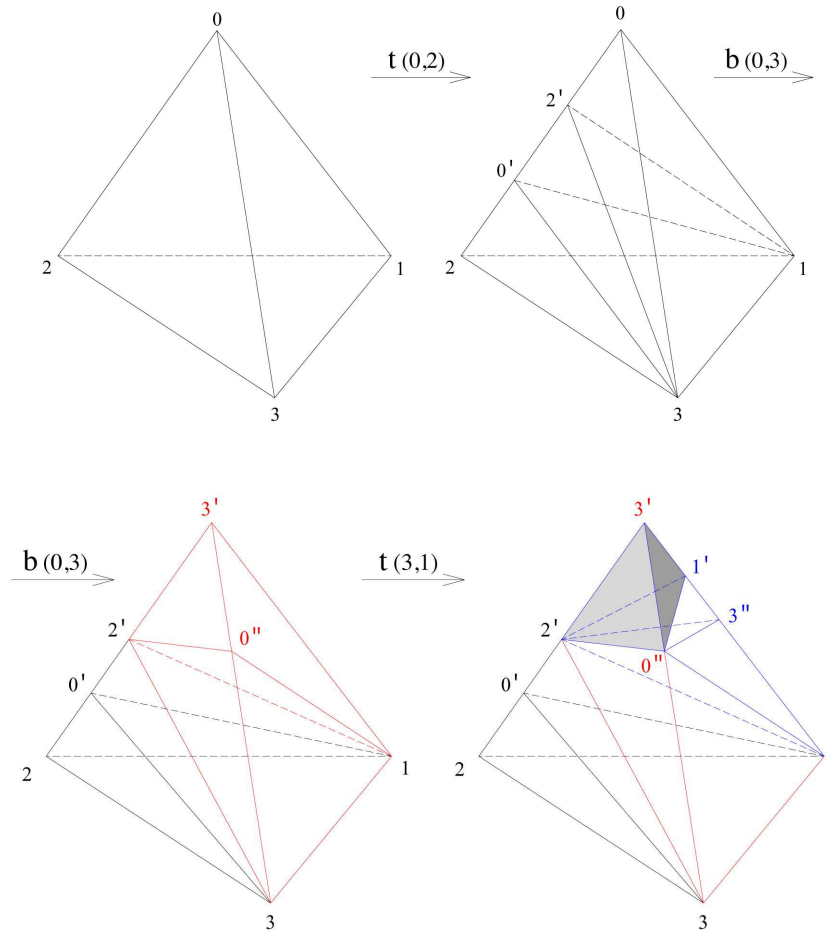

Figure 7

We turn now our attention to the pseudocomplex  $\bar{K}$ . Figure 7 describes locally, in a tetrahedron near a 0-labelled singular vertex of  $K(\Gamma)$ , the effects of the bisection and trisections performed. In the last picture of the sequence, we highlighted the small tetrahedron which has to be removed in the last step of the construction, as part of a neighborhood of the singular vertex. Moreover, we put “primes” beside the colour for the new vertices arising from the subdivisions.

In the following we will call an edge of  $K(\bar{\Gamma})$  of type  $i-j$  (with  $i, j \in \Delta_3 \cup \{0', 0'', 1', 2', 3', 3''\}$ ) referring to the labels of its endpoints as in Figure 7.

If we consider the generalized Heegaard diagram  $\mathcal{H}_\alpha = (\Sigma^{(\alpha)}, \mathbf{v}_\alpha, \mathbf{w}_\alpha)$  associated to  $\bar{\Gamma}$  with respect to the choice  $\alpha = 1$ , by Lemma 6, we have  $\Sigma^{(\alpha)} = \Sigma_g$ .

The system  $\mathbf{v}_\alpha$  is formed by the curves of  $\mathbf{v}'$  and by the curves dual to the edges of type  $1-3''$  and  $1'-3''$ . The system  $\mathbf{w}_\alpha$  is formed by the curves dual to the edges of type  $0'-2$  and  $0'-2'$ , which correspond in pairs to the curves of  $\mathbf{w}'$ .

Let us call  $\bar{\mathcal{D}}$  the set formed by  $v_0$  and by the curves of  $\mathbf{v}_\alpha$  which are dual to the edges of type  $1'-3''$  and  $1-3''$ .  $\bar{\mathcal{D}}$  corresponds to a maximal tree of  $\bar{K}_{13}$ , since  $v_0$  is dual to a maximal tree of  $K_{13}$  and no edges of type  $1'-3''$  have a common endpoint in  $\bar{K}$ .

Let  $G_{02}$  be the graph obtained by  $\bar{K}_{02}$  by shrinking to a point each connected component of  $\partial\bar{K}$ , and let  $\bar{G}$  be the subgraph of  $G_{02}$  formed by all edges of type  $0'-2'$  (modulo the above identifications) and by those edges of type  $0'-2$  belonging to the subdivision of an edge of  $K$  dual to a curve  $\bar{w}_i$  ( $i = 1, \dots, s$ )<sup>11</sup>.

We point out that:

- by Remark 4, each vertex of  $G_{02}$  belongs to  $\bar{G}$ ;
- each connected component of  $\bar{G}$  is a tree; in fact, the edges of  $K(\Gamma)$  dual to the curves  $\bar{w}_i$  form a maximal tree of  $K_{02}$ , no edges of type  $0'-2'$  have the 0-labelled endpoint in common and no edges of type  $0'-2$  belonging to  $\bar{G}$  have a common endpoint;
- each connected component of  $\bar{G}$  intersects only one boundary component of  $\bar{K}$  (otherwise the edges of  $K(\Gamma)$  dual to the curves  $\bar{w}_i$  wouldn't form a tree of  $K_{02}$ ).

If we denote by  $\bar{\mathcal{D}}'$  the set of curves of  $\mathbf{w}_\alpha$  dual to the edges of  $\bar{G}$ , as a consequence of the above considerations and of Proposition 3, we have that  $\mathcal{H}_\alpha(\bar{\mathcal{D}}, \bar{\mathcal{D}}')$  is a reduced Heegaard diagram of  $M$  associated to  $\mathcal{H}_\alpha$ ; furthermore it is obvious that  $\mathcal{H}_\alpha(\bar{\mathcal{D}}, \bar{\mathcal{D}}') = \mathcal{H}$ .

Hence,  $c_{GM}(\bar{\Gamma}) = c_{HM}(\mathcal{H}_\alpha) = c_{HM}(\mathcal{H})$ , as claimed.

• **[case B]** Let us now assume that the reduced Heegaard diagram  $\mathcal{H} = (\Sigma_g, \mathbf{v} = \{v_1, v_2, \dots, v_g\}, \mathbf{w} = \{w_1, w_2, \dots, w_s\})$ , with the property  $c_{HM}(\mathcal{H}) = c_{HM}(M)$ , is not connected.

By definition, this means that at least a connected component of  $\Sigma_g \setminus (\mathbf{v} \cup \mathbf{w})$  is not a 2-disk. As a consequence, a simple closed essential curve  $l$  exists in  $\Sigma_g$ , not intersecting  $\mathbf{v} \cup \mathbf{w}$ . Obviously,  $l$  bounds a disk  $D$  in the handlebody  $\mathbb{X}_g$  of the Heegaard splitting  $(\Sigma_g, \mathbb{X}_g, \mathbb{Y}_g)$  associated to  $\mathcal{H}$ ; on the other hand, in the compression body  $\mathbb{Y}_g$ ,  $l$  bounds either a disk  $D'$  or an annulus  $A$  with  $\partial A$  consisting of the disjoint union of  $l$  ( $l \in \partial_+ \mathbb{Y}_g$ ) and  $l'$  ( $l' \in \partial_- \mathbb{Y}_g = \partial M$ ).

In the first case, i.e. if a disk  $D' \subset \mathbb{Y}_g$  exists with  $\partial D' = l$ , then the union  $D \cup D'$  yields a 2-sphere in  $M$ , which - because of the assumption of irreducibility - splits  $M$  into a (necessarily trivial) connected sum. This means that  $l$  splits  $\mathcal{H}$  into two Heegaard diagrams  $\mathcal{H}'$  and  $\mathcal{H}''$ , where  $\mathcal{H}'$  represents  $M$ , too, and  $\mathcal{H}''$  represents  $\mathbb{S}^3$  (or viceversa).

<sup>11</sup>Note that, by Remark 4, all edges of  $K_{02}$  have been subdivided.

In the second case, i.e. if an annulus  $A \subset \mathbb{Y}_g$  exists with  $\partial A$  consisting of  $l \subset \partial_+ \mathbb{Y}_g$  and  $l' \subset \partial_- \mathbb{Y}_g = \partial M$ , then  $\bar{D} = D \cup A$  is a proper disk in  $M$ , with  $\partial \bar{D} = l' \subset \partial M$ , which - because of the assumption of boundary-irreducibility - splits  $M$  into a (necessarily trivial) boundary connected sum. This means that  $l$  splits  $\mathcal{H}$  into two Heegaard diagrams  $\mathcal{H}'$  and  $\mathcal{H}''$ , where  $\mathcal{H}'$  represents  $M$ , too, and  $\mathcal{H}''$  represents  $\mathbb{D}^3$  (or viceversa).

By iterating the process for any possible subsequent splitting of  $\mathcal{H}$ , we obtain  $k \geq 2$  connected Heegaard diagrams  $\mathcal{H}_1, \mathcal{H}_2, \dots, \mathcal{H}_k$  ( $k \geq 2$ ) so that  $\mathcal{H}_1$  represents the compact 3-manifold  $M$ , too, while for each  $i = 2, \dots, k$ ,  $\mathcal{H}_i$  represents either the 3-sphere or the 3-disk.

Now, Lemma 7 ensures  $\sum_{i=1}^k c_{HM}(\mathcal{H}_i) \leq c_{HM}(\mathcal{H})$ , and so  $c_{HM}(\mathcal{H}_1) \leq c_{HM}(\mathcal{H})$  directly follows.

Since  $c_{HM}(\mathcal{H}) = c_{HM}(M)$  is assumed,  $c_{HM}(\mathcal{H}_1) = c_{HM}(\mathcal{H}) = c_{HM}(M)$  necessarily holds, too.

Hence, the general statement follows by applying the first part of the proof (case A) to any connected reduced Heegaard diagram of  $M$  associated to  $\mathcal{H}_1$ . □

**Remark 5** Note that, since Lemma 8 holds for any Heegaard diagram  $\mathcal{H}$  satisfying condition (\*), the proof of the main theorem (i.e. the coincidence between GM-complexity and HM-complexity) works as well for all compact 3-manifolds admitting such a Heegaard diagram. More precisely: *if  $M$  is a compact 3-manifold admitting a Heegaard diagram  $\mathcal{H}$  satisfying condition (\*) such that  $c_{HM}(\mathcal{H}) = c_{HM}(M)$ , then a gem  $\bar{\Gamma}$  of  $M$  may be directly obtained, with the property  $c_{GM}(\bar{\Gamma}) = c_{HM}(\mathcal{H}) = c_{HM}(M)$ .*

Moreover, as a consequence of the main result, we can establish:

**Proposition 9** *For each compact irreducible and boundary-irreducible 3-manifold  $M$ ,  $\hat{c}_{GM}(M) = c_{GM}(M)$ .*

*Proof.* Let  $\Gamma' \in G^{(0)}$  represent  $\widehat{M}$ , with  $c_{GM}(\Gamma') = \hat{c}_{GM}(M)$ . Then, there is a reduced Heegaard diagram  $\mathcal{H}_\alpha$  of  $M$ , associated to  $\Gamma'$ , such that  $c_{GM}(\Gamma') = c_{HM}(\mathcal{H}_\alpha)$ ; moreover, by the hypothesis on  $M$ , the proof of the main result (case B) allows to assume  $\mathcal{H}_\alpha$  connected, without loss of generality. Hence, by applying to  $\mathcal{H}_\alpha$  the procedure described in the proof of the main theorem (case A), a 4-coloured graph  $\Gamma$ , regular with respect to colour 3 and representing  $M$  is obtained. Since  $\Gamma$  has the same GM-complexity as  $\mathcal{H}_\alpha$ ,  $c_{GM}(M) \leq \hat{c}_{GM}(M)$  follows.

Conversely, let  $\Gamma$  be a 4-colored graph with boundary representing  $M$  and let  $\mathcal{H}_\alpha$  be a reduced Heegaard diagram associated to  $\Gamma$  such that  $c_{GM}(\Gamma) = c_{HM}(\mathcal{H}_\alpha)$ . Again by the arguments of case B in the proof of the main theorem, we can suppose  $\mathcal{H}_\alpha$  to be connected. Therefore, by applying to  $\mathcal{H}_\alpha$  the construction of Lemma 8, we get a 4-coloured graph  $\Gamma'$ , representing  $\widehat{M}$ , such that  $c_{GM}(\Gamma') = c_{HM}(\mathcal{H}_\alpha)$ . Hence  $\hat{c}_{GM}(M) \leq c_{GM}(M)$ . □

In the following section we will apply the notion of GM-complexity (in particular, via graphs representing singular 3-manifolds) in order to yield an estimation of Matveev's complexity for an infinite family of bounded 3-manifolds, including all torus knot complements.

## 7. Estimation of Matveev's complexity for torus knot complements

In [24, Figure 1d], Grasselli obtained a 4-coloured graph  $\bar{\Lambda}$  representing a singular manifold which - in virtue of a previous work by Montesinos (see [30, Example 2]) - turns out to be associated to the complement of the trefoil knot  $t(3, 2)$  in  $\mathbb{S}^3$ . By a suitable combinatorial move not affecting the represented manifold (i.e., by the inverse of a  $\rho_2$ -pair switching, which may be performed via the insertion of a 2-dipole, followed by the elimination of a (proper) 1-dipole: see [1] for details on the admissible combinatorial moves on edge-coloured graphs representing PL-manifolds and [19], [3] for their extension to the case of singular manifolds), the 4-coloured graph  $\bar{\Lambda}'$  of Figure 8(a) is obtained.

The definitions and results of the previous sections easily yield a direct proof that the trefoil knot complement has Matveev's complexity zero:<sup>12</sup>

**Proposition 10**  $c(\mathbb{S}^3 - t(3, 2)) = 0$ .

*Proof.* In virtue of Proposition 5, Matveev's complexity may be estimated from any 4-coloured graph representing the associated singular manifold, and having only one singular colour. A trivial check ensures that the graph  $\bar{\Lambda}'$  actually belongs to the class  $G^{(0)}$ : in fact, all  $\hat{c}$ -residues represent 2-spheres, except when  $c = 0$  (the Euler characteristic computation easily proves  $\bar{\Lambda}'_0$  to represent a torus). Moreover, since  $g_{\hat{c}} = 1 \forall c \in \Delta_3$ , one only bicoloured cycle of each complementary pair of colours has to be deleted, in order to obtain a reduced Heegaard diagram of the trefoil knot complement. Hence,  $c_{GM}(\bar{\Lambda}') = 5 - 5 = 0$  directly follows: see Figure 8(b) for an associated Heegaard diagram, where it is easy to detect a region containing all the intersection points of the two systems of curves.

□

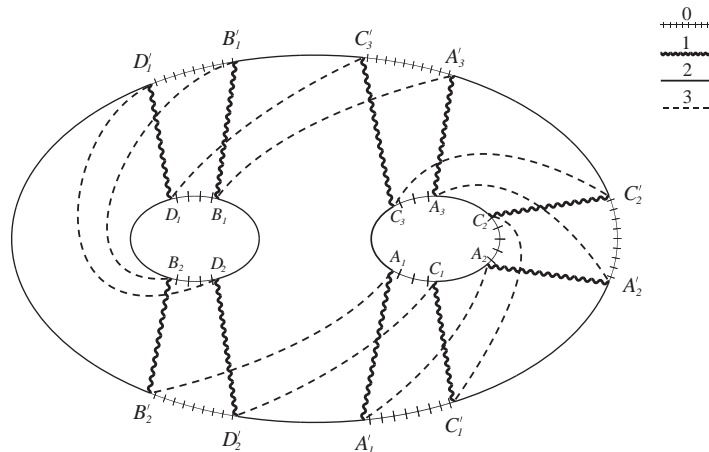

Figure 8(a):  $\bar{\Lambda}'$ , representing the trefoil knot complement

<sup>12</sup>The fact is actually already known, as Sergei Matveev pointed out in a personal communication, referring to an unpublished work by his former student Nikolaev, which yields the complete classification of all compact irreducible and boundary irreducible 3-manifolds with complexity zero.

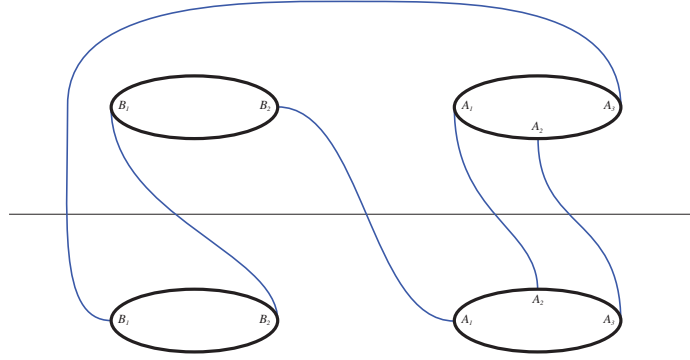

Figure 8(b): a reduced Heegaard diagram of the trefoil knot complement

By a quite natural generalization of the 4-coloured graph  $\bar{\Lambda}' \in G^{(0)}$  representing the trefoil knot complement, let us now consider the 4-coloured graph  $\Lambda((p, h), (q, k))$  depicted in Figure 9(a): it depends on two pairs  $(p, h)$  and  $(q, k)$  of coprime integers (where  $p \geq h \geq 1$ ,  $q \geq k \geq 1$  and  $p \geq q \geq 2$  may be assumed).

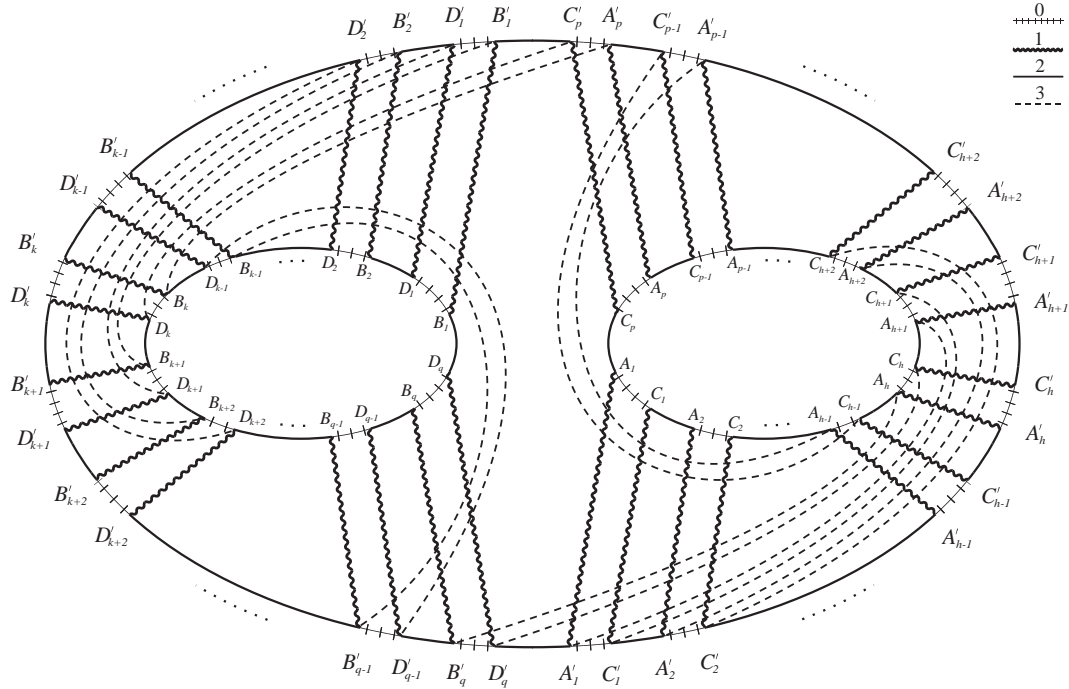

Figure 9(a):  $\Lambda((p, h), (q, k))$

For any 4-tuple  $(p, h, q, k)$  of positive integers, 3-coloured edges may be described via the following pairs of adjacent vertices:

- $\forall i = 1, \dots, p-1 : (A'_i, A'_{i+h})$  and  $(C'_i, C'_{i+h})$ , where indices are assumed  $\pmod p$  within the set  $\{1, 2, \dots, p\}$ ;
- $\forall j = 1, \dots, q-1 : (B'_j, B'_{j+k})$  and  $(D'_j, D'_{j+k})$ , where indices are assumed  $\pmod q$  within the set  $\{1, 2, \dots, q\}$ ;

- $(A'_p, B_k)$  and  $(C'_p, D_k)$ ;  $(B'_q, A_h)$  and  $(D'_q, C_h)$ .

**Proposition 11** For any 4-tuple  $(p, h, q, k)$  of positive integers so that  $GCD(p, h) = GCD(q, k) = 1$ , the 4-coloured graph  $\Lambda((p, h), (q, k))$  belongs to the class  $G^{(0)}$ . Moreover, it represents the Seifert 3-manifold  $(\mathbb{D}^2; (p, \alpha), (q, \beta))$ , with base  $\mathbb{D}^2$  and two exceptional fibers, where the Seifert type  $(p, \alpha)$  (resp.  $(q, \beta)$ ) of the first (resp. second) fiber is uniquely determined by  $\alpha h \equiv 1 \pmod p$  (resp.  $\beta k \equiv 1 \pmod q$ ).

*Proof.* First of all, note that the 4-coloured graph  $\Lambda((p, h), (q, k))$  (where  $GCD(p, h) = GCD(q, k) = 1$  is assumed to hold) has the following combinatorial structure:  $g_{01} = p + q$ ;  $g_{02} = 3$ ;  $g_{03} = p + q$ ;  $g_{12} = p + q - 1$ ;  $g_{13} = 2$ ;  $g_{23} = p + q - 1$ .

So the regularity property, together with the connectedness of each 3-coloured subgraph, allows to topologically recognize  $K(\Gamma_{\hat{c}}) (\forall c \in \Delta_3)$  by means of an Euler characteristic computation:

$$\chi(K(\Gamma_{\hat{0}})) = 0 \quad \Rightarrow \quad K(\Gamma_{\hat{0}}) \text{ is a torus}$$

$$\chi(K(\Gamma_{\hat{1}})) = \chi(K(\Gamma_{\hat{2}})) = \chi(K(\Gamma_{\hat{3}})) = 2 \quad \Rightarrow \quad K(\Gamma_{\hat{c}}) \text{ is a 2-sphere } \forall c \in \{1, 2, 3\}$$

This proves that  $\Lambda((p, h), (q, k))$  belongs to the class  $G^{(0)}$  and that the represented compact 3-manifold has (connected) toric boundary.

Finally, in order to complete the proof, it is sufficient to take into account the reduced Heegaard diagram -  $\mathcal{H}((p, h), (q, k))$ , say - associated to  $\Lambda((p, h), (q, k))$  with respect to colour 2, where the subset  $\mathcal{D}$  (resp.  $\mathcal{D}'$ ) considered in Section 5 consists of the length  $2(p + q)$   $\{0, 2\}$ -coloured cycle (resp. of one arbitrarily chosen  $\{1, 3\}$ -coloured cycle): see Figure 9(b). Since  $\mathcal{H}((p, h), (q, k))$  is a simple closed curve on the genus two handlebody consisting of exactly two connections of type  $(p, h)$  and  $(q, k)$  (see [32]), it turns out to be isotopic to the so-called “standard Heegaard diagram  $HD_0$  of type  $(S^p T^{-q}; h, k)$ ” described in [4, Definition 4.3].

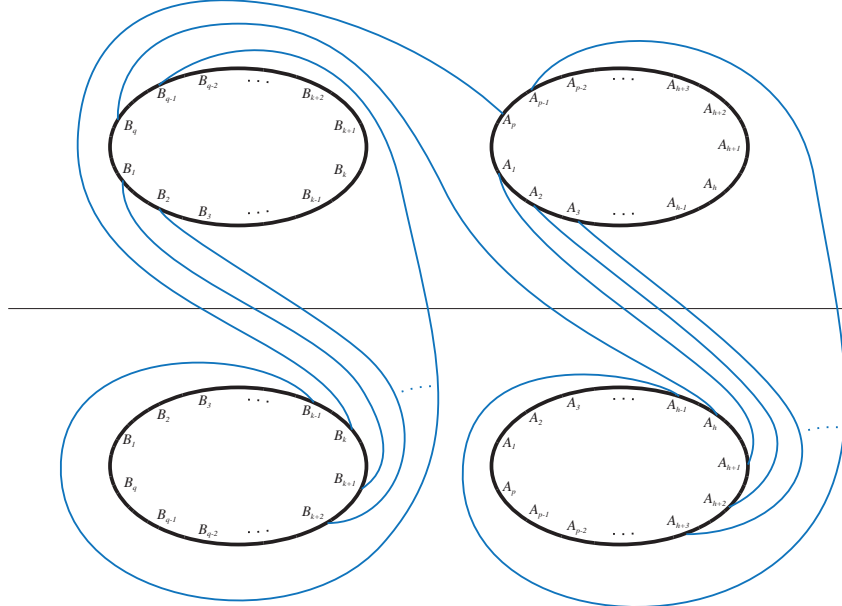

Figure 9(b):  $\mathcal{H}((p, h), (q, k))$

The statement now follows from [4, Proposition 4.4]: the standard Heegaard diagram  $HD_0$  of type  $(S^pT^{-q}; h, k)$  is proved to represent the Seifert 3-manifold  $(\mathbb{D}^2; (p, \alpha), (q, \beta))$ , with  $\alpha h \equiv 1 \pmod p$  and  $\beta k \equiv 1 \pmod q$ , and hence both  $\mathcal{H}((p, h), (q, k))$  and  $\Lambda((p, h), (q, k))$  do, too.  $\square$

**Remark 6** It is worthwhile noting that  $\Lambda((p, h), (q, k))$  may be directly obtained from  $\mathcal{H}((p, h), (q, k))$  by applying the construction described in Lemma 8.

**Corollary 12** For each pair  $(p, q)$  of coprime integers  $(p > q \geq 2)$ ,  $\Lambda((p, q), (q, p))$  represents the complement of the torus knot  $\mathfrak{t}(p, q)$ .

*Proof.* By [4, Corollary 4.6], the complement of the torus knot  $\mathfrak{t}(p, q)$  (which is the Seifert manifold  $(\mathbb{D}^2; (p, \alpha), (q, \beta))$ , with  $\alpha \cdot q \equiv \pm 1 \pmod p$  and  $\beta \cdot p \equiv \pm 1 \pmod q$ , by [4, Proposition 4.2 (d)]) admits the standard Heegaard diagram  $HD_0$  of type  $(S^pT^{-q}; q, p)$ . Hence, the thesis is a direct consequence of the proof of the previous Proposition:  $\mathbb{S}^3 - \mathfrak{t}(p, q)$  is also represented by the isotopic Heegaard diagram  $\mathcal{H}((p, q), (q, p))$ , as well as by the graph  $\Lambda((p, q), (q, p))$  (i.e.  $\Lambda((p, q), (q, p'))$ , where  $1 \leq p' \leq q - 1$  is (uniquely) determined by  $p' \equiv p \pmod q$ ).  $\square$

**Remark 7** As kindly pointed out by José Maria Montesinos in a personal communication, a direct proof exists of the fact that the 4-coloured graph  $\Lambda((p, q), (q, p))$  represents the complement in  $\mathbb{S}^3$  of a knot (and hence of the appropriate torus knot, because of the fundamental group computation): it is sufficient to note that a simple closed curve (whose existence relies on the Bezout equation for the pair  $(p, q)$  of coprime integers) may be added to the associated Heegaard diagram  $\mathcal{H}((p, q), (q, p))$  so that the represented manifold (i.e. the manifold obtained from  $K(\Lambda((p, h), (q, k)))$  by a 2-handle addition) has null fundamental group. See Figure 10 for an example, in the case  $p = 5, q = 3$  (where the red dotted curve identifies the “additional” 2-handle).

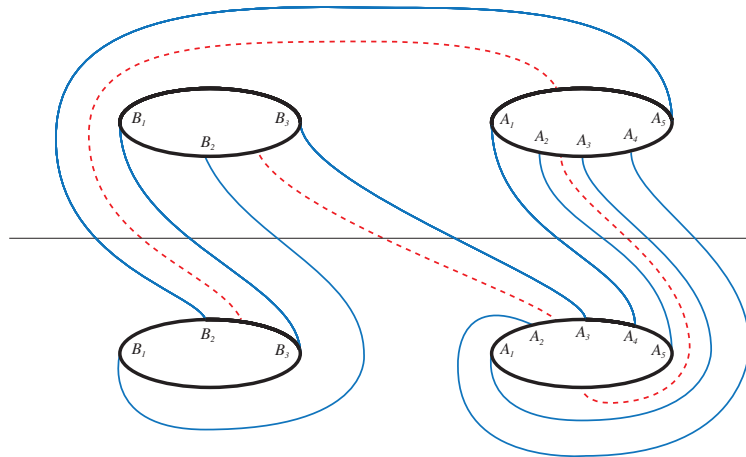

Figure 10:  $\mathcal{H}((5, 3), (3, 2))$



As a consequence, an estimation for the Matveev's complexity of the represented manifolds is obtained via the notion of GM-complexity; in the case of torus knot complements it significantly improves, for this particular class of knots, the general estimation for Matveev's complexity of any link complement given in [29, Prop. 2.11].<sup>13</sup>

**Proposition 13** *Let  $\delta_\alpha = \begin{cases} 1 & \alpha \equiv \pm 1 \pmod{p} \\ 0 & \text{otherwise} \end{cases}$  and  $\delta_\beta = \begin{cases} 1 & \beta \equiv \pm 1 \pmod{q} \\ 0 & \text{otherwise} \end{cases}$*

*Then:*

$$c(\mathbb{D}^2; (p, \alpha), (q, \beta)) \leq \max\{p - 4 + \delta_\alpha, 0\} + \max\{q - 4 + \delta_\beta, 0\}.$$

*In particular:*

(a) *For each pair  $(p, q)$  of coprime integers  $(p > q > 3)$ , with  $p - q \neq 1$ ,*

$$c(\mathbb{S}^3 - \mathfrak{t}(p, q)) \leq p + q - 8;$$

(b) *for each  $p \geq 4$ ,  $c(\mathbb{S}^3 - \mathfrak{t}(p, p - 1)) \leq 2p - 7$ ;*

(c) *for each  $p \geq 5$ ,  $c(\mathbb{S}^3 - \mathfrak{t}(p, 2)) \leq p - 4$ ;*

(d) *for each  $p \geq 5$ ,  $c(\mathbb{S}^3 - \mathfrak{t}(p, 3)) \leq p - 4$ .*

*Proof.* By arguments of Section 5, Matveev's complexity of  $M = (\mathbb{D}^2; (p, \alpha), (q, \beta))$  (where  $GCD(p, \alpha) = GCD(q, \beta) = 1$  necessarily holds) may be estimated from any graph belonging to the class  $G^{(0)}$  and representing the associated singular 3-manifold  $\widehat{M}$  (and  $M$  itself, too). The general statement follows by considering the above described 4-coloured graph  $\Lambda((p, h), (q, k))$ , with  $h, k$  uniquely determined by  $\alpha h \equiv 1 \pmod{p}$  and  $\beta k \equiv 1 \pmod{q}$ , and by computing its GM-complexity by means of the associated reduced Heegaard diagram  $\mathcal{H}((p, h), (q, k))$ : there are exactly  $p+q$  intersection points between the two systems of curves (i.e.:  $\{A_1, A_2, \dots, A_p\} \cup \{B_1, B_2, \dots, B_q\}$ ), while a "maximal" region of the embedding contains the subset  $\{A_1, A_p, A_h, A_{h+1}\} \cup \{B_1, B_q, B_k, B_{k+1}\}$ , whose cardinality depends on the value of  $p$  and  $q$  (since all indices are assumed to be  $\pmod{p}$  (resp.  $\pmod{q}$ ) within the sets  $\{1, 2, \dots, p\}$  (resp.  $\{1, 2, \dots, q\}$ )), as well as on the possible coincidence among elements. In particular, coincidences occur in  $\{A_1, A_p, A_h, A_{h+1}\}$  (resp. in  $\{B_1, B_q, B_k, B_{k+1}\}$ ) if and only if  $h \equiv \pm 1 \pmod{p}$  (resp.  $k \equiv \pm 1 \pmod{q}$ ), i.e. if and only if  $\alpha \equiv \pm 1 \pmod{p}$  (resp.  $\beta \equiv \pm 1 \pmod{q}$ ).

Statements (a), (b), (c), (d) are easy consequences of the general relation. □

The following Corollary collects some results which directly follow from Proposition 13. However, they appear to be of particular interest, since the exact value of the Matveev's complexity is obtained, for all involved 3-manifolds: the complements of torus knots  $\mathfrak{t}(4, 3)$ ,  $\mathfrak{t}(5, 2)$  and

---

<sup>13</sup>While writing the present paper, we learnt about a preprint by Fominykh and Wiest, which also yields an upper estimation for Matveev's complexity of torus knot complements, via their representation as Seifert manifolds: see [18]. In some cases, Fominykh and Wiest's estimation further improves Matveev's one.

$t(5, 3)$  are proved to have Matveev's complexity less or equal to one <sup>14</sup>, while the Seifert manifold  $(\mathbb{D}^2; (2, 1), (2, 1)) = U_2 \tilde{\times} I$  (i.e. the orientable I-bundle over the Klein Bottle) and the Seifert manifold  $(\mathbb{D}^2; (3, 1), (3, 1))$  are proved to have Matveev's complexity zero.<sup>15</sup>

### Corollary 14

- (a)  $c(\mathbb{S}^3 - t(4, 3)) \leq 1$ ;
- (b)  $c(\mathbb{S}^3 - t(5, 2)) \leq 1$ ;
- (c)  $c(\mathbb{S}^3 - t(5, 3)) \leq 1$ ;
- (d)  $c(U_2 \tilde{\times} I) = 0$ ;
- (e)  $c((\mathbb{D}^2; (3, 1), (3, 1))) = 0$ .

□

**Remark 8** Case (c) of the previous Corollary may be directly checked by the above Figure 10, where it is very easy to see a region of the embedding containing all intersection points, except  $A_2$ .

*Acknowledgement.* Work performed under the auspices of the G.N.S.A.G.A. of I.N.d.A.M. (Italy) and financially supported by M.I.U.R. of Italy, University of Modena and Reggio Emilia, funds for selected research topics.

## References

- [1] P. Bandieri - M. R. Casali - C. Gagliardi, *Representing manifolds by crystallization theory: foundations, improvements and related results*, Atti Sem. Mat. Fis. Univ. Modena **Suppl. 49** (2001), 283-337.
- [2] P. Bandieri - M. R. Casali - P. Cristofori - L. Grasselli - M. Mulazzani, *Computational aspects of crystallization theory: complexity, catalogues and classification of 3-manifolds*, Atti Sem. Mat. Fis. Univ. Modena **58** (2011), 11-45.
- [3] P. Bandieri - P. Cristofori, *Moves on coloured spines*, Riv. Mat. Univ. Parma **5** (1995), 147-159.
- [4] M. Boileau - M. Rost - H. Zieschang, *On Heegaard decompositions of torus knot exteriors and related Seifert fibre spaces*, Math. Ann. **279** (1988), 553- 581.
- [5] M.R.Casali, *An infinite class of bounded 4-manifolds having regular genus three*, Bollettino Un.Mat.Ital. **10-A** (1996), 279-303.
- [6] M.R.Casali, *Classifying PL 5-manifolds by regular genus: the boundary case*, Canadian J. Math. **49** (1997), 193-211.
- [7] M. R. Casali, *On the regular genus of 5-manifolds with free fundamental group*, Forum Math. **15** (2003), 465-475.

---

<sup>14</sup>These estimations actually turn out to be the exact values of complexity, since these complements of torus knots do not belong to the family of complexity zero compact 3-manifolds, according to Matveev's communication about Nikolaev's result.

<sup>15</sup>Note that the last two facts are already known, too, via Nikolaev's result.

- [8] M. R. Casali, *Computing Matveev's complexity of non-orientable 3-manifolds via crystallization theory*, Topology Appl. **144** (2004), 201-209.
- [9] M. R. Casali, *Estimating Matveev's complexity via crystallization theory*, Discrete Math. **307** (2007), 704-714.
- [10] M. R. Casali - P. Cristofori, *Computing Matveev's complexity via crystallization theory: the orientable case*, Acta Appl. Math. **92** (2006), 113-123.
- [11] M.R.Casali - P.Cristofori - M.Mulazzani, *Complexity computation for compact 3-manifolds via crystallizations and Heegaard diagrams*, Topology and its Applications **159** (13) (2012), 3042-3048. [<http://dx.doi.org/10.1016/j.topol.2012.05.016>]
- [12] M.R.Casali - C.Gagliardi, *Classifying PL 5-manifolds up to regular genus seven*, Proc. Amer. Math. Soc. **120** (1994), 275-283.
- [13] M.R.Casali - L.Malagoli, *Handle-decompositions of PL 4-manifolds*, Cahiers de Topologie et Geom. Diff. Cat. **38** (1997), 141-160.
- [14] A. Cattabriga - M. Mulazzani - A. Vesnin, *Complexity, Heegaard diagrams and generalized Dunwoody manifolds*, J. Korean Math. Soc. **47** (2010), 585-599.
- [15] P. Cristofori, *Heegaard and regular genus agree for compact 3-manifolds*, Cahiers Topologie Geom. Differentielle Categ. **39** (1998), 221-235.
- [16] P. Cristofori - C. Gagliardi - L. Grasselli, *Heegaard and regular genus of 3-manifolds with boundary*, Rev. Mat. Univ. Complut. Madrid **8** (1995), 379-398.
- [17] M. Ferri - C. Gagliardi - L. Grasselli, *A graph-theoretical representation of PL-manifolds. A survey on crystallizations*, Aequationes Math. **31** (1986), 121-141.
- [18] E. Fominykh - B. Wiest, *Upper bounds for the complexity of torus knot complements*, preprint (2012).
- [19] C. Gagliardi, *On a class of 3-dimensional polyhedra*, Ann. Univ. Ferrara, Sez. VII, Sc. Mat., **33** (1987), 51-88.
- [20] C. Gagliardi, *Extending the concept of genus to dimension  $n$* , Proc. Amer. Math. Soc. **81** (1981), 473-481.
- [21] C. Gagliardi, *Regular imbeddings of edge-coloured graphs*, Geom. Dedicata **11** (1981), 397-414.
- [22] C. Gagliardi, *Regular genus: the boundary case*, Geom. Dedicata **22** (1987), 261-281.
- [23] C. Gagliardi, *Cobordant crystallizations*, Discrete Math. **45** (1983), 61-73.
- [24] L. Grasselli, *3-manifold spines and bijoins*, Revista Mat. Univ. Complutense Madrid **3** (1990), 165-179.
- [25] J. Hempel, *3-manifolds*, Annals of Math. Studies **86**, Princeton Univ. Press, 1976.
- [26] P. J. Hilton - S. Wylie, *An introduction to algebraic topology - Homology theory*, Cambridge Univ. Press, 1960.
- [27] S. Lins, *Gems, computers and attractors for 3-manifolds*, Knots and Everything **5**, World Scientific, 1995.
- [28] S. Matveev, *Complexity theory of three-dimensional manifolds*, Acta Appl. Math. **19** (1990), 101-130.
- [29] S. Matveev, *Algorithmic topology and classification of 3-manifolds*, ACM-Monographs **9**, Springer-Verlag, Berlin-Heidelberg-New York, 2003.
- [30] J.M. Montesinos, *Representing 3-manifolds by a universal branching set*, Math. Proc. Camb. Phil. Soc. **94** (1983), 109-123.
- [31] A. T. White, *Graphs, groups and surfaces*, North Holland, 1973.
- [32] H. Zieschang, *Classification of simple systems of paths on a solid pretzel of genus 2*, Sov. Math. **4** (1963), 1460-1463. [Transl. Dokl. Acad. Sci. USSR **152** (1963), 841-844]