

Eigenvalues and Low Energy Eigenvectors of Quantum Many-Body Systems

by

Ramis Movassagh

B.Sc., Applied and Engineering Physics, Cornell University

Submitted to the Department of Mathematics
in partial fulfillment of the requirements for the degree of

Doctor of Philosophy

at the

MASSACHUSETTS INSTITUTE OF TECHNOLOGY

June 2012

© Massachusetts Institute of Technology 2012. All rights reserved.

Author.....
Department of Mathematics
April 23, 2012

Certified by.....
Peter W. Shor
Professor
Thesis Supervisor

Accepted by.....
Michel Goemans
Chairman, Department Committee on Graduate Theses

arXiv:1211.4908v1 [quant-ph] 21 Nov 2012

Eigenvalues and Low Energy Eigenvectors of Quantum Many-Body Systems

by

Ramis Movassagh

Submitted to the Department of Mathematics
on April 23, 2012, in partial fulfillment of the
requirements for the degree of
Doctor of Philosophy

Abstract

I first give an overview of the thesis and Matrix Product States (MPS) representation of quantum spin systems on a line with an improvement on the notation.

The rest of this thesis is divided into two parts. The first part is devoted to eigenvalues of quantum many-body systems (QMBS). I introduce Isotropic Entanglement (IE), which draws from various tools in random matrix theory and free probability theory to accurately approximate the eigenvalue distribution of QMBS on a line with generic interactions. We then list some open related problems. Next, I discuss the eigenvalue distribution of one particle hopping random Schrödinger operator in one dimension from free probability theory in context of the Anderson model.

The second part is devoted to ground states and gap of QMBS. I first give the necessary background on frustration free Hamiltonians, real and imaginary time evolution of quantum spin systems on a line within MPS representation and a numerical implementation. I then prove the degeneracy and unfrustration condition for quantum spin chains with generic local interactions, including corrections to our earlier assertions. Following this, I summarize my efforts in proving lower bounds for the entanglement of the ground states, which includes partial new results, with the hope that they inspire future work resulting in solving the conjecture given therein. Next I discuss two interesting measure zero examples where the Hamiltonians are carefully constructed to give unique ground states with high entanglement. One of the examples (i.e., $d = 4$) has not appeared elsewhere. In particular, we calculate the Schmidt

numbers exactly, entanglement entropies and introduce a novel technique for calculating the gap which may be of independent interest. The last chapter elaborates on one of the measure zero examples (i.e., $d = 3$) which is the first example of a frustration free translation-invariant spin-1 chain that has a unique highly entangled ground state and exhibits signatures of a critical behavior.

Thesis Supervisor: Peter W. Shor

Title: Professor

Acknowledgments

First and foremost I like to thank my advisor Peter W. Shor for his unconditional support, trust in my decisions and having provided an umbrella, as much as it was possible for him, under which I could work happily and freely. Interactions with him energize and inspire me.

I thank Alan Edelman, from whom I learned everything I know about random matrix theory, free probability theory and a good deal of linear algebra and Matlab. I thought I knew the latter two, till I met Alan. Above all I thank him for his friendship. I like to thank Jeffrey Goldstone for his time, many exciting discussions and his critical reading of my work when I asked him to.

I thank Daniel Nagaj for the discussions the first summer I started, Salman Beigi for various discussions, Bernie Wang for helping with Latex issues when I was writing my thesis and Eduardo Cuervo-Reyes for exciting physics related discussions during my Zürich years.

There have been many great scientists who influenced my scientific life trajectory in positive ways. I am very grateful to Reinhard Nesper, Roald Hoffmann, Mehran Kardar, and Richard V. Lovelace. I also like to thank Otto E. Rössler, Jürg Fröhlich, John McGreevy, Jack Wisdom, Alexei Borodin and John Bush.

I have been fortunate to have met so many wonderful people and made wonderful friendships during my PhD at MIT; too many to name here. I owe a good share of my happiness, balance in life, and the fun I had, to them.

Last but certainly not least, I thank my dad, Javad Movassagh, and mom, Mahin Shalchi, for the biological existence and all they did for my sister and I to have a worthwhile future and an education. I dedicate this thesis to them.

Contents

1	Many-Body Physics and an Overview	19
1.1	Phase Space	19
1.2	Part I: Eigenvalues	23
1.3	Part II: Eigenvectors	24
1.3.1	SVD and Matrix Product States (MPS) on a Line	27
1.3.2	MPS on a Tree	31
I	Eigenvalues	33
2	Isotropic Entanglement	35
2.1	Elusive Spectra of Hamiltonians	35
2.2	The Method of Isotropic Entanglement	38
2.2.1	Overview	38
2.2.2	Inputs and Outputs of the Theory	41
2.2.3	More Than Four Moments of Accuracy?	41
2.3	Spectra Sums in Terms of Probability Theory	42
2.3.1	Classical	43
2.3.2	Free and Isotropic	43

2.3.3	Quantum	45
2.4	Theory of Isotropic Entanglement	47
2.4.1	Isotropic Entanglement as the Combination of Classical and Isotropic	47
2.4.2	The Departure and The Matching Three Moments Theorems .	48
2.4.3	Distribution of A and B	51
2.4.4	Evaluation and Universality of $p = \frac{\gamma_2^q - \gamma_2^{iso}}{\gamma_2^c - \gamma_2^{iso}}$	53
2.4.5	The Slider Theorem and a Summary	64
2.5	A Detailed Example: Wishart Matrices as Local Terms	71
2.5.1	Evaluation of $p = \frac{\gamma_2^q - \gamma_2^{iso}}{\gamma_2^c - \gamma_2^{iso}}$	72
2.5.2	Summary of Our Findings and Further Numerical Results . .	74
2.6	Other Examples of Local Terms	81
2.7	Beyond Nearest Neighbors Interaction: $L > 2$	83
2.8	Conjectures and Open Problems	85
2.9	Appendix	87
3	Calculating the Density of States in Disordered Systems Using Free Probability	89
3.1	Introduction	90
3.2	Quantifying the error in approximating a PDF using free probability	91
3.3	The free convolution	92
3.4	Decomposition of the Anderson Hamiltonian	94
3.5	Numerical free convolution	95
3.6	Analytic free convolution	98
3.7	Comparison with other approximations	100

II	Eigenvectors	103
4	Generic Quantum Spin Chains	105
4.1	Frustration Free Condition	105
4.2	Why Care About Frustration Free Systems?	109
4.3	Why Does Imaginary Time Evolution Work?	110
4.4	Numerical Study of Quantum Spin Chains Using MPS	111
4.5	Degeneracy and Non-Frustration Condition for Generic Local Terms .	116
4.6	Generic Interactions	117
4.7	Numerical investigation using Matrix Product States	121
4.8	Summary	123
4.9	Appendix	124
5	Entanglement of The Ground States	127
5.1	Set Up	128
5.1.1	Genericity of $C^{[n]}$	128
5.1.2	Basis for Solutions and $C^{[n]}$	128
5.1.3	Constructing Solutions for $d \leq r \leq d^2/4$	130
5.2	First Method: Choosing Solutions	133
5.2.1	Rank of $C^{[n]}$	135
5.2.2	Towards Entanglement Bounds	135
5.3	Second Method: Matching Solutions	136
5.4	What Does Algebraic Geometry Buy You?	139
6	Examples of Quantum 2-SAT and Combinatorial Techniques	141
6.1	Quantum 2-SAT for balanced parentheses ($d = 3$)	142
6.1.1	Entanglement entropy	147

6.2	Quantum 2-SAT for Mirror Symmetric States ($d = 4$)	155
6.2.1	Entanglement entropy	163
7	Criticality Without Frustration for Quantum Spin-1 Chains	171
7.1	Motivation	171
7.2	Supplementary Material	188
7.2.1	Schmidt coefficients of the Motzkin state	188
7.2.2	Proof of Lemma 2	191
7.2.3	Proof of Lemma 3	192
7.2.4	Ground state energy for unbalanced subspaces	196

List of Figures

1.1.1 Sparsity pattern of H . The nonzero elements for k odd are shown in blue and k even in red.	22
1.2.1 Parameter counting	25
1.3.1 Some general N interaction quantum spins whose pure state is represented by Eq. 1.1.2.	28
1.3.2 Decompositions that define $\Gamma^{[n]}$ in the derivation of MPS.	30
1.3.3 MPS representation	32
2.1.1 Odd and even summands can separately be locally diagonalized, but not the sum. The overlap of the two subsets at every site generally requires a global diagonalization.	37
2.2.1 The method of Isotropic Entanglement: Quantum spectra as a convex combination of isotropic and classical distributions. The Slider (bottom) indicates the p that matches the quantum kurtosis as a function of classical ($p = 1$) and isotropic ($p = 0$) kurtoses. To simplify we drop the tensor products (Eq. 2.3.7) in the local terms (ellipses on top). Note that isotropic and quantum convolution depend on multivariate densities for the eigenvalues.	39

2.2.2 The exact diagonalization in dots and IE compared to the two approximations. The title parameters are explained in the section on numerical results.	40
2.2.3 Inputs and outputs of the IE theory. See section 2.3 for the definition of $d\nu^{IE}$	41
2.2.4 IE vs. Pearson and Gram-Charlier	42
2.4.1 The terms in the expansion of $\frac{1}{m}\mathbb{E}\left[\text{Tr}\left(AQ_q^T BQ_q\right)^2\right]$ can be visualized as picking an element from each row from top to bottom and multiplying. Each row has k of the local terms corresponding to a chain with odd number of terms. Among k^4 terms roughly k^2 of them differ among the classical, isotropic and quantum cases (See Eqs. 2.4.19 and 2.4.20). An example of such a choice is shown by diamonds.	57
2.4.2 An example: $\beta = 1$: the quantum problem for all d lies in between the iso ($p = 0$) and the classical ($p = 1$).	69
2.5.1 $N = 3$ examples. Note that the last two plots have the same p despite having different ranks r . This is a consequence of the Universality Lemma since they have the same N and d	77
2.5.2 $N = 5$	78
2.5.3 $N = 7$	79
2.5.4 $N = 9$. Note that the two plots have the same p despite having different local ranks.	80
2.5.5 $N = 11$	81
2.6.1 GOE's as local terms	82
2.6.2 Local terms have a random binomial distribution.	83
2.7.1 IE method approximates the quantum spectrum by $H^{IE} = \sum_{l=1}^4 Q_l^T H_{l,\dots,l+2} Q_l$	84

2.7.2 IE method approximates the quantum spectrum by $H^{IE} = \sum_{l=1}^3 Q_l^T H_{l,\dots,l+3} Q_l$.

84

2.7.3 IE method approximates the quantum spectrum by $H^{IE} = \sum_{l=1}^2 Q_l^T H_{l,\dots,l+4} Q_l$ 85

3.5.1 Calculation of the DOS, $\rho(\xi)$, of the Hamiltonian H of (3.4.1) with $M = 5000$ samples of 2000×2000 matrices for (a) low, (b) moderate and (c) high noise ($\sigma/J=0.1, 1$ and 10 respectively with $\sigma = 1$). For each figure we show the results of free convolution defined in Scheme I ($\rho^{(A_1 \boxplus B_1)}$; black solid line), Scheme II ($\rho^{(A_2 \boxplus B_2)}$; green dashed line) and exact diagonalization ($\rho^{(H)}$; red dotted line). 96

3.5.2 Diagrammatic expansion of the term $\langle A_1 B_1 A_1 B_1 A_1 B_1 A_1 B_1 \rangle$ in terms of allowed paths dictated by the matrix elements of A_1 and B_1 of Scheme I in (3.4.2a). 97

3.6.1 DOS, $\rho(\xi)$, of the Hamiltonian (3.4.1) with $M = 5000$ samples of 2000×2000 matrices with (a) low, (b) moderate and (c) high semi-circular on-site noise ($\sigma/J=0.1, 1$ and 10 respectively with $\sigma = 1$), as calculated with exact diagonalization (red dotted line), free convolution (black solid line), and perturbation theory with A_1 as reference (blue dashed line) and B_1 as reference (gray dash-dotted line). The partitioning scheme is Scheme I of (3.4.2a). 99

4.6.1 The existence of zero energy ground states for a qudit chain with d -dimensional qudits and r projectors per pair. We highlight two notable cases: $d = 2, r = 1$ and $d = 4, r = 4$ 119

4.7.1 (Color online) Ground state energy from imaginary time evolution vs. χ for different ranks of the Hamiltonian. This is a plot for $d = 4$, and projector ranks of 2, 4, 6. Exact description would require $\chi = d^{\frac{N}{2}} = 2^{20}$. 121

4.7.2 This is a plot for $d = 5$, and projector ranks of 4, 6, 8. Exact description would require $\chi = 5^{10}$.	122
4.7.3 The case of $d = 6$, and projector ranks: 5, 7, 9, 11. Exact description in general would require $\chi = 6^{10}$.	123
6.1.1 The states of the qudit.	142
6.1.2 A state in the ground state for $d = 3$ example. The high amount of entanglement is due to the high mutual information between the two halves of the chain.	145
6.1.3 Entanglement entropy for the case of qutrits	155
6.2.1 Normalization as a function of n .	170
6.2.2 Entropy $H(\{M_m^2\})$ vs. n for $d = 4$ case. We include the figure on left to demonstrate the closeness of the approximation.	170
7.1.1 The spectral gap Δ of the Hamiltonian H defined in Eq. (7.1.2) for $3 \leq n \leq 13$ obtained by the exact diagonalization. The dashed line shows a linear fit $\log \Delta = 0.68 - 2.91 \log n$. Our numerics suggests that the first excited state of H belongs to the subspace spanned by strings with exactly one unmatched bracket.	176

7.1.2 (Color Online) Five lowest levels of the supertree \mathcal{T} . Nodes of \mathcal{T} are Dyck paths — balanced strings of left and right brackets. Depth- k nodes are in one-to-one correspondence with Dyck paths of length $2k$ (the set \mathcal{D}_k). Any step towards the root requires removal of a consecutive $[]$ pair. Any node has at most four children. The supertree can be described a family of maps $f : \mathcal{D}_k \rightarrow \mathcal{D}_{k-1}$ such that $f(s)$ is the parent of s . The maps f are defined inductively such that $f([X]) = [f(X)]$, $f([]Y) = []f(Y)$ for any node, $f([X]Y) = [f(X)]Y$ for black nodes, and $f([X]Y) = [X]f(Y)$ for red (shaded) nodes. See the proof of Lemma 3 in the Supplementary Material for more details. 186

List of Tables

2.1	Various β -Haar matrices.	44
2.2	Notation	50
2.3	The multiplicity of terms in A and B for OBC. For closed boundary conditions there is no repetition.	52
2.4	The expectation values and counts of colliding terms in Q when it is β -Haar distributed. In this section we use the first row; we include the last three rows for the calculations in the appendix.	54
2.5	Expectation values.	66
2.6	Summary of the results when the local terms are Wishart matrices. The fourth moment is where the three cases differ.	75
2.8	The mean, variance and skewness of classical, iso and quantum results match. However, the fourth moments (kurtoses) differ. Here we are showing results for $d = 2$, $r = 4$ with an accuracy of three decimal points.	76

Chapter 1

Many-Body Physics and an Overview

Physics is concerned with specification and evolution in time of the state of particles given the laws of interactions they are subjected to. This thesis is devoted to better understanding of quantum aspects of Many-Body Systems.

1.1 Phase Space

The phase space of a classical system of N particles is a $6N$ dimensional space where each particle contributes 3 spatial coordinates and 3 momenta. A point in this space fully specifies the state of the system at any given time; the motion of this point in time specifies the time evolution of the system. Even if the laws of interaction are precisely formulated, the analytical solution of the equations of motion, given the exact initial state, can be daunting ¹. The complexity is due to interactions.

¹Uncertainties in the initial conditions can give rise to further complications caused by chaotic behavior for positive Lyapunov exponents

For example general solution of the 3–body problem has been an open problem for roughly 350 years[1]. Despite the interaction being 2–body, the correlation in time, of the distances between pairs of masses makes the analytical solution hard to obtain. In such a case, one can resort to computational methods to simulate and make predictions with controllable accuracy by keeping track of $6N$ real parameters.

The state of a quantum system of N interacting particles is defined by a *ray* in the Hilbert space, the dimension of which is a multiplicative function of the dimension of individual Hilbert spaces (see [2, 3, section 2.1] for nice expositions of quantum theory). Mathematically,

$$|\psi\rangle \in \bigotimes_{i=1}^N \mathcal{H}_i, \tag{1.1.1}$$

where we denote the Hilbert space of the i^{th} particle by \mathcal{H}_i and, following Dirac’s notation [2, section 20], the pure state of the system by the vector $|\psi\rangle$. We restore $|\cdot\rangle$ only when ambiguity of the label of the vector with linear operators preceding it may arise. To fully specify the system one needs to specify d^N complex numbers (assuming each particle has d degrees of freedom), which makes the study of quantum many-body systems (QMBS) computationally intractable. This, compared to simulation of classical many-body systems, is an additional obstacle we face. Hence, the complexity in studying QMBS is in interactions as well as state specification.

It is worth mentioning that there are quantum systems that are particularly simple, without having as simple a classical analogue. An example of which is a quantum bit (*qubit*), whose state consists of only two points in the phase space.

In this thesis we confine ourselves to finite dimensional Hilbert spaces where a general pure state of an N –body problem each of which having d states is

$$|\psi\rangle = \sum_{i_1, \dots, i_N} \psi^{i_1 \dots i_N} |i_1\rangle \otimes |i_2\rangle \otimes \dots \otimes |i_N\rangle. \quad (1.1.2)$$

where repeated indices are summed over. ²

In classical physics one can pick a single particle among N interacting particles, specify its state at some time and predict its evolution subject to the *fields* of the other particles. If after some time the fields impressed on this particle by the remaining particles diminish, the particle becomes free and uncorrelated from the remaining $N - 1$ particles. In contrast, in quantum mechanics, interaction can lead to quantum correlations (entanglement) that persist even if the interaction strength diminishes, by say taking the particles far apart. For example two electrons can interact for some time and end up in the entangled state $|\psi_{1,2}\rangle = |00\rangle + |11\rangle$ [39, see discussions on EPR pairs]. This peculiar feature of quantum mechanics, as of yet unexplained by classical physics, is a radical departure from the latter. Quantum computation and quantum information science make use of entanglement as a resource to do tasks that are classically difficult or impossible to do in reasonable time such as [4, 5].

Whether, for a given real linear operator, any eigenvalues and eigenvectors exist, and if so, how to find them is in general very difficult to answer [2, p. 32].

In this thesis I mainly focus on QMBS systems with Hamiltonians (except in chapter 3)

$$H = \sum_{l=1}^{N-1} \mathbb{I}_{d^{l-1}} \otimes H_{l,l+1} \otimes \mathbb{I}_{d^{N-l-1}}. \quad (1.1.3)$$

See Figure 1.1.1 for the sparsity pattern of H .

Eq. 1.1.2 is the most general equation for a pure state of N particles irrespective

²One could further simplify the notation by denoting the state by $|\psi\rangle \equiv \sum_{i_1, \dots, i_N} \psi^{i_1 \dots i_N} |i_1\rangle_{i_2} \dots |i_N\rangle$, but I do not think it is worth the trade offs.

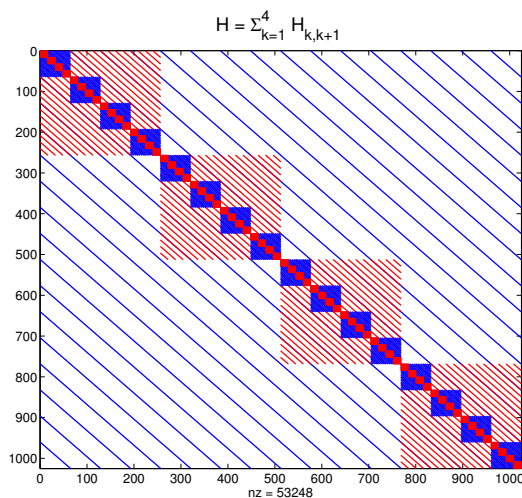

Figure 1.1.1: Sparsity pattern of H . The nonzero elements for k odd are shown in blue and k even in red.

of the type of interactions or configuration (see Fig. 1.3.1). However, the state of a system for any given problem has inherent constraints such as an underlying lattice that reduces the spatial degrees of freedom, a range of interaction, or underlying symmetries that the system has to obey. It is therefore, reasonable to suspect that the physical properties of any given problem could be well approximated by a reduced number of parameter say $\sim \text{poly}(N)$ if one understood the effective degrees of freedom well enough.

Non-commutativity of the interaction in QMBS is responsible for the richness of possibilities such as various phases of matter and quantum computing. Simultaneously, it is accountable for formidability of finding eigenvalues and corresponding eigenvectors. The exact computation of eigenvalues alone, on a line, has shown to be QMA-Hard [31]. Energy *eigenvalue distributions* are needed for calculating the partition function and calculating other transport properties (Part I). The eigenvectors specify the corresponding states of the system. Bulk of matter usually finds itself in

its *lowest energy* [28, p. 48]; hence, the urge to comprehend the low lying states in condensed matter research (Part II).

1.2 Part I: Eigenvalues

Consider the general problem of predicting the eigenvalue distribution of sums of matrices from the known distribution of summands. In general this is impossible to do without further information about the eigenvectors. However, any progress in this direction is extremely desirable as many problems are modeled by non-commuting matrices. For example, the Schrödinger equation has a kinetic term and a potential term; often the former is diagonalizable in the Fourier and the latter in position space. However, the sum does not have an obvious global basis nor a distribution that can trivially be inferred from the known pieces.

For the sake of concreteness suppose we are interested in the distribution of the random matrix $M = M_1 + M_2$ where the distributions of M_1 and M_2 are known. There are two special cases worth considering:

1. The summands commute. In this case, one can find a simultaneous set of eigenvectors that diagonalizes each of the summands. In the language of linear algebra of diagonal matrices, the eigenvalues add. When the eigenvalues are random, this connects us to the familiar classical probability theory where the distribution of the sum is obtained by a convolution of the distribution of the summands.
2. The summands are in generic positions. In this case, the eigenvectors of the summands are in generic positions. It is a fascinating fact that this case also has a known analytical answer given by Free Probability Theory (FPT) [84][48].

The eigenvalue distribution of M is given by the “free convolution” of the distributions of M_1 and M_2 .

There are many interesting questions that one can ask. How “free” are general non-commuting matrices? What is the relationship between commutation relation and freeness of two matrices? To what extent does the Fourier matrix act generic? Can a large class of non-commuting matrices be analyzed using a convex combination of the two extreme cases discussed above (see Isotropic Entanglement)?

Suppose the local terms in Eq. 1.1.3 are generic (i.e., random matrices), can we utilize the existing tools of random matrix theory to capture the eigenvalue distribution of H given the distribution of $H_{l,l+1}$ ’s? Despite, the local terms being generic, H is non-generic. The number of random parameters grow polynomially with N whereas H is d^N dimensional. Fraction of sparsity of H is $\leq (N - 1) d^{-(N-2)}$ (Figure 1.1.1).

Since the exact evaluation of the density of H is very difficult [31], one can use two known approximations. As far as parameter counting is concerned the quantum problem falls nicely in between the two extreme case (Figure 1.2.1 and Isotropic Entanglement).

Chapter 2 gives a detailed description of Isotropic Entanglement which gives the distribution of Eq. 1.1.3 and elaborates on the discussion of this section.

Chapter 3 is on the distribution of one particle hopping random Schrödinger equation and Anderson model.

1.3 Part II: Eigenvectors

Is it possible to capture the essential physics of the system accurately enough with an efficient simulation with a much smaller $\chi \sim \text{poly}(N)$, spanning only a small part

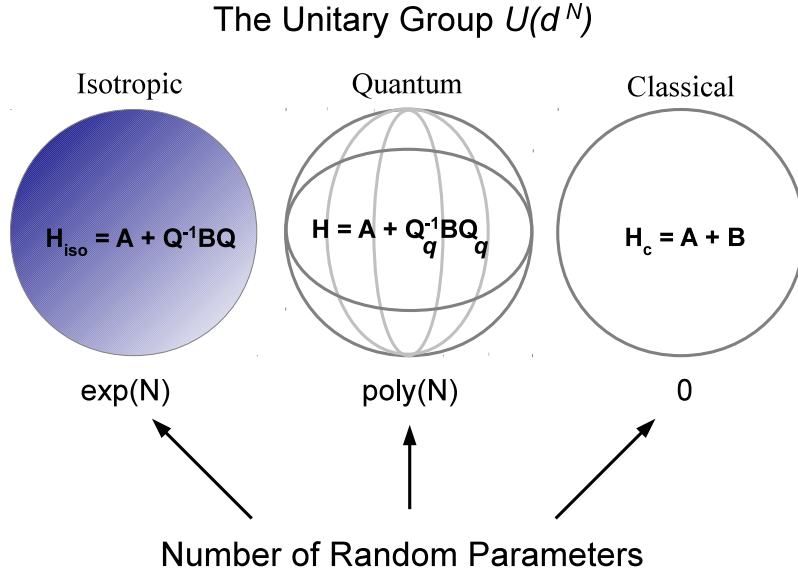

Figure 1.2.1: Parameter counting

of the full Hilbert space of the system? In our case, the qudits are arranged on a 1D lattice and only have nearest-neighbor interactions. We could thus expect that a reduced space might suffice for our needs. This concept is common for the various approaches proposed for efficient (tractable on a classical computer) numerical investigation of quantum many body systems such as the Density Matrix Renormalization Group [35], Matrix Product States [37], Tensor Product States [36] and projected entangled pair states (PEPSs) [100]. For gapped one dimensional systems MPS ansatz is proved to suffice [112]. Consider a general Hamiltonian for 1D open chain with generic local interactions as given by Eq. 1.1.3, where each $H_{l,l+1}$ is a $d^2 \times d^2$ matrix of rank r and the total number of particles is N .

It is interesting to ask under what circumstances can there be a degeneracy of ground states? Moreover, when is the ground state of the whole system (H in Eq.

1.1.3) also the local ground state of all $H_{l,l+1}$'s ; i.e., the system is “unfrustrated”? We answered these questions for $1D$ spin systems with *generic* interactions [133] (Chapter 6). We found that in the regime where $r \leq d^2/4$ the system is unfrustrated with many ground states; moreover for $r < d$ there can be product states among the ground states. For sufficiently large N the system is frustrated for $r > d^2/4$.

The next natural question is: how entangled are the ground states in the regime $d \leq r \leq d^2/4$? The entanglement can be quantified by the Schmidt rank (see MPS below). We call a state highly entangled if its Schmidt rank is exponentially large in the number of particles. In this regime, it is straightforward to show that among the many ground states, there are no product states and that there exist states with high amount of entanglement with probability one. The latter can be shown for example using results of algebraic geometry [11][10]. I have been trying to show that *all* the ground states, in this regime, have Schmidt ranks that are exponentially large with probability one. Despite some partial results, the goal has not been fulfilled.

Using a genericity argument one can show that, to prove results in the generic case, it is sufficient to find an example of local terms whose ground states all have large Schmidt ranks. We have not yet succeeded in finding such examples in the regime of interest $d \leq r \leq d^2/4$. There are, however, interesting examples for which there is a unique ground state with exponentially large entanglement in the *frustrated* regime, i.e., probability zero case (Chapters 8 and 9).

Below I give a background on Matrix Product States on with an improvement on the notation.

Chapter 4 discusses the unfrustration condition and a numerical code I developed to study spin systems on a line with local interactions and without translational invariance. I find the ground states using imaginary time evolution. I then provide the proofs and corrections of our previous work regarding the unfrustration condition

and degeneracy of quantum spin chains with generic local interactions.

Chapter 5 summarizes various attempts I made in proving a lower bound on the Schmidt rank of the ground states of generic spin chains. It includes unpublished results and two ways one can potentially prove the conjecture given there.

Chapter 6 discusses two interesting measure zero examples ($d = 3$ and $d = 4$). I include the combinatorial techniques for calculating the entanglement entropies. The $d = 4$ example has not been published elsewhere.

Chapter 7 elaborates on the $d = 3$ example of Chapter 6 and has a novel technique for calculating the gap that may be of independent interest.

1.3.1 SVD and Matrix Product States (MPS) on a Line

In this section, in order to avoid confusion, we restore the summation symbols. As stated earlier the state of a composite system is a vector in the tensor product of the Hilbert spaces of the constituents. Suppose we have the pure state of a composite system, how can we express it in terms of the pure states of the constituents? This is answered by singular value decomposition (SVD). This application of SVD in quantum information theory is called Schmidt Decomposition [6],[39].

Theorem 1. (*Schmidt Decomposition*) *Let H_1 and H_2 be Hilbert spaces of dimensions n and m respectively. Assume $m \leq n$. For any vector $|\psi_{12}\rangle \in H_1 \otimes H_2$, there exists orthonormal sets $\{|\eta_1\rangle, \dots, |\eta_n\rangle\} \subset H_1$ and $\{|\omega_1\rangle, \dots, |\omega_m\rangle\} \subset H_2$ such that $|\psi\rangle = \sum_{i=1}^m \lambda_i |\eta_i\rangle \otimes |\omega_i\rangle$, where λ_i are non-negative and, as a set, uniquely determined by $|\psi\rangle$.*

The number of nonzero λ 's are called the Schmidt rank denoted by χ .

Comment: $\chi \leq m \leq n$; the Schmidt rank is no greater than the minimum of the dimensions of the two Hilbert spaces.

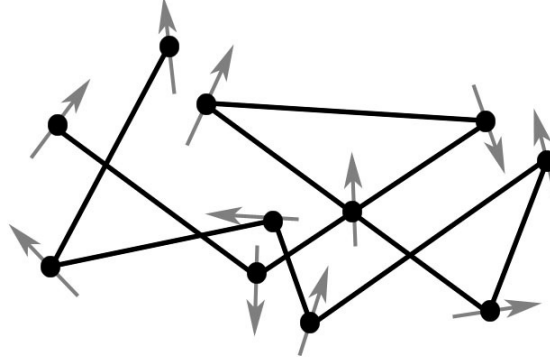

Figure 1.3.1: Some general N interaction quantum spins whose pure state is represented by Eq. 1.1.2.

Comment: Schmidt Decomposition can be thought of as an expansion of a vector in bases of the subsystems. The need for having more than one expansion coefficient (i.e., $\chi > 1$) indicates that the state is not separable in any basis (i.e., subsystems are entangled). A quantifier for entanglement is therefore χ .

DMRG, natural representation of which is MPS, beautifully utilizes Schmidt Decomposition to capture low energy properties of QMBS on a line or trees [33, 34][7]. Though any state can be expressed as a MPS, the time evolution is only naturally implemented for the line or a tree. Some attractive features are 1. MPS gives a local description of QMBS on a line 2. MPS allows for a systematic truncation of the Hilbert space to capture the low energy properties with controllable accuracy. Below I give a derivation of MPS similar to [96] and improve the notation by making it more compact (Eq. 1.3.8).

Suppose we have a chain with N sites and take $1 \leq n \leq N$. First, perform a Schmidt decomposition of the chain between sites $n - 1$ and n as

$$|\psi\rangle = \sum_{\alpha_{n-1}}^{\chi_{n-1}} \lambda_{\alpha_{n-1}}^{(n-1)} |\phi_{\alpha_{n-1}}\rangle_{1,\dots,n-1} \otimes |\phi_{\alpha_{n-1}}\rangle_{n,\dots,N}, \quad (1.3.1)$$

where the states on the left and on the right of the division form an orthonormal bases for the respective subsystems of the state of ψ . The Schmidt rank χ_{n-1} is the minimum number of terms required in this decomposition. Recall that χ_{n-1} is at most equal to the minimum dimension of the Hilbert spaces of the two subsystems.

Next, the Schmidt decomposition for a split between n and $n + 1$ gives

$$\psi\rangle = \sum_{\alpha_n}^{\chi_n} \lambda_{\alpha_n}^{(n)} |\theta_{\alpha_n}\rangle_{1,\dots,n} \otimes \theta_{\alpha_n}\rangle_{n+1,\dots,N}. \quad (1.3.2)$$

These two decompositions describe the same state Eq. 1.1.2, allowing us to combine them by expressing the basis of the subsystem n, \dots, N as

$$\phi_{\alpha_{n-1}}\rangle_{n,\dots,N} = \sum_{i_n=1}^d \sum_{\alpha_n=1}^{\chi_n} \Gamma_{\alpha_{n-1},\alpha_n}^{i_n,[n]} \lambda_{\alpha_n}^{(n)} |i_n\rangle \otimes \theta_{\alpha_n}\rangle_{n+1,\dots,N}, \quad (1.3.3)$$

where we inserted $\lambda_{\alpha_n}^{(n)}$ for convenience. This gives us the tensor $\Gamma^{[n]}$ which carries an index i_n corresponding to the physical states $|i_n\rangle$ of the n^{th} spin, and indices α_{n-1} and α_n corresponding to the two consecutive divisions of the system. Since $\phi_{\alpha_{n-1}}\rangle$ and $\theta_{\alpha_n}\rangle$ are orthonormal states, the vectors λ and tensors Γ obey the following normalization conditions. From Eq. 1.3.2 we have

$$\sum_{\alpha_n=1}^{\chi_n} \lambda_{\alpha_n}^{[n]2} = 1, \quad (1.3.4)$$

while 1.3.3 implies

$$\langle \phi_{\alpha'_{n-1}} | \phi_{\alpha_{n-1}} \rangle = \sum_{i_n=1}^d \sum_{\alpha_n=1}^{\chi_n} \Gamma_{\alpha'_{n-1},\alpha_n}^{[n],i_n*} \lambda_{\alpha_n}^{[n]} \Gamma_{\alpha_{n-1},\alpha_n}^{[n],i_n} \lambda_{\alpha_n}^{[n]} = \delta_{\alpha_{n-1},\alpha'_{n-1}}, \quad (1.3.5)$$

and

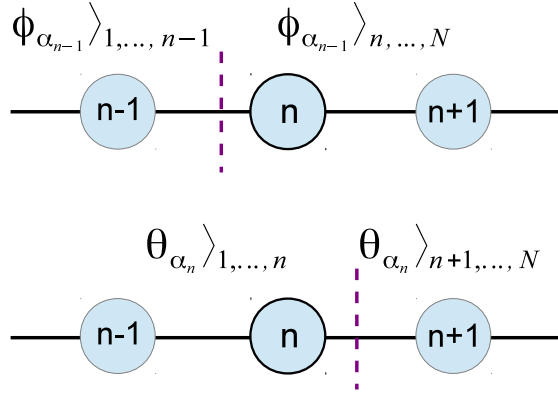

Figure 1.3.2: Decompositions that define $\Gamma^{[n]}$ in the derivation of MPS.

$$\langle \theta_{\alpha'_n} | \theta_{\alpha_n} \rangle = \sum_{i_n=1}^d \sum_{\alpha_{n-1}=1}^{\chi_{n-1}} \lambda_{\alpha_{n-1}}^{[n-1]} \Gamma_{\alpha_{n-1}, \alpha'_n}^{[n], i_n^*} \lambda_{\alpha_{n-1}}^{[n-1]} \Gamma_{\alpha_{n-1}, \alpha_n}^{[n], i_n} = \delta_{\alpha_n, \alpha'_n}. \quad (1.3.6)$$

One can do what we just did for every site $1 \leq n \leq N$ and get the MPS representation of the spin chain, denoting open boundary conditions and periodic boundary condition by OBC and PBC respectively,

$$\begin{aligned} \psi^{i_1 i_2 \dots i_N} &= \sum_{\alpha_1, \dots, \alpha_{N-1}=1}^{\chi} \Gamma_{1, \alpha_1}^{i_1, [1]} \Gamma_{\alpha_1, \alpha_2}^{i_2, [2]} \dots \Gamma_{\alpha_{N-1}, 1}^{i_N, [N]} && \text{OBC} && (1.3.7) \\ \psi^{i_1 i_2 \dots i_N} &= \sum_{\alpha_0, \alpha_1, \dots, \alpha_{N-1}=1}^{\chi} \Gamma_{\alpha_0, \alpha_1}^{i_1, [1]} \Gamma_{\alpha_1, \alpha_2}^{i_2, [2]} \dots \Gamma_{\alpha_{N-1}, \alpha_0}^{i_N, [N]} && \text{PBC} \end{aligned}$$

Comments: It is customary to absorb the λ 's into Γ 's and omit them as we did in the foregoing equation. The upper limit $\chi = \max_{1 \leq n \leq N} \{\chi_n\}$.

I believe the MPS notation given by Eq. 1.3.7 can be improved

$$\begin{aligned}
|\psi\rangle &= \mathcal{P} \left\{ \bigotimes_{p=1}^N \sum_{i_p=1}^d \Gamma(i_p) \sigma^{i_p} \right\} |0\rangle^{\otimes N} && \text{OBC} \\
|\psi\rangle &= \text{Tr}_\chi \mathcal{P} \left\{ \bigotimes_{p=1}^N \sum_{i_p=1}^d \Gamma(i_p) \sigma^{i_p} \right\} |0\rangle^{\otimes N} && \text{PBC}
\end{aligned} \tag{1.3.8}$$

where σ^{i_p} defined by $\sigma^{i_p} |0\rangle \equiv |i_p\rangle$ are the generalized Pauli operators, each $\Gamma(i_p) \equiv \Gamma^{[p],i_p} \rightarrow \Gamma_{\alpha_{p-1},\alpha_p}^{[p],i_p}$, for a given i_p , is a $\chi \times \chi$ matrix and \mathcal{P} denotes an ordering with respect to p of the tensor products. The subscript χ on the trace reminds us that the trace is on $\chi \times \chi$ part of Γ 's and not the physical indices i_p . Lastly, we can simplify notation by assuming repeated indices are summed over to get

$$\begin{aligned}
|\psi\rangle &= \mathcal{P} \left\{ \bigotimes_{p=1}^N \Gamma(i_p) \sigma^{i_p} \right\} |0\rangle^{\otimes N} && \text{OBC} \\
|\psi\rangle &= \text{Tr}_\chi \mathcal{P} \left\{ \bigotimes_{p=1}^N \Gamma(i_p) \sigma^{i_p} \right\} |0\rangle^{\otimes N} && \text{PBC}
\end{aligned} \tag{1.3.9}$$

Note that we now need at most $\sim Nd\chi^2$ parameters to specify any state. There are orthogonality conditions on Γ 's that further reduce the number of independent parameters needed.

1.3.2 MPS on a Tree

The MPS representation relies on splitting the system into two subsystems and making use of Schmidt Decomposition which applies for loop-less configuration of spins such as chains and trees. The derivation above can be generalized (see [96]) to

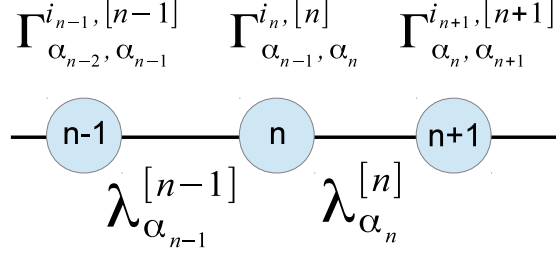

Figure 1.3.3: MPS representation

spins on a k -child tree.

$$|\psi\rangle = \left(\prod_{p \in \text{bonds}} \sum_{\alpha_p=1}^{\chi_p} \lambda_{\alpha_p}^{[p]} \right) \left(\prod_{n \in \text{sites}} \sum_{i_n} \Gamma_{\alpha_{n_1}, \dots, \alpha_{n_k}}^{i_n, [n]} \right) \dots \rangle \otimes |i_n\rangle \otimes \dots \rangle, \quad (1.3.10)$$

where $\alpha_{n_1}, \dots, \alpha_{n_k}$ are indices corresponding to the k bonds n_1, \dots, n_k coming out of site n . Each index α_{n_j} appears in k Γ tensors and one λ vector. The normalization conditions for a MPS description of a state on a tree are analogous to Eqs. 1.3.4, 1.3.5, and 1.3.6. We have

$$\sum_{\alpha_p} \lambda_{\alpha_p}^{[p]2} = 1, \quad (1.3.11)$$

$$\sum_{i_n} \sum_{\alpha_2, \dots, \alpha_n} \Gamma_{\alpha'_{n_1}, \dots, \alpha_{n_k}}^{i_n, [n]*} \lambda_{\alpha_{n_2}}^{[2]2} \dots \lambda_{n_k}^{[k]2} \Gamma_{\alpha_{n_1}, \dots, \alpha_{n_k}}^{i_n, [n]*} = \delta_{\alpha'_{n_1}, \alpha_{n_1}}, \quad (1.3.12)$$

and the other variations with n_2, \dots, n_k .

Part I

Eigenvalues

Chapter 2

Isotropic Entanglement

In this first part of the thesis I focus on the density of states or QMBS. This chapter treats the eigenvalue distribution of spin chains, though some of the theorems apply in higher dimensions. We treat generic local interactions, where by local I mean every interaction term acts nontrivially on L consecutive spins. This chapter also appears in [8, 9].

2.1 Elusive Spectra of Hamiltonians

Random matrix techniques have proved to be fruitful in addressing various problems in quantum information theory (QIT) [10, 32, 11] and theoretical physics [12, 13]. In condensed matter physics (CMP), quantum spins with random exchange have been extensively studied with surprising phase transition behaviors [16, 17, 14, 15].

Moreover, constraint satisfaction problems are at the root of complexity theory [18, 19]. The quantum analogue of the satisfiability problem (QSAT) encodes the constraints by a Hamiltonians acting on quantum spins (or qudits) [20]. Interesting phase transition behaviors have been seen for random QSAT with important implications for the Hardness of typical instances[21, 22, 23].

While the application of the aggregate of eigenvalues may be different in CMP, we point out a few examples where they are studied [24, 26, 25, 27]. By comparison, in QIT and CMP the ground state and the first few excited states have been well studied to date [33, 34, 35, 36, 37, 32, 38]. To the best of our knowledge the aggregate has not been as well studied perhaps in part because of the complexity [31] and perhaps in part because the *low* energy states have captivated so much interest to date.

Energy *eigenvalue distributions* or the *density of states (DOS)* are needed for calculating the partition function[28, p. 14]. The DOS plays an important role in the theory of solids, where it is used to calculate various physical properties such the internal energy, the density of particles, specific heat capacity, and thermal conductivity. Quantum Many-Body Systems (QMBS) spectra have been elusive for two reasons: 1. The terms that represent the interactions are generally non-commuting. This is pronounced for systems with random interactions (e.g., quantum spin glasses [44, 43]). 2. Standard numerical diagonalization is limited by memory and computer speed. The exact calculation of the spectrum of interacting QMBS has been shown to be difficult [31].

An accurate description of tails of distributions are desirable for CMP. Isotropic Entanglement (IE) provides a direct method for obtaining eigenvalue distributions of quantum spin systems with generic local interactions and does remarkably well in capturing the tails. Indeed interaction is the very source of entanglement generation [39, Section 2.4.1][40] which makes QMBS a resource for quantum computation [41] but their study a formidable task on a classical computer.

Suppose we are interested in the eigenvalue distribution of a sum of Hermitian matrices $M = \sum_{i=1}^N M_i$. In general, M_i cannot be simultaneously diagonalized, consequently the spectrum of the sum is not the sum of the spectra. Summation mixes the entries in a very complicated manner that depends on eigenvectors. Nevertheless, it seems possible that a one-parameter approximation might suffice.

Though we are not restricted to one dimensional chains, for sake of concreteness, we investigate N interacting d -dimensional quantum spins (qudits) on a line with generic interactions. The Hamiltonian is

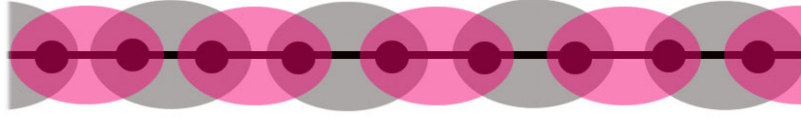

Figure 2.1.1: Odd and even summands can separately be locally diagonalized, but not the sum. The overlap of the two subsets at every site generally requires a global diagonalization.

$$H = \sum_{l=1}^{N-1} \mathbb{I}_{d^{l-1}} \otimes H_{l, \dots, l+L-1} \otimes \mathbb{I}_{d^{N-l-(L-1)}}, \quad (2.1.1)$$

where the local terms $H_{l, \dots, l+L-1}$ are finite $d^L \times d^L$ random matrices. We take the case of nearest neighbors interactions, $L = 2$, unless otherwise specified.

The eigenvalue distribution of any commuting subset of H such as the terms with l odd (the “odds”) or l even (the “evens”) can be obtained using local diagonalization. However, the difficulty in approximating the full spectrum of $H \equiv H_{\text{odd}} + H_{\text{even}}$ is in summing the odds and the evens because of their overlap at every site.

The intuition behind IE is that terms with an overlap, such as $H_{l, l+1}$ and $H_{l+1, l+2}$, introduce randomness and mixing through sharing of a site. Namely, the process of entanglement generation introduces an *isotropicity* between the eigenvectors of evens and odds that can be harnessed to capture the spectrum.

Random Matrix Theory (RMT) often takes advantage of eigenvectors with Haar measure, the uniform measure on the orthogonal/unitary group. However, the eigenvectors of QMBS have a more special structure (see Eq. 2.3.10).

Therefore we created a *hybrid theory*, where we used a finite version of Free Probability Theory (FPT) and Classical Probability Theory to capture the eigenvalue distribution of Eq. 2.1.1. Though such problems can be QMA-complete, our examples show that IE provides an accurate picture well beyond what one expects from the first four moments alone. The *Slider* (bottom of Figure 2.2.1) displays the proposed mixture p .

2.2 The Method of Isotropic Entanglement

2.2.1 Overview

We propose a method to compute the “density of states” (DOS) or “eigenvalue density” of quantum spin systems with generic local interactions. More generally one wishes to compute the DOS of the sum of non-commuting random matrices from their, individually known, DOS’s.

We begin with an example in Figure 2.2.2, where we compare exact diagonalization against two approximations:

- Dashed grey curve: *classical* approximation. Notice that it overshoots to the right.
- Solid grey curve: *isotropic* approximation. Notice that it overshoots to the left.
- Solid black curve: *isotropic entanglement (IE)*.
- Dots: *exact diagonalization* of the quantum problem given in Eq. 2.1.1.

The *classical approximation* ignores eigenvector structure by summing random eigenvalues uniformly from non-commuting matrices. The dashed curve is the convolution of the probability densities of the eigenvalues of each matrix.

The *isotropic approximation* assumes that the eigenvectors are in “general position”; that is, we add the two matrices with correct eigenvalue densities but choose the eigenvectors from Haar measure. As the matrix size goes to infinity, the resulting distribution is the free convolution of the individual distributions [48].

The exact diagonalization given by red dots, the dashed and solid grey curves have exactly the same first three moments, but differing fourth moments.

Isotropic Entanglement (IE) is a linear combination of the two approximations that is obtained by matching the fourth moments. We show that 1) the fit is better than what might be expected by four moments alone, 2) the combination is always

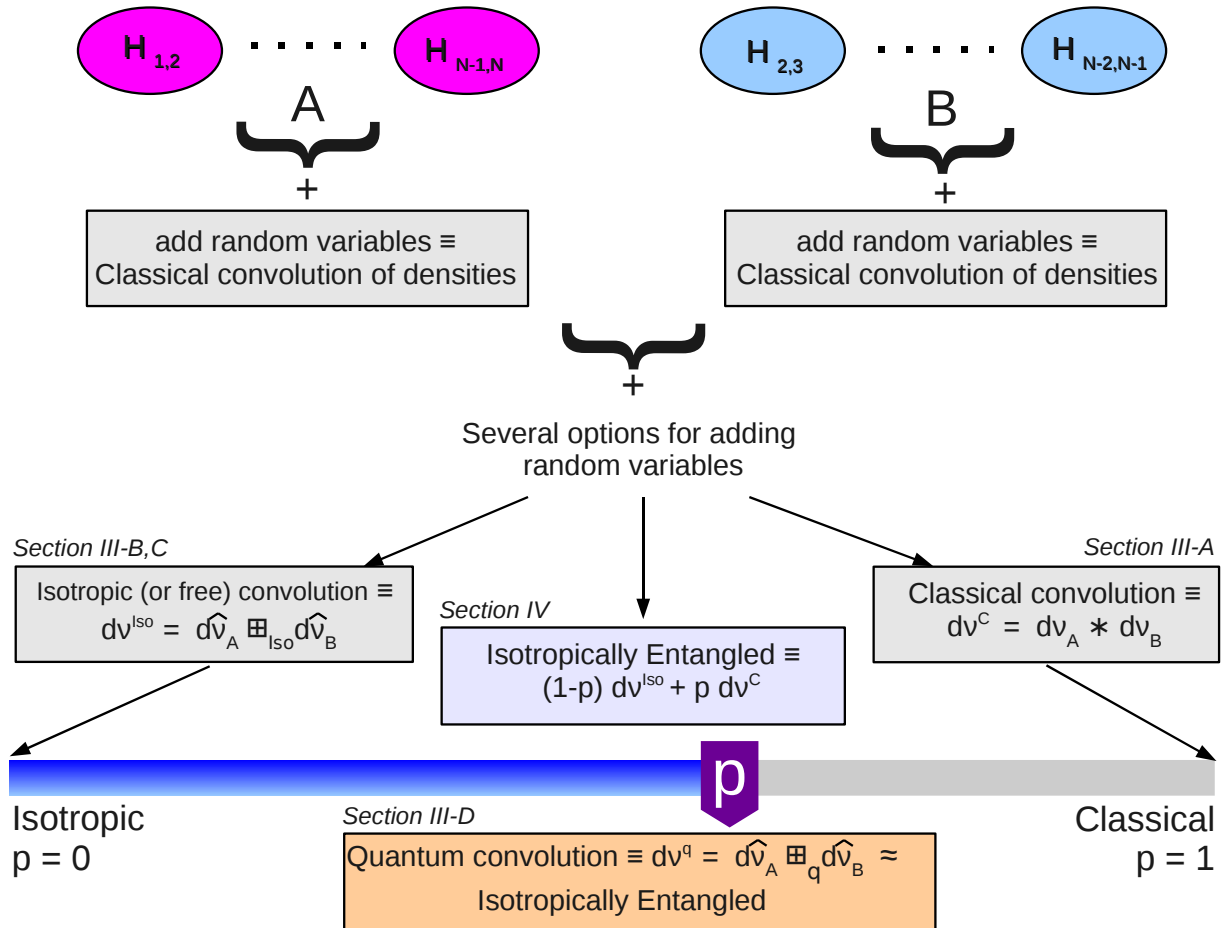

Figure 2.2.1: The method of Isotropic Entanglement: Quantum spectra as a convex combination of isotropic and classical distributions. The Slider (bottom) indicates the p that matches the quantum kurtosis as a function of classical ($p = 1$) and isotropic ($p = 0$) kurtoses. To simplify we drop the tensor products (Eq. 2.3.7) in the local terms (ellipses on top). Note that isotropic and quantum convolution depend on multivariate densities for the eigenvalues.

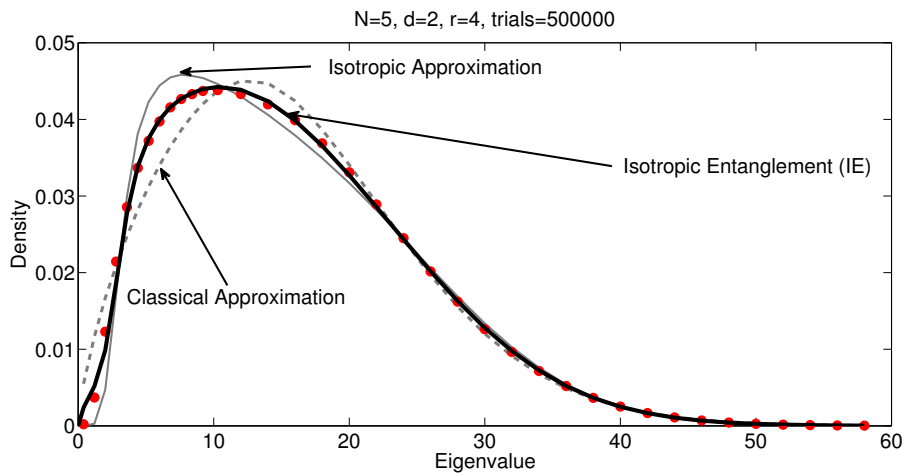

Figure 2.2.2: The exact diagonalization in dots and IE compared to the two approximations. The title parameters are explained in the section on numerical results.

convex for the problems of interest, given by $0 \leq p \leq 1$ and 3) this convex combination is universal depending on the parameter counts of the problem but not the eigenvalue densities of the local terms.

Parameter counts: exponential, polynomial and zero. Because of the *locality* of generic interactions, the complete set of eigenstates has parameter count equal to a polynomial in the number of spins, though the dimensionality is exponential. The classical and isotropic approximations have zero and exponentially many random parameters respectively. This suggests that the problem of interest somehow lies in between the two approximations.

Our work supports a very general principle that one can obtain an accurate representation of inherently exponential problems by approximating them with less complexity. This realization is at the heart of other recent developments in QMBS research such as Matrix Product States [33, 34], and Density Matrix Renormalization Group [35], where the *state* (usually the ground state of $1D$ chains) can be adequately represented by a Matrix Product State (MPS) ansatz whose parameters grow *linearly* with the number of quantum particles. Future work includes explicit treatment of fermionic systems and numerical exploration of higher dimensional systems.

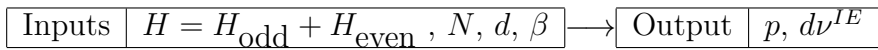

Figure 2.2.3: Inputs and outputs of the IE theory. See section 2.3 for the definition of $d\nu^{IE}$.

2.2.2 Inputs and Outputs of the Theory

In general we consider Hamiltonians $H = H_{\text{odd}} + H_{\text{even}}$, where the local terms that add up to H_{odd} (or H_{even}) form a commuting subset. All the physically relevant quantities such as the lattice structure, N , dimension of the spin d and the rank r are encoded in the eigenvalue densities. The output of the theory is a $0 \leq p \leq 1$ by which the IE distribution is obtained and $d\nu^{IE}$ serves as an approximation to the spectral measure. The inputs can succinctly be expressed in terms of the dimension of the quantum spins, and the nature of the lattice (Figure 2.2.3).

2.2.3 More Than Four Moments of Accuracy?

Alternatives to IE worth considering are 1) Pearson and 2) Gram-Charlier moment fits.

We illustrate in Figure 2.2.4 how the IE fit is better than expected when matching four moments. We used the first four moments to approximate the density using the Pearson fit as implemented in MATLAB and also the well-known Gram-Charlier fit [50]. In [49] it was demonstrated that the statistical mechanics methods for obtaining the DOS, when applied to a finite dimensional vector space, lead to a Gaussian distribution in the lowest order. Further, they discovered that successive approximations lead naturally to the Gram-Charlier series [50]. Comparing these against the accuracy of IE leads us to view IE as more than a moment matching methodology.

The departure theorem (Section 2.4.2) shows that in any of the higher moments (> 4) there are many terms in the quantum case that match IE exactly. Further, we conjecture that the effect of the remaining terms are generally less significant.

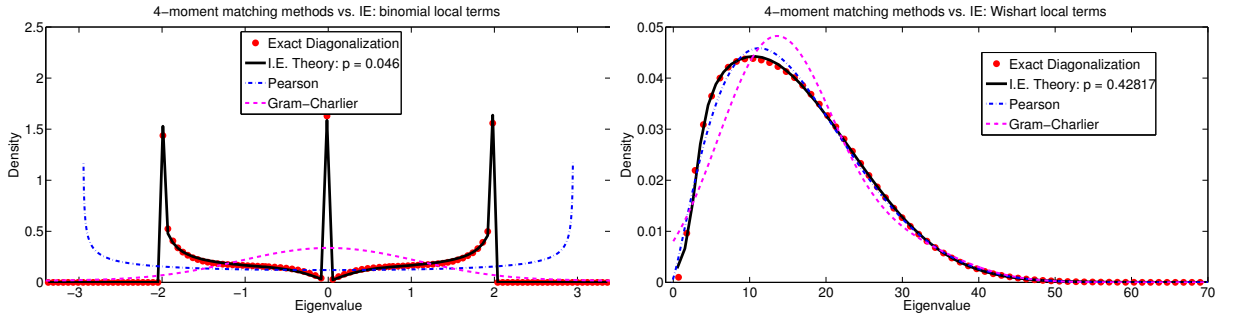

Figure 2.2.4: IE vs. Pearson and Gram-Charlier

2.3 Spectra Sums in Terms of Probability Theory

The density of eigenvalues may be thought of as a histogram. Formally for an $m \times m$ matrix M the *eigenvalue distribution* is [45, p. 4][46, p. 101]

$$d\nu_M(x) = \frac{1}{m} \sum_{i=1}^m \delta(x - \lambda_i(M)). \tag{2.3.1}$$

For a random matrix, there is the expected eigenvalue distribution [47], [48, p. 362]

$$d\nu_M(x) = \frac{1}{m} \mathbb{E} \left[\sum_{i=1}^m \delta(x - \lambda_i(M)) \right], \tag{2.3.2}$$

which is typically a smooth curve [45, p. 101][46, p. 115].

The eigenvalue distributions above are measures on one variable. We will also need the multivariate measure on the m eigenvalues of M :

$$d\hat{\nu}_M(x) = \text{The symmetrized joint density of the eigenvalues.}$$

Given the densities for M and M' , the question arises: What kind of summation of densities might represent the density for $M + M'$? This question is unanswerable without further information.

One might try to answer this using various assumptions based on probability theory. The first assumption is the familiar “classical” probability theory where

the distribution of the sum is obtained by convolution of the density of summands. Another assumption is the modern “free” probability theory; we introduce a finite version to obtain the “isotropic” theory. Our target problem of interest, the “quantum” problem, we will demonstrate, practically falls nicely in between the two. The “Slider” quantifies to what extent the quantum problem falls in between (Figure 2.2.1 bottom).

2.3.1 Classical

Consider random diagonal matrices A and B of size m , the only randomness is in a uniform choice among the $m!$ possible orders. Then there is no difference between the density of eigenvalue sums and the familiar convolution of densities of random variables,

$$d\nu^c = d\nu_A * d\nu_B. \quad (2.3.3)$$

Comment: From this point of view, the diagonal elements of A , say, are identically distributed random variables that need not be independent. Consider Wishart matrices [52], where there are dependencies among the eigenvalues. To be precise let $\mathbf{a} \in \mathbb{R}^m$ be a symmetric random variable, i.e., $P\mathbf{a}$ has the same distribution as \mathbf{a} for all permutation matrices P . We write, $A = \begin{pmatrix} a_1 & & \\ & \ddots & \\ & & a_m \end{pmatrix} \equiv \text{diag}(\mathbf{a})$. Similarly for B .

Comment: The classical convolution appears in Figure 2.2.1 in two different ways. Firstly, in the definition of A (or B), the eigenvalues of the odd (or even) terms are added classically. Secondly, A and B are added classically to form one end of the Slider.

2.3.2 Free and Isotropic

Free probability [48, is recommended] provides a new natural mathematical “sum” of random variables. This sum is computed “free convolution” denoted

$$d\nu^f = d\nu_A \boxplus d\nu_B. \quad (2.3.4)$$

Here we assume the random matrices A and B , representing the eigenvalues, have densities $d\nu_A$ and $d\nu_B$. In the large m limit, we can compute the DOS of $A + Q^T B Q$, where Q is a β -Haar distributed matrix (see Table 2.1).

Comment: In this paper we will not explore the free approach strictly other than observing that it is the infinite limit of the isotropic approach (i.e., $t \rightarrow \infty$ in Eq. 2.3.5). This infinite limit is independent of the choice of β (see Table 2.1).

	Real \mathbb{R}	Complex \mathbb{C}	Quaternions \mathbb{H}	“Ghosts”
β	1	2	4	general β
Notation	Q	U	S	Q_β
Haar matrices	orthogonal	unitary	symplectic	β -orthogonal

Table 2.1: Various β -Haar matrices.

We define an isotropic convolution. The isotropic sum depends on a copying parameter t and β (Table 2.1). The new Hamiltonian is the *isotropic Hamiltonian* (“iso”):

$$H_{iso} \equiv (A' \otimes \mathbb{I}_t) + Q_\beta^{-1} (\mathbb{I}_t \otimes B') Q_\beta, \quad (2.3.5)$$

where Q_β is a β -Haar distributed matrix, $A = A' \otimes \mathbb{I}_t$ and $B = \mathbb{I}_t \otimes B'$. For the copying parameter $t = d$, H_{iso} has the same dimension as H in Eq. 2.1.1; however, $t > d$ allows us to formally treat problems of growing size. We can recover the free convolution by taking the limit: $\lim_{t \rightarrow \infty} d\nu^{iso(\beta,t)} = d\nu^f$. The effect of Q_β is to spin the eigenvectors of $\mathbb{I}_t \otimes B$ to point isotropically with respect to the eigenvectors of A . We denote the isotropic eigenvalue distribution by

$$d\nu^{iso(\beta,t)} = d\hat{\nu}_A \boxplus_{iso(\beta,t)} d\hat{\nu}_B \quad (2.3.6)$$

omitting t and β when it is clear from the context.

Comment: In Eq. 2.3.5, the \mathbb{I}_t and B in $\mathbb{I}_t \otimes B$, can appear in any order. We chose this presentation in anticipation of the quantum problem.

Comment: In this paper we primarily consider t to match the dimension of H .

2.3.3 Quantum

Let $d\nu^q$ denote the eigenvalue distribution for the Hamiltonian in Eq. 2.1.1. This is the distribution that we will approximate by $d\nu^{IE}$. In connection to Figure 2.1.1 the Hamiltonian can be written as

$$H \equiv H_{\text{odd}} + H_{\text{even}} = \sum_{l=1,3,5,\dots} \mathbb{I} \otimes H_{l,l+1} \otimes \mathbb{I} + \sum_{l=2,4,6,\dots} \mathbb{I} \otimes H_{l,l+1} \otimes \mathbb{I}. \quad (2.3.7)$$

We proceed to define a “quantum convolution” on the distributions $d\hat{\nu}_A$ and $d\hat{\nu}_B$, which is β -dependent

$$d\nu^{q(\beta)} = d\hat{\nu}_A \boxplus_q d\hat{\nu}_B. \quad (2.3.8)$$

In general, without any connection to a Hamiltonian, let $d\hat{\nu}_A$ and $d\hat{\nu}_B$ be symmetric measures on \mathbb{R}^{d^N} . We define $d\nu^{q(\beta)}$ to be the eigenvalue distribution of

$$H = A + Q_q^{-1} B Q_q, \quad (2.3.9)$$

where $Q_q = \left(Q_q^{(A)}\right)^{-1} Q_q^{(B)}$ with

$$\begin{aligned} Q_q^{(A)} &= \left[\bigotimes_{i=1}^{(N-1)/2} Q_i^{(O)} \right] \otimes \mathbb{I}_d \text{ and } Q_q^{(B)} = \mathbb{I}_d \otimes \left[\bigotimes_{i=1}^{(N-1)/2} Q_i^{(E)} \right] & N \text{ odd} \\ Q_q^{(A)} &= \left[\bigotimes_{i=1}^{N/2} Q_i^{(O)} \right] \text{ and } Q_q^{(B)} = \mathbb{I}_d \otimes \left[\bigotimes_{i=1}^{N/2-1} Q_i^{(E)} \right] \otimes \mathbb{I}_d & N \text{ even} \end{aligned} \quad (2.3.10)$$

and each $Q_i^{(\bullet)}$ is a β -Haar measure orthogonal matrix of size d^2 and \mathbb{I}_d is an identity matrix of size d .

Comment: A , B and Q_q are $d^N \times d^N$.

Comment: In our examples given in this paper, we assume the local terms are independent and identically distributed (iid) random matrices, each of which has eigenvectors distributed with β -Haar measure.

The tensor product in (2.3.10) succinctly summarizes the departure of the quantum case from a generic matrix as well as from the classical case. First of all the number of parameters in Q_q grows linearly with N whereas in Q it grows exponentially with N . Second, the quantum case possesses isotropicity that makes it different from the classical, whose eigenvectors are a point on the orthogonal group (i.e., the identity matrix).

Comment: General β 's can be treated formally [53]. In particular, for quantum mechanical problems β is taken to be 1 or 2 corresponding to real and complex entries in the local terms. $\beta = 4$ corresponds to quaternions.

Definition. The **Hadamard product** of two matrices M_1 and M_2 of the same size, denoted by $M_1 \circ M_2$, is the product of the corresponding elements.

Lemma 1. *The elements of Q_q defined in Eq. 2.3.10 are (dependent) random variables with mean zero and variance d^{-N} .*

Proof. Here expectations are taken with respect to the random matrix Q_q which is built from local Haar measure matrices by Eq. 2.3.10. The fact that $\mathbb{E}\left(Q_q^{(A)}\right) = \mathbb{E}\left(Q_q^{(B)}\right) = 0_{d^N}$ follows from the Haar distribution of local terms. Thus $\mathbb{E}(Q_q) = 0$ by independence of $Q_q^{(A)}$ and $Q_q^{(B)}$. Further, each element in Q_q involves a dot product between columns of $Q_q^{(A)}$ and $Q_q^{(B)}$. In every given column of $Q_q^{(A)}$ any nonzero entry is a distinct product of entries of local Q 's (see Eq.2.3.10). For example the expectation value of the 1,1 entry is $\mathbb{E}\left(q_{i,1}^{(A)} q_{j,1}^{(A)} q_{i,1}^{(B)} q_{j,1}^{(B)}\right) = \mathbb{E}\left(q_{i,1}^{(A)} q_{j,1}^{(A)}\right) \mathbb{E}\left(q_{i,1}^{(B)} q_{j,1}^{(B)}\right)$. Because of the Haar measure of the local terms, this expectation is zero unless $i = j$. We then have that

$$\begin{aligned}
\mathbb{E}(Q_q \circ Q_q) &= \mathbb{E}\left(Q_q^{(A)} \circ Q_q^{(A)}\right)^T \mathbb{E}\left(Q_q^{(B)} \circ Q_q^{(B)}\right) = \\
\left\{ \begin{array}{ll} \left(\left[\bigotimes_{i=1}^{(N-1)/2} d^{-2} J_{d^2} \right] \otimes \mathbb{I}_d \right) \left(\mathbb{I}_d \otimes \left[\bigotimes_{i=1}^{(N-1)/2} d^{-2} J_{d^2} \right] \right) & N \text{ odd} \\ \left(\bigotimes_{i=1}^{N/2} d^{-2} J_{d^2} \right) \left(\mathbb{I}_d \otimes \left[\bigotimes_{i=1}^{N/2-1} d^{-2} J_{d^2} \right] \otimes \mathbb{I}_d \right) & N \text{ even} \end{array} \right. & (2.3.11) \\
&= d^{-N} J_{d^N},
\end{aligned}$$

where $J_i = i \times i$ matrix of all ones. We use facts such as $(J_i/i)^2 = (J_i/i)$, $(J_i/i) \otimes (J_i/i) = (J_{i^2}/i^2)$ and the variance of the elements of an $i \times i$ β -Haar matrix is $1/i$. \square

2.4 Theory of Isotropic Entanglement

2.4.1 Isotropic Entanglement as the Combination of Classical and Isotropic

We create a ‘‘Slider’’ based on the fourth moment. The moment m_k of a random variable defined in terms of its density is $m_k = \int x^k d\nu_M$. For the eigenvalues of an $m \times m$ random matrix, this is $\frac{1}{m} \mathbb{E} \text{Tr} M^k$. In general, the moments of the classical sum and the free sum are different, but the first three moments, m_1 , m_2 , and m_3 are theoretically equal [48, p. 191]. Further, to anticipate our target problem, the first three moments of the quantum eigenvalues are also equal to that of the iso and the classical (The Departure and the Three Moments Matching theorems in Section 2.4.2). These moments are usually encoded as the mean, variance, and skewness.

We propose to use the fourth moment (or the excess kurtosis) to choose a correct p from a sliding hybrid sum:

$$d\nu^q \approx d\nu^{IE} = p d\nu^c + (1 - p) d\nu^{iso} \quad (2.4.1)$$

Therefore, we find p that expresses the kurtosis of the quantum sum (γ_2^q) in terms of the kurtoses of the classical (γ_2^c) and isotropic (γ_2^{iso}) sums:

$$\gamma_2^q = p\gamma_2^c + (1-p)\gamma_2^{iso} \Rightarrow p = \frac{\gamma_2^q - \gamma_2^{iso}}{\gamma_2^c - \gamma_2^{iso}}. \quad (2.4.2)$$

Recall that the kurtosis $\gamma_2 \equiv \frac{m_4}{\sigma^4}$, where σ^2 is the variance. Hence kurtosis is the correct statistical quantity that encodes the fourth moments:

$$m_4^c = \frac{1}{d^N} \mathbb{E} \text{Tr} (A + \Pi^T B \Pi)^4, \quad m_4^{iso} = \frac{1}{d^N} \mathbb{E} \text{Tr} (A + Q^T B Q)^4, \quad m_4^q = \frac{1}{d^N} \mathbb{E} \text{Tr} (A + Q_q^T B Q_q)^4, \quad (2.4.3)$$

where Π is a random uniformly distributed permutation matrix, Q is a β -Haar measure orthogonal matrix of size d^N , and Q_q is given by Eq. 2.3.10. *Unless stated otherwise, in the following the expectation values are taken with respect to random eigenvalues A and B and eigenvectors. The expectation values over the eigenvectors are taken with respect to random permutation Π , β -Haar Q or Q_q matrices for classical, isotropic or quantum cases respectively.*

2.4.2 The Departure and The Matching Three Moments Theorems

In general we have the i^{th} moments:

$$\begin{aligned} m_i^{iso} &= \frac{1}{m} \mathbb{E} \text{Tr} (A + Q^T B Q)^i \\ m_i^q &= \frac{1}{m} \mathbb{E} \text{Tr} (A + Q_q^T B Q_q)^i, \text{ and} \\ m_i^c &= \frac{1}{m} \mathbb{E} \text{Tr} (A + \Pi^T B \Pi)^i. \end{aligned}$$

where $m \equiv d^N$. If we expand the moments above we find some terms can be put in the form $\mathbb{E} \text{Tr} (A^{m_1} Q_{\bullet}^T B^{m_2} Q_{\bullet})$ and the remaining terms can be put in the form $\mathbb{E} \text{Tr} \{ \dots Q_{\bullet}^T B^{\geq 1} Q_{\bullet} A^{\geq 1} Q_{\bullet}^T B^{\geq 1} Q_{\bullet} \dots \}$. The former terms we denote *non-departing*; the remaining terms we denote *departing*.

For example, when $i = 4$,

$$\begin{aligned}
m_4^{iso} &= \frac{1}{m} \mathbb{E} \left\{ \text{Tr} \left[A^4 + 4A^3 Q^T B Q + 4A^2 Q^T B^2 Q + 4A Q^T B^3 Q + \underline{\mathbf{2 (A Q^T B Q)^2}} + B^4 \right] \right\} \quad (2.4.4) \\
m_4^q &= \frac{1}{m} \mathbb{E} \left\{ \text{Tr} \left[A^4 + 4A^3 Q_q^T B Q_q + 4A^2 Q_q^T B^2 Q_q + 4A Q_q^T B^3 Q_q + \underline{\mathbf{2 (A Q_q^T B Q_q)^2}} + B^4 \right] \right\} \\
m_4^c &= \frac{1}{m} \mathbb{E} \left\{ \text{Tr} \left[A^4 + 4A^3 \Pi^T B \Pi + 4A^2 \Pi^T B^2 \Pi + 4A \Pi^T B^3 \Pi + \underline{\mathbf{2 (A \Pi^T B \Pi)^2}} + B^4 \right] \right\},
\end{aligned}$$

where the only departing terms and the corresponding classical term are shown as underlined and bold faced.

Theorem. (The Departure Theorem) *The moments of the quantum, isotropic and classical sums differ only in the departing terms: $\mathbb{E} \text{Tr} \{ \dots Q_{\bullet}^T B^{\geq 1} Q_{\bullet} A^{\geq 1} Q_{\bullet}^T B^{\geq 1} Q_{\bullet} \dots \}$.*

Proof. Below the repeated indices are summed over. If A and B are any diagonal matrices, and Q_{\bullet} is Q or Q_q or Π of size $m \times m$ then $\mathbb{E} (q_{ij}^2) = 1/m$, by symmetry and by Lemma 1 respectively. Since the $\mathbb{E} \text{Tr} (A Q_{\bullet}^T B Q_{\bullet}) = \mathbb{E} (q_{ij}^2 a_i b_j)$, where expectation is taken over randomly ordered eigenvalues and eigenvectors; the expected value is $m^2 \left(\frac{1}{m}\right) \mathbb{E} (a_i b_j)$ for any i or j . Hence, $\frac{1}{m} \mathbb{E} \text{Tr} (A Q_{\bullet}^T B Q_{\bullet}) = \mathbb{E} (a_i b_j) = \mathbb{E} (a_i) \mathbb{E} (b_j)$, which is equal to the classical value. The first equality is implied by permutation invariance of entries in A and B and the second equality follows from the independence of A and B .

□

Therefore, the three cases differ only in the terms $\frac{2}{m} \mathbb{E} \text{Tr} (A Q^T B Q)^2$, $\frac{2}{m} \mathbb{E} \text{Tr} (A Q_q^T B Q_q)^2$ and $\frac{2}{m} \mathbb{E} \text{Tr} (A \Pi^T B \Pi)^2$ in Eq. 2.4.4.

Theorem. (The Matching Three Moments Theorem) *The first three moments of the quantum, iso and classical sums are equal.*

number of sites	number of odds or evens (N odd)	number of odds or evens (N even)	size of H	Number of copies	Dimension of quidits
N	$k = \frac{N-1}{2}$	$k_{\text{odd}} = \frac{N}{2}, k_{\text{even}} = \frac{N-2}{2}$	$m = d^N$	t	d

size of local terms	l^{th} moment	l^{th} cumulant	mean	variance	skewness	kurtosis
$n = d^2$	m_l	κ_l	μ	σ^2	γ_1	γ_2

Table 2.2: Notation

Proof. The first three moments are

$$\begin{aligned}
m_1^{(\bullet)} &= \frac{1}{m} \mathbb{E} \text{Tr} (A + B) \\
m_2^{(\bullet)} &= \frac{1}{m} \mathbb{E} \text{Tr} (A + Q_{\bullet}^T B Q_{\bullet})^2 = \frac{1}{m} \mathbb{E} \text{Tr} (A^2 + 2A Q_{\bullet}^T B Q_{\bullet} + B^2) \\
m_3^{(\bullet)} &= \frac{1}{m} \mathbb{E} \text{Tr} (A + Q_{\bullet}^T B Q_{\bullet})^3 = \frac{1}{m} \mathbb{E} \text{Tr} (A^3 + 3A^2 Q_{\bullet}^T B Q_{\bullet} + 3A Q_{\bullet}^T B^2 Q_{\bullet} + B^3),
\end{aligned} \tag{2.4.5}$$

where Q_{\bullet} is Q and Q_q for the iso and the quantum sums respectively and we used the familiar trace property $\text{Tr}(M_1 M_2) = \text{Tr}(M_2 M_1)$. The equality of the first three moments of the iso and quantum with the classical follows from The Departure Theorem. □

Furthermore, in the expansion of any of the moments > 4 all the non-departing terms are exactly captured by IE. These terms are equal to the corresponding terms in the classical and the isotropic and therefore equal to any linear combination of them. The departing terms in higher moments (i.e., > 4) that are approximated by IE, we conjecture are of little relevance. For example, the fifth moment has only two terms (shown in bold) in its expansion that are departing:

$$\begin{aligned}
m_5 &= \frac{1}{m} \mathbb{E} \text{Tr} \left(A^5 + 5A^4 Q_{\bullet}^T B Q_{\bullet} + 5A^3 Q_{\bullet}^T B^2 Q_{\bullet} + 5A^2 Q_{\bullet}^T B^3 Q_{\bullet} + \mathbf{5A (AQ_{\bullet}^T B Q_{\bullet})^2} + \right. \\
&\quad \left. \mathbf{5 (AQ_{\bullet}^T B Q_{\bullet})^2 Q_{\bullet}^T B Q_{\bullet}} + 5A Q_{\bullet}^T B^4 Q_{\bullet} + B^5 \right)
\end{aligned} \tag{2.4.6}$$

By the Departure Theorem the numerator in Eq. 2.4.2 becomes,

$$\gamma_2^q - \gamma_2^{iso} = \frac{\kappa_4^q - \kappa_4^{iso}}{\sigma^4} = \frac{2}{m} \frac{\mathbb{E} \left\{ \text{Tr} \left[(AQ_q^T BQ_q)^2 - (AQ^T BQ)^2 \right] \right\}}{\sigma^4} \quad (2.4.7)$$

and the denominator in Eq. 2.4.2 becomes,

$$\gamma_2^c - \gamma_2^{iso} = \frac{\kappa_4^c - \kappa_4^{iso}}{\sigma^4} = \frac{2}{m} \frac{\mathbb{E} \left\{ \text{Tr} \left[(A\Pi^T B\Pi)^2 - (AQ^T BQ)^2 \right] \right\}}{\sigma^4}, \quad (2.4.8)$$

where as before, Q is a β -Haar measure orthogonal matrix of size $m = d^N$, $Q_q = \left(Q_q^{(A)} \right)^T Q_q^{(B)}$ given by Eq. 2.3.10 and κ_4^\bullet denote the fourth cumulants. Therefore, evaluation of p reduces to the evaluation of the right hand sides of Eqs. 2.4.7 and 2.4.8.

Below we do not want to restrict ourselves to only chains with odd number of sites and we need to take into account the multiplicity of the eigenvalues as a result of taking the tensor product with identity. It is convenient to denote the size of the matrices involved by $m = d^N = tn^k$, where $n = d^2$ and $k = \frac{N-1}{2}$ and t is the number of copies (Section 2.3.2 and Table 2.2).

2.4.3 Distribution of A and B

The goal of this section is to express the moments of the entries of A and B (e.g., m_2^A and $m_{1,1}^A$) in terms of the moments of the local terms (e.g for odd local terms $m_2^{\text{odd}}, m_{11}^{\text{odd}}$). Note that A and B are independent. The odd summands that make up A all commute and therefore can be locally diagonalized to give the diagonal matrix A (similarly for B),

$$\begin{aligned}
A &= \sum_{i=1,3,\dots}^{N-2} \mathbb{I} \otimes \Lambda_i \otimes \mathbb{I} \\
B &= \sum_{i=2,4,\dots}^{N-1} \mathbb{I} \otimes \Lambda_i \otimes \mathbb{I},
\end{aligned} \tag{2.4.9}$$

where Λ_i are of size d^2 and are the diagonal matrices of the local eigenvalues.

The diagonal matrices A and B are formed by a direct sum of the local eigenvalues of odds and evens respectively. For open boundary conditions (OBC) each entry has a multiplicity given by Table 2.3.

OBC	N odd	N even
A	d	1
B	d	d^2

Table 2.3: The multiplicity of terms in A and B for OBC. For closed boundary conditions there is no repetition.

Comment: We emphasize that A and B are independent of the eigenvector structures. In particular, A and B are the same among the three cases of isotropic, quantum and classical.

We calculate the moments of A and B . Let us treat the second moment of A (B is done the same way). By the permutation invariance of entries in A

$$\begin{aligned}
m_2^A \equiv \mathbb{E}(a_1^2) &= \mathbb{E} \left(\lambda_{i_1}^{(1)} + \dots + \lambda_{i_k}^{(k)} \right)^2 \\
&= \mathbb{E} [k(\lambda^2) + k(k-1)\lambda^{(1)}\lambda^{(2)}] \\
&= km_2^{\text{odd}} + k(k-1)m_{1,1}^{\text{odd}}
\end{aligned} \tag{2.4.10}$$

where expectation is taken over randomly chosen local eigenvalues, $m_2^{\text{odd}} \equiv \mathbb{E}(\lambda_i^2)$ and $m_{1,1}^{\text{odd}} \equiv \mathbb{E}(\lambda_i\lambda_j)$ for some uniformly chosen i and j with $i \neq j$. The permutation

invariance assumption implies $\mathbb{E}(a_i^2) = \mathbb{E}(a_1^2)$ for all $i = 1 \cdots m$.

Comment: The key to this argument giving m_2^A is that the indices are not sensitive to the copying that results from the tensor product with \mathbb{I}_d at the boundaries.

Next we calculate the correlation between two diagonal terms, namely $m_{1,1}^A \equiv \mathbb{E}(a_i a_j)$ for $i \neq j$. We need to incorporate the multiplicity, denoted by t , due to the tensor product with an identity matrix at the end of the chain,

$$\begin{aligned} m_{1,1}^A &= \frac{1}{m(m-1)} \mathbb{E} \left\{ \left(\sum_{i_1, \dots, i_k=1}^n \lambda_{i_1}^{(1)} + \dots + \lambda_{i_k}^{(k)} \right)^2 - \sum_{i_1, \dots, i_k=1}^n \left(\lambda_{i_1}^{(1)} + \dots + \lambda_{i_k}^{(k)} \right)^2 \right\} \\ &= k(k-1) \mathbb{E}(\lambda)^2 + k \{ \text{prob}(\lambda^2) \mathbb{E}(\lambda^2) + \text{prob}(\lambda_1 \lambda_2) \mathbb{E}(\lambda_1 \lambda_2) \} \\ &= k(k-1) m_2^{\text{odd}} + \frac{k}{m-1} \{ (tn^{k-1} - 1) m_2^{\text{odd}} + (tn^{k-1}(n-1)) m_{1,1}^{\text{odd}} \} \end{aligned}$$

where, $\text{prob}(\lambda^2) = \frac{tn^{k-1}-1}{m-1}$ and $\text{prob}(\lambda_1 \lambda_2) = \frac{tn^{k-1}(n-1)}{m-1}$. Similarly for B .

2.4.4 Evaluation and Universality of $p = \frac{\gamma_2^q - \gamma_2^{iso}}{\gamma_2^c - \gamma_2^{iso}}$

Recall the definition of p ; from Eqs. 2.4.2, 2.4.7 and 2.4.8 we have,

$$1 - p = \frac{\mathbb{E} \text{Tr} (A \Pi^T B \Pi)^2 - \mathbb{E} \text{Tr} (A Q_q^T B Q_q)^2}{\mathbb{E} \text{Tr} (A \Pi^T B \Pi)^2 - \mathbb{E} \text{Tr} (A Q_q^T B Q_q)^2}. \quad (2.4.12)$$

The classical case

$$\frac{1}{m} \mathbb{E} \text{Tr} (A \Pi^T B \Pi)^2 = \frac{1}{m} \mathbb{E} \sum_{i=1}^m a_i^2 b_i^2 = \mathbb{E}(a_i^2) \mathbb{E}(b_i^2) = m_2^A m_2^B. \quad (2.4.13)$$

Comment: Strictly speaking after the first equality we must have used b_{π_i} instead of b_i but we simplified the notation as they are the same in an expectation sense.

The general form for the denominator of Eq. 2.4.12 is

$$\frac{1}{m} \mathbb{E} \text{Tr} \left[(A \Pi^T B \Pi)^2 - (A Q_q^T B Q_q)^2 \right] = \frac{1}{m} \mathbb{E} \{ a_i^2 b_i^2 - a_i a_k b_j b_p (q_{ji} q_{jk} q_{pk} q_{pi}) \}. \quad (2.4.14)$$

moments	expectation values	count
m_2^2	$\mathbb{E}(q_{i,j} ^4) = \frac{\beta+2}{m(m\beta+2)}$	m^2
$m_2 m_{11}$	$\mathbb{E}(q_{1,1} q_{1,2} ^2) = \frac{\beta}{m(m\beta+2)}$	$2m^2(m-1)$
$(m_{11})^2$	$\mathbb{E}(q_{1,1} \overline{q_{1,2}} q_{2,1} q_{2,2}) = -\frac{\beta}{m(m\beta+2)(m-1)}$	$m^2(m-1)^2$
	$\mathbb{E}(q_{13}^2 q_{24}^2) = \frac{\beta(n-1)+2}{n(n\beta+2)(n-1)}$	

Table 2.4: The expectation values and counts of colliding terms in Q when it is β -Haar distributed. In this section we use the first row; we include the last three rows for the calculations in the appendix.

It's worth noting that the arguments leading to Eq. 2.4.18 hold even if one fixes A and B and takes expectation values over Π and a permutation invariant Q whose entries have the same expectation value. The right hand side of Eq. 2.4.18 is a homogeneous polynomial of order two in the entries of A and B ; consequently it necessarily has the form

$$\frac{1}{m} \mathbb{E} \text{Tr} \left[(A \Pi^T B \Pi)^2 - (A Q^T B Q)^2 \right] = c_1(B, Q) m_2^A + c_2(B, Q) m_{1,1}^A$$

but Eq. 2.4.14 must be zero for $A = I$, for which $m_2^A = m_{1,1}^A = 1$. This implies that $c_1 = -c_2$, allowing us to factor out $(m_2^A - m_{1,1}^A)$. Similarly, the homogeneity and permutation invariance of B implies,

$$\frac{1}{m} \mathbb{E} \text{Tr} \left[(A \Pi^T B \Pi)^2 - (A Q^T B Q)^2 \right] = (m_2^A - m_{1,1}^A) (D_1(Q) m_2^B + D_2(Q) m_{1,1}^B).$$

The right hand side should be zero for $B = I$, whereby we can factor out $(m_2^B - m_{1,1}^B)$

$$\frac{1}{m} \mathbb{E} \text{Tr} \left[(A \Pi^T B \Pi)^2 - (A Q^T B Q)^2 \right] = (m_2^A - m_{1,1}^A) (m_2^B - m_{1,1}^B) f(Q), \quad (2.4.15)$$

where $m_2^A = \mathbb{E}(a_i^2)$, $m_2^B = \mathbb{E}(b_j^2)$, and $m_{1,1}^A = \mathbb{E}(a_i, a_j)$, $m_{1,1}^B = \mathbb{E}(b_i, b_j)$. Moreover $f(Q)$ is a homogeneous function of order four in the entries of Q . To evaluate $f(Q)$, it suffices to let A and B be projectors of rank one where A would have only one

nonzero entry on the i^{th} position on its diagonal and B only one nonzero entry on the j^{th} position on its diagonal. Further take those nonzero entries to be ones, giving $m_{1,1}^A = m_{1,1}^B = 0$ and $m_2^A = m_2^B = 1/m$,

$$\frac{1}{m} \mathbb{E} \text{Tr} \left[(A\Pi^T B\Pi)^2 - (AQ^T BQ)^2 \right] = \frac{1}{m^2} f(Q) \quad (2.4.16)$$

But the left hand side is

$$\begin{aligned} \frac{1}{m} \mathbb{E} \text{Tr} \left[(A\Pi^T B\Pi)^2 - (AQ^T BQ)^2 \right] &= \frac{1}{m} \mathbb{E} [\delta_{ij} - q_{ij}^A] \\ &= \frac{1}{m} \left\{ \frac{1}{m^2} \sum_{ij} \delta_{ij} - \frac{1}{m^2} \sum_{ij} \mathbb{E} (q_{ij}^A) \right\} \\ &= \frac{1}{m} \left\{ \frac{1}{m} - \mathbb{E} (q_{ij}^A) \right\}, \end{aligned}$$

where, we used the homogeneity of Q . Consequently, by equating this to $f(Q)/m^2$, we get the desired quantity $f(Q) = \{1 - m\mathbb{E}(q_{ij}^A)\}$.

Our final result Eq. 2.4.15 now reads

$$\frac{1}{m} \mathbb{E} \text{Tr} \left[(A\Pi^T B\Pi)^2 - (AQ^T BQ)^2 \right] = (m_2^A - m_{1,1}^A) (m_2^B - m_{1,1}^B) \{1 - m\mathbb{E}(q_{ij}^A)\}. \quad (2.4.17)$$

The same calculation where each of the terms is obtained separately yields the same result (Appendix). In this paper p is formed by taking Q to have a β -Haar measure. Expectation values of the entries of Q are listed in the Table 2.4.

We wish to express everything in terms of the local terms; using Eqs. 2.4.10 and 2.4.11 as well as $tn^k = m$,

$$\begin{aligned} m_2^A - m_{1,1}^A &= \frac{tk(n-1)n^{k-1}}{m-1} (m_2^{\text{odd}} - m_{1,1}^{\text{odd}}) \\ m_2^B - m_{1,1}^B &= \frac{tk(n-1)n^{k-1}}{m-1} (m_2^{\text{even}} - m_{1,1}^{\text{even}}), \end{aligned}$$

giving

$$\frac{1}{m} \mathbb{E} \left[\text{Tr} (A \Pi^T B \Pi)^2 - \text{Tr} (A Q^T B Q)^2 \right] = \left(m_2^{\text{odd}} - m_{1,1}^{\text{odd}} \right) \left(m_2^{\text{even}} - m_{1,1}^{\text{even}} \right) \times \left(\frac{km(n-1)}{n(m-1)} \right)^2 \{1 - m \mathbb{E} (q_{ij}^4)\} \quad (2.4.18)$$

We now proceed to the quantum case where we need to evaluate

$$\frac{1}{m} \mathbb{E} \left[(A \Pi^T B \Pi)^2 - \text{Tr} (A Q_q^T B Q_q)^2 \right].$$

In this case, we cannot directly use the techniques that we used to get Eq. 2.4.18 because Q_q is not permutation invariant despite local eigenvectors being so. Before proceeding further we like to prove a useful lemma (Lemma 2). Let us simplify the notation and denote the local terms that are drawn randomly from a known distribution by $H_{l,l+1} \equiv H^{(l)}$ whose eigenvalues are Λ_l as discussed above.

Recall that A represents the *sum* of all the odds and $Q_q^{-1} B Q_q$ the *sum* of all the evens,

$$H_{\text{odd}} = \sum_{l=1,3,5,\dots} \mathbb{I} \otimes H^{(l)} \otimes \mathbb{I}, \text{ and } H_{\text{even}} = \sum_{l=2,4,6,\dots} \mathbb{I} \otimes H^{(l)} \otimes \mathbb{I},$$

Hence, the expansion of $\frac{1}{m} \mathbb{E} \left[\text{Tr} (A Q_q^T B Q_q)^2 \right]$ amounts to picking an odd term, an even term, then another odd term and another even term, multiplying them together and taking the expectation value of the trace of the product (Figure 2.4.1). Therefore, each term in the expansion can have four, three or two different local terms, whose expectation values along with their counts are needed. These expectations are taken with respect to the local terms (dense $d^2 \times d^2$ random matrices).

The expectation values depend on the type of random matrix distribution from which the local terms are drawn. The counting however, depends on the configuration of the lattice only. We show the counting of the number of terms, taking care of the

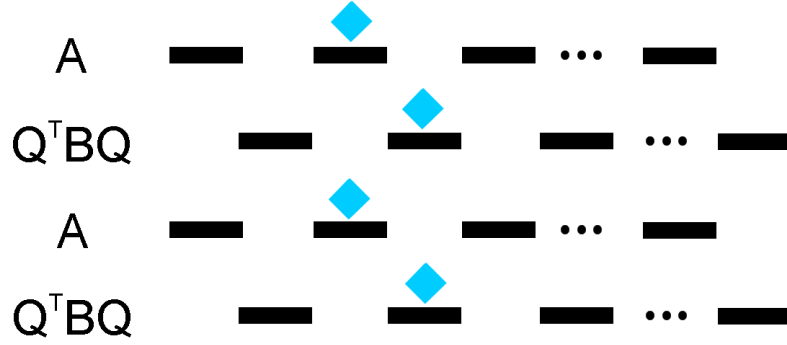

Figure 2.4.1: The terms in the expansion of $\frac{1}{m} \mathbb{E} \left[\text{Tr} \left(A Q_q^T B Q_q \right)^2 \right]$ can be visualized as picking an element from each row from top to bottom and multiplying. Each row has k of the local terms corresponding to a chain with odd number of terms. Among k^4 terms roughly k^2 of them differ among the classical, isotropic and quantum cases (See Eqs. 2.4.19 and 2.4.20). An example of such a choice is shown by diamonds.

boundary terms for an open chain, along with the type of expectation values by which they need to be weighted:

For N odd (k odd terms and k even terms)

$$\begin{aligned}
 \text{Four } H^{(\cdot)}\text{'s} : k^2 (k-1)^2 &\Rightarrow d^{N-u_1} \mathbb{E} \text{Tr} \left(H^{(l)} \right)^4, \quad u_1 \in \{5, \dots, 8\} \\
 \text{Three } H^{(\cdot)}\text{'s} : 2k^2 (k-1) &\Rightarrow d^{N-u_2} \mathbb{E} \text{Tr} \left([H^{(l)}]^2 \right) \mathbb{E} \text{Tr} \left(H^{(l)} \right)^2, \quad u_2 \in \{4, 5, 6\} \\
 \text{Two } H^{(\cdot)}\text{'s} : (k-1)^2 \text{ Not Entangled} &\Rightarrow d^{N-4} \left\{ \mathbb{E} \text{Tr} \left([H^{(l)}]^2 \right) \right\}^2 \\
 \text{Two } H^{(\cdot)}\text{'s} : (2k-1) \text{ Entangled} &\Rightarrow d^{N-3} \mathbb{E} \text{Tr} \left[\left(H^{(l)} \otimes \mathbb{I} \right) \left(\mathbb{I} \otimes H^{(l+1)} \right) \left(H^{(l)} \otimes \mathbb{I} \right) \left(\mathbb{I} \otimes H^{(l+1)} \right) \right]
 \end{aligned}
 \tag{2.4.19}$$

For N even (k odd terms and $k-1$ even terms)

$$\begin{aligned}
& \text{Four } H^{(\cdot)}\text{'s} : k(k-1)^2(k-2) \Rightarrow d^{N-u_1} \mathbb{E} \text{Tr} (H^{(l)})^4, \quad u_1 \in \{5, \dots, 8\} \\
& \text{Three } H^{(\cdot)}\text{'s} : k(k-1)(2k-3) \Rightarrow d^{N-u_2} \mathbb{E} \text{Tr} \left([H^{(l)}]^2 \right) \mathbb{E} \text{Tr} (H^{(l)})^2, \quad u_2 \in \{4, 5, 6\} \\
& \text{Two } H^{(\cdot)}\text{'s} : (k-1)(k-2) \text{ Not Entangled} \Rightarrow d^{N-4} \left\{ \mathbb{E} \text{Tr} \left([H^{(l)}]^2 \right) \right\}^2 \\
& \text{Two } H^{(\cdot)}\text{'s} : 2(k-1) \text{ Entangled} \Rightarrow d^{N-3} \mathbb{E} \text{Tr} \left[(H^{(l)} \otimes \mathbb{I}) (\mathbb{I} \otimes H^{(l+1)}) (H^{(l)} \otimes \mathbb{I}) (\mathbb{I} \otimes H^{(l+1)}) \right]
\end{aligned} \tag{2.4.20}$$

Here u_1 and u_2 indicate the number of sites that the local terms act on (i.e., occupy). Therefore, $\frac{1}{m} \mathbb{E} \left[\text{Tr} (A Q_q^T B Q_q)^2 \right]$ is obtained by multiplying each type of terms, weighted by the counts and summing. For example for $u_1 = 5$ and $u_2 = 3$, when N is odd,

$$\begin{aligned}
\frac{1}{m} \mathbb{E} \left[\text{Tr} (A Q_q^T B Q_q)^2 \right] &= \frac{1}{m} \left\{ d^{N-5} k^2 (k-1)^2 \mathbb{E} \text{Tr} (H^{(l)})^4 + \right. \\
& 2k^2 (k-1) d^{N-4} \mathbb{E} \text{Tr} \left([H^{(l)}]^2 \right) \mathbb{E} \text{Tr} (H^{(l)})^2 + (k-1)^2 d^{N-4} \left\{ \mathbb{E} \text{Tr} \left([H^{(l)}]^2 \right) \right\}^2 + \\
& \left. (2k-1) d^{N-3} \mathbb{E} \text{Tr} \left[(H^{(l)} \otimes \mathbb{I}) (\mathbb{I} \otimes H^{(l+1)}) (H^{(l)} \otimes \mathbb{I}) (\mathbb{I} \otimes H^{(l+1)}) \right] \right\}
\end{aligned} \tag{2.4.21}$$

and similarly for N even,

$$\begin{aligned}
\frac{1}{m} \mathbb{E} \left[\text{Tr} (A Q_q^T B Q_q)^2 \right] &= \frac{(k-1)}{m} \left\{ k(k-1)(k-2) d^{N-5} \mathbb{E} \text{Tr} (H^{(l)})^4 + \right. \\
& k(2k-3) d^{N-4} \mathbb{E} \text{Tr} \left([H^{(l)}]^2 \right) \mathbb{E} \text{Tr} (H^{(l)})^2 + (k-2) d^{N-4} \left\{ \mathbb{E} \text{Tr} \left([H^{(l)}]^2 \right) \right\}^2 + \\
& \left. 2d^{N-3} \mathbb{E} \text{Tr} \left[(H^{(l)} \otimes \mathbb{I}) (\mathbb{I} \otimes H^{(l+1)}) (H^{(l)} \otimes \mathbb{I}) (\mathbb{I} \otimes H^{(l+1)}) \right] \right\}.
\end{aligned} \tag{2.4.22}$$

The expectation values depend on the type of random matrix distribution from which the local terms are drawn. We will give explicit examples in the following sections. In the following lemma, we use $\mathbb{E} (H^{(l)}) = \mu \mathbb{I}_{d^2}$ and $\mathbb{E} (H^{(l)})^2 = m_2 \mathbb{I}_{d^2}$.

Lemma 2. *In calculating the $\mathbb{E} \text{Tr} (A Q_q^T B Q_q)^2$ if at least one of the odds (evens) commutes with one of the evens (odds) then the expectation value is the same as the classical expectation value. Further if the local terms have permutation invariance of*

eigenvalues then the only quantum expectation value that differs from classical is of Type II (see the proof and the diamonds in figure 2.4.1).

Proof. This can be shown using the trace property $\text{Tr}(MP) = \text{Tr}(PM)$. In calculating $\mathbb{E}\text{Tr}(H_l^{\text{odd}} H_p^{\text{even}} H_j^{\text{odd}} H_k^{\text{even}})$; if any of the odd (even) terms commutes with any of the even (odd) terms to its left or right then they can be swapped. For example one gets $\mathbb{E}\text{Tr}(H_l^{\text{odd}} H_p^{\text{even}} H_k^{\text{even}} H_j^{\text{odd}}) = \mathbb{E}\text{Tr}(H_j^{\text{odd}} H_l^{\text{odd}} H_p^{\text{even}} H_k^{\text{even}})$ which is just the classical value. Hence the only types of expectations that we need to worry about are

$$\begin{array}{ccc}
 \begin{array}{c} H^{(l)} \\ \text{--} \\ H^{(l+1)} \\ \text{--} \\ H^{(l)} \\ \text{--} \\ H^{(l-1)} \\ \text{--} \\ \text{Type I} \end{array} & \text{and} & \begin{array}{c} H^{(l)} \\ \text{--} \\ H^{(l+1)} \\ \text{--} \\ H^{(l)} \\ \text{--} \\ H^{(l+1)} \\ \text{--} \\ \text{Type II} \end{array}
 \end{array}$$

now we show that with permutation invariance of the local eigenvalues the first type are also classical leaving us with the ‘‘diamond terms’’ alone (Fig. 2.4.1). Consider a Type I term, which involves three independent local terms,

$$\begin{aligned}
 & \frac{1}{m} \mathbb{E}\text{Tr}[(\mathbb{I}_{d^2} \otimes H^{(3)} \otimes \mathbb{I}_{d^{N-4}})(\mathbb{I} \otimes H^{(2)} \otimes \mathbb{I}_{d^{N-3}})(\mathbb{I}_{d^2} \otimes H^{(3)} \otimes \mathbb{I}_{d^{N-4}})(\mathbb{I}_{d^3} \otimes H^{(4)} \otimes \mathbb{I}_{d^{N-5}})] \\
 & = \mu^2 m_2.
 \end{aligned}$$

This follows immediately from the independence of $H^{(4)}$, which allows us to take its expectation value separately giving a μ and leaving us with

$$\frac{\mu}{m} \mathbb{E}\text{Tr} \left[(\mathbb{I}_{d^2} \otimes H^{(3)} \otimes \mathbb{I}_{d^{N-4}})^2 (\mathbb{I} \otimes H^{(2)} \otimes \mathbb{I}_{d^{N-3}}) \right] = \mu^2 m_2.$$

Therefore the only relevant terms, shown by diamonds in Fig. 2.4.1, are of Type II. As an example of such terms consider (here on repeated indices are summed over)

$$\begin{aligned}
& \frac{1}{m} \mathbb{E} \text{Tr} \left[\left(H^{(1)} \otimes \mathbb{I}_{d^{N-2}} \right) \left(\mathbb{I} \otimes H^{(2)} \otimes \mathbb{I}_{d^{N-3}} \right) \left(H^{(1)} \otimes \mathbb{I}_{d^{N-2}} \right) \left(\mathbb{I} \otimes H^{(2)} \otimes \mathbb{I}_{d^{N-3}} \right) \right] \\
&= \frac{1}{d^3} \left\{ \mathbb{E} \left(H_{i_1 i_2, j_1 j_2}^{(1)} H_{i_1 p_2, j_1 k_2}^{(1)} \right) \mathbb{E} \left(H_{j_2 i_3, k_2 k_3}^{(2)} H_{i_2 i_3, p_2 k_3}^{(2)} \right) \right\}, \tag{2.4.23}
\end{aligned}$$

where the indices with subscript 2 prevent us from treating the two expectation values independently: $H^{(1)}$ and $H^{(2)}$ overlap at the second site. The number of such terms is $2k - 1$, where $k = \frac{N-1}{2}$. □

Therefore, we have found a further reduction of the terms from the departure theorem, that distinguishes the quantum problem from the other two. Luckily and interestingly the kurtosis of the quantum case lies in between the classical and the iso. We emphasize that *the only inputs to the theory are the geometry of the lattice (e.g., the number of summands and the inter-connectivity of the local terms) and the moments* that characterizes the type of the local terms.

Comment: The most general treatment would consider Type I terms as well, i.e., there is no assumption of permutation invariance of the eigenvalues of the local terms. This allows one to treat all types of local terms. Here we are confining to random local interactions, where the local eigenvectors are generic or the eigenvalues locally are permutation invariant in the expectation value sense.

The goal is to find p by matching fourth moments

$$1 - p = \frac{\mathbb{E} \text{Tr} (A \Pi^T B \Pi)^2 - \mathbb{E} \text{Tr} (A Q_q^T B Q_q)^2}{\mathbb{E} \text{Tr} (A \Pi^T B \Pi)^2 - \mathbb{E} \text{Tr} (A Q^T B Q)^2}$$

for which we calculated the denominator resulting in Eq. 2.4.18, where $\mathbb{E} (|q_{i,j}|^4) = \frac{\beta+2}{m(m\beta+2)}$ for β -Haar Q (Table 2.4). If the numerator allows a factorization of the moments of the local terms as in Eq. 2.4.18, then the value of p will be independent of the covariance matrix (i.e., eigenvalues of the local terms).

Lemma. (Universality) $p \mapsto p(N, d, \beta)$, namely, it is independent of the distribution of the local terms.

Proof. We use a similar techniques as we did in the isotropic case. The general form for the numerator of Eq. 2.4.12 is (denoting Lemma 2 by L3)

$$\begin{aligned}
\frac{1}{m} \mathbb{E} \text{Tr} \left[(A \Pi^T B \Pi)^2 - (A Q_q^T B Q_q)^2 \right] &\stackrel{\text{L3}}{=} \frac{(2k-1)}{d^3} \mathbb{E} \text{Tr} \left\{ (H^{(l)} \otimes \mathbb{I}_d)^2 (\mathbb{I}_d \otimes H^{(l+1)})^2 \right. \\
&\quad \left. - [(H^{(l)} \otimes \mathbb{I}_d) (\mathbb{I}_d \otimes H^{(l+1)})]^2 \right\} \\
&= \frac{(2k-1)}{d^3} \mathbb{E} \text{Tr} \left\{ (Q_l^{-1} \Lambda_l Q_l \otimes \mathbb{I}_d)^2 (\mathbb{I}_d \otimes Q_{l+1}^{-1} \Lambda_{l+1} Q_{l+1})^2 \right. \\
&\quad \left. - [(Q_l^{-1} \Lambda_l Q_l \otimes \mathbb{I}_d) (\mathbb{I}_d \otimes Q_{l+1}^{-1} \Lambda_{l+1} Q_{l+1})]^2 \right\} \quad (2.4.24)
\end{aligned}$$

where the expectation on the right hand side is taken with respect to the local terms $H^{(l)}$ and $H^{(l+1)}$. The right hand side is a homogeneous polynomial of order two in the entries of Λ_l , as well as, in the entries of Λ_{l+1} ; consequently Eq. 2.4.24 necessarily has the form

$$c_1 (\Lambda^{\text{even}}, Q_{\text{odd}}, Q_{\text{even}}) m_2^{\text{odd}} + c_2 (H^{\text{even}}, Q_{\text{odd}}, Q_{\text{even}}) m_{1,1}^{\text{odd}}$$

but Eq. 2.4.24 must be zero for $\Lambda_l = I$, for which $m_2^{\text{odd}} = m_{1,1}^{\text{odd}} = 1$. This implies that $c_1 = -c_2$. By permutation invariance of the local terms we can factor out $(m_2^{\text{odd}} - m_{1,1}^{\text{odd}})$. Similarly, the homogeneity and permutation invariance of $H^{(l+1)}$ implies,

$$(m_2^{\text{odd}} - m_{1,1}^{\text{odd}}) [D_1 (Q_{\text{odd}}, Q_{\text{even}}) m_2^{\text{even}} + D_2 (Q_{\text{odd}}, Q_{\text{even}}) m_{1,1}^{\text{even}}].$$

The right hand side should be zero for $\Lambda_{l+1} = I$, whereby we can factor out $(m_2^{\text{even}} - m_{1,1}^{\text{even}})$; hence the right hand side of Eq. 2.4.24 becomes

$$\frac{(2k-1)}{d^3} (m_2^{\text{odd}} - m_{1,1}^{\text{odd}}) (m_2^{\text{even}} - m_{1,1}^{\text{even}}) f_q (Q_{\text{odd}}, Q_{\text{even}}) \quad (2.4.25)$$

where $f_q (Q_{\text{odd}}, Q_{\text{even}})$ is a homogeneous function of order four in the entries of

Q_{odd} as well as Q_{even} . To evaluate f_q , it suffices to let Λ_l and Λ_{l+1} be projectors of rank one where Λ_l would have only one nonzero entry on the i^{th} position on its diagonal and Λ_{l+1} only one nonzero entry on the j^{th} position on its diagonal. Further take those nonzero entries to be ones, giving $m_{1,1}^A = m_{1,1}^B = 0$ and $m_2^A = m_2^B = 1/n$. Using this choice of local terms the right hand side of Eq. 2.4.24 now reads

$$\frac{(2k-1)}{d^3} \mathbb{E} \text{Tr} \left\{ \left(|q_i^{(l)}\rangle\langle q_i^{(l)}| \otimes I_d \right)^2 \left(I_d \otimes |q_j^{(l+1)}\rangle\langle q_j^{(l+1)}| \right)^2 \right. \\ \left. - \left[\left(|q_i^{(l)}\rangle\langle q_i^{(l)}| \otimes I_d \right) \left(I_d \otimes |q_j^{(l+1)}\rangle\langle q_j^{(l+1)}| \right) \right]^2 \right\} \quad (2.4.26)$$

where here the expectation value is taken with respect to random choices of local eigenvectors. Equating this and Eq. 2.4.25

$$f_q(Q_{\text{odd}}, Q_{\text{even}}) = n^2 \mathbb{E} \text{Tr} \left\{ \left(|q_i^{(l)}\rangle\langle q_i^{(l)}| \otimes I_d \right)^2 \left(I_d \otimes |q_j^{(l+1)}\rangle\langle q_j^{(l+1)}| \right)^2 \right. \\ \left. - \left[\left(|q_i^{(l)}\rangle\langle q_i^{(l)}| \otimes I_d \right) \left(I_d \otimes |q_j^{(l+1)}\rangle\langle q_j^{(l+1)}| \right) \right]^2 \right\} \quad (2.4.27)$$

To simplify notation let us expand these vectors in the computational basis $|q_i^{(l)}\rangle = u_{i_1 i_2} |i_1\rangle|i_2\rangle$ and $|q_j^{(l+1)}\rangle = v_{i_2 i_3} |i_2\rangle|i_3\rangle$. The first term on the right hand side of Eq. 2.4.26, the classical term, is obtained by assuming commutativity and using the projector properties,

$$\begin{aligned}
& \text{Tr} \left[\left(|q_i^{(l)}\rangle\langle q_i^{(l)}| \otimes I_d \right)^2 \left(I_d \otimes |q_j^{(l+1)}\rangle\langle q_j^{(l+1)}| \right)^2 \right] = \\
& \text{Tr} \left[\left(|q_i^{(l)}\rangle\langle q_i^{(l)}| \otimes I_d \right) \left(I_d \otimes |q_j^{(l+1)}\rangle\langle q_j^{(l+1)}| \right) \right] = \\
& \text{Tr} [u_{i_1, i_2} \overline{u_{j_1, j_2}} v_{j_2, i_3} \overline{v_{k_2, k_3}} u_{j_1, k_2} |i_1 i_2 i_3\rangle\langle j_1 k_2 k_3|] = \\
& [u_{i_1, i_2} \overline{u_{i_1, j_2}} v_{j_2, i_3} \overline{v_{i_2, i_3}}] = (u^\dagger u)_{j_2 i_2} (v v^\dagger)_{j_2 i_2} = \\
& \text{Tr} [(u^\dagger u) (v v^\dagger)] = \text{Tr} [uv (uv)^\dagger] = \\
& \|uv\|_{\mathbb{F}}^2 = \sum_{i=1}^d \sigma_i^2. \quad (2.4.28)
\end{aligned}$$

where $\|\cdot\|_{\mathbb{F}}$ denotes the Frobenius norm and σ_i are the singular values of uv . The second term, the quantum term, is

$$\begin{aligned}
& \text{Tr} \left[\left(|q_i^{(l)}\rangle\langle q_i^{(l)}| \otimes I_d \right) \left(I_d \otimes |q_j^{(l+1)}\rangle\langle q_j^{(l+1)}| \right) \right]^2 = \quad (2.4.29) \\
& \text{Tr} [u_{i_1, i_2} \overline{u_{j_1, j_2}} v_{j_2, i_3} \overline{v_{k_2, k_3}} u_{j_1, k_2} \overline{u_{m_1, m_2}} v_{m_2, k_3} \overline{v_{i_2, i_3}} |i_1 i_2 i_3\rangle\langle p_1 p_2 p_3|] = \\
& (u^\dagger u)_{j_2 k_2} (v v^\dagger)_{m_2 k_2} (u^\dagger u)_{m_2 i_2} (v v^\dagger)_{j_2 i_2} = \\
& (u^\dagger u v v^\dagger)_{j_2 m_2} (u^\dagger u v v^\dagger)_{m_2 j_2} = \text{Tr} \left\{ \left[uv (uv)^\dagger \right]^2 \right\} = \\
& \left\| uv (uv)^\dagger \right\|_{\mathbb{F}}^2 = \sum_{i=1}^d \sigma_i^4.
\end{aligned}$$

where we used the symmetry of $(uv (uv)^\dagger)^2 = uv (uv)^\dagger [uv (uv)^\dagger]^\dagger$.

Now we can calculate

$$f_q(Q_{\text{odd}}, Q_{\text{even}}) = n^2 \mathbb{E} \left\{ \|uv\|_{\mathbb{F}}^2 - \left\| uv (uv)^\dagger \right\|_{\mathbb{F}}^2 \right\} \quad (2.4.30)$$

giving us the desired result

$$\begin{aligned} \frac{1}{m} \mathbb{E} \text{Tr} \left[(A \Pi^T B \Pi)^2 - (A Q_q^T B Q_q)^2 \right] &= d(2k-1) \left(m_2^{\text{odd}} - m_{1,1}^{\text{odd}} \right) \left(m_2^{\text{even}} - m_{1,1}^{\text{even}} \right) \\ &\times \mathbb{E} \left(\|uv\|_{\mathbb{F}}^2 - \|uv(uv)^\dagger\|_{\mathbb{F}}^2 \right), \end{aligned} \quad (2.4.31)$$

from which

$$\begin{aligned} 1-p &= \frac{\mathbb{E} \text{Tr} (A \Pi^T B \Pi)^2 - \mathbb{E} \text{Tr} (A Q_q^{-1} B Q_q)^2}{\mathbb{E} \text{Tr} (A \Pi^T B \Pi)^2 - \mathbb{E} \text{Tr} (A Q^{-1} B Q)^2} \\ &= \frac{d(2k-1) \mathbb{E} \left(\|uv\|_{\mathbb{F}}^2 - \|uv(uv)^\dagger\|_{\mathbb{F}}^2 \right)}{\left(\frac{km(n-1)}{n(m-1)} \right)^2 \{1 - m \mathbb{E} (q_{ij}^A)\}}. \end{aligned} \quad (2.4.32)$$

The dependence on the covariance matrix has cancelled- a covariance matrix is one whose element in the i, j position is the covariance between the i^{th} and j^{th} eigenvalue. This shows that p is independent of eigenvalues of the local terms which proves the universality lemma.

Comment: To get the numerator we used permutation invariance of A and B and local terms, to get the denominator we used permutation invariance of Q .

□

Comment: It is interesting that the amount of mixture of the two extremes needed to capture the quantum spectrum is independent of the actual types of local terms. It only depends on the physical parameters of the lattice.

2.4.5 The Slider Theorem and a Summary

In this section we make explicit use of β -Haar properties of Q and local terms. To prove that there exists a $0 \leq p \leq 1$ such that the combination in Eq. 2.4.2 is convex we need to evaluate the expected Frobenius norms in Eq. 2.4.31.

Lemma 3. $\mathbb{E} \|uv\|_F^2 = 1/d$ and $\mathbb{E} \left\| uv (uv)^\dagger \right\|_F^2 = \frac{\beta^2[3d(d-1)+1]+2\beta(3d-1)+4}{d(\beta d^2+2)^2}$, when local terms have β -Haar eigenvectors.

Proof. It is a fact that $G = u\chi_{\beta d^2}$, when u is uniform on a sphere, G is a $d \times d$ β -Gaussian matrix whose expected Frobenius norm has a χ -distribution denoted here by $\chi_{\beta d^2}$ (similarly for v). Recall that $\mathbb{E}(\chi_h^2) = h$ and $\mathbb{E}(\chi_h^4) = h(h+2)$.

$$\begin{aligned} \mathbb{E} \|uv\|_F^2 \quad \mathbb{E} (\chi_{\beta d^2})^2 &= \mathbb{E} \|(G_1 G_2)\|_F^2 & (2.4.33) \\ \Rightarrow \mathbb{E} \|uv\|_F^2 &= \frac{1}{(\beta d^2)^2} \mathbb{E} \|G_1 G_2\|_F^2 = \frac{d^2}{(\beta d^2)^2} \mathbb{E} \sum_{k=1}^d \left(g_{i,k}^{(1)} g_{kj}^{(2)} \right)^2 \\ &= \frac{d^2}{(\beta d^2)^2} d(\beta)^2 = \frac{1}{d}. \end{aligned}$$

The quantum case, $u^\dagger u = \frac{G_1^\dagger G_1}{\|G_1\|_F^2} \equiv \frac{W_1}{\|G_1\|_F^2}$, similarly $v^\dagger v = \frac{G_2^\dagger G_2}{\|G_2\|_F^2} \equiv \frac{W_2}{\|G_2\|_F^2}$, where W_1 and W_2 are Wishart matrices.

$$\mathbb{E} \left\| uv (uv)^\dagger \right\|_F^2 = \frac{\mathbb{E} \text{Tr} (W_1 W_2)^2}{\mathbb{E} (\chi_{d^2 \beta}^4) \mathbb{E} (\chi_{d^2 \beta}^4)} = \frac{\mathbb{E} \text{Tr} (W_1 W_2)^2}{[d^2 \beta (d^2 \beta + 2)]^2} \quad (2.4.34)$$

hence the complexity of the problem is reduced to finding the expectation of the trace of a product of Wishart matrices.

$$\mathbb{E} \text{Tr} (W_1 W_2)^2 = \mathbb{E} \text{Tr} (W_1 W_2 W_1 W_2) = \mathbb{E} \sum_{1 \leq ijkl \leq d} x_i x_i^\dagger y_j y_j^\dagger x_k x_k^\dagger y_l y_l^\dagger \equiv \Pi \begin{bmatrix} x_i^\dagger y_j & y_l^\dagger x_i \\ y_j^\dagger x_k & x_k^\dagger y_l \end{bmatrix}, \quad (2.4.35)$$

where Π denotes the product of the elements of the matrix. There are three types of expectations summarized in Table 2.5.

In Table 2.5

Notation	Type	Count
X	$i \neq k \ \& \ j \neq l$	$d^2 (d - 1)^2$
Y	$i = k \ \& \ j \neq l$ or $i \neq k \ \& \ j = l$	$2d^2 (d - 1)$
Z	$i = k \ \& \ j = l$	d^2

Table 2.5: Expectation values.

$$\begin{aligned}
X &\equiv \mathbb{E}[\Pi(x_i x_k)(y_i y_l)] \\
Y &\equiv \mathbb{E}\left[\left(x_i^\dagger y_j\right)^2 \left(x_i^\dagger y_l\right)^2\right] \\
Z &\equiv \mathbb{E}\left[\left(x_i^\dagger y_i\right)^4\right].
\end{aligned}$$

We now evaluate these expectation values. We have

$$X = \Pi \begin{pmatrix} \chi_{\beta d} & g_\beta \\ 0 & \chi_{\beta(d-1)} \\ 0 & 0 \\ \vdots & \vdots \end{pmatrix}^\dagger \begin{pmatrix} g_\beta & g_\beta \\ g_\beta & g_\beta \\ \text{DC} & \text{DC} \\ \vdots & \vdots \end{pmatrix}$$

by QR decomposition, where g_β and χ_h denote an element with a β -Gaussian and χ_h distribution respectively; DC means ‘‘Don’t Care’’. Consequently

$$\begin{aligned}
X &= \Pi \begin{pmatrix} \chi_{\beta d} & g_\beta \\ 0 & \chi_{\beta(d-1)} \end{pmatrix} \begin{pmatrix} a & b \\ c & d \end{pmatrix} \\
&= \Pi \begin{bmatrix} a\chi_{\beta d} & g_\beta a + \chi_{\beta(d-1)}c \\ b\chi_{\beta d} & g_\beta b + \chi_{\beta(d-1)}d \end{bmatrix} = \Pi \begin{bmatrix} a\chi_{\beta d} & g_\beta a \\ b\chi_{\beta d} & g_\beta b \end{bmatrix} \\
&= \chi_{\beta d}^2 a^2 b^2 g_\beta^2 = \beta^4 d.
\end{aligned}$$

where we denoted the four independent Gaussian entries by a, b, c, d to not confuse them as one number. From Eq. 2.4.35 we have

$$\begin{aligned} Y &= \mathbb{E} \left[\left(x_i^\dagger y_j \right)^2 \left(x_i^\dagger y_l \right)^2 \right] = \mathbb{E} \left(\chi_{d\beta} g_\beta^{(1)} \right)^2 \left(\chi_{d\beta} g_\beta^{(2)} \right)^2 = \beta d (\beta d + 2) \beta^2 \\ Z &= \mathbb{E} \left(x^\dagger y \right)^4 = \mathbb{E} \left(\chi_{\beta d}^4 \right) \mathbb{E} \left(\chi_\beta^4 \right) = \beta d (\beta d + 2) \beta (\beta + 2). \end{aligned}$$

Eq. 2.4.34 now reads

$$\mathbb{E} \left\| uv (uv)^\dagger \right\|_F^2 = \frac{\beta^2 [3d(d-1) + 1] + 2\beta(3d-1) + 4}{d(\beta d^2 + 2)^2}. \quad (2.4.36)$$

□

Theorem. (The Slider Theorem) *The quantum kurtosis lies in between the classical and the iso kurtoses, $\gamma_2^{iso} \leq \gamma_2^q \leq \gamma_2^c$. Therefore there exists a $0 \leq p \leq 1$ such that $\gamma_2^q = p\gamma_2^c + (1-p)\gamma_2^{iso}$. Further, $\lim_{N \rightarrow \infty} p = 1$.*

Proof. We have $\left\{ 1 - \frac{1}{m} \sum_{ij=1}^m q_{ij}^4 \right\} \geq 0$, since $\sum_{ij} q_{ij}^4 \leq \sum_{ij} q_{ij}^2 = m$. The last inequality follows from $q_{ij}^2 \leq 1$. Therefore, Eq. 2.4.8 is

$$\begin{aligned} \gamma_2^{iso} - \gamma_2^c &= \frac{2}{\sigma^4} \left(m_2^{\text{odd}} - m_{11}^{\text{odd}} \right) \left(m_2^{\text{even}} - m_{11}^{\text{even}} \right) \times \\ &\quad \left(\frac{km(n-1)}{n(m-1)} \right)^2 \left\{ m \mathbb{E} \left(q_{11}^4 \right) - 1 \right\} \leq 0. \end{aligned}$$

From Eqs. 2.4.29 and 2.4.28 and using the fact that the singular values $\sigma_i \leq 1$ we have

$$\left\| uv (uv)^\dagger \right\|_F^2 = \sum_{i=1}^d \sigma_i^4 \leq \sum_{i=1}^d \sigma_i^2 = \|uv\|_F^2$$

which proves $\gamma_2^q - \gamma_2^c \leq 0$. In order to establish $\gamma_2^{iso} \leq \gamma_2^q \leq \gamma_2^c$, we need to show that $\gamma_2^c - \gamma_2^q \leq \gamma_2^c - \gamma_2^{iso}$. Eq. 2.4.32 after substituting $m \mathbb{E} \left(q_{ij}^4 \right) = \frac{\beta+2}{(m\beta+2)}$ from Table 2.4

and Eqs. 2.4.33, 2.4.36 reads

$$1 - p = (1 - d^{-2k-1}) \left[1 - \left(\frac{k-1}{k} \right)^2 \right] \left\{ \left(1 - \frac{1 - d^{-2k+1}}{1 + \beta d^2/2} \right) \left(\frac{d}{d+1} \right)^2 \right. \\ \left. \left[\frac{\beta (d^3 + d^2 - 2d + 1) + 4d - 2}{(d-1)(\beta d^2 + 2)} \right] \right\} \quad (2.4.37)$$

We want to show that $0 \leq 1 - p \leq 1$ for any integer $k \geq 1$, $d \geq 2$ and $\beta \geq 1$. All the factors are manifestly ≥ 0 , therefore $1 - p \geq 0$. The first two factors are clearly ≤ 1 so we need to prove that the term in the braces is too. Further, $k = 1$ provides an upper bound as $\left(1 - \frac{1 - d^{-2k+1}}{1 + \beta d^2/2} \right) \leq \left(1 - \frac{1 - d^{-3}}{1 + \beta d^2/2} \right)$. We rewrite the term in the braces

$$\frac{d(\beta d^3 + 2) [\beta (d^3 + d^2 - 2d + 1) + 4d - 2]}{(\beta d^2 + 2)^2 (d+1)^2 (d-1)}, \quad (2.4.38)$$

but we can subtract the denominator from the numerator to get

$$(\beta d + 2) [\beta (d^4 - 2d^3) + 2 (d^3 - d^2 - 1)] \geq 0 \quad \forall d \geq 2.$$

This proves that (2.4.38) is less than one. Therefore, the term in the braces is less than one and hence $0 \leq p \leq 1$. Let us note the following limits of interest (recall $N - 1 = 2k$)

$$\lim_{d \rightarrow \infty} (1 - p) = \frac{2k - 1}{k^2} \stackrel{k=1}{=} 1 \\ \lim_{N \rightarrow \infty} (1 - p) \sim \frac{1}{N} \rightarrow 0$$

the first limit tells us that if we consider having two local terms and take the local dimension to infinity we have essentially free probability theory as expected. The second limit shows that in the thermodynamical limit (i.e., $N \rightarrow \infty$) the convex combination slowly approaches the classical end. In the limit where $\beta \rightarrow \infty$ the β dependence in $(1 - p)$ cancels out. This is a reconfirmation of the fact that in free probability theory, for $\beta \rightarrow \infty$, the result should be independent of β . We see that the bounds are tight.

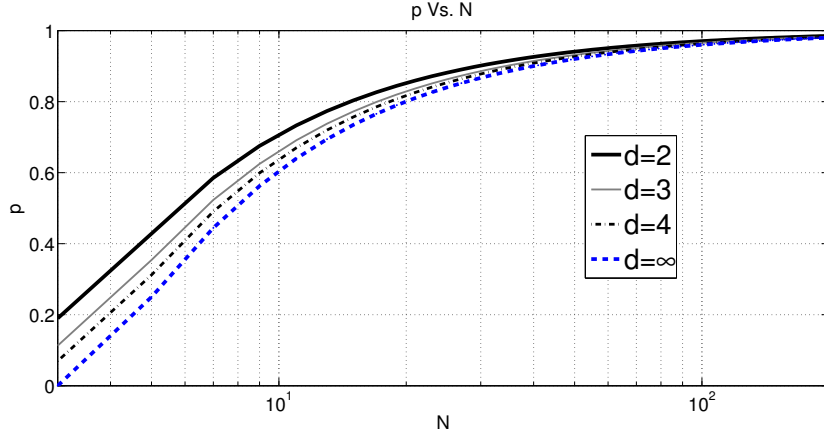

Figure 2.4.2: An example: $\beta = 1$: the quantum problem for all d lies in between the iso ($p = 0$) and the classical ($p = 1$).

□

Comment: Entanglement shows itself starting at the fourth moment; further, in the expansion of the fourth moments only the terms that involve *a pair* of local terms *sharing a site* differ. Note that when the QMBS possesses a translational symmetry, there is an additional complication introduced by the dependence of the local terms. Though, in this case, the non-iid nature of the local terms complicates the matter theoretically, we have not seen a practical limitation of IE in our numerical experiments.

Comment: One could from the beginning use free approximation instead of isotropic ($m \rightarrow \infty$), in which case the proofs are simplified.

We now summarize the main thesis of this work. We are interested in the eigenvalue distribution of

$$H \equiv H_{\text{odd}} + H_{\text{even}} = \sum_{l=1,3,5,\dots} \mathbb{I} \otimes H_{l,l+1} \otimes \mathbb{I} + \sum_{l=2,4,6,\dots} \mathbb{I} \otimes H_{l,l+1} \otimes \mathbb{I},$$

which in a basis in that H_{odd} is diagonal reads $H = A + Q_q^{-1}BQ_q$. Since this problem has little hope in being solved exactly we consider along with it two known approximations:

$$\begin{aligned} H_c &= A + \Pi^{-1}B\Pi \\ H &= A + Q_q^{-1}BQ_q \\ H_{iso} &= A + Q^{-1}BQ. \end{aligned}$$

We proved that the first three moments of the three foregoing equations are equal. We then calculated their fourth moments as encoded by their kurtoses (γ_2 's) analytically and proved that there exists a $0 \leq p \leq 1$ such that

$$\gamma_2^q = p\gamma_2^c + (1-p)\gamma_2^{iso}.$$

It turned out that the only terms in the expansion of the fourth moments that were relevant were

$$1 - p = \frac{\mathbb{E}\text{Tr} \left\{ (A\Pi^{-1}B\Pi)^2 - (AQ_q^{-1}BQ_q)^2 \right\}}{\mathbb{E}\text{Tr} \left\{ (A\Pi^{-1}B\Pi)^2 - (AQ^{-1}BQ)^2 \right\}}. \quad (2.4.39)$$

Through direct calculation we found that the numerator $\mathbb{E}\text{Tr} \left\{ (A\Pi^{-1}B\Pi)^2 - (AQ_q^{-1}BQ_q)^2 \right\}$ evaluates to be

$$d(2k-1) \left(m_2^{\text{odd}} - m_{1,1}^{\text{odd}} \right) \left(m_2^{\text{even}} - m_{1,1}^{\text{even}} \right) \mathbb{E} \left(\|uv\|_{\mathbb{F}}^2 - \left\| uv (uv)^\dagger \right\|_{\mathbb{F}}^2 \right),$$

and the denominator $\mathbb{E}\text{Tr} \left\{ (A\Pi^{-1}B\Pi)^2 - (AQ^{-1}BQ)^2 \right\}$

$$\left(m_2^{\text{odd}} - m_{1,1}^{\text{odd}} \right) \left(m_2^{\text{even}} - m_{1,1}^{\text{even}} \right) \left(\frac{km(n-1)}{n(m-1)} \right)^2 \{ 1 - m\mathbb{E}(q_{ij}^4) \}.$$

Therefore $1 - p$ does not depend on the local distribution and can generally be expressed as

$$1 - p = \frac{d(2k - 1) \mathbb{E} \left(\left\| uv \right\|_{\mathbb{F}}^2 - \left\| uv (uv)^\dagger \right\|_{\mathbb{F}}^2 \right)}{\left(\frac{km(n-1)}{n(m-1)} \right)^2 \{1 - m \mathbb{E} (q_{ij}^4)\}}.$$

If we further assume that the local eigenvectors are β – Haar distributed we get

$$1 - p = (1 - d^{-2k-1}) \left[1 - \left(\frac{k-1}{k} \right)^2 \right] \left(1 - \frac{1 - d^{-2k+1}}{1 + \beta d^2/2} \right) \left(\frac{d}{d+1} \right)^2 \\ \times \left[\frac{\beta(d^3 + d^2 - 2d + 1) + 4d - 2}{(d-1)(\beta d^2 + 2)} \right].$$

Next we asserted that this p can be used to approximate the distribution

$$d\nu^q \approx d\nu^{IE} = p d\nu^c + (1 - p) d\nu^{iso}.$$

We argued that the spectra obtained using Isotropic Entanglement (IE) are accurate well beyond four moments.

For illustration, we apply IE theory in full detail to a chain with Wishart matrices as local terms. Other types of local terms (e.g. GOE, random ± 1 eigenvalues) can be treated similarly; therefore in Section 2.6 we show the plots comparing IE with exact diagonalization for these cases.

2.5 A Detailed Example: Wishart Matrices as Local Terms

As an example take a chain with odd number of sites and for the local terms in Eq. 2.1.1 pick $H^{(l)} = W^T W$, where W is a rank r matrix whose elements are picked

randomly from a Gaussian distribution ($\beta = 1$); these matrices $W^T W$ are known as *Wishart matrices*. Clearly the maximum possible rank is $r = d^2$ for each of the local terms.

Any cumulant is equal to the corresponding cumulant of one local term, denoted by κ , times the number of summands in Eq. 2.1.1. In particular, the fourth cumulant of H is $\kappa_4^{(N-1)} = (N-1)\kappa_4$. Below we drop the superscripts when the quantity pertains to the whole chain. Next we recall the definitions in terms of cumulants of the mean (μ), the variance (σ^2), the skewness (γ_1), and the kurtosis (γ_2)

$$\mu \equiv \kappa_1 \quad \sigma^2 \equiv \kappa_2 \quad \gamma_1 \equiv \frac{\kappa_3}{\sigma^3} \quad \gamma_2 \equiv \frac{\kappa_4}{\sigma^4} = \frac{m_4}{\sigma^4} - 3 \quad . \quad (2.5.1)$$

2.5.1 Evaluation of $p = \frac{\gamma_2^q - \gamma_2^{iso}}{\gamma_2^c - \gamma_2^{iso}}$

The moments of the local terms are obtained from MOPS [51];

$$\begin{aligned} m_1 &= \beta r \\ m_2 &= \beta r [\beta (r + n - 1) + 2] \\ m_3 &= \beta r \{ \beta^2 [n^2 + (r - 1)(3n + r - 2)] + 6\beta (n + r - 1) + 8 \} \\ m_4 &= \beta r \{ 48 + \beta^3 [n^3 + 6n^2(r - 1) + n(6r - 11)(r - 1) - 6(r^2 + 1) + r^3 + 11r] \\ &\quad + 2\beta^2 [6(n^2 + r^2) + 17(n(r - 1) - r) + 11] + 44\beta (n + r - 1) \} \\ m_{1,1} &= \beta^2 r (r - 1) \end{aligned} \quad (2.5.2)$$

which for real matrices $\beta = 1$ yields

$$\begin{aligned} m_1 &= r \\ m_2 &= r (r + n + 1) \\ m_3 &= r (n^2 + 3n + 3rn + 3r + r^2 + 4) \\ m_4 &= r (6n^2 + 21n + 6rn^2 + 17rn + 21r + 6nr^2 + 6r^2 + n^3 + r^3 + 20) \\ m_{1,1} &= r (r - 1) . \end{aligned} \quad (2.5.3)$$

The mean, variance, skewness, and kurtosis are obtained from the foregoing relations, through the cumulants Eq. 2.5.1. We drop the superscripts when the quantity pertains to the whole chain. Therefore, using Eq. 2.5.1, we have

$$\begin{aligned} \mu &\equiv (N-1)r & \sigma^2 &\equiv r(N-1)(n+1) \\ \gamma_1 &\equiv \frac{n^2+3n+4}{(n+1)^{3/2}\sqrt{r(N-1)}} & \gamma_2^{(c)} &\equiv \frac{n^2(n+6)-rn(n+1)+21n+2r+20}{r(N-1)(n+1)^2}. \end{aligned} \quad (2.5.4)$$

From Eq. 2.4.10 we readily obtain

$$\frac{1}{m} \mathbb{E} \text{Tr} (A\Pi^T B\Pi)^2 = r^2 k^2 (rk + n + 1)^2. \quad (2.5.5)$$

By The Matching Three Moments theorem we immediately have the mean, the variance and the skewness for the isotropic case

$$\begin{aligned} \mu &= (N-1)r & \sigma^2 &= r(N-1)(n+1) \\ \gamma_1 &= \frac{n^2+3n+4}{(n+1)^{3/2}\sqrt{r(N-1)}}. \end{aligned}$$

Note that the denominator in Eq. 2.4.2 becomes,

$$\gamma_2^c - \gamma_2^{iso} = \frac{\kappa_4^{(c)} - \kappa_4^{(iso)}}{\sigma^4} = \frac{2}{m} \frac{\mathbb{E} \left\{ \text{Tr} \left[(A\Pi^T B\Pi)^2 - (AQ^T BQ)^2 \right] \right\}}{r^2 (N-1)^2 (n+1)^2}. \quad (2.5.6)$$

In the case of Wishart matrices, $m_1^{\text{odd}} = m_1^{\text{even}} = r$, and $m_2^{\text{odd}} = m_2^{\text{even}} = r(r+n+1)$, $m_{11}^{\text{odd}} = m_{11}^{\text{even}} = r(r-1)$ given by Eqs. 2.4.10 and 2.4.11 respectively. Therefore we can substitute these into Eq. 2.4.18

$$\begin{aligned} \frac{1}{m} \mathbb{E} \left\{ \text{Tr} \left[(A\Pi^T B\Pi)^2 - (AQ^T BQ)^2 \right] \right\} &= \left(m_2^{(A)} - m_{1,1}^{(A)} \right) \left(m_2^{(B)} - m_{1,1}^{(B)} \right) \{ 1 - m \mathbb{E} (q_{ij}^4) \} \\ &= \frac{\beta(m-1)}{(m\beta+2)} \left(\frac{km(n-1)}{n(m-1)} \right)^2 (m_2 - m_{1,1})^2 \\ &= \frac{\beta k^2 m^2 (n-1)^2}{(m\beta+2)(m-1)n^2} (m_2 - m_{1,1})^2 \end{aligned} \quad (2.5.7)$$

One can also calculate each of the terms separately and obtain the same results (see Appendix for the alternative).

From Eq. 2.4.31 we have

$$\begin{aligned}
\frac{1}{m} \mathbb{E} \left[\text{Tr} (A \Pi^T B \Pi)^2 - \text{Tr} (A Q_q^T B Q_q)^2 \right] &= d(2k-1)(m_2 - m_{1,1})^2 \\
&\times \mathbb{E} \left(\left\| uv \right\|_{\mathbb{F}}^2 - \left\| uv (uv)^\dagger \right\|_{\mathbb{F}}^2 \right) \\
&= (2k-1)(m_2 - m_{1,1})^2 \\
&\times \left\{ \frac{1 + d(d^3 + d - 3)}{(d^2 + 2)^2} \right\}. \quad (2.5.8)
\end{aligned}$$

We can divide Eq. 2.5.8 by Eq. 2.5.7 to evaluate the parameter p .

2.5.2 Summary of Our Findings and Further Numerical Results

We summarize the results along with numerical experiments in Tables 2.6 and 2.8 to show the equivalence of the first three moments and the departure of the three cases in their fourth moment. As said above,

$$Q_c = \mathbb{I}_{d^N} \quad Q_{iso} \equiv Q \text{ Haar } d^N \times d^N \quad Q_q = (Q_q^{(A)})^T Q_q^{(B)} \quad (2.5.9)$$

where, $(Q_q^{(A)})^T Q_q^{(B)}$ is given by Eq. 2.3.10. In addition, from Eq. 2.5.4 we can define Δ to be the part of the kurtosis that is equal among the three cases

$$\Delta = \gamma_2^c - \frac{2m_2^A m_2^B}{\sigma^4} = \gamma_2^c - \frac{1}{2} \frac{(rk+n+1)^2}{(n+1)^2}.$$

Using Δ we can obtain the full kurtosis for the iso and quantum case, and therefore (see Table 2.6 for a theoretical summary):

$$p = \frac{\gamma_2^q - \gamma_2^{iso}}{\gamma_2^c - \gamma_2^{iso}}. \quad (2.5.10)$$

$\beta = 1$ Wishart	Iso	Quantum	Classical
Mean μ	$r(N-1)$		
Variance σ^2	$r(N-1)(d^2+1)$		
Skewness γ_1	$\frac{d^4+3d^2+4}{\sqrt{r(N-1)(d^2+1)^3}}$		
$\frac{1}{m} \mathbb{E} [\text{Tr} (AQ_{\bullet}^T BQ_{\bullet})^2]$	$m_2^A m_2^B - \text{Eq. 2.5.7}$	$m_2^A m_2^B - \text{Eq. 2.5.8}$	$r^2 k^2 (rk + n + 1)^2$
Kurtosis $\gamma_2^{(\bullet)}$	$\frac{2}{m\sigma^4} \mathbb{E} [\text{Tr} (AQ^T BQ)^2] + \Delta$	$\frac{2}{m\sigma^4} \mathbb{E} [\text{Tr} (AQ_q^T BQ_q)^2] + \Delta$	Eq. 2.5.4

Table 2.6: Summary of the results when the local terms are Wishart matrices. The fourth moment is where the three cases differ.

The numerical convergence of the kurtoses to the theoretical values were rather slow. To make sure the results are consistent we did a large run with 500 million trials for $N = 5$, $d = 2$, $r = 3$ and $\beta = 1$ and obtained four digits of accuracy

$$\begin{aligned} \gamma_2^c - \gamma_2^{iso} &= 0.39340 && \text{Numerical experiment} \\ \gamma_2^c - \gamma_2^{iso} &= 0.39347 && \text{Theoretical value.} \end{aligned}$$

Convergence is faster if one calculates p based on the departing terms alone (Eq. 2.4.39). In this case, for full rank Wishart matrices with $N = 5$ and $d = 2$

$\beta = 1$, trials: 5 Million	$1 - p$	$\beta = 2$, trials: 10 Million	$1 - p$
Numerical Experiment	0.57189	Numerical Experiment	0.63912
Theoretical Value	0.57183	Theoretical Value	0.63938

Below we compare our theory against exact diagonalization for various number of sites N , local ranks r , and site dimensionality d (Figures 2.5.1-2.5.5).

Experiments based on 500000 trials						
$N = 3$	Theoretical value			Numerical Experiment		
	Iso	Quantum	Classical	Iso	Quantum	Classical
Mean μ	8			8.007	8.007	7.999
Variance σ^2	40			40.041	40.031	39.976
Skewness γ_1	$\frac{8}{25}\sqrt{10} = 1.01192$			1.009	1.009	1.011
Kurtosis γ_2	$\frac{516}{875} = 0.590$	$\frac{33}{50} = 0.660$	$\frac{24}{25} = 0.960$	0.575	0.645	0.953
Experiments based on 500000 trials						
$N = 5$	Theoretical value			Numerical Experiment		
	Iso	Quantum	Classical	Iso	Quantum	Classical
Mean μ	16			15.999	15.999	16.004
Variance σ^2	80			79.993	80.005	80.066
Skewness γ_1	$\frac{8}{25}\sqrt{5} = 0.716$			0.715	0.715	0.717
Kurtosis γ_2	$\frac{228}{2635} = 0.087$	$\frac{51}{200} = 0.255$	$\frac{12}{25} = 0.480$	0.085	0.255	0.485
Experiments based on 300000 trials						
$N = 7$	Theoretical value			Numerical Experiment		
	Iso	Quantum	Classical	Iso	Quantum	Classical
Mean μ	24			23.000	23.000	24.095
Variance σ^2	120			120.008	120.015	120.573
Skewness γ_1	$\frac{8}{75}\sqrt{30} = 0.584$			0.585	0.585	0.588
Kurtosis γ_2	$-\frac{16904}{206375} = -0.082$	$\frac{23}{150} = 0.153$	$\frac{8}{25} = 0.320$	-0.079	0.156	0.331
Experiments based on 40000 trials						
$N = 9$	Theoretical value			Numerical Experiment		
	Iso	Quantum	Classical	Iso	Quantum	Classical
Mean μ	32			32.027	32.027	31.777
Variance σ^2	160			160.074	160.049	157.480
Skewness γ_1	$\frac{4}{25}\sqrt{10} = 0.506$			0.505	0.506	0.500
Kurtosis γ_2	$-\frac{539142}{3283175} = -0.164$	$\frac{87}{800} = 0.109$	$\frac{6}{25} = 0.240$	-0.165	0.109	0.213
Experiments based on 2000 trials						
$N = 11$	Theoretical value			Numerical Experiment		
	Iso	Quantum	Classical	Iso	Quantum	Classical
Mean μ	40			39.973	39.973	39.974
Variance σ^2	200			200.822	200.876	197.350
Skewness γ_1	$\frac{8}{25}\sqrt{2} = 0.452548$			0.4618	0.4538	0.407
Kurtosis γ_2	$-\frac{11162424}{52454375} = -0.213$	$\frac{21}{250} = 0.084$	$\frac{24}{125} = 0.192$	-0.189	0.093	0.102

Table 2.8: The mean, variance and skewness of classical, iso and quantum results match. However, the fourth moments (kurtoses) differ. Here we are showing results for $d = 2$, $r = 4$ with an accuracy of three decimal points.

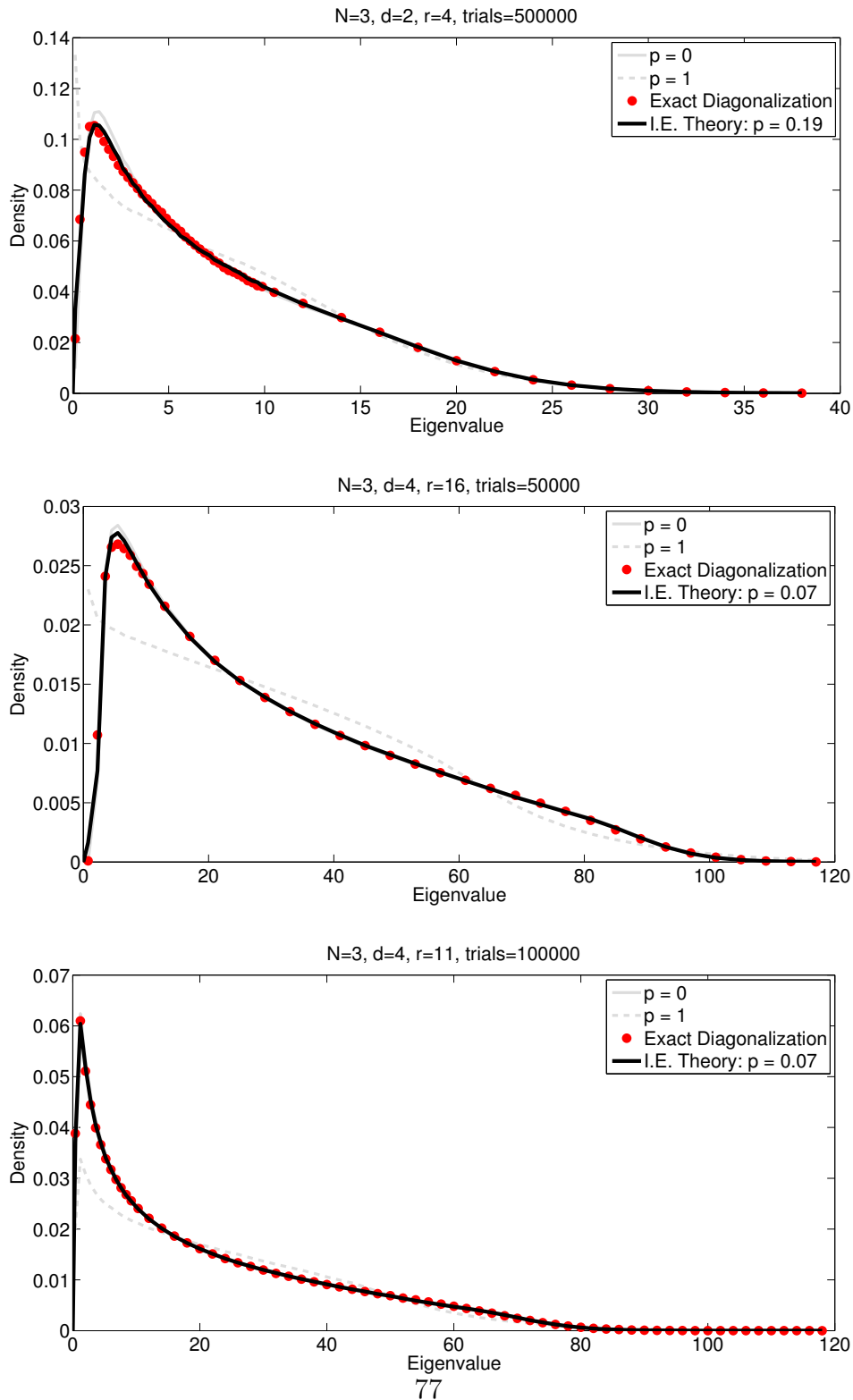

Figure 2.5.1: $N = 3$ examples. Note that the last two plots have the same p despite having different ranks r . This is a consequence of the Universality Lemma since they have the same N and d .

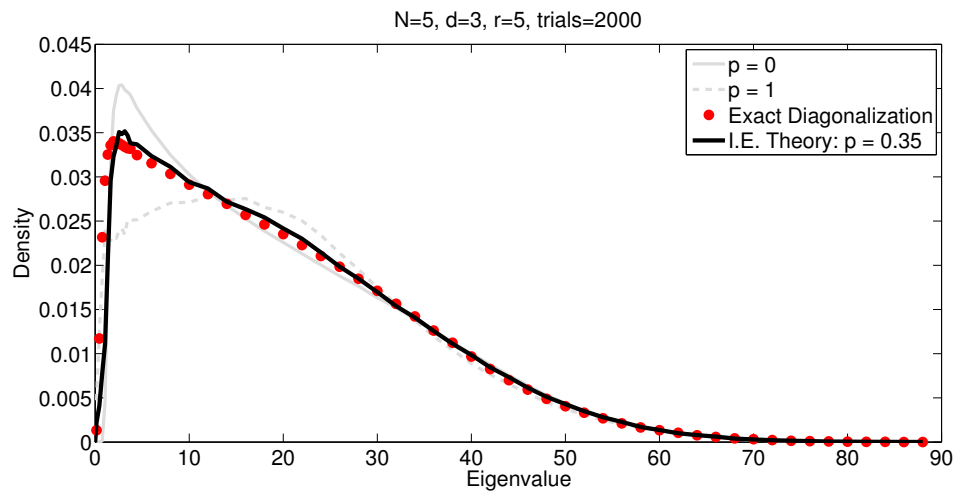
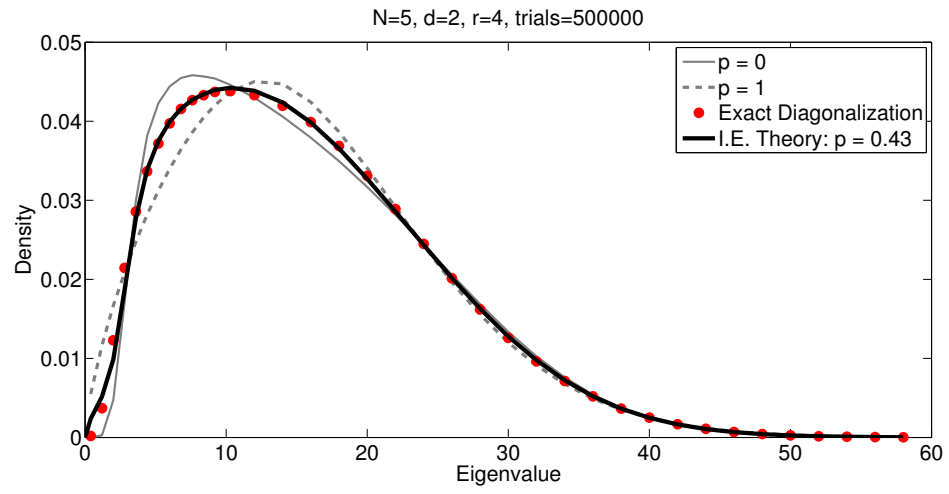

Figure 2.5.2: $N = 5$

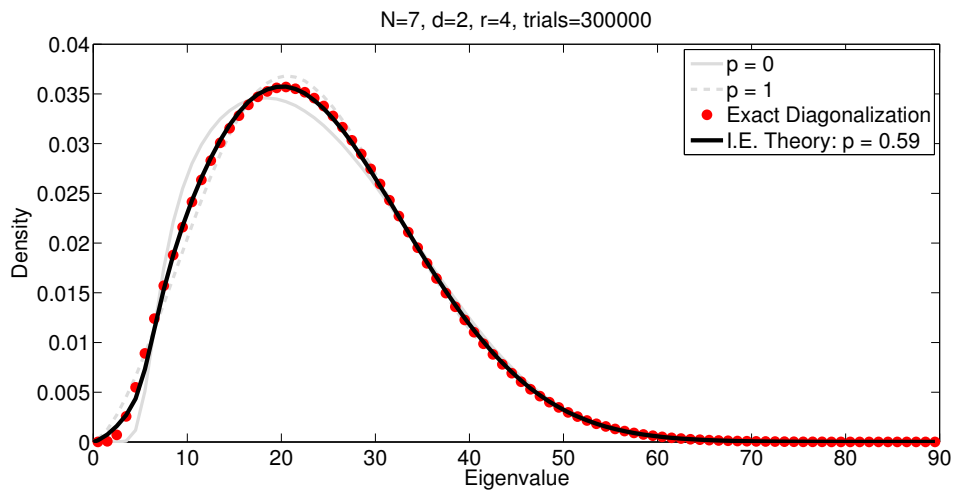

Figure 2.5.3: $N = 7$

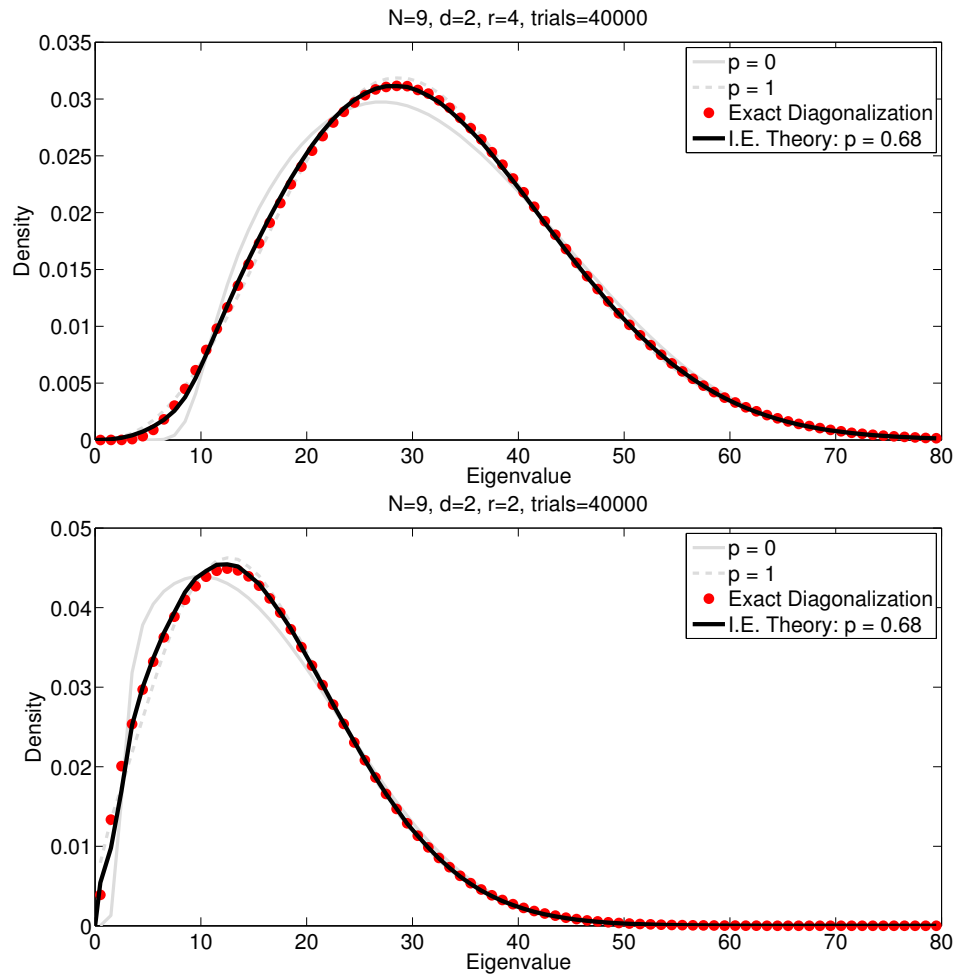

Figure 2.5.4: $N = 9$. Note that the two plots have the same p despite having different local ranks.

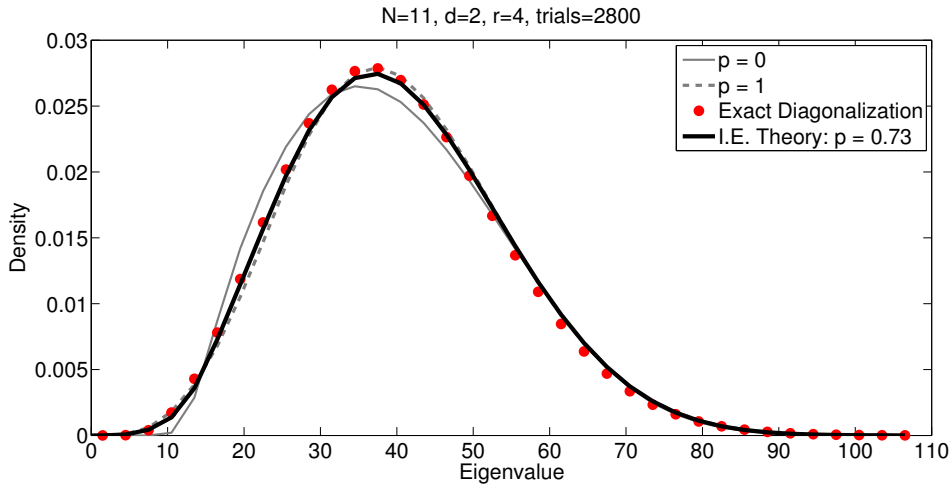

Figure 2.5.5: $N = 11$

2.6 Other Examples of Local Terms

Because of the Universality lemma, p is independent of the type of local distribution. Furthermore, as discussed above, the application of the theory for other types of local terms is entirely similar to the Wishart case. Therefore, we only show the results in this section. As a second example consider GOE's as local terms, i.e., $H_{l,l+1} = \frac{G^T + G}{2}$, where G is a full rank matrix whose elements are real Gaussian random numbers.

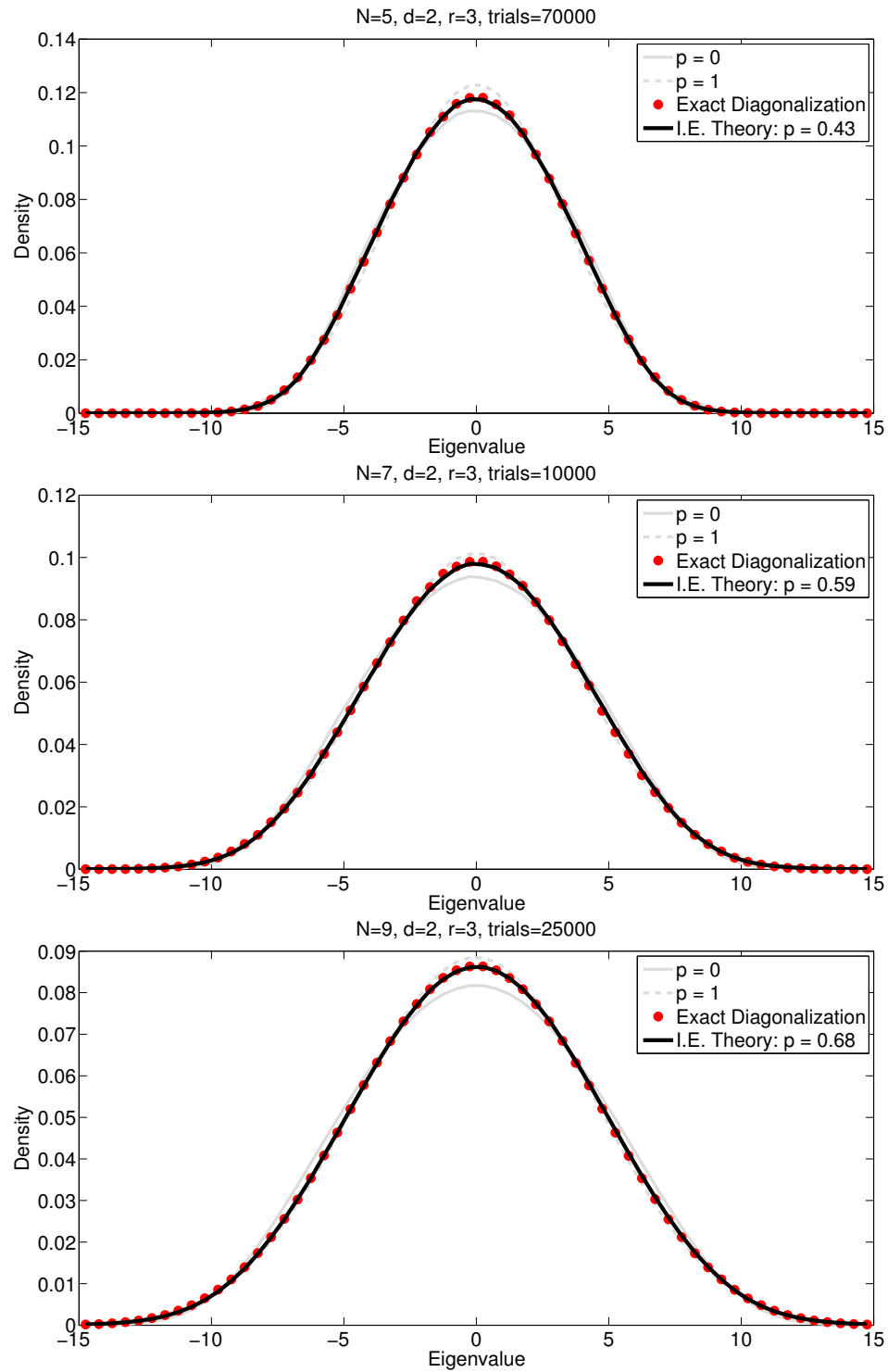

Figure 2.6.1: GOE's as local terms

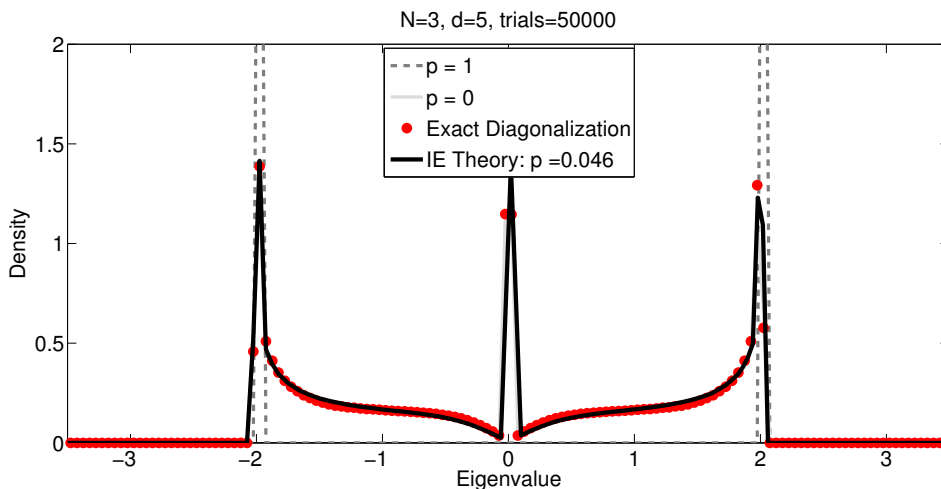

Figure 2.6.2: Local terms have a random binomial distribution.

Lastly take the local terms to have Haar eigenvectors but with random eigenvalues ± 1 , i.e., $H_{l,l+1} = Q_l^T \Lambda_l Q_l$, where Λ_l is a diagonal matrix whose elements are binary random variables ± 1 (Figure 2.6.2).

In this case the classical treatment of the local terms leads to a binomial distribution. As expected $p = 1$ in Figure 2.6.2 has three atoms at $-2, 0, 2$ corresponding to the randomized sum of the eigenvalues from the two local terms. The exact diagonalization, however, shows that the quantum chain has a much richer structure closer to iso; i.e, $p = 0$. This is captured quite well by IE with $p = 0.046$.

2.7 Beyond Nearest Neighbors Interaction: $L > 2$

If one fixes all the parameters in the problem and compares $L > 2$ with nearest neighbor interactions, then one expects the former to act more isotropic as the number of random parameters in Eq. 2.1.1 are more. When the number of random parameters introduced by the local terms, i.e., $(N - L + 1) d^L$ and d^N are comparable, we find that we can approximate the spectrum with a high accuracy by taking the summands to be all isotropic[55] (See Figures 2.7.1-2.7.3).

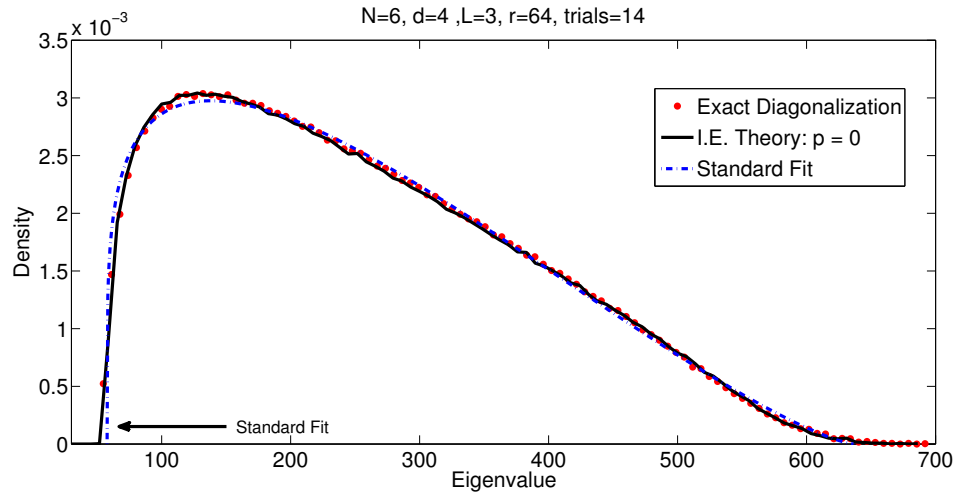

Figure 2.7.1: IE method approximates the quantum spectrum by $H^{IE} = \sum_{l=1}^4 Q_l^T H_{l, \dots, l+2} Q_l$

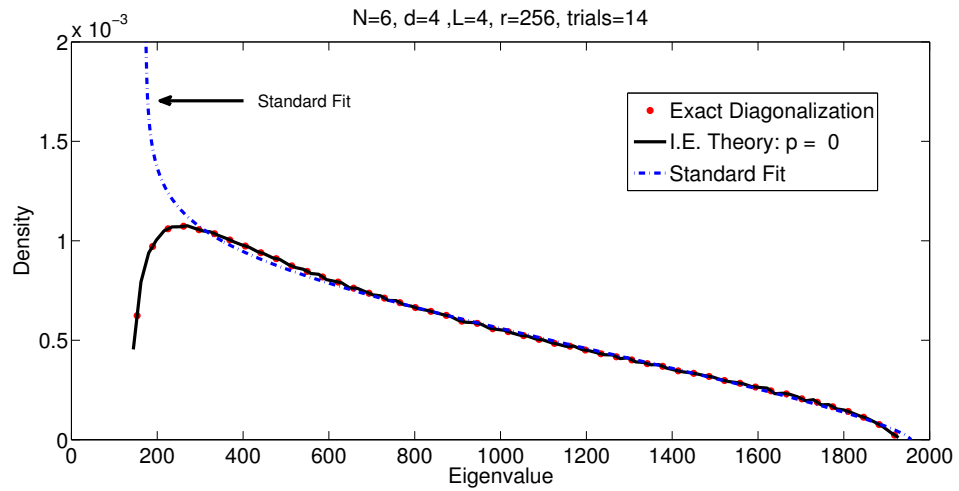

Figure 2.7.2: IE method approximates the quantum spectrum by $H^{IE} = \sum_{l=1}^3 Q_l^T H_{l, \dots, l+3} Q_l$.

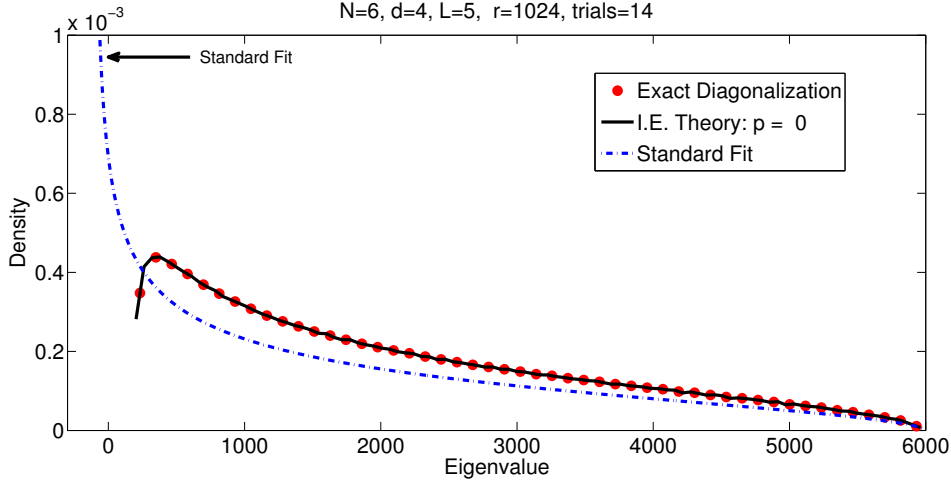

Figure 2.7.3: IE method approximates the quantum spectrum by $H^{IE} = \sum_{l=1}^2 Q_l^T H_{l,\dots,l+4} Q_l$

Most distributions built solely from the first four moments, would give smooth curves. Roughly speaking, the mean indicates the center of the distribution, variance its width, skewness its bending away from the center and kurtosis how tall and skinny versus how short and fat the distribution is. Therefore, it is hard to imagine that the kinks, cusps and local extrema of the quantum problem (as seen in some of our examples and in particular Figure in 2.6.2) could be captured by fitting only the first four moments of the QMBS Hamiltonian to a known distribution. It is remarkable that a one parameter (i.e., p) interpolation between the isotropic and classical suffices in capturing the richness of the spectra of QMBS.

2.8 Conjectures and Open Problems

In this paper we have offered a method that successfully captures the density of states of QMBS with generic local interaction with an accuracy higher than one expects solely from the first four moments. We would like to direct the reader's attention to open problems that we believe are within reach.

1. We conjecture that the higher moments may be analyzed for their significance. For example, one can show that the fraction of departing terms in the expansion of the higher moments (e.g. analogous to bold faced and underlined terms in Eqs. 2.4.4,2.4.6 but for higher moments) is asymptotically upper bounded by $1/N^3$. In Section2.2.3 we conjectured that their expectation values would not change the moments significantly. It would be of interest to know if

$$\begin{aligned} \mathbb{E}\text{Tr} \{ \dots Q^{-1} B^{\geq 1} Q A^{\geq 1} Q^{-1} B^{\geq 1} Q \dots \} &\leq \\ \mathbb{E}\text{Tr} \{ \dots Q_q^{-1} B^{\geq 1} Q_q A^{\geq 1} Q_q^{-1} B^{\geq 1} Q_q \dots \} &\leq \\ \mathbb{E}\text{Tr} \{ \dots \Pi^{-1} B^{\geq 1} \Pi A^{\geq 1} \Pi^{-1} B^{\geq 1} \Pi \dots \} &\quad . \end{aligned}$$

For example, one wonders if

$$\mathbb{E}\text{Tr} \left\{ (AQ^{-1}BQ)^k \right\} \leq \mathbb{E}\text{Tr} \left\{ (AQ_q^{-1}BQ_q)^k \right\} \leq \mathbb{E}\text{Tr} \left\{ (A\Pi^{-1}B\Pi)^k \right\}$$

for $k > 2$; we have proved that the inequality becomes an equality for $k = 1$ (Departure Theorem) and holds for $k = 2$ (Slider Theorem).

2. Though we focus on a decomposition for s , we believe that the main theorems may generalize to higher dimensional graphs. Further rigorous and numerical work in higher dimensions would be of interest.
3. At the end of Section 2.4.4 we proposed that more general local terms might be treated by explicitly including the extra terms (Type I terms).
4. Application of this method to slightly disordered systems would be of interest in CMP. In this case, the assumption of fully random local terms needs to be relaxed.
5. In our numerical work, we see that the method gives accurate answers in the presence of an external field. It would be nice to formally extend the results

and calculate thermodynamical quantities.

6. We derived our results for general β but numerically tested $\beta = 1, 2$. We acknowledge that general β remains an abstraction.
7. Readers may wonder whether it is better to consider “iso” or the infinite limit which is “free”. We have not fully investigated these choices, and it is indeed possible that one or the other is better suited for various purposes.
8. A grander goal would be to apply the ideas of this paper to very general sums of matrices.

2.9 Appendix

To help the reader with the random quantities that appear in this paper, we provide explanations of the exact nature of the random variables that are being averaged. A common assumption is that we either assume a uniformly randomly chosen eigenvalue from a random matrix or we assume a collection of eigenvalues that may be randomly ordered, Random ordering can be imposed or a direct result of the eigenvector matrix having the right property. Calculating each of the terms separately and then subtracting gives the same results.

$$\frac{1}{m} \mathbb{E} \left[\text{Tr} (A Q^T B Q)^2 \right] = \frac{1}{m} \mathbb{E} \left\{ \sum_{1 \leq i_1, i_2, j_1, j_2 \leq m} a_{i_1} a_{i_2} b_{j_1} b_{j_2} (q_{i_1 j_1} q_{i_1 j_2} q_{i_2 j_1} q_{i_2 j_2}) \right\}, \quad (2.9.1)$$

where a_i and b_j are elements of matrices A and B respectively. The right hand side of Eq. 2.9.1 can have terms with two collisions (i.e., $i_1 = i_2$ and $j_1 = j_2$), one collision (i.e. $i_1 \neq i_2$ exclusive-or $j_1 \neq j_2$), or no collisions (i.e., $i_1 \neq i_2$ and $j_1 \neq j_2$). Our goal now is to group terms based on the number of collisions. The pre-factors for two, one and no collisions along with the counts are summarized in Table 2.4. Using the latter we can sum the three types of contributions, to get the expectation

$$\begin{aligned} \frac{1}{m} \mathbb{E} \left[\text{Tr} (A Q^T B Q)^2 \right] &= \frac{(\beta+2)}{(m\beta+2)} \mathbb{E} (a^2) \mathbb{E} (b^2) + \\ \frac{\beta(m-1)}{(m\beta+2)} [\mathbb{E} (b^2) \mathbb{E} (a_1 a_2) + \mathbb{E} (a^2) \mathbb{E} (b_1 b_2)] &- \frac{\beta(m-1)}{(m\beta+2)} \mathbb{E} (a_1 a_2) \mathbb{E} (b_1 b_2). \end{aligned} \quad (2.9.2)$$

If we take the local terms to be from the same distribution we can further express the foregoing equation

$$\frac{1}{m} \mathbb{E} \left[\text{Tr} (A Q^T B Q)^2 \right] = \frac{1}{(m\beta+2)} [(\beta+2) m_2^2 + \beta(m-1) \mathbb{E} (a_1 a_2) \{2m_2 - \mathbb{E} (a_1 a_2)\}]. \quad (2.9.3)$$

The quantity of interest is the difference of the classical and the iso (see Eq. 2.4.8),

$$\begin{aligned} \frac{1}{m} \mathbb{E} \text{Tr} (A \Pi^T B \Pi)^2 - \frac{1}{m} \mathbb{E} \text{Tr} (A Q^T B Q)^2 &= \\ \frac{\beta(m-1)}{(m\beta+2)} \{ \mathbb{E} (a^2) \mathbb{E} (b^2) - \mathbb{E} (b^2) \mathbb{E} (a_1 a_2) - \mathbb{E} (a^2) \mathbb{E} (b_1 b_2) + \mathbb{E} (a_1 a_2) \mathbb{E} (b_1 b_2) \} &= \\ \frac{\beta(m-1)}{(m\beta+2)} \left\{ m_2^{(A)} m_2^{(B)} - m_2^{(B)} m_{1,1}^{(A)} - m_2^{(A)} m_{1,1}^{(B)} + m_{1,1}^{(A)} m_{1,1}^{(B)} \right\} &= \\ \frac{\beta(m-1)}{(m\beta+2)} \left(m_2^{(A)} - m_{1,1}^{(A)} \right) \left(m_2^{(B)} - m_{1,1}^{(B)} \right) &= \end{aligned} \quad (2.9.4)$$

If we assume that the local terms have the same distribution: $m_2 \equiv m_2^{(A)} = m_2^{(B)}$, $m_{1,1} \equiv m_{1,1}^{(A)} = m_{1,1}^{(B)}$ as in Eq. 2.9.3, the foregoing equation simplifies to

$$\frac{1}{m} \mathbb{E} \text{Tr} (A \Pi^T B \Pi)^2 - \frac{1}{m} \mathbb{E} \text{Tr} (A Q^T B Q)^2 = \frac{\beta(m-1)}{(m\beta+2)} (m_2 - m_{1,1})^2.$$

In the example of Wishart matrices as local terms we have

$$\begin{aligned} m_2 &\equiv \mathbb{E} (a^2) = rk (rk + n + 1) \\ m_{1,1} &\equiv \mathbb{E} (a_1 a_2) = k(k-1)r^2 + \frac{kr}{m-1} \left\{ (tn^{k-1} - 1)(n+r+1) + tn^{k-1}(n-1)(r-1) \right\} \\ &= k(k-1)r^2 + \frac{kr}{m-1} \left\{ tn^{k-1}(nr+2) - n - r - 1 \right\}. \end{aligned} \quad (2.9.5)$$

Chapter 3

Calculating the Density of States in Disordered Systems Using Free Probability

In the previous chapter we saw that when a decomposition into two commuting subsets is possible, one can with a high accuracy obtain the density of states of quantum spin chains. Spin chains that we discussed do not possess transport properties such as hopping of electrons. In this chapter we like to extend the ideas of decomposing the Hamiltonian to 'easier' pieces and treat different systems. In particular we will focus on one particle hopping random Schrödinger operator. What follows in the rest of this chapter also appears in [56].

3.1 Introduction

Disordered materials have long been of interest for their unique physics such as localization [57, 58], anomalous diffusion [59, 60] and ergodicity breaking [61]. Their properties have been exploited for applications as diverse as quantum dots [62, 63], magnetic nanostructures [64], disordered metals [65, 66], and bulk heterojunction photovoltaics [67, 68, 69]. Despite this, theoretical studies have been complicated by the need to calculate the electronic structure of the respective systems in the presence of random external potentials. Conventional electronic structure theories can only be used in conjunction with explicit sampling of thermodynamically accessible regions of phase space, which make such calculations enormously more expensive than usual single-point calculations [70].

Alternatively, we aim to characterize the ensemble of electronic Hamiltonians that arise from statistical sampling directly using random matrix theory; this would in principle allow us to sidestep the cost of explicit statistical sampling. This naturally raises the question of whether accurate approximations can be made for various characteristics of random Hamiltonians such as their densities of state (DOSs). We use techniques from free probability theory, which allow the computation of eigenvalues of sums of certain matrices [71]. While this has been proposed as a tool applicable to general random matrices [72] and has been used for similar purposes in quantum chromodynamics [73], we are not aware of any quantification of the accuracy of this approximation in practice. We provide herein a general framework for quantitatively estimating the error in such situations.

3.2 Quantifying the error in approximating a PDF using free probability

We propose to quantify the deviation between two PDFs using moment expansions. Such expansions are widely used to describe corrections to the central limit theorem and deviations from normality, and are often applied in the form of Gram–Charlier and Edgeworth series [74, 75]. Similarly, deviations from non-Gaussian reference PDFs can be quantified using generalized moment expansions. For two PDFs $w(\xi)$ and $\tilde{w}(\xi)$ with finite cumulants $\kappa_1, \kappa_2, \dots$ and $\tilde{\kappa}_1, \tilde{\kappa}_2, \dots$, and moments μ_1, μ_2, \dots and $\tilde{\mu}_1, \tilde{\mu}_2, \dots$ respectively, we can define a formal differential operator which transforms \tilde{w} into w and is given by [76, 74]

$$w(\xi) = \exp \left[\sum_{n=1}^{\infty} \frac{\kappa_n - \tilde{\kappa}_n}{n!} \left(-\frac{d}{d\xi} \right)^n \right] \tilde{w}(\xi). \quad (3.2.1)$$

This operator is parameterized completely by the cumulants of both distributions.

The first k for which the cumulants κ_k and $\tilde{\kappa}_k$ differ then allows us to define a degree to which the approximation $w \approx \tilde{w}$ is valid. Expanding the exponential and using the well-known relationship between cumulants and moments allows us to state that if the first $k - 1$ cumulants agree, but the k th cumulants differ, that this is equivalent to specifying that

$$w(\xi) = \tilde{w}(\xi) + \frac{\mu_k - \tilde{\mu}_k}{k!} (-1)^k \tilde{w}^{(k)}(\xi) + O(\tilde{w}^{(k+1)}). \quad (3.2.2)$$

At this point we make no claim on the convergence of the series defined by the expansion of (3.2.1), but use it as a justification for calculating the error term defined in (3.2.2). We will examine this claim later.

3.3 The free convolution

We now take the PDFs to be DOSs of random matrices. For a random matrix Z , the DOS is defined in terms of the eigenvalues $\{\lambda_n^{(m)}\}$ of the M samples $Z_1, \dots, Z_m, \dots, Z_M$ according to

$$\rho^{(Z)}(\xi) = \lim_{M \rightarrow \infty} \frac{1}{M} \sum_{m=1}^M \frac{1}{N} \sum_{n=1}^N \delta(\xi - \lambda_n^{(m)}). \quad (3.3.1)$$

The central idea to our approximation scheme is to split the Hamiltonian $H = A + B$ into two matrices A and B whose DOSs, $\rho^{(A)}$ and $\rho^{(B)}$ respectively, can be determined easily. The eigenvalues of the sum is in general not the sum of the eigenvalues. Instead, we propose to approximate the exact DOS with the free convolution $A \boxplus B$, i.e. $\rho^{(H)} \approx \rho^{(A \boxplus B)}$, a particular kind of “sum” which can be calculated without exact diagonalization of H . The moment expansion presented above quantifies the error of this approximation in terms of the onset of discrepancies between the k th moment of the exact DOS, $\mu_k^{(H)}$, and that for the free approximant $\mu_k^{(A \boxplus B)}$. By definition, the exact moments are

$$\mu_k^{(H)} = \mu_k^{(A+B)} = \left\langle (A + B)^k \right\rangle, \quad (3.3.2)$$

where $\langle Z \rangle = \mathbb{E} \text{Tr} (Z) / N$ denotes the normalized expected trace (NET) of the $N \times N$ matrix Z . The k th moment can be expanded using the (noncommutative) binomial expansion of $(A + B)^k$; each resulting term will have the form of a joint moment $\langle A^{n_1} B^{m_1} \dots A^{n_r} B^{m_r} \rangle$ with each exponent n_s, m_s being a positive integer such that $\sum_{s=1}^r (n_s + m_s) = k$. The free convolution $\tilde{\mu}_k$ is defined similarly, except that A and B are assumed to be freely independent, and therefore that each term must obey, by

definition [77], relations of the form

$$0 = \langle \prod_{s=1}^r (A^{n_s} - \langle A^{n_s} \rangle) (B^{m_s} - \langle B^{m_s} \rangle) \rangle \quad (3.3.3a)$$

$$= \langle \prod_{s=1}^r A^{n_s} B^{m_s} \rangle + \text{lower order terms}, \quad (3.3.3b)$$

where the degree k is the sum of exponents n_s, m_s and the second equality is formed by expanding the first line using linearity of the NET. Note for $k \leq 3$ that this is identical to the statement of (classical) independence [77]. Testing for $\mu_k^{(A+B)} \neq \mu_k^{(A \boxplus B)}$ then reduces to testing whether each centered joint moment of the form in (3.3.3a) is statistically nonzero. The cyclic permutation invariance of the NET means that the enumeration of all the centered joint moments of degree k is equivalent to the combinatorial problem of generating all binary necklaces of length k , for which efficient algorithms exist [80].

The procedure we have described above allows us to ascribe a degree k to the approximation $\rho^{(H)} \approx \rho^{(A \boxplus B)}$ given the splitting $H = A + B$. For each positive integer n , we generate all unique centered joint moments of degree n , and test if they are statistically nonzero. The lowest such n for which there exists at least one such term is the degree of approximation k . We expect that $k \geq 4$ in most situations, as the first three moments of the exact and free PDFs match under very general conditions [81]. However, we have found examples, as described in the next section, where it is possible to do considerably better than degree 4.

3.4 Decomposition of the Anderson Hamiltonian

As an illustration of the general method, we focus on Hamiltonians of the form

$$H = \begin{pmatrix} h_1 & J & & \\ J & h_2 & \ddots & \\ & \ddots & \ddots & J \\ & & J & h_N \end{pmatrix}, \quad (3.4.1)$$

where J is constant and the diagonal elements h_i are identically and independently distributed (iid) random variables with probability density function (PDF) $p_h(\xi)$. This is a real, symmetric tridiagonal matrix with circulant (periodic) boundary conditions on a one-dimensional chain. Unless otherwise stated, we assume herein that h_i are normally distributed with mean 0 and variance σ^2 . We note that σ/J gives us a dimensionless order parameter to quantify the strength of disorder.

So far, we have made no restrictions on the decomposition scheme $H = A + B$ other than $\rho^{(A)}$ and $\rho^{(B)}$ being easily computable. A natural question to pose is whether certain choices of decompositions are intrinsically superior to others. For the Anderson Hamiltonian, we consider two reasonable partitioning schemes:

$$H = A_1 + B_1 = \begin{pmatrix} h_1 & & & \\ & h_2 & & \\ & & h_3 & \\ & & & \ddots \end{pmatrix} + \begin{pmatrix} 0 & J & & \\ J & 0 & J & \\ & J & 0 & \ddots \\ & & \ddots & \ddots \end{pmatrix} \quad (3.4.2a)$$

$$H = A_2 + B_2 = \begin{pmatrix} h_1 & J & & & \\ J & 0 & & & \\ & & h_3 & J & \\ & & J & 0 & \\ & & & & \ddots \end{pmatrix} + \begin{pmatrix} 0 & & & & \\ & h_2 & J & & \\ & J & 0 & & \\ & & & h_4 & \cdots \\ & & & \vdots & \ddots \end{pmatrix}. \quad (3.4.2b)$$

We refer to these as Scheme I and II respectively. For both schemes, each fragment matrix on the right hand side has a DOS that is easy to determine. In Scheme I, we have $\rho_{A_1} = p_h$. B_1 is simply J multiplied by the adjacency matrix of a one-dimensional chain, and therefore has eigenvalues $\lambda_n = 2J \cos(2n\pi/N)$ [82]. Then the DOS of B_1 is $\rho_{B_1}(\xi) = \sum_{n=1}^N \delta(\xi - \lambda_n)$ which converges as $N \rightarrow \infty$ to the arcsine distribution with PDF $p_{AS}(\xi) = 1/(\pi\sqrt{4J^2 - \xi^2})$ on the interval $[-2|J|, 2|J|]$. In Scheme II, we have that $\rho_{A_2} = \rho_{B_2} = \rho_X$ where ρ_X is the DOS of $X = \begin{pmatrix} h_1 & J \\ J & 0 \end{pmatrix}$. Since X has eigenvalues $\epsilon_{\pm}(\xi) = h_1(\xi)/2 \pm \sqrt{h_1^2(\xi)/4 + J^2}$, their distribution can be calculated to be

$$\rho_X(\xi) = \left(1 + \frac{J^2}{\xi^2}\right) p_h\left(\xi - \frac{J^2}{\xi}\right). \quad (3.4.3)$$

3.5 Numerical free convolution

We now calculate the free convolution $A \boxplus B$ numerically by sampling the distributions of A and B . We define $\rho^{(A \boxplus B)}$ as simply the average DOS of the free approximant $Z = A + Q^{-1}BQ$, where Q is a $N \times N$ random matrix of Haar measure. For real symmetric Hamiltonians it is sufficient to consider orthogonal matrices Q , which can be generated from the QR decomposition of a Gaussian orthogonal matrix [78]. (This can be generalized readily to unitary and symplectic matrices for complex and

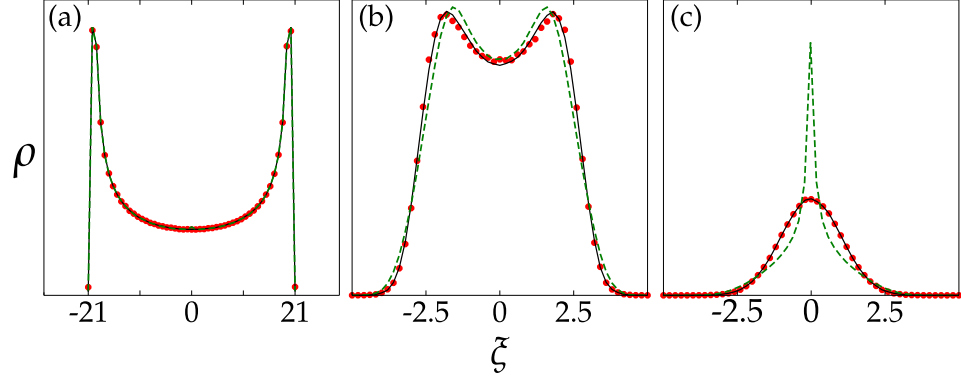

Figure 3.5.1: Calculation of the DOS, $\rho(\xi)$, of the Hamiltonian H of (3.4.1) with $M = 5000$ samples of 2000×2000 matrices for (a) low, (b) moderate and (c) high noise ($\sigma/J=0.1, 1$ and 10 respectively with $\sigma = 1$). For each figure we show the results of free convolution defined in Scheme I ($\rho^{(A_1 \boxplus B_1)}$; black solid line), Scheme II ($\rho^{(A_2 \boxplus B_2)}$; green dashed line) and exact diagonalization ($\rho^{(H)}$; red dotted line).

quaternionic Hamiltonians respectively.) In the $N \rightarrow \infty$ limit, this converges to the free convolution $A \boxplus B$ [71, 79].

The exact DOS $\rho^{(A+B)}$ and free approximant $\rho^{(A \boxplus B)}$ are plotted in Figure 3.5.1(a)–(c) for both schemes for low, moderate and high noise regimes ($\sigma/J = 0.1, 1, 10$ respectively).

We observe that for Scheme I we have excellent agreement between $\rho^{(H)}$ and $\rho^{(A_1 \boxplus B_1)}$ across all values of σ/J , which is evident from visual inspection; in contrast, Scheme II shows variable quality of fit.

We can understand the starkly different behaviors of the two partitioning schemes using the procedure outlined above to analyze the accuracy of the approximations $\rho^{(H)} \approx \rho^{(A_1 \boxplus B_1)}$ and $\rho^{(H)} \approx \rho^{(A_2 \boxplus B_2)}$. For Scheme I, we observe that the approximation (3.2.2) is of degree $k = 8$; the discrepancy lies solely in the term $\langle (A_1 B_1)^4 \rangle$ [83]. Free probability expects this term to vanish, since both A_1 and B_1 are centered (i.e. $\langle A_1 \rangle = \langle B_1 \rangle = 0$) and hence must satisfy (3.3.3b) with

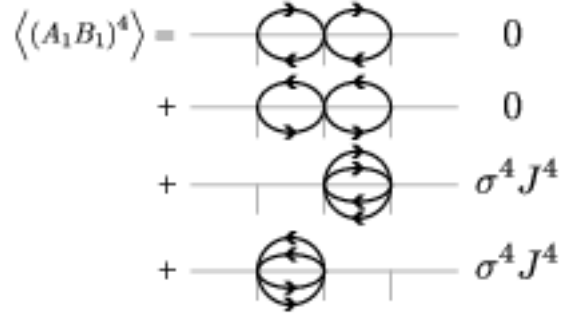

Figure 3.5.2: Diagrammatic expansion of the term $\langle A_1 B_1 A_1 B_1 A_1 B_1 A_1 B_1 \rangle$ in terms of allowed paths dictated by the matrix elements of A_1 and B_1 of Scheme I in (3.4.2a).

$n_1 = m_1 = \dots = n_4 = m_4 = 1$. In contrast, we can calculate its true value from the definitions of A_1 and B_1 . By definition of the NET $\langle \cdot \rangle$, only closed paths contribute to the term. Hence, only two types of terms can contribute to $\langle (A_1 B_1)^4 \rangle$; these are expressed diagrammatically in Figure 3.5.2. The matrix A_1 weights each path by a factor of h , while B_1 weights each path by J , and in addition forces the path to hop to an adjacent site.

Consequently, we can write explicitly

$$\begin{aligned}
\langle (A_1 B_1)^4 \rangle &= \frac{1}{N} \sum_i \mathbb{E} (h_i J h_{i-1} J h_i J h_{i+1} J) \\
&\quad + \frac{1}{N} \sum_i \mathbb{E} (h_i J h_{i+1} J h_i J h_{i-1} J) \\
&\quad + \frac{1}{N} \sum_i \mathbb{E} (h_i J h_{i-1} J h_i J h_{i-1} J) \\
&\quad + \frac{1}{N} \sum_i \mathbb{E} (h_i J h_{i+1} J h_i J h_{i+1} J) \\
&= 2J^4 \mathbb{E} (h_i)^2 \mathbb{E} (h_i^2) + 2J^4 \mathbb{E} (h_i^2)^2 = 0 + 2J^4 \sigma^4, \quad (3.5.1)
\end{aligned}$$

where the second equality follows from the independence of the h_i 's. As this is

the only source of discrepancy at the eighth moment, this explains why the agreement between the free and exact PDFs is so good, as the leading order correction is in the eighth derivative of $\rho^{(A_1 \boxplus B_1)}$ with coefficient $2\sigma^4 J^4 / 8! = (\sigma J)^4 / 20160$. In contrast, we observe for Scheme II that the leading order correction is at $k = 4$, where the discrepancy lies in $\langle A_2^2 B_2^2 \rangle$. Free probability expects this to be equal to $\langle A_2^2 B_2^2 \rangle = \langle A_2^2 \rangle \langle B_2^2 \rangle = \langle X^2 \rangle^2 = (J^2 + \sigma^2 / 2)^2$, whereas the exact value of this term is $J^2 (J^2 + \sigma^2)$. Therefore the discrepancy is in the fourth derivative of $\rho^{(A \boxplus B)}$ with coefficient $(-\sigma^4 / 4) / 4! = -\sigma^4 / 96$.

3.6 Analytic free convolution

Free probability allows us also to calculate the limiting distributions of $\rho^{(A \boxplus B)}$ in the macroscopic limit of infinite matrix sizes $N \rightarrow \infty$ and infinite samples $M \rightarrow \infty$. In this limit, the DOS $\rho^{(A \boxplus B)}$ is given as a particular type of integral convolution of $\rho^{(A)}$ and $\rho^{(B)}$. We now calculate the free convolution analytically in the macroscopic limit for the two partitioning schemes discussed above, thus sidestepping the cost of sampling and matrix diagonalization altogether.

For our first example, we take A and B as in Scheme I, but with each iid h_i following a Wigner semicircle distribution with PDF $p_W(\xi) = \sqrt{4 - \xi^2} / 4\pi$ on the interval $[-2, 2]$. (Using semicircular noise instead of Gaussian noise simplifies the analytic calculation considerably.) Then, $\rho^{(A)} = p_W$ and $\rho^{(B)} = p_{AS}$. The key tool to performing the free convolution analytically is the R -transform $r(w) = g^{-1}(w) - w^{-1}$ [84], where g^{-1} is defined implicitly via the Cauchy transform

$$w = \int_{\mathbb{R}} \frac{\rho(\xi)}{g^{-1}(w) - \xi} d\xi. \quad (3.6.1)$$

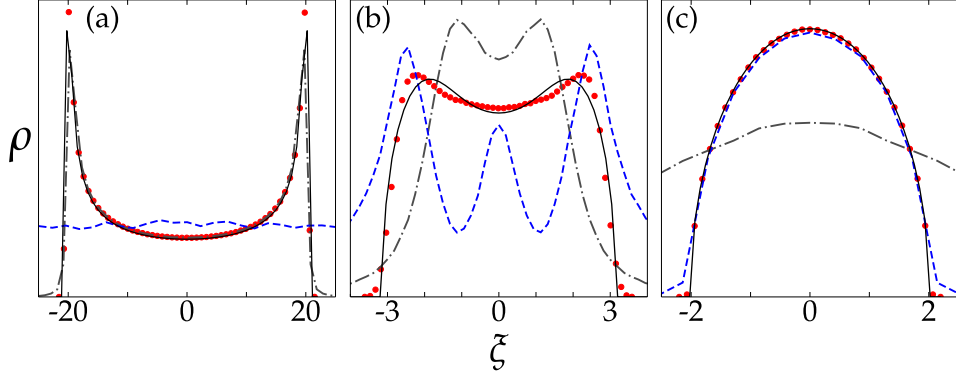

Figure 3.6.1: DOS, $\rho(\xi)$, of the Hamiltonian (3.4.1) with $M = 5000$ samples of 2000×2000 matrices with (a) low, (b) moderate and (c) high semicircular on-site noise ($\sigma/J=0.1, 1$ and 10 respectively with $\sigma = 1$), as calculated with exact diagonalization (red dotted line), free convolution (black solid line), and perturbation theory with A_1 as reference (blue dashed line) and B_1 as reference (gray dash-dotted line). The partitioning scheme is Scheme I of (3.4.2a).

For freely independent A and B , the R -transforms linearize the free convolution, i.e. $r^{(A \boxplus B)}(w) = r^{(A)}(w) + r^{(B)}(w)$, and that the PDF can be recovered from the Plemelj–Sokhotsky inversion formula by

$$\rho^{(A \boxplus B)}(\xi) = \frac{1}{\pi} \text{Im} \left(\left(g^{(A \boxplus B)} \right)^{-1}(\xi) \right) \quad (3.6.2a)$$

$$g^{(A \boxplus B)}(w) = r^{(A \boxplus B)}(w) + w^{-1}. \quad (3.6.2b)$$

Applying this to Scheme I, we have $r^{(A)}(w) = w$ and $r^{(B)}(w) = (-1 + \sqrt{4J^2 + w^2})/w$, so that $g^{(A \boxplus B)}(w) = w + (\sqrt{4J^2 + w^2})/w$. The need to calculate the functional inverse $(g^{(A \boxplus B)})^{-1}$ in this procedure unfortunately precludes our ability to write $\rho^{(A \boxplus B)}(\xi)$ in a compact closed form; nevertheless, the inversion can be calculated numerically. We present calculations of the DOS as a function of noise strength σ/J in Figure 3.6.1.

3.7 Comparison with other approximations

For comparative purposes, we also performed calculations using standard second-order matrix perturbation theory [85] for both partitioning schemes. The results are also shown in Figure 3.6.1. Unsurprisingly, perturbation theory produces results that vary strongly with σ/J , and that the different series, based on whether A is considered a perturbation of B or vice versa, have different regimes of applicability. Furthermore it is clear even from visual inspection that the second moment of the DOS calculated using second-order perturbation theory is in general incorrect. In contrast, the free convolution produces results with a more uniform level of accuracy across the entire range of σ/J , and that we have at least the first three moments being correct [81].

It is also natural to ask what mean-field theory, another standard tool, would predict. Interestingly, the limiting behavior of Scheme I as $N \rightarrow \infty$ is equivalent to a form of mean-field theory known as the coherent potential approximation (CPA) [86, 87, 88] in condensed matter physics, and is equivalent to the Blue's function formalism in quantum chromodynamics for calculating one-particle irreducible self-energies [73]. The breakdown in the CPA in the term $\langle (A_1 B_1)^4 \rangle$ is known [89, 57]; however, to our knowledge, the magnitude of the deviation was not explained. In contrast, our error analysis framework affords us such a quantitative explanation.

Finally, we discuss the predictions of isotropic entanglement theory, which proposes a linear interpolation between the classical convolution

$$\rho^{(A*B)}(\xi) = \int_{-\infty}^{\infty} \rho^{(A)}(\xi) \rho^{(B)}(x - \xi) dx$$

and the free convolution $\rho^{(A\boxplus B)}(\xi)$ in the fourth cumulant [81, 90]. The classi-

cal convolution can be calculated directly from the random matrices A and B ; by diagonalizing the matrices as $A = Q_A^{-1}\Lambda_A Q_A$ and $B = Q_B^{-1}\Lambda_B Q_B$, the classical convolution $\rho^{(A*B)}(\xi)$ can be computed from the eigenvalues of random matrices of the form $Z_{cl} = \Lambda_A + \Pi^{-1}\Lambda_B\Pi$ where Π is a $N \times N$ random permutation matrix. It is instructive to compare this with the free convolution, which can be sampled from matrices of the form $Z' = \Lambda_A + Q^{-1}\Lambda_B Q$, which can be shown by orthogonal invariance of the Haar measure random matrices Q to be equivalent to sampling matrices of the form $Z = A + Q^{-1}BQ$ described previously.

As discussed previously, the lowest three moments of Z and H are identical; this turns out to be true also for Z_{cl} [81]. Therefore IE proposes to interpolate via the fourth cumulant, with interpolation parameter p defined as

$$p = \frac{\kappa_4^{(H)} - \kappa_4^{(A\boxplus B)}}{\kappa_4^{(A*B)} - \kappa_4^{(A\boxplus B)}} \quad (3.7.1)$$

We observe that IE appears to always favor the free convolution limit ($p = 0$) as opposed to the classical limit ($p = 1$); this is not surprising as we know from our previous analysis that $\kappa_4^{(H)} = \kappa_4^{(A\boxplus B)}$, and that the agreement with the exact diagonalization result is excellent regardless of σ/J . In Scheme II, we observe the unexpected result that p can sometimes be negative and that the agreement varies with σ/J . From the moment expansion we understand why; we have that the first three moments match while $\kappa_4^{(A_2+B_2)} - \kappa_4^{(A_2\boxplus B_2)} = -\sigma^4/4$. The discrepancy lies in the term $\langle A_2^2 B_2^2 \rangle$ which is expected to have the value $\langle A_2^2 \rangle \langle B_2^2 \rangle = (J^2 + \sigma^2/2)^2$ in free probability but instead has the exact value $J^2 (J^2 + \sigma^2)$. Furthermore, we have that $\kappa_4^{(A_2*B_2)} \neq \kappa_4^{(A_2\boxplus B_2)}$ where the only discrepancy lies in the so-called departing term $\langle A_2 B_2 A_2 B_2 \rangle$ [81, 90]. This term contributes 0 to $\kappa_4^{(A\boxplus B)}$ but has value $\langle A_2^2 \rangle \langle B_2^2 \rangle =$

$(J^2 + \sigma^2/2)^2$ in $\kappa_4^{(A_2*B_2)}$, since for the classical convolution we have that

$$\langle \Pi_{s=1}^r (A_2^{n_s} B_2^{m_s}) \rangle = \left\langle A_2^{\sum_{s=1}^r n_s} \right\rangle \left\langle B_2^{\sum_{s=1}^r m_s} \right\rangle. \quad (3.7.2)$$

This therefore explains why we observe a negative p , as this calculation shows that

$$p = \frac{\kappa_4^{(A_2+B_2)} - \kappa_4^{(A_2\boxplus B_2)}}{\kappa_4^{(A_2*B_2)} - \kappa_4^{(A_2\boxplus B_2)}} = -2 \left(2 \left(\frac{\sigma}{J} \right)^{-2} + 1 \right)^{-2} \quad (3.7.3)$$

which is manifestly negative.

In conclusion, we have demonstrated that the free probability of random matrices can provide unexpectedly accurate approximations for the DOS of disordered Hamiltonians, both for finite dimensional systems and in the macroscopic limit $N \rightarrow \infty$. Our results illustrate variable accuracies of the approximations predicated on our particular choices of partitioning schemes, which can be quantitatively estimated using moment expansions. These results represent an optimistic beginning to addressing the electronic structure of disordered condensed matter systems using the tools of random matrix theory. We are currently investigating the predictions of free probability on the localization properties of eigenvectors, as well as studying the general applicability of free probability to lattices in higher dimensions, as well as systems with off-diagonal and correlated disorder.

Part II

Eigenvectors

Chapter 4

Generic Quantum Spin Chains

In this chapter I discuss frustration free condition, evolution in time and imaginary time within MPS representation along with numerical methods. I then discuss the degeneracy and frustration free condition for generic quantum spin chains with local interactions. I leave the discussion of the entanglement of the ground states for the next chapter.

4.1 Frustration Free Condition

An L -local Hamiltonian where each interaction acts nontrivially on L particles can be written as

$$H = \sum_{i=1}^M H_i$$

where i indexes M groups of L spins. By spectral decomposition any such Hamiltonian on N spins each with d -states can be written as

$$H = m_g \lambda_g |g\rangle\langle g| + \sum_{\alpha=1}^{\alpha_{max}} \lambda_\alpha |\alpha\rangle\langle\alpha|, \text{ with } \alpha_{max} + m_g = d^N$$

where g refers to the ground state quantities, m_g the possible multiplicity due to degeneracy and α 's label the excited states. Similarly for each of the local terms

$$H_i = m_g^i \lambda_g^i |g_i\rangle\langle g_i| + \sum_{p=1}^r \lambda_p^i |v_i^p\rangle\langle v_i^p| \text{ with } r + m_g^i = d^L. \quad (4.1.1)$$

Energy is meaningful in a relative sense, hence one can shift the local Hamiltonian such that the ground state has energy zero. This defines an effective Hamiltonian H'_i

$$H'_i \equiv H_i - \lambda_g^i \mathbb{I}_{d^L} = \sum_{p=1}^r (\lambda_p^i - \lambda_g^i) |v_i^p\rangle\langle v_i^p|$$

The effective local Hamiltonian has zero energy ground states and eigenstates corresponding to the excited states with positive eigenvalues. By definition, $\lambda_p^i - \lambda_g^i > 0$ for all p , where we have not made as of yet any assumptions on the possible numerical values they can take. The span and Kernel of $H'_{s,t}$ is therefore the same as

$$H''_i = \sum_{p=1}^r |v_i^p\rangle\langle v_i^p|, \quad (4.1.2)$$

where we replaced all $\lambda_p^i - \lambda_g^i > 0$ by ones to get projectors of rank r as our local terms. As discussed at the end of this section, there are advantages in doing so. Locally there are $d^2 - r$ zero energy states; however, the projectors are not mutually exclusive. This makes the problem of counting the kernel of H non-trivial, namely we cannot assert that the number of ground states is $(d^2 - r)^M$. In particular the ground state of the global Hamiltonian may not be a local ground state of some local term(s): frustrated.

Lemma 4. *Suppose E_{gr}^1 and E_{gr}^2 are the smallest eigenvalues of Hamiltonians H^1 and H^2 respectively and $E_{gr}^{1,2}$ that of $H^1 + H^2$. Further, let E_{max}^1 and E_{max}^2 be the largest eigenvalues of Hamiltonians H^1 and H^2 respectively and $E_{max}^{1,2}$ that of $H^1 + H^2$ then*

$$\begin{aligned} E_{gr}^1 + E_{gr}^2 &\leq E_{gr}^{1,2} \\ E_{max}^1 + E_{max}^2 &\geq E_{max}^{1,2}. \end{aligned}$$

In the first (second) case equality holds if H^1 and H^2 have the same eigenstate for their smallest (largest) eigenvalues.

Proof. The proof follows from the fact that the average is greater than the least eigenvalue and smaller than the largest eigenvalue. Suppose we are in the states in which $H^1 + H^2$ takes the eigenvalue $E_{gr}^{1,2}$, then $\langle H^1 + H^2 \rangle = E_{gr}^{1,2}$, but $\langle H^1 + H^2 \rangle = \langle H^1 \rangle + \langle H^2 \rangle \geq E_{gr}^1 + E_{gr}^2$. The equality holds if H^1 and H^2 have the same eigenstate for their smallest eigenvalues. Similarly if we are in the state in which $H^1 + H^2$ takes the eigenvalue $E_{max}^{1,2}$, then $\langle H^1 + H^2 \rangle = E_{max}^{1,2}$, but $\langle H^1 + H^2 \rangle = \langle H^1 \rangle + \langle H^2 \rangle \leq E_{max}^1 + E_{max}^2$. The equality holds if H^1 and H^2 have the same eigenstate for their largest eigenvalues. \square

One can prove this using Rayleigh quotient or min-max theorems as well.

Therefore, the summation in the first Eq. 4.1.2 can result in “lifting” the global ground state relative to that of the local ones. We seek conditions under which global ground state has zero energy, i.e., remains “unlifted” (see Section 4.2 for motivation).

It is necessary and sufficient for a state to be the ground state if it is orthogonal to all the local terms H'_i because all the terms in the Hamiltonian will be zero. If the

local terms commute by the foregoing lemma the global and local ground states will be the same, i.e., $E_{gr}^{1,2} = E_{gr}^1 + E_{gr}^2 = 0 + 0 = 0$. This is too strong a requirement. It could be that the lowest eigenvectors of each summand are aligned, in which case the system is Frustration Free (FF) or unfrustrated. A classical analogue would be the ferromagnet.

Definition 1. The ground state is unfrustrated if it is also a common ground state of all of the local terms H_i .

Let us go back to Eq. 4.1.3 and investigate chains of d -dimensional quantum spins (qudits) on a line with nearest-neighbor interactions. The Hamiltonian of the system,

$$H = \sum_{k=1}^{N-1} H_{k,k+1} \quad (4.1.3)$$

is 2-local (each $H_{k,k+1}$ acts non-trivially only on two neighboring qudits). Our goal is to find the necessary and sufficient conditions for the quantum system to be *unfrustrated*

The local terms can be written as

$$H_{k,k+1} = E_0^{(k)} P_{k,k+1}^{(0)} + \sum_p E_p^{(k)} P_{k,k+1}^{(p)}, \quad (4.1.4)$$

where $E_0^{(k)}$ is the ground state energy of $H_{k,k+1}$ and each $P_{k,k+1}^{(p)}$ is a projector onto the subspace spanned by the eigenstates of $H_{k,k+1}$ with energy $E_p^{(k)}$. The question of existence of a common ground state of all the local terms is equivalent to asking the same question for a Hamiltonian whose interaction terms are

$$H'_{k,k+1} = \mathbb{I}_{1,\dots,k-1} \otimes P_{k,k+1} \otimes \mathbb{I}_{k+2,\dots,N}, \quad (4.1.5)$$

with $P_{k,k+1} = \sum_{p=1}^r P_{k,k+1}^{(p)}$ projecting onto the excited states of each original interaction term $H_{k,k+1}$. When this modified system is unfrustrated, its ground state energy is zero (all the terms are positive semi-definite). The unfrustrated ground state belongs to the intersection of the ground state subspaces of each original $H_{k,k+1}$ and is annihilated by all the projector terms.

As far as the question of (un)frustration and count of the ground states are concerned, Eq. 4.1.5 yields the same result as Eq. 4.1.4.

4.2 Why Care About Frustration Free Systems?

There are many models such as the Heisenberg ferromagnetic chain, AKLT, Parent Hamiltonians that are frustration free (FF) [116, 117, 44, 33]. Besides such models and the mathematical convenience of working with projectors as local terms, what is the significance of FF systems? In particular, do FF systems describe systems that can be realized in nature? Some answers can be given:

1. It has been proved in [106] all gapped Hamiltonians can be approximated by frustration free Hamiltonians if one allows for the range of interaction to be $\mathcal{O}(\log \mathcal{N})$. It is believed that any type of gapped ground state is adequately described by a frustration free model [44].
2. The ground state is stable against variation of the Hamiltonian against perturbations [95]

$$H(g) = \sum_k g_k H_{k,k+1}, \quad g_k \geq 0$$

as the kernels of the local terms remain invariant.

3. In quantum complexity theory the classical SAT problem is generalized to the

so called qSAT [103]. The qSAT problem is: Given a collection of k -local projectors on n qubits, is there a state $|\psi\rangle$ that is annihilated by all the projectors? Namely, is the system frustration free?

4. Ground states of frustration free Hamiltonians, namely MPS can be prepared by dissipation [94].

4.3 Why Does Imaginary Time Evolution Work?

By imaginary time evolution we mean $it \rightarrow \tau$. The Hamiltonian evolution becomes

$$e^{-itH}|\psi\rangle \rightarrow e^{-\tau H}|\psi\rangle.$$

Intuitively one might like to see imaginary time evolution as dissipation of energy such that for sufficiently long time the system relaxes to its lowest energy state. Mathematically, one can do a spectral decomposition $H = \sum_{\alpha} E_{\alpha} |\alpha\rangle\langle\alpha|$ where E_{α} are energies associated with states $|\alpha\rangle$. The imaginary time evolution

$$e^{-\tau H}|\psi\rangle = e^{-\tau \sum E_{\alpha} |\alpha\rangle\langle\alpha|}|\psi\rangle,$$

which implies an exponential suppression of the overlap of $|\psi\rangle$ with states that have energies higher than that of the ground state. My numerical implementation of the imaginary time evolution is the same as described in [96].

4.4 Numerical Study of Quantum Spin Chains Using MPS

Suppose we want to evolve the MPS representation of the quantum spin system, (to be explicit we include the Λ 's see Eq. 1.3.9) starting at time t

$$|\psi_t\rangle = \mathcal{P} \left\{ \bigotimes_{p=1}^{N-1} \Gamma_t(i_p) \Lambda_t^{(p)} |i_p\rangle \right\} \quad \text{OBC.}$$

The quantum mechanical time evolution in Δt is given by

$$|\psi_{t+\Delta t}\rangle = \left\{ \bigotimes_{p=1}^{N-1} \exp(-i\Delta t H_{p,p+1}) \right\} |\psi_t\rangle.$$

As in Chapter 2, we once again decompose the Hamiltonian into two pieces $H \equiv H_1 + H_2$, where $H_1 \equiv \sum_{p=1,3,\dots} H_{p,p+1}$ and $H_2 \equiv \sum_{p=2,4,\dots} H_{p,p+1}$ are made up of terms that all commute with one another. One can show [39, Exercise 4.47]

$$\begin{aligned} e^{-itH_1} &= e^{-itH_{1,2}} e^{-itH_{3,4}} \dots e^{-itH_{N-2,N-1}} \\ e^{-itH_2} &= e^{-itH_{2,3}} e^{-itH_{4,5}} \dots e^{-itH_{N-1,N}}. \end{aligned} \quad (4.4.1)$$

In order to evolve the system in time we need to make use of Trotter's formula [39, Thm 4.3]

Theorem. (*Trotter formula*) *Let A and B be Hermitian operators. Then for any real t ,*

$$e^{i(A+B)t} = \lim_{n \rightarrow \infty} (e^{iAt/n} e^{iBt/n})^n. \quad (4.4.2)$$

Among other things, one can use the proof of this theorem to show [39, see Eq. 4.103],

$$e^{iH\Delta t} = e^{iH_1\Delta t} e^{iH_2\Delta t} + \mathcal{O}(\Delta t^2) \quad (4.4.3)$$

where we used $A \equiv H_1$ and $B \equiv H_2$.

Using Eqs. 4.4.1 and 4.4.3

$$\psi_{t+\Delta t} \rangle = \left\{ \bigotimes_{p \text{ odd}} \exp(-i\Delta t H_{p,p+1}) \bigotimes_{p \text{ even}} \exp(-i\Delta t H_{p,p+1}) \right\} \psi_t \rangle + \mathcal{O}(\Delta t^2)$$

which implies that Trotterization and evolution in time can be implemented by evolving the even terms first and then the odd terms for small time intervals.

An advantage of MPS is that one can locally update the state [97, Lemma 2], i.e., apply the operator on the local terms n and $n+1$, we first define

$$\Theta_t^{i_n, i_{n+1}} \equiv \Gamma_t(i_n) \Lambda_t^{(n)} \Gamma_t(i_{n+1})$$

Let the imaginary time evolution operator be

$$V_{i'_n, i'_{n+1}}^{i_n, i_{n+1}} \equiv \exp\left(-\Delta t H_{i'_n, i'_{n+1}}^{i_n, i_{n+1}}\right),$$

which after the imaginary time evolution update reads

$$\Theta_{t+\Delta t}^{i_n, i_{n+1}} = V_{i'_n, i'_{n+1}}^{i_n, i_{n+1}} \Theta_t^{i'_n, i'_{n+1}} \quad (4.4.4)$$

To get the updated Matrix Products we use SVD

$$\Gamma_{t+\Delta t}(i_n) \Lambda_{t+\Delta t}^{(n)} \Gamma_{t+\Delta t}(i_{n+1}) \equiv \text{SVD} \left(\Theta_{t+\Delta t}^{i_n, i_{n+1}} \right) \quad (4.4.5)$$

The state after imaginary time evolution will in general not be normalized. As in [96], I normalize the state after every update step. The work in [96] was confined to translationally invariant chains with $d = 2$ where Γ 's and Λ 's could be taken to be the same at every site and bond respectively. I generalized the numerical code to implement the updates for any d and regardless of whether there was translational invariance. A major hinderance was implementation of Θ update (Eq. 4.4.4) in an efficient manner. I overcame this by first reshaping the matrices and applying the update rules followed by undoing of the reshaping. I then took the SVD to update the chain and normalized the state. This was done for every pair of nearest neighbors qudits in H_1 followed by updates on every pair of nearest neighbor qudits in H_2 (see the code in Algorithm 1). See the section 4.7 for further discussion and numerical results.

Algorithm 1 This code updates Eqs.4.4.4 and 4.4.5

```
% Ramis Movassagh
% April 2012
% All rights reserved
% * * * * *
% writing the portion of the code for calculating Theta and its update
function [state
lossnorm]=recomputeGL2_TestTrivial(ham,state,strength,bit1,bit2,bond_a)
global imaginartytime
global usesvd
global normbymultiplication
global cutofflambda

% interacts the bonds a connecting bit1 to bit2
% note: bond g is not interacted
%
%
%   b       a       c
% --- bit1 --- bit2 ---

X=state.Xmax;
dit = state.dit;
% hardcode the line here...
bond_b = bond_a - 1;
bond_c = bond_a + 1;
% bond indices in {bit1, bit2 & bit3}
a1=find(state.options.bonds(bit1,:)==bond_a);
b1=find(state.options.bonds(bit1,:)==bond_b);
a2=find(state.options.bonds(bit2,:)==bond_a);
c2=find(state.options.bonds(bit2,:)==bond_c);

% lambdas of interacting bonds
La=diag(state.L(bond_a,:));
Lb=state.L(bond_b,:);
Lc=state.L(bond_c,:);

% this is for the interaction of nearest sites. These are just the
gammas:

Hba = zeros(X,X,dit);
Hac = zeros(X,X,dit);
r = (1:dit);
Hba(:,r) = state.H(:,r,bit1); % This is Gamma_ab
Hac(:,r) = state.H(:,r,bit2); % This is Gamma_ac
% we need inverse vectors for La and Li
nonzeroLa = find(state.L(bond_a,*)>cutofflambda);
Lail=zeros(X,1);
Lail(nonzeroLa)=1./state.L(bond_a,nonzeroLa);
Lai = diag(Lail);
%   b       a       c
% --- bit1 --- bit2 ---
bb=expm(-strength.*ham(:,r,bit1)); % It is called V in the thesis
p=1;
ThetaVec = zeros(dit*dit*X*X,1);
theta_before = zeros(X,X,dit,dit);
for s = 1:dit
    for t= 1:dit
        %At every entry s,t Theta has a matrix that is X x X.
```

```

% You don't need to store this: FOR CHECKING
    %Theta = R;
    %Theta = Hba(:,:,s)*Lai*Hac(:,:,t);
    %theta_before(:,:,s,t) = Theta;
    theta_before(:,:,s,t) = Hba(:,:,s)*Lai*Hac(:,:,t);
    %SIZE_THETA=size(Theta)
    %Here Lai is the inverse of Lambda in between the sites. Hba
and
    %Hac are just the L Gamma L each.
    thetaInter = reshape(theta_before(:,:,s,t),[],1);
    ThetaVec((p-1)*X*X+1:p*X*X)=thetaInter;
    p=p+1;
end
end
Theta2 = reshape(ThetaVec,X*X,[]);
Theta2t = Theta2';
Theta_update = bb*Theta2t; % returns a dit^2, by X^2.
% Here every column contains a loop over spins (fixed pair of X)
theta_update2t = Theta_update'; % X^2 by dit^2
IND = size(theta_update2t);
thetaB = zeros(IND(2),X,X);
for i = 1:IND(2)
    thetaB(i,:,:) = reshape(theta_update2t(i,i),X,X);
end
theta_update_back = zeros(X,X,dit,dit);
% Need to make it a square with dimensions X*dit by X*dit
Theta_flat=zeros(dit*X,dit*X); % Will be the updated Theta
for s = 1:dit
    for t = 1:dit
        theta_update_back(:,:,s,t) = thetaB(k,:,:); % Can be omitted
        Theta_flat((s-1)*X+1:s*X,(t-
1)*X+1:t*X)=theta_update_back(:,:,s,t);
    end
end
%% use the SVD for decomposition of Theta
[VV,EE,WW] = svd(Theta_flat,'econ'); % Theta = VV * EE * WW'
LL = diag(EE);
%Note on size: VV and EE and WW ARE ALL (dit*X) x (dit*X): same as
Theta
%LL IS (dit*X) x 1
[LLs,how]=sort(LL,'descend');
%% i.e LLs = LL(how);
lossnorm = sum(LLs(X+1:end).^2);
state.L(bond_a,:)=0;
% renormalize the lambdas
state.L(bond_a,:)=LL(how(1:X));
state.L(bond_a,:)=state.L(bond_a,:)/norm(state.L(bond_a,:));
EEcutoff = diag(state.L(bond_a,:));
for r = 1:dit
    state.H(:,:,r,bit1) = VV(X*(r-1)+1:r*X,how(1:X)) * EEcutoff;
    state.H(:,:,r,bit2) = EEcutoff * WW(X*(r-1)+1:r*X,how(1:X))';
end
%% just to check that gammas do what they are supposed to.
% rr = (1:dit);
% Hba_after(:,:,rr) = state.H(:,:,rr,bit1); % THIS IS Gamma_ab
% Hac_after(:,:,rr) = state.H(:,:,rr,bit2); % THIS IS Gamma_ac

```

4.5 Degeneracy and Non-Frustration Condition for Generic Local Terms

We choose to investigate chains of d -dimensional quantum spins (qudits) with 2-local nearest-neighbor interactions ¹. Our first result is an analytic derivation of the necessary and sufficient conditions for such quantum systems to be unfrustrated. Second, we look at their ground state properties and find a range of parameters where we conjecture that these states are highly entangled and thus may be difficult to find computationally. We then corroborate this by a numerical investigation using a Matrix Product State (MPS) method.

While the MPS formulation has been shown to work very well numerically for most one-dimensional particle systems, complexity theory issues seem to show there must be exceptions to this rule. Finding the ground-state energy of a one-dimensional qudit chain with $d = 11$ has been shown to be as hard as any problem in QMA [101, 102]. It is not believed that classical computers can efficiently solve problems in QMA. However, to our knowledge until now there have not been any concrete examples (except at phase transitions) for which MPS methods do not appear to work reasonably well. This research was undertaken to try to discover natural examples of Hamiltonians for which MPS cannot efficiently find or approximate the ground states.

In Section 4.6 we show that the question of non-frustration for qudit chain Hamiltonians with general nearest-neighbor interactions can be simplified to only Hamiltonians that are sums of projector terms[103]. We then analytically show under what conditions zero energy ground states for this system exist. Second, in Section 4.7 we

¹The rest of this chapter is based on [133]; however, I have corrected the erroneous assertion we made regarding choosing solutions.

show how to search for and approximate the ground states numerically and analyze the efficiency of finding the required MPS. We identify an interesting class of unfrustrated qudit chain Hamiltonians, on which our MPS methods do not work well. Led by our numerical work, we conjecture that these ground states are highly entangled. Finally, we summarize our results and conclude with an outlook to further work in Section 4.8.

4.6 Generic Interactions

We now choose to focus on a class of Hamiltonians whose local terms have generic eigenvectors. This implies

$$P_{k,k+1} = \sum_{p=1}^r |v_{k,k+1}^p\rangle\langle v_{k,k+1}^p| \quad (4.6.1)$$

is a *random* rank r projector acting on a d^2 -dimensional Hilbert space of two qudits, chosen by picking an orthonormal set of r random vectors (a different set for every qudit pair – we are not assuming translational invariance).

We now find conditions governing the existence of zero energy ground states (from now on, called solutions in short). We do so by counting the number of solutions possible for a subset of the chain, and then adding another site and imposing the constraints given by the Hamiltonian.

Suppose we have a set of D_n linearly independent solutions for the first n sites of the chain in the form

$$\psi_{\alpha_n}^{i_1, \dots, i_n} = \Gamma_{\alpha_1}^{i_1, [1]} \Gamma_{\alpha_1 \alpha_2}^{i_2, [2]} \dots \Gamma_{\alpha_{n-2}, \alpha_{n-1}}^{i_{n-1}, [n-1]} \Gamma_{\alpha_{n-1}, \alpha_n}^{i_n, [n]} \quad (4.6.2)$$

similar to MPS, with $i_k = 1, \dots, d$ and $\alpha_k = 1, \dots, D_k$; here and below all the repeated indices are summed over. The Γ 's satisfy the linear independence conditions²

$$\Gamma_{\alpha_{k-1}, \alpha_k}^{i_k, [k]} x_{\alpha_k} = 0, \forall i_k, \alpha_{k-1} \iff x_{\alpha_k} = 0, \forall \alpha_k.$$

We now add one more site to the chain, impose the constraint $P_{n, n+1}$ and look for the zero-energy ground states for $n + 1$ sites in the form

$$\psi_{\alpha_{n+1}}^{i_1, \dots, i_{n+1}} = \psi_{\alpha_{n-1}}^{i_1, \dots, i_{n-1}} \Gamma_{\alpha_{n-1}, \alpha_n}^{i_n, [n]} \Gamma_{\alpha_n, \alpha_{n+1}}^{i_{n+1}, [n+1]}. \quad (4.6.3)$$

The unknown matrix $\Gamma_{\alpha_n, \alpha_{n+1}}^{i_{n+1}, [n+1]}$ must satisfy

$$\langle v_{n, n+1}^p | i_n i_{n+1} \rangle \Gamma_{\alpha_{n-1}, \alpha_n}^{i_n, [n]} \Gamma_{\alpha_n, \alpha_{n+1}}^{i_{n+1}, [n+1]} = 0 \quad (4.6.4)$$

for all values of $\alpha_{n-1}, \alpha_{n+1}$ and p , with $|v_{n, n+1}^p\rangle$ vectors defined in (4.6.1). This results in a system of linear equations

$$C_{p\alpha_{n-1}, i_{n+1}\alpha_n} \Gamma_{\alpha_n, \alpha_{n+1}}^{i_{n+1}, [n+1]} = 0, \quad (4.6.5)$$

with $C_{p\alpha_{n-1}, i_{n+1}\alpha_n} = \langle v_{n, n+1}^p | i_n i_{n+1} \rangle \Gamma_{\alpha_{n-1}, \alpha_n}^{i_n, [n]}$ a matrix with dimensions $rD_{n-1} \times dD_n$. If $dD_n \geq rD_{n-1}$ and the matrix C has rank rD_{n-1} , the conditions given by Eq. 4.6.5 are independent and we can construct $dD_n - rD_{n-1}$ linearly independent $\Gamma_{\alpha_n, \alpha_{n+1}}^{i_{n+1}, [n+1]}$, corresponding to solutions for the $n + 1$ qudit chain (see the appendix for a proof

²Note that this is not the standard MPS form, which also requires linear independence in the other direction, i.e.

$$y_{\alpha_{k-1}} \Gamma_{\alpha_{k-1}, \alpha_k}^{i_k, [k]} = 0, \forall i_k, \alpha_k \iff y_{\alpha_{k-1}} = 0, \forall \alpha_{k-1}$$

In this case s_k would be the Schmidt rank for the partition of the qudits into $(1, \dots, k)$ and $(k + 1, \dots, n)$.

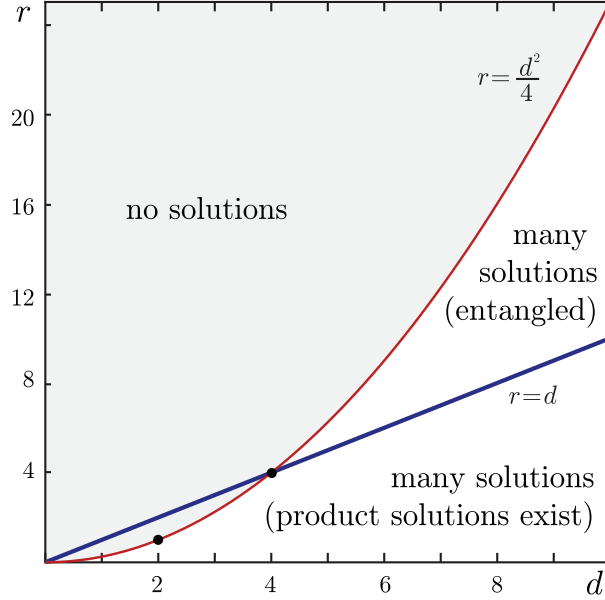

Figure 4.6.1: The existence of zero energy ground states for a qudit chain with d -dimensional qudits and r projectors per pair. We highlight two notable cases: $d = 2, r = 1$ and $d = 4, r = 4$.

of rank(C) = rD_{n-1}). The freedom we have now is to use only a subset of them for constructing solutions (see the next chapter). Previously in our work [133] we asserted that the choice made implies

$$s_{n+1} \leq ds_n - rs_{n-1}, \quad (4.6.6)$$

valid for all n . In order for the forgoing inequality to hold, one needs to prove that the possible dependences resulting from making choices do not affect the inequality (see next chapter). For example, excluding a subspace at a given step could break the full rankness of C at a later step.

Let $D_0 = 1$ and $D_1 = d$ as the only constraint on $\Gamma_{\alpha_1}^{[1],i_1}$ is linear independence. The recursion relation above at each gives D_n linearly independent zero energy states,

where

$$D_n = dD_{n-1} - rD_{n-2}, \quad (4.6.7)$$

for all n with. The solution of this recursion relation is

$$D_n = \frac{f^{n+1} - g^{n+1}}{f - g}$$

with $f + g = d$ and $fg = r$. Hence,

$$f = \frac{d}{2} + \sqrt{\frac{d^2}{4} - r}, \quad g = \frac{d}{2} - \sqrt{\frac{d^2}{4} - r}.$$

There are three interesting regimes for r and d which yield different behaviors of D_n (Figure 4.6.1):

1. $r > \frac{d^2}{4}$ gives $D_n = r^{\frac{n}{2}} \frac{\sin(n+1)\theta}{\sin\theta}$ with $\cos\theta = \frac{d}{2\sqrt{r}}$. D_n becomes negative when $n + 1 > \frac{\pi}{\theta}$ and thus no zero energy states can be constructed for a long chain if $r > \frac{d^2}{4}$.
2. $r = \frac{d^2}{4}$ results in $D_n = \left(\frac{d}{2}\right)^n (n + 1)$, an exponential growth in n (except when $d = 2$, which gives linear growth).
3. $r < \frac{d^2}{4}$ implies $f > \frac{d}{2}$ and $f > g$ so for large n , $D_n \sim f^n \left(1 - \frac{g}{f}\right)^{-1}$ and the number of zero energy states grows exponentially.

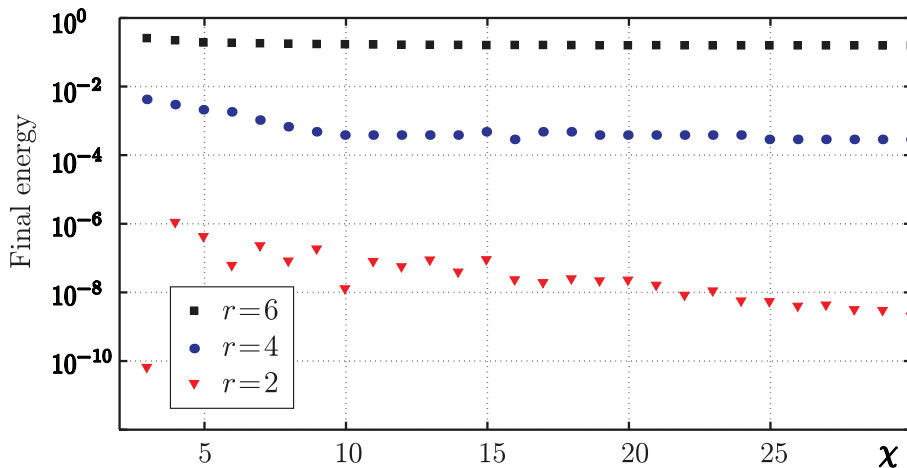

Figure 4.7.1: (Color online) Ground state energy from imaginary time evolution vs. χ for different ranks of the Hamiltonian. This is a plot for $d = 4$, and projector ranks of 2, 4, 6. Exact description would require $\chi = d^{N/2} = 2^{20}$.

4.7 Numerical investigation using Matrix Product States

In this Section we use the methods described above to numerically search for the ground states of our class of random projector Hamiltonians (4.1.5). We probe the relations obtained in the previous Section, and see how well the energy coming from our small- χ MPS imaginary time evolution converges to zero. The numerical technique we use is similar to Vidal’s [97, 104]. We use imaginary time evolution to bring the system from a known state to its ground state: $|\Psi_{\text{grd}}\rangle = \lim_{\tau \rightarrow \infty} \frac{e^{-H\tau}|\Psi_0\rangle}{\|e^{-H\tau}|\Psi_0\rangle\|}$. Our experimentation with the parameters for a linear chain of length $N = 20$ is shown in Figures 4.7.1, 4.7.2 and 4.7.3; all the plots are on semi-log scale and the quantities being plotted are dimensionless.

We see that for $r < d$ the final energy converges to the zero energy ground state relatively fast with $\chi \ll d^{N/2}$. This can be seen in all the figures by the lowest curves

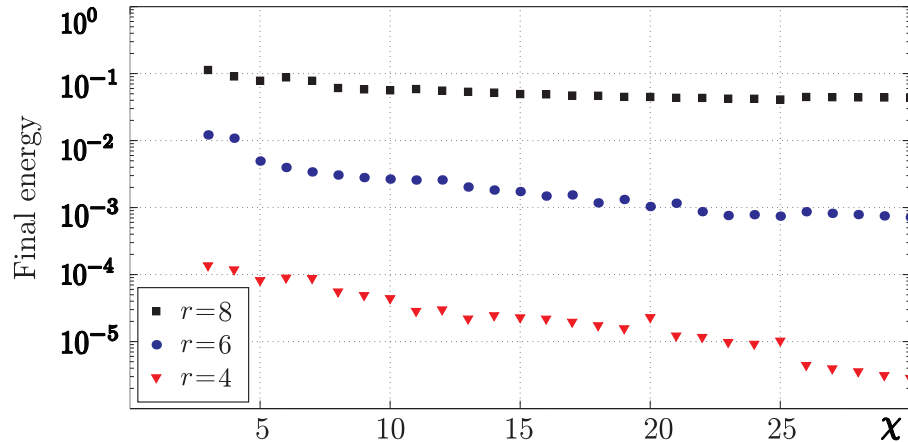

Figure 4.7.2: This is a plot for $d = 5$, and projector ranks of 4, 6, 8. Exact description would require $\chi = 5^{10}$.

(marked by triangles). As can be seen the final energy obtained from imaginary time evolution tends toward zero with a steep slope, indicating that the ground state can be approximated efficiently with a small χ in MPS ansatz.

The $r > d^2/4$ case, marked by squares, is shown by the top curves in all the figures. One sees that the final energy plateaus relatively fast in all three cases. This shows that the numerics have converged to a nonzero value and that increasing χ will not yield a lower value of energy. Therefore, the numerical results suggest that there are no ground states with zero energy.

In the previous section we analytically showed that when $d \leq r \leq d^2/4$ there are many zero energy ground states. However, when we try to numerically find these states we see that the final energy converges to zero slowly. This is shown in all the Figures by the curves marked by circles. Out of these there are the critical cases, where $r = \frac{d^2}{4}$. These correspond to the curves marked by closed circles in Figures 3 and 5. The numerical investigation of the case $d \leq r \leq d^2/4$ is interesting because it suggests that for large number of spins finding the ground state with small χ ,

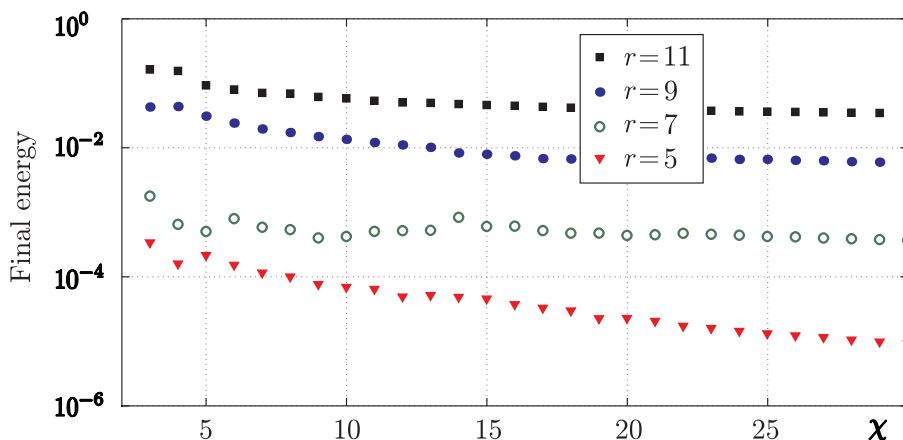

Figure 4.7.3: The case of $d = 6$, and projector ranks: 5, 7, 9, 11. Exact description in general would require $\chi = 6^{10}$.

tractable on a normal computer, is very hard. We interpret this as high amount of entanglement among the zero energy ground states and leave the analytical proof of this statement for a follow up paper.

4.8 Summary

We have investigated the no-frustration conditions for a system of qudits on a line with d states per site and random rank r local projector Hamiltonians acting between the nearest neighbor sites. We proved that there are no ground states with zero energy for $r > \frac{d^2}{4}$ and sufficiently large N . The system is not frustrated for $r \leq \frac{d^2}{4}$. This second parameter region further splits into two. For $d \leq r \leq \frac{d^2}{4}$, many entangled zero energy ground states exist. On the other hand, for $r < d$ we can also construct separable zero-energy ground states (see the next chapter and also Figure 4.6.1).

We have verified the above numerically, in particular we have seen that when

$d \leq r \leq d^2/4$ approximating the ground state energy (finding the ground states) is hard as the states seem to be highly entangled.

4.9 Appendix

We would like to say that for random $|v\rangle$ the rank of C is generically the maximum rank allowed, $\min(rD_{n-1}, dD_n)$. The full rankness of C in Eq. 4.6.5 is not obviously true. In particular in the regime $r \leq \frac{d^2}{4}$, to which we restrict ourselves from now on, D_n grows exponentially in n , while the number of parameters in the $|v_{k,k+1}^p\rangle$ on which C depends only grows linearly. Thus C is far from a generic matrix of its size, but we now prove that its rank is indeed rD_{n-1} .

The argument used by Laumann et al [108] to prove their “geometrization theorem” also applies to our problem. It shows that for a chain of N qudits with random $|v_{k,k+1}^p\rangle$, i.e. for a Hamiltonian H as in equations (2), (4) and (5) the number of zero-energy states, i.e. $\dim(\ker(H))$, is with probability one (which is what we mean by generic) equal to its minimum value. The calculation leading to the recursion relation Eq. 4.6.7 and its solution, shows that in the regime $r \leq d^2/4$ this minimum is $\geq D_N$, since if the rank of the $rD_{k-1} \times dD_k$ matrix C is ever less than rD_{k-1} we can choose D_{k+1} of them. Hence it is sufficient to find a single set of $|v_{k,k+1}^p\rangle$ for which $\dim(\ker(H)) = D_N$ to prove that D_N is the generic value, i.e. that greater values occur with probability zero. This implies that the rank of each C is generically rD_{k-1} , since otherwise at the first k where C had smaller rank we could construct more than D_{k+1} solutions for a chain of length $k+1$.

We construct $|v_{k,k+1}^p\rangle$ with the property $\langle v_{k,k+1}^p | i_k i_{k+1} \rangle = 0$ unless $i_k \leq \frac{d}{2}$ and $i_{k+1} > \frac{d}{2}$. This can be done for r linearly independent $|v^p\rangle$ if $r \leq \frac{d^2}{4}$. We now assume

d is even; the modifications for d odd are obvious. We proceed by induction on n . Assume that in each $\Gamma_{\alpha_{k-1}, \alpha_k}^{i_k, [k]}$ with $k \leq n$, α_k runs from 1 to D_k . From the definition of C (following Eq. 4.6.5) and the special choice of $|v\rangle$, $C_{p\alpha_{n-1}, i_{n+1}\alpha_n} = 0$ for $i_{n+1} \leq \frac{d}{2}$ and so from Eq. 4.6.5 $\Gamma_{\alpha_n, \alpha_{n+1}}^{i_{n+1}, [n+1]}$ is unconstrained for $i_{n+1} \leq \frac{d}{2}$. This allows us to choose, for $1 \leq \alpha_{n+1} \leq \frac{d}{2}D_n$,

$$\Gamma_{\alpha_n, \alpha_{n+1}}^{i_{n+1}, [n+1]} = 1 \text{ when } \alpha_{n+1} = \frac{d}{2}(\alpha_n - 1) + i_{n+1}$$

with $1 \leq \alpha_n \leq D_n$, $1 \leq i_{n+1} \leq \frac{d}{2}$

$$\Gamma_{\alpha_n, \alpha_{n+1}}^{i_{n+1}, [n+1]} = 0 \text{ otherwise.}$$

As part of our induction, we assume that for $1 \leq \alpha_n \leq \frac{d}{2}D_{n-1}$,

$$\Gamma_{\alpha_{n-1}, \alpha_n}^{i_n, [n]} = 1 \text{ when } \alpha_n = \frac{d}{2}(\alpha_{n-1} - 1) + i_n$$

with $1 \leq \alpha_{n-1} \leq D_{n-1}$, $1 \leq i_n \leq \frac{d}{2}$

$$\Gamma_{\alpha_{n-1}, \alpha_n}^{i_n, [n]} = 0 \text{ otherwise.}$$

Now we can show that the rows of $C_{p\alpha_{n-1}, i_{n+1}\alpha_n}$ are linearly independent. For if, $\sum_{p, \alpha_{n-1}} y_{p, \alpha_{n-1}} C_{p\alpha_{n-1}, i_{n+1}\alpha_n} = 0$ for all i_{n+1}, α_n this is true in particular for all $i_{n+1} > d/2$, $\alpha_n \leq \frac{d}{2}D_{n-1}$, when it becomes $\sum_p y_{p\alpha_{n-1}} \langle v_{n,n+1}^p | i_n i_{n+1} \rangle = 0$ for all $i_n \leq \frac{d}{2}$, $i_{n+1} > \frac{d}{2}$, and $\alpha_{n-1} \leq D_{n-1}$. Since the $|v^p\rangle$ are linearly independent, this is only true if $y_{p\alpha_{n-1}} = 0$ for all p, α_{n-1} . Hence the rank of C is rD_{n-1} and α_{n+1} can take altogether $dD_n - rD_{n-1} = D_{n+1}$ values, which is what we wanted to prove.

Chapter 5

Entanglement of The Ground States

The next natural question to ask is: how entangled are the ground states of qudit chains with generic local interaction? In this chapter I summarize my efforts in proving various results, which have not appeared elsewhere. As of now we have not succeeded in proving the main theorem (see the conjecture below); I include the partial results with the hope that they inspire future progress. In the previous chapter we showed that there are exponentially many ground states when $d \leq r \leq d^2/4$ (see Table).

Parameter range	Number of ground states	Frustrated?
$d \leq r \leq d^2/4$	$\sim \exp(n)$	No
$r > d^2/4$	—————	Yes

We will see that when $r < d$ the ground states can be product states. How entangled are the ground states in the regime $d \leq r \leq d^2/4$ when $d \geq 4$? Simple theorems of algebraic geometry tell us that among the many ground states there are

highly entangled ground states. Can there be product states? If not, are *all* the ground states highly entangled (see the conjecture below)? By highly entangled we mean their Schmidt rank is exponentially lower bounded.

There are two methods that can yield the bounds needed: 1) Choosing solutions as we build the ground states marching from one end of the chain and proving lower bounds on the number of solutions that need to be kept to build any state. 2) Relating the construction of the previous chapter to the Schmidt rank by working from both ends and matching solutions.

5.1 Set Up

5.1.1 Genericity of $C^{[n]}$

Due to generic local interactions, the complete set of eigenstates has parameter count equal to a polynomial in the number of spins, though the dimensionality is exponential. This implies that $C^{[n]}$ is non-generic despite its entries being functions of polynomial random variables. However, as long as the variables are continuous, statements about the rank of $C^{[n]}$ can be made in a 'generic' sense. That is if the rank is full for some choice of random variables, the full rankness holds with probability one for random choice of those variables.

5.1.2 Basis for Solutions and $C^{[n]}$

We want to understand the Kernel of $C^{[n]}$ as give by

$$C_{p\alpha_{n-1}, i_{n+1}\alpha_n}^{[n]} \equiv \langle v_{n,n+1}^p | i_n i_{n+1} \rangle \Gamma_{\alpha_{n-1}, \alpha_n}^{[n], i_n} \quad (5.1.1)$$

Further,

$$|v_{n,n+1}^p\rangle = \beta_{i_n, i_{n+1}}^p |i_n i_{n+1}\rangle \quad (5.1.2)$$

with β 's drawn randomly, say from a Gaussian distribution. $C^{[n]}$ solves:

$$C_{p\alpha_{n-1}, i_{n+1}\alpha_n}^{[n]} \Gamma_{\alpha_n, \alpha_{n+1}}^{[n+1], i_{n+1}} = 0. \quad (5.1.3)$$

Inserting Eq.5.1.2 in Eq.5.1.1 (β 's are real) we get

$$C_{p\alpha_{n-1}, i_{n+1}\alpha_n}^{[n]} = \beta_{i_n, i_{n+1}}^p \Gamma_{\alpha_{n-1}, \alpha_n}^{[n], i_n}. \quad (5.1.4)$$

Let B be the $r \times d^2$ matrix of β 's which we can write as d blocks of matrices (B_k) of size $r \times d$ put next to one another (not multiplied):

$$B \equiv [B_1 B_2 \cdots B_d], \quad (5.1.5)$$

with, $B_k = \begin{bmatrix} \beta_{1k}^1 & \cdots & \beta_{d,k}^1 \\ \vdots & \ddots & \vdots \\ \beta_{1k}^r & \cdots & \beta_{d,k}^r \end{bmatrix}$, $k = 1, \dots, d$. The matrix B has rank r ; whereas $\text{rank}(B_k) = \min(r, d)$ (both with probability one).

In matrix notation,

$$C^{[n]} = \left[(\mathbb{I}_{D_{n-1}} \otimes B_1) \Gamma^{[n]} \quad (\mathbb{I}_{D_{n-1}} \otimes B_2) \Gamma^{[n]} \quad \cdots \quad (\mathbb{I}_{D_{n-1}} \otimes B_d) \Gamma^{[n]} \right]. \quad (5.1.6)$$

Remark: In what follows, by the word *generic* we mean with probability one.

Lemma 5. *For $r < d$ there are product states, i.e., there exists $\chi = 1$ solutions.*

Proof. We show that the states can be satisfied by product states. In this case,

taking the Schmidt rank to be one, we propose that $\Gamma^{[n]} = \vec{\gamma}_n$ is a vector of size d corresponding to the physical index i_n . The constraint matrix $C^{[n]}$ takes the form $C_{p,i_{n+1}}^{[n]} = \left[B_1 \vec{\gamma}_n \quad B_2 \vec{\gamma}_n \quad \dots \quad B_d \vec{\gamma}_n \right]$, which is a $r \times d$ matrix. It clearly has full rank equal to r . The question becomes, can we build $\vec{\gamma}_{n+1}$ to be a vector of size d ? The system of $r < d$ equations with random coefficients can always be satisfied. Therefore indeed we can take $\Gamma^{[n+1]} = \vec{\gamma}_{n+1}$. \square

Corollary 1. *When $r \geq d$, generically there are no product states.*

Proof. The only solution is the trivial solution $\vec{\gamma}_{n+1} = 0$. The problem is over specified; r constraints and d variables generically cannot be satisfied for $r \geq d$. \square

Comment: When $r \geq d$, $(\mathbb{I} \otimes B_1)$ is a full rank injective map. $\Gamma^{[n]}$ has D_n independent columns and is a tall rectangular matrix and is therefore an injective map. Their composition $(\mathbb{I} \otimes B_1) \Gamma^{[n]}$ is yet another full rank injective map, whose rank is the number of columns. It is however not clear that when we concatenate this map by $(\mathbb{I} \otimes B_k) \Gamma^{[n]}$ with $1 < k \leq d$ to obtain Eq. 5.1.6, the resulting matrix has rank equal to the number of rows.

Comment: In our previous work we proved that there are many zero energy ground states when $d \leq r \leq d^2/4$ and none when $r > d^2/4$.

5.1.3 Constructing Solutions for $d \leq r \leq d^2/4$

In Eq. 5.1.9 taking $D_0 = 1$ and $D_1 = d$, we build the solutions recursively by marching along the chain. The very first set of solutions $\Gamma_{D_0, D_1}^{[1], i_1}$, is a $d \times d$ diagonal matrix. From Eq. 5.1.6 we have $C^{[1]} = (B_1 \Gamma^{[1]} \dots B_d \Gamma^{[1]}) \equiv B$. To find a basis for

the kernel we row reduce $C^{[1]}$ to put it in the row echelon form:

$$C_{\text{echel}}^{[1]} \equiv \begin{bmatrix} 1 & & \tilde{\beta}_{d^2-r}^1 & \cdots & \tilde{\beta}_{d^2}^1 \\ & \ddots & \vdots & & \vdots \\ & & 1 & \tilde{\beta}_{d^2-r}^r & \tilde{\beta}_{d^2}^r \end{bmatrix} \equiv \begin{bmatrix} & \uparrow & & & \uparrow \\ \mathbb{I}_r & \tilde{\beta}_1 & \cdots & & \tilde{\beta}_{d^2-r} \\ & \downarrow & & & \downarrow \end{bmatrix},$$

Recall that $\Gamma^{[2]}$ is the set of solutions in the Kernel of $C^{[1]}$. The null space of $C^{[1]}$ is

$$\mathcal{N}(C^{[1]}) = \text{span} \left(\begin{array}{c} \uparrow \\ -\tilde{\beta}_j \\ \hline \downarrow \\ e_j \end{array} \right), \quad 1 \leq j \leq d^2 - r$$

the horizontal line depicts the partition of the $\tilde{\beta}$'s from the unit vectors and does not signify any mathematical operation.

Consequently, $\Gamma^{[2]}$ can be expressed as

$$\Gamma^{[2]} = \begin{pmatrix} \uparrow & & \uparrow \\ -\tilde{\beta}_1 & \cdots & -\tilde{\beta}_{d^2-r} \\ \hline & & \downarrow \\ & \mathbb{I}_{d^2-r} & \end{pmatrix}.$$

This will in turn define the $rd \times d^2$ matrix $C^{[2]}$

$$C^{[2]} = \left[(\mathbb{I}_{D_1} \otimes B_1) \Gamma^{[2]} \quad (\mathbb{I}_{D_1} \otimes B_2) \Gamma^{[2]} \quad \dots \quad (\mathbb{I}_{D_1} \otimes B_d) \Gamma^{[2]} \right],$$

whose Kernel defines $\Gamma^{[3]}$. Continuing this way we arrive at

$$\Gamma^{[n]} = \left(\frac{\begin{array}{ccc} \uparrow & & \uparrow \\ -\tilde{\beta}_1 & \dots & -\tilde{\beta}_{D_n} \\ \downarrow & & \downarrow \end{array}}{\mathbb{I}_{D_n}} \right), \text{ giving}$$

$$C^{[n]} = \left(\frac{\begin{array}{cccc} \uparrow & & \uparrow & \uparrow & \uparrow \\ \gamma_1^{(1)} & \dots & \gamma_{D_n}^{(1)} & \dots & \gamma_1^{(d)} & \gamma_{D_n}^{(d)} \\ \downarrow & & \downarrow & & \downarrow & \downarrow \\ B_1 & & & & B_d & \\ & \ddots & & \dots & & \ddots \\ & & B_1 & & & B_d \end{array}}{\quad} \right) \quad (5.1.7)$$

where

$$\left(\begin{array}{c} \uparrow \\ \gamma_h^{(k)} \\ \downarrow \end{array} \right) \equiv \mathbb{I} \otimes B_k \left(\begin{array}{c} \uparrow \\ -\tilde{\beta}_h \\ \downarrow \end{array} \right); \quad 1 \leq h \leq D_n$$

Therefore these constraints give

$$D_{n+1} \geq dD_n - rD_{n-1}; \quad (5.1.8)$$

solutions with equality for $C^{[n]}$ being full rank. In our previous work we proved that $C^{[n]}$ is full rank:

$$D_{n+1} = dD_n - rD_{n-1}. \quad (5.1.9)$$

The main theorem of this chapter remains to be proved:

Conjecture 1. *Generically all the ground states of the qudit chain with generic local interactions are all highly entangled in the regime $d \leq r \leq d^2/4$.*

In order to obtain entanglement bounds one can take at least two different approaches.

5.2 First Method: Choosing Solutions

Let the n^{th} step be the first step in which we make a choice by throwing away u_n solutions and keeping $s_n \equiv D_n - u_n$ solutions. For example if we throw out the second and the last column of $\Gamma^{[n]}$ we obtain

$$\Gamma^{[n]} = \begin{pmatrix} \uparrow & \uparrow & \uparrow & & \uparrow \\ -\tilde{\beta}_1 & -\tilde{\beta}_3 & -\tilde{\beta}_4 & \cdots & -\tilde{\beta}_{D_{n-1}} \\ \downarrow & \downarrow & \downarrow & & \downarrow \\ \hline 1 & & & & \\ 0 & 0 & & & \\ & 1 & & & \\ & & 1 & & \\ & & & \ddots & \\ & & & & 1 \\ & & & & 0 \end{pmatrix}. \quad (5.2.1)$$

This in turn defines the $rD_{n-1} \times ds_n$ matrix $C^{[n]}$

$$C^{[n]} = \left[(\mathbb{I}_{s_n} \otimes B_1) \Gamma^{[n]} \quad (\mathbb{I}_{s_n} \otimes B_2) \Gamma^{[n]} \quad \cdots \quad (\mathbb{I}_{s_n} \otimes B_d) \Gamma^{[n]} \right],$$

whose dimension of Kernel dictates the number of independent solutions we can build, i.e., $\Gamma^{[n+1]}$. We can keep making choices by excluding solutions to build some arbitrary state, i.e., $s_k = D_k - u_k$.

Lemma 6. *A lower bound on s_k is a lower bound on χ_k .*

Proof. χ_k can be obtained from s_k by applying the canonicity condition [33, condition 2, in Theorem 1] to the $\Gamma^{[k]}$; equivalently a further constraint of linear independence from right to left (see the previous chapter) needs to be imposed on the solutions. Since solutions with χ_n are contained in solutions with s_n one can take the $\chi_k = s_k^{\text{lb}}$, (lb denotes lower bound) to allow construction of any state. \square

5.2.1 Rank of $C^{[n]}$

Suppose at some step n we throw away u_n and keep $s_n \equiv D_n - u_n$ of the solutions. In our previous work we proved that for $u_n = 0$ for all n , $C^{[n]}$ is full rank. The full rankness however does not generally hold if we throw away solutions. When a choice is made, as in the example shown in Eq. (5.2.1), the matrix of constraints becomes

$$C^{[n]} = \left(\begin{array}{cccccc} \uparrow & & \uparrow & & \uparrow & \uparrow \\ \gamma_1^{(1)} & \cdots & \gamma_{s_n}^{(1)} & \cdots & \gamma_1^{(d)} & \gamma_{s_n}^{(d)} \\ \downarrow & & \downarrow & & \downarrow & \downarrow \\ \hline B_1^1 & & & & B_d^1 & \\ & \ddots & & & & \ddots \\ & & B_1^{s_d} & \cdots & & B_d^{s_d} \end{array} \right) \equiv \left(\begin{array}{c} \mathbb{R}^{[n]} \\ \mathbb{B}^{[n]} \end{array} \right). \quad (5.2.2)$$

Each solution that is excluded will reduce the columns of $C^{[n]}$ d -fold and the superscripts on B_k 's remind us that there may be some columns missing as a consequence of having made a choice. It is easy to see how this comes about. Suppose we exclude the first column of $\Gamma^{[n]}$, then each of the top foremost B_k 's in Eq. (5.1.7) loses its first column. In particular if we throw away the last d solutions in $\Gamma^{[n]}$, one can see that $C^{[n]}$ above would have r rows all zeros as its last rows.

5.2.2 Towards Entanglement Bounds

Suppose we march along a semi-infinite line and choose solutions randomly then it is plausible to assume the recursion $s_{n+1} \leq ds_n - rs_{n-1}$ (i.e., no rank deficiency) to hold. In this case, the entanglement bounds can nicely be obtained

Lemma 7. *Suppose $s_{n+1} \leq ds_n - rs_{n-1}$ holds everywhere, then $s_{n+1} \geq qs_n$ where $q \equiv \frac{r}{d} \left(1 + \frac{r}{d^2-r}\right)$, which for $d \geq 4$ and $d \leq r \leq d^2/4$ implies exponentially large lower bound on χ_{n+1} .*

Proof. We apply the set of inequalities, $s_{n+2} \leq ds_{n+1} - rs_n$ and existence of solutions $s_k > 0$ for all k . Positivity of $s_{n+2} \Rightarrow s_{n+1} > \frac{r}{d}s_n$. Let $s_{n+1} \equiv \frac{r}{d}s_n + u_n$ which implies $s_{n+2} \leq du_n$. We now bound u_n using $s_{n+3} \leq ds_{n+2} - rs_{n+1} \Rightarrow s_{n+3} \leq d^2u_n - rs_{n+1} = d^2u_n - \frac{r^2}{d}s_n - ru_n = u_n(d^2 - r) - \frac{r^2}{d}s_n$. Now $s_{n+3} > 0$ implies $u_n > \frac{r^2}{d(d^2-r)}s_n$. Combining this with $s_{n+1} \equiv \frac{r}{d}s_n + u_n$ we get

$$s_{n+1} > \frac{r}{d} \left(1 + \frac{r}{d^2 - r}\right) s_n \equiv qs_n = \begin{cases} \frac{d}{d-1}s_n & r = d \\ \frac{d}{3}s_n & r = \frac{d^2}{4}. \end{cases}$$

which proves $s_n = q^n$ are lower bounds on solutions that grow exponentially with n for $d \geq 4$. Using Lemma 6 we conclude χ_n is exponentially lower bounded. \square

Comment: The formulation above does not take into account the finiteness of the chain. Further it ignores the affect of possible rank deficiency due to choosing solutions by assuming $s_{n+1} \leq ds_n - rs_{n-1}$ holds at every step. In particular, for a finite chain of length N , $\chi_{N-1} \leq d$ whereas, $q^{N-1} \sim \exp(N-1)$.

5.3 Second Method: Matching Solutions

One can approach the problem by marching along both ways and match solutions in between the two ends and ask what the lower bound on the Schmidt rank must be. It is notationally convenient to index the marching along from left and right

differently; let $N = m + n$. Suppose we march along from left n sites building the Γ matrices up to and including $\Gamma_{\alpha_{n-1}, \alpha_n}^{i_n, [n]}$ and suppose we we march along from right m sites with $\Gamma_{\alpha_m, \alpha_{m-1}}^{i_m, [m]}$. Recall that marching along from left (right) only imposed linear independence of the solutions from left (right). To build any state we need to match the solutions and apply the last constraint between sites n and m ,

$$\begin{aligned} \beta_{i_n, i_m}^p \Gamma_{\alpha_{n-1}, \alpha_n}^{i_n, [n]} X_{\alpha_n, \alpha_m} \Gamma_{\alpha_m, \alpha_{m-1}}^{i_m, [m]} &= 0 \\ \Leftrightarrow C_{p\alpha_{n-1}, \alpha_{m-1}; \alpha_n, \alpha_m} X_{\alpha_n, \alpha_m} &= 0, \end{aligned} \tag{5.3.1}$$

where $C_{p\alpha_{n-1}, \alpha_{m-1}; \alpha_n, \alpha_m} \equiv \beta_{i_n, i_m}^p \Gamma_{\alpha_{n-1}, \alpha_n}^{i_n, [n]} \Gamma_{\alpha_m, \alpha_{m-1}}^{i_m, [m]}$ defines $rD_{n-1}D_{m-1}$ constraints on $D_n D_m$ variables—entries of X . It can be checked that $D_{n+m} = D_n D_m - rD_{n-1}D_{m-1}$ as expected. Let us make a crisp problem definition. Given,

1. Eq. 5.3.1 has $D_{n+m} \equiv D_N$ solutions. Let us call the space of solutions \mathcal{S}
2. $\Gamma^{[n]}$ has D_n independent columns: If $\Gamma_{\alpha_{n-1}, \alpha_n}^{i_n, [n]} b_{\alpha_n} = 0, \quad \forall i_n, \alpha_{n-1} \Rightarrow b_{\alpha_n} = 0$
3. $\Gamma^{[m]}$ has D_m independent columns: If $c_{\alpha_m} \Gamma_{\alpha_m, \alpha_{m-1}}^{i_m, [m]} = 0, \quad \forall i_m, \alpha_{m-1} \Rightarrow c_{\alpha_m} = 0$
4. β_{i_n, i_m}^p are generic;

prove that

$$\{\mathcal{S}\} \cap \{\text{determinantal variety of } D_n \times D_m \text{ matrices with rank } \chi \leq \chi_0\} = \emptyset$$

with probability one for some large χ_0 . Using matrix notation, one wants to bound the rank of matrix X that satisfies

$$\sum_{i_m=1}^d (\mathbb{I}_{D_{n-1}} \otimes B_{i_m}) \Gamma(i_n) X \Gamma(i_m) = 0$$

where each B_{i_m} is a $r \times d$ generic matrix as discussed above and $\Gamma(i_n)$ is $dD_{n-1} \times D_n$ with D_n independent columns and each $\Gamma(i_m)$ for a fixed i_m is $D_m \times D_{m-1}$.

How do the entries of X depend on the local constraints that were imposed at previous steps? The entries are polynomials of very high degree¹ – much larger than the size of the matrix. One can see this by using the following basis for building solutions

$$\left[\begin{array}{c|c} X & Y \end{array} \right] \left[\begin{array}{c} (\text{adj}X)^{-1} \\ -I \end{array} \right]$$

$$\begin{array}{cccccccc} 1 & \dots & n-1 & n & X & m & m-1 & \dots & 1 \\ \cdot & & \cdot & \cdot & & \cdot & \cdot & & \cdot \end{array}$$

The elements of X have entries that are homogeneous polynomial functions of local terms at the previous steps

$$X_{ij} = \text{poly} \left\{ \left[(\beta_{12})^{r^n D_0 D_1 \dots D_{n-1}} \dots (\beta_{n-1,n})^{r^2 D_{n-2} D_{n-1}} \right]^{D_{n-1}} \right. \quad (5.3.2)$$

$$\left. \beta_{nm}^{r D_{n-1} D_{m-1}} \left[(w_{m,m-1})^{r^2 D_{m-1} D_{m-2}} \dots w_{21}^{r^m D_{m-1} \dots D_0} \right]^{D_{m-1}} \right\},$$

where we denote the matrix of the local terms between sites k and $k+1$ by $\beta_{k,k+1}$ if we are marching from the left and by $w_{k,k+1}$ if we are marching from the right. For example $(\beta_{12})^{r^n D_0 D_1 \dots D_{n-1}}$ means that the polynomial dependence of entries of X on

¹The degrees of polynomials, shown below, were obtained by Jeffrey Goldstone.

the first set of local terms from left are homogeneous of degree $r^n D_0 D_1 \cdots D_{n-1}$ with respect to the elements of the random local terms between the first and the second sites.

The conjecture can be answered if the lower bound on $\text{rank}(X)$ is found. In particular, can one use the fact that the entries are very high powers of random parameters to argue in favor of an effective genericity for the matrix X .

5.4 What Does Algebraic Geometry Buy You?

Though the Hamiltonian does have generic local interactions, it is highly non-generic. In particular, it has to obey the restrictive tensor product structure. Moreover, the number of random parameters scale linearly with the system's size and are no more than rd^2N , whereas the size of the Hamiltonian is d^N . This prevents one from utilizing the techniques of Algebraic Geometry in any direct way to prove statements about the entanglement of all the ground states. However, one can use basic ideas of Algebraic Geometry [10, 11] to show that among the many ground states there is at least a highly entangled state [11]. We can consider the space of all the ground states and use the following proposition given in [11, prop. 10].

Proposition. *Every bipartite system $\mathbb{C}^{D_n} \otimes \mathbb{C}^{D_m}$ has a subspace \mathcal{S} of Schmidt rank $\geq \chi$, and of dimension $\dim(\mathcal{S}) = (D_n - \chi + 1)(D_m - \chi + 1)$*

It is straightforward to calculate χ needed for the space of solutions with $\dim(\mathcal{S}) = D_N$ to have an intersection when a cut is made in the middle $D_m = D_n = D_{\frac{N}{2}}$. In the previous chapter we obtained the functional dependence of D_n on n

$$\begin{aligned}
D_n &\sim f^n \left(1 - \frac{g}{f}\right)^{-1} & r < \frac{d^2}{4} \\
D_n &= \left(\frac{d}{2}\right)^n (n+1) & r = \frac{d^2}{4}
\end{aligned}$$

with

$$f = \frac{d}{2} + \sqrt{\frac{d^2}{4} - r}, \quad g = \frac{d}{2} - \sqrt{\frac{d^2}{4} - r}.$$

For large N one gets $\chi \sim f^{N/2}$ when $r < \frac{d^2}{4}$ and $\chi \sim N \left(\frac{d}{2}\right)^{N/2}$ when $r = \frac{d^2}{4}$. It is not surprising to see that there is at least one solutions with a high Schmidt rank; the conjecture requires a stronger result.

Chapter 6

Examples of Quantum 2-SAT and Combinatorial Techniques

Here I describe two examples of quantum 2-SAT (both of which are due to Sergey Bravyi [107]) on a chain of length $2n$ with three-dimensional ($d = 3$) and four-dimensional ($d = 4$) qudits, both of which have unique highly entangled ground states. In the $d = 3$ case, the ground state has a Schmidt rank that grows linearly with the number of sites and in $d = 4$ case, the ground state has Schmidt rank $\chi = 2^{n+1} - 1$. Below I show that the entanglement entropies for $d = 3$ and $d = 4$ cases are $H = \frac{1}{2} \log n + 0.645$ and $H = (\sqrt{2} - 1)n + \frac{1}{2} \log_2 n + \frac{1}{2} \log_2 \left(\frac{\sqrt{2}\pi}{3+2\sqrt{2}} \right)$ respectively. I provide numerical simulations to verify these formulas. In the next chapter we prove that the gap closes polynomially in the $d = 3$ case. As far as we know the technique we use for proving the gap in this case is new. The $d = 3$ example below gives the combinatorial background for the next chapter and $d = 4$ example does not appear elsewhere.

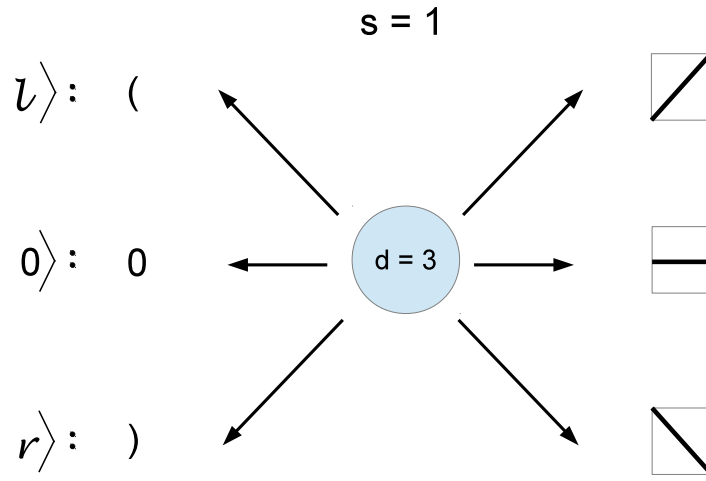

Figure 6.1.1: The states of the qudit.

6.1 Quantum 2-SAT for balanced parentheses ($d = 3$)

We describe an example of a frustration-free 2-local Hamiltonian on a chain of n qudits which has a unique highly entangled ground state ψ_0 . More precisely, if one cuts the chain in the middle, the Schmidt rank of ψ_0 is $\chi \approx n/2$, while the entanglement entropy is $S \approx (1/2) \log_2 n$. The Hamiltonian is likely to have a polynomial spectral gap.

Define a 3-letter alphabet (see Fig. 6.1.1)

$$\Sigma = \{l, r, 0\}.$$

We shall identify l and r with the left and right brackets respectively, that is, $l \equiv [$

and $r \equiv]$. Let us say that a string $s \in \Sigma^n$ is *balanced* iff after removing all zeroes from s one gets a balanced sequence of brackets. More formally, for any $s \in \Sigma^n$ let $L_i(s)$ and $R_i(s)$ be the number of left and right brackets in s located in the interval $1, \dots, i$.

Definition 2. A string $s \in \Sigma^n$ is called balanced iff $L_i(s) \geq R_i(s)$ for all $i = 1, \dots, n-1$ and $L_n(s) = R_n(s)$.

For example, for $n = 2$ there are only two balanced strings: 00 and lr . For $n = 3$ there are four balanced strings: 000 , $0lr$, $lr0$, and $l0r$. For $n = 4$ there are nine balanced strings:

$$\begin{array}{l} 0000 \quad l00r \\ 00lr \quad l0r0 \\ 0l0r \quad lr00 \\ 0lr0 \quad llrr \\ \quad \quad lrlr \end{array}$$

We would like to construct a Hamiltonian whose unique ground state is the uniform superposition of all balanced strings,

$$|\psi\rangle = \sum_{s \in \mathcal{B}} |s\rangle.$$

First we need to find a more local description of balanced strings. We shall say that a pair of strings $s, t \in \Sigma^n$ are equivalent, $s \sim t$, if one can obtain s from t by a sequence of local moves

$$00 \longleftrightarrow lr, \quad 0l \longleftrightarrow l0, \quad 0r \longleftrightarrow r0. \quad (6.1.1)$$

applied to pairs of consecutive letters. For any integers $p, q \geq 0$ let $u_{p,q} \in \Sigma^n$ be the string that has p leading r 's and q trailing l 's, that is,

$$u_{p,q} \equiv \underbrace{r \dots r}_p \underbrace{0 \dots 0}_{n-p-q} \underbrace{l \dots l}_q.$$

In particular, $u_{0,0} \equiv 0^n$.

Proposition. *A string $s \in \Sigma^n$ is balanced iff it is equivalent to the all-zeros string, $s \sim 0^n$. Any string $s \in \Sigma^n$ is equivalent to one and only one string $u_{p,q}$ for some integers $p, q \geq 0$.*

Proof. Indeed, applying the local moves Eq. (6.1.1) we can make sure that s does not contain substrings lr and $l0\dots 0r$. It means that if s contains at least one l , then all letters on the right of l are l or 0 . Similarly, if s contains at least one r , then all letters on the left of r are r or 0 . Since we can swap 0 with any other letter by the local moves, s is equivalent to $u_{p,q}$ for some p, q . It remains to show that different strings $u_{p,q}$ are not equivalent to each other. Indeed, suppose $u_{p,q} \sim u_{p',q'}$ such that $p \geq p'$. Then $R_p(s) - L_p(s) \leq p'$ for any string s equivalent to $u_{p',q'}$. This is a contradiction unless $p = p'$. Similarly one shows that $q = q'$. See Figure \square

It follows that the set of all strings Σ^n is a disjoint union of the equivalence classes $[u_{p,q}]$. We shall now introduce projectors Q that “implement” the local moves Eq. (6.1.1) and a frustration-free Hamiltonian

$$H^{\text{PROP}} = \sum_{j=1}^{n-1} Q_{j,j+1} \tag{6.1.2}$$

such that ground states of H^{PROP} are

Entanglement of **Motzkin States** is due to the mutual information between halves

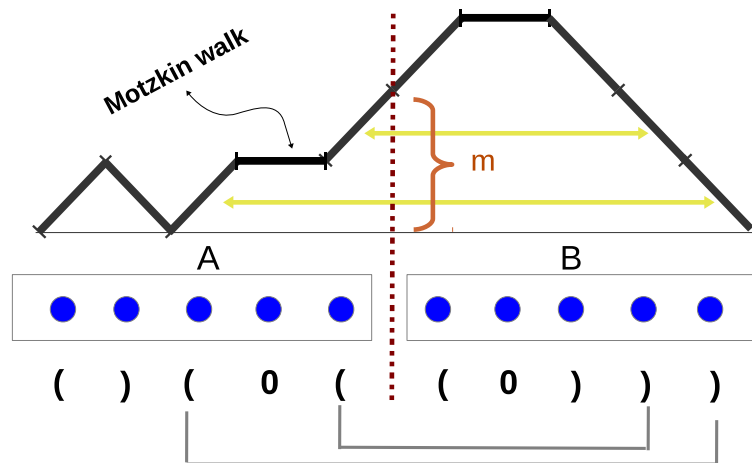

Figure 6.1.2: A state in the ground state for $d = 3$ example. The high amount of entanglement is due to the high mutual information between the two halves of the chain.

$$|\psi_{p,q}\rangle = \sum_{s \sim u_{p,q}} |s\rangle \quad (6.1.3)$$

Define quantum states $|A\rangle, |B\rangle, |C\rangle \in \mathbb{C}^3 \otimes \mathbb{C}^3$ as

$$|A\rangle = |00\rangle - |lr\rangle,$$

$$|B\rangle = |0r\rangle - |r0\rangle,$$

and

$$|C\rangle = |0l\rangle - |l0\rangle.$$

Define a projector

$$Q = \frac{1}{2} (|A\rangle\langle A| + |B\rangle\langle B| + |C\rangle\langle C|)$$

If a state $|\psi\rangle$ obeys $Q_{j,j+1}|\psi\rangle = 0$ for all $1 \leq j \leq n-1$ then $\langle s|\psi\rangle = \langle s'|\psi\rangle$ for any pair of equivalent strings s, s' . Hence H^{PROP} is indeed frustration free and its ground subspace is spanned by the states $\psi_{p,q}$.

How can we exclude the unwanted ground states $\psi_{p,q}$ with $p \neq 0$ and/or $q \neq 0$? The key observation is that the equivalence class $\mathcal{B}_n = [u_{0,0}]$ is the only class in which every string s satisfies $s_1 \neq r$ and $s_n \neq l$. Hence we can modify our Hamiltonian as

$$H = H^{\text{PROP}} + |r\rangle\langle r|_1 + |l\rangle\langle l|_n.$$

Now H is a frustration-free Hamiltonian with the unique ground state $|\psi_0\rangle$.

Let us now show that the Schmidt rank of $|\psi_n\rangle$ grows linearly with n . Consider

a bipartition $\{1, \dots, n\} = AB$ where A and B is the left and the right halves of the chain (we assume for simplicity that n is even). For any string $s \in \Sigma^n$ let s_A and s_B be the restrictions of s onto A and B . If s is a balanced string, one must have $s_A \sim u_{0,p}$ and $s_B \sim u_{p,0}$ for some $0 \leq p \leq n/2$, since each unbalanced left bracket in A must have a matching unbalanced right bracket in B . It follows that the Schmidt decomposition of ψ_0 can be written (ignoring the normalization) as

$$|\psi_0\rangle = \sum_{p=0}^{n/2} |\psi_{0,p}\rangle_A \otimes |\psi_{p,0}\rangle_B,$$

where the states $\psi_{p,q}$ are defined in Eq. (6.1.3). Therefore, the reduced density matrix of A has rank $\chi = 1 + n/2$.

Numerical simulation shows that the entanglement entropy of A grows logarithmically, $S(A) \approx (1/2) \log_2(n)$, while the spectral gap of H decays polynomially, $\Delta \sim 1/n^3$ (see next chapter).

6.1.1 Entanglement entropy

To have a balanced string, we need to have an even number of slots available for r 's and l 's after 0's have been removed. First, recall that the Catalan numbers are

$$\begin{aligned} C_k &= \frac{1}{k+1} \binom{2k}{k}, \quad k = 0, 1, \dots \\ &= \{1, 1, 2, 5, 14, \dots\}, \end{aligned}$$

which among many other things, count the number of ways one can deposit and withdraw a dollar a day such that after k days one starts and ends with zero dollars without ever going negative. It is immediate to see that a string that has $2n - 2k$

zeros has w_k number of configurations

$$w_k = C_k \binom{2n}{2k} = \frac{1}{k+1} \binom{2k}{k} \binom{2n}{2k}, \text{ with} \quad (6.1.4)$$

$$k = \{1, \dots, n\}$$

This count (with zeros taken into account) is also known as *Motzkin Numbers*. Let $Z_{2n} = \sum_{k=1}^n w_k$, the ground state reads

$$|\psi_g\rangle = \frac{1}{\sqrt{Z_{2n}}} \sum_{i=1}^{Z_{2n}} |i\rangle,$$

where i is any of the walks that start and end with height zero without ever going negative on $2n$ qutrits allowing only \nearrow , \searrow , \longrightarrow moves.

In order to calculate the entanglement entropy, we need to consider the correlation between the left and the right when a cut is made at some arbitrary bond. For simplicity we put the cut in the middle, i.e., at n . Let us define \mathcal{L}_m to be the space of all states with m excess left parentheses on the first n qutrits; moreover \mathcal{R}_m would be the space of all states with m excess right parentheses on the remaining n qutrits:

$$\mathcal{L}_m = \{|s_m\rangle_{1\dots n} | s_m \in \{0, r, l\}^n \text{ with } m \text{ excess } l\text{'s}\}$$

$$\mathcal{R}_m = \{|s_m\rangle_{n+1\dots 2n} | s_m \in \{0, r, l\}^n \text{ with } m \text{ excess } r\text{'s}\}$$

We want the states of the form

$$|\psi\rangle = \frac{1}{\sqrt{N}} \sum_{m=0}^n \left(\sum_{|x\rangle \in \mathcal{L}_m} |x\rangle \right) \left(\sum_{|y\rangle \in \mathcal{R}_m} |y\rangle \right).$$

Tracing over the right n qutrits we have

$$\text{Tr}_R |\psi\rangle\langle\psi| = \frac{1}{N} \sum_{m=0}^n M_{m,n} \left(\sum_{|x\rangle \in \mathcal{L}_m} |x\rangle \right) \left(\sum_{|x\rangle \in \mathcal{L}_m} \langle x| \right).$$

Recalling that we can have 0 or l and r , the number of states in \mathcal{L}_m denoted by M_m become

$$\begin{aligned} M_{m,n} &= \sum_{k=0}^{n-m} \binom{n}{k} (\# \text{ nn walks of height } m \text{ on remaining } (n-k) \text{ qutrits}) \\ N &= \sum_{m=0}^n M_{m,n}^2. \end{aligned} \tag{6.1.5} \tag{6.1.6}$$

where nn means none-negative. The number of walks such that we start with zero and end with zero without going negative is given by the Catalan numbers. The same problem but ending with a positive height is given by a theorem, originally due to D. André (1887), the so called Ballot problem [125, p. 8]:

Theorem. (*D. André 1887*) *Let a, b be integers satisfying $1 \leq b \leq a$. The number of lattice paths $\mathcal{N}(p)$ joining the origina O to the point (a, b) and not touching the diagonal $x = y$ except at O is given by*

$$\mathcal{N}(p) = \frac{a-b}{a+b} \binom{a+b}{b}$$

In other words, given a ballot at the end of which candidates P, Q obtain a, b votes

respectively, the probability that P leads Q throughout the counting of votes is $\frac{a-b}{a+b}$.

First note that $a = b + 1$ gives the Catalan numbers. For us $a + b = m - k + 1$ and $a - b = m + 1$. Using this in Eq. 6.1.5 and taking care of the parity

$$M_{n,m} = \sum_{k=0}^{n-m} \frac{m+1}{n-k+1} \binom{n}{k} \binom{n-k+1}{\frac{1}{2}(n-k-m)} \quad (6.1.7)$$

$$k \rightarrow n - m - 2i \quad \sum_{i=0}^{(n-m)/2} \binom{n}{2i+m} \cdot \left\{ \binom{2i+m}{i} - \binom{2i+m}{i-1} \right\} \quad (6.1.8)$$

$$= \sum_{i \geq 0} \binom{n}{2i+m} \cdot \left\{ \binom{2i+m}{i} - \binom{2i+m}{i-1} \right\} \quad (6.1.8)$$

$$= n! (m+1) \sum_{i \geq 0} \frac{1}{(i+m+1)! (n-2i-m)!} \quad (6.1.9)$$

$$(6.1.10)$$

To check Eq. 6.1.7, we see that $M_n = 1$, corresponding to all left parentheses and

$$M_0 = \sum_{k=0}^n \frac{1}{n-k+1} \binom{n}{k} \binom{n-k+1}{\frac{1}{2}(n-k)} = \sum_{k=0}^n \binom{n}{k} C_{\frac{1}{2}(n-k)}$$

as expected. This count is also known as *Motzkin triangles* [126, p. 4]. Consequently the Schmidt numbers become $p_m \equiv \frac{M_m^2}{N}$ and the entanglement entropy is $H(n) = -\sum_{m=0}^n p_m \log_2 p_m$. Before making approximations, using Maple one can express

$$M_{m,n} = \frac{n! (m+1) {}_2F_1 \left(\left[-\frac{1}{2}(n-m), -\frac{1}{2}(n-m-1) \right], [m+2], 4 \right)}{\Gamma(m+1) \Gamma(n-m+1)}$$

where ${}_2F_1$ denotes Hypergeometric function.

For simplicity we have made the cut in the middle and will confine to this restric-

tion below. However, more generally, one can place the cut at site $1 \leq h \leq 2n - 1$ then

$$|\psi\rangle = \frac{1}{\sqrt{N}} \sum_{m=0}^{\min(h, 2n-h)} \left(\sum_{|x\rangle \in \mathcal{L}_m} |x\rangle \right) \left(\sum_{|y\rangle \in \mathcal{R}_m} |y\rangle \right)$$

where

$$\begin{aligned} \mathcal{L}_m &= \left\{ |s_m\rangle_{1\dots h} |s_m \in \{0, r, l\}^h \text{ with } m \text{ excess } l\text{'s} \right\} \\ \mathcal{R}_m &= \left\{ |s_m\rangle_{h+1\dots 2n} |s_m \in \{0, r, l\}^{2n-h} \text{ with } m \text{ excess } r\text{'s} \right\} \end{aligned}$$

and Schmidt numbers would become $p_m = \frac{M_{h,m} M_{2n-h,m}}{N}$, where $M_{h,m}$ is defined as above but of height m on h sites, similarly for $M_{2n-h,m}$. The normalization being $N = \sum_{m=0}^{\min(h, 2n-h)} M_{h,m} M_{2n-h,m}$.

Now we analyze the sum given by Eq. 6.1.9 carefully,

$$M_{n,m} = (m+1) \sum_{i \geq 0} \frac{n!}{(i+m+1)! i! (n-2i-m)!}$$

First, though, let's do a little calculation. We will analyze a trinomial coefficient, where $x + y + z = 0$.

We first use Stirling's formula to get

$$\begin{aligned} \binom{n}{\frac{n}{3} + x \quad \frac{n}{3} + y \quad \frac{n}{3} + z} &= \left(\frac{54\pi n}{8\pi^3 (n+3x)(n+3y)(n+3z)} \right)^{1/2} \\ &\quad \left(\frac{n}{n+3x} \right)^{n/3+x} \left(\frac{n}{n+3y} \right)^{n/3+y} \left(\frac{n}{n+3z} \right)^{n/3+z} 3^n. \end{aligned}$$

Let's expand this by saying

$$\begin{aligned}
\left(\frac{n}{n+3x}\right)^{n/3+x} &= \exp\left(-\left(\frac{n}{3}+x\right)\ln\left(1+3\frac{x}{n}\right)\right) \\
&\approx \exp\left(-\frac{n}{3}\left(3\frac{x}{n}-\frac{1}{2}\cdot 9\frac{x^2}{n^2}\right)-3\frac{x^2}{n}\right) \\
&= \exp\left(-x-\frac{3x^2}{2n}\right).
\end{aligned}$$

Thus, since $x+y+z=0$, we get

$$\binom{n}{\frac{n}{3}+x \quad \frac{n}{3}+y \quad \frac{n}{3}+z} \approx \frac{3\sqrt{3}}{2\pi} \sqrt{\frac{n}{(n+3x)(n+3y)(n+3z)}} \exp\left(-\frac{3x^2+y^2+z^2}{2n}\right) 3^n.$$

Now, we take the formula for M_n , let $m = \alpha\sqrt{n}$ and $i = \frac{n}{3} + \beta\sqrt{n}$, and use this approximation. The term inside the square root is approximately $1/n^2$, so we make this substitution to get

$$\begin{aligned}
M_{n,m,i} &= \frac{(m+1)}{n+1} \binom{n+1}{i+m+1 \quad i \quad n-2i-m} \\
&\approx \frac{3\sqrt{3}}{2\pi n} \frac{\alpha\sqrt{n}}{n} \exp\left[\frac{-3}{2}((\alpha+\beta)^2 + \beta^2 + (\alpha+2\beta)^2)\right] 3^{n+1} \\
&= \frac{3\sqrt{3}}{2\pi n^{3/2}} \alpha \exp\left[\frac{-3}{2}(2\alpha^2 + 6\alpha\beta + 6\beta^2)\right] 3^{n+1} \\
&= \frac{3\sqrt{3}}{2\pi n^{3/2}} 3^{n+1} \alpha \exp(-3\alpha^2 - 9\alpha\beta - 9\beta^2).
\end{aligned}$$

We need to evaluate the sum of $M_{n,m,i}$ from $i=0$ to $i=n$. We approximate this by integrating over i . Since we have $i = \frac{n}{3} + \beta\sqrt{n}$, we get $di = \sqrt{n}d\beta$. Since the maximum is near $i = \frac{n}{3}$, we can turn this sum into an integral from $-\infty$ to ∞ . The

integral we need to evaluate is thus

$$\begin{aligned}
M_{n,m} &\approx \frac{3\sqrt{3}}{2\pi n^{3/2}} 3^{n+1} \alpha \int_{-\infty}^{\infty} \exp(-3\alpha^2 - 9\alpha\beta - 9\beta^2) \sqrt{n} d\beta \\
&= \frac{3\sqrt{3}}{2\pi n} 3^{n+1} \alpha \int_{-\infty}^{\infty} \exp\left(-9(\beta - \alpha/2)^2 - \frac{3}{4}\alpha^2\right) \sqrt{n} d\beta \\
&= \frac{\sqrt{3}}{2\sqrt{\pi n}} 3^{n+1} \alpha \exp\left(-\frac{3}{4}\alpha^2\right).
\end{aligned}$$

This is maximized when

$$\frac{d}{d\alpha} \alpha \exp\left(-\frac{3}{4}\alpha^2\right) = 0,$$

or $\alpha = \sqrt{2/3}$.

Now, we need to figure out the entropy of the probability distribution proportional to $M_{n,m}^2$. Recalling that $m = \alpha\sqrt{n}$, and noticing that the normalization factor cancels, the entropy is

$$H(\{M_{n,m}^2\}) \approx -\frac{1}{T} \sum_{m=0}^n \frac{m^2}{n} \exp\left(-\frac{3}{2} \frac{m^2}{n}\right) \log \left[\frac{1}{T} \frac{m^2}{n} \exp\left(-\frac{3}{2} \frac{m^2}{n}\right) \right]$$

where

$$T = \sum_{m=0}^n \frac{m^2}{n} \exp\left(-\frac{3}{2} \frac{m^2}{n}\right).$$

We can approximate the sum with an integral. Since the integrand goes to 0 rapidly, we can extend the upper limit of integration to ∞ , getting

$$H(\{M_{n,m}^2\}) \approx -\frac{1}{T'} \int_0^{\infty} \frac{m^2}{n} \exp\left(-\frac{3}{2} \frac{m^2}{n}\right) \log \left[\frac{1}{T'} \frac{m^2}{n} \exp\left(-\frac{3}{2} \frac{m^2}{n}\right) \right] dm,$$

where

$$T' = \int_{m=0}^{\infty} \frac{m^2}{n} \exp\left(-\frac{3}{2} \frac{m^2}{n}\right) dm.$$

Now, we can replace m/\sqrt{n} by α again. This gives

$$H(\{M_{n,m}^2\}) \approx \log \sqrt{n} - \frac{1}{T''} \int_0^\infty \alpha^2 \exp(-\frac{3}{2}\alpha^2) \log \left[\frac{1}{T''} \alpha^2 \exp\left(-\frac{3}{2}\alpha^2\right) \right] d\alpha,$$

where

$$T'' = \int_0^\infty \alpha^2 \exp(-\frac{3}{2}\alpha^2) d\alpha.$$

Here the extra $\log \sqrt{n}$ term comes from the fact that $T' = \sqrt{n}T''$. The integral is just a constant, so we can evaluate it to get

$$\begin{aligned} H(\{M_{n,m}^2\}) &\approx \frac{1}{2} \log n - \frac{1}{2} + \gamma + \frac{1}{2}(\log 2 + \log \pi - \log 3) \text{ nats} \quad (6.1.11) \\ &\approx \frac{1}{2} \log_2 n + 0.64466547 \text{ bits}, \end{aligned}$$

where γ is Euler's constant. In Figure 6.1.3 we compare Eq. 6.1.11 with numerical evaluation of Eq. 6.1.7.

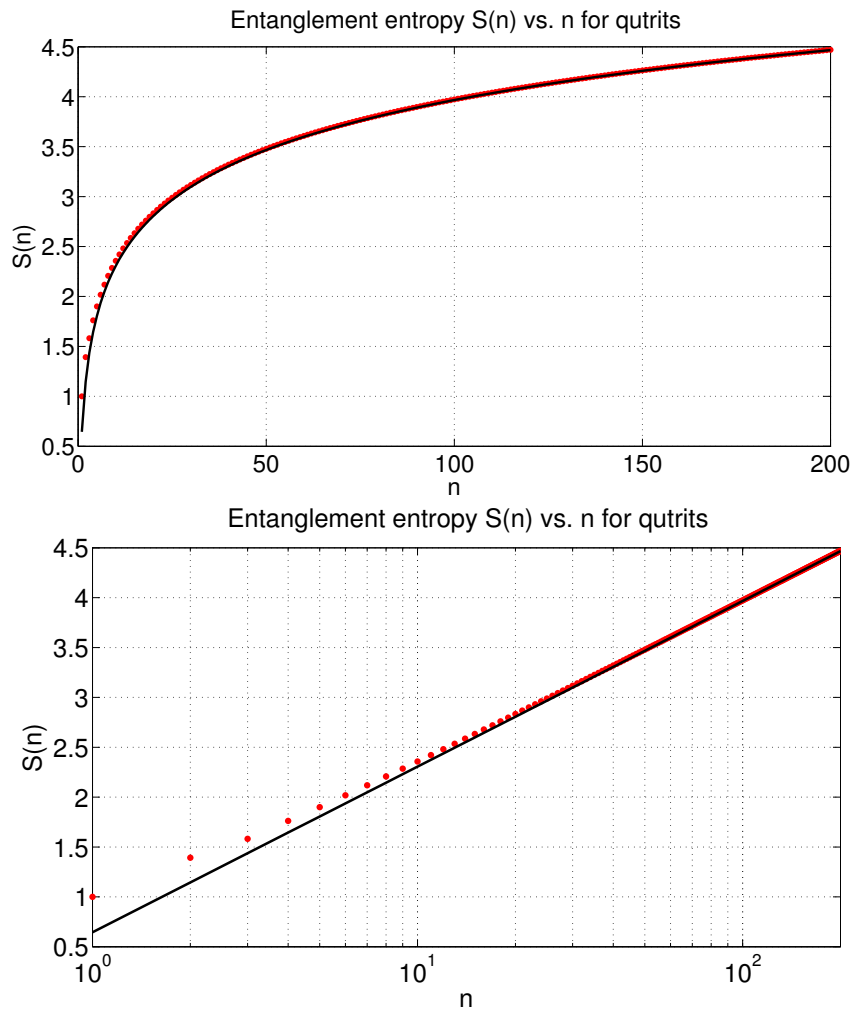

Figure 6.1.3: Entanglement entropy for the case of qutrits

6.2 Quantum 2-SAT for Mirror Symmetric States

$$(d = 4)$$

We describe an example of a quantum 2-SAT on a chain of $2n$ four-dimensional ($d = 4$) qudits which has a unique satisfying state with the Schmidt rank growing

exponentially with n [107].

Let A and B be the left and the right halves of the chain containing n qudits each, that is,

$$A = \{1, 2, \dots, n\} \quad \text{and} \quad B = \{n + 1, n + 2, \dots, 2n\}.$$

Basis states of each qudit will be labeled using the alphabet

$$\Sigma = \{0, \alpha, \beta, \gamma\}.$$

Let us first informally describe the idea behind the construction. The letters α, β, γ represent three ‘particle types’ while the state 0 represents the ‘vacuum’. The particles can propagate freely through the vacuum, although they cannot pass through each other. Furthermore, the boundary between A and B is impenetrable for α and β particles, while γ particles can propagate freely across the boundary. Let us first describe the role of α and β particles. The only place where α, β can be created or annihilated is the boundary between A and B . Specifically, one can create/annihilate pairs $\alpha\alpha$ or $\beta\beta$ from the vacuum at qudits $(n, n + 1)$. This will create a ‘gas’ of α and β particles such that the gas contained in A is the ‘mirror image’ of the gas contained in B if one ignores all zeroes. For example, $\alpha\alpha 000\beta : 0\beta\alpha 0\alpha 0$ represents an admissible gas of particles for $n = 6$ (here $:$ represents the boundary between A and B). All possible admissible configurations of the gas will appear in superposition in the ground state. The mirror symmetry between A and B will be responsible for the exponentially large Schmidt rank. To maintain the mirror symmetry will forbid pairs $\alpha\beta$ and $\beta\alpha$ on the boundary between A and B . This however is not sufficient by itself because it does not guarantee that A and B contain the same

number of particles. For example, a string $000 : \alpha\beta\alpha$ does not have forbidden pairs on the boundary but it cannot propagate to any other string. Such strings could give rise to unwanted ground states with no entanglement between A and B . This is where γ particles come to play. The rules for creation/annihilation of γ particles are as follows:

- Every α or β particle located in A can emit/absorb γ particle on its *right*, that is, $\alpha 0 \leftrightarrow \alpha\gamma$ and $\beta 0 \leftrightarrow \beta\gamma$.
- Every α or β particle located in B can emit/absorb γ particle on its *left*, that is, $0\alpha \leftrightarrow \gamma\alpha$ and $0\beta \leftrightarrow \gamma\beta$.
- γ particles are forbidden at qudits 1 and $2n$

Note that γ -particles cannot tell the difference between α and β particles, so they cannot maintain the mirror symmetry between A and B by themselves. The purpose of γ -particles is to ensure that the total number of α and β particles is the same in A and B . In the above example a string $000 : \alpha\beta\alpha$ can now propagate to a forbidden string: the leftmost α -particle in B emits γ -particle obtaining $00\gamma : \alpha\beta\alpha$ which now can propagate to a forbidden string $\gamma 00 : \alpha\beta\alpha$ since γ -particles can move freely through the vacuum. On the other hand, a balanced string like $00\alpha 0 : 00\alpha 0$ cannot propagate to a forbidden string since γ -particles are confined to the interval between the two α particles. We will prove below (see Lemma 8) that the only strings that cannot propagate to a forbidden string are those representing a gas of α, β particles where the intervals between adjacent particles may be filled by 0 's and γ 's and the gas contained in A is the mirror image of the gas contained in B (if one ignores all 0 's and all γ 's).

Let us now describe this construction more formally. We shall say that a pair of

strings $s, t \in \Sigma^{2n}$ is equivalent, $s \sim t$, iff one can obtain s from t by a sequence of local moves listed below. These moves can be applied to some pairs of consecutive qudits $(j, j + 1)$. We say that the pair is inside A iff $1 \leq j \leq n - 1$. We say that the pair is inside B iff $n + 1 \leq j \leq 2n - 1$. We say that the pair is on the boundary iff $j = n$.

Move 1: $0\alpha \leftrightarrow \alpha 0, 0\beta \leftrightarrow \beta 0, 0\gamma \leftrightarrow \gamma 0$ (inside A or inside B)

Move 2: $\alpha 0 \leftrightarrow \alpha\gamma, \beta 0 \leftrightarrow \beta\gamma$ (inside A or on the boundary)

Move 3: $0\alpha \leftrightarrow \gamma\alpha, 0\beta \leftrightarrow \gamma\beta$ (inside B or on the boundary)

Move 4: $00 \leftrightarrow \alpha\alpha, 00 \leftrightarrow \beta\beta, 0\gamma \leftrightarrow \gamma 0$ (on the boundary)

In addition to these moves we shall impose several constraints:

Constraint 1: Pairs $\alpha\beta, \beta\alpha$ are forbidden on the boundary.

Constraint 2: The first qudit of A is not γ .

Constraint 3: The last qudit of B is not γ .

Definition 3. A string $s \in \Sigma^{2n}$ is called good iff all strings in the equivalence class of s obey Constraints 1,2,3. Otherwise a string s is called bad.

Given a pair of strings $s, s' \in \{\alpha, \beta\}^m$, we shall say that s' is the mirror image of s iff $s'_i = s_{m-i+1}$ for all $i = 1, \dots, m$. For any string $s \in \Sigma^{2n}$ let us denote s_A and s_B the restrictions of s onto A and B .

Definition 4. A string $s = (s_A, s_B) \in \Sigma^{2n}$ has mirror symmetry iff after removing all zeroes and all γ 's the strings s_A and s_B become mirror images of each other.

Lemma 8. *A string is good iff it has mirror symmetry, the leftmost particle in A (if any) is α or β , and the rightmost particle in B (if any) is α or β . Any good string is equivalent to the all-zeroes string.*

Proof. Let $s = (s_A, s_B) \in \Sigma^{2n}$ be any good string. It is clear that the leftmost particle in A cannot be γ since otherwise Move 1 would propagate γ to the first qudit of A violating Constraint 2. By the same reason the rightmost particle in B cannot be γ . Let us show that s has mirror symmetry. If both s_A, s_B are all-zeroes strings we are done, so let us assume that s_A contains at least one non-zero. Suppose s_A contains at least one γ . Consider the left-most γ and push it to the left until it gets absorbed by α or β (Move 2). Applying this to every γ -particle in s_A we can assume that s_A contains only 0, α , and β . Applying Move 1 we can transform s_A to the following canonical form

$$s_A = (\underbrace{0 \dots 0}_{n-m}, x_1, \dots, x_m) \quad \text{where } x = (x_1, \dots, x_m) \in \{\alpha, \beta\}^m$$

for some $m > 0$. If s_B is all-zeroes string, we can apply Move 2 to the rightmost particle in A (which is $x_m \in \{\alpha, \beta\}$) to emit γ -particle, $x_m 0 \rightarrow x_m \gamma$. Propagating this γ -particle to the last qudit of B we violate Constraint 3. It shows that s_B must contain at least one α or β . Using the same arguments as above, we can apply Moves 1,3 to transform s_B into canonical form

$$s_B = (y_k, \dots, y_1, \underbrace{0 \dots 0}_{n-k}) \quad \text{where } y = (y_k, \dots, y_1) \in \{\alpha, \beta\}^k$$

for some $k > 0$. Using Move 4 and keeping in mind that s satisfies Constraint 1, we can consecutively annihilate all pairs $x_i y_i$ until we arrive at $s_A = 0$ or $s_B = 0$. However the same arguments as above show that if $s_A = 0$ then the string s_B cannot contain α or β , that is, $s_B = 0$ (and vice versa). Thus we proved that any good string is equivalent to the all-zeroes string. Since all moves used above preserve the mirror symmetry, we also proved that any good string has mirror symmetry.

Conversely, suppose a string $s \in \Sigma^{2n}$ has mirror symmetry, the leftmost particle in A (if any) is α or β , and the rightmost particle in B (if any) is α or β . Let t be any string equivalent to s . We have to show that t obeys Constraints 1,2,3. Since all Moves 1,2,3 preserve the order of α , β particles in A and B , it clear that t satisfies Constraint 1. Since α or β particles located in A can emit γ particles only on their right (Move 2), no γ particle emitted in A can violate Constraint 2. A γ -particle emitted in B or on the boundary (Move 3) can violate Constraint 2 only if B contains at least one α or β particle while A does not. However this contradicts to the mirror symmetry. Thus t satisfies Constraint 2. The same arguments show that t satisfies Constraint 3. \square

Consider a state $|\psi_{2n}\rangle \in (\mathbb{C}^4)^{\otimes 2n}$ defined as the uniform superposition of all good strings,

$$|\psi_{2n}\rangle = \sum_{\substack{s \in \Sigma^{2n} \\ s \text{ is good}}} |s\rangle.$$

Lemma 9. *The state $|\psi_{2n}\rangle$ considered as a bipartite state shared by A and B has Schmidt rank*

$$\chi_n = 2^{n+1} - 1. \tag{6.2.1}$$

Proof. Indeed, the Schmidt basis of $|\psi_{2n}\rangle$ can be easily constructed using Lemma 8. Choose any integer $m \in [0, n]$ and any string $x \in \{\alpha, \beta\}^m$. Let $|A(m, x)\rangle$ be the uniform superposition of all strings $s \in \Sigma^n$ of the form

$$s = (Z_0, x_1, Z_1, x_2, Z_2, \dots, x_m, Z_m),$$

where Z_0 is a string of zeroes, and Z_1, \dots, Z_m are arbitrary strings of zeroes and γ 's. Any of the strings Z_0, \dots, Z_m can be empty. Similarly, let $|B(m, x)\rangle$ be the uniform

superposition of all strings $s \in \Sigma^n$ of the form

$$s = (Z_m, x_m, Z_{m-1}, x_{m-1}, \dots, Z_1, x_1, Z_0),$$

where Z_0 is a string of zeroes, and Z_1, \dots, Z_m are arbitrary strings of zeroes and γ 's. Any of the strings Z_0, \dots, Z_m can be empty. Using the characterization of good strings given by Lemma 8 we conclude that

$$|\psi_{2n}\rangle = \sum_{m=0}^n \sum_{x \in \{\alpha, \beta\}^m} |A(m, x)\rangle \otimes |B(m, x)\rangle$$

is the Schmidt decomposition of $|\psi_{2n}\rangle$ (up to normalization of the Schmidt basis vectors). It immediately implies Eq. (6.2.1). \square

Since the set of good strings is specified by 2-local moves and constraints, we can specify the state $|\psi_{2n}\rangle$ by 2-local projectors acting on nearest-neighbor qudits. Define auxiliary states

$$\begin{aligned} |M_\alpha\rangle &\sim |0\alpha\rangle - |\alpha 0\rangle \\ |M_\beta\rangle &\sim |0\beta\rangle - |\beta 0\rangle \\ |M_\gamma\rangle &\sim |0\gamma\rangle - |\gamma 0\rangle \\ |-\rangle &\sim |0\rangle - |\gamma\rangle \\ |C_\alpha\rangle &\sim |00\rangle - |\alpha\alpha\rangle \\ |C_\beta\rangle &\sim |00\rangle - |\beta\beta\rangle \end{aligned}$$

We assume that all above states are normalized. Define a propagation Hamiltonian $H^{prop, A}$ responsible for ‘implementing’ Moves 1,2 for consecutive pairs of qudits inside A , namely

$$H^{\text{PROP},A} = |M_\alpha\rangle\langle M_\alpha| + |M_\beta\rangle\langle M_\beta| + |M_\gamma\rangle\langle M_\gamma| \\ + |\alpha\rangle\langle\alpha| \otimes |-\rangle\langle-| + |\beta\rangle\langle\beta| \otimes |-\rangle\langle-|$$

Define a propagation Hamiltonian $H^{\text{prop},B}$ responsible for ‘implementing’ Moves 1,3 for consecutive pairs of qudits inside B , namely

$$H^{\text{PROP},B} = |M_\alpha\rangle\langle M_\alpha| + |M_\beta\rangle\langle M_\beta| + |M_\gamma\rangle\langle M_\gamma| \\ + |-\rangle\langle-| \otimes |\alpha\rangle\langle\alpha| + |-\rangle\langle-| \otimes |\beta\rangle\langle\beta|$$

Define a propagation Hamiltonian $H^{\text{prop},AB}$ responsible for ‘implementing’ Moves 2,3,4 on the boundary, namely

$$H^{\text{PROP},AB} = |M_\gamma\rangle\langle M_\gamma| + |\alpha\rangle\langle\alpha| \otimes |-\rangle\langle-| + |\beta\rangle\langle\beta| \otimes |-\rangle\langle-| \\ + |-\rangle\langle-| \otimes |\alpha\rangle\langle\alpha| + |-\rangle\langle-| \otimes |\beta\rangle\langle\beta| + |C_\alpha\rangle\langle C_\alpha| + |C_\beta\rangle\langle C_\beta|$$

This Hamiltonian acts on the pair of qudits $(n, n+1)$. Finally, define Hamiltonians imposing Constraints 1,2,3, namely,

$$H^{\text{CON},A} = |\gamma\rangle\langle\gamma|_1, \quad H^{\text{CON},B} = |\gamma\rangle\langle\gamma|_{2n}, \quad H^{\text{CON},AB} = |\alpha\beta\rangle\langle\alpha\beta| + |\beta\alpha\rangle\langle\beta\alpha|.$$

Here $H^{\text{con},AB}$ acts on the pair of qudits $(n, n+1)$.

Lemma 10. *The state $|\psi_{2n}\rangle$ is the unique state annihilated by all the Hamiltonians $H^{prop,A}$, $H^{prop,B}$, $H^{prop,AB}$, $H^{con,A}$, $H^{con,B}$, and $H^{con,AB}$.*

Proof. Indeed let H be Hamiltonian defined as the sum of all above Hamiltonians. It is clear that $|\psi_{2n}\rangle$ is annihilated by H . Since H is a stoquastic Hamiltonian, it suffices to consider ground states $|\psi\rangle$ with real non-negative amplitudes. If $|\psi\rangle$ has a positive amplitude on some string s , the propagation Hamiltonians ensure that $|\psi\rangle$ has the same amplitude on any string equivalent to s . The Hamiltonians implementing the constraints then ensure that only good strings can appear in $|\psi\rangle$. Lemma 8 implies that there is only one equivalence class of good strings. Hence H has unique ground state $|\psi_{2n}\rangle$. \square

6.2.1 Entanglement entropy

Recall that we impose three **constraints** on the states of the $2n$ qudits:

1. Pairs $\alpha\beta$ and $\beta\alpha$ are forbidden at the boundary.
2. The first qudit of A is not γ .
3. The last qudit of B is not γ .

The particles γ can propagate freely through the the vacuum state given by 0 states.

We want to count the number of mirror symmetric states that obey the constraints 2 and 3 (the first constraint is implied by mirror symmetry). First let us ask: how many strings can there be in A alone? Well out of the 4^n possible strings the ones that violate constraint 2 need to be excluded (we are not worrying about B yet). The complete list of the excluded states is (each row represents a forbidden string in s_A)

$$\begin{array}{rcl}
\gamma \# \# \# \# & : & 4^{n-1} \\
0 \ \gamma \# \# \# & : & 4^{n-2} \\
0 \ 0 \ \gamma \# \# & : & 4^{n-3} \\
& & \vdots \\
0 \ 0 \ 0 \ 0 \ \gamma & : & 1
\end{array} \tag{6.2.2}$$

where $\# \in \{\alpha, \beta, \gamma, 0\}$ denotes any state and the counts are written to the right. Therefore, the total number of possible strings in s_A is,

$$\text{Number of allowed strings in } s_A = 4^n - \sum_{k=0}^{n-1} 4^k.$$

Definition. (m -dense string) A string of size m is m -dense if it has no 0's or γ 's.

We wish to find the number of symmetric states where every string on A is m -dense (i.e., there are m qudits on A that are not γ or 0). The number of mirror symmetric states becomes

$$(\text{Count of } n - m \text{ particles of type } 0, \gamma \text{ in } A)^2 \left\{ \binom{m}{0} + \binom{m}{1} + \dots + \binom{m}{m} \right\} \tag{6.2.3}$$

$$= (\text{Count of } n - m \text{ particles of type } 0, \gamma \text{ in } A)^2 \frac{2^m}{2^m} \tag{6.2.4}$$

where as before $\left\{ \binom{m}{0} + \binom{m}{1} + \dots + \binom{m}{m} \right\}$ is the number of ways that α and β particles can be positioned in m slots. To find the number of allowed m -dense strings in A we first count all possible (unconstrained) ways of putting $n - m$ of 0 or γ particles and m of α and β particles on the n qudits. We then subtract from it the forbidden states. The total number of ways one can have an m -dense chain is

where, $1 \leq k \leq n - m$ is the first $k - 1$ zeros followed by a γ ; # is means *it can be any state as long as we have a total of $n - m$ of 0's and γ 's and m of α, β* . The number of states that need to be excluded are therefore

$$\text{number of } m - \text{dense states to exclude} = \sum_{k=1}^{n-m} \binom{n-k}{m} 2^{n-k}. \quad (6.2.6)$$

Comment: Mathematica erroneously expresses the foregoing equation in terms of a Hypergeometric function, that has poles for integer n .

In summary the number of allowed m -dense state on the n qudits are

$$\binom{n}{m} 2^n - \sum_{k=1}^{n-m} \binom{n-k}{m} 2^{n-k}. \quad (6.2.7)$$

The ground states are

$$|\psi\rangle = \sum_{m=0}^n \sum_{x \in \{\alpha, \beta\}^m} |A(m, x)\rangle \otimes |B(m, x)\rangle$$

The number of ways that $0, \gamma$ can be put on n qudits are

$$M_{m,n} \equiv 2^{n-m} \left\{ \binom{n}{m} - \sum_{k=1}^{n-m} \binom{n-k}{m} 2^{-k} \right\}. \quad (6.2.8)$$

Consequently, the Schmidt numbers are $p_{m,n} \equiv \frac{M_{m,n}^2}{N}$ where $M_{m,n}$ is given by Eq. 6.2.8 and $N \equiv \sum_{m=0}^n 2^m M_{m,n}^2$ is the normalization constant. The entanglement entropy becomes

$$H(\{p_{m,n}\}) = - \sum_{m=0}^n 2^m p_{m,n} \log_2 p_{m,n}. \quad (6.2.9)$$

Let us rewrite Eq. 6.2.8 as

$$M_{m,n} = 2^{n-m} \binom{n}{m} \quad (6.2.10)$$

$$\times \left\{ 1 - \frac{1}{2} \left(1 - \frac{m}{n}\right) - \dots - \frac{1}{2^{n-m}} \left(1 - \frac{m}{n}\right) \dots \left(1 - \frac{m}{m+1}\right) \right\} \quad (6.2.11)$$

$$\simeq 2^{n-m} \binom{n}{m} \left\{ 1 - \sum_{k=1}^{n-m} r^k \right\} = 2^{n-m+1} \binom{n}{m} \frac{m}{n+m}$$

where $r = \frac{1}{2} \left(1 - \frac{m}{n}\right)$. Next we use Stirling's approximation $n! \sim (n/e)^n \sqrt{2\pi n}$, similarly for $m!$ and $(n-m)!$, to obtain (below all the logarithms are in base 2 unless stated otherwise)

$$M_{m,n}^2 = \frac{2nm}{\pi(n-m)} \frac{\exp[f(m,n)]}{(n+m)^2}, \quad (6.2.12)$$

$$f(n,m) \equiv 2[(n-m) \log(2) + n \log n - m \log m - (n-m) \log(n-m)]$$

Let $m = \alpha n$, giving

$$M_{\alpha,n}^2 = \frac{2\alpha}{\pi n(1-\alpha)} \frac{\exp[nf(\alpha)]}{(1+\alpha)^2},$$

$$f(\alpha) \equiv 2[(1-\alpha) \log(2) + \log n - \alpha \log \alpha n - (1-\alpha) \log n(1-\alpha)] \quad (6.2.13)$$

$$= 2[(\alpha-1) \log(1-\alpha) - \alpha \log \alpha + (1-\alpha) \log(2)] \quad (6.2.14)$$

$$N = \sum_{m=0}^n 2^m M_{m,n}^2 = \sum_{m=0}^n \frac{2nm \exp [g(n, m)]}{\pi (n-m)(n+m)^2}$$

$$g(n, m) \equiv f(n, m) + m \log 2.$$

We can approximate this sum with an integral over α

$$N \simeq \int_0^1 d\alpha \frac{2\alpha \exp [ng(\alpha)]}{\pi (1-\alpha)(1+\alpha)^2}, \quad (6.2.15)$$

$$g(\alpha) \equiv f(\alpha) + \alpha \log 2$$

$$= 2 \left[(\alpha - 1) \log (1 - \alpha) - \alpha \log \alpha - \frac{\alpha}{2} \log 2 + \log (2) \right],$$

note that the factor of n cancelled because of change of variables from m to α . In anticipation of the steepest descent approximation to the entanglement entropy, we evaluate

$$g' \equiv \frac{\partial g(\alpha)}{\partial \alpha} = 2 \left[\log (1 - \alpha) - \log \alpha - \frac{1}{2} \log 2 \right]$$

$$g'' \equiv \frac{\partial^2 g(\alpha)}{\partial \alpha^2} = 2 \left[\frac{1}{\alpha(\alpha - 1)} \right].$$

$g' = 0 \Rightarrow \alpha_0 = \frac{1}{1+\sqrt{2}} = \sqrt{2} - 1$ and $g''(\alpha_0) = -\sqrt{2}(3 + 2\sqrt{2})$, which implies α_0 is a maximum. Let us proceed in calculating the entanglement entropy given by $H(m, n) = -\sum_{m=0}^n 2^m \frac{M_m^2}{N} \log_2 \frac{M_m^2}{N}$ by first approximating the sum with an integral over α and then performing the steepest descent approximation (in nats)

$$\begin{aligned}
H(\{M(\alpha, n)\}) &\simeq -\frac{1}{N} \int_0^1 d\alpha \frac{2\alpha \exp[ng(\alpha)]}{\pi(1-\alpha)(1+\alpha)^2} \log \frac{M^2(\alpha, n)}{N} \\
&\simeq -\log \frac{M^2(\alpha_0, n)}{N} \left\{ \frac{1}{N} \int_0^1 d\alpha \frac{2\alpha \exp[ng(\alpha)]}{\pi(1-\alpha)(1+\alpha)^2} \right\} \\
&\simeq -\log \frac{M^2(\alpha_0, n)}{N},
\end{aligned}$$

by the definition of N . It remains to calculate $-\log \frac{M^2(\alpha_0, n)}{N}$

$$\begin{aligned}
-\log \frac{M^2(\alpha_0, n)}{N} &= -\log \frac{\frac{1}{n} \exp[nf(\alpha_0)]}{\int_0^1 d\alpha \exp[ng(\alpha)]} \\
&\simeq -\log \frac{\frac{1}{n} \exp[nf(\alpha_0)]}{\int_{-\infty}^{+\infty} d\alpha \exp\left\{n\left[g(\alpha_0) + \frac{1}{2}g''(\alpha_0)(\alpha - \alpha_0)^2\right]\right\}} \\
&= -\log \left\{ \frac{1}{n} \exp[nf(\alpha_0) - ng(\alpha_0)] \sqrt{\frac{n|g''(\alpha_0)|}{2\pi}} \right\} \\
&= -\log \left\{ \exp[-n\alpha_0 \log 2] \sqrt{\frac{(3+2\sqrt{2})}{n\sqrt{2}\pi}} \right\}.
\end{aligned}$$

Expanding this we obtain

$$\begin{aligned}
H(\{M(\alpha, n)\}) &\simeq (\sqrt{2} - 1)n \log 2 + \frac{1}{2} \log n + \frac{1}{2} \log \left(\frac{\sqrt{2}\pi}{3+2\sqrt{2}} \right) \quad \text{nats} \\
&= (\sqrt{2} - 1)n + \frac{1}{2} \log_2 n + \frac{1}{2} \log_2 \left(\frac{\sqrt{2}\pi}{3+2\sqrt{2}} \right) \quad \text{bits.}
\end{aligned}$$

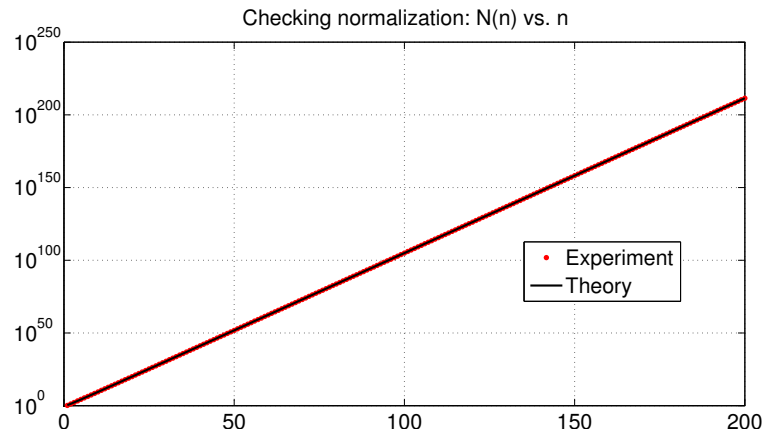

Figure 6.2.1: Normalization as a function of n .

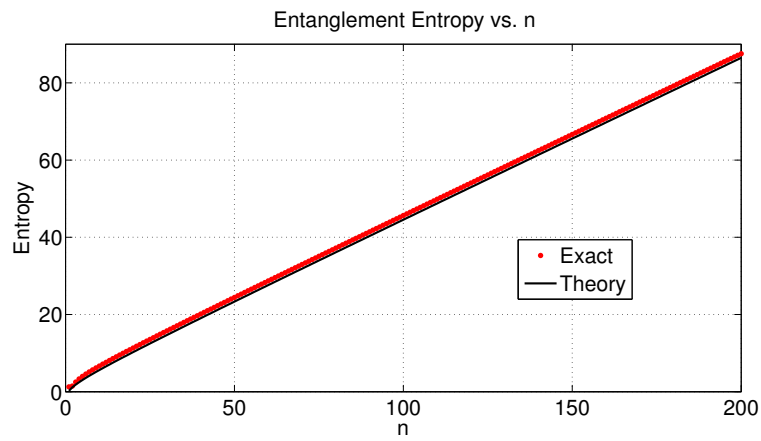

Figure 6.2.2: Entropy $H(\{M_m^2\})$ vs. n for $d = 4$ case. We include the figure on left to demonstrate the closeness of the approximation.

Chapter 7

Criticality Without Frustration for Quantum Spin-1 Chains

In the previous chapter we showed two examples of FF qudit chains with high entanglement and introduced the mathematical techniques needed for calculating their entanglement entropies. Here we elaborate on the $d = 3$ model- balanced parenthesis model. While FF spin-1/2 chains are known to have unentangled ground states, the case $s=1$ remains less explored. We propose the first example of a FF translation-invariant spin-1 chain that has a unique highly entangled ground state and exhibits some signatures of a critical behavior. The rest of this chapter also appears in [109].

7.1 Motivation

The presence of long-range entanglement in the ground states of critical spin chains with only short-range interactions is one of the most fascinating discoveries in the theory of quantum phase transitions [42, 110, 111]. It can be quantified by the

scaling law $S(L) \sim \log L$, where $S(L)$ is the entanglement entropy of a block of L spins. In contrast, non-critical spin chains characterized by a non-vanishing energy gap obey an area law [112, 113, 114] asserting that $S(L)$ has a constant upper bound independent of L .

One can ask how stable is the long-range ground state entanglement against small variations of Hamiltonian parameters? The scaling theory predicts [110, 115] that a chain whose Hamiltonian is controlled by some parameter g follows the law $S(L) \sim \log L$ only if L does not exceed the correlation length $\xi \sim |g - g_c|^{-\nu}$, where $\nu > 0$ is the critical exponent and g_c is the critical point. For larger L the entropy $S(L)$ saturates at a constant value. Hence achieving the scaling $S(L) \sim \log L$ requires fine-tuning of the parameter g with precision scaling polynomially with $1/L$ posing a serious experimental challenge.

The stringent precision requirement described above can be partially avoided for spin chains described by *frustration-free* Hamiltonians. Well-known (non-critical) examples of such Hamiltonians are the Heisenberg ferromagnetic chain [116], the AKLT model [117], and parent Hamiltonians of matrix product states [44, 118]. More generally, we consider Hamiltonians of a form $H = \sum_j g_j \Pi_{j,j+1}$, where $\Pi_{j,j+1}$ is a projector acting on spins $j, j+1$ and $g_j > 0$ are some coefficients. The Hamiltonian is called frustration-free (FF) if the projectors $\Pi_{j,j+1}$ have a common zero eigenvector ψ . Such zero eigenvectors ψ span the ground subspace of H . Clearly, the ground subspace does not depend on the coefficients g_j as long as they remain positive. This inherent stability against variations of the Hamiltonian parameters motivates a question of whether FF Hamiltonians can describe critical spin chains.

In this Letter we propose a toy model describing a FF translation-invariant spin-1 chain with open boundary conditions that has a unique ground state with a logarithmic scaling of entanglement entropy and a polynomial energy gap. Thus our FF

model reproduces some of the main signatures of critical spin chains. In contrast, it was recently shown by Chen et al [119] that any FF spin-1/2 chain has an unentangled ground state. Our work may also offer valuable insights for the problem of realizing long-range entanglement in open quantum systems with an engineered dissipation. Indeed, it was shown by Kraus et al [120] and Verstraete et al [121] that the ground state of a FF Hamiltonian can be represented as a unique steady state of a dissipative process described by the Lindblad equation with local quantum jump operators. A proposal for realizing such dissipative processes in cold atom systems has been made by Diehl et al [122].

Main results. We begin by describing the ground state of our model. The three basis states of a single spin will be identified with a left bracket $l \equiv [$, right bracket $r \equiv]$, and an empty space represented by 0. Hence a state of a single spin can be written as $\alpha|0\rangle + \beta|l\rangle + \gamma|r\rangle$ for some complex coefficients α, β, γ . For a chain of n spins, basis states $|s\rangle$ correspond to strings $s \in \{0, l, r\}^n$. A string s is called a *Motzkin path* [123, ?] iff (i) any initial segment of s contains at least as many l 's as r 's, and (ii) the total number of l 's is equal to the total number of r 's. For example, a string $llr0rl0rr$ is a Motzkin path while $l0lrrrllr$ is not since its initial segment $l0lrrr$ has more r 's than l 's. By ignoring all 0's one can view Motzkin paths as balanced strings of left and right brackets. We shall be interested in the *Motzkin state* $|\mathcal{M}_n\rangle$ which is the uniform superposition of all Motzkin paths of length n . For example, $|\mathcal{M}_2\rangle \sim |00\rangle + |lr\rangle$, $|\mathcal{M}_3\rangle \sim |000\rangle + |lr0\rangle + |l0r\rangle + |0lr\rangle$, and

$$\begin{aligned}
|\mathcal{M}_4\rangle \sim & |0000\rangle + |00lr\rangle + |0l0r\rangle + |l00r\rangle \\
& + |0l0r\rangle + |l0r0\rangle + |lr00\rangle + |llrr\rangle + |lr0r\rangle.
\end{aligned}$$

Let us first ask how entangled is the Motzkin state. For a contiguous block of spins

A , let $\rho_A = \text{Tr}_{j \notin A} |\mathcal{M}_n\rangle\langle\mathcal{M}_n|$ be the reduced density matrix of A . Two important measures of entanglement are the Schmidt rank $\chi(A)$ equal to the number of non-zero eigenvalues of ρ_A , and the entanglement entropy $S(A) = -\text{Tr} \rho_A \log_2 \rho_A$. We will choose A as the left half of the chain, $A = \{1, \dots, n/2\}$. We show that

$$\chi(A) = 1 + n/2 \quad \text{and} \quad S(A) = \frac{1}{2} \log_2 n + c_n \quad (7.1.1)$$

where $\lim_{n \rightarrow \infty} c_n = 0.14(5)$. The linear scaling of the Schmidt rank stems from the presence of locally unmatched left brackets in A whose matching right brackets belong to the complementary region $B = [1, n] \setminus A$. The number of the locally unmatched brackets m can vary from 0 to $n/2$ and must be the same in A and B leading to long-range entanglement between the two halves of the chain.

Although the definition of Motzkin paths may seem very non-local, we will show that the state $|\mathcal{M}_n\rangle$ can be specified by imposing local constraints on nearest-neighbor spins. Let Π be a projector onto the three-dimensional subspace of $\mathbb{C}^3 \otimes \mathbb{C}^3$ spanned by states $|0l\rangle - |l0\rangle$, $|0r\rangle - |r0\rangle$, and $|00\rangle - |lr\rangle$. Our main result is the following.

Theorem 1. *The Motzkin state $|\mathcal{M}_n\rangle$ is a unique ground state with zero energy of a frustration-free Hamiltonian*

$$H = |r\rangle\langle r|_1 + |l\rangle\langle l|_n + \sum_{j=1}^{n-1} \Pi_{j,j+1}, \quad (7.1.2)$$

where subscripts indicate spins acted upon by a projector. The spectral gap¹ of H scales polynomially with $1/n$.

¹Here and below the spectral gap of a Hamiltonian means the difference between the smallest and the second smallest eigenvalue.

The theorem remains true if H is modified by introducing arbitrary weights $g_j \geq 1$ for every projector in Eq. (7.1.2). A polynomial lower bound on the spectral gap of H is, by far, the most difficult part of Theorem 1. Our proof consists of several steps. First, we use a perturbation theory to relate the spectrum of H to the one of an effective Hamiltonian H_{eff} acting on Dyck paths — balanced strings of left and right brackets². This step involves successive applications of the Projection Lemma due to Kempe et al [129]. Secondly, we map H_{eff} to a stochastic matrix P describing a random walk on Dyck paths in which transitions correspond to insertions/removals of consecutive lr pairs. The key step of the proof is to show that the random walk on Dyck paths is rapidly mixing. Our method of proving the desired rapid mixing property employs the polyhedral description of matchings in bipartite graphs [130]. This method appears to be new and might be interesting on its own right. Exact diagonalization performed for short chains suggests that the spectral gap of H scales as $\Delta \sim 1/n^3$, see Fig. 7.1.1. Our proof gives an upper bound $\Delta = O(n^{-1/2})$ and a lower bound $\Delta = \Omega(n^{-c})$ for some $c \gg 1$.

Previous work. Examples of spin chain Hamiltonians with highly entangled ground states have been constructed by Gottesman and Hastings [131], and Irani [132] for local dimension $d = 9$ and $d = 21$ respectively (here and below $d \equiv 2s + 1$). These models exhibit a linear scaling of the entropy $S(L)$ for some blocks of spins while the spectral gap is polynomial in $1/n$. The model found in [132] is FF and translation-invariant. Ref. [133] focused on ‘generic’ spin chains with a Hamiltonian $H = \sum_j \Pi_{j,j+1}$ where the projectors $\Pi_{j,j+1}$ are chosen randomly with

²One can regard Dyck paths as a special case of Motzkin paths in which no ‘0’ symbols are allowed.

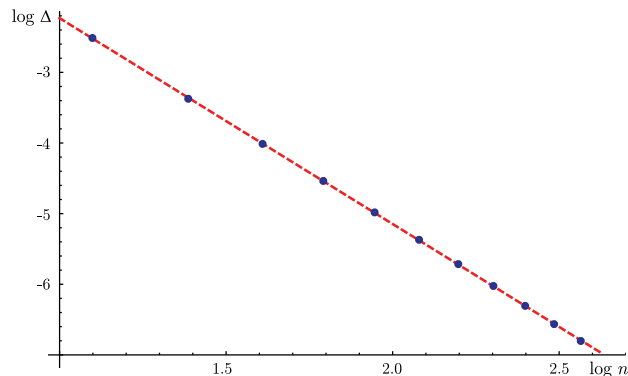

Figure 7.1.1: The spectral gap Δ of the Hamiltonian H defined in Eq. (7.1.2) for $3 \leq n \leq 13$ obtained by the exact diagonalization. The dashed line shows a linear fit $\log \Delta = 0.68 - 2.91 \log n$. Our numerics suggests that the first excited state of H belongs to the subspace spanned by strings with exactly one unmatched bracket.

a fixed rank r ³. The authors of [133] identified three important regimes: (i) frustrated chains, $r > d^2/4$, (ii) FF chains, $d \leq r \leq d^2/4$, and (iii) FF chains with product ground states, $r < d$. It was conjectured in [133] that generic FF chains in the regime $d \leq r \leq d^2/4$ have only highly entangled ground states with probability one. This regime however requires local dimension $d \geq 4$. The new model based on Motzkin paths corresponds to the case $d = r = 3$ (ignoring the boundary terms) and thus it can be frustrated by arbitrarily small deformations of the projectors making them generic. In addition, results of [133] imply that examples of FF spin-1 chains with highly entangled ground states have measure zero in the parameter space. The question of whether matrix product states specified by FF parent Hamiltonians can exhibit quantum phase transitions has been studied by Wolf et al [135]. However, the models studied in [135] have bounded entanglement entropy, $S(L) = O(1)$.

Hamiltonian. Let us now construct a FF Hamiltonian H whose unique ground

³Though the results of Ref. [133] are applicable to more general Hamiltonians, the convenient restriction to random projectors is sufficient for addressing the degeneracy and frustration condition.

state is $|\mathcal{M}_n\rangle$. First we need to find a more local description of Motzkin paths. Let $\Sigma = \{0, l, r\}$. We will say that a pair of strings $s, t \in \Sigma^n$ is equivalent, $s \sim t$, if s can be obtained from t by a sequence of local moves

$$00 \leftrightarrow lr, \quad 0l \leftrightarrow l0, \quad 0r \leftrightarrow r0. \quad (7.1.3)$$

These moves can be applied to any consecutive pair of letters. For any integers $p, q \geq 0$ such that $p + q \leq n$ define a string

$$c_{p,q} \equiv \underbrace{r \dots r}_p \underbrace{0 \dots 0}_{n-p-q} \underbrace{l \dots l}_q.$$

Lemma 1. *Any string $s \in \Sigma^n$ is equivalent to one and only one string $c_{p,q}$. A string $s \in \Sigma^n$ is a Motzkin path iff it is equivalent to the all-zeros string, $s \sim c_{0,0}$.*

Proof. Indeed, applying the local moves Eq. (7.1.3) one can make sure that s does not contain substrings lr or $l0 \dots 0r$. If this is the case and s contains at least one l , then all letters to the right of l are l or 0 . Similarly, if s contains at least one r , then all letters to the left of r are r or 0 . Since we can swap 0 with any other letter by the local moves, s is equivalent to $c_{p,q}$ for some p, q . It remains to show that different strings $c_{p,q}$ are not equivalent to each other. Let $L_j(s)$ and $R_j(s)$ be the number of l 's and r 's among the first j letters of s . Suppose $c_{p,q} \sim c_{p',q'}$ and $p \geq p'$. Then $R_p(s) - L_p(s) \leq p'$ for any string s equivalent to $c_{p',q'}$. This is a contradiction unless $p = p'$. Similarly one shows that $q = q'$. \square

The lemma shows that the set of all strings Σ^n can be partitioned into equivalence classes $C_{p,q}$, such that $C_{p,q}$ includes all strings equivalent to $c_{p,q}$. In other words, $s \in C_{p,q}$ iff s has p unmatched right brackets and q unmatched left brackets. Accordingly,

the set of Motzkin paths \mathcal{M}_n coincides with the equivalence class $C_{0,0}$.

Let us now define projectors ‘implementing’ the local moves in Eq. (7.1.3). Define normalized states

$$|\phi\rangle \sim |00\rangle - |lr\rangle, \quad |\psi^l\rangle \sim |0l\rangle - |l0\rangle, \quad |\psi^r\rangle \sim |0r\rangle - |r0\rangle$$

and a projector $\Pi = |\phi\rangle\langle\phi| + |\psi^l\rangle\langle\psi^l| + |\psi^r\rangle\langle\psi^r|$. Application of Π to a pair of spins $j, j+1$ will be denoted $\Pi_{j,j+1}$. If some state ψ is annihilated by every projector $\Pi_{j,j+1}$, it must have the same amplitude on any pair of equivalent strings, that is, $\langle s|\psi\rangle = \langle t|\psi\rangle$ whenever $s \sim t$. It follows that a Hamiltonian $H_\sim = \sum_{j=1}^{n-1} \Pi_{j,j+1}$ is FF and the ground subspace of H_\sim is spanned by pairwise orthogonal states $|C_{p,q}\rangle$, where $|C_{p,q}\rangle$ is the uniform superposition of all strings in $C_{p,q}$. The desired Motzkin state $|\mathcal{M}_n\rangle = |C_{0,0}\rangle$ is thus a ground state of H_\sim . (It is worth mentioning that not all states $|C_{p,q}\rangle$ are highly entangled. For example, $|C_{n,0}\rangle = |r\rangle^{\otimes n}$ is a product state.) How can we exclude the unwanted ground states $|C_{p,q}\rangle$ with $p \neq 0$ or $q \neq 0$? We note that $C_{0,0}$ is the only class in which strings never start from r and never end with l . Hence a modified Hamiltonian $H = |r\rangle\langle r|_1 + |l\rangle\langle l|_n + H_\sim$ that penalizes strings starting from r or ending with l has a unique ground state $|C_{0,0}\rangle$. This proves the first part of Theorem 1. We can also consider weighted Hamiltonians $H_\sim(g) = \sum_{j=1}^{n-1} g_j \Pi_{j,j+1}$ and $H(g) = g_0 |r\rangle\langle r|_1 + g_n |l\rangle\langle l|_n + H_\sim(g)$, where $g_0, \dots, g_n \geq 1$ are arbitrary coefficients. One can easily check that the ground state of $H(g)$ does not depend on g and $H(g) \geq H$. It implies that the spectral gap of $H(g)$ is lower bounded by the one of H .

Entanglement entropy. We can now construct the Schmidt decomposition of the Motzkin state. Let $A = \{1, \dots, n/2\}$ and $B = \{n/2+1, \dots, n\}$ be the two halves of the chain (we assume that n is even). For any string $s \in \Sigma^n$ let s_A and s_B be

the restrictions of s onto A and B . We claim that s is a Motzkin path iff $s_A \sim c_{0,m}$ and $s_B \sim c_{m,0}$ for some $0 \leq m \leq n/2$. Indeed, s_A (s_B) cannot have unmatched right (left) brackets, while each unmatched left bracket in s_A must be matched with some unmatched right bracket in s_B . It follows that the Schmidt decomposition of $|\mathcal{M}_n\rangle$ can be written as

$$|\mathcal{M}_n\rangle = \sum_{m=0}^{n/2} \sqrt{p_m} |\hat{C}_{0,m}\rangle_A \otimes |\hat{C}_{m,0}\rangle_B, \quad (7.1.4)$$

where $|\hat{C}_{p,q}\rangle$ is the normalized uniform superposition of all strings in $C_{p,q}$ and p_m are the Schmidt coefficients defined by

$$p_m = \frac{|C_{0,m}(n/2)|^2}{|C_{0,0}(n)|}. \quad (7.1.5)$$

Here we added an explicit dependence of the classes $C_{p,q}$ on n . For large n and m one can use an approximation $p_m \sim m^2 \exp(-3m^2/n)$, see the Supplementary Material for the proof. Note that p_m achieves its maximum at $m^* \approx \sqrt{n/3}$. Approximating the sum $\sum_m p_m = 1$ by an integral over $\alpha = m/\sqrt{n}$ one gets $p_m \approx n^{-1/2} q_{\alpha(m)}$, where q_{α} is a normalized pdf defined as

$$q_{\alpha} = Z^{-1} \alpha^2 e^{-3\alpha^2}, \quad Z \equiv \int_0^{\infty} d\alpha \alpha^2 e^{-3\alpha^2} = \frac{\sqrt{\pi}}{4 \cdot 3^{3/2}}.$$

It gives

$$S(A) = - \sum_m p_m \log_2 p_m \approx \log \sqrt{n} - \int_0^{\infty} d\alpha q_{\alpha} \log_2 q_{\alpha}.$$

Evaluating the integral over α yields Eq. (7.1.1). The approximation $p_m \approx n^{-1/2} q_{\alpha(m)}$ also implies that $\max_m p_m = O(n^{-1/2})$. This bound will be used below in our spectral gap analysis. We conjecture that one can achieve a power law scaling of $S(A)$ in Eq. (7.1.1) by introducing two types of brackets, say $l \equiv [, r \equiv], l' \equiv \{, \text{ and } r' \equiv \}$,

such that bracket pairs lr and $l'r'$ are created from the ‘vacuum’ 00 in a maximally entangled state $(|lr\rangle + |l'r'\rangle)/\sqrt{2}$. The local moves Eq. (7.1.3) must be modified as $0x \leftrightarrow x0$, where x can be either of l, r, l', r' , and $00 \leftrightarrow (lr + l'r')/\sqrt{2}$. We expect the modified model with two types of brackets to obey a scaling $S(A) \sim \sqrt{n}$, while its gap will remain lower bounded by an inverse polynomial.

Spectral gap: upper bound. Let $\lambda_2 > 0$ be the smallest non-zero eigenvalue of the Hamiltonian defined in Eq. (7.1.2). We shall use the fact that the ground state $|\mathcal{M}_n\rangle$ is highly entangled to prove an upper bound $\lambda_2 \leq O(n^{-1/2})$. Fix any $k \in [0, n/2]$ and define a ‘twisted’ version of the ground state:

$$|\phi\rangle = \sum_{m=0}^{n/2} e^{i\theta_m} \sqrt{p_m} |\hat{C}_{0,m}\rangle_A \otimes |\hat{C}_{m,0}\rangle_B,$$

where $\theta_m = 0$ for $0 \leq m \leq k$ and $\theta_m = \pi$ otherwise. Note that $|\phi\rangle$ and $|\mathcal{M}_n\rangle$ have the same reduced density matrices on A and B . Hence $\langle\phi|H|\phi\rangle = \langle\phi|\Pi_{cut}|\phi\rangle$, where $\Pi_{cut} \equiv \Pi_{n/2, n/2+1}$. Since $\max_m p_m = O(n^{-1/2})$ and $\sum_m p_m = 1$, there must exist $k \in [0, n/2]$ such that $\sum_{0 \leq m \leq k} p_m = 1/2 \pm \epsilon$ for some $\epsilon = O(n^{-1/2})$. This choice of k ensures that $\langle\phi|\mathcal{M}_n\rangle = \sum_m p_m e^{i\theta_m} \leq 2\epsilon$, that is ϕ is almost orthogonal to the ground state. Define a normalized state $|\tilde{\phi}\rangle \sim |\phi\rangle - \langle\mathcal{M}_n|\phi\rangle \cdot |\mathcal{M}_n\rangle$. Then $\langle\tilde{\phi}|\mathcal{M}_n\rangle = 0$ and $\langle\tilde{\phi}|H|\tilde{\phi}\rangle = \langle\tilde{\phi}|\Pi_{cut}|\tilde{\phi}\rangle \leq \langle\phi|\Pi_{cut}|\phi\rangle + O(\epsilon)$. The difference $\langle\phi|\Pi_{cut}|\phi\rangle - \langle\mathcal{M}_n|\Pi_{cut}|\mathcal{M}_n\rangle$ gets contributions only from the terms $m = k, k \pm 1$ in the Schmidt decomposition, since Π_{cut} can change the number of unmatched brackets in A and B at most by one. Since $\langle\mathcal{M}_n|\Pi_{cut}|\mathcal{M}_n\rangle = 0$, we get

$$\langle\phi|\Pi_{cut}|\phi\rangle \leq O(p_k + p_{k-1} + p_{k+1}) = O(n^{-1/2}).$$

We arrive at $\langle\tilde{\phi}|H|\tilde{\phi}\rangle = O(n^{-1/2})$. Therefore λ_2 is at most $O(n^{-1/2})$.

Spectral gap: lower bound. It remains to prove a lower bound $\lambda_2 \geq n^{-O(1)}$. Let $\mathcal{H}_{p,q}$ be the subspace spanned by strings $s \in C_{p,q}$ and $\mathcal{H}_M \equiv \mathcal{H}_{0,0}$ be the Motzkin space spanned by Motzkin paths. Note that H preserves any subspace $\mathcal{H}_{p,q}$ and the unique ground state of H belongs to \mathcal{H}_M . Therefore it suffices to derive a lower bound $n^{-O(1)}$ for two quantities: (i) the gap of H inside the Motzkin space \mathcal{H}_M , and (ii) the ground state energy of H inside any ‘unbalanced’ subspace $\mathcal{H}_{p,q}$ with $p \neq 0$ or $q \neq 0$. Below we shall focus on part (i) since it allows us to introduce all essential ideas. The proof of part (ii) can be found in the Supplementary Material.

Recall that a string $s \in \{l, r\}^{2m}$ is called a *Dyck path* iff any initial segment of s contains at least as many l ’s as r ’s, and the total number of l ’s is equal to the total number of r ’s. For example, Dyck paths of length 6 are $llrrrr$, $llrllr$, $llrllr$, $lrlrlr$, and $lrlrrr$. The proof of part (i) consists of the following steps:

Step 1. Map the original Hamiltonian H acting on Motzkin paths to an effective Hamiltonian H_{eff} acting on Dyck paths using perturbation theory.

Step 2. Map H_{eff} to a stochastic matrix P describing a random walk on Dyck paths in which transitions correspond to insertions or removals of consecutive lr pairs.

Step 3. Bound the spectral gap of P using the canonical paths method [136, ?].

To construct a good family of canonical paths in Step 3 we will organize Dyck paths into a rooted tree in which level- m nodes represent Dyck paths of length $2m$, edges correspond to insertion of lr pairs, and each node has at most four children. Existence of such a tree will be proved using the fractional matching method [130].

Let \mathcal{D}_m be the set of Dyck paths of length $2m$, \mathcal{D} be the union of all \mathcal{D}_m with $2m \leq n$, and \mathcal{M}_n be the set of Motzkin paths of length n . Define a Dyck space \mathcal{H}_D whose basis vectors are Dyck paths $s \in \mathcal{D}$. Given a Motzkin path u with $2m$ brackets, let $\text{Dyck}(u) \in \mathcal{D}_m$ be the Dyck path obtained from u by removing zeros.

We shall use an embedding $V : \mathcal{H}_D \rightarrow \mathcal{H}_M$ defined as

$$V |s\rangle = \frac{1}{\sqrt{\binom{n}{2m}}} \sum_{\substack{u \in \mathcal{M}_n \\ \text{Dyck}(u)=s}} |u\rangle, \quad s \in \mathcal{D} \cap \mathcal{D}_m.$$

One can easily check that $V^\dagger V = I$, that is, V is an isometry. For any Hamiltonian H , let $\lambda_2(H)$ be the second smallest eigenvalue of H .

Step 1. The restriction of the Hamiltonian Eq. (7.1.2) onto the Motzkin space \mathcal{H}_M can be written as $H = H_{move} + H_{int}$, where H_{move} describes freely moving left and right brackets, while H_{int} is an ‘interaction term’ responsible for pairs creation. More formally, $H_{move} = \sum_{j=1}^{n-1} \Pi_{j,j+1}^{move}$ and $H_{int} = \sum_{j=1}^{n-1} \Pi_{j,j+1}^{int}$, where Π^{move} projects onto the subspace spanned by $|0l\rangle - |l0\rangle$ and $|0r\rangle - |r0\rangle$, while Π^{int} projects onto the state $|00\rangle - |lr\rangle$. Note that the boundary terms in Eq. (7.1.2) vanish on \mathcal{H}_M . We shall treat H_{int} as a small perturbation of H_{move} . To this end define a modified FF Hamiltonian $H_\epsilon = H_{move} + \epsilon H_{int}$, where $0 < \epsilon \leq 1$ will be chosen later. One can easily check that $|\mathcal{M}_n\rangle$ is the unique ground state of H_ϵ and $\lambda_2(H) \geq \lambda_2(H_\epsilon)$ (use the operator inequality $H \geq H_\epsilon$). Note that $H_{move}\psi = 0$ iff ψ is symmetric under the moves $0l \leftrightarrow l0$ and $0r \leftrightarrow r0$. It follows that the ground subspace of H_{move} is spanned by states $V |s\rangle$ with $s \in \mathcal{D}$. To compute the spectrum of H_{move} , we can ignore the difference between l ’s and r ’s since H_{move} is only capable of swapping zeros with non-zero letters. It follows that the spectrum of H_{move} must coincide with the spectrum of the Heisenberg ferromagnetic spin-1/2 chain, that is, Π^{move} can be replaced by the projector onto the singlet state $|01\rangle - |10\rangle$, where 1 represents either l or r . Using the exact formula for the spectral gap of the Heisenberg chain found by

Koma and Nachtergaele [116] we arrive at $\lambda_2(H_{move}) = 1 - \cos\left(\frac{\pi}{n}\right) = \Omega(n^{-2})$. Let

$$H_{\text{eff}} = V^\dagger H_{\text{int}} V$$

be the first-order effective Hamiltonian acting on the Dyck space \mathcal{H}_D . Applying the Projection Lemma of [129] to the orthogonal complement of $|\mathcal{M}_n\rangle$ in \mathcal{H}_M we infer that

$$\lambda_2(H_\epsilon) \geq \epsilon \lambda_2(H_{\text{eff}}) - \frac{O(\epsilon^2) \|H_{\text{int}}\|^2}{\lambda_2(H_{move}) - 2\epsilon \|H_{\text{int}}\|}. \quad (7.1.6)$$

Choosing $\epsilon \ll n^{-3}$ guarantees that $\epsilon \|H_{\text{int}}\|$ is small compared with $\lambda_2(H_{move})$. For this choice of ϵ one gets

$$\lambda_2(H) \geq \lambda_2(H_\epsilon) \geq \epsilon \lambda_2(H_{\text{eff}}) - O(\epsilon^2 n^4). \quad (7.1.7)$$

Hence it suffices to prove that $\lambda_2(H_{\text{eff}}) \geq n^{-O(1)}$.

Step 2. Recall that $H_{\text{eff}} = V^\dagger H_{\text{int}} V$ acts on the Dyck space \mathcal{H}_D . Its unique ground state $|\mathcal{D}\rangle \in \mathcal{H}_D$ can be found by solving $|\mathcal{M}_n\rangle = V |\mathcal{D}\rangle$. It yields

$$|\mathcal{D}\rangle = \frac{1}{\sqrt{|\mathcal{M}_n|}} \sum_{2m \leq n} \sqrt{\binom{n}{2m}} \sum_{s \in \mathcal{D}_m} |s\rangle. \quad (7.1.8)$$

Let $\pi(s) = \langle s | \mathcal{D} \rangle^2$ be the induced probability distribution on \mathcal{D} . Given a pair of Dyck paths $s, t \in \mathcal{D}$, define

$$P(s, t) = \delta_{s,t} - \frac{1}{n} \langle s | H_{\text{eff}} | t \rangle \sqrt{\frac{\pi(t)}{\pi(s)}}. \quad (7.1.9)$$

We claim that P describes a random walk on the set of Dyck paths \mathcal{D} such that $P(s, t)$ is a transition probability from s to t , and $\pi(s)$ is the unique steady state

of P . Indeed, since $\sqrt{\pi(t)}$ is a zero eigenvector of H_{eff} , one has $\sum_t P(s, t) = 1$ and $\sum_s \pi(s)P(s, t) = \pi(t)$. Off-diagonal matrix elements $\langle s|H_{\text{eff}}|t\rangle$ get contributions only from terms $-|00\rangle\langle lr|$ and $-|lr\rangle\langle 00|$ in H_{int} . It implies that $\langle s|H_{\text{eff}}|t\rangle \leq 0$ for $s \neq t$ and hence $P(s, t) \geq 0$. Furthermore, $P(s, s) \geq 1/2$ since $\langle s|H_{\text{eff}}|s\rangle \leq n/2$. In the Supplementary Material we shall prove the following.

Lemma 2. *Let $s, t \in \mathcal{D}$ be any Dyck paths such that t can be obtained from s by adding or removing a single lr pair. Then $P(s, t) = \Omega(1/n^3)$. Otherwise $P(s, t) = 0$.*

Let $\lambda_2(P)$ be the second largest eigenvalue of P . From Eq. (7.1.9) one gets $\lambda_2(H_{\text{eff}}) = n(1 - \lambda_2(P))$. Hence it suffices to prove that the random walk P has a polynomial spectral gap, that is, $1 - \lambda_2(P) \geq n^{-O(1)}$.

Step 3. Lemma 2 tells us that P describes a random walk on a graph $G = (\mathcal{D}, E)$ where two Dyck paths are connected by an edge, $(s, t) \in E$, iff s and t are related by insertion/removal of a single lr pair. To bound the spectral gap of P we shall connect any pair of Dyck paths $s, t \in \mathcal{D}$ by a *canonical path* $\gamma(s, t)$, that is, a sequence $s_0, s_1, \dots, s_l \in \mathcal{D}$ such that $s_0 = s$, $s_l = t$, and $(s_i, s_{i+1}) \in E$ for all i . The canonical paths theorem [136, 137] shows that $1 - \lambda_2(P) \geq 1/(\rho l)$, where l is the maximum length of a canonical path and ρ is the maximum edge load defined as

$$\rho = \max_{(a,b) \in E} \frac{1}{\pi(a)P(a,b)} \sum_{s,t: (a,b) \in \gamma(s,t)} \pi(s)\pi(t). \quad (7.1.10)$$

The key new result that allows us to choose a good family of canonical paths is the following.

Lemma 3. *Let \mathcal{D}_k be the set of Dyck paths of length $2k$. For any $k \geq 1$ there exists a map $f : \mathcal{D}_k \rightarrow \mathcal{D}_{k-1}$ such that (i) the image of any path $s \in \mathcal{D}_k$ can be obtained*

from s by removing a single lr pair, (ii) any path $t \in \mathcal{D}_{k-1}$ has at least one pre-image in \mathcal{D}_k , and (iii) any path $t \in \mathcal{D}_{k-1}$ has at most four pre-images in \mathcal{D}_k .

The lemma allows one to organize the set of all Dyck paths \mathcal{D} into a *supertree* \mathcal{T} such that the root of \mathcal{T} represents the empty path and such that children of any node s are elements of $f^{-1}(s)$. The properties of f imply that Dyck paths of length $2m$ coincide with level- m nodes of \mathcal{T} , any step away from the root on \mathcal{T} corresponds to insertion of a single lr pair, and any node of \mathcal{T} has at most four children. Hence the lemma provides a recipe for growing long Dyck paths from short ones without overusing any intermediate Dyck paths. It should be noted that restricting the maximum number of children to four is optimal since $|\mathcal{D}_k| = C_k \approx 4^k / \sqrt{\pi k^{3/2}}$, where C_k is the k -th Catalan number. Our proof of Lemma 3 based on the fractional matching method can be found in the Supplementary Material. Five lowest levels of the supertree \mathcal{T} are shown on Fig. 7.1.2.

We can now define the canonical path $\gamma(s, t)$ from $s \in \mathcal{D}_m$ to $t \in \mathcal{D}_k$. Any intermediate state in $\gamma(s, t)$ will be represented as uv where $u \in \mathcal{D}_{l'}$ is an ancestor of s in the supertree and $v \in \mathcal{D}_{l''}$ is an ancestor of t . The canonical path starts from $u = s, v = \emptyset$ and alternates between shrinking u and growing v by making steps towards the root (shrink) and away from the root (grow) on the supertree. The path terminates as soon as $u = \emptyset$ and $v = t$. The shrinking steps are skipped whenever $u = \emptyset$, while the growing steps are skipped whenever $v = t$. Note that any intermediate state uv obeys

$$\min(|s|, |t|) \leq |u| + |v| \leq \max(|s|, |t|). \quad (7.1.11)$$

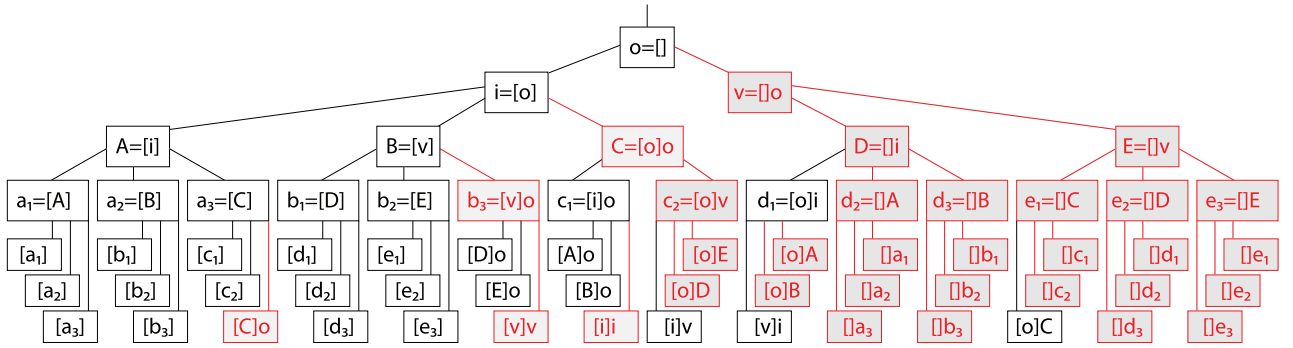

Figure 7.1.2: (Color Online) Five lowest levels of the supertree \mathcal{T} . Nodes of \mathcal{T} are Dyck paths — balanced strings of left and right brackets. Depth- k nodes are in one-to-one correspondence with Dyck paths of length $2k$ (the set \mathcal{D}_k). Any step towards the root requires removal of a consecutive $[]$ pair. Any node has at most four children. The supertree can be described a family of maps $f : \mathcal{D}_k \rightarrow \mathcal{D}_{k-1}$ such that $f(s)$ is the parent of s . The maps f are defined inductively such that $f([X]) = [f(X)]$, $f([]Y) = []f(Y)$ for any node, $f([X]Y) = [f(X)]Y$ for black nodes, and $f([X]Y) = [X]f(Y)$ for red (shaded) nodes. See the proof of Lemma 3 in the Supplementary Material for more details.

Since any path $\gamma(s, t)$ has length at most $2n$, it suffices to bound the maximum edge load ρ . Fix the edge $(a, b) \in E$ with the maximum load. Let $\rho(m, k, l, l')$ be the contribution to ρ that comes from canonical paths $\gamma(s, t)$ such that $a = uv \in \mathcal{D}_{l+l'}$, where

$$s \in \mathcal{D}_m, \quad t \in \mathcal{D}_k, \quad u \in \mathcal{D}_l, \quad v \in \mathcal{D}_{l'},$$

and such that b is obtained from a by growing v (the case when b is obtained from a by shrinking u is analogous). The number of possible source strings $s \in \mathcal{D}_m$ contributing to $\rho(m, k, l, l')$ is at most 4^{m-l} since s must be a descendant of u on the supertree. The number of possible target strings $t \in \mathcal{D}_k$ contributing to $\rho(m, k, l, l')$ is at most $4^{k-l'}$ since t must be a descendant of v on the supertree. Taking into account that

$\pi(s)$ and $\pi(t)$ are the same for all $s \in \mathcal{D}_m$ and $t \in \mathcal{D}_k$ we arrive at

$$\rho(m, k, l', l'') \leq 4^{m+k-l'-l''} \frac{\pi(s)\pi(t)}{\pi(a)P(a, b)} = \frac{\pi_m \pi_k}{\pi_{l'+l''} P(a, b)}$$

with $\pi_l = 4^l \binom{n}{2l} / |\mathcal{M}_n|$. Here we used the identity $\pi(w) = \langle w | \mathcal{D} \rangle^2$ and Eq. (7.1.8). Lemma 2 implies that $1/P(a, b) \leq n^{O(1)}$. Furthermore, the fraction of Motzkin paths of length n that have exactly $2l$ brackets is $\sigma_l = C_l \binom{n}{2l} / |\mathcal{M}_n|$. However $C_l \approx 4^l / \sqrt{\pi} l^{3/2}$ coincides with 4^l modulo factors polynomial in $1/n$. Hence

$$\rho(m, k, l', l'') \leq n^{O(1)} \cdot \frac{\sigma_m \sigma_k}{\sigma_{l'+l''}}.$$

By definition, $\sigma_l \leq 1$ for all l . Also, one can easily check that σ_l as a function of l has a unique maximum at $l \approx n/3$ and decays monotonically away from the maximum. Consider two cases. *Case (1)*: $l' + l''$ is on the left from the maximum of σ_l . From Eq. (7.1.11) one gets $\min(m, k) \leq l' + l''$ and thus $\sigma_m \sigma_k \leq \sigma_{\min(m, k)} \leq \sigma_{l'+l''}$. *Case (2)*: $l' + l''$ is on the right from the maximum of σ_l . From Eq. (7.1.11) one gets $\max(m, k) \geq l' + l''$ and thus $\sigma_m \sigma_k \leq \sigma_{\max(m, k)} \leq \sigma_{l'+l''}$. In both cases we get a bound $\rho(m, k, l', l'') \leq n^{O(1)}$. Since the number of choices for m, k, l', l'' is at most $n^{O(1)}$, we conclude that $\rho \leq n^{O(1)}$ and thus $1 - \lambda_2(P) \geq n^{-O(1)}$.

Open problems. Our work raises several questions. First, one can ask what is the upper bound on the ground state entanglement of FF spin-1 chains and whether the Motzkin state achieves this bound. For example, if the Schmidt rank $\chi(L)$ for a block of L spins can only grow polynomially with L , as it is the case for the Motzkin state, ground states of FF spin-1 chains could be efficiently represented by Matrix Product States [138] (although finding such representation might be a computationally hard problem [139]). One drawback of the model based on Motzkin

paths is the need for boundary conditions and the lack of the thermodynamic limit. It would be interesting to find examples of FF spin-1 chains with highly entangled ground states that are free from this drawback. We also leave open the question of whether our model can indeed be regarded as a critical spin chain in the sense that its continuous limit can be described by a conformal field theory. Finally, an intriguing open question is whether long-range ground state entanglement (or steady-state entanglement in the case of dissipative processes) in 1D spin chains can be stable against more general local perturbations, such as external magnetic fields.

7.2 Supplementary Material

7.2.1 Schmidt coefficients of the Motzkin state

In this section we compute the Schmidt coefficients p_m defined in Eq. (7.1.5) and show that for large n and m one can use an approximation

$$p_m \sim m^2 \exp(-3m^2/n). \quad (7.2.1)$$

Let $\mathcal{D}_{n,k} \subseteq \{l, r\}^{2n+k}$ be the set of balanced strings of left and right brackets of length $2n+k$ with k extra left brackets. More formally, $s \in \mathcal{D}_{n,k}$ iff any initial segment of s contains at least as many l 's as r 's, and the total number of l 's is equal to $n+k$.

Lemma 4 (André's reflection method). *The total number of strings in $\mathcal{D}_{n,k}$ is*

$$D_{n,k} = \frac{k+1}{n+k+1} \binom{2n+k}{n}.$$

Proof. For any bracket string s let $L(s)$ and $R(s)$ be the number of left and right brackets in s . Any $s \in \{l, r\}^{2n+k}$ such that $s \notin \mathcal{D}_{n,k}$ can be uniquely represented as

$s = urv$, where r corresponds to the first unmatched right bracket in s , while u is a balanced string (Dyck path). Let v' be a string obtained from v by a reflection $r \leftrightarrow l$ and $s' = urv'$. Then

$$L(s') = L(u) + L(v') = R(u) + R(v) = R(s) - 1 = n - 1$$

and

$$\begin{aligned} R(s') &= R(u) + 1 + R(v') = L(u) + 1 + L(v) = L(s) + 1 \\ &= n + k + 1. \end{aligned}$$

Furthermore, any string s' with $n - 1$ left brackets and $n + k + 1$ right bracket can be uniquely represented as $s' = urv'$. Hence the number of strings in $\mathcal{D}_{n,k}$ is

$$D_{n,k} = \binom{2n+k}{n} - \binom{2n+k}{n-1} = \frac{k+1}{n+k+1} \binom{2n+k}{n}.$$

□

One can easily check that $|C_{p,q}(n)| = |C_{0,p+q}(n)|$ since the identity of unmatched brackets does not matter for the counting. Let

$$M_{n,m} \equiv |C_{0,m}(n)|.$$

Lemma 4 implies that

$$M_{n,m} = \sum_{\substack{i \geq 0 \\ 2i+m \leq n}} \frac{m+1}{i+m+1} \binom{n}{2i+m} \binom{2i+m}{i}.$$

It can be rewritten as

$$M_{n,m} = \sum_{\substack{i \geq 0 \\ 2i+m \leq n}} M_{n,m,i}, \quad (7.2.2)$$

where

$$M_{n,m,i} = \frac{(m+1) \cdot n!}{(i+m+1)! (n-2i-m)!}. \quad (7.2.3)$$

Let $\alpha = m/\sqrt{n}$ and $\beta = (i - n/3)/\sqrt{n}$. Using Stirling's formula one can get

$$M_{n,m,i} \approx \frac{3\sqrt{3}}{2\pi n^{3/2}} 3^{n+1} \alpha \exp(-3\alpha^2 - 9\alpha\beta - 9\beta^2). \quad (7.2.4)$$

We approximate the sum in Eq. (7.2.2) by integrating over i . Since $i = \frac{n}{3} + \beta\sqrt{n}$, we get $di = \sqrt{n}d\beta$. Since the maximum is near $i = \frac{n}{3}$, we can turn this sum into an integral from $-\infty$ to ∞ . The integral we need to evaluate is thus

$$\begin{aligned} M_{n,m} &\approx \frac{3\sqrt{3}}{2\pi n^{3/2}} 3^{n+1} \alpha \int_{-\infty}^{\infty} e^{-3\alpha^2 - 9\alpha\beta - 9\beta^2} \sqrt{n} d\beta \\ &= \frac{3\sqrt{3}}{2\pi n} 3^{n+1} \alpha \int_{-\infty}^{\infty} e^{-9(\beta - \alpha/2)^2 - \frac{3}{4}\alpha^2} \sqrt{n} d\beta \\ &= \frac{\sqrt{3}}{2\sqrt{\pi n}} 3^{n+1} \alpha e^{-\frac{3}{4}\alpha^2} \sim m \exp(-3m^2/4n). \end{aligned}$$

Recalling that

$$p_m = \frac{|C_{0,m}(n/2)|^2}{|C_{0,0}(n)|} \sim M_{n/2,m}^2 \quad (7.2.5)$$

we arrive at Eq. (7.2.1).

7.2.2 Proof of Lemma 2

Suppose $s \in \mathcal{D}_k$ and $t \in \mathcal{D}_{k\pm 1}$. Using the definition of $P(s, t)$ one can easily get

$$P(s, t) = -\frac{1}{n} \binom{n}{2k}^{-1} \sum_{u \in \mathcal{M}_n[s]} \sum_{v \in \mathcal{M}_n[t]} \langle u | H_{int} | v \rangle.$$

Here $\mathcal{M}_n[s] = \{u \in \mathcal{M}_n : \text{Dyck}(u) = s\}$. Note that $\langle u | H_{int} | v \rangle = -1/2$ if u and v differ exactly at two consecutive positions where u and v contain 00 and lr respectively or vice versa. In all other cases one has $\langle u | H_{int} | v \rangle = 0$.

Suppose $t \in \mathcal{D}_{k+1}$ and $P(s, t) > 0$. Let us fix some $j \in [0, 2k]$ such that t can be obtained from s by inserting a pair lr between s_j and s_{j+1} . For any string $u \in \mathcal{M}_n[s]$ in which s_j and s_{j+1} are separated by at least two zeros one can find at least one $v \in \mathcal{M}_n[t]$ such that $\langle u | H_{int} | v \rangle = -1/2$. The fraction of strings $u \in \mathcal{M}_n[s]$ in which s_j and s_{j+1} are separated by two or more zeros is at least $1/n^2$ which implies

$$P(s, t) \geq \frac{1}{2n^3}.$$

Suppose now that $t \in \mathcal{D}_{k-1}$. Let us fix some $j \in [1, 2k-1]$ such that t can be obtained from s by removing the pair $s_j s_{j+1} = lr$. For any string $u \in \mathcal{M}_n[s]$ in which s_j and s_{j+1} are not separated by zeros one can find at least one $v \in \mathcal{M}_n[t]$ such that $\langle u | H_{int} | v \rangle = -1/2$. The fraction of strings $u \in \mathcal{M}_n[s]$ in which s_j and s_{j+1} are not separated by zeros is at least $1/n$ which implies

$$P(s, t) \geq \frac{1}{2n^2}.$$

7.2.3 Proof of Lemma 3

Let us first prove a simple result concerning fractional matchings. Consider a bipartite graph $G = (A \cup B, E)$. Let $x = \{x_e\}_{e \in E}$ be a vector of real variables associated with edges of the graph. For any vertex u let $\delta(u)$ be the set of edges incident to u . Define a *matching polytope* [130]

$$\begin{aligned} \mathcal{P} = \{ & x : x_e \geq 0 \text{ for all } e \in E, \\ & 1 \leq \sum_{e \in \delta(a)} x_e \leq 4, \quad \sum_{e \in \delta(b)} x_e = 1 \\ & \text{for all } a \in A \text{ and } b \in B\}. \end{aligned}$$

Lemma 5. *Suppose \mathcal{P} is non-empty. Then there exists a map $f : B \rightarrow A$ such that (i) $f(b) = a$ implies $(a, b) \in E$, (ii) any vertex $a \in A$ has at least one pre-image in B , and (iii) any vertex $a \in A$ has at most four pre-images in B .*

Proof. Since \mathcal{P} is non-empty, it must have at least one extremal point $x^* \in \mathcal{P}$. Let $E^* \subseteq E$ be the set of edges such that $x_e^* > 0$. We claim that E^* is a forest (disjoint union of trees). Indeed, suppose E^* contains a cycle Z (a closed path). Then $x_{a,b}^* < 1$ for all $(a, b) \in Z$ since otherwise the cycle would terminate at b . Hence $0 < x_e^* < 1$ for all $e \in Z$. Since the graph is bipartite, one can label edges of Z as even and odd in alternating order. There exists $\epsilon \neq 0$ such that x^* can be shifted by $\pm\epsilon$ on even and odd edges of Z respectively without leaving \mathcal{P} . Hence x^* is a convex mixture of two distinct vectors from \mathcal{P} . This is a contradiction since x^* is an extreme point. Hence E^* contains no cycles, that is, E^* is a forest. We claim that $x_e^* = 1$ for all $e \in E^*$. Indeed, let $T \subseteq E^*$ be the subset of edges with $0 < x_e^* < 1$. Obviously, T itself is a forest. Degree-1 nodes of T must be in A and there must exist a path $\gamma \subseteq T$ starting and ending at degree-1 nodes $u, u' \in A$. Since $0 < x_e^* < 1$ for all

$e \in \gamma$, there exists $\epsilon \neq 0$ such that x^* can be shifted by $\pm\epsilon$ on even and odd edges of γ respectively without leaving \mathcal{P} . This is a contradiction since x^* is an extreme point. Hence $x_e^* = 1$ for all $e \in E^*$. We conclude that $x_e^* \in \{0, 1\}$ for all edges of G . The desired map can now be defined as $f(b) = a$ iff $x_{a,b}^* = 1$. \square

We are interested in the case where

$$A = \mathcal{D}_{n-1} \quad \text{and} \quad B = \mathcal{D}_n$$

are Dyck paths of semilength $n - 1$ and n respectively. Paths $a \in \mathcal{D}_{n-1}$ and $b \in \mathcal{D}_n$ are connected by an edge iff a can be obtained from b by removing a single lr pair. Our goal is to construct a map $f : \mathcal{D}_n \rightarrow \mathcal{D}_{n-1}$ with the properties (i),(ii),(iii) stated in Lemma 5. According to the lemma, it suffices to choose f as a stochastic map. Namely, for any $b \in \mathcal{D}_n$ we shall define a random variable $f(b) \in \mathcal{D}_{n-1}$ with some normalized probability distribution. It suffices to satisfy two conditions:

$$\begin{aligned} \Pr[f(b) = a] > 0 \quad \text{only if } a \text{ can be obtained} & \quad (7.2.6) \\ & \quad \text{from } b \text{ by removing a single} \\ & \quad lr \text{ pair,} \end{aligned}$$

and

$$\sum_{b \in \mathcal{D}_n} \Pr[f(b) = a] = X_n \quad \text{for all } a \in \mathcal{D}_{n-1}. \quad (7.2.7)$$

Here $1 \leq X_n \leq 4$ is some function of n that we shall choose later. We shall define f using induction in n .

Lemma 6. *For every $n \geq 1$ there exists $1 \leq X_n \leq 4$ and a stochastic map $f : \mathcal{D}_n \rightarrow \mathcal{D}_{n-1}$ satisfying Eqs. (7.2.6, 7.2.7).*

Proof. Any Dyck path $b \in \mathcal{D}_n$ can be uniquely represented as $b = lsrt$ for some $s \in \mathcal{D}_i$, $t \in \mathcal{D}_{n-i-1}$, and $i \in [0, n-1]$. We shall specify the map $f : \mathcal{D}_n \rightarrow \mathcal{D}_{n-1}$ by the following rules:

$b \in \mathcal{D}_n$	$f(b) \in \mathcal{D}_{n-1}$	probability
$lsrt, s \in \mathcal{D}_i, 1 \leq i \leq n-2$	$lf(s)rt$	p_i
$lsrt, s \in \mathcal{D}_i, 1 \leq i \leq n-2$	$lsrf(t)$	$1 - p_i$
$lrt, t \in \mathcal{D}_{n-1}$	$lrf(t)$	1
$lsr, s \in \mathcal{D}_{n-1}$	$lf(s)r$	1

Here we assumed that f has been already defined for strings of semilength up to $n-1$ such that Eqs. (7.2.6,7.2.7) are satisfied. By abuse of notation, we ignore the index n in f , so we regard f as a family of maps defined for all n . It is clear that our inductive definition of f on \mathcal{D}_n satisfies Eq. (7.2.6). The probabilities $p_1, \dots, p_{n-2} \in [0, 1]$ are free parameters that must be chosen to satisfy Eq. (7.2.7). Note that these probabilities also implicitly depend on n . The choices of $f(b)$ in the first two lines of the above table are represented by black and red nodes in the example shown on Fig. 7.1.2. Consider three cases:

Case 1: $a = lrt'$ for some $t' \in \mathcal{D}_{n-2}$. Then $f(b) = a$ iff $b = llrrt'$ or $b = lrt$ for some $t \in \mathcal{D}_{n-1}$ such that $f(t) = t'$. These possibilities are mutually exclusive. Hence

$$\begin{aligned} \sum_{b \in \mathcal{D}_n} \Pr[f(b) = lrt'] &= p_1 + \sum_{t \in \mathcal{D}_{n-1}} \Pr[f(t) = t'] \\ &= p_1 + X_{n-1}. \end{aligned}$$

Substituting it into Eq. (7.2.7) gives a constraint

$$p_1 = X_n - X_{n-1}. \quad (7.2.8)$$

Case 2: $a = ls'r$ for some $s' \in \mathcal{D}_{n-2}$. Then $f(b) = a$ iff $b = ls'rlr$ or $b = lsr$ for some $s \in \mathcal{D}_{n-1}$ such that $f(s) = s'$. These possibilities are mutually exclusive. Hence

$$\begin{aligned} \sum_{b \in \mathcal{D}_n} \Pr[f(b) = ls'r] &= 1 - p_{n-2} + \sum_{s \in \mathcal{D}_{n-1}} \Pr[f(s) = s'] \\ &= 1 - p_{n-2} + X_{n-1}. \end{aligned}$$

Substituting it into Eq. (7.2.7) gives a constraint

$$p_{n-2} = 1 - (X_n - X_{n-1}). \quad (7.2.9)$$

It says that X_n must be a non-decreasing sequence.

Case 3: $a = ls'rt'$ for some $s' \in \mathcal{D}_i$, $t' \in \mathcal{D}_{n-i-2}$, and $i = 1, \dots, n-3$. In other words, both s' and t' must be non-empty. Then $f(b) = a$ iff $b = lsrt'$ for some $s \in \mathcal{D}_{i+1}$ such that $f(s) = s'$, or $b = ls'rt$ for some $t \in \mathcal{D}_{n-i-1}$ such that $f(t) = t'$. These possibilities are mutually exclusive. Hence

$$\begin{aligned} \sum_{b \in \mathcal{D}_n} \Pr[f(b) = ls'rt'] &= p_{i+1} \sum_{s \in \mathcal{D}_{i+1}} \Pr[f(s) = s'] \\ &\quad + (1 - p_i) \sum_{t \in \mathcal{D}_{n-i-1}} \Pr[f(t) = t'] \\ &= p_{i+1} X_{i+1} + (1 - p_i) X_{n-i-1}. \end{aligned}$$

Substituting it into Eq. (7.2.7) gives a constraint

$$p_{i+1} X_{i+1} + (1 - p_i) X_{n-i-1} = X_n \quad (7.2.10)$$

for each $i = 1, \dots, n - 3$. Let us choose

$$X_i = \frac{C_i}{C_{i-1}} = \frac{4(i - 1/2)}{i + 1}. \quad (7.2.11)$$

Combining Eqs. (7.2.8,7.2.9,7.2.10) we obtain a linear system with unknown variables $p_1, \dots, p_{n-2} \in [0, 1]$. We shall look for a solution $\{p_i\}$ having an extra symmetry

$$p_i + p_{n-i-1} = 1 \quad \text{for } i = 1, \dots, n - 2. \quad (7.2.12)$$

One can check that the system defined by Eqs. (7.2.8,7.2.9,7.2.10,7.2.12) has a solution

$$p_i = \frac{i(i + 1)(3n - 2i - 1)}{n(n + 1)(n - 1)}, \quad i = 1, \dots, n - 2. \quad (7.2.13)$$

Hence we have defined the desired stochastic map $f : \mathcal{D}_n \rightarrow \mathcal{D}_{n-1}$. This proves the induction hypothesis.

It remains to note that for $n = 1, 2$ the map f is uniquely specified by Eqs. (7.2.6,7.2.7) and our choice of X_n . Indeed, one has $\mathcal{D}_2 = \{llrr, lrlr\}$, $\mathcal{D}_1 = \{lr\}$, and $\mathcal{D}_0 = \emptyset$. To satisfy Eq. (7.2.6), we have to choose $f(llrr) = f(lrlr) = lr$ for $n = 2$ and $f(lr) = \emptyset$ for $n = 1$. It also satisfies Eq. (7.2.7) since $X_2 = 2$ and $X_1 = 1$. This proves the base of induction. \square

7.2.4 Ground state energy for unbalanced subspaces

Recall that the unbalanced subspace $\mathcal{H}_{p,q}$ is spanned by strings $s \in C_{p,q}$ that have p unmatched right and q unmatched left brackets. Our goal is to prove that the restriction of H onto any subspace $\mathcal{H}_{p,q}$ with $p > 0$ or $q > 0$ has ground state energy at least $n^{-O(1)}$. By the symmetry, it suffices to consider the case $p > 0$. To simplify

the analysis we shall omit the boundary term $|l\rangle\langle l|_n$. Note that such omission can only decrease the ground state energy. Accordingly, our simplified Hamiltonian becomes

$$H = |r\rangle\langle r|_1 + \sum_{j=1}^{n-1} \Pi_{j,j+1}. \quad (7.2.14)$$

Recall that Π is a projector onto the subspace spanned by states $|00\rangle - |lr\rangle$, $|0l\rangle - |l0\rangle$, and $|0r\rangle - |r0\rangle$. Let $\lambda_1(H)$ be the ground state energy of H .

Any string $s \in C_{p,q}$ can be uniquely represented as

$$s = u_0 r u_1 r u_2 \dots r u_p l v_1 l v_2 \dots l v_q$$

where u_i and v_j are Motzkin paths (balanced strings of brackets). The remaining p right and q left brackets are unmatched and never participate in the move $00 \leftrightarrow lr$. It follows that the unmatched brackets can be regarded as “solid walls” that can be swapped with 0’s but otherwise do not participate in any interactions. In particular, the spectrum of H restricted to $\mathcal{H}_{p,q}$ depends only on $p + q$ as long as $p > 0$. This allows us to focus on the case $q = 0$, i.e. assume that all unmatched brackets are right.

Given a string $s \in C_{p,0}$, let $\tilde{s} \in \{0, l, r, x, y\}^n$ be the string obtained from s by the following operations: (i) replace the first unmatched right bracket in s by ‘ x ’, and (ii) replace all other unmatched brackets in s (if any) by ‘ y ’. Define a new Hilbert space $\tilde{\mathcal{H}}_p$ whose basis vectors are $|\tilde{s}\rangle$, $s \in C_{p,0}$. Consider a Hamiltonian

$$\tilde{H} = |x\rangle\langle x|_1 + \sum_{j=1}^{n-1} \Pi_{j,j+1} + \Theta_{j,j+1}^x + \Theta_{j,j+1}^y, \quad (7.2.15)$$

where Θ^x and Θ^y are projectors onto the states $|0x\rangle - |x0\rangle$ and $|0y\rangle - |y0\rangle$ respectively

(with a proper normalization). One can easily check that $\langle s|H|t\rangle = \langle \tilde{s}|\tilde{H}|\tilde{t}\rangle$ for any $s, t \in C_{p,0}$. Hence the spectrum of H on $\mathcal{H}_{p,0}$ coincides with the spectrum of \tilde{H} on $\tilde{\mathcal{H}}_p$. Furthermore, if we omit all the terms $\Theta_{j,j+1}^y$ in \tilde{H} , the ground state energy can only decrease. Hence it suffices to consider a simplified Hamiltonian

$$H^x = |x\rangle\langle x|_1 + \sum_{j=1}^{n-1} \Pi_{j,j+1} + \Theta_{j,j+1}^x \quad (7.2.16)$$

which acts on $\tilde{\mathcal{H}}_p$. Note that positions of y -particles are integrals of motion for H^x . Moreover, for fixed positions of y -particles, any term in H^x touching a y -particle vanishes. Hence H^x can be analyzed separately on each interval between consecutive y -particles. Since our goal is to get a lower bound on the ground state energy, we can only analyze the interval between 1 and the first y -particle. Equivalently, we can redefine n and focus on the case $p = 1, q = 0$, that is, assume that there is only one unmatched right bracket. The relevant Hilbert space $\tilde{\mathcal{H}}_1$ is now spanned by states

$$|s\rangle \otimes |x\rangle \otimes |t\rangle, \quad \text{where } s \in \mathcal{M}_{j-1}, \quad t \in \mathcal{M}_{n-j}.$$

Recall that \mathcal{M}_k is the set of Motzkin paths (balanced strings of left and right brackets) of length k .

We would like to treat the terms responsible for the motion and detection of the x -particle as a small perturbation. To this end, choose any $0 < \epsilon \leq 1$ and define the Hamiltonian

$$H_\epsilon^x = \sum_{j=1}^{n-1} \Pi_{j,j+1} + \epsilon |x\rangle\langle x|_1 + \epsilon \sum_{j=1}^{n-1} \Theta_{j,j+1}^x.$$

Clearly, $H_\epsilon^x \leq H^x$, so it suffices to get a lower bound on the ground state energy of H_ϵ^x .

Let us first find the ground subspace and the spectral gap of the unperturbed Hamiltonian $H_0^x = \sum_{j=1}^{n-1} \Pi_{j,j+1}$. Note that the position of the x -particle j is an invariant of motion for H_0^x . Moreover, any projector $\Pi_{i,i+1}$ touching the x -particle vanishes. Hence we can analyze H_0^x separately on the two disjoint intervals $A = [1, j-1]$ and $B = [j+1, n]$. It follows that the ground subspace of H_0^x is spanned by normalized states

$$|\psi_j\rangle = |\mathcal{M}_{j-1}\rangle \otimes |x\rangle \otimes |\mathcal{M}_{n-j}\rangle, \quad j = 1, \dots, n. \quad (7.2.17)$$

The spectral gap of H_0^x can also be computed separately in A and B . Since we have already shown that the original Hamiltonian Eq. (7.1.2) has a polynomial gap inside the Motzkin subspace, we conclude that $\lambda_2(H_0^x) \geq n^{-O(1)}$.

Let us now turn on the perturbation. The first-order effective Hamiltonian acting on the ground subspace spanned by ψ_1, \dots, ψ_n describes a hopping of the x -particle on a chain of length n with a delta-like repulsive potential applied at site $j = 1$. Parameters of the hopping Hamiltonian can be found by calculating the matrix elements

$$\langle \psi_j | \Theta_{j,j+1}^x | \psi_j \rangle = \frac{M_{n-j-1}}{2M_{n-j}} \equiv \alpha_j^2,$$

$$\langle \psi_{j+1} | \Theta_{j,j+1}^x | \psi_{j+1} \rangle = \frac{M_{j-1}}{2M_j} \equiv \beta_j^2,$$

and

$$\langle \psi_j | \Theta_{j,j+1}^x | \psi_{j+1} \rangle = -\frac{1}{2} \sqrt{\frac{M_{n-j-1}}{M_{n-j}} \cdot \frac{M_{j-1}}{M_j}} = -\alpha_j \beta_j,$$

where $M_k = |\mathcal{M}_k|$ is the k -th Motzkin number. We arrive at the effective hopping

Hamiltonian acting on \mathbb{C}^n , namely,

$$H_{\text{eff}} = |1\rangle\langle 1| + \sum_{j=1}^{n-1} \Gamma_{j,j+1}, \quad (7.2.18)$$

where

$$\begin{aligned} \Gamma_{j,j+1} &= \alpha_j^2 |j\rangle\langle j| + \beta_j^2 |j+1\rangle\langle j+1| \\ &\quad - \alpha_j \beta_j (|j\rangle\langle j+1| + |j+1\rangle\langle j|) \end{aligned} \quad (7.2.19)$$

is a rank-1 projector. Applying the Projection Lemma of [129] we infer that

$$\lambda_1(H_\epsilon^x) \geq \epsilon \lambda_1(H_{\text{eff}}) - \frac{O(\epsilon^2) \|V\|^2}{\lambda_2(H_0^x) - 2\epsilon \|V\|},$$

where $V = |x\rangle\langle x|_1 + \sum_{j=1}^{n-1} \Theta_{j,j+1}^x$ is the perturbation operator. Since $\lambda_2(H_0^x) \geq n^{-O(1)}$, we can choose ϵ polynomial in $1/n$ such that $2\epsilon \|V\|$ is small compared with $\lambda_2(H_0^x)$. For this choice of ϵ one gets

$$\lambda_1(H_\epsilon^x) \geq \epsilon \lambda_1(H_{\text{eff}}) - O(\epsilon^2) n^{O(1)}.$$

Hence it suffices to show that $\lambda_1(H_{\text{eff}}) \geq n^{-O(1)}$, where H_{eff} is now the single x -particle hopping Hamiltonian Eq. (7.2.18).

Let us first focus on the hopping Hamiltonian without the repulsive potential:

$$H_{\text{move}} \equiv \sum_{j=1}^{n-1} \Gamma_{j,j+1}.$$

This Hamiltonian is FF and its unique ground state is

$$|g\rangle \sim \sum_{j=1}^n \sqrt{M_{j-1}M_{n-j}} |j\rangle. \quad (7.2.20)$$

Our strategy will be to bound the spectral gap of H_{move} and apply the Projection Lemma to H_{eff} by treating the repulsive potential $|1\rangle\langle 1|$ as a perturbation of H_{move} . First let us map H_{move} to a stochastic matrix describing a random walk on the interval $[1, n]$ with the steady state $\pi(j) = \langle j|g\rangle^2$. For any $a, b \in [1, n]$ define

$$P(j, k) = \delta_{j,k} - \langle j|H_{move}|k\rangle \sqrt{\frac{\pi(k)}{\pi(j)}}. \quad (7.2.21)$$

Since $\sqrt{\pi(j)}$ is a zero eigenvector of H_{move} , we infer that $\sum_k P(j, k) = 1$ and $\sum_j \pi(j)P(j, k) = \pi(k)$. A simple algebra shows that

$$P(j, j+1) = \frac{M_{n-j-1}}{2M_{n-j}} \quad \text{and} \quad P(j+1, j) = \frac{M_{j-1}}{2M_j}$$

are the only non-zero off-diagonal matrix elements of P . We shall use the following property of the Motzkin numbers.

Lemma 7. *For any $n \geq 1$ one has $1/3 \leq M_n/M_{n+1} \leq 1$. Furthermore, for large n one can use an approximation*

$$M_n \approx c \frac{3^n}{n^{3/2}} \quad (7.2.22)$$

where $c \approx 1.46$.

The lemma implies that

$$\frac{1}{6} \leq P(j, j \pm 1) \leq \frac{1}{2}$$

for all j . Hence the diagonal matrix elements $P(j, j)$ are non-negative, that is, we indeed can regard $P(j, k)$ as a transition probability from j to k . Furthermore, using Eq. (7.2.20) and the above lemma we infer that the steady state π is ‘almost uniform’, that is,

$$n^{-O(1)} \leq \frac{\pi(k)}{\pi(j)} \leq n^{O(1)} \quad \text{for all } 1 \leq j, k \leq n. \quad (7.2.23)$$

In particular, $\min_j \pi(j) \geq n^{-O(1)}$. We can now easily bound the spectral gap of P . For example, applying the canonical paths theorem stated above we get $1 - \lambda_2(P) \geq 1/(\rho l)$ where ρ is defined in Eq. (7.1.10) and the canonical path $\gamma(s, t)$ simply moves the x -particle from s to t . Since the denominator in Eq. (7.1.10) is lower bounded by $n^{-O(1)}$, we conclude that $1 - \lambda_2(P) \geq n^{-O(1)}$. It shows that $\lambda_2(H_{move}) \geq n^{-O(1)}$.

To conclude the proof, it remains to apply the Projection Lemma to H_{eff} defined in Eq. (7.2.18) by treating the repulsive potential $|1\rangle\langle 1|$ as a perturbation. Now the effective first-order Hamiltonian will be simply a c -number $\langle 1|g\rangle^2 = \pi(1) \geq n^{-O(1)}$ which proves the bound $\lambda_1(H_{\text{eff}}) \geq n^{-O(1)}$.

Bibliography

- [1] Whittaker, E. T. A Treatise on the Analytical Dynamics of Particles and Rigid Bodies: With an Introduction to the Problem of Three Bodies. New York: Dover, (1944)
- [2] P. A. M. Dirac, “Principles of Quantum Mechanics”, Fourth Edition (revised), Oxford and The Clarendon Press (1967)
- [3] S. Weinberg, “Quantum Theory of Fields” Vol. I, Cambridge University Press; 1 edition (June 30, 1995)
- [4] P.W. Shor, “Polynomial-Time Algorithms for Prime Factorization and Discrete Logarithms on a Quantum Computer” SIAM J.Sci.Statist.Comput. 26 1484 (1997)
- [5] L.K. Grover, “A fast quantum mechanical algorithm for database search”, STOC '96 Proceedings of the twenty-eighth annual ACM symposium on Theory of computing (1996)
- [6] Wikipedia, http://en.wikipedia.org/wiki/Schmidt_decomposition
- [7] Y.-Y. Shi, L.-M. Duan, and G. Vidal , “Classical simulation of quantum many-body systems with a tree tensor network” Phys. Rev. A 74, 022320 (2006)

- [8] R. Movassagh, Alan Edelman, “Isotropic Entanglement” ArXiv: 1012.5039v1 quant-ph (2010)
- [9] R. Movassagh, Alan Edelman, “Density of States of Quantum Spin Systems from Isotropic Entanglement”, Phys. Rev. Lett 107, 097205 (2011)
- [10] Patrick Hayden, Debbie W. Leung and Andreas Winter, Comm. of Math. Phys., Volume 265, Number 1, 95-117(2006)
- [11] T. Cubitt, A. Montanaro, A. Winter, Journal of Mathematical Physics, Volume 49; Number 2 (2008).
- [12] T. Guhr, A. Mueller-Groeling, H. A. Weidenmueller, Phys.Rept.299:189-425, (1998)
- [13] C.W.J. Beenakker, Rev.Mod.Phys. 69, 731 (1997)
- [14] Hong-Hao Tu and Mikel Sanz, Phys. Rev. B 82, 104404 (2010)
- [15] H. -B Schüttler and D.J. Scalapino, Physical Review B, Vol 35, Number 7, (1987)
- [16] D. S. Fisher, Phys. Rev. B 50, 3799–3821 (1994)
- [17] Fisher DS, Le Doussal P, Monthus C. Phys. Rev. E 64, 066107 (2001)
- [18] S.A. Cook, in proceedings of the 3rd STOC, AMC, New York, (1971)
- [19] Florent Krzakala and Lenka Zdeborová , Phys. Rev. Lett. 102, 238701 (2009)
- [20] S. Bravyi, 0602108v1 [quant-ph] (2006)

- [21] C.R. Laumann, R Moessner, A Scardicchio, S. L. Sondhi, Quantum Information & Computation Volume 10 Issue 1, January (2010)
- [22] C. R. Laumann, R. Moessner, A. Scardicchio and S. L. Sondhi, “Statistical Mechanics of Classical and Quantum Computational Complexity”, Lecture Notes in Physics, Volume 843/2012, 295-332 (2012)
- [23] A. Ambainis, J. Kempe, O. Sattath, arXiv:0911.1696v1 [quant-ph] (2009)
- [24] B Bernu, G Misguich, Physical Review B Volume: 63, Issue: 13 (2000)
- [25] E L Wolf 1978 Rep. Prog. Phys. 41 1439 (1978)
- [26] P. Liljeroth , L. Jdira , K. Overgaag , B. Grandidier , S. Speller and D. Vanmaekelbergh, Phys. Chem. Chem. Phys., 8, 3845-3850 (2006)
- [27] F. Reinert and S. Hufner, New J. Phys. 7, 97 (2005)
- [28] L.P. Kadanoff, “Statistical Physics: Statics, Dynamics and Renormalization”, World Scientific Publishing Company (July 2000)
- [29] M.P. Mardar, “Condensed Matter Physics”, Wiley-Interscience; 1 edition (January 7, 2000)
- [30] X-G. Wen, “Quantum Field Theory of Many-body Systems: From the Origin of Sound to an Origin of Light and Electrons”, Oxford University Press, USA; Reissue edition (October 18, 2007)
- [31] B. Brown, S. T. Flammia, N. Schuch, “Computational Difficulty of Computing the Density of States” arXiv:1010.3060v1 (2010)

- [32] A. Ambainis, A. W. Harrow, M B. Hastings, “Random tensor theory: extending random matrix theory to random product states” arXiv:0910.0472v2 (2009)
- [33] D. Perez-Garcia, F. Verstraete, M.W. Wolf and J.I. Cirac, “Matrix Product State Representations”, *Quantum Inf. Comput.* 7, 401 (2007)
- [34] G. Vidal, “Efficient Simulation Of One-Dimensional Quantum Many-Body Systems”, *Phys. Rev. Lett.* 93, 040502 (2004). There is an alternative yet equivalent notation for the MPS that can be found in [33].
- [35] S. White, “Density Matrix Formulation For Quantum Renormalization Group”, *Phys. Rev. Lett.* 69, 2863 - 2866 (1992)
- [36] Z. Gu, M. Levin, X. Wen, “Tensor-Entanglement Renormalization Group Approach To 2D Quantum Systems” *Phys. Rev. B* 78, 205116 (2008)
- [37] F. Verstraete, V. Murg, J.I. Cirac, “MPS Projected Entangled Pair States, And Variational Renormalization Group Methods For Quantum Spin Systems”, *Advances in Physics*, Vol. 57, No. 2, 143-224 (March-April 2008)
- [38] R. Movassagh, E. Farhi, J. Goldstone, D. Nagaj, T. J. Osborne, P. W. Shor, “Unfrustrated Qudit Chains and Their Ground States”, *Phys. Rev. A* 82, 012318 (2010)
- [39] I. Chuang and M. Nielsen, “Quantum Computation and Quantum Information”, Cambridge University Press; 1 edition (September 2000)
- [40] J. Preskill, Lecture notes (2009) URL: <http://www.theory.caltech.edu/people/preskill/ph229/>

- [41] D. Aharonov, D. Gottesman, S. Irani, J. Kempe, “Power of Quantum Systems on a Line”, *Comm. Math. Physics*, vol. 287, no. 1, pp. 41-65 (2009)
- [42] S. Sachdev, “Quantum Phase Transitions” by S. Sachdev (2001)
- [43] S. Sachdev, “Spin glasses enter the quantum regime”, *Physics World* 7, No. 10, 25 (October 1994)
- [44] M. Fannes, B. Nachtergaele, R.F.Werner, “Finitely Correlated States on Quantum Spin Chains” *Commun. Math. Phys.* 144, 443-490 (1992)
- [45] G. W. Anderson, A. Guionnet, O. Zeitouni, “An Introduction to Random Matrices” (2009)
- [46] F. Hiai, D. Petz, “The Semicircle Law, Free Random Variables, and Entropy” (2006)
- [47] A. Edelman, “Eigenanalysis of Random Matrices”, unpublished notes for MIT graduate course 18.337
- [48] A. Nica, R. Speicher, “Lectures on the Combinatorics of Free Probability”, *London Mathematical Society Lecture Note Series* (2006)
- [49] S. Das Gupta, R. K. Bhaduri, *Physics Letters B*, vol 58 issue 4, 381-383 (1975)
- [50] H. Cramér, *Mathematical Methods of Statistics*, (Princeton University Press, Princeton 1957)
- [51] I. Dumitriu, A. Edelman and G. Shuman, “MOPs: Multivariate Orthogonal Polynomials (symbolically)”, *Journal of Symbolic Computation* 42, 587–620 (2007)

- [52] R. J. Muirhead, “Aspects of Multivariate Statistical Theory”, Wiley-Interscience; 2nd edition (2005)
- [53] A. Edelman, “The Random Matrix Technique of Ghosts and Shadows”, Markov Processes and Related Fields (To appear 2011)
- [54] L. N. Trefethen and D. Bau II, “Numerical Linear Algebra” (SIAM 1997)
- [55] R. Movassagh, A. Edelman, Talk given at The Perimeter Institute (July 2010). URL: http://pirsa.org/index.php?p=speaker&name=Ramis_Movassagh
- [56] This also appears in: Jiahao Chen, Eric Hontz, Jeremy Moix, Matthew Welborn, Troy Van Voorhis, Alberto Suárez, Ramis Movassagh, Alan Edelman “Error analysis of free probability approximations to the density of states of disordered systems”: arXiv:1202.5839v1 [cond-mat.dis-nn]
- [57] D. J. Thouless, Phys. Rep. 13, 93 (1974)
- [58] F. Evers and A. Mirlin, Rev. Mod. Phys 80, 1355 (2008)
- [59] J.-P. Bouchaud and A. Georges, Phys. Rep. 195, 127 (1990)
- [60] M. F. Shlesinger, G. M. Zaslavsky, and J. Klafter, Nature 363, 31 (1993)
- [61] R. G. Palmer, Adv. Phys. 31, 669 (1982)
- [62] E. Barkai, Y. Jung, and R. Silbey, Annu. Rev. Phys. Chem. 55, 457 (2004)
- [63] F. D. Stefani, J. P. Hoogenboom, and E. Barkai, Phys. Today 62, 34 (2009)
- [64] A. Hernando, J. Phys.: Condens. Matter 11, 9455 (1999)
- [65] J. Dyre and T. Schröder, Rev. Mod. Phys. 72, 873 (2000)

- [66] J. S. Dugdale, *The Electrical Properties of Disordered Metals*, Cambridge Solid State Science Series (Cambridge, Cambridge, UK, 2005)
- [67] J. Peet, A. J. Heeger, and G. C. Bazan, *Acc. Chem. Res.* 42, 1700 (2009)
- [68] S. Difley, L.-P. Wang, S. Yeganeh, S. R. Yost, and T. Van Voorhis, *Acc. Chem. Res.* 43, 995 (2010)
- [69] S. R. Yost, L.-P. Wang, and T. Van Voorhis, *J. Phys. Chem. C* 115, 14431 (2011)
- [70] P. Kollman, *Chem. Rev.* 93, 2395 (1993)
- [71] D. Voiculescu, *Invent. Math.* 104, 201 (1991)
- [72] P. Biane, in *Quantum probability communications*, Vol. 11 Chap. 3, pp. 55–71 (1998)
- [73] A. Zee, *Nucl. Phys. B* 474, 726 (1996)
- [74] A. Stuart and J. K. Ord, *Kendall's advanced theory of statistics*. (Edward Arnold, London, 1994)
- [75] S. Blinnikov and R. Moessner, *Astron. Astrophys. Supp. Ser.* 130, 193 (1998)
- [76] D. Wallace, *Ann. Math. Stat.* 29, 635 (1958)
- [77] A. Nica and R. Speicher, *Lectures on the Combinatorics of Free Probability*, London Math. Soc. Lecture Note Ser. (London, 2006)
- [78] P. Diaconis, *Not. Amer. Math. Soc.* 52, 1348 (2005)

- [79] D. Voiculescu, in Proceedings of the International Congress of Mathematicians pp. 227–241 (Birkh user Verlag, Z urich, Switzerland, 1994)
- [80] J. Sawada, SIAM J. Comput. 31, 259 (2001)
- [81] R. Movassagh and A. Edelman, arXiv:1012.5039 (2012)
- [82] G. Strang, SIAM Rev. 41, 135 (1999)
- [83] I. Popescu, personal communication (2011)
- [84] D. Voiculescu, in Operator algebras and their connections with topology and ergodic theory, Lecture Notes in Mathematics, Vol. 1132, edited by H. Araki, C. Moore, S.-V. Stratila, and D.-V. Voiculescu pp. 556–588 (Springer, 1985)
- [85] R. A. Horn and C. R. Johnson, Matrix Analysis (Cambridge, UK, 1990)
- [86] P. Neu and R. Speicher, Z. Phys. B 95, 101 (1994)
- [87] P. Neu and R. Speicher, J. Phys. A 79, L79 (1995)
- [88] P. Neu and R. Speicher, J. Stat. Phys. 80, 1279 (1995)
- [89] J. Blackman, D. Esterling, and N. Berk, Phys. Rev. B 4, 2412 (1971)
- [90] R. Movassagh and A. Edelman, Phys. Rev. Lett. 107, 097205 (2011)
- [91] K. H. Fischer and J. A. Hertz, Spin Glasses (Cambridge University Press, Cambridge, 1993)
- [92] S. Cook, in Proceedings of the Third Annual ACM Symposium on Theory of Computing, pp. 151–158 (ACM Press, New York, 1971)

- [93] N. Schuch, D. Perez-Garcia, I. Cirac, “Classifying quantum phases using Matrix Product States and PEPS” *Phys. Rev. B* 84, 165139 (2011)
- [94] F. Verstraete, M.M. Wolf, and J.I. Cirac, “Quantum computation and quantum-state engineering driven by dissipation” *Nature Physics*, 5: 633-636, (2009)
- [95] B. Kraus, H. P. Büchler, S. Diehl, A. Kantian, A. Micheli, and P. Zoller, “Preparation of entangled states by quantum Markov processes” *Phys. Rev. A* 78, 042307 (2008)
- [96] D. Nagaj, E. Farhi, J. Goldstone, P. Shor, and I. Sylvester, *Phys. Rev. B* 77, 214431 (2008)
- [97] G. Vidal, *Phys. Rev. Lett.* 91, 147902 (2003)
- [98] M. A. Nielsen and I. L. Chuang, *Quantum Computation and Quantum Information* (Cambridge University Press, Cambridge, 2000)
- [99] Z. C. Gu, M. Levin, and X. G. Wen, *Phys. Rev. B* 78, 205116 (2008)
- [100] F. Verstraete, M. Wolf, D. Perez-Garcia, and J. I. Cirac, *Phys. Rev. Lett.* 96, 220601 (2006)
- [101] D. Aharonov, D. Gottesman, and J. Kempe, *Commun. Math. Phys.* 287, 41 (2009)
- [102] D. Nagaj, arXiv:0808.2117v1 [quant-ph] (2008)
- [103] S. Bravyi, arXiv:quant-ph/0602108v1 (2006)
- [104] G. Vidal, *Phys. Rev. Lett.* 93, 040502 (2004).

- [105] M. B. Hastings, Phys. Rev. Lett. 103, 050502 (2009)
- [106] M. Hastings, Phys. Rev. B 73, 085115 (2006).
- [107] S. Bravyi, notes and private discussions.
- [108] C. Laumann, R. Moessner, A. Scardicchio, and S. L. Sondhi, Quantum Inf. Comput. 10, 0001 (2010)
- [109] Sergey Bravyi, Libor Caha, Ramis Movassagh, Daniel Nagaj, Peter Shor, "Criticality without frustration for quantum spin-1 chains", arXiv:1203.5801v1 [quant-ph]
- [110] G. Vidal, J. I. Latorre, E. Rico, and A. Kitaev, Phys. Rev. Lett, 90, 227902 (2003)
- [111] V. E. Korepin, Phys. Rev. Lett., 92, 096402 (2004)
- [112] M. B. Hastings, J. Stat. Mech., P08024 (2007)
- [113] J. Eisert, M. Cramer, and M. Plenio, Rev. Mod. Phys., 82, 277 (2010)
- [114] I. Arad, Z. Landau, and U. Vazirani, arXiv:1111.2970 (2011)
- [115] J. I. Latorre, E. Rico, and G. Vidal, Quant. Inf. Comput., 4, 48 (2004)
- [116] T. Koma and B. Nachtergaele, Lett. Math. Phys., 40, 1 (1997)
- [117] I. Affleck, T. Kennedy, E. H. Lieb, and H. Tasaki, Phys. Rev. Lett, 59, 799802 (1987)
- [118] D. Perez-Garcia, F. Verstraete, J. I. Cirac, and M. M. Wolf, Quant. Inf. Comp., 8, 0650 (2007)

- [119] J. Chen, X. Chen, R. Duan, Z. Ji, and B. Zeng, arXiv:1004.3787 (2010)
- [120] B. Kraus, H. P. Büchler, S. Diehl, A. Kantian, A. Micheli, and P. Zoller, *Phys. Rev. A*, 78, 042307 (2008)
- [121] F. Verstraete, M. M. Wolf, and J. I. Cirac, *Nature Physics*, 5, 633 (2009)
- [122] S. Diehl, A. Micheli, A. Kantian, B. Kraus, H. Büchler, and P. Zoller, *Nature Physics*, 4, 878 (2008)
- [123] R. Donaghey and L. Shapiro, *Journal of Combinatorial Theory (A)*, 23, 291 (1977)
- [124] R. P. Stanley, *Enumerative Combinatorics, Volume 2* p. 238 (Cambridge University Press, 1999)
- [125] T.V. Naryana “Lattice Path Combinatorics with Statistical Applications”, *Mathematical Exposition No. 23* (University of Toronto Press 1979)
- [126] J. L. Arregui, “Tangent and Bernoulli numbers related to Motzkin and Catalan numbers by means of numerical triangles.” <http://arxiv.org/pdf/math/0109108>
- [127] Here and below the spectral gap of a Hamiltonian means the difference between the smallest and the second smallest eigenvalue
- [128] One can regard Dyck paths as a special case of Motzkin paths in which no ‘0’ symbols are allowed
- [129] J. Kempe, A. Kitaev, and O. Regev, *SIAM J. of Comp.*, 35, 1070 (2006)
- [130] A. Schrijver, *Combinatorial Optimization* (Springer, 2002)

- [131] D. Gottesman and M. B. Hastings, *New J. Phys.*, 12, 025002 (2009)
- [132] S. Irani, *J. Math. Phys.*, 51, 022101 (2010)
- [133] R. Movassagh, E. Farhi, J. Goldstone, D. Nagaj, T. J. Osborne, and P. W. Shor, *Phys. Rev A*, 82, 012318 (2010)
- [134] Though the results of Ref. [23] are applicable to more general Hamiltonians, the convenient restriction to random projectors is sufficient for addressing the degeneracy and frustration condition.
- [135] M. M. Wolf, G. Ortiz, F. Verstraete, and J. I. Cirac, *Phys. Rev. Lett.*, 97, 110403 (2006)
- [136] P. Diaconis and D. Stroock, *Ann. Appl. Probab.*, 1, 36 (1991)
- [137] A. Sinclair, *Combinatorics, Probability, and Computing*, 1, 351 (1992)
- [138] F. Verstraete and J. Cirac, *Phys. Rev. B*, 73, 094423 (2006)
- [139] N. Schuch, J. I. Cirac, and F. Verstraete, *Phys. Rev. Lett.*, 100, 250501 (2008)