

Hard exclusive processes**

SAMUEL WALLON

LPT, Université Paris-Sud, CNRS, 91405, Orsay, France &
UPMC Univ. Paris 06, faculté de physique, 4 place Jussieu, 75252 Paris Cedex 05, France

We present the theory of hard exclusive processes, at medium and asymptotical energies, illustrated through some selected examples.

1. Introduction

1.1. Prehistory

Hard exclusive processes are very efficient tools to get insight into the internal tri-dimensional partonic structure of hadrons. The idea is to reduce a given process to interactions involving a small number of *partons* (quarks, gluons), despite confinement. This is possible if the considered process is driven by short distance

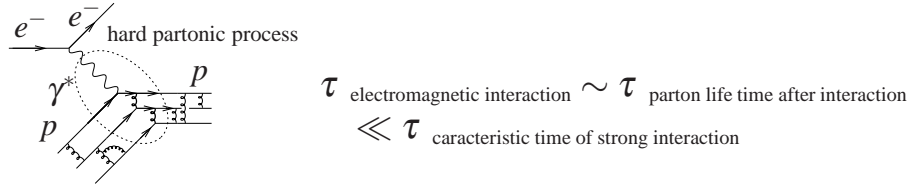

Fig. 1. Hard subprocess for the proton form factor, with the typical time scales involved.

phenomena, allowing the use of perturbative methods. One should thus hit strongly enough a hadron, as in the case of an electromagnetic probe, which gives access to form factors $F_n(q^2)$ (Fig. 1). Such exclusive reactions are very challenging since their cross section are very small. Indeed counting rules [1] show that

$$F_n(q^2) \simeq \frac{C}{(Q^2)^{n-1}} \tag{1}$$

where n is the number of minimal constituent (meson: $n = 2$; baryons: $n = 3$). Similarly, large angle (i.e. $s \sim t \sim u$ large) $h_a h_b \rightarrow h_a h_b$ elastic scattering satis-

** Presented at ISMD 2012

fies [2], for n external fermionic lines ($n = 8$ for $\pi\pi \rightarrow \pi\pi$),

$$\frac{d\sigma}{dt} \sim \left(\frac{\alpha_S(p_\perp^2)}{s} \right)^{n-2}. \quad (2)$$

Limitations to the underlying factorised description have been known since decades,



Fig. 2. Brodsky-Lepage (a) and Landshoff (b) mechanisms for $\pi\pi \rightarrow \pi\pi$ at large angle.

since other contributions might be significant, even at large angle [3]. Consider for example the process $\pi\pi \rightarrow \pi\pi$. The mechanism of Fig. 2a relies on the description of each mesons through their collinear $q\bar{q}$ content, encoded in their distribution amplitudes (DA), the whole amplitude scaling like $\frac{d\sigma_{BL}}{dt} \sim s^{-6}$. On the other hand, one can assume¹ that particular collinear quark configurations of non-perturbative origin are present inside each meson (Fig. 2b), with a scaling $\frac{d\sigma_L}{dt} \sim s^{-5}$.

1.2. Modern developments

Inclusive and exclusive processes differ due to the hard scale power suppression, making the measurements much more involved. This requires high luminosity accelerators and high-performance detection facilities, as provided by HERA (H1, ZEUS), HERMES, JLab@6 GeV (Hall A, CLAS), BaBar, Belle, BEPC-II (BES-III), LHC or by future projects (COMPASS-II, JLab@12 GeV, LHeC, EIC, ILC). In parallel, theoretical efforts have been very important during the last decade, dealing both with perturbative and power corrections, and popularising many new acronyms and concepts which we now introduce in a nutshell².

2. Collinear factorisations

2.1. Extensions from DIS

The deep inelastic scattering (DIS) total cross-section, as an *inclusive* process, involves the forward ($t = 0$) Compton amplitude, through optical theorem (Fig. 3a). The structure functions can be factorised collinearly as a convolution of coefficient functions (CFs) with parton distribution functions (PDFs). The *exclusive* deep virtual Compton scattering (DVCS) and time-like Compton scattering

¹ Such a mechanism is absent when at least one $\gamma^{(*)}$ is involved, due to its point-like coupling.

² For reviews, see [4, 5, 6, 7].

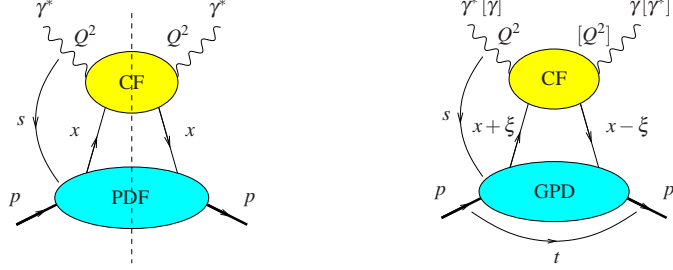
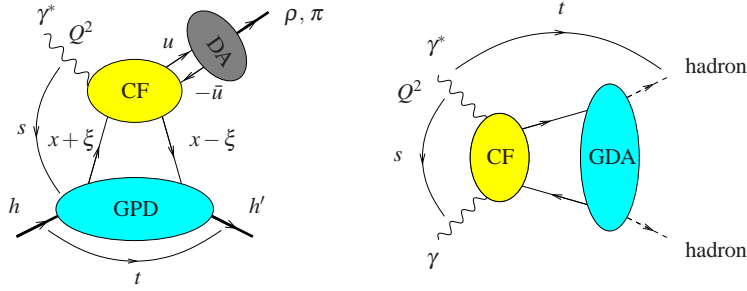
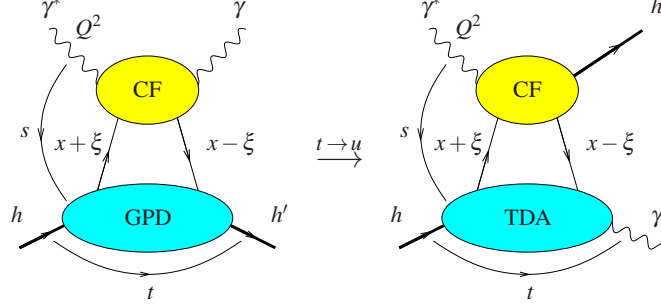

Fig. 3. (a): DIS factorisation. (b): DVCS [TCS] factorisation.

(TCS), in the limit $s_{\gamma^* p}, Q^2 \gg -t$, can also be factorised, now at the amplitude level (Fig. 3b). It involves generalised parton distribution functions (GPDs) [8] which extend the PDFs outside of the diagonal kinematical limit: the t variable as well as the longitudinal momentum transfer may not vanish, calling for new variables, the skewness ξ , encoding the inbalance of longitudinal t -channel momentum, and the transferred transverse momentum Δ .

Fig. 4. (a): Collinear factorisation of meson electroproduction. (b): Collinear factorisation of hadron pair production in $\gamma\gamma^*$ subchannel.

From DVCS, several extensions have been made. First, one may replace the produced γ by a meson, factorised collinearly through a DA [9] (Fig. 4a). Second, one may consider the crossed process in the limit $s_{\gamma^* p}, Q^2 \ll -t$. It again factorises (Fig. 4b), the $q\bar{q}$ content of the hadron pair being encoded in a generalised distribution amplitude (GDA) [10]. These frameworks allow to describe hard exotic hybrid meson production both in electroproduction and $\gamma\gamma^*$ collisions [11]. Starting from usual DVCS, one can allow the initial hadron and the final hadron to differ, replacing GPDs by transition GPDs. The conservation of baryonic number can be removed between initial and final state, introducing transition distribution amplitudes (TDAs) [12]. This can be obtained from DVCS by a $t \leftrightarrow u$ crossing (Fig. 5). A further extension is done by replacing the outgoing γ by any hadronic state [13]. The process $\gamma^* \gamma \rightarrow \rho \rho$ is of particular interest, since it can be factorised in two ways involving either the GDA of the ρ pair or the $\gamma^* \rightarrow \rho$ TDA, depending on the polarization of the incoming photons [14].

Fig. 5. $t \leftrightarrow u$ crossing from DVCS.

2.2. GPDs

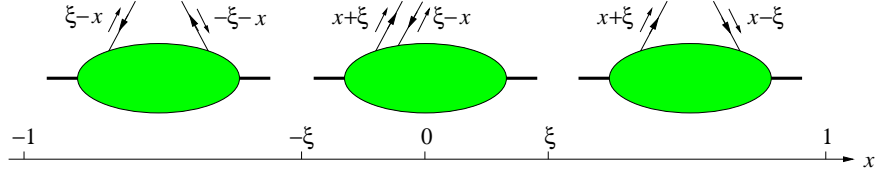

| | | |
|--|--|--|
| Emission and reabsorption of an antiquark ~ PDFs for antiquarks DGLAP-II region | Emission of a quark and emission of an antiquark ~ meson exchange ERBL region | Emission and reabsorption of a quark ~ PDFs for quarks DGLAP-I region |
|--|--|--|

Fig. 6. The parton interpretation of GPDs in the three x -intervals. Figure from [5].

The twist 2 GPDs have a simple physical interpretation, shown in Fig. 6. Their classification goes as follows, according to the chirality of the Γ matrix involved in the matrix elements F^q and \tilde{F}^q of bilocal light-cone operators defining them:

- For quarks, one should distinguish the exchanges

– without helicity flip (chiral-even Γ matrices), 4 chiral-even GPDs :

$$H^q \left(\xrightarrow{\xi=0, t=0} \text{PDF } q \right), E^q, \tilde{H}^q \left(\xrightarrow{\xi=0, t=0} \text{polarized PDFs } \Delta q \right) \text{ and } \tilde{E}^q,$$

$$\begin{aligned} F^q &= \frac{1}{2} \int \frac{dz^+}{2\pi} e^{ixP^-z^+} \langle p' | \bar{q}(-\frac{1}{2}z) \gamma^- q(\frac{1}{2}z) | p \rangle \Big|_{z^-=0, z_\perp=0} \\ &= \frac{1}{2P^-} \left[H^q(x, \xi, t) \bar{u}(p') \gamma^- u(p) + E^q(x, \xi, t) \bar{u}(p') \frac{i\sigma^{-\alpha} \Delta_\alpha}{2m} u(p) \right], \end{aligned}$$

$$\begin{aligned} \tilde{F}^q &= \frac{1}{2} \int \frac{dz^+}{2\pi} e^{ixP^-z^+} \langle p' | \bar{q}(-\frac{1}{2}z) \gamma^- \gamma_5 q(\frac{1}{2}z) | p \rangle \Big|_{z^-=0, z_\perp=0} \\ &= \frac{1}{2P^-} \left[\tilde{H}^q(x, \xi, t) \bar{u}(p') \gamma^- \gamma_5 u(p) + \tilde{E}^q(x, \xi, t) \bar{u}(p') \frac{\gamma_5 \Delta^-}{2m} u(p) \right]. \end{aligned}$$

- with helicity flip (chiral-odd Γ mat.), 4 chiral-odd GPDs:

$$H_T^q \left(\xrightarrow{\xi=0, t=0} \text{quark transversity PDFs } \Delta_T q \right), E_T^q, \tilde{H}_T^q, \tilde{E}_T^q$$

$$\begin{aligned} & \frac{1}{2} \int \frac{dz^+}{2\pi} e^{ixP^-z^+} \langle p' | \bar{q}(-\frac{1}{2}z) i\sigma^{-i} q(\frac{1}{2}z) | p \rangle \Big|_{z^-=0, z_\perp=0} \\ &= \frac{1}{2P^-} \bar{u}(p') \left[H_T^q i\sigma^{-i} + \tilde{H}_T^q \frac{P^- \Delta^i - \Delta^- P^i}{m^2} + E_T^q \frac{\gamma^- \Delta^i - \Delta^- \gamma^i}{2m} + \tilde{E}_T^q \frac{\gamma^- P^i - P^- \gamma^i}{m} \right] u(p), \end{aligned}$$

- A similar analysis can be made for twist-2 gluonic GPDs:

- 4 gluonic GPDs without helicity flip:

$$H^g \left(\xrightarrow{\xi=0, t=0} \text{PDF } xg \right), E^g, \tilde{H}^g \left(\xrightarrow{\xi=0, t=0} \text{polarized PDF } x\Delta g \right) \text{ and } \tilde{E}^g$$

- 4 gluonic GPDs with helicity flip: $H_T^g, E_T^g, \tilde{H}_T^g$ and \tilde{E}_T^g . We note that there is no forward limit reducing to gluons PDFs here: a change of 2 units of helicity cannot be compensated by a spin 1/2 target.

2.3. Transversity

The tranverse spin content of the proton is related to non-diagonal helicity observables, since

$$\text{spin along } x: \begin{array}{l} |\uparrow\rangle_{(x)} \sim |\rightarrow\rangle + |\leftarrow\rangle \\ |\downarrow\rangle_{(x)} \sim |\rightarrow\rangle - |\leftarrow\rangle \end{array} : \text{helicity states.}$$

An observable sensitive to helicity spin flip gives thus access to the transversity $\Delta_T q(x)$, which is very badly known. Meanwhile, the transversity GPDs are completely unknown. Since for massless (anti)quarks chirality = (-) helicity, transversity is a chiral-odd quantity. Now, since QCD and QED are chiral even, any chiral-odd operator should be balanced by another chiral-odd operator in the amplitude. The dominant DA for ρ_T is of twist 2 and chiral-odd. One may thus think about

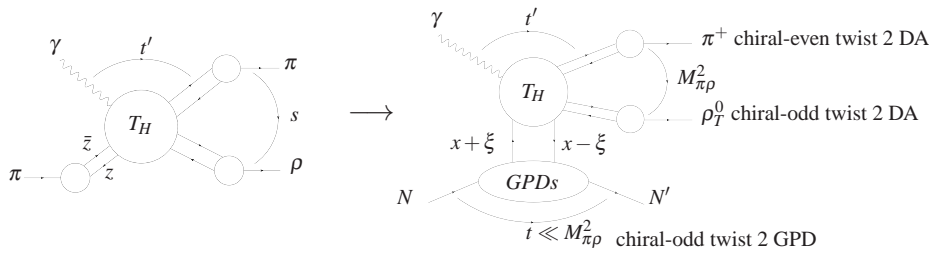

Fig. 7. Brodsky-Lepage factorisation applied to $\gamma N \rightarrow \pi^+ \rho_T^0 N'$.

using ρ_T -electroproduction. Unfortunately the amplitude vanishes, at any order in perturbation theory, since this process would require a transfer of 2 units of helicity

from the proton [15]. This vanishing is true only a twist 2, however processes involving twist 3 DAs [16] may face problems with factorisation (see Sec. 2.5). One can circumvent this vanishing by considering a 3-body final state [17]. Indeed the process $\gamma N \rightarrow \pi^+ \rho_T^0 N'$ can be described in the spirit of large angle factorisation [2] of the process $\gamma \pi \rightarrow \pi \rho$ at large s and fixed angle (i.e. for fixed t'/s , u'/s in Fig. 7), $M_{\pi\rho}^2$ providing the hard scale. Such processes with a 3-body final state can give access to all GPDs, $M_{\pi\rho}^2$ playing the role of the γ^* virtuality of usual TCS.

2.4. Resummation effects

The DVCS coefficient function has threshold singularities in its s - and u -channels, in the limits $x \rightarrow \pm\xi$. Soft-collinear effects lead to large terms of type $[\alpha_S \log^2(\xi \pm x)]^n / (x \pm \xi)$ which can be resummed in light-like gauge as ladder-like diagrams [18].

2.5. Problems with factorisation

In ρ -electroproduction, since QED and QCD vertices are chiral even, the total helicity of a $q\bar{q}$ pair produced by a γ^* should be 0, and the γ^* helicity equals $L_z^{q\bar{q}}$. In the pure collinear limit (i.e. twist 2), $L_z^{q\bar{q}}=0$, and thus the γ^* is longitudinally polarised. At $t=0$ there is no source of orbital momentum from the proton coupling so that the meson and photon helicities are identical. This statement is not modified in the collinear factorisation approach at $t \neq 0$ (the hard part is t -independent). This s -channel helicity conservation (SCHC) implies that the only allowed transitions are $\gamma_L^* \rightarrow \rho_L$, for which QCD factorisation holds at twist 2 at any order in perturbation [9], and $\gamma_T^* \rightarrow \rho_T$, for which QCD factorisation faces problems due to end-point singularities at twist 3 when integrating over quark longitudinal momenta [19]. The improved collinear approximation may be a solution: one keeps a transverse ℓ_\perp dependency in the q , \bar{q} momenta, to regulate end-point singularities. Now, soft and collinear gluon exchange between the valence quark are responsible for large double-logarithmic effects which are conjectured to exponentiate in a Sudakov factor [20], regularizing end-point singularities. This tail can be combined with an ad-hoc non-perturbative gaussian ansatz for the DAs, providing practical tools for meson electroproduction phenomenology [21].

3. QCD at large s

3.1. Theoretical motivations

The perturbative Regge limit of QCD is reached in the diffusion of two hadrons h_1 and h_2 whenever $\sqrt{s_{h_1 h_2}} \gg$ other scales (masses, transferred momenta, ...), while other scales are comparable (virtualities, etc...) and at least one of them is large enough to justify the applicability of perturbative QCD. The appearance of large

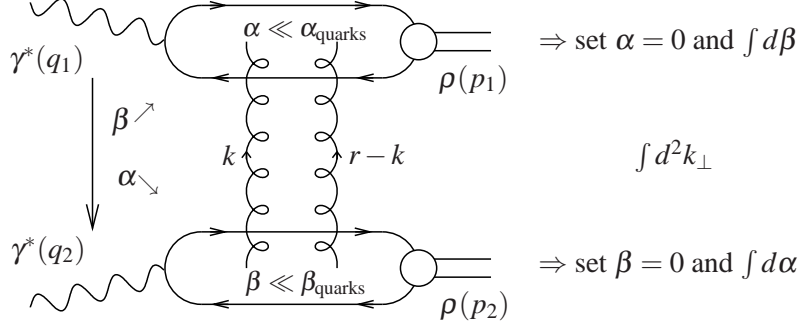
Fig. 8. k_T -factorisation applied to $\gamma^* \gamma^* \rightarrow \rho \rho$.

In s in loop corrections may compensate the smallness of α_s . The dominant sub-series $\sum_n (\alpha_s \ln s)$ leads to $\sigma_{tot}^{h_1 h_2} \sim s^{\alpha_p(0)-1}$, ($\alpha_p(0) > 1$) [22] which violates QCD S matrix unitarity. One of the main issue of QCD is to improve this result, and to test this dynamics experimentally, now in particular based on exclusive processes.

3.2. k_T -factorisation

The main tool in this regime is the k_T -factorisation, as illustrated in Fig. 8 for $\gamma^* \gamma^* \rightarrow \rho \rho$. Using the Sudakov decomposition $k = \alpha p_1 + \beta p_2 + k_\perp$ (with $p_1^2 = p_2^2 = 0$, $2p_1 \cdot p_2 = s$), in which $d^4 k = \frac{s}{2} d\alpha d\beta d^2 k_\perp$, and noting that the dominant polarization of the t -channel gluons is non-sense, i.e. $\epsilon_{NS}^{up} = \frac{2}{s} p_2$, $\epsilon_{NS}^{down} = \frac{2}{s} p_1$, one obtains the impact representation for exclusive processes amplitude³

$$\mathcal{M} = is \int \frac{d^2 \underline{k}}{(2\pi)^2 \underline{k}^2 (\underline{r} - \underline{k})^2} \Phi^{\gamma^*(q_1) \rightarrow \rho(p_1^p)}(\underline{k}, \underline{r} - \underline{k}) \Phi^{\gamma^*(q_2) \rightarrow \rho(p_2^p)}(-\underline{k}, -\underline{r} + \underline{k}) \quad (3)$$

where $\Phi^{\gamma^*(q_1) \rightarrow \rho(p_1^p)}$ is the $\gamma_{L,T}^*(q) g(k_1) \rightarrow \rho_{L,T} g(k_2)$ impact factor.

3.3. Meson production

The "easy" case (from factorisation point of view) is J/Ψ production, whose mass provides the required hard scale [23]. Exclusive vector meson photoproduction at large t (providing the hard scale) is another example (which however faces problem with end-point singularities) for which HERA data seems to favor a BFKL picture [24]. Exclusive electroproduction of vector meson can also be described [21] based on improved collinear factorisation for the coupling with the meson DA and collinear factorisation for GPD coupling.

³ \underline{k} = Eucl. \leftrightarrow k_\perp = Mink.

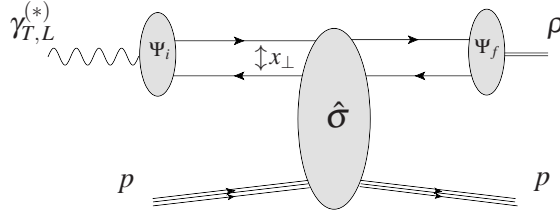

Fig. 9. Dipole representation for $\gamma^* p \rightarrow \rho p$ high energy scattering.

The process $\gamma^{(*)}\gamma^{(*)} \rightarrow \rho\rho$ is an example of a realistic exclusive test of the \mathbb{P} omeron, as a subprocess of $e^-e^+ \rightarrow e^-e^+\rho_L^0\rho_L^0$ with double lepton tagging, to be made at ILC which should provide the required very large energy ($\sqrt{s} \sim 500$ GeV) and luminosity ($\simeq 125 \text{ fb}^{-1}/\text{year}$), with the planned detectors designed to cover the very forward region, close from the beampipe [25].

Diffractive vector meson electroproduction have recently been described beyond leading twist, combining collinear factorisation and k_T -factorisation. Based on the $\gamma_{L,T}^* \rightarrow \rho_{L,T}$ impact factor including two- and three-partons contributions, one can describe HERA data on the ratio of the dominant helicity amplitudes [26]. The dipole representation of high energy scattering [27] (Fig. 9) is very convenient to implement saturation effects, through a universal scattering amplitude $\hat{\sigma}(x_{\perp})$ [28]. Data for ρ production call for models encoding saturation [29]. This dipole representation is consistent with the twist 2 collinear factorisation, and remains valid beyond leading twist. It seems however that saturation is not enough to describe low Q^2 HERA data [30]. The impact parameter dependence provides a probe of the proton shape, in particular through local geometrical scaling [31].

3.4. Looking for the Odderon through exclusive processes

The \mathbb{O} dderon, elusive C -odd partner of the \mathbb{P} omeron, has never been seen in any hard process. One may either consider exclusive processes where the $\mathcal{M}_{\mathbb{P}}$ amplitude vanishes due to C -parity conservation [32] the signal being quadratic in the $\mathcal{M}_{\mathbb{O}}$ contribution, or consider observables sensitive to the interference between $\mathcal{M}_{\mathbb{P}}$ and $\mathcal{M}_{\mathbb{O}}$, like asymmetries, thus providing observables linear in $\mathcal{M}_{\mathbb{O}}$ [33].

4. Conclusion

Since a decade, there have been much progress in the understanding of hard exclusive processes. At medium energies, there is now a conceptual framework starting from first principles, allowing to describe a huge number of processes. At high energy, the impact representation is a powerful tool for describing exclusive processes in diffractive experiments; they are and will be essential for studying QCD in the hard Regge limit (\mathbb{P} omeron, \mathbb{O} dderon, saturation...). Still, some problems

remain: proofs of factorisation have been obtained only for very few processes (ex.: $\gamma^* p \rightarrow \gamma p$, $\gamma_L^* p \rightarrow \rho_L p$). For some other processes, it is highly plausible, but not fully demonstrated, like those involving GDAs and TDAs. Some processes explicitly show sign of breaking of factorisation (ex.: $\gamma_T^* p \rightarrow \rho_T p$ at leading order). The effect of QCD evolution, the NLO corrections and the choice of renormalization/factorisation scale [34], as well as power corrections will be very relevant to interpret and describe the forecoming data. The AdS/QCD correspondence may provide insight for modeling the involved non-perturbative correlators [35].

REFERENCES

- [1] S. J. Brodsky, G. R. Farrar, *Phys. Rev. Lett.* **31**, 1153 (1973); *Phys. Rev.* **D11**, 1309 (1975).
- [2] S. J. Brodsky, G. P. Lepage, *ibid.* **D24**, 1808 (1981).
- [3] P. V. Landshoff, *ibid.* **D10**, 1024 (1974).
- [4] P. A. M. Guichon, M. Vanderhaeghen, *Prog. Part. Nucl. Phys.* **41**, 125 (1998); K. Goetze *et al.*, *ibid.* **47**, 401 (2001).
- [5] M. Diehl, *Phys. Rept.* **388**, 41 (2003).
- [6] A. V. Belitsky, A. V. Radyushkin, *ibid.* **418**, 1 (2005).
- [7] S. Boffi, B. Pasquini, *Riv. Nuovo Cim.* **30**, 387 (2007); V. D. Burkert, M. Diehl, *In *Close, Frank (ed.) et al.: Electromagnetic interactions and hadronic structure** 359-423; M. Guidal, *Prog. Part. Nucl. Phys.* **61**, 89 (2008); S. Wallon, *Few Body Syst.* **53**, 59 (2012).
- [8] D. Mueller *et al.*, *Fortschr. Phys.* **42**, 101 (1994); A. V. Radyushkin, *Phys. Lett.* **B380**, 417 (1996); X-D. Ji, *Phys. Rev. Lett.* **78**, 610 (1997).
- [9] J. C. Collins *et al.*, *Phys. Rev.* **D56**, 2982 (1997); A. V. Radyushkin, *Phys. Lett.* **B385**, 333 (1996).
- [10] M. Diehl *et al.*, *Phys. Rev. Lett.* **81**, 1782 (1998).
- [11] I. V. Anikin *et al.*, *Phys. Rev.* **D70**, 011501 (2004); **D71**, 034021 (2005); *Eur. Phys. J.* **C47**, 71 (2006).
- [12] B. Pire, L. Szymanowski, *Phys. Rev.* **D71**, 111501 (2005).
- [13] B. Pire, L. Szymanowski, *Phys. Lett.* **B622**, 83 (2005); J. P. Lansberg *et al.*, *Phys. Rev.* **D76**, 111502 (2007).
- [14] B. Pire *et al.*, *Phys. Lett.* **B639**, 642 (2006).
- [15] M. Diehl *et al.*, *Phys. Rev.* **D59**, 034023 (1999); J. C. Collins, M. Diehl, *ibid.* **D61**, 114015 (2000).
- [16] P. Ball *et al.*, *Nucl. Phys.* **B529**, 323 (1998); *ibid.* **B543**, 201 (1999); *JHEP* **0708**, 090 (2007).
- [17] D. Yu. Ivanov *et al.*, *Phys. Lett.* **B550**, 65 (2002); R. Enberg *et al.*, *Eur. Phys. J.* **C47**, 87 (2006); M. El Beiyad *et al.*, *Phys. Lett.* **B688**, 154 (2010).
- [18] T. Altinoluk *et al.*, *JHEP* **1210**, 049 (2012); arXiv:1206.3115 [hep-ph].

- [19] L. Mankiewicz, G. Piller, *Phys. Rev.* **D61**, 074013 (2000).
- [20] H-N. Li, G. Sterman, *Nucl. Phys.* **B381**, 129 (1992).
- [21] S. V. Goloskokov, P. Kroll, *Eur. Phys. J.* **C42**, 281 (2005); **C50**, 829 (2007); **C53**, 367 (2008).
- [22] V. S. Fadin *et al.*, *Phys. Lett.* **B60**, 50 (1975); *Sov. Phys. JETP* **44**, 443 (1976); **45**, 199 (1977); I. I. Balitsky, L. N. Lipatov, *Sov. J. Nucl. Phys.* **28**, 822 (1978).
- [23] M. G. Ryskin, *Z. Phys.* **C57**, 89 (1993); L. Frankfurt *et al.*, *Phys. Rev.* **D57**, 512 (1998); R. Enberg *et al.*, *Eur. Phys. J.* **C26**, 219 (2002); D.Yu. Ivanov *et al.*, *ibid.* **C34**, 297 (2004).
- [24] D. Yu. Ivanov *et al.*, *Phys. Lett.* **B478**, 101 (2000); R. Enberg *et al.*, *JHEP* **09**, 008 (2003); G. G. Poludniowski *et al.*, *ibid.* **12**, 002 (2003).
- [25] B. Pire *et al.*, *Eur. Phys. J.* **C44**, 545 (2005); R. Enberg *et al.*, *ibid.* **C45**, 759 (2006) [Erratum-*ibid.* **C 51** 1015 (2007)]; M. Segond *et al.*, *ibid.* **C52**, 93 (2007); D. Yu. Ivanov, A. Papa, *Nucl. Phys.* **B732**, 183 (2006); *Eur. Phys. J.* **C49**, 947 (2007); F. Caporale *et al.*, *ibid.* **C53**, 525 (2008).
- [26] I. V. Anikin *et al.*, *Phys. Lett.* **B682**, 413 (2010); *Nucl. Phys.* **B828**, 1 (2010); *Phys. Rev.* **D84**, 054004 (2011).
- [27] A. H. Mueller, *Nucl. Phys.* **B335**, 115 (1990); N. N. Nikolaev, B. G. Zakharov, *Z. Phys.* **C49**, 607 (1991).
- [28] K. J. Golec-Biernat, M. Wusthoff, *Phys. Rev.* **D59**, 014017 (1999); **D60**, 114023 (1999).
- [29] S. Munier *et al.*, *Nucl. Phys.* **B603**, 427 (2001); H. Kowalski *et al.*, *Phys. Rev.* **D74**, 074016 (2006).
- [30] A. Besse *et al.*, *Nucl. Phys.* **B867**, 19 (2013); arXiv:1302.1766 [hep-ph].
- [31] E. Ferreira *et al.*, *Nucl. Phys.* **A710**, 373 (2002). S. Munier, S. Wallon, *Eur. Phys. J.* **C30**, 359 (2003).
- [32] I. F. Ginzburg, D. Yu. Ivanov, *Nucl. Phys.* **B388**, 376 (1992); S. Braunewell, C. Ewerz, *Phys. Rev.* **D70**, 014021 (2004); A. Bzdak *et al.*, *ibid.* **D75**, 094023 (2007).
- [33] S. J. Brodsky *et al.*, *Phys. Lett.* **B461**, 114 (1999); I. F. Ginzburg *et al.*, *Eur. Phys. J. direct* **C5**, 02 (2003); *Eur. Phys. J.* **C32S1**, 23 (2003); Ph. Hagler *et al.*, *Phys. Lett.* **B535**, 117 (2002); *Nucl. Phys.* **A711**, 232 (2002); *Eur. Phys. J.* **C26**, 261 (2002); B. Pire *et al.*, *Phys. Rev.* **D78**, 094009 (2008).
- [34] S. J. Brodsky *et al.*, *Phys. Rev.* **D28**, 228 (1983); I. V. Anikin *et al.*, *Eur. Phys. J.* **C42**, 163 (2005); H. Moutarde *et al.*, arXiv:1301.3819 [hep-ph].
- [35] S. J. Brodsky, G. F. de Teramond, *Phys. Rev. Lett.* **96**, 201601 (2006); J-H. Gao, B-W. Xiao, *Phys. Rev.* **D81**, 035008 (2010); C. Marquet *et al.*, *JHEP* **04**, 051 (2010).