

OPENING ANGLES OF COLLAPSAR JETS

AKIRA MIZUTA

Theory Center, Institute of Particle and Nuclear Studies, KEK, Tsukuba 305-0801, Japan
Computational Astrophysics Laboratory, RIKEN, Wako, 351-0198, Japan

KUNIHITO IOKA

Theory Center, Institute of Particle and Nuclear Studies, KEK
Department of Particles and Nuclear Physics, the Graduate University for Advanced Studies (Sokendai), Tsukuba 305-0801, Japan
KEK-TH-1615, KEK-Cosmo-119

ABSTRACT

We investigate the jet propagation and breakout from the stellar progenitor for gamma-ray burst (GRB) collapsars by performing two-dimensional relativistic hydrodynamic simulations and analytical modeling. We find that the jet opening angle is given by $\theta_j \sim 1/5\Gamma_0$ and infer the initial Lorentz factor of the jet at the central engine, Γ_0 , is a few for existing observations of θ_j . The jet keeps the Lorentz factor low inside the star by converging cylindrically via collimation shocks under the cocoon pressure, and accelerates at jet breakout before the free expansion to a hollow-cone structure. In this new picture the GRB duration is determined by the sound crossing time of the cocoon, after which the opening angle widens, reducing the apparent luminosity. Some bursts violating the maximum opening angle $\theta_{j,\max} \sim 1/5 \sim 12^\circ$ imply the existence of a baryon-rich sheath or a long-acting jet. We can explain the slopes in both Amati and Yonetoku spectral relations using an off-centered photosphere model, if we make only one assumption that the total jet luminosity is proportional to the initial Lorentz factor of the jet. We also numerically calibrate the pre-breakout model (Bromberg et al.) for later use.

Subject headings: (stars:) gamma-ray burst: general — hydrodynamics — ISM: jets and outflows — methods: analytical numerical — methods: numerical

1. INTRODUCTION

Gamma-ray bursts (GRBs) are the brightest objects in the universe. The observed isotropic energy (the apparent energy if it is emitted isotropically) is of the order of or even sometimes more than the solar rest mass energy of $M_\odot c^2 \sim 2 \times 10^{54}$ erg. Current understanding is that the GRB prompt emission is produced by a relativistic collimated jet, whose (half) opening angle is $\theta_j \sim 0.1$ and Lorentz factor is more than $\Gamma > 100$, significantly alleviating the energy requirements.

The opening angle of a GRB jet is an important quantity not only for the energetics but also for the event rate of the GRB. The opening angle also carries information about the central engine. It is difficult to get any information on the opening angle from observations of the prompt emission, which is beamed into an angle $\sim 1/\Gamma$ by a relativistic effect. The opening angle of a GRB is measured by the light curve of the afterglow that follows the prompt GRB. The afterglow light curve exhibits a break when the jet decelerates to a Lorentz factor of $\Gamma \sim 1/\theta_j$, the so-called a jet break, and we can estimate the opening angle from the jet break time (Sari et al. 1999). Recent observations suggest that the opening angle of long GRBs are distributed over several to tens of degrees ($6^\circ \approx 0.1$ rad; e.g., Fong et al. 2012).

What physics determines the opening angle of GRB jets is not known yet. In order to understand the physical origin of the jet opening angle, we have to closely examine jet propagation and breakout from the surrounding matter. Because some GRBs are associated with supernovae (Galama et al. 1998; Iwamoto et al. 1998; Stanek

et al. 2003; Campana et al. 2006; Mazzali et al. 2006), a long GRB is thought to arise from the death of a massive star. A jet is launched deep inside the progenitor, and should break out from the stellar envelope to be observed as a GRB. This is the so-called collapsar model (Woosley 1993; MacFadyen & Woosley 1999). When the jet collides with the stellar envelope, a shocked jet and a shocked envelope move sideways from the jet head and form a cocoon.¹ At the expense of the shocked matter, the jet head moves outward and finally drills a hole in the stellar envelope. This is called the jet breakout.²

There are many simulations of jet propagation for the collapsar model. Aloy et al. (2000) were the first to show that a relativistic jet can penetrate the stellar envelope while maintaining good collimation. Zhang et al. (2003, 2004) and Mizuta et al. (2006) studied jet propagation for collapsars with a wide range of jet parameters, such as luminosity, initial Lorentz factor, and so on. Morsony et al. (2007) discussed the evolution of the jet opening angle and indicated that the opening angle of the jet is relatively smaller than the initial opening angle. However the physical origin of the jet opening angle is still unclear. What determines the opening angle of the jet?

¹ In some articles, a cocoon indicates only the shocked jet that has moved sideways. However, the shocked jet is mixed with the shocked stellar envelope by the shear interaction and loses its identity. Since it is difficult to define the contact discontinuity, we use the term “cocoon” for both the shocked jet and the shocked stellar envelope in a broad sense.

² To be precise, a jet breakout is different from a shock breakout that occurs when a forward shock reaches the stellar surface. This is also different from a jet break seen in the afterglow light curve.

We consider that the opening angle is given by

$$\theta_j \sim \frac{1}{\Gamma}, \quad (1)$$

where Γ is the Lorentz factor at the jet breakout from the stellar envelope (Matzner 2003; Toma et al. 2007). In order to infer Γ , the cocoon pressure is important as it confines the jet (Matzner 2003; Toma et al. 2007; Ioka et al. 2011). After passing through the collimation shock (Komissarov & Falle 1997), the jet becomes cylindrical since the cocoon pressure is uniform inside the star. A cylindrical jet is actually observed in simulations (Zhang et al. 2003, 2004; Mizuta et al. 2006; Morsony et al. 2007; Lazzati et al. 2009, 2013; Mizuta et al. 2011) and recently discussed by Bromberg et al. (2011) in an analytical way. The Lorentz factor of a cylindrical (stationary) jet is constant ($\Gamma \sim \Gamma_0$) because of flux conservation. Therefore a naive expectation is that the opening angle is given by the inverse of the initial Lorentz factor,

$$\theta_j \sim \frac{1}{\Gamma_0}, \quad (2)$$

as shown in the right panel of Figure 1 (the conventional picture).

In this paper, we explore the evolution of the opening angle for long GRB jet, and show that the naive expectation in Equation (2) is partly false. We perform a series of numerical hydrodynamic simulations for jet propagation and breakout from collapsars. We find that the opening angle is a factor ~ 5 smaller than $1/\Gamma_0$, and identify its physical origin with the jet-breakout acceleration, that is, the jet accelerates at the jet breakout before a free expansion as shown in the left panel of Figure 1 (the new picture). The jet-breakout acceleration boosts the Lorentz factor Γ by a factor of ~ 5 above than Γ_0 . Thus Equation (1) is correct but Equation (2) is not correct.

We also examine the jet dynamics in an analytical way. We first compare the numerical results with analytical formulae before the jet breakout by Bromberg et al. (2011). We calibrate the model parameters with careful numerical calculations, and make the formulae easier to use. Then we make an analytical model for the jet-breakout acceleration after the jet breakout.

In the new picture of Figure 1, the GRB duration (T_{90}) is determined by the sound crossing time of the cocoon. After that time, the cocoon pressure decreases so that the jet is no longer confined by the cocoon. The opening angle widens from $\theta_j \sim 1/5\Gamma_0$ (our result) to $\theta_j \sim 1/\Gamma_0$ (free expansion), reducing the apparent isotropic luminosity by a factor of ~ 25 . The GRB appears to end even if the central engine is still active. Therefore the jet-breakout acceleration is essential for the observed GRB duration.

We infer the initial Lorentz factor of the jet ejected from the central engine by using the observed opening angles. We also argue for a possible origin of the observed spectral relations, the Amati and Yonetoku relations (Amati et al. 2002; Yonetoku et al. 2004). We derive the slopes in both the relations with only one assumption on the jet injection: that the total jet luminosity is proportional to the initial Lorentz factor ($L_j \propto \Gamma_0$), under the photosphere model of GRB prompt emission. These are interesting suggestions for the emission mech-

anism of the prompt emission as well as the jet formation mechanism.

The paper is organized as follows. In Section 2, we describe the numerical method and the initial conditions for the jet parameters. We also introduce the probe particles to measure the jet opening angle. In Section 3, we show the main results of the hydrodynamic calculations and the time evolution of the opening angles. In Section 4, we present the analytical model of the jet dynamics and the opening angle of the jet and compare these quantities with the numerical results. In Section 5, we apply our results with the observations of the opening angle, the GRB duration, and the spectral relations to probe the initial conditions of the jet from the central engine and the emission mechanism of the prompt emission. Finally, we summarize our results and give our conclusions in Section 6.

2. NUMERICAL METHOD

2.1. Numerical Scheme

We have performed two dimensional axis-symmetric relativistic hydrodynamic simulations of jet propagation before and after the eruption from a progenitor surface in order to obtain the final opening angle of the jet θ_j . An updated version of the relativistic hydrodynamic code developed by one of the authors (AM) is used for the hydrodynamic simulations. The code solves special relativistic hydrodynamic equations. We adopt an adiabatic equation of state, $P = (\gamma - 1)\rho\epsilon$, with a constant specific heat ratio, $\gamma = 4/3$, where P is the pressure, ρ is the rest mass density, and ϵ is the specific internal energy.

The hydrodynamic code employs the Godunov type fluxes, i.e., an approximate Riemann solver. The version of Marquina's flux formula (Donat & Marquina 1996) is used for numerical fluxes. The second-order accuracy in space is achieved by the MUSCL method (van Leer 1977) and the second-order accuracy in time is achieved by the total variation diminishing (TVD) Runge-Kutta method (Shu & Osher 1988). Any radiative processes, such as emission or absorption of photons are not included in the calculations. The details of the code and results of one-dimensional and two-dimensional test calculations are presented in the appendices of Mizuta et al. (2004, 2006).

2.2. Grid

Cylindrical coordinate (z, r) are employed for the hydrodynamic simulations (z is the direction of jet propagation). In this study, axis-symmetry is assumed for simplicity. $6400 (z) \times 500 (r)$ grid points are used. The high resolution grid points are centered around the cylindrical axis so that the interaction with the stellar envelope is accurately captured. The fine grid points ($10^7 \text{ cm} \times 10^7 \text{ cm}$) are spaced uniformly at $10^9 \text{ cm} \leq z \leq 4 \times 10^{10} \text{ cm}$, and $0 \leq r \leq 2 \times 10^9 \text{ cm}$ which covers the entire jet and a part of the cocoon at the jet-breakout time. Logarithmic linear grids are spaced both in z and r coordinates at $4 \times 10^{10} \text{ cm} \leq z \leq 4.3 \times 10^{11} \text{ cm}$ and $2 \times 10^9 \text{ cm} \leq r \leq 1.1 \times 10^{11} \text{ cm}$. At the outer boundaries, the grid sizes are $\Delta z = 7 \times 10^8 \text{ cm}$ and $\Delta r = 1.6 \times 10^9 \text{ cm}$, respectively.

We perform a resolution study with twice the resolution of the grids [$9728 (z) \times 500 (r)$]. The fine grid

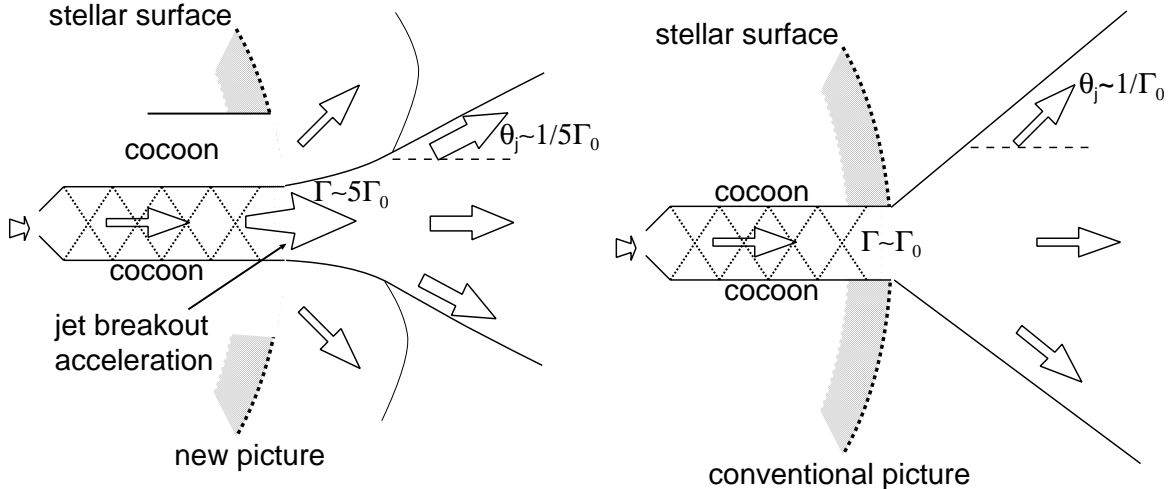

FIG. 1.— Physical picture of the jet evolution at the jet breakout. Inside the star, the Lorentz factor of the jet keeps the initial value $\sim \Gamma_0$ since the jet is almost cylindrical before the jet breakout. After the jet breakout, the opening angle of the jet is $\sim 1/5\Gamma_0$ (left panel) rather than $\sim 1/\Gamma_0$ (right panel), because the jet-breakout acceleration occurs at the jet breakout where the pressure of the cocoon decreases outward.

points (5×10^6 cm \times 5×10^6 cm) are spaced uniformly at 10^9 cm $\leq z \leq 4 \times 10^{10}$ cm and $0 \leq r \leq 10^9$ cm which covers the jet and some parts of the cocoon at the jet breakout time. Logarithmic linear grids are spaced both in z and r coordinates at 4×10^{10} cm $\leq z \leq 6.2 \times 10^{11}$ cm and 1×10^9 cm $\leq r \leq 1.1 \times 10^{11}$ cm. At the outer boundaries, the grid sizes are $\Delta z = 2 \times 10^9$ cm and $\Delta r = 2.2 \times 10^9$ cm, respectively. The results of the resolution study are given in Section 3.7.

The resolution with $\Delta z_{\min} = \Delta r_{\min} = 10^7$ cm is comparable with the highest resolution zone in Morsony et al. (2007, 2010) who adopted the adaptive mesh refinement technique, while our high resolution area covers much larger area. Our resolution study uses $\Delta z_{\min} = \Delta r_{\min} = 5 \times 10^6$ cm, which is one of the highest resolutions so far.

The boundary condition is the free boundary condition except for the jet injection region and the cylindrical axis. The reflective boundary condition is imposed at the cylindrical axis.

2.3. Stellar Model

We adopt one of stellar models in Woosley & Heger (2006) for the progenitor of the GRB. The model is named 16TI. The total mass and radius of the progenitor at the pre-supernova stage are 13.95 solar mass and $R_* = 4 \times 10^{10}$ cm, respectively, where R is the radius in spherical coordinates. The mass density at the innermost boundary ($z = 10^9$ cm) is about 10^5 g cm $^{-3}$. The radial mass density distribution of the progenitor is almost a power law with an index ~ -1.5 at 10^9 cm $\leq R \leq 6 \times 10^9$ cm and quickly drops at $R > 6 \times 10^9$ cm. The mass density at the last grid of the progenitor ($R = R_*$) is 1.7×10^{-5} g cm $^{-3}$. Outside the progenitor, we put a low density gas assuming a stellar wind with a power-law index -2 , i.e., $\rho(R) = 1.7 \times 10^{-14} (R/R_*)^{-2}$ g cm $^{-3}$. See the radial mass density profile in Figure 2.

2.4. Jet Conditions

Assuming the jet formation deep inside the progenitor, we start the numerical calculation at a distance of $z_{\min} = 10^9$ cm from the center of the progenitor. From

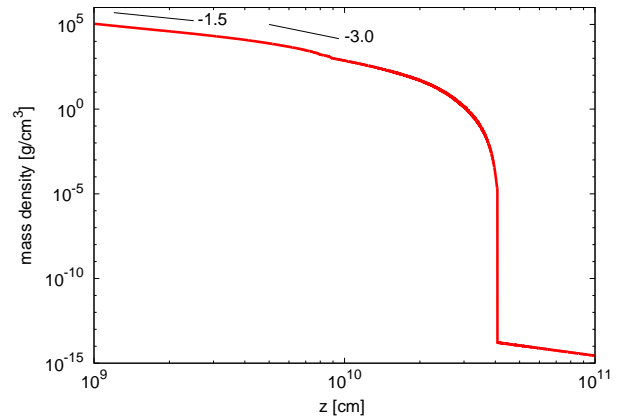

FIG. 2.— Initial radial mass density profile (model 16TI in Woosley & Heger (2006)). The radial mass density profile is almost power law at 10^9 cm $\leq R \leq 6 \times 10^{10}$ cm with an index ~ -1.5 . Then it quickly drops at $R > 6 \times 10^9$ cm. We extend the gas to the outside of the progenitor ($R > 4 \times 10^{10}$ cm) which is assumed to be very dilute and a stellar wind profile with the a power-law index -2 .

the innermost computational boundary, we inlet the jet into the computational domain.

At least four parameters are necessary to characterize the initial condition of the jet. We choose the cylindrical radius (r_0), the luminosity (L_j), the Lorentz factor (Γ_0), and the specific enthalpy ($h_0 \equiv 1 + \epsilon_0/c^2 + P_0/\rho_0$) of the initial jet, where the subscript “0” stands for the injection parameter. Since we inlet the jet parallel to the jet axis with a small radius (r_0), it is not necessary to assume an initial opening angle of the jet (θ_0), which is determined by the relativistic beaming effect to be $\theta_0 \approx 1/\Gamma_0$. This allows us to reduce the number of initial parameters.

1. We adopt the initial cylindrical radius of the jet as $r_0 = 8 \times 10^7$ cm. This value should be sufficiently smaller than Equation (26), which is supposed to be the cylindrical radius of the jet after the collimation shock (i.e., the cylindrical ra-

dius of the jet balanced with the cocoon pressure). If the initial cylindrical radius was larger than Equation (26), the jet dynamics would be different from the true ones because a thick jet sweeps out a large mass. Even though r_0 should be small, we still need to cover the jet with a sufficient number of grid points. In our simulations, 8 and 16 grid points cover the jet at the boundary for the resolutions, $\Delta z_{\min} = \Delta r_{\min} = 10^7$ cm and $\Delta z_{\min} = \Delta r_{\min} = 5 \times 10^6$ cm, respectively. Our resolution is high enough to resolve internal structures, such as shocks and vortices, inside the jet and the cocoon.

2. We consider a constant luminosity jet ($L_j = 5 \times 10^{50}$ erg s $^{-1}$) for simplicity. Thus the explosion energy is $\sim 10^{52}$ erg for a few tens of seconds duration the jet injection, which is comparable with the values inferred from the observations.
3. Another two parameters that define the initial jet are the specific enthalpy (h_0) and the Lorentz factor of the jet (Γ_0). We fix the product of two parameters, i.e., $h_0\Gamma_0$ to be 538 in this paper. The product $h_0\Gamma_0$ gives the maximum Lorentz factor achieved by the adiabatic expansion, since $h\Gamma$ is conserved by the relativistic Bernoulli principle along a stream line for a steady state. A gas with large enthalpy ($h \gg 1$) expands adiabatically by decreasing h and increasing Γ , i.e., the jet accelerates with a fixed $h\Gamma$. Our assumption ($h_0\Gamma_0 = 538$) satisfies $h_0\Gamma_0 > 100$, which is required for avoiding the compactness problem of the GRB. The recent *Fermi* bursts suggest a relatively large $h\Gamma$ (Abdo et al. 2009; Ackermann et al. 2010; Ioka 2010).
4. The initial Lorentz factors, $\Gamma_0 = 2.5, 5,$ and $10,$ are studied to determine the dependence on Γ_0 of the jet dynamics and the opening angle after the jet breakout. These are the models: G2.5 ($\Gamma_0 = 2.5$), G5.0 ($\Gamma_0 = 5$), and G10 ($\Gamma_0 = 10$). We also perform hydrodynamic simulations with higher resolutions. These are the models: G2.5H ($\Gamma_0 = 2.5$), G5.0H ($\Gamma_0 = 5$), and G10H ($\Gamma_0 = 10$). Since we fix $h_0\Gamma_0 (= 538)$, the initial enthalpy (h_0) is the smallest ($h_0 = 53.8$) for the case with $\Gamma_0 = 10$. Thus all jets are initially thermal-dominated plasma ($h_0 \gg 1$). The initial specific internal energy (ϵ_0/c^2) is 80 for the model with $\Gamma_0 = 5$. As shown later, these initial Lorentz factors are crucial parameters for the final opening angles. We set the velocity vector of the jet initially parallel to the z -axis. The jet expands with an initial opening angle $\sim 1/\Gamma_0$ as long as the injection angle is less than $\sim 1/\Gamma_0$.

Table 1 summarizes the initial jet conditions of our models.

2.5. Probe Particles

In order to follow the Lagrange motion of the fluid elements, we introduce probe particles to trace the path of the fluid elements. It is necessary to follow the Lagrange motion of the fluid elements to define the opening angle of the jet, since the jet opening angle depends on

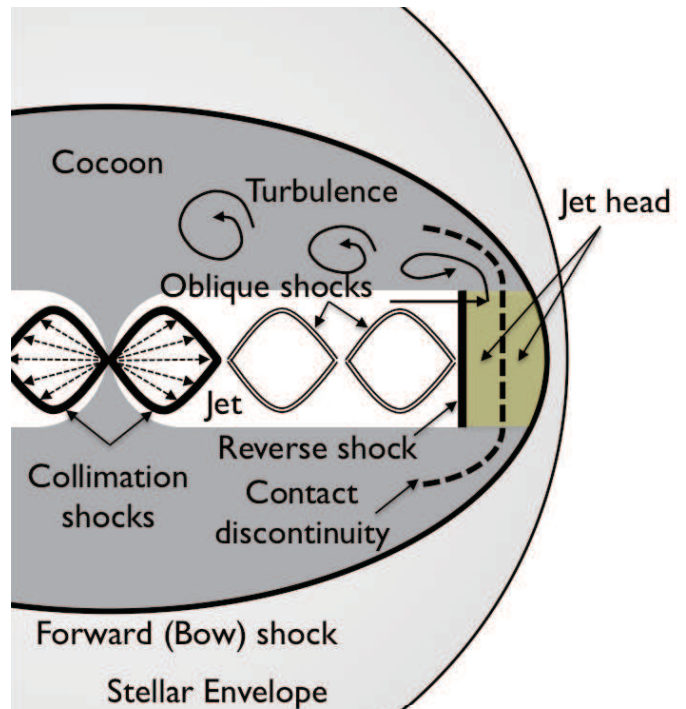

FIG. 3.— Schematic figure of the jet while the forward shock is inside the progenitor star.

time. Every 0.01 s, 32 particles are injected into the computational domain with the jet. In the injection region at $z_{\min} = 10^9$ cm, 32 particles are uniformly spaced at $0 \leq r \leq r_0 = 8 \times 10^7$ cm. In every hydrodynamic time step (Δt), the particles move with their local velocities calculated by the hydrodynamic simulation, i.e., $\mathbf{x}_{\text{new}} = \mathbf{x}_{\text{old}} + \mathbf{v}\Delta t$, where \mathbf{x} is the position of a particle and \mathbf{v} is the local velocity.

Tracing the Lagrangian motion of the fluid elements allows us to find the location where the free expansion starts after the jet breakout. Since we define the jet opening angle by the direction of free expansion (see, Section 3.4), the Lagrangian motion is very important for the quantitative analysis, especially for finding a relationship between the opening angle and the Lorentz factor. The particle path is also useful for identifying whether the fluid elements have moved into the cocoon or not.

3. RESULTS

3.1. Overall Evolution

The jets in all models of Table 1 successfully drill through the stellar envelopes. Before the jet breakout, the jet hits the reverse shock that is produced by the interaction between the jet and the stellar envelope. Then, the shocked jet moves sideways, forming a high pressure cocoon, as shown in the schematic Figure 3 (Ramirez-Ruiz et al. 2002). The high pressure in the cocoon works to confine the jet. The jet is confined through a collimation shock that deflects the velocity vector into a direction parallel to the cylindrical axis. The high pressure cocoon is also discussed in the context of Fanaroff-Riley type II jets (Begelman & Cioffi 1989).

When the forward shock reaches the stellar surface, the shocked stellar envelope starts to expand into the circumstellar matter, i.e., shock breakout occurs. Soon the jet also starts to expand into the circumstellar matter, i.e.,

TABLE 1
JET INITIAL CONDITIONS OF THE MODELS

Model	Γ_0 ^a	Luminosity (L_j) (erg s ⁻¹)	Initial Jet Cylindrical Radius (r_0) (cm)	$h_0\Gamma_0(\cong\Gamma_\infty)$	$\Delta z_{\min} = \Delta r_{\min}$ ^b (cm)
G2.5	2.5				
G5.0	5.0	5×10^{50}	8×10^7 cm	538	10^7 ^c
G10	10				
G2.5H	2.5				
G5.0H	5.0	5×10^{50}	8×10^7 cm	538	5×10^6 ^d
G10H	10				

^a Initial Lorentz factor

^b Highest resolution grid size in the computational domain

^c At the region of $10^9 \text{ cm} \leq z \leq 4 \times 10^{10} \text{ cm}$ and $0 \leq r \leq 2 \times 10^9 \text{ cm}$

^d At the region of $10^9 \text{ cm} \leq z \leq 4 \times 10^{10} \text{ cm}$ and $0 \leq r \leq 1 \times 10^9 \text{ cm}$

jet breakout occurs, as presented in previous numerical simulations (Aloy et al. 2000; Zhang et al. 2003, 2004; Mizuta et al. 2006; Morsony et al. 2007; Mizuta & Aloy 2009; Mizuta et al. 2011; Nagakura et al. 2011). After jet breakout, the jet advances in the circumstellar matter which is assumed to be very dilute.

3.2. Before the Jet Breakout

The jet is well confined by the high pressure cocoon before the jet breakout. Figure 4 shows the contours of the mass density, the pressure and the Lorentz factor of the jet just before the jet breakout for the model G5.0 ($\Gamma_0 = 5$). We should note that the r axis is elongated and the aspect ratio of z and r is not unity in order to highlight the fine structures in the jet and the cocoon. Although we inlet a jet with a velocity parallel to the cylindrical axis, the jet tries to expand with an opening angle of $\theta_0 \sim \Gamma_0^{-1}$ because the thermal energy is large. Around the injection point, the Lorentz factor rapidly increases and then drops across a discontinuity. Since the pressure and the mass density increase across this discontinuity, it is the shock surface. The shock deflects the velocity vector almost towards the jet axis, and is the so-called collimation shock. The collimation shock is produced by the interaction between the expanding jet and the high pressure cocoon (Komissarov & Falle 1997, 1998; Bromberg & Levinson 2009; Bromberg et al. 2011). To distinguish it from the other collimating oblique shocks in the jet, we sometimes call it the first collimation shock. See the schematic Figure 3.

As shown in Figure 4, after the first collimation shock, the jet maintains an overall cylindrical shape (Bromberg et al. 2011). The Lorentz factor increases to a few tens and then drops to $\sim \Gamma_0$, i.e., the initial Lorentz factor, after the first collimation shock, see Equation (20). The Lorentz factor after the first collimation shock remains constant with time on average, although the pressure in the cocoon gradually decreases with time, since the timescale for the cocoon to change is much longer than that for the jet to cross the cylindrical region. Figure 5(c) shows the one-dimensional Lorentz factor profile along the z axis.

We can understand the cylindrical evolution as follows. The propagation velocity of the jet head is comparable to the sound velocity of the shocked envelope (obviously) and is much smaller than the sound velocity of the shocked jet (with high entropy) at the jet head. The shocked jet goes backward around the jet and provides a constant cocoon pressure over the jet. Namely,

the flow in the cocoon is subsonic. Although the mean sound velocity of the cocoon, which is comparable with the transverse velocity of the bow shock, is lower than the jet head velocity, the matter is only partially mixed in the cocoon. Thus, the gas in the cocoon can communicate with each other, resulting in a homogeneous pressure profile in the cocoon. Figure 5(a) shows the pressure profile at $r = 1.8 \times 10^9$ cm as a function of z . At $t = 3$ s (before the jet breakout), we can see a relatively constant pressure profile over the cocoon. Since the jet is confined by the homogeneous pressure in the cocoon, the jet maintains a cylindrical structure after passing the first collimation shock. As shown in Figure 5(a) ($t = 4.5$ s), the homogeneous pressure decreases with time, and the cylindrical radius of the jet increases with time. The constant pressure profile in the cocoon breaks around the head of the jet.

The Lorentz factor should be constant over the cylindrical jet because of flux conservation. The Lorentz factor remains $\sim \Gamma_0$, although some fluctuations appear in the Lorentz factor due to the internal oblique shocks; see Figure 5(c). The internal oblique shocks occur in the cylindrical jet for several reasons. The first reason is that the jet converges to the axis after the first collimation shock. The jet shrinks the cylindrical radius, resulting in an oblique shock. The second reason is similar to that for the first collimation shock. The shrinking jet becomes over-pressured and bounces. This is like the initial expansion at the injection and thereby leads to the second collimation shock. Such a cycle of expansion and collimation is repeated several times. Note that the jet has a larger initial cylindrical radius in the second and later collimations than in the first one. The third reason is the fluctuation of the cocoon pressure (Mizuta et al. 2004). The cocoon is produced by the shocked jet and the shocked envelope. The shocked jet at the jet head goes sideways and also backward under the pressure of the shocked envelope (Mizuta et al. 2010). Together with the shear motion between the shocked jet and the shocked envelope, a large vortex and a turbulent structure is formed in the cocoon. The turbulence in the cocoon makes a perturbation at the contact discontinuity between the cocoon and the jet, which causes the oblique shocks in the jet. Because shocks are tilted to the jet axis, we call these shocks oblique shocks in the jet.

At the last stage of the propagation in the progenitor, we identify a jet-breakout acceleration. Since the density distribution of the envelope drops exponentially at

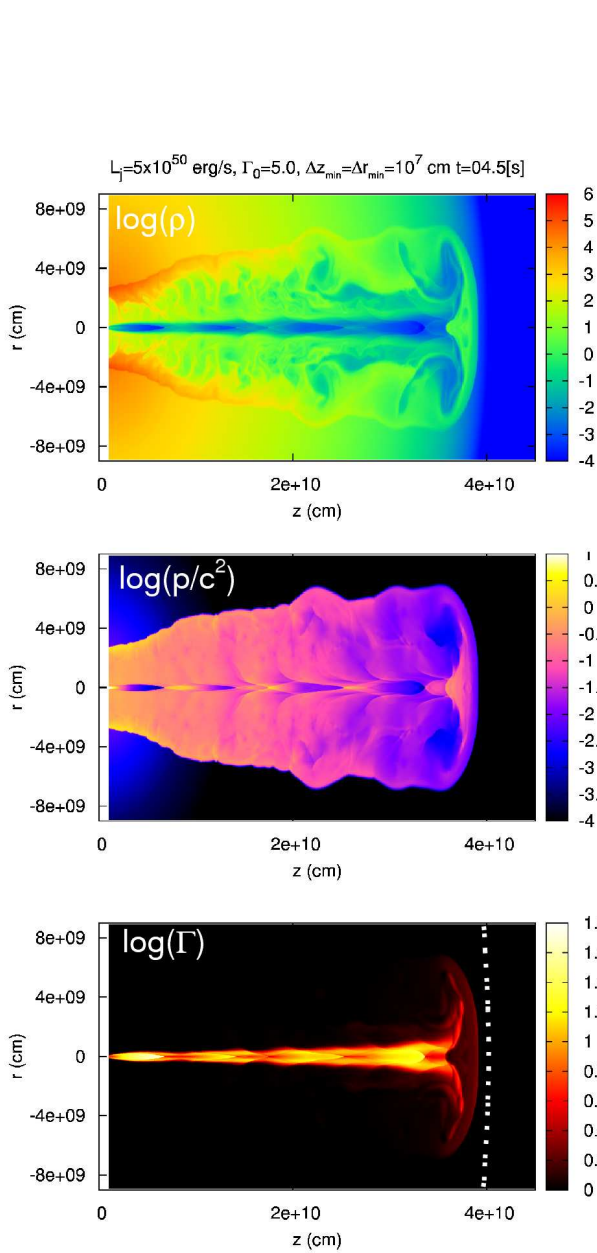

FIG. 4.— Mass density in g cm^{-3} (top), pressure in $\text{dyn cm}^{-2}/c^2$ (middle), and Lorentz factor (bottom) contours of the model $\Gamma_0 = 5$ at $t = 4.5$ s (model G5.0). Note that the aspect ratio of z and r is not unity in order to enhance the fine structures in the jet and the cocoon. The white dashed line in the Lorentz factor contour indicates the initial stellar surface.

the stellar surface R_* ($z = 4 \times 10^{10}$ cm; see Figure 2), the jet head advances rapidly ($\sim c$, the speed of light). As a result, the pressure profile in the cocoon cannot remain constant around the jet head. The pressure profile in the cocoon drops near the jet head; see the one-dimensional pressure profile in the cocoon in Figure 5(a) at $t = 4.5$ s when the jet breakout just occurs. Figure 5(b) shows the same as Figure 5(a) for but when the z -axis is shifted by z_{shift} , where z_{shift} is approximately the position at which the jet starts to expand. The jet cannot maintain its

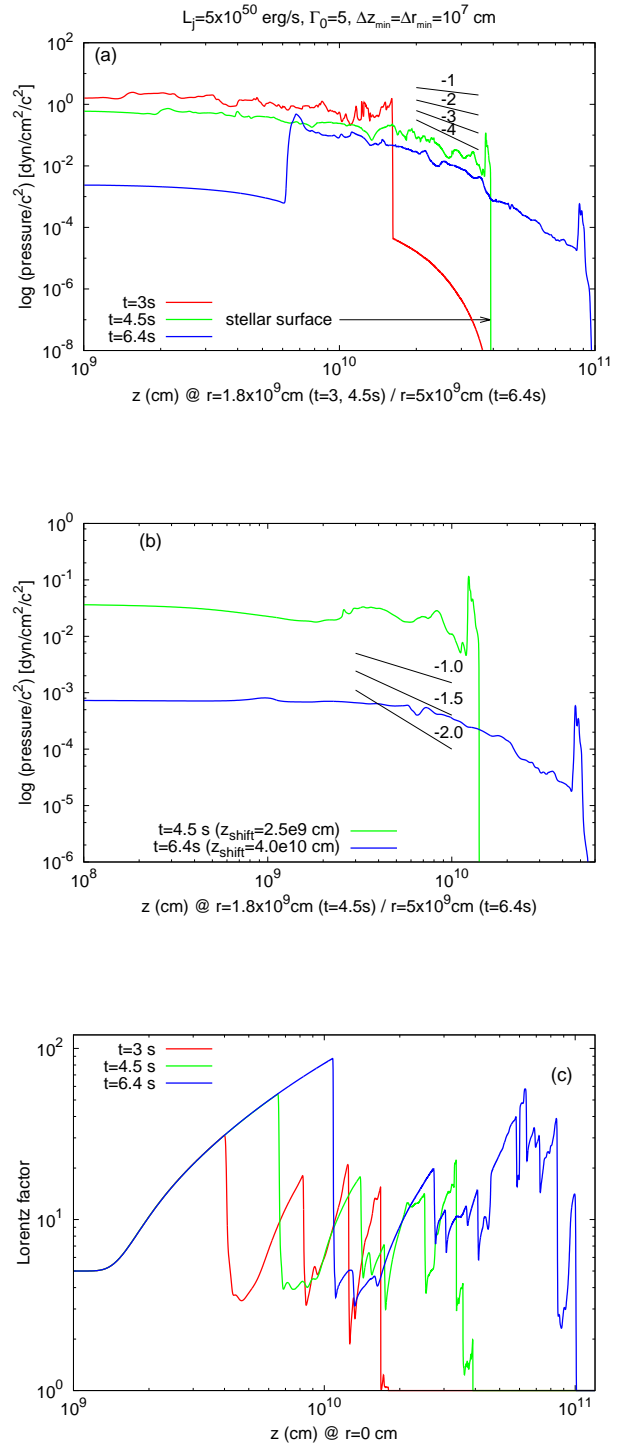

FIG. 5.— (a) One dimensional pressure profiles at $r = 1.8 \times 10^9$ cm and $t = 3, 4.5$ s, and at $r = 5 \times 10^9$ cm and $t = 6.4$ s for model G5.0. The profile shows the cocoon region. The shocked ambient gas appears as a thin shell at the jet head. The pressure profile is almost homogeneous before the jet breakout ($t = 3$ s). When the jet breakout occurs at $t = 4.5$ s, a pressure gradient can be seen around the jet head. After the jet breakout at $t \geq 6.4$ s, the pressure profile in the outer cocoon is about $p \propto z^{-4}$. (b) Same as (a) but only for $t = 4.5, 6$ s and the horizontal axis is $z - z_{\text{shift}}$ to show the pressure profiles measured from off-center origin at z_{shift} , which determines the evolution of the jet expanding from the off-center around $\sim z_{\text{shift}}$ for each time ($z_{\text{shift}} = 2.5 \times 10^9$ cm for $t = 4.5$ s and $z_{\text{shift}} = 4 \times 10^{10}$ cm for $t = 6.4$ s). A pressure gradient can be seen around the jet head at the time of the jet breakout ($t = 4.5$ s) and after the jet breakout ($t = 6.4$ s). (c) One dimensional Lorentz factor profile along the z -axis at $t = 3, 4.5$, and 6.4 s for model G5.0.

cylindrical structure near the jet head even after passing the oblique shock, since the cocoon pressure drops before the jet breakout. The jet expands in the decreasing cocoon pressure and accelerates by converting thermal energy into kinetic energy. The Lorentz factor of the jet increases to a few tens even after the oblique shock. See the Lorentz factor contour near the jet head in Figures 4 and 5(c) and the discussion in Section 4.2.

3.3. After the Jet Breakout

Soon after the forward shock reaches the stellar surface, jet breakout occurs. The jet and the cocoon (a mix of the shocked jet and the shocked stellar envelope) start to expand into the circumstellar matter which is assumed to be very dilute. The expansion velocity of the cocoon is comparable to the sound velocity before the jet breakout (\sim a few tens of percent of the speed of light). So, the cocoon stays near the stellar surface for 10 s (see Section 5.2), providing pressure for the jet confinement. As shown in Figure 5(b), for $t = 6.4$ s, the cocoon pressure is decreasing outward, ranging from $P \sim \text{const}$ to $P \propto (z - z_{\text{shift}})^{-2}$ (the off-center case).

On the other hand, the supersonic jet does not notice the cocoon profile until a collimation shock is formed. In the star, the jet is repeating a cycle of the expansion and the (over-)collimation that maintains the cylindrical structure; see Sections 3.2 and 3.4. Near the stellar surface, the jet also expands without noticing the outwardly decreasing pressure before the shock. Note that the expansion is off-center near the stellar surface, not from the stellar center. The off-center origin makes the pressure profile shallower (Figure 5(b)) than that shown in Figure 5(a) with a stellar center origin. Since the pressure profile is still shallower than $P \propto (z - z_{\text{shift}})^{-2}$, the jet is collimated but the collimation is not enough to keep the cylindrical radius fixed (see Section 3.4). This expansion leads to the jet-breakout acceleration, as shown in Section 4.2. Even after the last collimating oblique shock, a certain level of confinement continues without forming a shock (or with a weak shock), but the jet expands laterally, leading to an additional jet-breakout acceleration (see Section 4.2). Finally the jet starts to expand freely after the pressure profile gets steeper than $P \propto (z - z_{\text{shift}})^{-4}$. As time goes on, the steep pressure profile moves inward, while the first collimation shock becomes large. Then the jet starts a free expansion after crossing the first collimation shock.

Figure 6 shows the mass density, the pressure, and the Lorentz factor contours of the model G5.0 ($\Gamma_0 = 5$) at $t = 6.4$ s. There are many oblique shocks in the jet, not only inside the progenitor but also outside the progenitor. The oblique shocks outside the star are imprinted before the free expansion and expand in a self-similar way, because the internal shocks were not developed in a freely accelerating flow without confinement (Ioka et al. 2011). The jet advances with a velocity close to the speed of the light, whereas the cocoon expands with a sub-relativistic speed. As the cocoon pressure decreases, the first collimation shock expands and the converging point of the shock moves outside the progenitor star.

3.4. Opening Angle After the Jet Breakout

Since probe particles are introduced in the jet (Section 2.5), we can trace the particle path and measure the

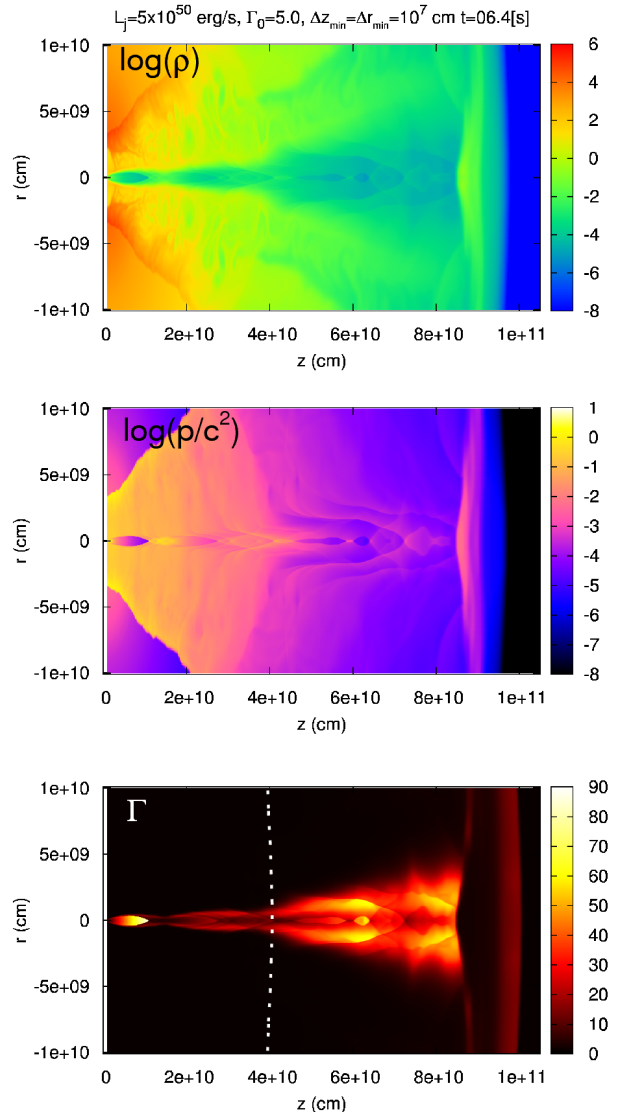

FIG. 6.— Same as Figure 4 but after the jet breakout (at $t = 6.4$ s, model G5.0).

opening angle of the jet. Figure 7 shows the traces of particles that are injected at the same time ($t = 5$ s). The path of each particle repeats the cycle of expansion and collimation inside the star and the last collimation near the stellar surface is not so strong that the cylindrical radius of the jet becomes large. Just outside the progenitor ($R \gtrsim R_* = 4 \times 10^{10}$ cm), the particles do not yet start a free expansion. At some distance which depends on the particles, the particle path finally becomes straight, i.e., the jet freely expands as discussed in the previous section. The position where the particle path becomes straight depends on when and where the particle is injected. The location of free expansion starts at

$\sim 5 \times 10^{10}$ cm for early particles which were near the head of the jet at the jet breakout. Then, the locations to start the free expansion move inward for subsequent particles.

The arrows in Figure 7 indicate the slopes of the inverse of the local Lorentz factor (Γ^{-1}) for the laterally outermost particle. The left arrow is Γ^{-1} just after the last collimating oblique shock ($z \sim 3.3 \times 10^{10}$ cm). Although the jet behind the shock has a higher Lorentz factor than that in the star, the arrow is pointing outside the jet opening angle. Thus, the jet is still confined by the cocoon and can not expand freely, drawing a concave particle path in Fig. 7. Finally, the path becomes straight from the base of the right arrow ($z \sim 5 \times 10^{10}$ cm). The direction of the arrow almost coincides with the freely expanding direction. This means that the opening angle of the jet is determined by the Lorentz factor of the flow when the free expansion starts as in Equation (1).

The extrapolations of the free expansion lines do not cross the center of the progenitor, i.e., the explosion is off-center. The explosion center moves gradually inward as time passes. The off-center position is different even for particles injected at the same time.

We note that the acceleration of the Lorentz factor by a factor of ~ 5 does not take ~ 5 stellar radii. This is because the expansion is off-center and the initial size of the fireball is much smaller than the stellar radius under the cocoon pressure. The fireball expands by a factor of $\gtrsim 5$ before the free expansion, but the size of the fireball is still comparable with the radius of the star R_* . See also the discussion in Section 4.2.

Since the particles with $h\Gamma < 100$ lose their potential to reach $\Gamma \geq 100$ by an adiabatic expansion, only particles with $h\Gamma \geq 100$ contribute to the GRB prompt emission. Baryon loading occurs for the particles that are involved in the cocoon component before the free expansion, because the turbulence in the cocoon mixes the shocked jet and the shocked stellar envelope. Baryon loading also occurs at the contact discontinuity between the jet and the cocoon even after jet breakout (mostly via numerical diffusion). A certain level of baryon loading is unavoidable through numerical diffusion and we should be careful about it, as discussed in Section 3.7. Most particles that are injected at early times exhibit $h\Gamma < 100$ at large z .

We measure the jet opening angle (θ_j) as the angle between the jet axis and the free expansion path for the laterally outermost particle. Figure 8 shows the time evolution of the jet opening angle for each model. The solid lines show the opening angles measured by the particles with $h\Gamma \geq 100$, while the dashed lines correspond to $h\Gamma < 100$ that can not produce GRBs. The time axis in Figure 8 corresponds to the time when the particles are injected. Since the jet breakout time depends on the models, we align the shock breakout time at $t = 0$ in Figure 8. Thus the time $t < 0$ indicates that the particles move into the cocoon before the shock breakout.

The opening angle of the jet is not constant at early times, as shown in Figure 8. There are particles with $h\Gamma < 100$ before and a few seconds after the shock breakout. Those particles are the components that are engulfed into the cocoon before the jet breakout. The cocoon is largely baryon-loaded because the shocked envelope mixes with the shocked jet by the shear interaction

through the contact discontinuity. Since the particles expand with the cocoon after the shock breakout, those opening angles are relatively large.

The opening angle drops after the shock breakout in Figure 8. At the same time, the baryon-poor GRB component $h\Gamma \geq 100$ appears. We note that our results are not sensitive to the threshold value of $h\Gamma \geq 100$ because the baryon-loaded flow and the baryon-poor flow are well separated, irrespective of the uncertainty in the numerical baryon loading (see also Section 3.5). The opening angle settles down to a nearly constant value a few seconds after the shock breakout. Small time variations of the opening angle are caused by the fluctuations of the local Lorentz factor just before the free expansion, according to Equation (1). The local Lorentz factor depends on where and how the particle crosses the collimation shock. Since the size of the first collimation shock grows to a size comparable with the stellar radius, the later particles only pass the first collimation shock before the free expansion.

Most importantly, the opening angles in Figure 8 are much smaller than Γ_0^{-1} , contrary to our naive expectations ($1/\Gamma_0 \sim 0.2$ rad for $\Gamma_0 = 5$ and $1/\Gamma_0 \sim 0.1$ rad for $\Gamma_0 = 10$). Figure 9 shows the $\theta_j - \Gamma_0^{-1}$ plot for the models. We plot the opening angles at different times (from $t = 3$ s to 7 s) since they fluctuate, as shown in Figure 8. The opening angles of the jet are not on the line $\theta_j \sim \Gamma_0^{-1}$ but on the line $\theta_j \sim (5\Gamma_0)^{-1}$. This is our main result; the opening angle of the GRB jet from collapsars for the first 10 seconds (see Section 5.2) is roughly given by

$$\theta_j \simeq \frac{1}{5\Gamma_0}. \quad (3)$$

If the activity of the engine continues, the opening angle of the jet will increase as shown by Morsony et al. (2007).

3.5. Angular Profile of the Jet After the Jet Breakout

Figure 10 shows the angular distribution of isotropic luminosity (L_{iso}) using the hydrodynamic quantities of the fluid calculations without any constrain on $h\Gamma$, at $R_a = 1.5 \times 10^{11}$ cm at the time when the forward shock reaches $z_{\text{FS}} = 3 \times 10^{11}$ cm, for models G2.5 ($t = 14.8$ s), G5.0 ($t = 12.5$), and G10 ($t = 11.9$ s). The angle is in spherical coordinates with the origin at the center of the progenitor. The angular distribution of the isotropic luminosity profile shown in Figure 10 roughly corresponds to the particles at $t = (z_{\text{FS}} - R_a)/c = 5$ s after the shock breakout in Figure 8. The arrows indicate the opening angle of the jet measured in Figure 8 for each model. Each arrow roughly coincides with the rim at which the isotropic luminosity starts to drop exponentially. Our results are not sensitive to the threshold value of $h\Gamma \geq 100$, irrespective of the uncertainty in the numerical baryon loading.

Figure 10 shows a hollow-cone jet structure. The angular distribution of the isotropic luminosity is high at the rim and drops exponentially at the edge. Then it gradually decreases at large angles. The high isotropic luminosity rim part is produced by the shock between the expanding jet and the high density cocoon before the free expansion. The other oblique shocks produced in the star are also imprinted on the jet structure even after the jet breakout; see Figure 6 and 8.

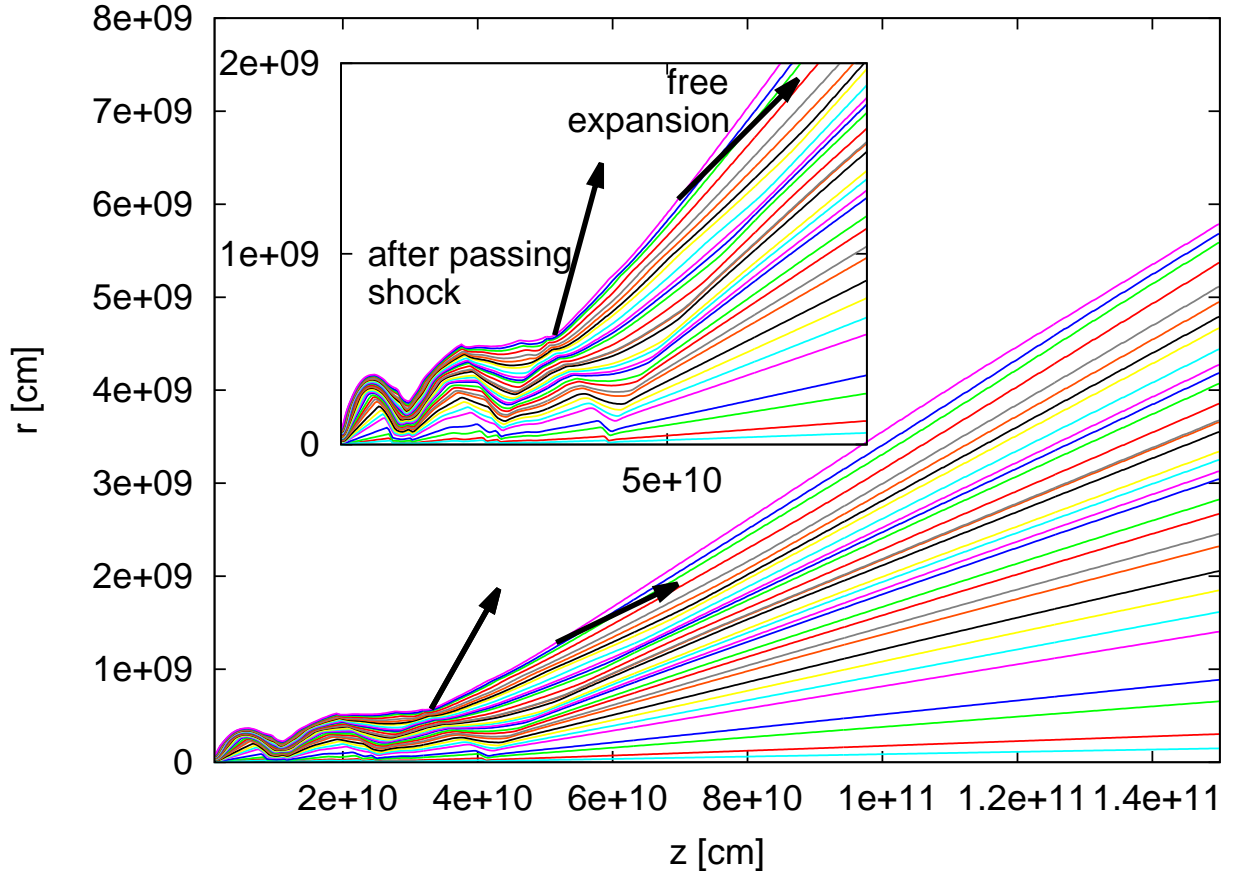

FIG. 7.— Particle trajectories injected with the jet at the same time ($t = 5$ s, model G5.0). The arrows indicate the slope of the inverse of the local Lorentz factor (Γ^{-1}) at the time when the particles have passed the final collimating oblique shock before the free expansion (left arrow) and at the time when the free expansion starts (right arrow) for the laterally outermost particle. The free expansion direction almost coincides with the slope of the inverse of the local Lorentz factor (Γ^{-1}) when the free expansion starts. The inset displays a zoom in of the range 1×10^9 cm $\leq z \leq 8 \times 10^{10}$ cm. Note that the aspect ratio of z and r is not unity.

Angular distributions of the jet are also shown by Zhang et al. (2004) Morsony et al. (2007), and Mizuta & Aloy (2009). Since these authors take the radial integration of the energy density or the time integration of the energy flux at a certain radius, as opposed to a snapshot of the isotropic luminosity, we can not simply compare their results with ours. In fact, there are some differences, but it is difficult to identify the reasons for these diffusions (numerical diffusion, the initial jet size etc.).

3.6. The $\Gamma_0 = 2.5$ Case

The behavior of the jet for the case $\Gamma_0 = 2.5$ is somewhat different from other cases ($\Gamma_0 = 5$ and 10). The jet opening angle at the injection point for the model $\Gamma_0 = 2.5$ is larger than those for other models, since the initial opening angle is $\sim \Gamma_0^{-1}$. The cylindrical radius of the jet becomes larger than those of other models (see the analytic study of the jet dynamics in the progenitor in Section 4.1). As the cylindrical radius of the jet in-

creases before the jet breakout, the momentum flux per area pushing the stellar envelopes decreases, resulting in a strong reverse shock. As a result, the forward shock and the reverse shock go away from each other, as shown in Figure 11. The reverse shock is far from the progenitor surface at $z \sim 2.4 \times 10^{10}$ cm at the time when the forward shock reaches the stellar surface, $z \sim 4 \times 10^{10}$ cm. Since the cylindrical radius of the jet is very large, a large fraction of the shocked jet and the shocked envelope can not go sideways and remains in the jet head. The mass is collected at the jet head like a snowplow or a plug (Zhang et al. 2004; Mizuta et al. 2006). Even after the shock breakout, the plug remains on the axis and affects the jet advance for a while. As the plug moves away from the star, the jet can go around the plug more easily and the effect of the plug decreases. A similar structure would also appear for low-luminosity jets with $L_j < 5 \times 10^{50}$ erg s $^{-1}$ (e.g., Toma et al. 2007), while the plug would be reduced for a non-axisymmetric case (Zhang et al. 2004). We will study the luminosity dependence in the near future.

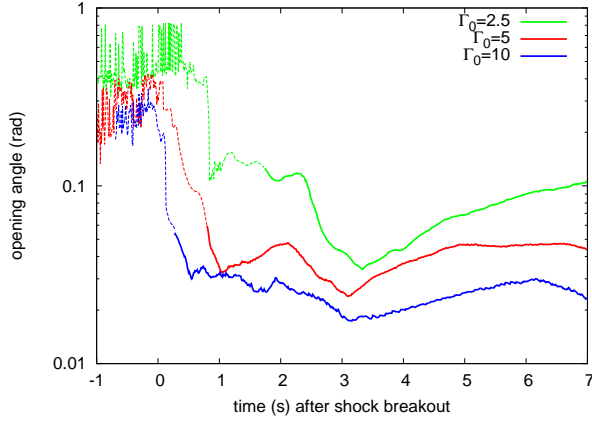

FIG. 8.— Opening angles as a function of time before and after the shock breakout for the resolution $\Delta z_{\min} = \Delta r_{\min} = 10^7$ cm cases (models G2.5, G5.0, and G10). The opening angles are measured by using probe particles (see Section 3.4). The components that satisfy $h\Gamma \geq 100$ are indicated by the solid lines. Those are components to be accelerated to $\Gamma \geq 100$ by the adiabatic expansion and can contribute to the prompt emission. The components with $h\Gamma < 100$ via the baryon loading from the shocked stellar envelopes are shown by the dashed lines.

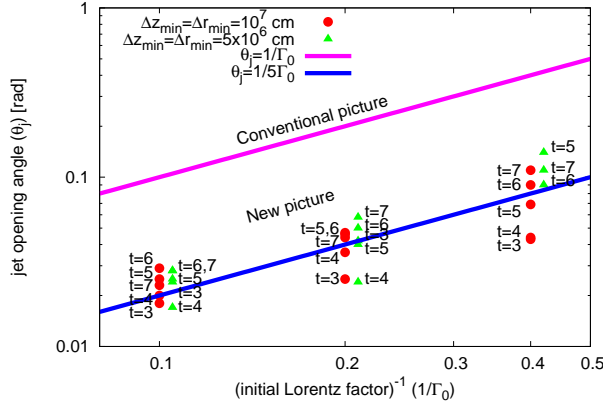

FIG. 9.— Opening angle (θ_j) vs. the inverse of the initial Lorentz factor (Γ_0^{-1}). The opening angles at $t = 3, 4, 5, 6,$ and 7 s are shown for models G2.5, G5.0, and G10 with the resolution $\Delta z_{\min} = \Delta r_{\min} = 10^7$ cm (red circles). The opening angles are also shown at $t = 3, 4, 5, 6,$ and 7 s for models G5.0H and G10H and at $t = 5, 6,$ and 7 s for model G2.5H with the resolution $\Delta z_{\min} = \Delta r_{\min} = 5 \times 10^6$ cm (green triangles; the green triangles are slightly shifted to the right). We also plot lines of $\theta_j = \Gamma_0^{-1}$ (the conventional picture based on the naive expectation) and $\theta_j = (5\Gamma_0)^{-1}$ (our new picture obtained by numerical simulations).

The plug affects the time evolution of the opening angle after the jet breakout. The opening angle in the case of $\Gamma_0 = 2.5$ does not drop quickly, compared with the other models. It takes a few seconds to start to drop and produces a much smaller angle than Γ_0^{-1} . As shown in Figure 11, there is a baryon-rich plug ahead of the jet when the jet breakout occurs. The jet is scattered by the plug for a few seconds after the jet breakout. As a result the opening angle of the jet is large for a while. The

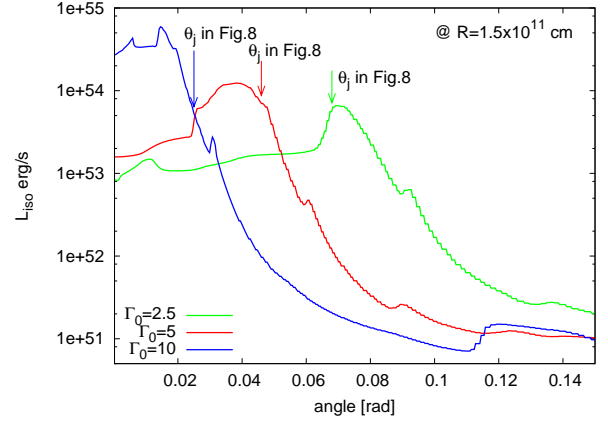

FIG. 10.— Angular energy density distribution after the jet breakout at a spherical radius ($R = 1.5 \times 10^{11}$ cm) for models G2.5 at $t = 14.8$ s (green), G5.0 at $t = 12.5$ (red), and G10 at $t = 11.9$ s (blue). The time is when the forward shock reaches $z = 3 \times 10^{11}$ cm. The energy density distribution of the jet shows a hollow-cone structure. The jet opening angles at $t = 5$ s in Figure 8 are indicated by the arrows for each model, and coincides with the position at which the energy density starts to drop exponentially.

following jet, which moves far away from the progenitor and hence does not interact with the plug, has a small opening angle, as seen in our other models.

3.7. Resolution Study

We completed hydrodynamic simulations with higher resolution as discussed in Section 2.2. The initial jet contains a small amount of baryons, while the stellar envelope contains abundant baryons, i.e., $h\Gamma \sim 1$. As the jet proceeds in the stellar envelope, a contact discontinuity is formed between the shocked jet and the shocked stellar envelope. Our numerical calculations use fixed grid points. Artificial baryon loading could happen when the discontinuity crosses the grids via numerical diffusion. Once the gas is polluted by baryons ($h\Gamma \sim 1$), it is not accelerated to a large Lorentz factor by the adiabatic expansion. Figure 12 shows the one-dimensional profile of $h\Gamma$ along the jet axis for $\Gamma_0 = 5$ at $t = 6.4$ s when the forward shock reaches $z \sim 10^{11}$ cm with both resolution cases, i.e., $\Delta z_{\min} = \Delta r_{\min} = 10^7$ cm and $\Delta z_{\min} = \Delta r_{\min} = 5 \times 10^6$ cm. In both cases, Bernoulli's constant $h\Gamma$ is conserved all the way to the jet head except for some fluctuations at the internal shocks. If we use poor resolution, Bernoulli's constant $h\Gamma$ is not well conserved. For example, the case of Mizuta et al. (2011) is also shown. $h\Gamma$ is conserved up to a half of the jet but not near the jet head due to the numerical baryon loading. Mizuta et al. (2011) adopted similar jet parameters but a spherical coordinate for hydrodynamic simulations with $\Delta\theta = 0.25$ around the jet axis. This is one of the reasons for using much higher resolution grid points for detailed quantitative discussions on the opening angle of the jet.

Figure 9 shows the opening angles for different resolutions. The results are similar between different resolutions. Therefore the relation $\theta_j \sim (5\Gamma_0)^{-1}$ in Equation (3) seems robust.

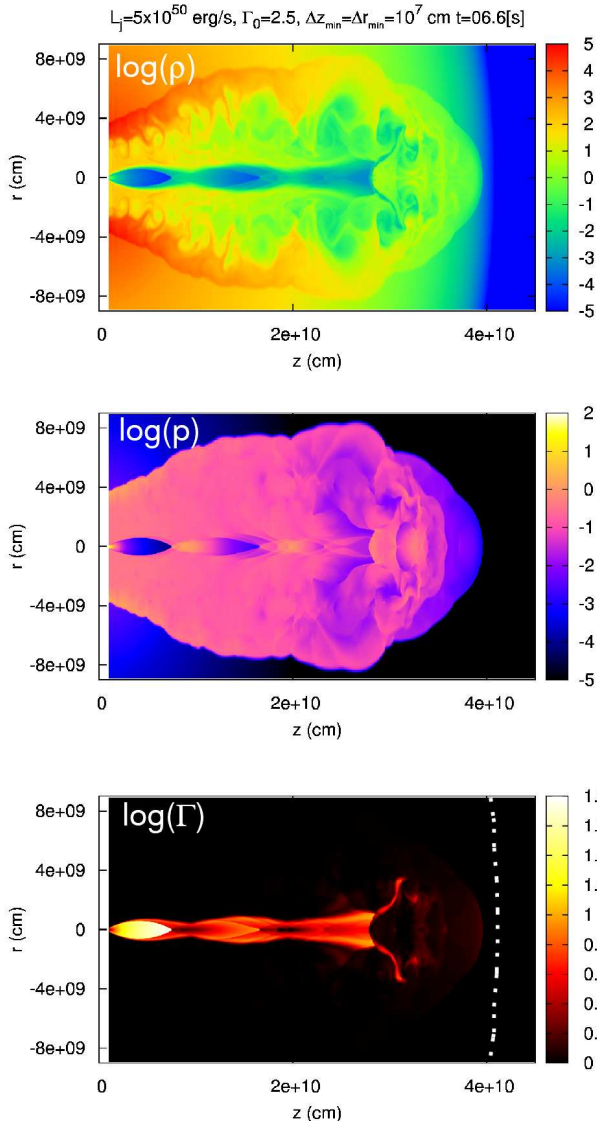

FIG. 11.— Same as Figure 4 but $\Gamma_0 = 2.5$ (model G2.5), just before the shock breakout ($t = 6.6$ s).

Although the differences are small between the models G2.5 and G2.5H ($\Gamma_0 = 2.5$), they depend on the resolution more sensitively than the other models. Figure 13 shows the mass density, the pressure, and the Lorentz factor contours of the model $\Gamma_0 = 2.5$ with the high resolution at $t = 7.5$ s when the shock breakout occurs. The shock breakout times (6.6 s and 7.5 s) are different by ~ 1 s even if the jet parameters are the same in Figure 11 and 13. The high resolution case takes about 1.2 times longer than the lower resolution case. One should note that the recollimation shocks are different. The low resolution one converges on the axis while the high resolution one makes a Mach disk. The difference is probably caused by the

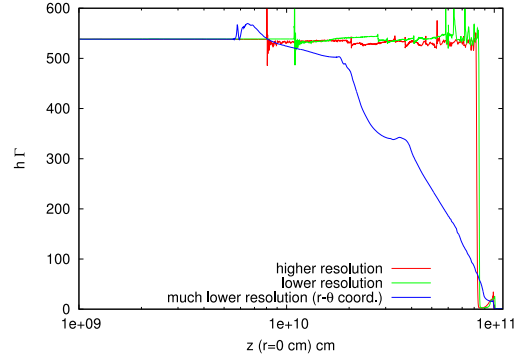

FIG. 12.— One dimensional profile of Bernoulli's constant $h\Gamma$ along the jet axis for $\Gamma_0 = 5$ at $t = 6.4$ s when the forward shock reaches $z \sim 10^{11}$ cm. Both resolution cases, i.e., $\Delta z_{\min} = \Delta r_{\min} = 10^7$ cm (model G5.0) and $\Delta z_{\min} = \Delta r_{\min} = 5 \times 10^6$ cm (model G5.0H) are shown. $h\Gamma$ is conserved up to the jet head except for some fluctuations in the internal shocks. On the other hand, $h\Gamma$ drops near the jet head for a simulation with similar jet parameters but low-resolution spherical coordinates, $\Delta\theta = 0.^{\circ}25$, (Mizuta et al. 2011) due to baryon loading via the interaction with the stellar envelope.

nonlinear evolution of the jet and the cocoon dynamics. A small difference in the oblique shocks near the head of the jet changes the cross-sectional radius of the reverse shock and hence the jet head speed. This produces the difference in the appearance of the vortices and the turbulence in the cocoon (Mizuta et al. 2010; Morsony et al. 2010). The turbulence itself is also a non-linear process. The numerical diffusion of the baryon loading would also alter the dynamics. The size of the head plug is also larger for the high resolution case than that for the low resolution case, when the jet breakout occurs.

3.8. Initial Jet Size

At the injection point $z_{\min} = 10^9$ cm, we set the initial cylindrical radius of the jet to be $r_0 = 8 \times 10^7$ cm. The initial cylindrical radius should be smaller than the value in Equation (26), the cylindrical radius of the jet after the collimation shock. Otherwise, the jet evolution is different. The jet does not show an initial expansion but maintains its the incorrect cylindrical radius. This gives wrong dynamics for the breakout time, the cocoon energetics, and the opening angle. That is why we start the numerical simulation with so small an initial cylindrical radius. At least several or 10 grid points are necessary for covering the initial cylindrical radius because we have to resolve the internal shocks. This sets the scale for the fine grid points as used in this study. Our simulations use one of the finest resolutions so far.

3.9. Comparison with Previous Studies

We have run one of the highest resolution hydrodynamic simulations of jet propagation. High resolution reduces the numerical baryon loading which affects the jet dynamics. Since the numerical baryon loading is the most dangerous at the boundary with a high contrast of the enthalpy h , the highest resolution grid points appear around the region that covers the jet and some part of the cocoon. The highest resolution grid size is comparable to or better than that used in Morsony et al. (2007),

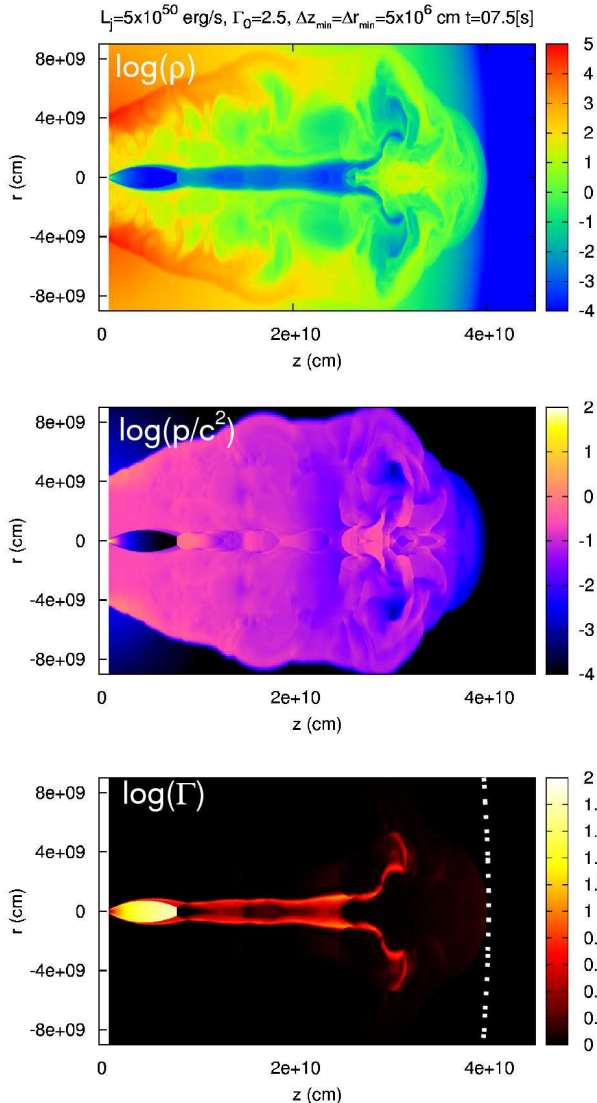

FIG. 13.— Same as Figure 4 but $\Gamma_0 = 2.5$ with high resolution (model G2.5H), just before the shock breakout ($t = 7.5$ s).

and Lazzati et al. (2013). The highest resolution region is much larger than that used in Morsony et al. (2007).

Since we have run quite high resolution calculations for hydrodynamic simulations of the jet dynamics, the computational domain is restricted to about 10 times larger than the progenitor size. This is smaller than that used in Mizuta et al. (2011); Nagakura et al. (2011), and Suzuki & Shigeyama (2013). Our discussion is restricted to only several seconds after the jet breakout. The computational box size is comparable with that used in Morsony et al. (2007) who discussed the time evolution of the opening angle of the jet. The requirement that the initial cylindrical radius of the jet should be sufficiently

small is also one of the reasons for using high-resolution grid points (see Section 3.8). We have paid special care by applying a sufficiently small cylindrical radius of the initial jet. The dynamics of our results may be different from those of Morsony et al. (2007), who took the initial radius to $\sim 1.76 \times 10^8$ cm for the $\theta_0 = 10^\circ$ case. This is about 2.2 times larger than our initial cylindrical radius of the jet ($r_0 = 8 \times 10^7$ cm).

Our numerical results show that the opening angle of the jet after jet breakout is narrower than what we expect ($\theta_j \sim 1/\Gamma_0$). This trend is consistent with previous numerical simulations, for example, Morsony et al. (2007), Lazzati et al. (2009), Mizuta et al. (2011), and Lazzati et al. (2013) who pointed out that the opening angle after the jet breakout is smaller than the initial opening angle (θ_0). In this paper we introduce much more sophisticated analysis with probe particles that allows us to follow the Lagrangian motion of each element. We determine the correlation between the initial Lorentz factor and the opening angle of the jet, i.e., $\theta_j \sim 1/5\Gamma_0$. We also find where and how the gas starts free expansion. The position where expansion starts is off-center and also different for each particle around $\sim 4 \times 10^{10}$ cm. We identify that the jet breakout acceleration occurs and that the local Lorentz factor of the flow just before the free expansion determines the opening angle of the jet. Since we measure the opening angle based on the free expansion direction with respect to the jet axis, the angle is different from that measured by Morsony et al. (2007), who defined the jet opening angle by measuring how the GRB jet component ($\Gamma_{\text{inf}} \equiv h\Gamma \geq \Gamma_{\text{cr}}$) spreads out at $R = 1.2 \times 10^{11}$ cm in spherical coordinates (the progenitor center is the origin of the coordinate). The different measurement methods result in about a 30 % difference in the opening angle of the jet.

4. ANALYTIC MODELS

Let us consider analytical models of the jet propagation and the dynamics of the opening angle. The evolution is generally divided into two phases, i.e., before and after the jet breakout.

In Section 4.1, we discuss the pre-breakout phase. Bromberg et al. (2011) investigated the pre-breakout evolution in detail. Before the breakout, the jet is inside the progenitor star and collimated by the cocoon pressure. Since the cocoon pressure is constant (subsonic inside), the jet becomes cylindrical through the first collimation shock. The cylindrical (and stationary) flow has a constant Lorentz factor because of flux conservation. If the Lorentz factor were constant even at the jet breakout, the opening angle of the jet would be the inverse of the initial Lorentz factor (or the initial opening angle; see below), as shown in Figure 1, but this is not the case as shown in Section 4.2.

We present analytical formulae of the jet propagation for easy comparison with our numerical simulations. We also calibrate the model parameters, taking great care with the baryon contamination and the initial jet size. We compare the evolution of three physical quantities, the jet head position, the jet cylindrical radius, and the collimation position, with numerical calculations. The model has one free parameter η in Equation (8), which is obtained by fitting the numerical results.

In Section 4.2, we model the post-breakout phase. Af-

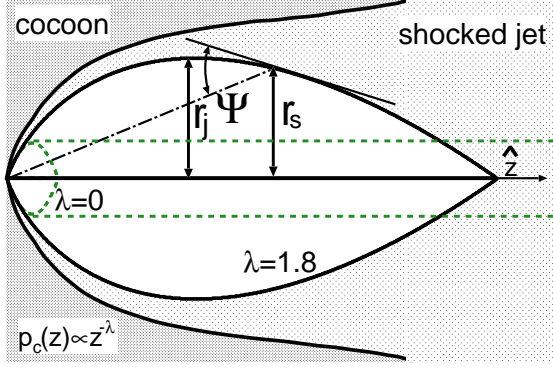

FIG. 14.— Structure of the jet and the collimation shock. The collimation shock appears by the interaction between the expanding jet and the high pressure cocoon. The collimation shock converges at \hat{z} . Solid lines show the collimation shock and the jet structure after the collimation shock for a decreasing pressure case ($\lambda = 1.8$), whereas green dashed lines show the collimation shock and the cylindrical jet structure after the collimation shock for the constant pressure case ($\lambda = 0$).

ter the breakout, the cocoon pressure is not constant but decreases outward (see Figure 5). This leads to less collimation, a wider jet, and hence a larger Lorentz factor. Therefore, the jet-breakout acceleration occurs almost inevitably if the external medium has a finite size. We estimate that the jet-breakout acceleration boosts the Lorentz factor of the jet by a factor of several (~ 5). This is the reason why the naive picture in Figure 1 is not correct but the jet opening angle becomes $\sim 1/5\Gamma$, as shown numerically in Section 3.4 and Figure 8.

4.1. Jet Evolution in Constant External Pressure

First we consider the jet evolution inside the progenitor star. Bromberg et al. (2011) provided a detail analysis. Here we make the analytical formulae easier to use in the calibration of the model parameters. The jet dynamics is controlled by three processes: (1) the jet head, (2) the cocoon, and (3) the collimation. After combining these dynamics, we can describe the evolution of the jet head position by Equation (25), the jet cylindrical radius by Equation (26), and the collimation position by Equation (27). There is one free parameter η by Equation (8) to be fixed by numerical simulations.

1. *Jet head dynamics.* After the jet propagates inside the star, it collides with the stellar envelope. A reverse shock decelerates the jet, and a forward shock runs into the stellar envelope. The shocked region is called the jet head. The jet head dynamics is determined by the ram pressure balance between the shocked jet and the shocked envelope, both of which are given by the pre-shock quantities through the shock jump conditions (Marti et al. 1997; Mészáros & Waxman 2001; Matzner 2003):

$$h_j \rho_j c^2 \Gamma_{jh}^2 \beta_{jh}^2 + P_j = h_a \rho_a c^2 \Gamma_h^2 \beta_h^2 + P_a, \quad (4)$$

where $\Gamma_{jh} = \Gamma_j \Gamma_h (1 - \beta_j \beta_h)$ is the relative Lorentz factor between the jet and the jet head and $\beta_{jh} = (\beta_j - \beta_h)/(1 - \beta_j \beta_h)$ is the corresponding relative velocity. We can neglect the internal pressure of the jet P_j for the strong reverse shock and the pressure P_a for the cold ambient matter. Then, the jet head

velocity is

$$\beta_h = \frac{\beta_j}{1 + \tilde{L}^{-1/2}}, \quad (5)$$

where

$$\tilde{L} \equiv \frac{h_j \rho_j \Gamma_j^2}{h_a \rho_a} \simeq \frac{L_j}{\Sigma_j \rho_a c^3} \quad (6)$$

is the ratio of the energy density between the jet and the ambient medium. In the last equality, we assume the cold ambient medium $h_a = 1$ and use the jet cross-section $\Sigma_j = \pi r_j^2$ and the jet luminosity L_j . For typical parameters of GRBs, we have $\tilde{L} \ll 1$, i.e., a non-relativistic head velocity:

$$\beta_h \simeq \tilde{L}^{1/2}. \quad (7)$$

Hereafter, we consider the non-relativistic case, that is appropriate for typical parameters.

2. *Cocoon.* The shocked jet and the shocked envelope try to expand and go sideways into a cocoon component. The cocoon pressure is determined by the injected energy divided by the cocoon volume (Begelman & Cioffi 1989),

$$P_c = \frac{E}{3V_c} = \frac{\eta}{3} \frac{\int L_j (1 - \beta_h) dt}{(\int \beta_h c dt) \pi (\int \beta_c c dt)^2}, \quad (8)$$

where η is a parameter to correct the approximation of the cylindrical cocoon shape. We use η to absorb other approximations. (For example, we represent the transverse velocity by a single value, assume a spherical cocoon and a power-law density profile in Equation (13), neglect z_* in Equation (17), and so on.) We determine η by comparing the analytical formulae with the numerical simulations. Note that $1 - \beta_h \approx 1$ for the non-relativistic head velocity. The transverse velocity of the cocoon is determined by the balance between the cocoon pressure and the ram pressure of the ambient medium:

$$\beta_c = \sqrt{\frac{P_c}{\bar{\rho}_a c^2}}, \quad (9)$$

where

$$\bar{\rho}_a(z_h) = \frac{\int \rho_a dV}{V_c} \equiv \xi_a \rho_a(z_h), \quad (10)$$

is the mean density of the medium. Defining

$$\int \beta_h dt \equiv \xi_h \beta_h t \left(= \frac{z_h}{c} \right), \quad \int \beta_c dt \equiv \xi_c \beta_c t, \quad (11)$$

we can eliminate β_c from Equations (8) and (9) to obtain

$$P_c = \tilde{L}^{-1/4} \left(\frac{L_j \rho_a}{c t^2} \right)^{1/2} \left(\frac{\eta \xi_a}{3 \pi \xi_h \xi_c^2} \right)^{1/2}. \quad (12)$$

If the density profile follows a power law $\rho_a \propto z^{-\alpha}$, the coefficients, ξ_a , ξ_h and ξ_c , become constant:

$$\xi_a = \frac{3}{3 - \alpha}, \quad \xi_h = \xi_c = \frac{5 - \alpha}{3}. \quad (13)$$

Here we obtain ξ_a in Equation (10) assuming a spherical cocoon with a radius z_h for simplicity. Although this is not a good approximation, we adjust η in Equation (8) to fit the analytic models with numerical results. For ξ_h and ξ_c , we use Eqs. (22), (9) and (23), which yield $\beta_h \propto t^{-2/5}(\beta_h t)^{\alpha/5} \propto t^{\frac{\alpha-2}{5-\alpha}}$ and $\beta_c \propto t^{-2/5}(\beta_h t)^{\alpha/5} \propto t^{\frac{\alpha-2}{5-\alpha}}$.

3. *Collimation shock.* If the ambient density is sufficiently high like in the stellar envelope, the cocoon pressure becomes high enough to collimate the jet. The initially expanding jet hits the first collimation shock and its trajectory converges (Bromberg et al. 2011). For a constant cocoon pressure, the conical jet becomes cylindrical after the collimation. This process determines the cross-section of the jet and thereby the jet Lorentz factor after the shock.

The geometry of the collimation shock is determined by the pressure balance between the jet and the cocoon (Komissarov & Falle 1997; Bromberg et al. 2011),

$$h_0 \rho_0 c^2 \Gamma_0^2 \beta_0^2 \sin^2 \Psi + P_0 = P_c, \quad (14)$$

where the first term is the ram pressure of the jet normal to the shock surface (see Figure 14) and the subscript 0 stands for the unshocked jet. Since the jet internal pressure decreases as $P_0 \propto z^{-4}$ when the size grows, we neglect the term P_0 . For a small incident angle, we have a relation

$$\sin \Psi = \frac{r_s}{z} - \frac{dr_s}{dz} = z \frac{d}{dz} \left(\frac{r_s}{z} \right), \quad (15)$$

to the first order (see Figure 14), where r_s is the cylindrical radius of the shock position. Then, Equation (14) gives a first-order ordinary differential equation. Assuming that $\beta_0 \approx 1$ and $L_j \simeq h_0 \rho_0 c^3 \Gamma_0^2 (\pi z^2 \theta_0^2)$, we can integrate the geometry of the collimation shock as

$$r_s = \theta_0 z (1 + Az_*) - \theta_0 A z^2, \quad (16)$$

where A is given by Equation (17). We note that we assume a constant external pressure $P_c = \text{const.}$ For a decreasing external pressure, the shock geometry is different as shown in Section 4.2.

According to Equation (16), the collimation shock expands to a maximum size at $\frac{dr_s}{dz}|_{z=z_{\max}} = 0$, and converges to $r_s(z = \hat{z}) = 0$ where the maximally-expanding position z_{\max} and the converging position \hat{z} are given by

$$\hat{z} = 2z_{\max} = A^{-1} + z_* \simeq A^{-1} = \sqrt{\frac{L_j \beta_0}{\pi c P_c}}. \quad (17)$$

In the second to last equality we assume that the collimation shock is initially small, $z_* \ll A^{-1}$. As we can see from Figure 14, the maximum size of the collimation shock determines the cross-section of the jet after the collimation shock,

$$\Sigma_j(z > \hat{z}) \simeq \pi (\theta_0 z_{\max})^2 \simeq \frac{L_j \theta_0^2}{4c P_c}. \quad (18)$$

Combining with a general relation for a hot jet (the radiation-dominated jet),

$$L_j \simeq 4P_c \Gamma_1^2 \Sigma_j c, \quad (19)$$

we obtain the Lorentz factor of the jet after the first collimation shock (Bromberg et al. 2011),

$$\Gamma_1 \simeq \frac{1}{\theta_0}. \quad (20)$$

After the collimation shock, the jet is usually over-deflected to the axis, resulting in an oblique shock inside the jet. A high pressure region appears after the converging point of the first collimation shock and then expands again. The jet repeats a cycle of bounce, expansion, and collimation, like a spring under the pressure of the cocoon. Because the supersonic jet is not synchronized with the cocoon, oblique shocks arise in the jet. In each collimation, the jet tries to expand with the same angle $\sim 1/\Gamma_0$ and hence the Lorentz factor after a collimating oblique shock maintains its the same value. The Lorentz factor after the N -th collimating oblique shock is

$$\Gamma_N \simeq \Gamma_{(N-1)} \simeq \dots \simeq \Gamma_1 \simeq \frac{1}{\theta_0} \simeq \Gamma_0, \quad (21)$$

under constant pressure inside a star. The last equality is satisfied in our simulation because we inject a jet parallel to the z -axis and the jet tries to expand with an angle $\theta_0 \sim 1/\Gamma_0$, about the inverse of the initial Lorentz factor.

If the Lorentz factor were constant ($\Gamma \sim \Gamma_0$) even at the jet breakout, the opening angle of the jet would be the inverse of the Lorentz factor inside a star (or the initial opening angle) $\theta_j \sim \Gamma_0^{-1} \sim \theta_0$. However this is not the case as discussed in Section 4.2.

For comparison with the numerical results, we express physical quantities by basic parameters, i.e., the jet luminosity L_j , the ambient density ρ_a , the initial opening angle θ_0 , and time t . First, we rewrite the head velocity and the cocoon pressure as

$$\beta_h \simeq \tilde{L}^{1/2} \simeq \left(\frac{L_j}{c^5 t^2 \rho_a \theta_0^4} \right)^{1/5} \left(\frac{16 \eta \xi_a}{3\pi \xi_h \xi_c^2} \right)^{1/5}, \quad (22)$$

$$P_c = \left(\frac{\rho_a^3 L_j^2 \theta_0^2}{t^4} \right)^{1/5} \left(\frac{1}{6\pi} \frac{\eta \xi_a}{\xi_h \xi_c^2} \right)^{2/5}, \quad (23)$$

respectively, with Equations (6), (7), (12) and (18). Then we can derive analytic formulae for the jet head position with Equations. (11) and (22), the jet cylindrical radius with Equations. (18) and (12), and the converging point of the collimation shock with Equations. (17) and (12) as

$$z_h = \xi_h \beta_h c t \simeq \left(\frac{t^3 L_j}{\rho_a \theta_0^4} \right)^{1/5} \left(\frac{16 \eta \xi_a \xi_h^4}{3\pi \xi_c^2} \right)^{1/5} \quad (24)$$

$$\simeq 1.4 \times 10^{10} \text{ cm} \left(\frac{t}{1 \text{ s}} \right)^{3/5} \left(\frac{L_j}{10^{51} \text{ erg s}^{-1}} \right)^{1/5} \\ \times \left(\frac{\rho_a}{10^3 \text{ g cm}^{-3}} \right)^{-1/5} \left(\frac{\theta_0}{0.1} \right)^{-4/5}, \quad (25)$$

$$r_j \equiv \left(\frac{\Sigma_j}{\pi} \right)^{1/2} \simeq \left(\frac{t^4 L_j^3 \theta_0^8}{c^5 \rho_a^3} \right)^{1/10} \left(\frac{3}{16\pi^{3/2}} \frac{\xi_h \xi_c^2}{\eta \xi_a} \right)^{1/5} \\ \simeq 2.4 \times 10^8 \text{ cm} \left(\frac{t}{1 \text{ s}} \right)^{2/5} \left(\frac{L_j}{10^{51} \text{ erg s}^{-1}} \right)^{3/10}$$

$$\times \left(\frac{\rho_a}{10^3 \text{ g cm}^{-3}} \right)^{-3/10} \left(\frac{\theta_0}{0.1} \right)^{4/5}, \quad (26)$$

$$\hat{z} \simeq \left(\frac{t^4 L_j^3}{c^5 \rho_a^3 \theta_0^2} \right)^{1/10} \left(\frac{6}{\pi^{3/2}} \frac{\xi_h \xi_c^2}{\eta \xi_a} \right)^{1/5} \\ \simeq 4.7 \times 10^9 \text{ cm} \left(\frac{t}{1 \text{ s}} \right)^{2/5} \left(\frac{L_j}{10^{51} \text{ erg s}^{-1}} \right)^{3/10} \\ \times \left(\frac{\rho_a}{10^3 \text{ g cm}^{-3}} \right)^{-3/10} \left(\frac{\theta_0}{0.1} \right)^{-1/5}, \quad (27)$$

respectively, where we set $\alpha = 2$ [$\xi_a = 3$, $\xi_h = \xi_c = 1$ in Equations (13)] and $\eta = 0.01$ for the numerical values. For a general density profile rather than a power-law form, we solve the first line of Equation (24) for the head position z_h , where the quantities ρ_a , ξ_a , ξ_h and ξ_c in the right-hand side are also functions of z_h . Here, for simplicity, we set ξ_a , ξ_h and ξ_c with Equation (13) using the density slope $\alpha = -d \ln \rho_a / d \ln z$ at $z = z_h$.

As shown in Section 3, we can fit three analytic formulae in Equations (25)–(27) with the numerical calculations by adjusting one parameter, $\eta \sim 0.01$, in Equation (8). Figure 15 shows the comparison with analytic formulae and the results of the hydrodynamic simulations, i.e., the head position, the converging position, and the jet radius, for the model G5.0 ($\Gamma_0 = 5$ and $\Delta z_{\min} = \Delta r_{\min} = 10^7 \text{ cm}$). The numerical results are in good agreement with the analytical results. The difference in the early evolution of the jet is caused by the insufficient smallness of the initial jet size. Since the power law index (α) in the mass density profile exceeds $\alpha > 3$ at a certain radius and ξ_a becomes infinity or negative in Equation (13), we can not apply the analytical formula after $t = 1.05 \text{ s}$. Figure 15 is the confirmation that the analytical physical picture of Bromberg et al. (2011) is correct³ based on the numerical calculations that take great care with the baryon loading and the initial jet size. Although the opening angle of the jet measured from the stellar origin is small just before the breakout, the jet cannot maintain this opening angle after the jet breakout because the jet is hot and would try to expand with $\sim 1/\Gamma_0$ due to the thermal pressure.

4.2. Jet Evolution in Decreasing External Pressure

We numerically find that the opening angle of the jet is not $\sim 1/\Gamma_0$ but $\sim 1/5\Gamma_0$ where Γ_0 is the Lorentz factor of the jet inside the star. This is because the cocoon expands into outer space and hence the cocoon pressure decreases outward after the jet breakout from the stellar surface. In the decreasing pressure, the jet becomes less collimated and hence more accelerated than that in the star. Since the jet-breakout acceleration increases the Lorentz factor Γ before free expansion begins, the jet opening angle determined by $\sim 1/\Gamma$ is narrower than the naive estimate.

³ We introduce a parameter to fit the numerical results with the analytic formula. It is η in Equation (8), and turns out to be relatively small ($\eta \sim 0.01$). One of the reason for the smallness of η is the weak dependence of the radii on η in Equations. (24)–(27). These analytic formulae for radii should have errors of a factor of ~ 2 because of the reasons discussed below Equation (8). This factor corresponds to $1/2^5 \sim 0.03$ for η , which differs only by a factor of ~ 3 from the fitting result ($\eta \sim 0.01$).

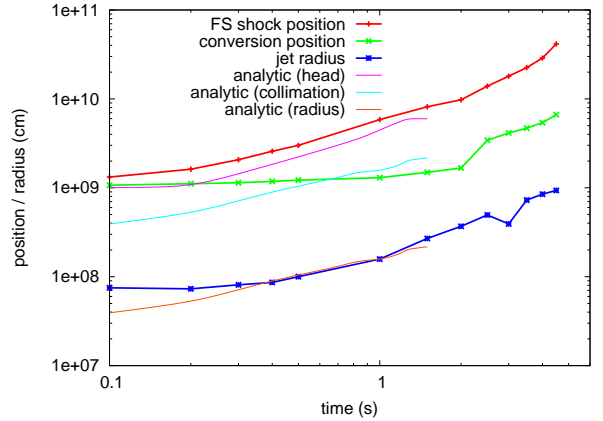

FIG. 15.— Comparison of the numerical results with the analytical formulae for the jet propagation inside the star (see Section 4.1). We show the forward shock position of the jet head z_h , the converging position of the collimation shock \hat{z} , and the maximum cylindrical radius of the jet $r_{s,\max} \simeq \theta_0 z_{\max}$. Theoretical model lines are also plotted. Since the slope of the radial mass density profile starts to rapidly drop at $R \sim 6 \times 10^9 \text{ cm}$, there is no analytical solution outside this point.

The jet-breakout acceleration is broadly divided into two types, i.e., with and without a shock. Both types contribute equally to the Lorentz factor enhancement. Since it is difficult to disentangle the two acceleration mechanisms, we discuss these cases separately below, assuming each mechanism is dominant.

First, we consider the jet-breakout acceleration by evaluating the Lorentz factor after the collimating oblique shock. The cocoon pressure that is decreasing outward is expressed by

$$P_c(z) = P_* \left(\frac{z}{z_*} \right)^{-\lambda}. \quad (28)$$

Under this pressure, we can solve the geometry of the collimation shock, as in Section 4.1 with Equations (14) and (15):

$$r_s = \theta_0 z \left(1 + \frac{A_* z_*}{1 - \frac{\lambda}{2}} \right) - \frac{\theta_0 A_* z_*^2}{1 - \frac{\lambda}{2}} \left(\frac{z}{z_*} \right)^{-\frac{\lambda}{2}}, \quad (29)$$

where z_* is the initial position of the collimation shock and

$$A_* = \sqrt{\frac{\pi c P_*}{L_j \beta_0}}. \quad (30)$$

We show the shock geometry in Figure 14. Note that the shock geometry is not a parabola, in contrast with the constant pressure case in Equation (16). The collimation shock expands to a maximum cylindrical radius at $\frac{dr_s}{dz} \Big|_{z=z_{\max}} = 0$, where the maximally-expanding position is given by

$$\frac{z_{\max}}{z_*} = \left[\left(\frac{2 - \lambda}{A_* z_*} + 2 \right) \frac{1}{4 - \lambda} \right]^{\frac{2}{2 - \lambda}}. \quad (31)$$

Here $\lambda < 2$ is necessary for the shock to converge. At the position z_{\max} , the general relation for a hot jet in

Equation (19) is given by

$$L_j \simeq 4 \left[P_* \left(\frac{z_{\max}}{z_*} \right)^{-\lambda} \right] \Gamma_1^2 (\pi \theta_0^2 z_{\max}^2) c. \quad (32)$$

This yields the Lorentz factor after the collimation shock,

$$\Gamma_1 \simeq \frac{1}{\theta_0} \times \mathcal{A}, \quad (33)$$

which is larger than that for a constant pressure case in Equation (20) by

$$\mathcal{A} = \frac{4 - \lambda}{4 - 2\lambda + 4A_* z_*} \simeq \frac{4 - \lambda}{4 - 2\lambda} \sim 5, \quad \text{if } \lambda \sim 1.8, \quad (34)$$

for small $A_* z_*$. To be precise, θ_0 is not the initial opening angle of the jet here, but the opening angle of the jet expanding to the last collimating oblique shock, which is the inverse of the Lorentz factor inside a jet $\sim \Gamma_0^{-1}$ and thereby turns out to be θ_0 from Equations (20) and (21).

The numerical calculations show that the total acceleration factor is $\mathcal{A} \sim 5$ (see Figure 15), about half of which is achieved at the collimation shock and the other half of which is obtained later. A factor ~ 2.5 can be explained by $\lambda \sim 1.5$. Although it is difficult to estimate the exact acceleration factor \mathcal{A} analytically, we can see that \mathcal{A} is mainly determined by the slope λ of the external pressure profile. In our case, the external pressure profile is shaped by the cocoon expansion to outer space, which does not depend on the jet properties so much. Therefore it is natural that similar acceleration factors are obtained for the different initial conditions in our numerical calculations.

Next, we consider a jet-breakout acceleration without shocks (i.e., an adiabatic jet) as the other extreme. The jet expands in a decreasing pressure, decreasing its temperature as radiation, i.e., $T' \propto V'^{-1/3}$, where V' is the comoving volume of the jet. If the pressure in the jet balances with the pressure in the cocoon, i.e., $T'^4 \propto P_c$, the jet does not perform work and hence the energy is conserved and $\Gamma T'^4 V' \sim \text{const}$. Therefore the jet accelerates as the size grows according to (Ioka et al. 2011)

$$\Gamma \propto T'^{-1} \propto P_c^{-1/4} \propto z^{\lambda/4}. \quad (35)$$

In the numerical calculations, we identify such an adiabatic evolution after the collimation shock, in particular at the periphery of the jet. For $2 < \lambda < 4$, the cocoon pressure does not causally affect the jet interior (Ioka et al. 2011) but can still affect the periphery of the jet. Note that the off-center origin makes the pressure profile (Figure 5(b)) shallower than that shown in Figure 5(a), which assumes a stellar center origin.

In order to estimate the acceleration factor of the Lorentz factor, we need to know how much the jet expands before entering a free expansion phase. In this regard, we should note that the jet expands from the breakout position, that is, the fireball of the jet is off-centered by the cocoon confinement. This means that the fireball size should not be measured from the center of the star. Instead, the effective center of the fireball is located at a distance $\sim \Gamma_0 r_j \sim r_j / \theta_0$ inward from the stellar surface (breakout point) because the jet tries

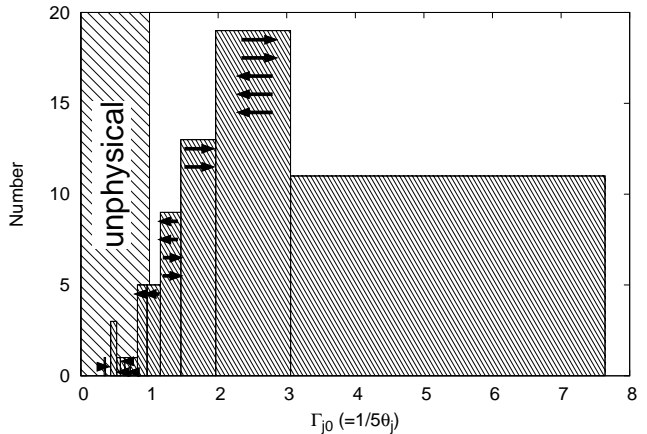

FIG. 16.— Distribution of the initial Lorentz factor of the jet inferred by the observations and the relation $\Gamma_0 = 1/5\theta_j$ in Equation (3). Observational data (θ_j, N) are taken from Figure 6 in Fong et al. (2012). Since the Lorentz factor should be greater than unity, the region with $\Gamma_0 < 1$ is shaded as an unphysical zone.

to expand with an opening angle of $1/\Gamma_0$ and the expanding surface has an initial cylindrical radius of r_j in Equation (26). So, the initial fireball size is

$$r_0 \sim \Gamma_0 r_j \sim r_j / \theta_0. \quad (36)$$

If the fireball expands to a size of the stellar radius $R \sim 4 \times 10^{10}$ cm, the expansion factor is about ~ 10 times for the typical parameters in Equation. (26) and hence the Lorentz factor grows by a factor ~ 3 for $\lambda \sim 2$, according to Equation (35). Thus, the adiabatic expansion can explain a part of the jet-breakout acceleration observed in the numerical calculations. Here, a parameter dependence of the expansion factor is weak since the initial fireball size is $r_0 \propto L_j^{1/6} \rho_a^{-1/6} \theta_0^{1/3}$ at the breakout time (when $R \sim z_h$) with Equations (25) and (26). Note that the jet-breakout acceleration looks very rapid at first glance if we do not note the off-center effect (i.e., the radius measured from the stellar center is only doubled).

5. DISCUSSION

5.1. Lorentz Factor of the Jet in a Star

The opening angle of the GRB jet is usually measured by observing a jet break in the afterglow lightcurve (Racusin et al. 2009, 2011; Fong et al. 2012). Our numerical calculations show that a jet opening angle is related to the Lorentz factor inside a star by

$$\theta_j \sim \frac{1}{5\Gamma_0}. \quad (37)$$

By applying this formula, we can infer the Lorentz factor inside a star (or the initial opening angle) from the observed opening angle of the GRB jet. Figure 16 shows the estimated Lorentz factor inside a star. The result suggests that the jet is mildly relativistic in a star (or the initial opening angle is $O(0.3-0.5)$ rad).

A slow jet inside a star is a preferable condition for the survival of nuclei in the jet, which may explain the observed ultra-high energy cosmic ray nuclei (Murase et al. 2008; Wang et al. 2008; Metzger et al. 2011; Horiuchi et al. 2012).

Equation (37) also implies that the maximum opening angle is obtained by setting $\Gamma_0 \sim 1$ as

$$\theta_{j,\max} \sim 1/5 = 0.2 \sim 12^\circ, \quad (38)$$

if the jet is radiation dominated at the breakout. However several events violate this maximum, as shown in Figure 16 (Racusin et al. 2009, 2011; Fong et al. 2012). There are two possibilities to this problem. The first is to consider a baryon-rich slow sheath surrounding a central jet. A baryon-rich flow cannot accelerate to a large Lorentz factor, and if the Lorentz factor of the baryon-rich sheath is less than ~ 5 , the opening angle of the sheath can be larger than ~ 0.2 . Note that the central jet should have $h\Gamma > 100$ to avoid the compactness problem.⁴ The second is to consider long-acting engine activity (e.g., Ioka et al. (2005)). After several tens of seconds in Equation (39), the jet is no longer confined by the cocoon and the opening angle can widen to $\theta_j \sim 1/\Gamma_0$ without the factor of ~ 5 (see the next section). If the jet energy is dominated by the wide opening angle component, the wide component determines the opening angle of the jet obtained from the afterglow observations.

5.2. Origin of the GRB Duration

In our new picture with the jet-breakout acceleration in Figure 1, the GRB duration would be determined by the sound crossing time of the cocoon, which is about $t_{sc} \sim R_*/c\beta_c$, where the sound velocity in the cocoon is about $c\beta_c$ in Equation (9). At $t < t_{sc}$, the cocoon persists around the star and provides pressure for collimating the jet into an opening angle $\theta_j \sim 1/5\Gamma_0$ in Equation (3). However, at $t > t_{sc}$, the cocoon pressure decreases and thereby the jet is no longer confined. The opening angle of the jet increases to $\theta_j \sim 1/\Gamma_0$, which is determined by the free expansion without the jet-breakout acceleration (see also Morsony et al. 2007). Then, the apparent luminosity of the GRB jet is reduced by a factor of $\sim 5^2 \sim 25$. Even if the jet injection continues after $t > t_{sc}$, we observe that the GRB terminates. Therefore we expect the observed duration to be

$$T_{90} \sim t_{sc} \equiv R_*/c\beta_c. \quad (39)$$

With Equations(9), (10), and (23), we have

$$T_{90} \sim R_* \left(\frac{\rho_a t^2}{L_j \theta_0} \right)^{1/5} \left(\frac{(6\pi)^2 \xi_a^3 \xi_h^2 \xi_c^4}{\eta^2} \right)^{1/10}. \quad (40)$$

Here it is appropriate to set the time t to the breakout time determined by $z_h = R_*$ in Equation (24), which is

$$\begin{aligned} t = t_{br} &\equiv \left(\frac{R_*^5 \rho_a \theta_0^4}{L_j} \right)^{1/3} \left(\frac{3\pi}{16} \frac{\xi_c^2}{\eta \xi_a \xi_h^4} \right)^{1/3} \\ &\sim 0.58 \text{ s} \left(\frac{R_*}{10^{10} \text{ cm}} \right)^{5/3} \left(\frac{L_j}{10^{51} \text{ erg s}^{-1}} \right)^{-1/3} \end{aligned}$$

⁴ A potential third possibility is that the outflow is initially non-relativistic and expands to a relativistic speed. The non-relativistic flow expands to an angle larger than the relativistic case, $\theta_0 \sim \pi > 1/\Gamma_0$, so that the final opening angle after the breakout might be also larger than the maximum value in Equation (38). However, the collimation of the spherically expanding flow cannot be treated by the formulae in this paper and Bromberg et al. (2011). So, we leave this possibility for the future studies.

$$\times \left(\frac{\rho_a}{10^3 \text{ g cm}^{-3}} \right)^{1/3} \left(\frac{\theta_0}{0.1} \right)^{4/3}. \quad (41)$$

Then we have

$$\begin{aligned} T_{90} &= \left(\frac{R_*^5 \rho_a \theta_0}{L_j} \right)^{1/3} \left(\frac{(3\pi)^2 \xi_a \xi_c^4}{4 \xi_h^2 \eta^2} \right)^{1/6} \\ &\sim 20 \text{ s} \left(\frac{R_*}{10^{10} \text{ cm}} \right)^{5/3} \left(\frac{L_j}{10^{51} \text{ erg s}^{-1}} \right)^{-1/3} \\ &\times \left(\frac{\rho_a}{10^3 \text{ g cm}^{-3}} \right)^{1/3} \left(\frac{\theta_0}{0.1} \right)^{1/3}, \quad (42) \end{aligned}$$

which is consistent with the observed GRB duration $T_{90} \sim 10$ sec. We again set $\alpha = 2$ [$\xi_a = 3$, $\xi_h = \xi_c = 1$ in Equation (13)] and $\eta = 0.01$ for the numerical values.

5.3. Amati and Yonetoku Relations

Based on our numerical and analytical modeling, we can evaluate the initial condition of a jet that is just expanding freely and infer the observational characteristics of the jet based on the photospheric model (e.g., Pe'er et al. 2007; Ioka et al. 2007). First, since we are now able to estimate the opening angle of the jet in Equation (37), we can assess the isotropic luminosity of the jet:

$$L_{\text{iso}} = \frac{4L_j}{\theta_j^2} \propto L_j \Gamma_0^2. \quad (43)$$

We can also obtain the observed temperature of a jet if it is radiation dominated:

$$E_{\text{peak}} \sim T_{\text{obs}} \propto \Gamma_0 T' \propto \Gamma_0 P_c^{1/4}, \quad (44)$$

which may be identified with the spectral peak energy E_{peak} of a GRB in the photosphere model. In the actual observations of GRBs, there is a relation between the isotropic luminosity and the observed temperature,

$$E_{\text{peak}} \propto L_{\text{iso}}^{1/2}, \quad (45)$$

the so-called Yonetoku relation (Yonetoku et al. 2004).

Let us show that the Yonetoku relation can be reproduced if we assume that the total jet luminosity is proportional to the Lorentz factor inside the star

$$L_j \propto \Gamma_0, \quad (46)$$

that is, the mass outflow rate is $\dot{M} = L_j/\Gamma_0 \sim \text{const}$. First, the above equation gives $L_{\text{iso}} \propto \Gamma_0^3$ with Equation (43). Next, substituting Equations (43) and (44) into Equation (19) (where we should read Γ_1 as Γ_0) yields

$$E_{\text{peak}} \propto L_{\text{iso}}^{1/4} \Sigma_j^{-1/4}. \quad (47)$$

The jet breakout occurs when $z_h \sim R_*$ at the time

$$t \propto L_j^{-1/3} \theta_0^{4/3}, \quad (48)$$

obtained from Equation (25) (see also Equation (41)). At this time the jet cross-section follows

$$\Sigma_j \propto t^{4/5} L_j^{3/5} \theta_0^{8/5} \propto L_j^{1/3} \theta_0^{8/3}, \quad (49)$$

from Equation (26)⁵. Then, noting $\theta_0 \sim \Gamma_0^{-1}$, we have

$$E_{\text{peak}} \propto L_{\text{iso}}^{1/4} \Gamma_0^{7/12} \propto L_{\text{iso}}^{4/9}, \quad (50)$$

which is close to the Yonetoku relation.

In addition, we may be also able to reproduce the Amati relation (Amati et al. 2002),

$$E_{\text{peak}} \propto E_{\text{iso}}^{1/2} \quad (\text{Amati relation}). \quad (51)$$

We can think that the GRB duration is roughly given by the sound-crossing time across the cocoon of the stellar size in Equation (42),

$$T_{90} \sim \frac{R_*}{c\beta_c} \propto t^{2/5} L_j^{-1/5} \theta_0^{-1/5} \propto L_j^{-1/3} \theta_0^{1/3} \propto L_{\text{iso}}^{-2/9}, \quad (52)$$

with Equations (9) and (23), because the cocoon pressure decreases after this time, leading to less confinement, a larger opening angle, and a smaller isotropic luminosity of the jet. Note that the weak correlation between T_{90} and L_{iso} is actually observed. Then, we can estimate the isotropic energy as

$$E_{\text{peak}} \propto L_{\text{iso}}^{4/9} \propto (L_{\text{iso}} T_{90})^{4/7} \sim E_{\text{iso}}^{4/7}, \quad (53)$$

which is also similar to the Amati relation. This is killing two birds with one stone, that is, we explain the slopes of two relations (the Amati and Yonetoku relations) by only one assumption in Equation (46). We leave the explanation of the normalization factor for future studies.

Lazzati et al. (2013) reproduced the Amati relation in the context of the photosphere model by combining their numerical results with an analytical model for estimating the peak energy. It is not easy to compare the Lazzati et al. (2013) model with our analytic model. Since in Lazzati et al. (2013), most radiation is released in the coasting phase, in which the most thermal energy has been converted to kinetic energy, the temperature estimation is different from our estimates. The second is that the viewing angle dependence mainly produces the Amati relation in Lazzati et al. (2013), which is different from our cases.

6. SUMMARY

In this paper we have explored the dynamics of GRB jets from collapsars by performing two-dimensional relativistic hydrodynamic simulations as well as analytical modeling. We have followed the jet propagation all the way from the progenitor star through the jet breakout to the free expansion, implementing probe particles to trace the Lagrangian motion of the fluid elements. This enables us to connect the final jet appearance to the initial jet conditions near the central engine.

We have found that the jet opening angle after the jet breakout is about $\theta_j \sim 1/5\Gamma_0$ in Equation (3) and Figure 9, where Γ_0 is the initial Lorentz factor of the jet injected into the progenitor star. This value is smaller than the naive expectation of $\theta_j \sim 1/\Gamma_0$ in Figure 1, where we thought that the opening angle was determined by the inverse of the Lorentz factor and that the Lorentz factor maintains its the initial value of Γ_0 for a cylindrical jet. Actually, this is partly correct. The jet becomes

cylindrical under the nearly homogeneous pressure of the cocoon after crossing the first collimation shock. The Lorentz factor after the collimation shock is $\sim \Gamma_0$ and largely stays constant before the jet breakout, according to our simulations. However, we have identified the ‘‘jet-breakout acceleration’’ just before and after the jet breakout. This occurs because the pressure profile of the cocoon can not remain constant but decreases outward as the cocoon expands to outer space. The cocoon still confines the jet to some extent near the stellar radius, while the jet expands its cylindrical radius with increasing its Lorentz factor by a factor ~ 5 before a free expansion. Therefore the jet opening angle becomes narrow, which is determined by the inverse of the Lorentz factor at the base of the free expansion, as explicitly shown by the numerical simulations. The opening angles are roughly constant over time with a factor ~ 2 fluctuation in Figure 8.

We have also analytically modeled the jet-breakout acceleration. The jet-breakout acceleration occurs with and without the collimating oblique shock, and both are equally important. For the former case, we solve the structure of the collimating oblique shock in a decreasing pressure profile and obtain the Lorentz factor after the shock in Equation (33). The post-shock Lorentz factor is enhanced appreciably for a pressure slope close to $\lambda \sim 2$ in $P \propto z^{-\lambda}$. The latter case happens after the last collimating oblique shock, even for $\lambda > 2$ near the periphery of the jet in Equation (35).

We have also compared our numerical results with the analytical formulae for jet propagation inside the star presented by Bromberg et al. (2011), and have confirmed a good agreement. For later use, we have calibrated the model parameter with the numerical results. We can now calculate the jet evolution relatively precisely with ease, such as the jet head position, the jet cylindrical radius, and the converging position of the collimation shock, for a wide range of initial conditions.

We have paid special attention to the numerical diffusion of the baryon loading into the jet through the discontinuity, which can entirely change the jet propagation. We have also taken the initial cylindrical radius of the jet to be sufficiently smaller than the radius after the first collimation shock, because a large initial radius slows down the jet propagation. For these purposes, we have performed one of the highest resolution calculations so far.

The post-breakout jet shows a hollow-cone angular structure. The edge is relatively sharp with an exponential drop. The bright rim is produced by the shock between the expanding jet and the high pressure cocoon before the free expansion.

To understand the jet evolution, it is important to note that the jet expands off-center as a result of the cocoon confinement. If the expansion origin is the stellar center, the fireball would feel a steep pressure profile of the cocoon pressure and the acceleration would be slow. In addition, the opening angle should be measured from the off-center origin for precise analyses.

We have also applied our results to the observations. First we infer the initial Lorentz factor Γ_0 of the jet injected at the central engine by using the observed opening angles in Figure 16. The distribution of Γ_0 peaks at around ~ 2 -3. Second, our result suggests the exist-

⁵ We assume that the structure of the progenitor star is similar and neglect the dependence on it.

tence of a maximum opening angle for a high-entropy jet, $\theta_{j,\max} \sim 1/5 \sim 12^\circ$, in Equation (38). However several bursts violate this maximum value. This may imply a two-component jet with a baryon-rich slow sheath surrounding a central jet, or a long-lasting jet after the GRB prompt emission.

The opening angle evolution with the jet-breakout acceleration is also important for determining the observed duration of GRB. In particular, the GRB duration is given by the sound crossing time of the cocoon in Equation (23). Before this time, the cocoon continues to exist around the jet and confines it into an opening angle $\sim 1/5\Gamma_0$, while after that, the jet expands freely and the opening angle increases to $\sim 1/\Gamma_0$. This reduces the apparent luminosity of the GRB, effectively terminating the observed GRB.

We have also derived the slopes of the Amati and Yonetoku spectral relations by applying our results to the photosphere of the jet that is expanding freely after the jet breakout. We explain the slopes of both the relations with only one assumption that the jet luminosity is proportional to the initial Lorentz factor, $L_j \propto \Gamma_0$, in Equation (46), i.e., the mass outflow rate is independent of the jet luminosity, $\dot{M} = L_j/\Gamma_0 \sim \text{const}$. The fireball temperature becomes different from the value at the central engine after the jet propagation through the star. Thus the confinement by the cocoon and the off-center expansion of the jet may be the missing pieces for the photosphere model so far.

In the future, it will be interesting to study the long-term evolution of the jet studied in this paper and

the evolution of the low-luminosity jet and the two-component jet. It will also be important to investigate jet propagation in a huge progenitor such as the population III GRBs (Suwa & Ioka 2011; Nagakura, Suwa & Ioka 2012) and ultra-long GRBs (Levan et al. 2013; Murase & Ioka 2013). It will be interesting to perform magnetohydrodynamic simulations to study the effect of magnetic fields on the jet dynamics and the opening angle of the jet. For example, Mignone et al. (2010) have performed magnetohydrodynamic simulations in the context of active galactic nucleus jets. Three-dimensional numerical hydrodynamic simulation including precession or other effects will also be interesting (for example, see López-Cámara et al. (2013)).

We thank A. Heger for his kindness to allow us to use his progenitor models. We thank the anonymous referee for constructive comments that improved our manuscript. This work is supported by a Grant-in-Aid for Scientific Research from the Ministry of Education, Culture, Sports, Science and Technology (MEXT) of Japan and the Japan Society for the Promotion of Science (JSPS) (20105005 (AM), 24103006, 24000004, 22244030, 21684014 (KI)). Numerical simulations were carried out on SR-16000, at YITP, Kyoto University, on the Space Science Simulator (NEC SX9) at JAXA, and on the XT4 System at CFCA at NAOJ. This work was supported in part by the Center for the Promotion of Integrated Sciences (CPIS) of Sokendai. The page charge of this paper is partly supported by CFCA at NAOJ.

REFERENCES

- Abdo, A. A., et al. 2009, *Science*, 323, 1688
 Ackermann, M., et al. 2010, *ApJ*, 716, 1178
 Aloy, M. A., Müller, E., Ibáñez, J. M., Martí, J. M., & MacFadyen, A. 2000, *ApJ*, 531, L119
 Amati, L., et al. 2002, *A&A*, 390, 81
 Begelman, M. C., & Cioffi, D. F. 1989, *ApJ*, 345, L21
 Bromberg, O., & Levinson, A. 2009, *ApJ*, 699, 1274
 Bromberg, O., Nakar, E., Piran, T., & Sari, R. 2011, *ApJ*, 740, 100
 Campana, S., et al. 2006, *Nature*, 442, 1008
 Donat, R., & Marquina, A. 1996, *Journal of Computational Physics*, 125, 42
 Fong, W., Berger, E., Margutti, R., et al. 2012, *ApJ*, 756, 189
 Galama, T. J., et al. 1998, *Nature*, 395, 670
 Horiuchi, S., Murase, K., Ioka, K., & Mészáros, P. 2012, *ApJ*, 753, 69
 Ioka, K. 2010, *Prog. Theor. Phys.*, 124, 667
 Ioka, K., Kobayashi, S., & Zhang, B. 2005, *ApJ*, 631, 429
 Ioka, K., Murase, K., Toma, K., Nagataki, S., & Nakamura, T. 2007, *ApJ*, 670, L77
 Ioka, K., Ohira, Y., Kawanaka, N., & Mizuta, A. 2011, *Prog. Theo. Phys.*, 126, 555
 Iwamoto, K., et al. 1998, *Nature*, 395, 672
 Komissarov, S. S., & Falle, S. A. E. G. 1997, *MNRAS*, 288, 833
 Komissarov, S. S., & Falle, S. A. E. G. 1998, *MNRAS*, 297, 1087
 Lazzati, D., Morsony, B. J., & Begelman, M. C. 2009, *ApJ*, 700, L47
 Lazzati, D., Morsony, B. J., Margutti, R., & Begelman, M. C. 2013, *ApJ*, 765, 103
 Levan, A. J., et al. 2013, arXiv:1302.2352
 López-Cámara, D., Morsony, B. J., Begelman, M. C., & Lazzati, D. 2013, *ApJ*, 767, 19
 MacFadyen, A. I., & Woosley, S. E. 1999, *ApJ*, 524, 262
 Martí, J. M. A., Mueller, E., Font, J. A., Ibanez, J. M. A., & Marquina, A. 1997, *ApJ*, 479, 151
 Matzner, C. D. 2003, *MNRAS*, 345, 575
 Mazzali, P. A., et al. 2006, *Nature*, 442, 1018
 Mészáros, P., & Waxman, E. 2001, *Physical Review Letters*, 87, 171102
 Metzger, B. D., Giannios, D., & Horiuchi, S. 2011, *MNRAS*, 415, 2495
 Mignone, A., Rossi, P., Bodo, G., Ferrari, A., & Massaglia, S. 2010, *MNRAS*, 402, 7
 Mizuta, A., & Aloy, M. A. 2009, *ApJ*, 699, 1261
 Mizuta, A., Kino, M., & Nagakura, H. 2010, *ApJ*, 709, L83
 Mizuta, A., Nagataki, S., & Aoi, J. 2011, *ApJ*, 732, 26
 Mizuta, A., Yamada, S., & Takabe, H., 2004, *ApJ*, 606, 804
 Mizuta, A., Yamasaki, T., Nagataki, S., & Mineshige, S. 2006, *ApJ*, 651, 960
 Morsony, B. J., Lazzati, D., & Begelman, M. C. 2007, *ApJ*, 665, 569
 Morsony, B. J., Lazzati, D., & Begelman, M. C. 2010, *ApJ*, 723, 267
 Murase, K., & Ioka, K. 2013, *PhRvL*, 111, 121102
 Murase, K., Ioka, K., Nagataki, S., & Nakamura, T. 2008, *Phys. Rev. D*, 78, 023005
 Nagakura, H., Ito, H., Kiuchi, K., & Yamada, S. 2011, *ApJ*, 731, 80
 Nagakura, H., Suwa, Y., & Ioka, K. 2012, *ApJ*, 754, 85
 Pe'er, A., Ryde, F., Wijers, R. A. M. J., Mészáros, P., & Rees, M. J. 2007, *ApJ*, 664, L1
 Racusin, J. L., Liang, E. W., Burrows, D. N., et al. 2009, *ApJ*, 698, 43
 Racusin, J. L., Oates, S. R., Schady, P., et al. 2011, *ApJ*, 738, 138
 Ramirez-Ruiz, E., Celotti, A., & Rees, M. J. 2002, *MNRAS*, 337, 1349
 Sari, R., Piran, T., & Halpern, J. P. 1999, *ApJ*, 519, L17
 Shu, C.-W., & Osher, S. 1988, *Journal of Computational Physics*, 77, 439
 Stanek, K. Z., et al. 2003, *ApJ*, 591, L17
 Suzuki, A., & Shigezuma, T. 2013, *ApJ*, 764, L12
 Suwa, Y., & Ioka, K. 2011, *ApJ*, 726, 107

- Toma, K., Ioka, K., Sakamoto, T., & Nakamura, T. 2007, ApJ, 659, 1420
- van Leer, B. 1977, Journal of Computational Physics, 23, 276
- Wang, X.-Y., Razzaque, S., & Mészáros, P. 2008, ApJ, 677, 432
- Woosley, S. E. 1993, ApJ, 405, 273
- Woosley, S. E., & Heger, A., 2006, ApJ, 637, 914
- Yonetoku, D., Murakami, T., Nakamura, T., Yamazaki, R., Inoue, A. K., & Ioka, K. 2004, ApJ, 609, 935
- Zhang, W., Woosley, S. E., & Heger, A. 2004, ApJ, 608, 365
- Zhang, W., Woosley, S. E., & MacFadyen, A. I. 2003, ApJ, 586, 356