

Geometric Optimization Methods for Adaptive Filtering

A thesis presented
by

Steven Thomas Smith

to

The Division of Applied Sciences

in partial fulfillment

for the degree of Doctor of Philosophy

in the subject of

Applied Mathematics

Harvard University
Cambridge, Massachusetts

May 1993



To Laura

*L'aura soave al sole spiega et vibra
l'auro ch' Amor di sua man fila et tesse;
là da' belli occhi et de le chiome stesse
lega 'l cor lasso e i lievi spirti cribra.*

*Non ò medolla in osso o sangue in fibra
ch' i' non senta tremar pur ch' i' m'apresse
dove è chi morte et vita insieme, spesse
volte, in frale bilancia apprende et libra,
vedendo ardere i lumi ond' io m'accendo,
et folgorare i nodi ond' io son preso
or su l'omero destro et or sul manco.
I' nol posso ridir, ché nol comprendo,
da ta' due luci è l'intelletto offeso
et di tanta dolcezza opresso et stanco.*

Petrarch, Rime sparse

ACKNOWLEDGMENTS

I would like to thank my advisor Professor Roger Brockett for directing me in three directions that eventually coalesced: subspace tracking, gradient flows on Lie groups, and conjugate gradient methods on symmetric spaces. I am also indebted to Tony Bloch for the invitation to speak at the Fields Institute workshop on Hamiltonian and gradient flows in April 1992, and to the Fields Institute itself for their generous support during my visit. I greatly appreciated the opportunity to present my work to the distinguished participants of this workshop. My exposition was influenced by the teaching style of Professor Guillemin, and I benefited from many helpful discussions with Professor Anderson, who has always been generous with his time and advice. I would also like to thank the members of my thesis committee: Professors James Clark, Petros Maragos, and David Mumford, not only for their evaluation of this work, but also for the intellectual and social qualities that they and their students brought to the Harvard Robotics Laboratory.

My life in graduate school would have been much more difficult without the pleasant and supportive atmosphere that my classmates provided. The help and advice of my predecessors was invaluable in learning the graduate student ropes. I will always remember sitting on the bank of Walden Pond with Bill Nowlin, Nicola Ferrier, and Ann Stokes on my first day off after a very long first year. “I’m supposed to pick a project this summer,” I said. Bill was quick with his advice: “The summer after first year is just a waste.” I also remember Nicola bringing cookies to me and Bob Hewes late one night because she remembered how heavy the work load was. Ken Keeler and Frank Park enriched the cultural life of Pierce G14 by founding an ever growing museum. Peter Hallinan and Tai Sing Lee taught me some climbing techniques at Acadia Natl. Park. Gaile Gordon hosted many enjoyable and memorable social events. Ed Rak convinced me that I could hack $\text{T}_{\text{E}}\text{X}$ macros and still graduate. Ann Stokes’s friendship made office life enjoyable even in the batcave. John Page and George Thomas worked very hard to ensure that the lab ran smoothly. Leonid Faybusovich taught me about the gradient. I thoroughly enjoyed the discussions I shared with Dan Friedman, Jeff Kosowsky, Bob Hewes, Peter Belhumeur, and others. We all owe a debt to Navin Saxena for making our Wednesday afternoon lab tea a thriving event.

Finally, I thank my family, especially my parents for their encouragement, empathy, and love. Most of all, I thank my wife Laura, whom I love very much. Her constant thoughtfulness, support, patience, and love made many difficult days good, and many good days great.

ABSTRACT

The techniques and analysis presented in this thesis provide new methods to solve optimization problems posed on Riemannian manifolds. These methods are applied to the subspace tracking problem found in adaptive signal processing and adaptive control. A new point of view is offered for the constrained optimization problem. Some classical optimization techniques on Euclidean space are generalized to Riemannian manifolds. Several algorithms are presented and their convergence properties are analyzed employing the Riemannian structure of the manifold. Specifically, two new algorithms, which can be thought of as Newton's method and the conjugate gradient method on Riemannian manifolds, are presented and shown to possess quadratic and superlinear convergence, respectively. These methods are applied to several eigenvalue and singular value problems, which are posed as constrained optimization problems. New efficient algorithms for the eigenvalue problem are obtained by exploiting the special homogeneous space structure of the constraint manifold. It is shown that Newton's method applied to the Rayleigh quotient on a sphere converges cubically, and that the Rayleigh quotient iteration is an efficient approximation of Newton's method. The Riemannian version of the conjugate gradient method applied to this function gives a new algorithm for finding the eigenvectors corresponding to the extreme eigenvalues of a symmetric matrix. The Riemannian version of the conjugate gradient method applied to a generalized Rayleigh quotient yields a superlinearly convergent algorithm for computing the k eigenvectors corresponding to the extreme eigenvalues of an n -by- n matrix. This algorithm requires $O(nk^2)$ operations and $O(k)$ matrix-vector multiplications per step. Several gradient flows are analyzed that solve eigenvalue and singular value problems. The new optimization algorithms are applied to the subspace tracking problem of adaptive signal processing. A new algorithm for subspace tracking is given, which is based upon the conjugate gradient method applied to the generalized Rayleigh quotient. The results of several numerical experiments demonstrating the convergence properties of the new algorithms are given.

CONTENTS

Acknowledgments iv

Abstract v

Figures vii

Tables viii

1. Introduction	1
2. Riemannian geometry of Lie groups and homogeneous spaces	7
1. Riemannian manifolds	7
2. Lie groups and homogeneous spaces	12
3. Examples	21
3. Gradient flows on Lie groups and homogeneous spaces	26
1. The diagonalization of a matrix	27
2. The extreme eigenvalues of a matrix	30
3. The singular value decomposition	33
4. Optimization on Riemannian Manifolds	47
1. Preliminaries	49
2. Steepest descent on Riemannian manifolds	49
3. Newton's method on Riemannian manifolds	55
4. Conjugate gradient method on Riemannian manifolds	63
5. Application to Adaptive Filtering	71
1. Adaptive estimation techniques	74
2. Conjugate gradient method for largest eigenvalues	76
3. Conjugate gradient method for subspace tracking	90
6. Conclusions	97

References 101

FIGURES

Chapter 2.

Figure 1. Geodesic on a sphere	11
Figure 2. Parallel translation on a sphere	11
Figure 3. Covariant differentiation	11

Chapter 3.

Figure 1. Gradient flow of singular value decomposition	46
Figure 2. Off-diagonal convergence of SVD gradient flow	46

Chapter 4.

Figure 1. Convergence with the Rayleigh quotient on S^{20}	68
Figure 2. Conjugate gradient iterates on the 2-sphere	69
Figure 3. Convergence with $\text{tr } \Theta^T Q \Theta N$ on $\mathbf{SO}(20)$	70

Chapter 5.

Figure 1. Convergence with the generalized Rayleigh quotient on $V_{100,3}$	87
Figure 2. Convergence of the diagonal elements of $p_i^T A p_i$	88
Figure 3. Convergence of the tracking algorithm: First test	94
Figure 4. Tracking estimated eigenvalues: First test	94
Figure 5. Convergence of the tracking algorithm: Second test	95
Figure 6. Tracking estimated eigenvalues: Second test	95
Figure 7. Convergence of the tracking algorithm: Third test	96
Figure 8. Tracking estimated eigenvalues: Third test	96

TABLES

Chapter 3.

Table 1. Convergence rates of selected elements of Σ	45
---	----

Chapter 5.

Table 1. Computational requirements of geodesic computation	83
Table 2. Computational requirements of $(\nabla^2\rho)_p(X, Y)$ computation	84
Table 3. Computational requirements of changing coset representative	85

CHAPTER 1

INTRODUCTION

Optimization is the central idea behind many problems in science and engineering. Indeed, determination of “the best” is both a practical and an aesthetic problem that is encountered almost universally. Thus it is not surprising to find in many areas of study a variety of optimization methods and vocabulary. While the statement of the optimization problem is simple—given a set of points and an assignment of a real number to each point, find the point with the largest or smallest number—its solution is not. In general, the choice of optimization algorithm depends upon many factors and assumptions about the underlying set and the real-valued function defined on the set. If the set is discrete, then a simple search and comparison algorithm is appropriate. If the discrete set is endowed with a topology, then a tree searching algorithm can yield a local extremum. If the set is a finite-dimensional vector space and the function is continuous, then the simplex method can yield a local extremum. If the set is a Euclidean space, i.e., a finite-dimensional vector space with inner product, and the function is differentiable, then gradient-based methods may be used. If the set is a polytope, i.e., a subset of Euclidean space defined by linear inequality constraints, and a linear function, then linear programming techniques are appropriate. This list indicates how successful optimization techniques exploit the given structure of the underlying space. This idea is an important theme of this thesis, which explains how the metric structure on a manifold may be used to develop effective optimization methods on such a space.

Manifolds endowed with a metric structure, i.e., Riemannian manifolds, arise naturally in many applications involving optimization problems. For example, the largest eigenvalue of a symmetric matrix corresponds to the point on a sphere maximizing the Rayleigh quotient. This eigenvalue problem and its generalizations are encountered in diverse fields: signal processing, mechanics, control theory, estimation theory, and others. In most cases the

so-called principal invariant subspace of a matrix must be computed. This is the subspace spanned by the eigenvectors or singular vectors corresponding to the largest eigenvalues or singular values, respectively. Oftentimes there is an adaptive context so that the principal invariant subspaces change over time and must be followed with an efficient tracking algorithm. Many algorithms rely upon optimization techniques such as gradient following to perform this tracking.

A few analytic optimization methods are quite old, but, as in most computational fields, the invention of electronic computers was the impetus for the development of modern optimization theory and techniques. Newton's method has been a well-known approach for solving optimization problems of one or many variables for centuries. The method of steepest descent to minimize a function of several variables goes back to Cauchy. Its properties and performance are well-known; see, e.g., the books of Polak (1971), Luenberger (1973), or Fletcher (1987) for a description and analysis of this technique. Modern optimization algorithms appeared in the middle of this century, with the introduction of linear and quadratic programming algorithms, the conjugate gradient algorithm of Hestenes & Stiefel (1952), and the variable metric algorithm of Davidon (1959). It is now understood how these algorithms may be used to compute the point in \mathbf{R}^n at which a differentiable function attains its maximum value, and what performance may be expected of them.

Of course, not all optimization problems are posed on a Euclidean space, and much research has been done on the constrained optimization problem, specifically when the underlying space is defined by equality constraints on Euclidean space. Because all Riemannian manifolds may be defined in this way, this approach is general enough for the purposes of this thesis. What optimization algorithms are appropriate on such a space? Luenberger (1973, pp. 254ff) considers this question in his exposition of the constrained optimization problem. He describes an idealized steepest descent algorithm on the constraint surface that employs geodesics in gradient directions, noting that this approach is in general not computationally feasible. For this reason, other approaches to the constrained optimization problem have been developed. All of these methods depend upon the imbedding of the constraint surface in \mathbf{R}^n . Projective methods compute a gradient vector tangent to the constraint surface, compute a minimum in \mathbf{R}^n along this direction, then project this point onto the constraint surface. Lagrange multiplier methods minimize a function defined on \mathbf{R}^n constructed from the original function to be minimized and the distance to the constraint surface. However, this so-called extrinsic approach ignores the intrinsic structure that the manifold may have. With specific examples, such as a sphere

and others to be discussed later, intrinsic approaches are computationally feasible, but the study of intrinsic optimization algorithms is absent from the literature.

Optimization techniques have long been applied to the fields of adaptive filtering and control. There is a need for such algorithms in these two fields because of their reliance on error minimization techniques and on the minimax characterization of the eigenvalue problem. Also, many scenarios in adaptive filtering and control have slowly varying parameters which corresponding to the minimum point of some function that must be estimated and tracked. Gradient-based algorithms are desirable in this situation because the minimum point is ordinarily close to the current estimate, and the gradient provides local information about the direction of greatest decrease.

Many researchers have applied constrained optimization techniques to algorithms that compute the static or time varying principal invariant subspaces of a symmetric matrix. This problem may be viewed as the problem of computing k orthonormal vectors in \mathbf{R}^n that maximize a generalized form of the Rayleigh quotient. Orthonormality imposes the constraint surface. Bradbury & Fletcher (1966) propose a projective formulation of the constrained conjugate gradient method to solve the symmetric eigenvalue problem. Fried (1969) proposes a very similar method for application to finite element eigenvalue problems. Chen et al. (1986) are the first to apply this projective conjugate gradient method to the problem of adaptive spectral estimation for signal processing. However, these conjugate gradient algorithms are based upon the classical unconstrained conjugate gradient method on Euclidean space. They apply this algorithm to the constrained problem without accounting for the curvature terms that naturally arise. In general, the superlinear convergence guaranteed by the classical conjugate gradient method is lost in the constrained case when these curvature terms are ignored.

Fuhrmann & Liu (1984) recognize this fact in their constrained conjugate gradient algorithm for maximizing the Rayleigh quotient on a sphere. They correctly utilize the curvature of the sphere to develop a conjugate gradient algorithm on this space analogous to the classical superlinearly convergent conjugate gradient algorithm. Insofar as they use maximization along geodesics on the sphere instead of maximization along lines in \mathbf{R}^n followed by projection, their approach is the first conjugate gradient method employing intrinsic ideas to appear. However, they use an azimuthal projection to identify points on the sphere with points in tangent planes, which is not naturally defined because it depends upon the choice of imbedding. Thus their method is extrinsic. Although the asymptotic performance of their constrained conjugate gradient algorithm is the same as one to be

presented in this thesis, their dependence on azimuthal projection does not generalize to other manifolds. We shall see that completely intrinsic approaches on arbitrary Riemannian manifolds are possible and desirable.

There are many other algorithms for computing the principal invariant subspaces that are required for some methods used in adaptive filtering (Comon & Golub 1990). Of course, one could apply the QR algorithm at each step in the adaptive filtering procedure to obtain a full diagonal decomposition of a symmetric matrix, but this requires $O(n^3)$ floating point operations (n is the dimension of the matrix), which is unnecessarily expensive. Also, many applications require only the principal invariant subspace corresponding to the k largest eigenvalues, thus a full decomposition involves wasted effort. Furthermore, this technique does not exploit previous information, which is important in most adaptive contexts. So other techniques for obtaining the eigenvalue decomposition are used. In addition to the constrained conjugate gradient approaches mentioned in the preceding paragraphs, pure gradient based methods and other iterative techniques are popular. The use of gradient techniques in adaptive signal processing was pioneered in the 1960s. See Widrow & Stearns (1985) for background and references. Several algorithms for the adaptive eigenvalue problem use such gradient ideas (Owsley 1978, Larimore 1983, Hu 1985).

Iterative algorithms such as Lanczos methods are very important in adaptive subspace tracking problems. Lanczos methods compute a sequence of tridiagonal matrices (or bidiagonal matrices in the case where singular vectors are required) whose eigenvalues approximate the extreme eigenvalues of the original matrix. The computational requirements of the classical Lanczos algorithm are modest: only $O(nk^2)$ operations and $O(k)$ matrix-vector multiplications are required to compute k eigenvectors of an n -by- n symmetric matrix. Thus Lanczos methods are well-suited for sparse matrix extreme eigenvalue problems. However, the convergence properties of the classical Lanczos methods are troublesome, and they must be modified to yield useful algorithms (Parlett & Scott 1979, Parlett 1980, Golub & Van Loan 1983, Cullum & Willoughby 1985).

This thesis arose from the study of gradient flows applied to the subspace tracking problem as described by Brockett (1991b), and from the study of gradient flows that diagonalize matrices (Brockett 1991a). While the resulting differential equation models are appealing from the perspective of learning theory, it is computationally impractical to implement them on conventional computers. A desire to avoid the “small step” methods found in the integration of gradient flows while retaining their useful optimization properties led to the investigation of “large step” methods on manifolds, analogous to the optimization

algorithms on Euclidean space discussed above. A theory of such methods was established, and then applied to the subspace tracking problem, whose homogeneous space structure allows efficient and practical optimization algorithms.

The following contributions are contained within this thesis. In Chapter 2, a geometric framework is provided for a large class of problems in numerical linear algebra. This chapter reviews the natural metric structure of various Lie groups and homogeneous spaces, along with some useful formulae implied by this structure, which will be used throughout the thesis. This geometric framework allows one to solve problems in numerical linear algebra, such as the computation of eigenvalues and eigenvectors, and singular values and singular vectors, with gradient flows on Lie groups and homogeneous spaces.

In Chapter 3 a gradient flow that yields the extreme eigenvalues and corresponding eigenvectors of a symmetric matrix is given, together with a gradient flow that yields the singular value decomposition of an arbitrary matrix. (Functions whose gradient flows yield the extreme singular values and corresponding left singular vectors of an arbitrary matrix are also discussed in Chapter 5.)

Chapter 4 develops aspects of the theory of optimization of differentiable functions defined on Riemannian manifolds. New methods and a new point of view for solving constrained optimization problems are provided. Within this chapter, the usual versions of Newton's method and the conjugate gradient method are generalized to yield new optimization algorithms on Riemannian manifolds. The method of steepest descent on a Riemannian manifold is first analyzed. Newton's method on Riemannian manifolds is developed next and a proof of quadratic convergence is given. The conjugate gradient method is then introduced with a proof of superlinear convergence. Several illustrative examples are offered throughout this chapter. These three algorithms are applied to the Rayleigh quotient defined on the sphere, and the function $f(\Theta) = \text{tr } \Theta^T Q \Theta N$ defined on the special orthogonal group. It is shown that Newton's method applied to the Rayleigh quotient converges cubically, and that this procedure is efficiently approximated by the Rayleigh quotient iteration. The conjugate gradient algorithm applied to the Rayleigh quotient on the sphere yields a new superlinearly convergent algorithm for computing the eigenvector corresponding to the extreme eigenvalue of a symmetric matrix, which requires two matrix-vector multiplications and $O(n)$ operations per iteration.

Chapter 5 applies the techniques developed in the preceding chapters to the subspace tracking problem of adaptive signal processing. The idea of tracking a principal invariant subspace is reviewed in this context, and it is shown how this problem may be viewed as

maximization of the generalized Rayleigh quotient on the so-called Stiefel manifold of matrices with orthonormal columns. An efficient conjugate gradient method that solves this optimization problem is developed next. This algorithm, like Lanczos methods, requires $O(nk^2)$ operations per step and $O(k)$ matrix-vector multiplications. This favorable computational cost is dependent on the homogeneous space structure of the Stiefel manifold; a description of the algorithms implementation is provided. Superlinear convergence of this algorithm to the eigenvectors corresponding to the extreme eigenvalues of a symmetric matrix is assured by results of Chapter 4. This algorithm also has the desirable feature of maintaining the orthonormality of the k vectors at each step. A similar algorithm for computing the largest left singular vectors corresponding to the extreme singular values of an arbitrary matrix is discussed. Finally, this algorithm is applied to the subspace tracking problem. A new algorithm for subspace tracking is given, which is based upon the conjugate gradient method applied to the generalized Rayleigh quotient. The results of several numerical experiments demonstrating the tracking properties of this algorithm are given.

CHAPTER 2

RIEMANNIAN GEOMETRY OF LIE GROUPS AND HOMOGENEOUS SPACES

Both the analysis and development of optimization algorithms presented in this thesis rely heavily upon the geometry of the space on which optimization problems are posed. This chapter provides a review of pertinent ideas from differential and Riemannian geometry, Lie groups, and homogeneous spaces that will be used throughout the thesis. It may be skipped by those readers familiar with Riemannian geometry. Sections 1 and 2 contain the necessary theoretical background. Section 3 provides formulae specific to the manifolds to be used throughout this thesis, which are derived from the theory contained in the previous sections.

1. Riemannian manifolds

In this section the concepts of Riemannian structures, affine connections, geodesics, parallel translation, and Riemannian connections on a differentiable manifold are reviewed. A background of differentiable manifolds and tensor fields is assumed, e.g., Chapters 1–5 of Spivak (1979, Vol. 1) or the introduction of Golubitsky & Guillemin (1973). The review follows Helgason's (1978) and Spivak's (1979, Vol. 2) expositions.

Let M be a C^∞ differentiable manifold. Denote the set of C^∞ functions on M by $C^\infty(M)$, the tangent plane at p in M by T_p or T_pM , and the set of C^∞ vector fields on M by $\mathfrak{X}(M)$.

Riemannian structures

Definition 1.1. Let M be a differentiable manifold. A *Riemannian structure* on M is a tensor field g of type $(0, 2)$ which for all $X, Y \in \mathfrak{X}(M)$ and $p \in M$ satisfies

- (i) $g(X, Y) = g(Y, X)$,
- (ii) $g_p: T_p \times T_p \rightarrow \mathbf{R}$ is positive definite.

A *Riemannian manifold* is a connected differentiable manifold with a Riemannian structure. For every p in M , the Riemannian structure g provides an inner product on T_p given by the nondegenerate symmetric bilinear form $g_p: T_p \times T_p \rightarrow \mathbf{R}$. The notation $\langle X, Y \rangle = g_p(X, Y)$ and $\|X\| = g_p(X, X)^{1/2}$, where $X, Y \in T_p$, is often used. Let $t \mapsto \gamma(t)$, $t \in [a, b]$, be a curve segment in M . The length of γ is defined by the formula

$$L(\gamma) = \int_a^b g_{\gamma(t)}(\dot{\gamma}(t), \dot{\gamma}(t))^{1/2} dt.$$

Because M is connected, any two points p and q in M can be joined by a curve. The infimum of the length of all curve segments joining p and q yields a metric on M called the *Riemannian metric* and denoted by $d(p, q)$.

Definition 1.2. Let M be a Riemannian manifold with Riemannian structure g and $f: M \rightarrow \mathbf{R}$ a C^∞ function on M . The *gradient* of f at p , denoted by $(\text{grad} f)_p$, is the unique vector in T_p such that $df_p(X) = \langle (\text{grad} f)_p, X \rangle$ for all X in T_p .

The corresponding vector field $\text{grad} f$ on M is clearly smooth.

The expression of the preceding ideas using coordinates is often useful. Let M be an n -dimensional Riemannian manifold with Riemannian structure g , and (U, x^1, \dots, x^n) a coordinate chart on M . There exist n^2 functions g_{ij} , $1 \leq i, j \leq n$, on U such that

$$g = \sum_{i,j} g_{ij} dx^i \otimes dx^j.$$

Clearly $g_{ij} = g_{ji}$ for all i and j . Because g_p is nondegenerate for all $p \in U \subset M$, the symmetric matrix (g_{ij}) is invertible. The elements of its inverse are denoted by g^{kl} , i.e., $\sum_l g^{il} g_{lj} = \delta^i_j$, where δ^i_j is the Kronecker delta. Furthermore, given $f \in C^\infty(M)$, we have

$$df = \sum_i \left(\frac{\partial f}{\partial x^i} \right) dx^i.$$

Therefore, from the definition of $\text{grad} f$ above, we see that

$$\text{grad} f = \sum_{i,l} g^{il} \left(\frac{\partial f}{\partial x^l} \right) \frac{\partial}{\partial x^i}.$$

Affine connections

Let M be a differentiable manifold. An *affine connection* on M is a function ∇ which assigns to each vector field $X \in \mathfrak{X}(M)$ an \mathbf{R} -linear map $\nabla_X: \mathfrak{X}(M) \rightarrow \mathfrak{X}(M)$ which satisfies

- (i) $\nabla_{fX+gY} = f\nabla_X + g\nabla_Y$,
- (ii) $\nabla_X(fY) = f\nabla_X Y + (Xf)Y$,

for all $f, g \in C^\infty(M)$, $X, Y \in \mathfrak{X}(M)$. The map ∇_X may be applied to tensors of arbitrary type. Let ∇ be an affine connection on M and $X \in \mathfrak{X}(M)$. Then there exists a unique \mathbf{R} -linear map $A \mapsto \nabla_X A$ of C^∞ tensor fields into C^∞ tensor fields which satisfies

- (i) $\nabla_X f = Xf$,
- (ii) $\nabla_X Y$ is given by ∇ ,
- (iii) $\nabla_X(A \otimes B) = \nabla_X A \otimes B + A \otimes \nabla_X B$,
- (iv) ∇_X preserves the type of tensors,
- (v) ∇_X commutes with contractions,

where $f \in C^\infty(M)$, $Y \in \mathfrak{X}(M)$, and A, B are C^∞ tensor fields. If A is of type (k, l) , then $\nabla_X A$, called the *covariant derivative* of A along X , is of type (k, l) , and $\nabla A: X \mapsto \nabla_X A$, called the *covariant differential* of A , is of type $(k, l + 1)$.

The expression of these ideas using coordinates is useful. Let M be an n -dimensional differentiable manifold with affine connection ∇ , and (U, x^1, \dots, x^n) a coordinate chart on M . These coordinates induce the canonical basis $(\partial/\partial x^1), \dots, (\partial/\partial x^n)$ of $\mathfrak{X}(U)$. There exist n^3 functions Γ_{ij}^k , $1 \leq i, j, k \leq n$, on U such that

$$\nabla_{(\partial/\partial x^i)} \frac{\partial}{\partial x^j} = \sum_{i,j,k} \Gamma_{ij}^k \frac{\partial}{\partial x^k}.$$

The Γ_{ij}^k are called the *Christoffel symbols* of the connection.

The convergence proofs of later chapters require an analysis of the second order terms of real-valued functions near critical points. Consider the second covariant differential $\nabla \nabla f = \nabla^2 f$ of a smooth function $f: M \rightarrow \mathbf{R}$. If (U, x^1, \dots, x^n) is a coordinate chart on M , then this $(0, 2)$ tensor takes the form

$$\nabla^2 f = \sum_{i,j} \left(\left(\frac{\partial^2 f}{\partial x^i \partial x^j} \right) - \sum_k \Gamma_{ji}^k \left(\frac{\partial f}{\partial x^k} \right) \right) dx^i \otimes dx^j.$$

Geodesics and parallelism

Let M be a differentiable manifold with affine connection ∇ . Let $\gamma: I \rightarrow M$ be a smooth curve with tangent vectors $X(t) = \dot{\gamma}(t)$, where $I \subset \mathbf{R}$ is an open interval. The curve γ is called a *geodesic* if $\nabla_X X = 0$ for all $t \in I$. Let $Y(t) \in T_{\gamma(t)}$ ($t \in I$) be a smooth family of tangent vectors defined along γ . The family $Y(t)$ is said to be *parallel* along γ if $\nabla_X Y = 0$ for all $t \in I$.

For every p in M and $X \neq 0$ in T_p , there exists a unique geodesic $t \mapsto \gamma_X(t)$ such that $\gamma_X(0) = p$ and $\dot{\gamma}_X(0) = X$. We define the *exponential map* $\exp_p: T_p \rightarrow M$ by $\exp_p(X) =$

$\gamma_X(1)$ for all $X \in T_p$ such that 1 is in the domain of γ_X . Oftentimes the map \exp_p will be denoted by “exp” when the choice of tangent plane is clear, and $\gamma_X(t)$ will be denoted by $\exp tX$. A neighborhood N_p of p in M is a *normal neighborhood* if $N_p = \exp N_0$, where N_0 is a star-shaped neighborhood of the origin in T_p and \exp maps N_0 diffeomorphically onto N_p . Normal neighborhoods always exist.

Given a curve $\gamma: I \rightarrow M$ such that $\gamma(0) = p$, for each $Y \in T_p$ there exists a unique family $Y(t) \in T_{\gamma(t)}$ ($t \in I$) of tangent vectors parallel along γ such that $Y(0) = Y$. If γ joins the points p and $\gamma(\alpha) = q$, the parallelism along γ induces an isomorphism $\tau_{pq}: T_p \rightarrow T_q$ defined by $\tau_{pq}Y = Y(\alpha)$. If $\mu \in T_p^*$, define $\tau_{pq}\mu \in T_q^*$ by the formula $(\tau_{pq}\mu)(X) = \mu(\tau_{pq}^{-1}X)$ for all $X \in T_q$. The isomorphism τ_{pq} can be extended in an obvious way to mixed tensor products of arbitrary type.

Let M be a manifold with an affine connection ∇ , and N_p a normal neighborhood of $p \in M$. Define the vector field \tilde{X} on N_p adapted to the tangent vector X in T_p by putting $\tilde{X}_q = \tau_{pq}X$, the parallel translation of X along the unique geodesic segment joining p and q .

Let (U, x^1, \dots, x^n) be a coordinate chart on an n -dimensional differentiable manifold with affine connection ∇ . Geodesics in U satisfy the n second order nonlinear differential equations

$$\frac{d^2x^k}{dt^2} + \sum_{i,j} \frac{dx^i}{dt} \frac{dx^j}{dt} \Gamma_{ij}^k = 0.$$

For example, geodesics on the imbedded 2-sphere in \mathbf{R}^3 with respect to the connection given by $\Gamma_{ij}^k = \delta_{ij}x^k$ (the Levi-Civita connection on the sphere), $1 \leq i, j, k \leq 3$, are segments of great circles, as shown in Figure 1. Let $t \mapsto \gamma(t)$ be a curve in U , and let $Y = \sum_k Y^k (\partial/\partial x^k)$ be a vector field parallel along γ . Then the functions Y^k satisfy the n first order linear differential equations

$$\frac{dY^k}{dt} + \sum_{i,j} \frac{dx^i}{dt} Y^j \Gamma_{ij}^k = 0.$$

For example, if γ is a segment of a great circle on the sphere, then parallel translation of vectors along γ with respect to the connection given by $\Gamma_{ij}^k = \delta_{ij}x^k$ is equivalent to rotating tangent planes along the great circle. The parallel translation of a vector tangent to the north pole around a geodesic triangle on S^2 is illustrated in Figure 2. Note that the tangent vector obtained by this process is different from the original tangent vector.

Parallel translation and covariant differentiation are related in the following way. Let X be a vector field on M , and $t \mapsto \gamma(t)$ an integral curve of X . Denote the parallelism

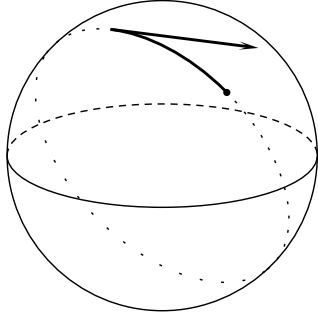

FIGURE 1. Geodesic on a sphere

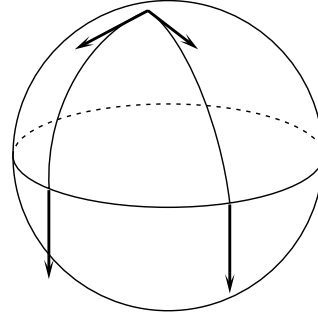

FIGURE 2. Parallel translation on a sphere

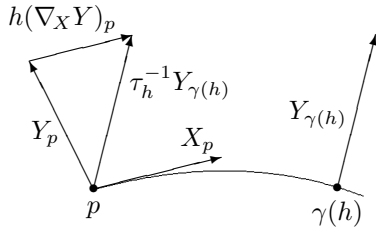

FIGURE 3.

along γ from $p = \gamma(0)$ to $\gamma(h)$, h small, by τ_h . Then for an arbitrary tensor field A on M ,

$$(\nabla_X A)_p = \lim_{h \rightarrow 0} \frac{1}{h} (\tau_h^{-1} A_{\gamma(h)} - A_p). \quad (1)$$

The covariant differentiation of a vector field Y along a vector field X is illustrated in Figure 3 at the left.

Riemannian connections

Given a Riemannian structure g on a differentiable manifold M , there exists a unique affine connection ∇ on M , called the Riemannian or Levi-Civita connection, which for all $X, Y \in \mathfrak{X}(M)$ satisfies

- (i) $\nabla_X Y - \nabla_Y X = [X, Y]$ (∇ is symmetric or torsion-free),
- (ii) $\nabla g = 0$ (parallel translation is an isometry).

Length minimizing curves on M are geodesics of the Levi-Civita connection. We shall use this connection throughout the thesis. For every $p \in M$, there exists a normal neighborhood $N_p = \exp N_0$ of p such that $d(p, \exp_p X) = \|X\|$ for all $X \in N_0$, where d is the Riemannian metric corresponding to g .

If (U, x^1, \dots, x^n) is a coordinate patch on M , then the Christoffel symbols Γ_{ij}^k of the Levi-Civita connection are related to the functions g_{ij} by the formula

$$\Gamma_{ij}^k = \frac{1}{2} \sum_l g^{kl} \left(\frac{\partial g_{li}}{\partial x^j} - \frac{\partial g_{ij}}{\partial x^l} + \frac{\partial g_{jl}}{\partial x^i} \right).$$

By inspection it is seen that $\Gamma_{ij}^k = \Gamma_{ji}^k$.

2. Lie groups and homogeneous spaces

The basic structure of Lie groups and homogeneous spaces is reviewed in this section, which follows Helgason's (1978), Warner's (1983), Cheeger and Ebin's (1975), and Kobayashi and Nomizu's (1969, Chap. 10) expositions.

Lie groups

Definition 2.1. A *Lie group* G is a differentiable manifold and a group such that the map $G \times G \rightarrow G$ defined by $(g, k) \mapsto gk^{-1}$ is C^∞ .

The identity in G will be denoted by e in the general case, and by I if G is a matrix group.

Definition 2.2. A *Lie algebra* \mathfrak{g} over \mathbf{R} is a vector space over \mathbf{R} with a bilinear operation $[\cdot, \cdot]: \mathfrak{g} \times \mathfrak{g} \rightarrow \mathfrak{g}$ (called the *bracket*) such that for all $x, y, z \in \mathfrak{g}$,

- (i) $[x, x] = 0$ (implies anticommutativity),
- (ii) $[x, [y, z]] + [y, [z, x]] + [z, [x, y]] = 0$ (Jacobi identity).

Let G be a Lie group and $g \in G$. Left multiplication by g is denoted by the map $l_g: G \rightarrow G$, $k \mapsto gk$, and similarly for right multiplication $r_g: k \mapsto kg$. Let X be a vector field on G . X is said to be *left invariant* if for each $g \in G$,

$$l_{g*}(X) = X \circ l_g.$$

The notation f_* is used here and elsewhere to denote df , the differential of a map f . Specifically, note that if X is a left invariant vector field, then $X_g = l_{g*}X_e$, i.e., the value of X at any point $g \in G$ is determined by its value at the identity e . Thus there is a one-to-one correspondence between left invariant vector fields on G and tangent vectors in T_eG . Given a finite dimensional Lie group G , the vector space of left invariant vector fields on G or, equivalently, the vector space T_eG , together with the Lie derivative $L_X Y = [X, Y] = XY - YX$ as the bracket operation yields a finite dimensional Lie algebra \mathfrak{g} , in this thesis denoted by a lower-case German letter. We shall define \mathfrak{g} to be the vector space T_eG , and for $X \in \mathfrak{g}$, oftentimes denote the corresponding left invariant vector field by \tilde{X} .

For every element X in \mathfrak{g} , there is a unique homomorphism $\phi: \mathbf{R} \rightarrow G$, called the *one-parameter subgroup* of G generated by X , such that $\dot{\phi}(0) = X$. Define the *exponential map* $\exp: \mathfrak{g} \rightarrow G$ by setting $\exp X = \phi(1)$. The one-parameter subgroup $t \mapsto \phi(t)$ generated by X is denoted by $t \mapsto \exp tX$. For matrix groups, the exponential map corresponds to

matrix exponentiation, i.e., $\exp tX = e^{Xt} = I + tX + (t^2/2!)X^2 + \dots$. It will be seen in the next section in what sense the exponential map for a Lie group is related to the exponential map for a manifold with an affine connection.

Let G be a Lie group with Lie algebra \mathfrak{g} . Consider the action of G on itself by conjugation, i.e., $a: (g, k) \mapsto gkg^{-1}$, which has a fixed point at the identity. Denote the automorphism $k \mapsto gkg^{-1}$ of G by a_g . Define the *adjoint representation* $\text{Ad}: G \rightarrow \text{Aut}(\mathfrak{g})$ by the map $g \mapsto (da_g)_e$, where $\text{Aut}(\mathfrak{g})$ is the group of automorphisms of the Lie algebra \mathfrak{g} . If G is a matrix group with $g \in G$ and $\omega \in \mathfrak{g}$, we have $\text{Ad}(g)(\omega) = g\omega g^{-1}$. Furthermore, we denote the differential of Ad at the identity by ad , i.e.,

$$\text{ad} = d\text{Ad}_e$$

so that $\text{ad}: \mathfrak{g} \rightarrow \text{End}(\mathfrak{g})$ is a map from the Lie algebra \mathfrak{g} to its vector space of endomorphisms $\text{End}(\mathfrak{g})$. The notation $\text{Ad}_g = \text{Ad}(g)$ ($g \in G$) and $\text{ad}_X = \text{ad}(X)$ ($X \in \mathfrak{g}$) is often used. It may be verified that $\text{ad}_X Y = [X, Y]$ for X and Y in \mathfrak{g} . If G is a matrix group, then $\text{ad}_X Y = XY - YX$. The functions $\text{Ad}: G \rightarrow \text{Aut}(\mathfrak{g})$ and $\text{ad}: \mathfrak{g} \rightarrow \text{End}(\mathfrak{g})$ are related by

$$\text{Ad} \circ \exp = \exp \circ \text{ad},$$

i.e., for $X \in \mathfrak{g}$, $\text{Ad}_{\exp X} = e^{\text{ad}_X}$.

Definition 2.3. Let \mathfrak{g} be a Lie algebra. The *Killing form* of \mathfrak{g} is the bilinear form φ on $\mathfrak{g} \times \mathfrak{g}$ defined by

$$\varphi(X, Y) = \text{tr}(\text{ad}_X \circ \text{ad}_Y).$$

Homogeneous spaces

Let G be a Lie group and H a closed subgroup of G . Then the (left) *coset space* $G/H = \{gH : g \in G\}$ admits the structure of a differentiable manifold such that the natural projection $\pi: G \rightarrow G/H$, $g \mapsto gH$, and the action of G on G/H defined by $(g, kH) \mapsto gkH$ are C^∞ . The dimension of G/H is given by $\dim G/H = \dim G - \dim H$. Define the origin of G/H by $o = \pi(e)$.

Definition 2.4. Let G be a Lie group and H a closed subgroup of G . The differentiable manifold G/H is called a *homogeneous space*.

Let \mathfrak{g} and \mathfrak{h} be the Lie algebras of G and H , respectively, and let \mathfrak{m} be a vector subspace of \mathfrak{g} such that $\mathfrak{g} = \mathfrak{m} + \mathfrak{h}$ (direct sum). Then there exists a neighborhood of $0 \in \mathfrak{m}$ which

is mapped homeomorphically onto a neighborhood of the origin $o \in G/H$ by the mapping $\pi \circ \exp|_{\mathfrak{m}}$. The tangent plane $T_o(G/H)$ at the origin can be identified with the vector subspace \mathfrak{m} .

Definition 2.5. A Lie transformation group G acting on a differentiable manifold M is a Lie group G which acts on M (on the left) such that (i) every element $g \in G$ induces a diffeomorphism of M onto itself, denoted by $p \mapsto g \cdot p$ or $p \mapsto l_g(p)$, (ii) the map from $G \times M$ to M defined by $(g, p) \mapsto g \cdot p$ is C^∞ , and (iii) $g \cdot (k \cdot p) = gk \cdot p$ for $p \in M$, $g, k \in G$ (the action is transitive).

For example, the Lie group G is clearly a Lie transformation group of the homogeneous space G/H .

The action of G on M is said to be *effective* if for any $g \in G$, $l_g = \text{id}$ on M implies that $g = e$. Define the *isotropy group* H_p at p in M by

$$H_p = \{g \in G : g \cdot p = p\}.$$

The isotropy group at p is a closed subgroup of G , and the mapping

$$g \cdot p \mapsto gH_p$$

of M onto G/H_p is a diffeomorphism. Therefore, we can identify M with the homogeneous space G/H_p . Note that H_p is not uniquely determined by M , as it may be replaced by $H_{g \cdot p} = gH_p g^{-1}$ for any g in G . The element g in G is called a *coset representative* of the point $g \cdot p$ in M and the point gH in G/H . Every element h in H_p fixes p , and therefore induces a linear transformation $(dl_h)_p$ on the tangent plane $T_p M$. The set $\tilde{H}_p = \{(dl_h)_p : h \in H_p\}$ is called the *linear isotropy group* at p .

Let G/H be a homogeneous space of G , and $\pi: G \rightarrow G/H$ the natural projection. The tangent plane $T_o(G/H)$ at the origin $o = \pi(e)$ may be identified with the quotient space $\mathfrak{g}/\mathfrak{h}$, because for any function $f \in C^\infty(G/H)$,

$$\bar{f}_*(\mathfrak{h}) = 0,$$

where \bar{f} is the unique lift in $C^\infty(G)$ such that $\bar{f} = f \circ \pi$. A tensor field A on G/H is G -invariant if and only if A_o is invariant under the linear isotropy group at o , thus a computation of the map $l_{h*}: T_o \rightarrow T_o$ is desirable. Let $\bar{l}_g: G \rightarrow G$ and $l_g: G/H \rightarrow G/H$ denote left translation by $g \in G$. Note that

$$l_g \circ \pi = \pi \circ \bar{l}_g, \tag{2}$$

and for any $h \in H$, $g \in G$, $\pi(hg) = \pi(hgh^{-1})$, i.e.,

$$\pi \circ \bar{l}_h = \pi \circ a_h, \quad (3)$$

where a_h denotes conjugation by h . Therefore, by applying Equation (2) to Equation (3) and evaluating the differential of both sides at the identity e , it is seen that

$$l_{h*} \circ \pi_* = \pi_* \circ \text{Ad}_h,$$

i.e., the action of l_{h*} on T_o corresponds to the action of Ad_h on \mathfrak{g} , which in turn corresponds to the action of Ad_h on $\mathfrak{g}/\mathfrak{h}$ because \mathfrak{h} is Ad_H -invariant.

Let M be a differentiable manifold, and G a Lie transformation of M . To every $X \in \mathfrak{g}$, there corresponds a unique vector field \tilde{X} on M defined by the equation

$$(\tilde{X}f)_p = \left. \frac{d}{dt} \right|_{t=0} f(\exp tX \cdot p) \quad (4)$$

for $f \in C^\infty(M)$. The vector field \tilde{X} on M is said to be *induced* by the one-parameter subgroup $\exp tX$. For $p_0 \in M$, $g \in G$, note that

$$\tilde{X}_{g \cdot p_0} = (l_{g*} \circ \pi_* \circ \text{Ad}_{g^{-1}})(X), \quad (5)$$

where π is the projection $g \mapsto g \cdot p_0$ from G onto M . Thus \tilde{X} is not left invariant in general. Equation (5) will be useful when specific vector fields on homogeneous spaces are considered. Furthermore, if \tilde{X} and \tilde{Y} are vector fields on M induced by X and Y in \mathfrak{g} , then

$$[\tilde{X}, \tilde{Y}] = -[\widetilde{[X, Y]}].$$

Definition 2.6. Let G be a connected Lie group, H a closed subgroup of G , and \mathfrak{g} and \mathfrak{h} the Lie algebras of G and H , respectively. The homogeneous space G/H is said to be *reductive* if there exists a vector subspace \mathfrak{m} of \mathfrak{g} such that $\mathfrak{g} = \mathfrak{m} + \mathfrak{h}$ (direct sum), and \mathfrak{m} is Ad_H -invariant, i.e., $\text{Ad}_H(\mathfrak{m}) \subset \mathfrak{m}$.

For example, the homogeneous space G/H is reductive if H is compact. Our interest in reductive homogeneous spaces lies solely with this class of examples; for others, see Nomizu (1954) or Kobayashi & Nomizu (1969, Chap. 10).

Invariant affine connections

Definition 2.7. Let G be a Lie transformation group acting on a differentiable manifold M . An affine connection ∇ on M is said to be G -invariant if for all $g \in G$, $X, Y \in \mathfrak{X}(M)$,

$$l_{g*}(\nabla_X Y) = \nabla_{(l_{g*}X)}(l_{g*}Y).$$

If $M = G$ is a Lie group with Lie algebra \mathfrak{g} , we have the following useful classification. Let \tilde{X} and \tilde{Y} be left invariant vector fields on G corresponding to X and $Y \in \mathfrak{g}$, respectively. There is a one-to-one correspondence between invariant affine connections on G and the set of bilinear functions $\alpha: \mathfrak{g} \times \mathfrak{g} \rightarrow \mathfrak{g}$ given by the formula

$$\alpha(X, Y) = (\nabla_{\tilde{X}} \tilde{Y})_e.$$

Geodesics on G coincide with one-parameter subgroups if and only if $\alpha(X, X) = 0$ for all $X \in \mathfrak{g}$. The classical Cartan-Schouten invariant affine connections on G correspond to $\alpha(X, Y) \equiv 0$ (the $(-)$ -connection), $\alpha(X, Y) = \frac{1}{2}[X, Y]$ (the (0) -connection), and $\alpha(X, Y) = [X, Y]$ (the $(+)$ -connection).

Let G/H be a reductive homogeneous space with a fixed decomposition of the Lie algebra $\mathfrak{g} = \mathfrak{m} + \mathfrak{h}$, $\text{Ad}_H(\mathfrak{m}) \subset \mathfrak{m}$, and $\pi: G \rightarrow G/H$ the natural projection. Any element $X \in \mathfrak{g}$ can be uniquely decomposed into the sum of elements in \mathfrak{m} and \mathfrak{h} , which will be denoted by $X_{\mathfrak{m}}$ and $X_{\mathfrak{h}}$, respectively. There is a one-to-one correspondence between invariant affine connections on G/H and the set of bilinear functions $\alpha: \mathfrak{m} \times \mathfrak{m} \rightarrow \mathfrak{m}$ which are Ad_H -invariant, i.e., $\text{Ad}_h \cdot \alpha(X, Y) = \alpha(\text{Ad}_h X, \text{Ad}_h Y)$ for all $X, Y \in \mathfrak{m}$, $h \in H$.

Let $t \mapsto \exp tX$ be the one-parameter subgroup generated by X in \mathfrak{m} , and denote the curve $t \mapsto \pi(\exp tX)$ in G/H by $t \mapsto \gamma_X(t)$. In addition to the requirement that the connection be complete, consider the following conditions on the invariant affine connection on G/H .

(a) The curve γ_X is a geodesic in G/H .

(b) Parallel translation of the tangent vector $Y \in T_o$ corresponding to $y \in \mathfrak{m}$ along the curve γ_X is given by the differential of $\exp tX$ acting on G/H .

Nomizu (1954) established the following results concerning invariant affine connections on reductive homogeneous spaces. Recall that the *torsion* of a connection ∇ on a manifold M is a tensor T of type $(1, 2)$ defined by $T(X, Y) = \nabla_X Y - \nabla_Y X - [X, Y]$, $X, Y \in \mathfrak{X}(M)$. The connection is said to be torsion-free if $T \equiv 0$.

Theorem 2.8 (Nomizu). *On a reductive homogeneous space G/H , there exists a unique invariant connection which is torsion-free and satisfies (a). It is defined by the function $\alpha(X, Y) = \frac{1}{2}[X, Y]_{\mathfrak{m}}$ on $\mathfrak{m} \times \mathfrak{m}$.*

This connection is called the *canonical torsion-free connection* on G/H with respect to the fixed decomposition $\mathfrak{g} = \mathfrak{m} + \mathfrak{h}$. In the case of a Lie group, it is the Cartan-Schouten (0)-connection.

Theorem 2.9 (Nomizu). *On a reductive homogeneous space G/H , there exists a unique invariant connection which satisfies (b). It is defined by the function $\alpha(X, Y) \equiv 0$ on $\mathfrak{m} \times \mathfrak{m}$.*

This connection is called the *canonical connection* on G/H with respect to the fixed decomposition $\mathfrak{g} = \mathfrak{m} + \mathfrak{h}$. In the case of a Lie group, it is the Cartan-Schouten (−)-connection.

If G/H is a *symmetric* homogeneous space, then these two connections coincide. (See Helgason (1978), Kobayashi & Nomizu (1969), or Wolf (1984) for background on symmetric spaces.) From the point of view of the applications we have in mind, the choice of the canonical torsion-free connection on G/H facilitates the computation of geodesics on G/H . The choice of the canonical connection on G/H facilitates the computation of parallel translation along curves of the form $t \mapsto \pi(\exp tX)$. In the case of a symmetric space, the canonical connection allows both the computation of geodesics and parallel translation along geodesics by conditions (a) and (b) above.

Invariant Riemannian metrics

Definition 2.10. Let G be a Lie transformation group acting on a differentiable manifold M . A tensor field A on M is said to be *G -invariant* if for all $g \in G$, $p \in M$,

$$l_{g*}(A) = A \circ l_g.$$

In particular, a Riemannian structure g on M is said to be (left) *invariant* if it is G -invariant as a tensor field on G/H . That is,

$$g_{k \cdot p}(l_{k*}X, l_{k*}Y) = g_p(X, Y)$$

for all $p \in M$, $k \in G$, $X, Y \in T_p$. In the case of a Lie group G , a *bi-invariant* metric on G is a Riemannian structure on G that is invariant with respect to the left and right action of G on itself.

There may not exist an invariant Riemannian metric on the homogeneous space G/H ; however, Cheeger & Ebin (1975) provide a proposition that describes the invariant metric structure of all homogeneous spaces considered in this thesis. The following proposition paraphrases Proposition 3.16 of Cheeger and Ebin.

Proposition 2.11. (1) *The set of G -invariant metrics on G/H is naturally isomorphic to the set of bilinear forms $\langle \cdot, \cdot \rangle$ on $\mathfrak{g}/\mathfrak{h} \times \mathfrak{g}/\mathfrak{h}$ which are Ad_H -invariant.*

(2) *If H is connected, the bilinear form $\langle \cdot, \cdot \rangle$ on $\mathfrak{g}/\mathfrak{h} \times \mathfrak{g}/\mathfrak{h}$ is Ad_H -invariant if and only if for all $\eta \in \mathfrak{h}$, ad_η is skew-symmetric with respect to $\langle \cdot, \cdot \rangle$.*

(3) *If G acts effectively on G/H , then G/H admits an invariant metric if and only if the closure of the group Ad_H in $\text{Aut}(\mathfrak{g})$, the group of automorphisms of \mathfrak{g} , is compact.*

(4) *If G acts effectively on G/H and G/H is reductive with the fixed decomposition $\mathfrak{g} = \mathfrak{m} + \mathfrak{h}$, then there is a one-to-one correspondence between G -invariant metrics on G/H and Ad_H -invariant bilinear forms on $\mathfrak{m} \times \mathfrak{m}$. If G/H admits a left invariant metric, then G admits a left invariant metric which is right invariant with respect to H ; the restriction of this metric to H is bi-invariant.*

Setting $\mathfrak{m} = \mathfrak{h}^\perp$ provides such a decomposition.

(5) *If H is connected, then the condition $\text{Ad}_H(\mathfrak{m}) \subset \mathfrak{m}$ is equivalent to $[\mathfrak{h}, \mathfrak{m}] \subset \mathfrak{m}$.*

Let G be a Lie group which admits a bi-invariant metric $\langle \cdot, \cdot \rangle$. Then there is a corresponding left invariant metric, called the *normal* metric, on the homogeneous space G/H with fixed decomposition $\mathfrak{g} = \mathfrak{m} + \mathfrak{h}$, $\mathfrak{m} = \mathfrak{h}^\perp$, arising from the restriction of $\langle \cdot, \cdot \rangle$ to \mathfrak{m} . For example, let G be a compact semisimple Lie group with Lie algebra \mathfrak{g} . The Killing form φ of \mathfrak{g} is negative definite; therefore, $-\varphi$ naturally defines an invariant Riemannian metric on G . The Levi-Civita connection of this metric is the (0)-connection of G . Let H be a closed subgroup of G such that G acts effectively on G/H . Then setting $\mathfrak{m} = \mathfrak{h}^\perp$ with respect to $-\varphi$ yields a subspace \mathfrak{m} of \mathfrak{g} such that $\text{Ad}_H(\mathfrak{m}) \subset \mathfrak{m}$, i.e., G/H is a reductive homogeneous space. Furthermore, $-\varphi$ restricted to \mathfrak{m} yields an Ad_H -invariant bilinear form on $\mathfrak{m} \times \mathfrak{m}$ and therefore yields a left invariant Riemannian metric on G/H . The Levi-Civita connection of this metric is the canonical torsion-free connection on G/H .

Formulae for geodesics and parallel translation along geodesics

Let G be a Lie group with the (0)-connection, \mathfrak{g} the Lie algebra of G , and X a left invariant vector field on G corresponding to $x \in \mathfrak{g}$. Then the unique geodesic in G emanating from

g in direction X_g is given by the curve $t \mapsto \gamma(t)$, where

$$\gamma(t) = g \exp tx.$$

Let $t \mapsto \gamma_x(t)$ be the geodesic in G emanating from the identity e with direction $x \in \mathfrak{g}$, and let $Y(t)$ be the parallel translation of $y \in \mathfrak{g}$ from e to $\exp tX$ along γ_x . Then

$$Y(t) = l_{e^{xt}*} \text{Ad}_{e^{-\frac{t}{2}x}}(y), \quad (6)$$

where $e^x = \exp x$. For computations involving vector fields on G , it is oftentimes convenient to represent a tangent vector X_g in $T_g G$ ($g \in G$) by a corresponding element x_g in \mathfrak{g} defined by the equation $X_g = l_{g*} x_g$. Letting $y(t) \in \mathfrak{g}$ correspond to $Y(t) \in T_{e^{xt}} G$ in this way, it is seen that

$$y(t) = \text{Ad}_{e^{-\frac{t}{2}x}}(y). \quad (7)$$

Let G be a Lie group with bi-invariant metric g also denoted by $\langle \cdot, \cdot \rangle$, and G/H a reductive homogeneous space with the normal metric and the fixed decomposition $\mathfrak{g} = \mathfrak{m} + \mathfrak{h}$, $\mathfrak{m} = \mathfrak{h}^\perp$. Denote the natural projection from G onto G/H by π and let $o = \pi(e)$ be the origin in G/H . We wish to compute a formula for parallel translation along geodesics in G/H . To do this, we view G as principal fiber bundle over G/H with structure group H , i.e., we consider the fiber bundle $G(G/H, H)$ with its canonical torsion-free connection (Kobayashi & Nomizu 1969, Chap. 1, § 5; Chap. 2).

For every element $x \in \mathfrak{m}$, there is a unique element $X_o \in T_o(G/H)$ given by Equation (4). For t small enough, define the vector field X along the geodesic $t \mapsto \exp tx \cdot o$ in G/H by setting $X_{e^{xt}} = l_{e^{xt}*} X_o$. There is a unique horizontal lift $\bar{X} \in \mathfrak{X}(G)$ of a smooth extension of X . Let Y be a parallel vector field along the geodesic $t \mapsto \exp(tx) \cdot o$ and denote Y evaluated at the point $\exp(tx) \cdot o$ by $Y(t)$. For each $t \in \mathbf{R}$, define $Y_o(t) \in T_o(G/H)$ and $y(t) \in \mathfrak{m}$ by the equation

$$Y(t) = l_{e^{xt}*} Y_o(t),$$

such that $Y_o(t)$ corresponds to $y(t)$. Let $\bar{Y} \in \mathfrak{X}(G)$ be the horizontal lift a smooth extension of Y , and let \bar{Z} be the horizontal lift in $\mathfrak{X}(G)$ of a smooth extension of the vector field Z along $t \mapsto \exp tx \cdot o$ defined by $Z_{e^{xt}} = l_{e^{xt}*} Z_o$, where $Z_o \in T_o(G/H)$ corresponds to $z \in \mathfrak{m}$. The projection onto the horizontal and vertical components in $\mathfrak{X}(G)$ will be denoted by superscript H and V , respectively, i.e., the vector field $A \in \mathfrak{X}(G)$ decomposes uniquely as $A = A^H + A^V$. At the identity, the horizontal and vertical components of $\mathfrak{X}(G)$ coincide with the \mathfrak{m} -component and \mathfrak{h} -component of \mathfrak{g} , respectively. The projection of \mathfrak{g} onto these

components will be denoted by a subscript \mathfrak{m} and \mathfrak{h} , respectively, i.e., $x \in \mathfrak{g}$ decomposes uniquely as $x = x_{\mathfrak{m}} + x_{\mathfrak{h}}$.

By the definition of the Levi-Civita connection, we have

$$X\langle Y, Z \rangle = \langle \nabla_X Y, Z \rangle + \langle Y, \nabla_X Z \rangle. \quad (8)$$

It is seen that

$$X\langle Y, Z \rangle = \langle dy/dt, z \rangle \quad (9)$$

by the chain of equalities

$$\begin{aligned} (X\langle Y, Z \rangle)_{e^{xt} \cdot o} &= (d/dt) g_{e^{xt} \cdot o}(l_{e^{xt}*} Y_o(t), l_{e^{xt}*} Z_o) \\ &= (d/dt) g_o(Y_o(t), Z_o) \\ &= (d/dt) \langle y(t), z \rangle. \end{aligned}$$

The vector field Y is parallel along the geodesic; therefore,

$$\nabla_X Y = 0 \quad (10)$$

by definition. Computing the rightmost term of Equation (8), we find that

$$\begin{aligned} \langle Y, \nabla_X Z \rangle &= \langle \bar{Y}, \overline{\nabla_X Z} \rangle \\ &= \langle \bar{Y}, \nabla_{\bar{X}} \bar{Z} - \frac{1}{2}[\bar{X}, \bar{Z}]^V \rangle \quad (\text{cf. Cheeger and Ebin, p. 67}) \\ &= \langle \bar{Y}, \frac{1}{2}[\bar{X}, \bar{Z}] - \frac{1}{2}[\bar{X}, \bar{Z}]^V \rangle \\ &= \langle \bar{Y}, \frac{1}{2}[\bar{X}, \bar{Z}]^H \rangle \\ &= \langle y, \frac{1}{2}[x, z]_{\mathfrak{m}} \rangle \\ &= \langle -\frac{1}{2}[x, y]_{\mathfrak{m}}, z \rangle. \end{aligned} \quad (11)$$

Combining Equations (8), (9), (10), and (11), we have proved:

Proposition 2.12. *Let $M = G/H$ be a reductive homogeneous space which admits an invariant metric $\langle \cdot, \cdot \rangle$ and which has the fixed decomposition $\mathfrak{g} = \mathfrak{m} + \mathfrak{h}$, $\mathfrak{m} = \mathfrak{h}^\perp$. Denote the origin of M by $o = \pi(e)$, where $\pi: G \rightarrow M$ is the natural projection. Let x and y_0 be vectors in \mathfrak{m} corresponding to the tangent vectors X and Y_0 in $T_o(G/H)$. The parallel translation $Y(t)$ of Y_0 along the geodesic $t \mapsto \exp_o tX = e^{xt} \cdot o$ in M is given in the following way. Define $Y_o(t) \in T_o(G/H)$ by the equation $Y(t) = l_{e^{xt}*} Y_o(t)$, and let $y(t) \in \mathfrak{m}$ correspond to $Y_o(t) \in T_o(G/H)$. The vector $y(t)$ satisfies the ordinary linear differential equation*

$$\dot{y} = -\frac{1}{2}[x, y]_{\mathfrak{m}}; \quad y(0) = y_0. \quad (12)$$

In the case of a Lie group $M = G$, we may take $\mathfrak{m} = \mathfrak{g}$; thus Equation (12) reduces to

$$\dot{y} = -\frac{1}{2}[x, y]; \quad y(0) = y_0 \in \mathfrak{g},$$

whose solution is given by Equation (7). In the case where G/H is a symmetric space, the decomposition $\mathfrak{g} = \mathfrak{m} + \mathfrak{h}$ satisfies the properties

$$[\mathfrak{m}, \mathfrak{m}] \subset \mathfrak{h}, \quad [\mathfrak{h}, \mathfrak{m}] \subset \mathfrak{m}, \quad [\mathfrak{h}, \mathfrak{h}] \subset \mathfrak{h}.$$

Therefore $\dot{y} \equiv 0$ because the \mathfrak{m} -component of $[x, y]$ vanishes. Thus $y(t) \equiv y_0$.

3. Examples

The orthogonal group

The *general linear group* $GL(n)$ is the set of all real n -by- n invertible matrices. $GL(n)$ is easily verified to be a Lie group of dimension n^2 whose Lie algebra $\mathfrak{gl}(n)$ is the vector space of all n -by- n matrices with bracket $[X, Y] = XY - YX$. The *orthogonal group* $O(n)$ is the subgroup of $GL(n)$ given by

$$O(n) = \{ \Theta \in GL(n) : \Theta^T \Theta = I \}.$$

It is well-known that $O(n)$ is a Lie group of dimension $n(n-1)/2$ with two connected components. The identity component of $O(n)$ is called the *special orthogonal group* $SO(n)$, which is defined by

$$SO(n) = \{ \Theta \in GL(n) : \Theta^T \Theta = I, \det \Theta = 1 \}.$$

The Lie algebra of $SO(n)$, denoted by $\mathfrak{so}(n)$, is the set of all n -by- n skew-symmetric matrices, i.e.,

$$\mathfrak{so}(n) = \{ \Omega \in \mathfrak{gl}(n) : \Omega + \Omega^T = 0 \}.$$

The orthogonal group is the group of all isometries of the vector space \mathbf{R}^n (endowed with the standard inner product $\langle x, y \rangle = x^T y = \sum_i x^i y^i$) which fix the origin. The special orthogonal group is the group of all orientation preserving isometries of \mathbf{R}^n which fix the origin.

The orthogonal group $O(n)$ is compact, and therefore admits a bi-invariant metric, which is given by the negative of the Killing form of $\mathfrak{so}(n)$. A computation shows that for $X, Y \in \mathfrak{so}(n)$,

$$\varphi(X, Y) = \text{tr}(\text{ad}_X \circ \text{ad}_Y) = (n-2) \text{tr} XY, \quad (13)$$

where the first trace is the trace of endomorphisms of $\mathfrak{so}(n)$, and the second trace is the trace of n -by- n matrices. In case $n = 2$, take the bilinear form $(X, Y) \mapsto \text{tr } XY$. Furthermore, $\mathbf{O}(n)$ is semisimple, therefore $-\varphi$ is positive definite and thus defines a bi-invariant metric on $\mathbf{O}(n)$. This is the natural bi-invariant metric on $\mathbf{O}(n)$.

The Levi-Civita connection of this metric is the (0)-connection. The unique geodesic in $\mathbf{O}(n)$ emanating from the identity I in direction $X \in \mathfrak{so}(n)$ is given by the formula

$$t \mapsto e^{Xt}, \quad (14)$$

where $e^{Xt} = I + tX + (t^2/2!)X^2 + \dots$ denotes matrix exponentiation of X . Because the (0)-connection is invariant, geodesics anywhere on $\mathbf{O}(n)$ may be obtained by left translation of geodesics emanating from the identity. The parallel translation $Y(t)$ of a tangent vector $Y_0 \in \mathfrak{so}(n)$ along the geodesic $t \mapsto e^{Xt}$ is given by the formula

$$Y_0(t) = e^{-\frac{t}{2}X} Y_0 e^{\frac{t}{2}X}, \quad (15)$$

where $Y(t) \in T_{e^{Xt}}$ corresponds to $Y_0(t) \in \mathfrak{so}(n)$ via left translation by e^{Xt} , i.e., $Y(t) = e^{Xt} Y_0(t)$. This formula may be used to compute the parallel translation along any geodesic in $\mathbf{O}(n)$ by the invariance of the canonical connection. Thus both geodesics in $\mathbf{O}(n)$ and parallel translation along geodesics in $\mathbf{O}(n)$ may be computed via matrix exponentiation of skew-symmetric matrices, for which there exist stable efficient algorithms (Ward & Gray 1978a, 1978b).

The sphere

Endow \mathbf{R}^n with the standard inner product $\langle x, y \rangle = x^T y = \sum_i x^i y^i$. The $(n - 1)$ -sphere S^{n-1} is an imbedded manifold in \mathbf{R}^n defined by

$$S^{n-1} = \{ x \in \mathbf{R}^n : x^T x = 1 \}.$$

The standard inner product on \mathbf{R}^n induces a Riemannian metric on S^{n-1} . As is well-known, geodesics on the sphere are great circles and parallel translation along a geodesic is equivalent to rotating the tangent plane along the corresponding great circle. The tangent plane of the sphere at x in S^{n-1} is characterized by

$$T_x S^{n-1} = \{ v \in \mathbf{R}^n : x^T v = 0 \}.$$

Let $x \in S^{n-1}$, and let $h \in T_x$ be any tangent vector at x having unit length, i.e., $h^T h = 1$, and $v \in T_x$ any tangent vector. Then the unique geodesic in S^{n-1} emanating from x in

direction h , the parallel translation of h along this geodesic, and the parallel translation of v along this geodesic are given by the equations

$$\begin{aligned}\exp_x th &= x \cos t + h \sin t, \\ \tau h &= h \cos t - x \sin t, \\ \tau v &= v - (h^\top v)(x \sin t + h(1 - \cos t)),\end{aligned}$$

where τ is the parallelism along the geodesic $t \mapsto \exp th$.

The special orthogonal group $\mathbf{SO}(n)$ is a Lie transformation group of the sphere S^{n-1} . At any point on the sphere, say $(1, 0, \dots, 0)$, there is a closed subgroup $\mathbf{SO}(n-1)$ of $\mathbf{SO}(n)$ that fixes this point. Therefore, we may make the identification

$$S^{n-1} \cong \mathbf{SO}(n)/\mathbf{SO}(n-1).$$

In fact, the homogeneous space $\mathbf{SO}(n)/\mathbf{SO}(n-1)$ is a symmetric space. We do not use the homogeneous space structure of the sphere explicitly in this thesis, although the sphere is a special case in the next example to be consider. The symmetric space structure of the sphere is described by Kobayashi & Nomizu (1969, Chap. 11, § 10).

The Stiefel manifold

The compact *Stiefel manifold* $V_{n,k}$ is defined to be the set of all real n -by- k matrices, $k \leq n$, with orthonormal columns, i.e.,

$$V_{n,k} = \{U \in \mathbf{R}^{n \times k} : U^\top U = I\}.$$

Note that $V_{n,n} = \mathbf{O}(n)$ and $V_{n,1} = S^{n-1}$. The orthogonal group $\mathbf{O}(n)$ is naturally a Lie transformation group of $V_{n,k}$ where the group action is given by matrix multiplication on the left, i.e., $(\Theta, U) \mapsto \Theta U$. Fix the origin $o = \begin{pmatrix} I \\ 0 \end{pmatrix}$ in $V_{n,k}$. The isotropy group H of this action at the point o is the closed subgroup

$$H = \left\{ \begin{pmatrix} I & 0 \\ 0 & h \end{pmatrix} \in \mathbf{SO}(n) : h \in \mathbf{SO}(n-k) \right\}.$$

Thus the Stiefel manifold $V_{n,k}$ may be identified with the homogeneous space given by

$$V_{n,k} \cong \mathbf{O}(n)/\mathbf{O}(n-k),$$

which is a differentiable manifold of dimension $k(k-1)/2 + (n-k)k$.

For notational convenience, set $M = V_{n,k}$, $G = \mathbf{O}(n)$, and $H = \mathbf{O}(n-k)$ the isotropy group at $o = \begin{pmatrix} I \\ 0 \end{pmatrix}$ in M . The Lie group G has a bi-invariant metric, and acts transitively

and effectively on M ; therefore, the homogeneous space G/H is reductive with the fixed decomposition $\mathfrak{g} = \mathfrak{m} + \mathfrak{h}$, where

$$\mathfrak{g} = \mathfrak{so}(n)$$

is the Lie algebra of G ,

$$\mathfrak{h} = \left\{ \begin{pmatrix} 0 & 0 \\ 0 & \omega \end{pmatrix} \in \mathfrak{so}(n) : \omega \in \mathfrak{so}(n-k) \right\}$$

is the Lie algebra of H , and $\mathfrak{m} = \mathfrak{h}^\perp$ is the vector subspace

$$\mathfrak{m} = \left\{ \begin{pmatrix} a & -b^T \\ b & 0 \end{pmatrix} \in \mathfrak{so}(n) : a \in \mathfrak{so}(k) \right\}.$$

Let H_p denote the isotropy group of an arbitrary point $p \in M$, and let g be a coset representative of $p = g \cdot o$. Then, as seen above, $H_p = gH_o g^{-1}$. We identify tangent vectors in $T_p M$ with elements of \mathfrak{m} in the following way. Let \mathfrak{h}_p denote the Lie algebra of H_p , and set $\mathfrak{m}_p = \mathfrak{h}_p^\perp$. Then we have the decomposition $\mathfrak{g} = \mathfrak{m}_p + \mathfrak{h}_p$ (direct sum). Clearly,

$$\mathfrak{m}_p = \text{Ad}_g(\mathfrak{m}), \quad \mathfrak{h}_p = \text{Ad}_g(\mathfrak{h}).$$

An element x in \mathfrak{m} corresponds to an element x_p in \mathfrak{m}_p by the equation $x_p = \text{Ad}_g(x)$; the element x_p induces a tangent vector X in $T_p M$ by the equation $Xf = (d/dt)_{t=0} f(e^{x_p t} \cdot p)$ for any f in $C^\infty(M)$. Combining these ideas, it is seen that X is defined by

$$Xf = \left. \frac{d}{dt} \right|_{t=0} f(e^{x_p t} g \cdot o) = \left. \frac{d}{dt} \right|_{t=0} f(g e^{x t} \cdot o).$$

It is important to note that this identification of elements $x \in \mathfrak{m}$ with tangent vectors $X \in T_p M$ depends upon the choice of coset representative g . The reason for making this identification will be clear when we consider in Chapter 5, Section 2, the computational aspects of computing geodesics in $V_{n,k}$.

The negative of the Killing form of \mathfrak{g} restricted to \mathfrak{m} yields an invariant Riemannian metric on M . The Levi-Civita connection of this metric coincides with the canonical torsion-free affine connection of G/H . Let p be a point in M , g a coset representative of p such that $p = g \cdot o$, and X a tangent vector in $T_p M$ corresponding to the element x in \mathfrak{m} as described in the preceding paragraph. Then the unique geodesic emanating from p in direction X is given by

$$t \mapsto g e^{x t} \cdot o.$$

Thus geodesics in $V_{n,k}$ may be computed by matrix exponentiation of elements in \mathfrak{m} . However, the Stiefel manifold is not a symmetric space, so parallel translation along geodesics

may not be computed as easily as in the previous examples. Indeed, partition any element x in \mathfrak{m} as

$$x = \begin{pmatrix} x_1 & -x_2^T \\ x_2 & 0 \end{pmatrix}, \quad x_1 \text{ in } \mathfrak{so}(k).$$

The parallel translation of a tangent vector in T_oM corresponding to $y_0 \in \mathfrak{m}$ along the geodesic $t \mapsto e^{xt} \cdot o$ is given by Equation (12). In the case of the Stiefel manifold, and after rescaling the parameter t by $-1/2$, this equation becomes the pair coupled linear differential equations

$$\begin{aligned} \dot{y}_1 &= [x_1, y_1] + y_2^T x_2 - x_2^T y_2 & y_1(0) &= \text{given}, \\ \dot{y}_2 &= x_2 y_1 - y_2 x_1 & y_2(0) &= \text{given}. \end{aligned} \tag{16}$$

In the case $k = n$, i.e., $V_{n,n} = \mathbf{O}(n)$, the linear operator $y \mapsto [x, y]$ of $\mathfrak{so}(n)$ onto itself has eigenvalues $\lambda_i - \lambda_j$, $1 \leq i, j \leq n$, where the λ_i are the eigenvalues of the skew-symmetric matrix x . Thus the differential equation in (16) has the relatively simple solution given by Equation (15). In the case $k = 1$, i.e., $V_{n,1} = S^{n-1}$, the linear operator $y \mapsto [x, y]_{\mathfrak{m}}$ of \mathfrak{m} onto itself is identically zero, thus the differential equation of (16) also has a simple solution. In all other cases where $V_{n,k}$ is not a symmetric case, i.e., $k \neq n$ or 1 , the solution to the differential equation of (16) may be obtained by exponentiating the linear operator $y \mapsto [x, y]_{\mathfrak{m}}$, which is skew-symmetric with respect to the Killing form of \mathfrak{g} restricted to \mathfrak{m} . However, this exponentiation corresponds to the problem of computing the matrix exponential of a $(k(k-1)/2 + (n-k)k)$ -by- $(k(k-1)/2 + (n-k)k)$ skew-symmetric matrix, which is computationally much more expensive than computing the matrix exponential of an n -by- n skew-symmetric matrix as in the case $V_{n,n} = \mathbf{O}(n)$.

CHAPTER 3

GRADIENT FLOWS ON LIE GROUPS AND HOMOGENEOUS SPACES

To develop a theory of optimization on smooth manifolds, it is natural to begin with a study of gradient flows, which provide local information about the direction of greatest increase or decrease of a real-valued function defined on the manifold. The study of gradient flows is also desirable from the perspective of applications because we will later apply optimization theory to the problem of principal component analysis, which may be expressed as a smooth optimization problem. This approach has received wide attention in the fields of adaptive signal processing (Widrow & Stearns 1985, Schmidt 1979, Roy & Kailath 1989, Larimore 1983, Fuhrmann 1988) and neural networks (Oja 1982, 1989; Bourland & Kamp 1988; Baldi & Hornik 1989; Rubner & Tavan 1989; Rubner & Schulten 1990), where the problem of tracking a principal invariant subspace is encountered (Brockett 1991b).

Let M be a Riemannian manifold with Riemannian structure g , and $f: M \rightarrow \mathbf{R}$ a smooth function on M . Then the gradient of f , denoted by $\text{grad}f$, is a smooth vector field on M and the one-parameter groups of diffeomorphisms generated by $\text{grad}f$ are called the gradient flows of f . In this chapter we will consider a variety of problems whose solutions correspond to the stable critical points of the gradient of a function, i.e., the problems will be restated as local optimization problems on a manifold. These optimization problems will then be solved by computing an integral curve of the gradient. As our concern will be principal component analysis, we shall consider the algebraic task of computing the eigenvalues and eigenvectors of a symmetric matrix, and the singular values and singular vectors of an arbitrary matrix. Of course, efficient algorithms already exist to solve these eigenvalue problems and the methods described within this chapter—integrating differential equations on Lie groups and homogeneous spaces—are not in the least way competitive with standard techniques. Our interest in gradient flows to solve the problems in numerical

linear algebra arises in part from the intent to illuminate and provide a framework for the practical large step optimization algorithms that will appear in Chapter 4. There is also a general interest in studying the class of problems that may be solved via dynamical systems (Brockett 1991b, Faybusovich 1991, Chu & Driessel 1990).

From the perspective of optimization theory, there is a very natural setting for the symmetric eigenvalue problem and the singular value problem. Indeed, finding the eigenvalues of a symmetric matrix may be posed as an optimization problem (Wilkinson 1965, Golub & Van Loan 1983). Let Q be an n -by- n symmetric matrix. The largest (smallest) eigenvalue of Q is the maximum (resp., minimum) value taken by the Rayleigh quotient $x^T Q x / x^T x$ over all vectors $x \neq 0$ in \mathbf{R}^n . The Courant-Fisher minimax characterization describes the general case. Denote the k th largest eigenvalue of Q by λ_k , and let $S \subset \mathbf{R}^n$ be a vector subspace. Then for $k = 1, \dots, n$,

$$\lambda_k = \max_{\dim S=k} \min_{x \in S \setminus \{0\}} \frac{x^T Q x}{x^T x}.$$

The situation for the singular value problem is similar. Let K be an m -by- n matrix, $S \subset \mathbf{R}^n$ and $T \subset \mathbf{R}^m$ vector subspaces, and denote the k th largest singular value of K by σ_k . Then by Theorem 8.3-1 of Golub & Van Loan (1983), for $k = 1, \dots, \min(m, n)$,

$$\sigma_k = \max_{\substack{\dim S=k \\ \dim T=k}} \min_{\substack{x \in S \setminus \{0\} \\ y \in T \setminus \{0\}}} \frac{y^T A x}{\|x\| \|y\|} = \max_{\dim S=k} \min_{x \in S \setminus \{0\}} \frac{\|A x\|}{\|x\|}.$$

Several practical algorithms for the eigenvalue problem, specifically Jacobi methods and Lanczos methods, can be developed on the basis of such optimization requirements. Thus we see that the eigenvalue problem and singular value problems can be viewed as optimization problems on the manifold of k -planes in \mathbf{R}^n , i.e., the Grassmann manifold $G_{n,k}$. Although this particular minimax characterization and manifold will not be used within this chapter, several equivalent optimization problems will be investigated.

1. The diagonalization of a matrix

This section briefly describes pertinent elements of the work of Brockett (1989, 1991a), who provides a gradient flow on the special orthogonal group, or under a change of variables, on the space of symmetric matrices with fixed spectrum. This material is covered to motivate some contributions of this thesis that will appear in subsequent sections, and to illustrate some techniques that will be used throughout the thesis.

In the investigation of some least squares matching problems in computer vision, Brockett (1989) considers the function $f: \Theta \mapsto \text{tr} \Theta^T Q \Theta N$ on the special orthogonal group

$\mathbf{SO}(n)$, where Q is a fixed real symmetric matrix and N is a real diagonal matrix with distinct diagonal elements. We wish to compute the gradient flow of f , which will lead to the eigenvalue decomposition of Q . Using the definition of the differential, we have $df_{\Theta}(\tilde{\Omega}) = (d/dt)|_{t=0} f(c(t))$, where $c: \mathbf{SO}(n) \rightarrow \mathbf{R}$ is any smooth curve such that $c(0) = \Theta$ and $\dot{c}(0) = \tilde{\Omega} \in T_{\Theta}\mathbf{SO}(n)$. As shown in Chapter 2, the unique geodesic in $\mathbf{SO}(n)$ through Θ with direction $\tilde{\Omega} \in T_{\Theta}$ is given by $\exp t\tilde{\Omega} = \Theta e^{\Omega t}$, where Ω is the unique vector in $\mathfrak{so}(n)$ determined by the equation $\tilde{\Omega} = L_{\Theta*}\Omega$.

Therefore, taking $c(t) = \Theta e^{\Omega t}$ and setting $H = \Theta^T Q \Theta$, we have

$$\begin{aligned} df_{\Theta}(\tilde{\Omega}) &= \left. \frac{d}{dt} \right|_{t=0} f(\Theta e^{\Omega t}) \\ &= \left. \frac{d}{dt} \right|_{t=0} \text{tr}(\Theta e^{\Omega t})^T Q (\Theta e^{\Omega t}) N \\ &= \left. \frac{d}{dt} \right|_{t=0} \text{tr} \text{Ad}_{e^{-\Omega t}}(H) N \\ &= -\text{tr}[\Omega, H] N \\ &= -\text{tr} \Omega [H, N] \\ &= \langle \Omega, [H, N] \rangle. \end{aligned}$$

The expansion $\text{Ad}_{e^{Xt}}(Y) = e^{t \text{ad}_X} \cdot Y = Y + t \text{ad}_X Y + (t^2/2!) \text{ad}_X^2 Y + \dots$ and the identity $\text{tr} ABC = \text{tr} BCA = \text{tr} CAB$ are used in this chain of equalities. Equivalently, we may also use the fact that with respect to the Killing form on $\mathfrak{so}(n)$, $\langle \text{ad}_x y, z \rangle = -\langle y, \text{ad}_x z \rangle$, following Brockett (1993). From the definition of the gradient, i.e. $df_p(X) = \langle (\text{grad} f)_p, X \rangle$ for all $X \in T_p$, we see that with respect to the natural invariant metric on $\mathbf{SO}(n)$ the gradient of f is given by

$$(\text{grad} f)_{\Theta} = \Theta[\Theta^T Q \Theta, N]. \quad (1)$$

Let \mathbf{S}_{λ} denote the set of real symmetric matrices with the fixed set of eigenvalues $\lambda = \{\lambda_1, \dots, \lambda_n\}$. If the eigenvalues are distinct, then this set is a C^{∞} differentiable manifold of dimension $n(n-1)/2$. To see why this is so, observe that the Lie group $\mathbf{SO}(n)$ acts effectively and transitively on \mathbf{S}_{λ} by the action $(\theta, s) \mapsto \theta s \theta^{-1}$. If the eigenvalues $\lambda = \{\lambda_1, \dots, \lambda_n\}$ are distinct, the isotropy group of this action at the point $\text{diag}(\lambda_1, \dots, \lambda_n)$ is the discrete subgroup $\text{diag}(\pm 1, \dots, \pm 1)$, which we denote by D . Therefore, we may make the natural identification $\mathbf{S}_{\lambda} \cong \mathbf{SO}(n)/D$. Thus the manifold \mathbf{S}_{λ} inherits a Riemannian structure from the natural invariant structure on $\mathbf{SO}(n)$.

The so-called double bracket equation, also known as Brockett's equation, can be ob-

tained from Equation (1) by making the change of variables

$$H = \Theta^T Q \Theta. \quad (2)$$

Differentiating both sides of Equation (2) and rearranging terms yields the isospectral flow

$$\dot{H} = [H, [H, N]]. \quad (3)$$

Remarkably, Equation (3) is equivalent to a Toda flow in the case where H is tridiagonal and $N = \text{diag}(1, \dots, n)$ (Bloch 1990; Bloch et al. 1990, 1992); therefore, it is an example of a flow that is both Hamiltonian and gradient.

The fixed points of Equations (1) and (3) may be computed in a straightforward way. Consider the function $H \mapsto \text{tr} HN$ on the set of real symmetric matrices with fixed spectrum, where N is a real diagonal matrix with distinct diagonal entries. Computing as above, we see that

$$\begin{aligned} \frac{d}{dt} \text{tr} HN &= \text{tr}[H, [H, N]]N \\ &= -\text{tr}[H, N]^2 \\ &= -\|[H, N]\|^2. \end{aligned}$$

This derivative is nonnegative and bounded from above because the set \mathcal{S}_λ is compact. Therefore, $\text{tr} HN$ has a limit and its derivative approaches zero as

$$[H, N] \rightarrow 0.$$

In the limit, this becomes

$$h_{ij}(n_{jj} - n_{ii}) = 0.$$

Therefore, H approaches a diagonal matrix with the prescribed eigenvalues along its diagonal, i.e., $H = \text{diag}(\lambda_{\pi(1)}, \dots, \lambda_{\pi(n)})$ for some permutation π of the integers $1, \dots, n$.

Inspecting the second order terms of $\text{tr} HN$ at a critical point $H = \text{diag}(\lambda_{\pi(1)}, \dots, \lambda_{\pi(n)})$ will show which of these $n!$ points are asymptotically stable. Let H be the parameterized matrix $(\Theta e^{\Omega \epsilon})^T Q (\Theta e^{\Omega \epsilon})$, where $\Theta^T Q \Theta = \text{diag}(\lambda_{\pi(1)}, \dots, \lambda_{\pi(n)})$ and $\Omega \in \mathfrak{so}(n)$. The second order terms of $\text{tr} HN$ are

$$-\sum_{1 \leq i < j \leq n} (n_{ii} - n_{jj})(\lambda_{\pi(i)} - \lambda_{\pi(j)})(\epsilon \omega_{ij})^2. \quad (4)$$

This quadratic form is negative (positive) definite if and only if the sets $\{\lambda_i\}$ and $\{n_{ii}\}$ are similarly (resp., oppositely) ordered. Therefore, of the $n!$ critical points of Equation (3),

one is a sink, one is a source, and the remainder are saddle points. Of the $2^n n!$ critical points of Equation (1), 2^n are sinks, 2^n are sources, and the remainder are saddle points.

Equations (1) and (3) play a role in the study of interior point methods for linear programming (Faybusovich 1991) and the study of continuous versions of the QR algorithm (Lagarias 1991, Watkins & Elsner 1988), but this work will not be discussed here.

2. The extreme eigenvalues of a matrix

In the previous section an optimization problem was considered whose solution corresponds to the complete eigenvalue decomposition of a symmetric matrix. However, oftentimes only a few eigenvalues and eigenvectors are required. If given an n -by- n symmetric matrix Q with distinct eigenvalues, the closest rank k symmetric matrix is desired, this is determined by the sum $\sum \lambda_i x_i x_i^T$, $i = 1, \dots, k$, where λ_i is the i th largest eigenvalue of Q and x_i is the corresponding eigenvector. Some signal processing applications (Bienvenu & Kopp 1983, Larimore 1983, Roy & Kailath 1989) require knowledge of the smallest eigenvalues and corresponding eigenvectors to estimate signals in the presence of noise. In this section we will consider a function whose gradient flow yields the eigenvectors corresponding to the extreme eigenvalues of a given matrix.

The generalized Rayleigh quotient

Consider the compact Stiefel manifold $V_{n,k}$ of real n -by- k matrices, $k \leq n$, with orthonormal columns. As discussed in Chapter 2, Section 3, $V_{n,k}$ may be identified with the reductive homogeneous space $\mathbf{O}(n)/\mathbf{O}(n-k)$ of dimension $k(k-1)/2 + (n-k)k$. Let $G = \mathbf{O}(n)$, $o = \begin{pmatrix} I \\ 0 \end{pmatrix}$ the origin of $V_{n,k}$, $H = \mathbf{O}(n-k)$ the isotropy group at o , \mathfrak{g} and \mathfrak{h} the Lie algebra of G and H , respectively. Set $M = V_{n,k}$. There is a subspace \mathfrak{m} of \mathfrak{g} such that $\mathfrak{g} = \mathfrak{m} + \mathfrak{h}$ (direct sum) and $\text{Ad}_H(\mathfrak{m}) = \mathfrak{m}$ obtained by choosing $\mathfrak{m} = \mathfrak{h}^\perp$ with respect to the Killing form of \mathfrak{g} . The tangent plane $T_o M$ is identified with the subspace \mathfrak{m} in the standard way. Let g be a coset representative of $p \in V_{n,k}$, i.e., $p = g \cdot o$. Tangent vectors in $T_p M$ will be represented by vectors in \mathfrak{m} via the correspondence described in Chapter 2, Section 3. The reductive homogeneous space structure of $V_{n,k}$ will be exploited in this section to describe the gradient flow of a function defined on $V_{n,k}$ and will be especially important in later chapters when efficient algorithms for computing a few extreme eigenvalues of a symmetric matrix are developed.

Definition 2.1. Let $1 \leq k \leq n$, A be a real n -by- n symmetric matrix, and N a real n -by- n diagonal matrix. Define the *generalized Rayleigh quotient* to be the function $\rho: V_{n,k} \rightarrow \mathbf{R}$

given by

$$\rho(p) = \text{tr } p^T A p N.$$

Gradient flows

Proposition 2.2. *Let p be a point in $V_{n,k}$, A a real n -by- n symmetric matrix, and N a real n -by- n diagonal matrix.*

(1) *The element v in \mathfrak{m} corresponding to the gradient of the generalized Rayleigh quotient ρ at p with respect to the canonical invariant metric is given by*

$$v = [g^T A g, o N o^T] = g^T A p N o^T - o N p^T A g.$$

(2) *If the diagonal elements ν_i of N are distinct, with $\nu_i > 0$ for $i = 1, \dots, r$, and $\nu_i < 0$ for $i = r + 1, \dots, k$, and the largest r eigenvalues and smallest $k - r$ eigenvalues of A are distinct, then with the exception of certain initial points contained within codimension 1 submanifolds of $V_{n,k}$, the gradient flow associated with $v = [g^T A g, o N o^T] \in \mathfrak{m}$ converge exponentially to points p_∞ such that the first r columns contain the eigenvectors of A corresponding to its largest eigenvalues, and the last $k - r$ columns contain the eigenvectors corresponding to the smallest eigenvalues.*

Proof. Let X a tangent vector in $T_p M$. Then for $f \in C^\infty(M)$, X corresponds to $x \in \mathfrak{m}$ by

$$(Xf)_p = \left. \frac{d}{dt} \right|_{t=0} f(ge^{xt} \cdot o).$$

By the definition of ρ , it is seen that for any $X \in T_p M$

$$\begin{aligned} d\rho_p(X) &= \left. \frac{d}{dt} \right|_{t=0} \rho(ge^{xt} \cdot o) \\ &= \left. \frac{d}{dt} \right|_{t=0} \text{tr}(ge^{xt} \cdot o)^T A (ge^{xt} \cdot o) N \\ &= \left. \frac{d}{dt} \right|_{t=0} \text{tr } o^T \text{Ad}_{e^{-xt}}(g^T A g) o N \\ &= -\text{tr}[x, g^T A g] o N o^T \\ &= -\text{tr } x [g^T A g, o N o^T] \\ &= \langle x, [g^T A g, o N o^T] \rangle. \end{aligned}$$

This establishes the first part.

Let $t \mapsto p_t$ be an integral curve of a gradient flow of the ρ on $V_{n,k}$, and g_t a coset representative of p_t such that $p_t = g_t \cdot o$ for all $t \in \mathbf{R}$. For simplicity, denote the n -by- n

symmetric matrix $g_t^T A g_t$ by H . The manifold $V_{n,k}$ is compact and thus ρ is bounded from above. As the derivative

$$\frac{d}{dt}\rho(p_t) = -\operatorname{tr}[H, oN o^T]^2$$

is nonnegative, the value of $\rho(p_t)$ has a limit and its derivative approaches zero as

$$[H, oN o^T] \rightarrow 0.$$

In the limit these asymptotics become

$$\begin{aligned} h_{ij}(\nu_j - \nu_i) &= 0 && \text{for } 1 \leq i, j \leq k, \\ h_{ij}\nu_j &= 0 && \text{for } k < i \leq n, 1 \leq j \leq k. \end{aligned}$$

Because the ν_i are assumed to be distinct, these conditions imply that in the limit,

$$H = \begin{pmatrix} \lambda_{\pi(1)} & & & 0 \\ & \ddots & & \\ & & \lambda_{\pi(k)} & \\ 0 & & & H_1 \end{pmatrix},$$

where π is a permutation of the integers $1, \dots, n$, and H_1 is an $(n-k)$ -by- $(n-k)$ symmetric matrix with eigenvalues $\lambda_{\pi(k+1)}, \dots, \lambda_{\pi(n)}$.

The second order terms of $\rho(p_t)$ at the critical points corresponding to $H = \operatorname{diag}(\lambda_{\pi(1)}, \dots, \lambda_{\pi(k)}, H_1)$ indicate which of these points are asymptotically stable. Because the coset representative g_t of p_t is arbitrary, choose g_t such that $H = g_t^T A g_t = \operatorname{diag}(\lambda_{\pi(1)}, \dots, \lambda_{\pi(n)})$. Let X be tangent vector in $T_{p_0}M$ corresponding to $x \in \mathfrak{m}$. The Taylor expansion of $\rho(p_t)$ about $t = 0$ is

$$\rho(p_t) = \rho(p_0) + t(\nabla\rho)_{p_0}(X) + \frac{t^2}{2}(\nabla^2\rho)_{p_0}(X, X) + \dots$$

(this formula will be established rigorously in Chapter 4). The second order terms of $\rho(p_t)$ at the critical points of ρ corresponding to $H = \operatorname{diag}(\lambda_{\pi(1)}, \dots, \lambda_{\pi(n)})$ are given by the Hessian

$$\begin{aligned} (d^2\rho)_{p_0}(X, X) &= - \sum_{1 \leq j < i \leq k} x_{ij}^2 (\lambda_{\pi(i)} - \lambda_{\pi(j)}) (\nu_i - \nu_j) \\ &\quad - \sum_{\substack{k < i \leq n \\ 1 \leq j \leq k}} x_{ij}^2 (\lambda_{\pi(j)} - \lambda_{\pi(i)}) \nu_j, \end{aligned}$$

where x_{ij} are the elements of the matrix x .

This quadratic form is negative definite if and only if

- (i) The eigenvalues $\lambda_{\pi(i)}$ and the numbers ν_i , $1 \leq i \leq k$, are similarly ordered.

- (ii) If $\nu_j > 0$, then $\lambda_{\pi(j)}$ is greater than all the eigenvalues of the matrix H_1 ; if $\nu_j < 0$, then $\lambda_{\pi(j)}$ is less than all the eigenvalues of the matrix H_1 .

This establishes the second part of the proposition. ■

Note that the second equality of part 1 of Proposition 2.2 is more suitable for computations because it requires $O(k)$ matrix-vector multiplications, as opposed to the first equality which requires $O(n)$ matrix-vector multiplications.

Remark 2.3. If A or N in Proposition 2.2 has repeated eigenvalues, then exponential stability, but not asymptotic stability, is lost.

Corollary 2.4. *Let A and N be as in part (2) of Proposition 2.2. Then the generalized Rayleigh quotient ρ has $2^k {}_n P_k$ critical points (${}_n P_k = n!/(n-k)!$ is the number of permutations of n objects taken k at a time), of which one is a sink, one is a source, and the remainder are saddle points.*

Corollary 2.5. *Let A and N be as in part (2) of Proposition 2.2. Then near the critical points corresponding to $H = \text{diag}(\lambda_{\pi(1)}, \dots, \lambda_{\pi(k)}, H_1)$ the gradient flow of ρ has the exponential rates of convergence μ_{ij} given by*

$$\mu_{ij} = \begin{cases} -(\lambda_{\pi(i)} - \lambda_{\pi(j)})(\nu_i - \nu_j), & \text{for } 1 \leq i, j \leq k; \\ -(\lambda_{\pi(j)} - \lambda_{\pi(i)})\nu_j, & \text{for } k < i \leq n, 1 \leq j \leq k. \end{cases}$$

3. The singular value decomposition

The singular value decomposition (SVD) is an important decomposition in numerical linear algebra. It has applications in least squares theory, matrix inversion, subspace comparisons, and spectral analysis. Golub and Van Loan (1983) provide background and examples. There has been interest recently in the application of dynamical systems to the solution of problems posed in the domain of numerical linear algebra. Brockett [1988] (1991a) introduces the double bracket equation $\dot{H} = [H, [H, N]]$, discussed in Section 1, and shows that it can solve certain problems of this type. This work motivated Perkins et al. (1990) to formulate a gradient algorithm which finds classes of balanced realizations of finite dimensional linear systems. In particular, they give a gradient algorithm for the SVD. Also, several researchers have constructed neuron-like networks that perform principal component analysis. For example, Oja (1982) describes a network algorithm that extracts the principal component of a statistically stationary signal; Rubner and Schulten (1990) generalize this

method so that all principal components are extracted. There is a link between the matrix double bracket equation and the least squares problems studied by Brockett (1991b), and the analysis of neural network principal component analysis provided by Baldi and Hornik (1989). Baldi and Hornik describe the level set structure of a strictly convex function defined on real n -by- n matrices of rank k . This level set structure becomes identical to that of the Lyapunov function $-\text{tr} HN$ if the strictly convex function is restricted to matrices with fixed singular values. See also the work of Watkins and Elsner (1988, 1989) for a discussion of self-similar and self-equivalent flows and a continuous version of the QR algorithm for eigenvalues and singular values. Chu & Driessel (1990) and Helmke & Moore (1992) also provide gradient flows similar to the ones described here that yield the singular value decomposition of a matrix. Deift et al. (1991a, 1991a) describe how a certain flow of bidiagonal matrices that leads to the singular value decomposition can be viewed as a Hamiltonian flow with respect to the so-called Sklyanin structure, which is described by Li & Parmentier (1989) and Deift & Li (1991).

This section describes a gradient flow on the space of real n -by- k matrices with fixed singular values whose solutions converge exponentially to the SVD of a given matrix provided that its singular values are distinct. This dynamic system has, therefore, potential application to the problems mentioned above. Also, as a generalization of the symmetric version of the matrix double bracket equation, it inherits the capability to sort lists, diagonalize matrices, and solve linear programming problems. Viewed as an algorithm for the SVD, this method is less efficient than the variant of the QR algorithm described by Golub and Van Loan; however the motivation here is to describe analog systems capable of this task. As opposed to Perkins et al.'s method which requires matrix inversion, matrix multiplication and addition are the only operations required. First presented are some results from differential geometry and a suitable representation of the set of real n -by- k matrices with prescribed singular values. A Riemannian structure is defined on this space so that the gradient operator is well defined. Next, the main result is given with ensuing corollaries. Finally, the results of a numerical simulation are provided.

Matrices with fixed singular values

Recall the following standard mathematical notation and concepts. Let $\mathbf{R}^{n \times k}$ denote the set of all real n -by- k matrices. Let $\mathbf{O}(n)$ and $\mathfrak{o}(n)$ represent the real orthogonal group and its Lie algebra of skew-symmetric matrices, respectively, such that for $\Theta \in \mathbf{O}(n)$ and $\Omega \in \mathfrak{o}(n)$, $\Theta^T \Theta = I$ and $\Omega + \Omega^T = 0$. Both spaces have dimension $n(n-1)/2$. The notation

$\text{diag}(\alpha_1, \dots, \alpha_k)$ represents a k -by- k diagonal matrix whose diagonal elements are α_i , and $\text{diag}_{n \times k}(\alpha_1, \dots, \alpha_k)$ represents the n -by- k matrix

$$\text{diag}_{n \times k}(\alpha_1, \dots, \alpha_k) = \begin{pmatrix} \text{diag}(\alpha_1, \dots, \alpha_k) \\ 0 \end{pmatrix},$$

where, in this instance, $n \geq k$. Let D represent the discrete subgroup of $\mathbf{O}(k)$ consisting of matrices of the form $\text{diag}(\pm 1, \dots, \pm 1)$. Finally, let \mathbf{K}_σ denote the manifold of real n -by- k matrices with the set of singular values $\sigma = \{\sigma_1, \dots, \sigma_k\}$. In this section it is assumed that the singular values σ_i are distinct, and unless stated otherwise, nonzero.

Let $K \in \mathbf{K}_\sigma$ and assume, without loss of generality, that $n \geq k$. Then K has the SVD

$$K = U \text{diag}_{n \times k}(\sigma_1, \dots, \sigma_k) V^T, \quad (5)$$

where $U \in \mathbf{O}(n)$, $V \in \mathbf{O}(k)$, and $\sigma_i \geq 0$ for $i = 1, \dots, k$. This decomposition is also expressible as

$$K v_i = \sigma_i u_i \quad \text{or} \quad K^T u_i = \sigma_i v_i, \quad (6)$$

where the σ_i are called the singular values of K , and the u_i and v_i are called the left and right singular vectors of K , respectively, for $i = 1, \dots, k$. If the singular values are distinct, the left and right singular vectors are unique up to multiplication of u_i and v_i by ± 1 .

Remark 3.1. The set \mathbf{K}_σ is a differentiable manifold of dimension $nk - k$ if the σ_i are distinct and nonzero. This fact can be inferred from the existence of a map p from $\mathbf{R}^{n \times k}$ to the coefficients of the polynomials of degree k over \mathbf{R} whose Jacobian has constant rank, viz.,

$$p(K) = \det(\lambda I - K^T K) - (\lambda - \sigma_1^2) \dots (\lambda - \sigma_k^2).$$

The differential of p at K is given by

$$dp_K(X) = -2 \det(\lambda I - K^T K) \text{tr}(\lambda I - K^T K)^{-1} K^T X.$$

This mapping has rank k for all $K \in \mathbf{K}_\sigma$; therefore the inverse image $\mathbf{K}_\sigma = p^{-1}(0)$ is a (compact) submanifold of $\mathbf{R}^{n \times k}$ of dimension $nk - k$. It will be shown later that if $n > k$, then \mathbf{K}_σ is connected, if $n = k$, then \mathbf{K}_σ has two connected components, and if $n = k$ and the elements of \mathbf{K}_σ are restricted to be symmetric, then \mathbf{K}_σ restricted to the symmetric matrices has 2^k connected components.

A similar argument shows that if $\{\sigma_i\}$ has r nonzero distinct elements and $k - r$ zero elements, then $\mathbf{K}_{\{\sigma_1, \dots, \sigma_r, 0, \dots, 0\}}$ is a manifold of dimension $nr + kr - r^2 - r$. In particular, if $r = k - 1$, then $\mathbf{K}_{\{\sigma_1, \dots, \sigma_{k-1}, 0\}}$ is a manifold of dimension $nk - n$.

The statement of the main result of this section contains statements about the gradient of a certain function defined on \mathbf{K}_σ . The definition of the gradient on a manifold depends upon the choice of Riemannian metric; therefore a metric must be chosen if the gradient is to be well defined. The approach of this section is standard: \mathbf{K}_σ is identified with a suitable homogeneous space on which a Riemannian metric is defined (see, e.g., Kobayashi & Nomizu (1969)).

Remark 3.2. The product group $\mathbf{O}(n) \times \mathbf{O}(k)$ acts effectively on \mathbf{K}_σ via the map $((\theta, \vartheta), K) \mapsto \theta K \vartheta^T$. Clearly this action is transitive; therefore \mathbf{K}_σ is a homogeneous space with the transformation group $\mathbf{O}(n) \times \mathbf{O}(k)$. If the σ_i are distinct and nonzero, then the isotropy group or stabilizer of this action at the point $\text{diag}_{n \times k}(\sigma_1, \dots, \sigma_k) \in \mathbf{K}_\sigma$ is the closed subgroup $\{(\text{diag}(\Delta, \Psi), \Delta) : \Psi \in \mathbf{O}(n-k), \Delta \in D\}$, as can be verified from an elementary calculation. Note that this subgroup is the semidirect product of $\mathbf{O}(n-k)$ and $\Delta_D \stackrel{\text{def}}{=} \{(\text{diag}(\Delta, I), \Delta) : \Delta \in D\}$, the set theoretic diagonal of $\text{diag}(D, I) \times D$; therefore it will be represented by the notation

$$\Delta_D \mathbf{O}(n-k) \stackrel{\text{def}}{=} \{(\text{diag}(\Delta, \Psi), \Delta) : \Psi \in \mathbf{O}(n-k), \Delta \in D\}.$$

Thus \mathbf{K}_σ may be identified with the homogeneous space $(\mathbf{O}(n) \times \mathbf{O}(k))/\Delta_D \mathbf{O}(n-k)$ of dimension $nk - k$. Let $K \in \mathbf{K}_\sigma$ have the SVD $K = U \text{diag}_{n \times k}(\sigma_1, \dots, \sigma_k) V^T$. It is straightforward to show that the map $\psi: \mathbf{K}_\sigma \rightarrow (\mathbf{O}(n) \times \mathbf{O}(k))/\Delta_D \mathbf{O}(n-k)$ defined by the action $\psi: K \mapsto (U, V) \Delta_D \mathbf{O}(n-k)$ is a bijection. Because matrix multiplication as an operation on $\mathbf{R}^{n \times k}$ is smooth, ψ^{-1} is C^∞ ; therefore ψ is a diffeomorphism.

A similar argument shows that if the set $\{\sigma_i \in \mathbf{R}\}$ has r nonzero distinct elements, then $\mathbf{K}_{\{\sigma_1, \dots, \sigma_r, 0, \dots, 0\}}$ can be identified with the homogeneous space $(\mathbf{O}(n) \times \mathbf{O}(k))/\Delta_D(\mathbf{O}(n-r) \times \mathbf{O}(k-r))$ of dimension $nr + kr - r^2 - r$, where

$$\begin{aligned} \Delta_D(\mathbf{O}(n-r) \times \mathbf{O}(k-r)) &\stackrel{\text{def}}{=} \{(\text{diag}(\Delta, \Psi), \text{diag}(\Delta, \Upsilon)) : \\ &\Psi \in \mathbf{O}(n-r), \Upsilon \in \mathbf{O}(k-r), \Delta \in D \subset \mathbf{O}(r)\}. \end{aligned}$$

In particular, if $r = k-1$, then $\mathbf{K}_{\{\sigma_1, \dots, \sigma_{k-1}, 0\}}$ can be identified with the homogeneous space $(\mathbf{O}(n) \times \mathbf{O}(k))/\Delta_D(\mathbf{O}(n-k+1) \times \mathbf{O}(1))$ of dimension $nk - n$.

Remark 3.3. The homogeneous space $(\mathbf{O}(n) \times \mathbf{O}(k))/\Delta_D \mathbf{O}(n-k)$ is reductive; i.e., there exists a linear subspace $\mathfrak{k} \times \mathfrak{o}(k)$ of $\mathfrak{o}(n) \times \mathfrak{o}(k)$ such that

$$\mathfrak{o}(n) \times \mathfrak{o}(k) = \mathfrak{o}(n-k) \times 0 + \mathfrak{k} \times \mathfrak{o}(k) \quad (\text{direct sum})$$

and $\text{Ad}_{\Delta_D \mathbf{O}(n-k)}(\mathfrak{k} \times \mathfrak{o}(k)) \subset \mathfrak{k} \times \mathfrak{o}(k)$, viz.,

$$\mathfrak{k} = \left\{ \begin{pmatrix} a & -b^T \\ b & 0 \end{pmatrix} \in \mathfrak{o}(n) \right\}.$$

This is the perpendicular subspace given by Proposition 2.11 of Chapter 2. Therefore there is a natural correspondence between $\text{Ad}_{\Delta_D \mathbf{O}(n-k)}$ -invariant nondegenerate symmetric bilinear forms on $\mathfrak{k} \times \mathfrak{o}(k)$ and $\mathbf{O}(n) \times \mathbf{O}(k)$ -invariant Riemannian metrics on $(\mathbf{O}(n) \times \mathbf{O}(k))/\Delta_D \mathbf{O}(n-k)$. A general exposition of these ideas is given by Kobayashi & Nomizu (1969, Chap. 10).

The object of these remarks is to establish the identification

$$\mathbf{K}_\sigma \cong (\mathbf{O}(n) \times \mathbf{O}(k))/\Delta_D \mathbf{O}(n-k)$$

when the σ_i are distinct and nonzero, where $\Delta_D \mathbf{O}(n-k)$ is the closed subgroup of $\mathbf{O}(n) \times \mathbf{O}(k)$ defined in Remark 3.2, and to assert that a positive definite quadratic form on $\mathfrak{k} \times \mathfrak{o}(k)$ defines a Riemannian metric on \mathbf{K}_σ , where \mathfrak{k} is the linear subspace defined in Remark 3.3.

Proposition 3.4. *The nondegenerate symmetric bilinear form on $\mathfrak{k} \times \mathfrak{o}(k)$ defined by*

$$g((\Gamma_1, \Phi_1), (\Gamma_2, \Phi_2)) = \frac{n-2}{2} \text{tr } \Gamma_1^T \Gamma_2 + \frac{k-2}{2} \text{tr } \Phi_1^T \Phi_2, \quad (7)$$

where $\Phi_1, \Phi_2 \in \mathfrak{o}(k)$, $\Gamma_1, \Gamma_2 \in \mathfrak{k}$, and $n \geq k \geq 3$, defines an $\mathbf{O}(n) \times \mathbf{O}(k)$ -invariant Riemannian metric on $(\mathbf{O}(n) \times \mathbf{O}(k))/\Delta_D \mathbf{O}(n-k)$. If n or k equals 2, replacing the coefficients $(n-2)$ or $(k-2)$ by unity, respectively, yields an $\mathbf{O}(n) \times \mathbf{O}(k)$ -invariant Riemannian metric on $(\mathbf{O}(n) \times \mathbf{O}(k))/\Delta_D \mathbf{O}(n-k)$.

Proof. The product space $\mathbf{O}(n) \times \mathbf{O}(k)$ is a compact semisimple Lie group, $n, k \geq 3$; therefore the Killing form $\varphi((\Gamma_1, \Phi_1), (\Gamma_2, \Phi_2)) = (n-2) \text{tr } \Gamma_1^T \Gamma_2 + (k-2) \text{tr } \Phi_1^T \Phi_2$ of $\mathfrak{o}(n) \times \mathfrak{o}(k)$ is strictly negative definite. From Kobayashi & Nomizu (1969, Chap. 10, Coroll. 3.2), or Helgason (1978, Chap. 4, Prop. 3.4), it can be seen that there is a natural correspondence between $\mathbf{O}(n) \times \mathbf{O}(k)$ -invariant Riemannian metrics on $(\mathbf{O}(n) \times \mathbf{O}(k))/\Delta_D \mathbf{O}(n-k)$ and nondegenerate symmetric bilinear forms on $\mathfrak{k} \times \mathfrak{o}(k)$. Therefore the form $g = -\frac{1}{2}\varphi$ restricted to $\mathfrak{k} \times \mathfrak{o}(k)$ defines such a metric. If n or k equals 2, the nondegenerate symmetric bilinear form $(\Omega_1, \Omega_2) \mapsto \frac{1}{2} \text{tr } \Omega_1^T \Omega_2$ on $\mathfrak{o}(2)$ defines an $\mathbf{O}(2)$ -invariant Riemannian metric on $\mathbf{O}(2)$. Therefore replacing the expressions $(n-2)$ or $(k-2)$ by unity in Equation (7) yields an $\mathbf{O}(n) \times \mathbf{O}(k)$ -invariant Riemannian metric on $(\mathbf{O}(n) \times \mathbf{O}(k))/\Delta_D \mathbf{O}(n-k)$. ■

Proposition 3.5. *Let $\Sigma: \mathbf{R} \rightarrow \mathbf{K}_\sigma$ be a smoothly parameterized curve in \mathbf{K}_σ . Then the tangent vector to the curve Σ at t is of the form*

$$\dot{\Sigma}(t) = \Sigma(t)\Phi - \Gamma\Sigma(t), \quad (8)$$

where $\Phi \in \mathfrak{o}(k)$ and $\Gamma \in \mathfrak{k}$.

Proof. Let $K \in \mathbf{K}_\sigma$. Then $\Sigma(t) = U^\top(t)KV(t)$ for $U(t) \in \mathbf{O}(n)$ and $V(t) \in \mathbf{O}(k)$. The perturbations $U(t) \rightarrow Ue^{(t+\epsilon)\Gamma}$ and $V(t) \rightarrow Ve^{(t+\iota)\Phi}$ for $U \in \mathbf{O}(n)$, $V \in \mathbf{O}(k)$, $\Gamma \in \mathfrak{k}$, $\Phi \in \mathfrak{o}(k)$, and real ϵ and ι , give rise to the tangent vector of Equation (8) under the change of coordinates $\Sigma(t) = U^\top(t)KV(t)$. The elements of Γ and Φ parameterize the tangent plane of \mathbf{K}_σ at $\Sigma(t)$ completely; therefore this set of tangent vectors is complete. ■

Gradient flows

Consider the extremization problem

$$\max_{\Sigma \in \mathbf{K}_\sigma} \text{tr } N^\top \Sigma,$$

where $N = \text{diag}_{n \times k}(\nu_1, \dots, \nu_k)$ and the ν_i are real (cf. von Neumann [1937] (1962)). For the remainder of this section, assume that $n \geq k \geq 3$. The following results may be extended to include the cases where n or k equals 2 by replacing the expressions $(n-2)$ or $(k-2)$ by unity, respectively. The notation $[[\cdot, \cdot]]: \mathbf{R}^{m \times l} \times \mathbf{R}^{m \times l} \rightarrow \mathfrak{o}(m)$ defined for $m \geq 3$ by the bilinear operation $[[A, B]] = (AB^\top - BA^\top)/(m-2)$ is employed in the statement of the following proposition.

Proposition 3.6. *Let $\Sigma, K \in \mathbf{K}_\sigma$. The gradient ascent equation on \mathbf{K}_σ for the function $\text{tr } N^\top \Sigma$ with respect to the Riemannian metric defined above is*

$$\dot{\Sigma} = \Sigma[[\Sigma^\top, N^\top]] - [[\Sigma, N]]\Sigma; \quad \Sigma(0) = K. \quad (9a)$$

Equivalently, let $U \in \mathbf{O}(n)$ and $V \in \mathbf{O}(k)$. The gradient ascent equations on $\mathbf{O}(n) \times \mathbf{O}(k)$ for the function $\text{tr } N^\top U^\top KV$ with respect to the Riemannian metric defined above are

$$\begin{aligned} \dot{U} &= U[[U^\top KV, N]]; & U(0) &= I, \\ \dot{V} &= V[[V^\top K^\top U, N^\top]]; & V(0) &= I. \end{aligned} \quad (9b)$$

Furthermore, if $\{\sigma_i\}$ and $\{\nu_i\}$ have distinct elements, then with the exception of certain initial points contained within a finite union of codimension 1 submanifolds of $\mathbf{K}_\sigma \times \mathbf{O}(n) \times \mathbf{O}(k)$, the triple (Σ, U, V) converges exponentially to the singular value decomposition of K

(up to the signs of the singular values). If Σ is nonsquare or nonsymmetric, then in the limit the moduli of the $\pm\sigma_i$ and the ν_i are similarly ordered. If Σ is square and symmetric, then in the limit the eigenvalues $\lambda_i = \pm\sigma_i$ of Σ and the ν_i are similarly ordered.

Proof. Let K have the SVD $K = U_1 \text{diag}_{n \times k}(\sigma_1, \dots, \sigma_k) V_1^T$ where the singular values are distinct and nonzero. Denote the isotropy group at K by $H = (U_1, V_1) \Delta_D \mathbf{O}(n-k) (U_1^T, V_1^T)$ (n.b. Remark 3.2). The gradient of the function $f: (\mathbf{O}(n) \times \mathbf{O}(k)) / \Delta_D \mathbf{O}(n-k) \rightarrow \mathbf{R}$ at the point $H(U, V)$ is uniquely defined by the equality

$$df_{H(U,V)}(\Gamma, \Phi) = g((\text{grad} f)_{H(U,V)}, (\Gamma, \Phi)).$$

For $f(H(U, V)) = \text{tr} N^T U^T K V$, it can be seen that

$$df_{H(U,V)}(\Gamma, \Phi) = \frac{1}{2} \text{tr} \Gamma^T (\Sigma N^T - N \Sigma^T) + \frac{1}{2} \text{tr} \Phi^T (\Sigma^T N - N^T \Sigma),$$

where the identities $\text{tr} ABC = \text{tr} BCA = \text{tr} CAB$ and $\text{tr} A^T B = \text{tr}(A^T B + B^T A)/2$ are employed. From the definition of the Riemannian metric in Proposition 3.4, it is clear that the gradient directions of $\text{tr} N^T U^T K V$ are

$$\begin{aligned} \text{grad} f &= \frac{1}{n-2} (\Sigma N^T - N \Sigma^T) = \llbracket \Sigma, N \rrbracket \in \mathfrak{k} && (\mathfrak{k}\text{-component}), \\ \text{grad} f &= \frac{1}{k-2} (\Sigma^T N - N^T \Sigma) = \llbracket \Sigma^T, N^T \rrbracket \in \mathfrak{o}(k) && (\mathfrak{o}(k)\text{-component}). \end{aligned}$$

This with Proposition 3.5 proves the first part.

Because the derivative

$$\frac{d}{dt} \text{tr} N^T \Sigma = \frac{(n-2)^2}{2(k-2)} \text{tr} \llbracket \Sigma, N \rrbracket^T \llbracket \Sigma, N \rrbracket + \frac{(k-2)^2}{2(n-2)} \text{tr} \llbracket \Sigma^T, N^T \rrbracket^T \llbracket \Sigma^T, N^T \rrbracket$$

is nonnegative and $\text{tr} N^T \Sigma$ is bounded from above (\mathbf{K}_σ is a compact subset of $\mathbf{R}^{n \times k}$), $\text{tr} N^T \Sigma$ has a limit and its derivative approaches zero as $\llbracket \Sigma, N \rrbracket$ and $\llbracket \Sigma^T, N^T \rrbracket$ approach zero. In the limit these become, for $1 \leq i, j \leq k$,

$$\sigma_{ij} \nu_j - \nu_i \sigma_{ji} = 0, \quad \sigma_{ji} \nu_j - \nu_i \sigma_{ij} = 0$$

and, for $1 \leq i \leq k, k < j \leq n$,

$$\nu_i \sigma_{ji} = 0,$$

where the σ_{ij} are elements of Σ . If the ν_i are distinct, these conditions imply that $\sigma_{ij} = 0$ for $i \neq j$. Therefore the critical points of Equations (9a) and (9b) occur when the prescribed

singular values are along the diagonal of Σ ; i.e., $\Sigma = \text{diag}_{n \times k}(\pm\sigma_{\pi(1)}, \dots, \pm\sigma_{\pi(k)})$ for some permutation π of the integers $1, \dots, k$.

Inspecting the second order terms of $\text{tr } N^T \Sigma$ at a critical point $\Sigma = \text{diag}_{n \times k}(\sigma_{\pi(1)}, \dots, \sigma_{\pi(k)})$ will show which of these points is asymptotically stable. Let Σ be the parameterized matrix $(Ue^{\epsilon\Gamma})^T K (Ve^{\iota\Phi})$, where $U^T K V = \text{diag}_{n \times k}(\sigma_{\pi(1)}, \dots, \sigma_{\pi(k)})$. The second order terms of $\text{tr } N^T \Sigma$ are

$$\begin{aligned} & \frac{1}{2} \begin{pmatrix} \epsilon & \iota \end{pmatrix} \begin{pmatrix} \text{tr } N^T \Gamma^{2T} \Sigma & \text{tr } N^T \Gamma^T \Sigma \Phi \\ \text{tr } N^T \Gamma^T \Sigma \Phi & \text{tr } N^T \Sigma \Phi^2 \end{pmatrix} \begin{pmatrix} \epsilon \\ \iota \end{pmatrix} \\ &= -\frac{1}{2} \sum_{1 \leq i < j \leq k} \begin{pmatrix} \epsilon \gamma_{ij} & \iota \phi_{ij} \end{pmatrix} \begin{pmatrix} \nu_i \sigma_{\pi(i)} + \nu_j \sigma_{\pi(j)} & -(\nu_i \sigma_{\pi(j)} + \nu_j \sigma_{\pi(i)}) \\ -(\nu_i \sigma_{\pi(j)} + \nu_j \sigma_{\pi(i)}) & \nu_i \sigma_{\pi(i)} + \nu_j \sigma_{\pi(j)} \end{pmatrix} \begin{pmatrix} \epsilon \gamma_{ij} \\ \iota \phi_{ij} \end{pmatrix} \\ & \quad - \frac{1}{2} \sum_{\substack{1 \leq i \leq k \\ k < j \leq n}} \nu_i \sigma_{\pi(i)} (\epsilon \gamma_{ij})^2, \end{aligned} \tag{10}$$

where γ_{ij} and ϕ_{ij} are the elements of Γ and Φ , respectively. Thus $\text{tr } N^T \Sigma$ is negative definite if and only if this quadratic form is negative definite. Three cases must be considered.

Case I. Σ nonsquare

The quadratic form of Equation (10) is negative definite if and only if the 2-by-2 matrices in the first sum are positive definite and the coefficients $\nu_i \sigma_{\pi(i)}$ of the second sum are positive. The matrices will be inspected first. A 2-by-2 symmetric matrix is positive definite if and only if its (1,1) element and its determinant are positive. In this case, these conditions imply that

$$\nu_i \sigma_{\pi(i)} + \nu_j \sigma_{\pi(j)} > 0, \quad (\nu_i^2 - \nu_j^2)(\sigma_{\pi(i)}^2 - \sigma_{\pi(j)}^2) > 0.$$

The condition that the determinant be positive implies that the moduli of ν_i and $\pm\sigma_{\pi(i)}$ must be similarly ordered and that the singular values must be distinct. Given that the moduli are similarly ordered, the condition that the (1,1) element $\nu_i \sigma_{\pi(i)} + \nu_j \sigma_{\pi(j)}$ be positive demands that

$$\text{sign } \sigma_{\pi(i)} = \text{sign } \nu_i \quad i = 1, \dots, k-1,$$

because if $|\nu_i| > |\nu_j|$ (implying that $|\sigma_{\pi(i)}| > |\sigma_{\pi(j)}|$) and $\text{sign } \sigma_{\pi(i)} = -\text{sign } \nu_i$, then the (1,1) element would be negative. This argument asserts nothing about the sign of the smallest singular value, which, without loss of generality, may be taken as σ_k . As stated previously, the coefficients $\nu_i \sigma_{\pi(i)}$ of the second sum of Equation (10) must be positive. Therefore

$$\text{sign } \sigma_k = \text{sign } \nu_{\pi^{-1}(k)}.$$

Case II. Σ square and nonsymmetric

In this case the second sum of Equation (10) vanishes and cannot be used to determine the sign of σ_k , but the additional structure of square matrices compensates for this loss. Consider the (square) decomposition $\Sigma = U^T K V$, where K is nonsymmetric and $U, V \in \mathbf{SO}(n)$ (the special orthogonal group $\mathbf{SO}(n) = \{ \Theta \in \mathbf{O}(n) : \det \Theta = 1 \}$). Then

$$\det \Sigma = \det K$$

and the sign of σ_k is determined.

Case III. Σ square and symmetric

When Σ is square and symmetric, Equation (9a) reduces to the matrix double bracket equation described by Brockett (1991a); i.e., $\dot{\Sigma} = [\Sigma, [\Sigma, N]]$; $\Sigma(0) = K = K^T$ defined over real k -by- k symmetric matrices with fixed eigenvalues (where the time parameter is scaled by $k-2$). Thus the flow of Σ on \mathbf{K}_σ is isospectral and $\Sigma(t)$ is symmetric for all t . The critical points of Equation (9a) occur when the eigenvalues $\lambda_i = \pm\sigma_i$ of K are along the diagonal of Σ ; i.e., $\Sigma = \text{diag}(\lambda_{\pi(1)}, \dots, \lambda_{\pi(n)})$ for some permutation π of the integers $1, \dots, k$. A square symmetric matrix K in Equation (9b) implies that $U \equiv V$; i.e., $\dot{V} = V[V^T K V, N]$; $V(0) = I$ or $\text{diag}(-1, 1, \dots, 1)$ (where the time parameter is scaled by $k-2$). Therefore $\gamma_{ij} = \phi_{ij}$ in Equation (10), which reduces to the sum

$$- \sum_{1 \leq i < j \leq k} (\nu_i - \nu_j)(\lambda_{\pi(i)} - \lambda_{\pi(j)})(\epsilon \phi_{ij})^2.$$

This sum is negative definite if and only if $\{\lambda_i\}$ and $\{\nu_i\}$ are similarly ordered.

If one of the singular values vanishes, the proof holds if the homogeneous space $(\mathbf{O}(n) \times \mathbf{O}(k))/\Delta_D \mathbf{O}(n-k)$ is replaced by $(\mathbf{O}(n) \times \mathbf{O}(k))/\Delta_D(\mathbf{O}(n-k+1) \times \mathbf{O}(1))$, and the linear space \mathfrak{k} is replaced by the linear space \mathfrak{k}' defined by the orthogonal decomposition $\mathfrak{o}(n) = \text{diag}(0, \mathfrak{o}(n-k+1)) + \mathfrak{k}'$ (direct sum). This completes the proof of the second part. ■

Remark 3.7. If K or N in Proposition 3.6 has repeated singular values, exponential stability, but not asymptotic stability, is lost.

Corollary 3.8. *Let the σ_i and the ν_i be distinct and nonzero. The following hold:*

(1) *Let $\Sigma \in \mathbf{K}_\sigma$ be nonsquare. Then \mathbf{K}_σ is connected and Equation (9a) has $2^k k!$ critical points, of which one is a sink, one is a source, and the remainder are saddle points. Also, the set of critical points of Equation (9b) is a submanifold of $\mathbf{O}(n) \times \mathbf{O}(k)$ of dimension $(n-k)(n-k-1)/2$.*

(2) Let $\Sigma \in \mathbf{K}_\sigma$ be square and nonsymmetric. Then \mathbf{K}_σ has two connected components corresponding to the sign of $\det \Sigma$. On each connected component Equation (9a) has $2^{k-1}k!$ critical points, of which one is a sink, one is a source, and the remainder are saddle points. Also, Equation (9b) has $2^{2k}k!$ critical points, of which 2^{2k} are sinks, 2^{2k} are sources, and the remainder are saddle points.

(3) Let $\Sigma \in \mathbf{K}_\sigma$ be square and symmetric. Then $\mathbf{K}_\sigma \cap \{Q \in \mathbf{R}^{k \times k} : Q = Q^T\}$ has 2^k connected components corresponding to matrices with eigenvalues $\{\pm\sigma_i\}$. On each connected component Equation (9a) has $k!$ critical points, of which one is a sink, one is a source, and the remainder are saddle points. Also, Equation (9b) has $2^k k!$ critical points, of which 2^k are sinks, 2^k are sources, and the remainder are saddle points.

Proof. Without loss of generality, let $N = \text{diag}_{n \times k}(k, \dots, 1)$. In the nonsquare case every trajectory with initial point $K \in \mathbf{K}_\sigma$ converges to the point $\text{diag}_{n \times k}(\sigma_1, \dots, \sigma_k)$, except for a finite union of codimension 1 submanifolds of \mathbf{K}_σ . But the closure of this set of initial points is \mathbf{K}_σ ; therefore \mathbf{K}_σ is path connected, and, as seen in the proof of Proposition 3.6, Equation (9a) has $2^k k!$ critical points. Furthermore, for every critical point of Equation (9a) there is a corresponding critical point (U, V) of Equation (9b). But every point in the coset $(U, V)\Delta_D \mathbf{O}(n - k)$ is also a critical point of Equation (9b).

In the square nonsymmetric case every trajectory with initial point $K \in \mathbf{K}_\sigma$ converges to the point $\text{diag}(\sigma_1, \dots, (\text{sign det } K)\sigma_k)$, except for a finite union of codimension 1 submanifolds of \mathbf{K}_σ . The closures of these sets of initial points with positive and negative determinants are path connected and disjoint; therefore \mathbf{K}_σ has two connected components, and there are $2^{k-1}k!$ critical points in each connected component. Furthermore, for every critical point of Equation (9a) there is a corresponding critical point (U, V) of Equation (9b). But every point in the coset $(U, V)\Delta_D$ is also a critical point of Equation (9b).

In the square symmetric case every trajectory with initial point $K \in \mathbf{K}_\sigma \cap \{Q \in \mathbf{R}^{k \times k} : Q = Q^T\}$ converges to the point $\text{diag}_{n \times k}(\lambda_1, \dots, \lambda_k)$, where the $\lambda_i = \pm\sigma_i$ are the ordered eigenvalues of K , except for a finite union of codimension 1 submanifolds of \mathbf{K}_σ . The closures of these isospectral sets of initial points are path connected and disjoint; therefore $\mathbf{K}_\sigma \cap \{Q \in \mathbf{R}^{k \times k} : Q = Q^T\}$ has 2^k connected components, and there are $k!$ critical points in each connected component. Furthermore, for all critical points $\text{diag}(\lambda_{\pi(1)}, \dots, \lambda_{\pi(k)})$ of Equation (9a) there is a corresponding critical point V of Equation (9b). But every point in the coset VD is also a critical point of Equation (9b). ■

Corollary 3.9. *Let the σ_i and the ν_i be distinct and nonzero. The function $\text{tr } N^T \Sigma$*

mapping \mathbf{K}_σ to the real line has $2^k k!$ critical points, of which one is a global minimum (and one is a local minimum if $n = k$), one is a global maximum (and one is a local maximum if $n = k$), and the remainder are saddle points. Furthermore, if $n > k$, the submanifold $\Delta_D \mathbf{O}(n - k)$ of $\mathbf{O}(n) \times \mathbf{O}(k)$ is a nondegenerate critical manifold of the function $\text{tr } N^T U^T K V$ mapping $\mathbf{O}(n) \times \mathbf{O}(k)$ to the real line. If $n = k$ and K is nonsymmetric, the function $\text{tr } N^T U^T K V$ has $2^{2k} k!$ critical points, of which 2^k are global minima, 2^k are local minima, 2^k are global maxima, 2^k are local maxima, and the remainder are saddle points. If $n = k$ and K is symmetric, the function $\text{tr } N^T U^T K V$ has $2^k k!$ critical points, of which 2^k are global minima, 2^k are global maxima, and the remainder are saddle points.

Corollary 3.10. *Let l be a positive integer. The matrix $(\Sigma^T \Sigma)^l$ evolves isospectrally on flows of Equation (9a).*

Proof. The corollary follows from the fact that

$$\frac{d}{dt}(\Sigma^T \Sigma)^l = \left[(\Sigma^T \Sigma)^l, \frac{k-2}{n-2} [\Sigma^T, N^T] \right]$$

is in standard isospectral form. ■

Proposition 3.11. *Let $\{\sigma_i\}$ and $\{\nu_i\}$ have distinct nonzero elements.*

(1) *Near the critical points $\Sigma = \text{diag}_{n \times k}(\pm \sigma_{\pi(1)}, \dots, \pm \sigma_{\pi(k)})$ the off-diagonal elements σ_{ij} of Equation (9a) converge exponentially with rates $r_{ij}^{(1)}$ given by the eigenvalues of the matrix*

$$R_1 = \begin{pmatrix} \frac{\nu_i \sigma_i}{k-2} + \frac{\nu_j \sigma_j}{n-2} & -\frac{\nu_j \sigma_i}{k-2} - \frac{\nu_i \sigma_j}{n-2} \\ -\frac{\nu_j \sigma_i}{n-2} - \frac{\nu_i \sigma_j}{k-2} & \frac{\nu_i \sigma_i}{n-2} + \frac{\nu_j \sigma_j}{k-2} \end{pmatrix}$$

for $1 \leq i, j \leq k$, and by

$$r_{ij}^{(1)} = \frac{\nu_i \sigma_i}{n-2}$$

for $k < i \leq n$, $1 \leq j \leq k$.

(2) *Near the critical points (U, V) such that $U^T K V = \text{diag}_{n \times k}(\pm \sigma_{\pi(1)}, \dots, \pm \sigma_{\pi(k)})$, the elements of Equation (9b) converge exponentially with rates $r_{ij}^{(2)}$ given by the eigenvalues of the matrix*

$$R_2 = \begin{pmatrix} \frac{\nu_i \sigma_i + \nu_j \sigma_j}{n-2} & -\frac{\nu_i \sigma_j + \nu_j \sigma_i}{n-2} \\ -\frac{\nu_i \sigma_i + \nu_j \sigma_j}{k-2} & \frac{\nu_i \sigma_i + \nu_j \sigma_j}{k-2} \end{pmatrix}$$

for $1 \leq i, j \leq k$, and by

$$r_{ij}^{(2)} = \frac{\nu_i \sigma_i}{n-2}$$

for $k < i \leq n$, $1 \leq j \leq k$.

$$(3) \text{ For all } i \text{ and } j, r_{ij}^{(1)} = r_{ij}^{(2)}.$$

Proof. Let $\delta U = U\delta\Gamma$ and $\delta V = V\delta\Phi$ be first order perturbations of $(U, V) \in \mathbf{O}(n) \times \mathbf{O}(k)$, i.e., $\delta\Gamma \in \mathfrak{so}(n)$ and $\delta\Phi \in \mathfrak{so}(k)$. Then

$$\delta\Sigma = \Sigma(\delta\Phi) - (\delta\Gamma)\Sigma$$

is a first order perturbation of $\Sigma \in \mathbf{K}_\sigma$. Computing the first order perturbation of Equation (9a) at the critical point $\Sigma = \text{diag}_{n \times k}(\pm\sigma_{\pi(1)}, \dots, \pm\sigma_{\pi(k)})$, it is seen that

$$\delta\dot{\Sigma} = \Sigma[(\delta\Sigma)^T, N^T] - [(\delta\Sigma), N]\Sigma.$$

This differential equation is equivalent to the set of differential equations

$$\begin{pmatrix} \delta\dot{\sigma}_{ij} \\ \delta\dot{\sigma}_{ji} \end{pmatrix} = -R_1 \begin{pmatrix} \delta\sigma_{ij} \\ \delta\sigma_{ji} \end{pmatrix}$$

for $1 \leq i, j \leq k$, and $\delta\dot{\sigma}_{ij} = -r_{ij}^{(1)}\delta\sigma_{ij}$ for $k < i \leq n$, $1 \leq j \leq k$. This establishes the first part.

Computing the first order perturbation of Equation (9b) at the critical point (U, V) such that $U^T K V = \text{diag}_{n \times k}(\pm\sigma_{\pi(1)}, \dots, \pm\sigma_{\pi(k)})$, it is seen that

$$\delta\dot{\Gamma} = -[(\delta\Gamma)\Sigma, N] + [\Sigma(\delta\Phi), N], \quad \delta\dot{\Phi} = -[(\delta\Phi)\Sigma^T, N^T] + [\Sigma^T(\delta\Gamma), N^T].$$

These differential equations are equivalent to the set of differential equations

$$\begin{pmatrix} \delta\dot{\gamma}_{ij} \\ \delta\dot{\phi}_{ij} \end{pmatrix} = -R_2 \begin{pmatrix} \delta\gamma_{ij} \\ \delta\phi_{ij} \end{pmatrix}$$

for $1 \leq i, j \leq k$, $\delta\dot{\gamma}_{ij} = -r_{ij}^{(2)}\delta\gamma_{ij}$ for $k < i \leq n$, $1 \leq j \leq k$, and $\delta\dot{\gamma}_{ij} = 0$ for $k < i, j \leq n$. This establishes the second part.

The final part follows immediately from the equalities $\text{tr } R_1 = \text{tr } R_2$ and $\det R_1 = \det R_2$. █

Remark 3.12. Equations (9a) and (9b) become

$$\begin{aligned} \dot{\Sigma} &= \frac{1}{n-2}\Sigma\Sigma^T N - \left(\frac{1}{n-2} + \frac{1}{k-2}\right)\Sigma N^T \Sigma + \frac{1}{k-2}N\Sigma^T \Sigma; & \Sigma(0) &= K, \\ \dot{U} &= \frac{1}{n-2}(K V N^T - U N V^T K^T U); & U(0) &= I, \\ \dot{V} &= \frac{1}{k-2}(K^T U N - V N^T U^T K V); & V(0) &= I, \end{aligned}$$

when the notation $[[,]]$ is expanded and $n \geq k \geq 3$.

Experimental results

The system of Equation (9b) was simulated with a Runge–Kutta algorithm with $K = \text{diag}_{7 \times 5}(1, 2, 3, 4, 5)$, $N = \text{diag}_{7 \times 5}(5, 4, 3, 2, 1)$, and the initial conditions

$$\begin{pmatrix} -0.210 & -0.091 & 0.455 & 0.668 & -0.217 & 0.490 & 0.085 \\ 0.495 & 0.365 & 0.469 & 0.291 & 0.183 & -0.413 & -0.335 \\ 0.191 & 0.647 & 0.058 & -0.237 & -0.578 & 0.154 & 0.356 \\ 0.288 & -0.285 & 0.403 & -0.539 & -0.089 & 0.461 & -0.404 \\ -0.490 & -0.022 & 0.633 & -0.339 & 0.130 & -0.340 & 0.333 \\ -0.426 & 0.598 & -0.064 & -0.088 & 0.438 & 0.364 & -0.353 \\ -0.412 & -0.005 & -0.046 & 0.017 & -0.607 & -0.325 & -0.595 \end{pmatrix}, \begin{pmatrix} 0.679 & 0.524 & 0.091 & -0.438 & 0.253 \\ -0.521 & 0.427 & 0.406 & 0.137 & 0.602 \\ 0.504 & -0.108 & 0.315 & 0.788 & 0.120 \\ -0.032 & -0.089 & 0.839 & -0.255 & -0.472 \\ 0.113 & -0.723 & 0.156 & -0.322 & 0.579 \end{pmatrix}$$

representing $U(0)$ and $V(0)$ chosen at random using Gram-Schmidt orthogonalization from $\mathcal{O}(7)$ and $\mathcal{O}(5)$, respectively. Figure 1 illustrates the convergence of the diagonal elements of Σ to the singular values 5, 4, 3, 2, 1 of K . Figure 2 illustrates the rates of convergence of a few off diagonal elements of Σ , which are tabulated in Table 1 with the predicted convergence rates of Proposition 3.11.

TABLE 1.
Convergence rates of selected elements of Σ

Convergence Rate	Exact Value	Approximate Value	Measured Value*
r_{12}	$(164 - \sqrt{25681})/15$	0.24980	0.2498
r_{43}	$(52 - \sqrt{2329})/15$	0.24935	0.2471
r_{31}	$(136 - 8\sqrt{229})/15$	0.99587	0.969
r_{24}	$(80 - 4\sqrt{265})/15$	0.99231	0.989
r_{75}	1/5	—	0.1999

* Based upon linear regression analysis.

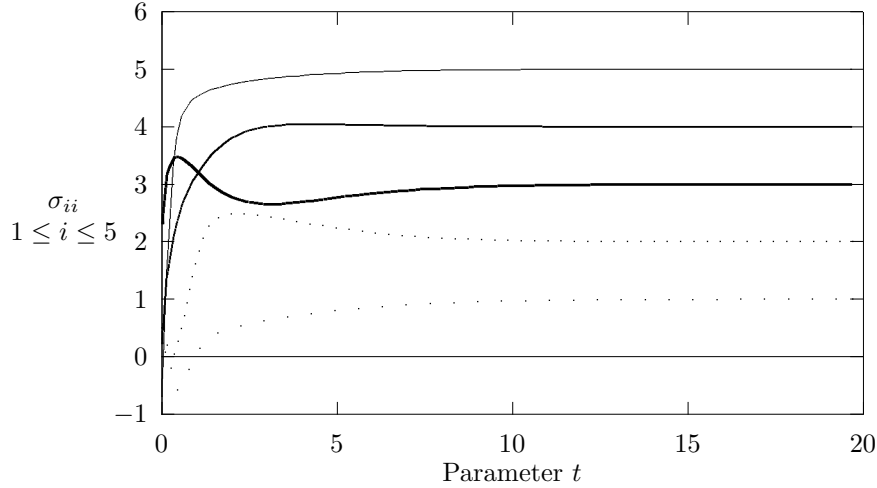

FIGURE 1. Gradient flow of the singular value decomposition on $\mathbf{K}_{\{1,2,3,4,5\}} \subset \mathbf{R}^{7 \times 5}$. The five diagonal elements of $\Sigma(t)$ satisfying Eq. (9a) are shown.

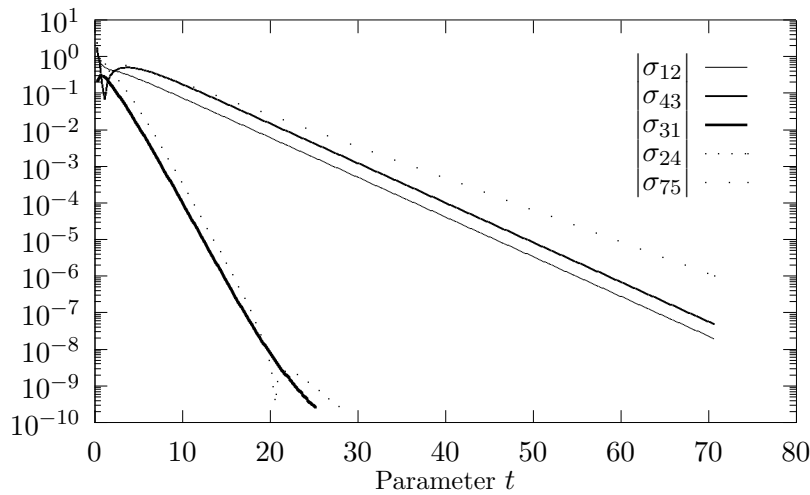

FIGURE 2. Off-diagonal convergence of SVD gradient flow on $\mathbf{K}_{\{1,2,3,4,5\}} \subset \mathbf{R}^{7 \times 5}$. Selected off-diagonal elements of $\Sigma(t)$ satisfying Eq. (9a) are shown.

CHAPTER 4

OPTIMIZATION ON RIEMANNIAN MANIFOLDS

The preponderance of optimization techniques address problems posed on Euclidean spaces. Indeed, several fundamental algorithms have arisen from the desire to compute the minimum of quadratic forms on Euclidean space. However, many optimization problems are posed on non-Euclidean spaces. For example, finding the largest eigenvalue of a symmetric matrix may be posed as the maximization of the Rayleigh quotient defined on the sphere. Optimization problems subject to nonlinear differentiable equality constraints on Euclidean space also lie within this category. Many optimization problems share with these examples the structure of a differentiable manifold endowed with a Riemannian metric. This is the subject of this chapter: the extremization of functions defined on Riemannian manifolds.

The minimization of functions on a Riemannian manifold is, at least locally, equivalent to the smoothly constrained optimization problem on a Euclidean space, because every C^∞ Riemannian manifold can be isometrically imbedded in some Euclidean space (Spivak 1979, Vol. 5). However, the dimension of the Euclidean space may be larger than the dimension of the manifold; practical and aesthetic considerations suggest that one try to exploit the intrinsic structure of the manifold. Elements of this spirit may be found throughout the field of numerical methods, such as the emphasis on unitary (norm preserving) transformations in numerical linear algebra (Golub & Van Loan 1983), or the use of feasible direction methods (Fletcher 1987, Gill & Murray 1974, Sargent 1974).

An intrinsic approach leads one from the extrinsic idea of vector addition to the exponential map and parallel translation, from minimization along lines to minimization along geodesics, and from partial differentiation to covariant differentiation. The computation of geodesics, parallel translation, and covariant derivatives can be quite expensive. For an n -dimensional manifold, the computation of geodesics and parallel translation requires the solution of a system of $2n$ nonlinear and n linear ordinary differential

equations. Nevertheless, many optimization problems are posed on manifolds that have an underlying structure that may be exploited to greatly reduce the complexity of these computations. For example, on a real compact semisimple Lie group endowed with its natural Riemannian metric, geodesics and parallel translation may be computed via matrix exponentiation (Helgason 1978). Several algorithms are available to perform this computation (Golub & Van Loan 1983, Moler & Van Loan 1978). This structure may be found in the problems posed by Brockett (1989, 1991a, 1993), Bloch et al. (1990, 1992), Smith (1991), Faybusovich (1991), Lagarias (1991), Chu et al. (1986, 1990), Perkins et al. (1990), and Helmke (1991). This approach is also applicable if the manifold can be identified with a symmetric space or, excepting parallel translation, a reductive homogeneous space (Nomizu 1954, Kobayashi & Nomizu 1969). Perhaps the simplest nontrivial example is the sphere, where geodesics and parallel translation can be computed at low cost with trigonometric functions and vector addition. If the reductive homogeneous space does not have a symmetric space structure, the result of Proposition 2.12 of Chapter 2 can be used to compute the parallel translation of arbitrary vectors along geodesics. Furthermore, Brown and Bartholomew-Biggs (1989) show that in some cases function minimization by following the solution of a system of ordinary differential equations can be implemented so as to make it competitive with conventional techniques.

The outline of the chapter is as follows. In Section 1, the optimization problem is posed and conventions to be held throughout the chapter are established. The method of steepest descent on a Riemannian manifold is described in Section 2. To fix ideas, a proof of linear convergence is given. The examples of the Rayleigh quotient on the sphere and the function $\text{tr } \Theta^T Q \Theta N$ on the special orthogonal group are presented. In Section 3, Newton's method on a Riemannian manifold is derived. As in Euclidean space, this algorithm may be used to compute the extrema of differentiable functions. It is proved that this method converges quadratically. The example of the Rayleigh quotient is continued, and it is shown that Newton's method applied to this function converges cubically, and is approximated by the Rayleigh quotient iteration. The example considering $\text{tr } \Theta^T Q \Theta N$ is continued. In a related example, it is shown that Newton's method applied to the sum of the squares of the off-diagonal elements of a symmetric matrix converges cubically. This provides an example of a cubically convergent Jacobi-like method. The conjugate gradient method is presented in Section 4 with a proof of superlinear convergence. This technique is shown to provide an effective algorithm for computing the extreme eigenvalues of a symmetric matrix. The conjugate gradient method is applied to the function $\text{tr } \Theta^T Q \Theta N$.

1. Preliminaries

This chapter is concerned with the following problem.

Problem 1.1. Let M be a complete Riemannian manifold, and f a C^∞ function on M . Compute

$$\min_{p \in M} f(p)$$

and find the minimizing point p .

There are many well-known algorithms for solving this problem in the case where M is a Euclidean space. This section generalizes several of these algorithms to the case of complete Riemannian manifolds by replacing the Euclidean notions of straight lines and ordinary differentiation with geodesics and covariant differentiation. These concepts are reviewed in Chapter 2.

Unless otherwise specified, all manifolds, vector fields, and functions are assumed to be smooth. When considering a function f to be minimized, the assumption that f is differentiable of class C^∞ can be relaxed throughout the chapter, but f must be continuously differentiable at least beyond the derivatives that appear. As the results of this chapter are local ones, the assumption that M be complete may also be relaxed in certain instances.

We will use the the following definitions to compare the convergence rates of various algorithms.

Definition 1.2. Let $\{p_i\}$ be a Cauchy sequence in M that converges to \hat{p} . (i) The sequence $\{p_i\}$ is said to converge (at least) *linearly* if there exists an integer N and a constant $\theta \in [0, 1)$ such that $d(p_{i+1}, \hat{p}) \leq \theta d(p_i, \hat{p})$ for all $i \geq N$. (ii) The sequence $\{p_i\}$ is said to converge (at least) *quadratically* if there exists an integer N and a constant $\theta \geq 0$ such that $d(p_{i+1}, \hat{p}) \leq \theta d^2(p_i, \hat{p})$ for all $i \geq N$. (iii) The sequence $\{p_i\}$ is said to converge (at least) *cubically* if there exists an integer N and a constant $\theta \geq 0$ such that $d(p_{i+1}, \hat{p}) \leq \theta d^3(p_i, \hat{p})$ for all $i \geq N$. (iv) The sequence $\{p_i\}$ is said to converge *superlinearly* if it converges faster than any sequence that converges linearly.

2. Steepest descent on Riemannian manifolds

The method of steepest descent on a Riemannian manifold is conceptually identical to the method of steepest descent on Euclidean space. Each iteration involves a gradient computation and minimization along the geodesic determined by the gradient. Fletcher (1987),

Botsaris (1978, 1981a, 1981b), and Luenberger (1973) describe this algorithm in Euclidean space. Gill and Murray (1974) and Sargent (1974) apply this technique in the presence of constraints. In this section we restate the method of steepest descent described in the literature and provide an alternative formalism that will be useful in the development of Newton's method and the conjugate gradient method on Riemannian manifolds.

Algorithm 2.1 (The method of steepest descent). Let M be a Riemannian manifold with Riemannian structure g and Levi-Civita connection ∇ , and let $f \in C^\infty(M)$.

Step 0. Select $p_0 \in M$, compute $G_0 = -(\text{grad}f)_{p_0}$, and set $i = 0$.

Step 1. Compute λ_i such that

$$f(\exp_{p_i} \lambda_i G_i) \leq f(\exp_{p_i} \lambda G_i)$$

for all $\lambda \geq 0$.

Step 2. Set

$$p_{i+1} = \exp_{p_i} \lambda_i G_i,$$

$$G_{i+1} = -(\text{grad}f)_{p_{i+1}},$$

increment i , and go to Step 1.

It is easy to verify that $\langle G_{i+1}, \tau G_i \rangle = 0$, for $i \geq 0$, where τ is the parallelism with respect to the geodesic from p_i to p_{i+1} . By assumption, the function $\lambda \mapsto f(\exp \lambda G_i)$ is minimized at λ_i . Therefore, we have $0 = (d/dt)|_{t=0} f(\exp(\lambda_i + t)G_i) = df_{p_{i+1}}(\tau G_i) = \langle (\text{grad}f)_{p_{i+1}}, \tau G_i \rangle$. Thus the method of steepest descent on a Riemannian manifold has the same deficiency as its counterpart on a Euclidean space, i.e., it makes a ninety degree turn at every step.

The convergence of Algorithm 2.1 is linear. To prove this fact, we will make use of a standard theorem of the calculus, expressed in differential geometric language. The covariant derivative $\nabla_X f$ of f along X is defined to be Xf . For $k = 1, 2, \dots$, define $\nabla_X^k f = \nabla_X \circ \dots \circ \nabla_X f$ (k times), and let $\nabla_X^0 f = f$.

Remark 2.2 (Taylor's formula). Let M be a manifold with an affine connection ∇ , N_p a normal neighborhood of $p \in M$, the vector field \tilde{X} on N_p adapted to X in T_p , and f a C^∞ function on M . Then there exists an $\epsilon > 0$ such that for every $\lambda \in [0, \epsilon)$

$$\begin{aligned} f(\exp_p \lambda X) &= f(p) + \lambda(\nabla_{\tilde{X}} f)(p) + \dots + \frac{\lambda^{n-1}}{(n-1)!} (\nabla_{\tilde{X}}^{n-1} f)(p) \\ &\quad + \frac{\lambda^n}{(n-1)!} \int_0^1 (1-t)^{n-1} (\nabla_{\tilde{X}}^n f)(\exp_p t\lambda X) dt. \end{aligned} \tag{1}$$

Proof. Let N_0 be a star-shaped neighborhood of $0 \in T_p$ such that $N_p = \exp N_0$. There exists $\epsilon > 0$ such that $\lambda X \in N_0$ for all $\lambda \in [0, \epsilon)$. The map $\lambda \mapsto f(\exp \lambda X)$ is a real C^∞ function on $[0, \epsilon)$ with derivative $(\nabla_{\tilde{X}} f)(\exp \lambda X)$. The statement follows by repeated integration by parts. ■

Note that if M is an analytic manifold with an analytic affine connection ∇ , the representation

$$f(\exp_p \lambda X) = \sum_{k=0}^{\infty} \frac{\lambda^k}{k!} (\nabla_{\tilde{X}}^k f)(p)$$

is valid for all $X \in T_p$ and all $\lambda \in [0, \epsilon)$. Helgason (1978) provides a proof.

The following special cases of Remark 2.2 will be particularly useful. When $n = 2$, Equation (1) yields

$$f(\exp_p \lambda X) = f(p) + \lambda (\nabla_{\tilde{X}} f)(p) + \lambda^2 \int_0^1 (1-t) (\nabla_{\tilde{X}}^2 f)(\exp_p t\lambda X) dt. \quad (2)$$

Furthermore, when $n = 1$, Equation (1) applied to the function $\tilde{X}f = \nabla_{\tilde{X}} f$ yields

$$(\tilde{X}f)(\exp_p \lambda X) = (\tilde{X}f)(p) + \lambda \int_0^1 (\nabla_{\tilde{X}}^2 f)(\exp_p t\lambda X) dt. \quad (3)$$

The second order terms of f near a critical point are required for the convergence proofs. Consider the second covariant differential $\nabla \nabla f = \nabla^2 f$ of a smooth function $f: M \rightarrow \mathbf{R}$. If (U, x^1, \dots, x^n) is a coordinate chart on M , then at $p \in U$ this $(0, 2)$ tensor takes the form

$$(\nabla^2 f)_p = \sum_{i,j} \left(\left(\frac{\partial^2 f}{\partial x^i \partial x^j} \right)_p - \sum_k \Gamma_{ji}^k \left(\frac{\partial f}{\partial x^k} \right)_p \right) dx^i \otimes dx^j, \quad (4)$$

where Γ_{ij}^k are the Christoffel symbols at p . If \hat{p} in U is a critical point of f , then $(\partial f / \partial x^k)_{\hat{p}} = 0$, $k = 1, \dots, n$. Therefore $(\nabla^2 f)_{\hat{p}} = (d^2 f)_{\hat{p}}$, where $(d^2 f)_{\hat{p}}$ is the Hessian of f at the critical point \hat{p} . Furthermore, for $p \in M$, $X, Y \in T_p$, and \tilde{X} and \tilde{Y} vector fields adapted to X and Y , respectively, on a normal neighborhood N_p of p , we have $(\nabla^2 f)(\tilde{X}, \tilde{Y}) = \nabla_{\tilde{Y}} \nabla_{\tilde{X}} f$ on N_p . Therefore the coefficient of the second term of the Taylor expansion of $f(\exp tX)$ is $(\nabla_{\tilde{X}}^2 f)_p = (\nabla^2 f)_p(X, X)$. Note that the bilinear form $(\nabla^2 f)_p$ on $T_p \times T_p$ is symmetric if and only if ∇ is symmetric, which true of the Levi-Civita connection by definition.

Theorem 2.3. *Let M be a complete Riemannian manifold with Riemannian structure g and Levi-Civita connection ∇ . Let $f \in C^\infty(M)$ have a nondegenerate critical point at \hat{p} such that the Hessian $(d^2 f)_{\hat{p}}$ is positive definite. Let p_i be a sequence of points in M*

converging to \hat{p} and $H_i \in T_{p_i}$ a sequence of tangent vectors such that

- (i) $p_{i+1} = \exp_{p_i} \lambda_i H_i$ for $i = 0, 1, \dots$,
- (ii) $\langle -(\text{grad}f)_{p_i}, H_i \rangle \geq c \|(\text{grad}f)_{p_i}\| \|H_i\|$ for $c \in (0, 1]$,

where λ_i is chosen such that $f(\exp \lambda_i H_i) \leq f(\exp \lambda H_i)$ for all $\lambda \geq 0$. Then there exists a constant E and a $\theta \in [0, 1)$ such that for all $i = 0, 1, \dots$,

$$d(p_i, \hat{p}) \leq E\theta^i.$$

Proof. The proof is a generalization of the one given in Polak (1971, p. 242ff) for the method of steepest descent on Euclidean space.

The existence of a convergent sequence is guaranteed by the smoothness of f . If $p_j = \hat{p}$ for some integer j , the assertion becomes trivial; assume otherwise. By the smoothness of f , there exists an open neighborhood U of \hat{p} such that $(\nabla^2 f)_p$ is positive definite for all $p \in U$. Therefore, there exist constants $k > 0$ and $K \geq k > 0$ such that for all $X \in T_p$ and all $p \in U$,

$$k\|X\|^2 \leq (\nabla^2 f)_p(X, X) \leq K\|X\|^2. \quad (5)$$

Define $X_i \in T_{\hat{p}}$ by the relations $\exp X_i = p_i$, $i = 0, 1, \dots$. By assumption, $df_{\hat{p}} = 0$ and from Equation (2), we have

$$f(p_i) - f(\hat{p}) = \int_0^1 (1-t)(\nabla_{\tilde{X}_i}^2 f)(\exp_{\hat{p}} tX_i) dt. \quad (6)$$

Combining this equality with the inequalities of (5) yields

$$\frac{1}{2}kd^2(p_i, \hat{p}) \leq f(p_i) - f(\hat{p}) \leq \frac{1}{2}Kd^2(p_i, \hat{p}). \quad (7)$$

Similarly, we have by Equation (3)

$$(\tilde{X}_i f)(p_i) = \int_0^1 (\nabla_{\tilde{X}_i}^2 f)(\exp_{\hat{p}} tX_i) dt.$$

Next, use (6) with Schwarz's inequality and the first inequality of (7) to obtain

$$\begin{aligned} kd^2(p_i, \hat{p}) &= k\|X_i\|^2 \leq \int_0^1 (\nabla_{\tilde{X}_i}^2 f)(\exp_{\hat{p}} tX_i) dt = (\tilde{X}_i f)(p_i) \\ &= df_{p_i}((\tilde{X}_i)_{p_i}) = df_{p_i}(\tau X_i) = \langle (\text{grad}f)_{p_i}, \tau X_i \rangle \\ &\leq \|(\text{grad}f)_{p_i}\| \|\tau X_i\| = \|(\text{grad}f)_{p_i}\| d(p_i, \hat{p}). \end{aligned}$$

Therefore,

$$\|(\text{grad}f)_{p_i}\| \geq kd(p_i, \hat{p}). \quad (8)$$

Define the function $\Delta: T_p \times \mathbf{R} \rightarrow \mathbf{R}$ by the equation $\Delta(X, \lambda) = f(\exp_p \lambda X) - f(p)$. By Equation (2), the second order Taylor formula, we have

$$\Delta(H_i, \lambda) = \lambda(\tilde{H}_i f)(p_i) + \frac{1}{2}\lambda^2 \int_0^1 (1-t)(\nabla_{\tilde{H}_i}^2 f)(\exp_{p_i} \lambda H_i) dt.$$

Using assumption (ii) of the theorem along with (5) we establish for $\lambda \geq 0$

$$\Delta(H_i, \lambda) \leq -\lambda c \|(\text{grad} f)_{p_i}\| \|H_i\| + \frac{1}{2}\lambda^2 K \|H_i\|^2. \quad (9)$$

We may now compute an upper bound for the rate of linear convergence θ . By assumption (i) of the theorem, λ must be chosen to minimize the right hand side of (9). This corresponds to choosing $\lambda = c \|(\text{grad} f)_{p_i}\| / K \|H_i\|$. A computation reveals that

$$\Delta(H_i, \lambda_i) \leq -\frac{c^2}{2K} \|(\text{grad} f)_{p_i}\|^2.$$

Applying (7) and (8) to this inequality and rearranging terms yields

$$f(p_{i+1}) - f(\hat{p}) \leq \theta(f(p_i) - f(\hat{p})), \quad (10)$$

where $\theta = (1 - (ck/K)^2)$. By assumption, $c \in (0, 1]$ and $0 < k \leq K$, therefore $\theta \in [0, 1)$. (Note that Schwarz's inequality bounds c below unity.) From (10) it is seen that $(f(p_i) - f(\hat{p})) \leq E\theta^i$, where $E = (f(p_0) - f(\hat{p}))$. From (7) we conclude that for $i = 0, 1, \dots$,

$$d(p_i, \hat{p}) \leq \sqrt{\frac{2E}{k}} (\sqrt{\theta})^i. \quad \blacksquare \quad (11)$$

Corollary 2.4. *If Algorithm 2.1 converges to a local minimum, it converges linearly.*

The choice $H_i = -(\text{grad} f)_{p_i}$ yields $c = 1$ in the second assumption the Theorem 2.3, which establishes the corollary.

Example 2.5 (Rayleigh quotient on the sphere). Let S^{n-1} be the imbedded sphere in \mathbf{R}^n , i.e., $S^{n-1} = \{x \in \mathbf{R}^n : x^T x = 1\}$, where $x^T y$ denotes the standard inner product on \mathbf{R}^n , which induces a metric on S^{n-1} . Geodesics on the sphere are great circles and parallel translation along geodesics is equivalent to rotating the tangent plane along the great circle. Let $x \in S^{n-1}$ and $h \in T_x$ have unit length, and $v \in T_x$ be any tangent vector. Then

$$\begin{aligned} \exp_x th &= x \cos t + h \sin t, \\ \tau h &= h \cos t - x \sin t, \\ \tau v &= v - (h^T v)(x \sin t + h(1 - \cos t)), \end{aligned}$$

where τ is the parallelism along the geodesic $t \mapsto \exp th$. Let Q be an n -by- n positive definite symmetric matrix with distinct eigenvalues and define $\rho: S^{n-1} \rightarrow \mathbf{R}$ by $\rho(x) = x^T Q x$. A computation shows that

$$\frac{1}{2}(\text{grad } \rho)_x = Qx - \rho(x)x. \quad (12)$$

The function ρ has a unique minimum and maximum point at the eigenvectors corresponding to the smallest and largest eigenvalues of Q , respectively. Because S^{n-1} is geodesically complete, the method of steepest descent in the opposite direction of the gradient converges to the eigenvector corresponding to the smallest eigenvalue of Q ; likewise for the eigenvector corresponding to the largest eigenvalue. Chu (1986) considers the continuous limit of this problem. A computation shows that $\rho(x)$ is maximized along the geodesic $\exp_x th$ ($\|h\| = 1$) when $a \cos 2t - b \sin 2t = 0$, where $a = 2x^T Q h$ and $b = \rho(x) - \rho(h)$. Thus $\cos t$ and $\sin t$ may be computed with simple algebraic functions of a and b (which appear below in Algorithm 4.5). The results of a numerical experiment demonstrating the convergence of the method of steepest descent applied to maximizing the Rayleigh quotient on S^{20} are shown in Figure 1 on page 68.

Example 2.6 (Brockett (1991a, 1993)). Consider the function $f(\Theta) = \text{tr } \Theta^T Q \Theta N$ on the special orthogonal group $\mathbf{SO}(n)$, where Q is a real symmetric matrix with distinct eigenvalues and N is a real diagonal matrix with distinct diagonal elements. It will be convenient to identify tangent vectors in T_Θ with tangent vectors in $T_I \cong \mathfrak{so}(n)$, the tangent plane at the identity, via left translation. The gradient of f (with respect to the negative Killing form of $\mathfrak{so}(n)$, scaled by $1/(n-2)$) at $\Theta \in \mathbf{SO}(n)$ is $\Theta[H, N]$, where $H = \text{Ad}_{\Theta^T}(Q) = \Theta^T Q \Theta$. The group $\mathbf{SO}(n)$ acts on the set of symmetric matrices by conjugation; the orbit of Q under the action of $\mathbf{SO}(n)$ is an isospectral submanifold of the symmetric matrices. We seek a $\hat{\Theta}$ such that $f(\hat{\Theta})$ is maximized. This point corresponds to a diagonal matrix whose diagonal entries are ordered similarly to those of N . A related example is found in Smith (1991), who considers the homogeneous space of matrices with fixed singular values, and in Chu (1990).

The Levi-Civita connection on $\mathbf{SO}(n)$ is bi-invariant and invariant with respect to inversion; therefore, geodesics and parallel translation may be computed via matrix exponentiation of elements in $\mathfrak{so}(n)$ and left (or right) translation (Helgason 1978, Chap. 2, Ex. 6). The geodesic emanating from the identity in $\mathbf{SO}(n)$ in direction $X \in \mathfrak{so}(n)$ is given by the formula $\exp_I tX = e^{Xt}$, where the right hand side denotes regular matrix exponentiation. The expense of geodesic minimization may be avoided if instead one uses Brockett's estimate (Brockett 1993) for the step size. Given $\Omega \in \mathfrak{so}(n)$, we wish

to find $t > 0$ such that $\phi(t) = \text{tr Ad}_{e^{-\Omega t}}(H)N$ is minimized. Differentiating ϕ twice shows that $\phi'(t) = -\text{tr Ad}_{e^{-\Omega t}}(\text{ad}_\Omega H)N$ and $\phi''(t) = -\text{tr Ad}_{e^{-\Omega t}}(\text{ad}_\Omega H)\text{ad}_\Omega N$, where $\text{ad}_\Omega A = [\Omega, A]$. Hence, $\phi'(0) = 2 \text{tr } H\Omega N$ and, by Schwarz's inequality and the fact that Ad is an isometry, $|\phi''(t)| \leq \|\text{ad}_\Omega H\| \|\text{ad}_\Omega N\|$. We conclude that if $\phi'(0) > 0$, then ϕ' is nonnegative on the interval

$$0 \leq t \leq \frac{2 \text{tr } H\Omega N}{\|\text{ad}_\Omega H\| \|\text{ad}_\Omega N\|}, \quad (13)$$

which provides an estimate for the step size of Step 1 in Algorithm 2.1. The results of a numerical experiment demonstrating the convergence of the method of steepest descent (ascent) in $\mathbf{SO}(20)$ using this estimate are shown in Figure 3.

3. Newton's method on Riemannian manifolds

As in the optimization of functions on Euclidean space, quadratic convergence can be obtained if the second order terms of the Taylor expansion are used appropriately. In this section we present Newton's algorithm on Riemannian manifolds, prove that its convergence is quadratic, and provide examples. Whereas the convergence proof for the method of steepest descent relies upon the Taylor expansion of the function f , the convergence proof for Newton's method will rely upon the Taylor expansion of the one-form df . Note that Newton's method has a counterpart in the theory of constrained optimization, as described by, e.g., Fletcher (1987), Bertsekas (1982b, 1982a), or Dunn (1980, 1981). The Newton method presented in this section has only local convergence properties. There is a theory of global Newton methods on Euclidean space and computational complexity; see the work of Hirsch and Smale (1979), Smale (1981, 1985), and Shub and Smale (1985, 1986a).

Let M be an n -dimensional Riemannian manifold with Riemannian structure g and Levi-Civita connection ∇ , let μ be a C^∞ one-form on M , and let p in M be such that the bilinear form $(\nabla\mu)_p: T_p \times T_p \rightarrow \mathbf{R}$ is nondegenerate. Then, by abuse of notation, we have the pair of isomorphisms

$$T_p \begin{array}{c} \xrightarrow{(\nabla\mu)_p} \\ \xleftarrow{(\nabla\mu)_p^{-1}} \end{array} T_p^*$$

with the forward map defined by $X \mapsto (\nabla_X\mu)_p = (\nabla\mu)_p(\cdot, X)$, which is nonsingular. The notation $(\nabla\mu)_p$ will henceforth be used for both the bilinear form defined by the covariant differential of μ evaluated at p and the homomorphism from T_p to T_p^* induced by this bilinear form. In case of an isomorphism, the inverse can be used to compute a point in M

where μ vanishes, if such a point exists. The case $\mu = df$ will be of particular interest, in which case $\nabla\mu = \nabla^2f$. Before expounding on these ideas, we make the following remarks.

Remark 3.1 (The mean value theorem). Let M be a manifold with affine connection ∇ , N_p a normal neighborhood of $p \in M$, the vector field \tilde{X} on N_p adapted to $X \in T_p$, μ a one-form on N_p , and τ_λ the parallelism with respect to $\exp tX$ for $t \in [0, \lambda]$. Denote the point $\exp \lambda X$ by p_λ . Then there exists an $\epsilon > 0$ such that for every $\lambda \in [0, \epsilon)$, there is an $\alpha \in [0, \lambda]$ such that

$$\tau_\lambda^{-1}\mu_{p_\lambda} - \mu_p = \lambda(\nabla_{\tilde{X}}\mu)_{p_\alpha} \circ \tau_\alpha.$$

Proof. As in the proof of Remark 2.2, there exists an $\epsilon > 0$ such that $\lambda X \in N_0$ for all $\lambda \in [0, \epsilon)$. The map $\lambda \mapsto (\tau_\lambda^{-1}\mu_{p_\lambda})(A)$, for any A in T_p , is a C^∞ function on $[0, \epsilon)$ with derivative $(d/dt)(\tau_t^{-1}\mu_{p_t})(A) = (d/dt)\mu_{p_t}(\tau_t A) = \nabla_{\tilde{X}}(\mu_{p_t}(\tau_t A)) = (\nabla_{\tilde{X}}\mu)_{p_t}(\tau_t A) + \mu_{p_t}(\nabla_{\tilde{X}}(\tau_t A)) = (\nabla_{\tilde{X}}\mu)_{p_t}(\tau_t A)$. The lemma follows from the mean value theorem of real analysis. ■

This remark can be generalized in the following way.

Remark 3.2 (Taylor's theorem). Let M be a manifold with affine connection ∇ , N_p a normal neighborhood of $p \in M$, the vector field \tilde{X} on N_p adapted to $X \in T_p$, μ a one-form on N_p , and τ_λ the parallelism with respect to $\exp tX$ for $t \in [0, \lambda]$. Denote the point $\exp \lambda X$ by p_λ . Then there exists an $\epsilon > 0$ such that for every $\lambda \in [0, \epsilon)$, there is an $\alpha \in [0, \lambda]$ such that

$$\tau_\lambda^{-1}\mu_{p_\lambda} = \mu_p + \lambda(\nabla_{\tilde{X}}\mu)_p + \cdots + \frac{\lambda^{n-1}}{(n-1)!}(\nabla_{\tilde{X}}^{n-1}\mu)_p + \frac{\lambda^n}{n!}(\nabla_{\tilde{X}}^n\mu)_{p_\alpha} \circ \tau_\alpha. \quad (14)$$

The remark follows by applying Remark 3.1 and the Taylor's theorem of real analysis to the function $\lambda \mapsto (\tau_\lambda^{-1}\mu_{p_\lambda})(A)$ for any A in T_p .

Remarks 3.1 and 3.2 can be generalized to C^∞ tensor fields, but we will only require Remark 3.2 for case $n = 2$ to make the following observation.

Let μ be a one-form on M such that for some \hat{p} in M , $\mu_{\hat{p}} = 0$. Given any p in a normal neighborhood of \hat{p} , we wish to find X in T_p such that $\exp_p X = \hat{p}$. Consider the Taylor expansion of μ about p , and let τ be the parallel translation along the unique geodesic joining p to \hat{p} . We have by our assumption that μ vanishes at \hat{p} , and from Equation (14) for $n = 2$,

$$0 = \tau^{-1}\mu_{\hat{p}} = \tau^{-1}\mu_{\exp_p X} = \mu_p + (\nabla\mu)_p(\cdot, X) + \text{h.o.t.}$$

If the bilinear form $(\nabla\mu)_p$ is nondegenerate, the tangent vector X may be approximated by discarding the higher order terms and solving the resulting linear equation

$$\mu_p + (\nabla\mu)_p(\cdot, X) = 0$$

for X , which yields

$$X = -(\nabla\mu)_p^{-1}\mu_p.$$

This approximation is the basis of the following algorithm.

Algorithm 3.3 (Newton's method). Let M be a complete Riemannian manifold with Riemannian structure g and Levi-Civita connection ∇ , and let μ be a C^∞ one-form on M .

Step 0. Select $p_0 \in M$ such that $(\nabla\mu)_{p_0}$ is nondegenerate, and set $i = 0$.

Step 1. Compute

$$H_i = -(\nabla\mu)_{p_i}^{-1}\mu_{p_i}$$

$$p_{i+1} = \exp_{p_i} H_i,$$

(assume that $(\nabla\mu)_{p_i}$ is nondegenerate), increment i , and repeat.

It can be shown that if p_0 is chosen suitably close (within the so-called domain of attraction) to a point \hat{p} in M such that $\mu_{\hat{p}} = 0$ and $(\nabla\mu)_{\hat{p}}$ is nondegenerate, then Algorithm 3.3 converges quadratically to \hat{p} . The following theorem holds for general one-forms; we will consider the case where μ is exact.

Theorem 3.4. *Let $f \in C^\infty(M)$ have a nondegenerate critical point at \hat{p} . Then there exists a neighborhood U of \hat{p} such that for any $p_0 \in U$, the iterates of Algorithm 3.3 for $\mu = df$ are well defined and converge quadratically to \hat{p} .*

The proof of this theorem is a generalization of the corresponding proof for Euclidean spaces, with an extra term containing the Riemannian curvature tensor (which of course vanishes in the latter case).

Proof. If $p_j = \hat{p}$ for some integer j , the assertion becomes trivial; assume otherwise. Define $X_i \in T_{p_i}$ by the relations $\hat{p} = \exp X_i$, $i = 0, 1, \dots$, so that $d(p_i, \hat{p}) = \|X_i\|$ (n.b. this convention is opposite that used in the proof of Theorem 2.3). Consider the geodesic triangle with vertices p_i, p_{i+1} , and \hat{p} , and sides $\exp tX_i$ from p_i to \hat{p} , $\exp tH_i$ from p_i to p_{i+1} , and $\exp tX_{i+1}$ from p_{i+1} to \hat{p} , for $t \in [0, 1]$. Let τ be the parallelism with respect to the

side $\exp tH_i$ between p_i and p_{i+1} . There exists a unique tangent vector Ξ_i in T_{p_i} defined by the equation

$$X_i = H_i + \tau^{-1}X_{i+1} + \Xi_i \quad (15)$$

(Ξ_i may be interpreted as the amount by which vector addition fails). If we use the definition $H_i = -(\nabla^2 f)_{p_i}^{-1}df_{p_i}$ of Algorithm 3.3, apply the isomorphism $(\nabla^2 f)_{p_i}: T_{p_i} \rightarrow T_{p_i}^*$ to both sides of Equation (15), we obtain the equation

$$(\nabla^2 f)_{p_i}(\tau^{-1}X_{i+1}) = df_{p_i} + (\nabla^2 f)_{p_i}X_i - (\nabla^2 f)_{p_i}\Xi_i. \quad (16)$$

By Taylor's theorem, there exists an $\alpha \in [0, 1]$ such that

$$\tau_1^{-1}df_{\hat{p}} = df_{p_i} + (\nabla_{\tilde{X}_i} df)_{p_i} + \frac{1}{2}(\nabla_{\tilde{X}_i}^2 df)_{p_\alpha} \circ \tau_\alpha, \quad (17)$$

where τ_t is the parallel translation from p_i to $p_t = \exp tX_i$. The trivial identities $(\nabla_{\tilde{X}_i} df)_{p_i} = (\nabla^2 f)_{p_i}X_i$ and $(\nabla_{\tilde{X}_i}^2 df)_{p_\alpha} = (\nabla^3 f)_{p_\alpha}(\tau_\alpha \cdot, \tau_\alpha X_i, \tau_\alpha X_i)$ will be used to replace the last two terms on the right hand side of Equation (17). Combining the assumption that $df_{\hat{p}} = 0$ with Equations (16) and (17), we obtain

$$(\nabla^2 f)_{p_i}(\tau^{-1}X_{i+1}) = -\frac{1}{2}(\nabla_{\tilde{X}_i}^2 df)_{p_\alpha} \circ \tau_\alpha - (\nabla^2 f)_{p_i}\Xi_i. \quad (18)$$

By the smoothness of f and g , there exists an $\epsilon > 0$ and constants δ' , δ'' , δ''' , all greater than zero, such that whenever p is in the convex normal ball $B_\epsilon(\hat{p})$,

- (i) $\|(\nabla^2 f)_p(\cdot, X)\| \geq \delta'\|X\|$ for all $X \in T_p$,
- (ii) $\|(\nabla^2 f)_p(\cdot, X)\| \leq \delta''\|X\|$ for all $X \in T_p$,
- (iii) $\|(\nabla^3 f)_p(\cdot, X, X)\| \leq \delta'''\|X\|^2$ for all $X \in T_p$,

where the induced norm on T_p^* is used in all three cases. Taking the norm of both sides of Equation (18), applying the triangle inequality to the right hand side, and using the fact that parallel translation is an isometry, we obtain the inequality

$$\delta' d(p_{i+1}, \hat{p}) \leq \delta''' d^2(p_i, \hat{p}) + \delta'' \|\Xi_i\|. \quad (19)$$

The length of Ξ_i can be bounded by a cubic expression in $d(p_i, \hat{p})$ by considering the distance between the points $\exp(H_i + \tau^{-1}X_{i+1})$ and $\exp X_{i+1} = \hat{p}$. Given $p \in M$, $\epsilon > 0$ small enough, let $a, v \in T_p$ be such that $\|a\| + \|v\| \leq \epsilon$, and let τ be the parallel translation with respect to the geodesic from p to $q = \exp_p a$. Karcher (1977, App. C2.2) shows that

$$d(\exp_p(a+v), \exp_q(\tau v)) \leq \|a\| \cdot \text{const.} (\max |K|) \cdot \epsilon^2, \quad (20)$$

where K is the sectional curvature of M along any section in the tangent plane at any point near p .

There exists a constant $c > 0$ such that $\|\Xi_i\| \leq cd(\hat{p}, \exp(H_i + \tau^{-1}X_{i+1}))$. By (20), we have $\|\Xi_i\| \leq \text{const.} \|H_i\| \epsilon^2$. Taking the norm of both sides of the Taylor formula $df_{p_i} = -\int_0^1 (\nabla_{\hat{X}_i} df)(\exp tX_i) dt$ and applying a standard integral inequality and inequality (ii) from above yields $\|df_{p_i}\| \leq \delta'' \|X_i\|$ so that $\|H_i\| \leq \text{const.} \|X_i\|$. Furthermore, we have the triangle inequality $\|X_{i+1}\| \leq \|X_i\| + \|H_i\|$, therefore ϵ may be chosen such that $\|H_i\| + \|X_{i+1}\| \leq \epsilon \leq \text{const.} \|X_i\|$. By (20) there exists $\delta^{\text{iv}} > 0$ such that $\|\Xi_i\| \leq \delta^{\text{iv}} d^3(p_i, \hat{p})$. ■

Corollary 3.5. *If $(\nabla^2 f)_{\hat{p}}$ is positive (negative) definite and Algorithm 3.3 converges to \hat{p} , then Algorithm 3.3 converges quadratically to a local minimum (maximum) of f .*

Example 3.6 (Rayleigh quotient on the sphere). Let S^{n-1} and $\rho(x) = x^T Q x$ be as in Example 2.5. It will be convenient to work with the coordinates x^1, \dots, x^n of the ambient space \mathbf{R}^n , treat the tangent plane $T_x S^{n-1}$ as a vector subspace of \mathbf{R}^n , and make the identification $T_x S^{n-1} \cong T_x^* S^{n-1}$ via the metric. In this coordinate system, geodesics on the sphere obey the second order differential equation $\ddot{x}^k + x^k = 0$, $k = 1, \dots, n$. Thus the Christoffel symbols are given by $\Gamma_{ij}^k = \delta_{ij} x^k$, where δ_{ij} is the Kronecker delta. The ij th component of the second covariant differential of ρ at x in S^{n-1} is given by (cf. Equation (4))

$$((\nabla^2 \rho)_x)_{ij} = 2Q_{ij} - \sum_{k,l} \delta_{ij} x^k \cdot 2Q_{kl} x^l = 2(Q_{ij} - \rho(x) \delta_{ij}),$$

or, written as matrices,

$$\frac{1}{2}(\nabla^2 \rho)_x = Q - \rho(x)I. \quad (21)$$

Let u be a tangent vector in $T_x S^{n-1}$. A linear operator $A: \mathbf{R}^n \rightarrow \mathbf{R}^n$ defines a linear operator on the tangent plane $T_x S^{n-1}$ for each x in S^{n-1} such that

$$A \cdot u = Au - (x^T Au)x = (I - xx^T)Au.$$

If A is invertible as an endomorphism of the ambient space \mathbf{R}^n , the solution to the linear equation $A \cdot u = v$ for u, v in $T_x S^{n-1}$ is

$$u = A^{-1} \left(v - \frac{(x^T A^{-1} v)}{(x^T A^{-1} x)} x \right). \quad (22)$$

For Newton's method, the direction H_i in $T_x S^{n-1}$ is the solution of the equation

$$(\nabla^2 \rho)_{x_i} \cdot H_i = -(\text{grad } \rho)_{x_i}.$$

Combining Equations (12), (21), and (22), we obtain

$$H_i = -x_i + \alpha_i(Q - \rho(x_i)I)^{-1}x_i,$$

where $\alpha_i = 1/x_i^T(Q - \rho(x_i)I)^{-1}x_i$. This gives rise to the following algorithm for computing eigenvectors of the symmetric matrix Q .

Algorithm 3.7 (Newton-Rayleigh quotient method). Let Q be a real symmetric n -by- n matrix.

Step 0. Select x_0 in \mathbf{R}^n such that $x_0^T x_0 = 1$, and set $i = 0$.

Step 1. Compute

$$y_i = (Q - \rho(x_i)I)^{-1}x_i$$

and set $\alpha_i = 1/x_i^T y_i$.

Step 2. Compute

$$H_i = -x_i + \alpha_i y_i, \quad \theta_i = \|H_i\|,$$

$$x_{i+1} = x_i \cos \theta_i + H_i \sin \theta_i / \theta_i,$$

increment i , and go to Step 1.

The quadratic convergence guaranteed by Theorem 3.4 is in fact too conservative for Algorithm 3.7. As evidenced by Figure 1, Algorithm 3.7 converges cubically.

Proposition 3.8. *If λ is a distinct eigenvalue of the symmetric matrix Q , and Algorithm 3.7 converges to the corresponding eigenvector \hat{x} , then it converges cubically.*

Proof 1. In the coordinates x^1, \dots, x^n of the ambient space \mathbf{R}^n , the ijk th component of the third covariant differential of ρ at \hat{x} is $-2\lambda \hat{x}^k \delta_{ij}$. Let $X \in T_{\hat{x}}S^{n-1}$. Then $(\nabla^3 \rho)_{\hat{x}}(\cdot, X, X) = 0$ and the second order terms on the right hand side of Equation (18) vanish at the critical point. The proposition follows from the smoothness of ρ . ■

Proof 2. The proof follows Parlett's (1980, p. 72ff) proof of cubic convergence for the Rayleigh quotient iteration. Assume that for all i , $x_i \neq \hat{x}$, and denote $\rho(x_i)$ by ρ_i . For all i , there is an angle ψ_i and a unit length vector u_i defined by the equation $x_i = \hat{x} \cos \psi_i + u_i \sin \psi_i$, such that $\hat{x}^T u_i = 0$. By Algorithm 3.7

$$\begin{aligned} x_{i+1} &= \hat{x} \cos \psi_{i+1} + u_{i+1} \sin \psi_{i+1} = x_i \cos \theta_i + H_i \sin \theta_i / \theta_i \\ &= \hat{x} \left(\frac{\alpha_i \sin \theta_i}{(\lambda - \rho_i) \theta_i} + \beta_i \right) \cos \psi_i + \left(\frac{\alpha_i \sin \theta_i}{\theta_i} (Q - \rho_i I)^{-1} u_i + \beta_i u_i \right) \sin \psi_i, \end{aligned}$$

where $\beta_i = \cos \theta_i - \sin \theta_i / \theta_i$. Therefore,

$$|\tan \psi_{i+1}| = \frac{\left\| \frac{\alpha_i \sin \theta_i}{\theta_i} (Q - \rho_i I)^{-1} u_i + \beta_i u_i \right\|}{\left| \frac{\alpha_i \sin \theta_i}{(\lambda - \rho_i) \theta_i} + \beta_i \right|} \cdot |\tan \psi_i|. \quad (23)$$

The following equalities and low order approximations in terms of the small quantities $\lambda - \rho_i$, θ_i , and ψ_i are straightforward to establish: $\lambda - \rho_i = (\lambda - \rho(u_i)) \sin^2 \psi_i$, $\theta_i^2 = \cos^2 \psi_i \sin^2 \psi_i + \text{h.o.t.}$, $\alpha_i = (\lambda - \rho_i) + \text{h.o.t.}$, and $\beta_i = -\theta_i^2/3 + \text{h.o.t.}$. Thus, the denominator of the large fraction in Equation (23) is of order unity and the numerator is of order $\sin^2 \psi_i$. Therefore, we have

$$|\psi_{i+1}| = \text{const.} \cdot |\psi_i|^3 + \text{h.o.t.} \quad \blacksquare$$

Remark 3.9. If Algorithm 3.7 is simplified by replacing Step 2 with

Step 2'. Compute

$$x_{i+1} = y_i / \|y_i\|,$$

increment i , and go to Step 1.

then we obtain the Rayleigh quotient iteration. These two algorithms differ by the method in which they use the vector $y_i = (Q - \rho(x_i)I)^{-1}x_i$ to compute the next iterate on the sphere. Algorithm 3.7 computes the point H_i in $T_{x_i}S^{n-1}$ where y_i intersects this tangent plane, then computes x_{i+1} via the exponential map of this vector (which “rolls” the tangent vector H_i onto the sphere). The Rayleigh quotient iteration computes the intersection of y_i with the sphere itself and takes this intersection to be x_{i+1} . The latter approach approximates Algorithm 3.7 up to quadratic terms when x_i is close to an eigenvector. Algorithm 3.7 is more expensive to compute than—though of the same order as—the Rayleigh quotient iteration; thus, the RQI is seen to be an efficient approximation of Newton’s method.

If the exponential map is replaced by the chart $v \in T_x \mapsto (x + v) / \|x + v\| \in S^{n-1}$, Shub (1986) shows that a corresponding version of Newton’s method is equivalent to the RQI.

Example 3.10 (The function $\text{tr } \Theta^T Q \Theta N$). Let Θ , Q , $H = \text{Ad}_{\Theta^T}(Q)$, and Ω be as in Example 2.6. The second covariant differential of $f(\Theta) = \text{tr } \Theta^T Q \Theta N$ may be computed either by polarization of the second order term of $\text{tr } \text{Ad}_{e^{-\Omega t}}(H)N$, or by covariant differentiation of the differential $df_\Theta = -\text{tr}[H, N]\Theta^T(\cdot)$:

$$(\nabla^2 f)_\Theta(\Theta X, \Theta Y) = -\frac{1}{2} \text{tr}([H, \text{ad}_X N] - [\text{ad}_X H, N])Y,$$

where $X, Y \in \mathfrak{so}(n)$. To compute the direction $\Theta X \in T_\Theta$, $X \in \mathfrak{so}(n)$, for Newton's method, we must solve the equation $(\nabla^2 f)_\Theta(\Theta \cdot, \Theta X) = df_\Theta$, which yields the linear equation

$$L_\Theta(X) \stackrel{\text{def}}{=} [H, \text{ad}_X N] - [\text{ad}_X H, N] = 2[H, N].$$

The linear operator $L_\Theta: \mathfrak{so}(n) \rightarrow \mathfrak{so}(n)$ is self-adjoint for all Θ and, in a neighborhood of the maximum, negative definite. Therefore, standard iterative techniques in the vector space $\mathfrak{so}(n)$, such as the classical conjugate gradient method, may be used to solve this equation near the maximum. The results of a numerical experiment demonstrating the convergence of Newton's method in $\mathbf{SO}(20)$ are shown in Figure 3. As can be seen, Newton's method converged within round-off error in 2 iterations.

Remark 3.11. If Newton's method applied to the function $f(\Theta) = \text{tr } \Theta^T Q \Theta N$ converges to the point $\hat{\Theta}$ such that $\text{Ad}_{\hat{\Theta}^T}(Q) = H_\infty = \alpha N$, $\alpha \in \mathbf{R}$, then it converges cubically.

Proof. By covariant differentiation of $\nabla^2 f$, the third covariant differential of f at Θ evaluated at the tangent vectors $\Theta X, \Theta Y, \Theta Z \in T_\Theta$, $X, Y, Z \in \mathfrak{so}(n)$, is

$$\begin{aligned} (\nabla^3 f)_\Theta(\Theta X, \Theta Y, \Theta Z) &= -\frac{1}{4} \text{tr}([\text{ad}_Y \text{ad}_Z H, N] - [\text{ad}_Z \text{ad}_Y N, H] \\ &\quad + [H, \text{ad}_{\text{ad}_Y Z} N] - [\text{ad}_Y H, \text{ad}_Z N] + [\text{ad}_Y N, \text{ad}_Z H])X. \end{aligned}$$

If $H = \alpha N$, $\alpha \in \mathbf{R}$, then $(\nabla^3 f)_\Theta(\cdot, \Theta X, \Theta X) = 0$. Therefore, the second order terms on the right hand side of Equation (18) vanish at the critical point. The remark follows from the smoothness of f . ■

This remark illuminates how rapid convergence of Newton's method applied to the function f can be achieved in some instances. If $E_{ij} \in \mathfrak{so}(n)$ ($i < j$) is a matrix with entry +1 at element (i, j) , -1 at element (j, i) , and zero elsewhere, $X = \sum_{i < j} x^{ij} E_{ij}$, $H = \text{diag}(h_1, \dots, h_n)$, and $N = \text{diag}(\nu_1, \dots, \nu_n)$, then

$$\begin{aligned} (\nabla^3 f)_\Theta(\Theta E_{ij}, \Theta X, \Theta X) &= \\ &= -2 \sum_{k \neq i, j} x^{ik} x^{jk} ((h_i \nu_j - h_j \nu_i) + (h_j \nu_k - h_k \nu_j) + (h_k \nu_i - h_i \nu_k)). \end{aligned}$$

If the h_i are close to $\alpha \nu_i$, $\alpha \in \mathbf{R}$, for all i , then $(\nabla^3 f)_\Theta(\cdot, \Theta X, \Theta X)$ may be small, yielding a fast rate of quadratic convergence.

Example 3.12 (Jacobi's method). Let π be the projection of a square matrix onto its diagonal, and let Q be as above. Consider the maximization of the function $f(\Theta) =$

$\text{tr } H\pi(H)$, $H = \text{Ad}_{\Theta\tau}(Q)$, on the special orthogonal group. This is equivalent to minimizing the sum of the squares of the off-diagonal elements of H (Golub and Van Loan (1983) derive the classical Jacobi method). The gradient of this function at Θ is $2\Theta[H, \pi(H)]$ (Chu & Driessel 1990). By repeated covariant differentiation of f , we find

$$\begin{aligned} (\nabla f)_I(X) &= -2 \text{tr}[H, \pi(H)]X, \\ (\nabla^2 f)_I(X, Y) &= -\text{tr}([H, \text{ad}_X \pi(H)] - [\text{ad}_X H, \pi(H)] - 2[H, \pi(\text{ad}_X H)])Y \\ (\nabla^3 f)_I(X, Y, Z) &= -\frac{1}{2} \text{tr}([\text{ad}_Y \text{ad}_Z H, \pi(H)] - [\text{ad}_Z \text{ad}_Y \pi(H), H], \\ &\quad + [H, \text{ad}_{\text{ad}_Y Z} \pi(H)] - [\text{ad}_Y H, \text{ad}_Z \pi(H)] + [\text{ad}_Y \pi(H), \text{ad}_Z H] \\ &\quad + 2[H, \pi(\text{ad}_Y \text{ad}_Z H)] + 2[H, \pi(\text{ad}_Z \text{ad}_Y H)] \\ &\quad + 2[\text{ad}_Y H, \pi(\text{ad}_Z H)] - 2[H, \text{ad}_Y \pi(\text{ad}_Z H)] \\ &\quad + 2[\text{ad}_Z H, \pi(\text{ad}_Y H)] - 2[H, \text{ad}_Z \pi(\text{ad}_Y H)])X, \end{aligned}$$

where I is the identity matrix and $X, Y, Z \in \mathfrak{so}(n)$. It is easily shown that if $[H, \pi(H)] = 0$, i.e., if H is diagonal, then $(\nabla^3 f)_{\Theta}(\cdot, \Theta X, \Theta X) = 0$ (n.b. $\pi(\text{ad}_X H) = 0$). Therefore, by the same argument as the proof of Remark 3.11, Newton's method applied to the function $\text{tr } H\pi(H)$ converges cubically.

4. Conjugate gradient method on Riemannian manifolds

The method of steepest descent provides an optimization technique which is relatively inexpensive per iteration, but converges relatively slowly. Each step requires the computation of a geodesic and a gradient direction. Newton's method provides a technique which is more costly both in terms of computational complexity and memory requirements, but converges relatively rapidly. Each step requires the computation of a geodesic, a gradient, a second covariant differential, and its inverse. In this section we describe the conjugate gradient method, which has the dual advantages of algorithmic simplicity and superlinear convergence.

Hestenes and Stiefel (1952) first used conjugate gradient methods to compute the solutions of linear equations, or, equivalently, to compute the minimum of a quadratic form on \mathbf{R}^n . This approach can be modified to yield effective algorithms to compute the minima of nonquadratic functions on \mathbf{R}^n . In particular, Fletcher and Reeves (1964) and Polak and Ribière (Polak 1971) provide algorithms based upon the assumption that the second order Taylor expansion of the function to be minimized sufficiently approximates this function near the minimum. In addition, Davidon, Fletcher, and Reeves developed the variable metric methods (Davidon 1959, Fletcher 1987, Polak 1971), but these will not be discussed here.

One noteworthy feature of conjugate gradient algorithms on \mathbf{R}^n is that when the function to be minimized is quadratic, they compute its minimum in no more than n iterations, i.e., they have the property of quadratic termination.

The conjugate gradient method on Euclidean space is uncomplicated. Given a function $f: \mathbf{R}^n \rightarrow \mathbf{R}$ with continuous second derivatives and a local minimum at \hat{x} , and an initial point $x_0 \in \mathbf{R}^n$, the algorithm is initialized by computing the (negative) gradient direction $G_0 = H_0 = -(\text{grad}f)_{x_0}$. The recursive part of the algorithm involves (i) a line minimization of f along the affine space $x_i + tH_i$, $t \in \mathbf{R}$, where the minimum occurs at, say, $t = \lambda_i$, (ii) computation of the step $x_{i+1} = x_i + \lambda_i H_i$, (iii) computation of the (negative) gradient $G_{i+1} = -(\text{grad}f)_{x_{i+1}}$, and (iv) computation of the next direction for line minimization,

$$H_{i+1} = G_{i+1} + \gamma_i H_i, \quad (24)$$

where γ_i is chosen such that H_i and H_{i+1} conjugate with respect to the Hessian matrix of f at \hat{x} . When f is a quadratic form represented by the symmetric positive definite matrix Q , the conjugacy condition becomes $H_i^T Q H_{i+1} = 0$; therefore, $\gamma_i = -H_i^T Q G_{i+1} / H_i^T Q H_i$. It can be shown in this case that the sequence of vectors G_i are all mutually orthogonal and the sequence of vectors H_i are all mutually conjugate with respect to Q . Using these facts, the computation of γ_i may be simplified with the observation that $\gamma_i = \|G_{i+1}\|^2 / \|G_i\|^2$ (Fletcher-Reeves) or $\gamma_i = (G_{i+1} - G_i)^T G_{i+1} / \|G_i\|^2$ (Polak-Ribière). When f is not quadratic, it is assumed that its second order Taylor expansion sufficiently approximates f in a neighborhood of the minimum, and the γ_i are chosen so that H_i and H_{i+1} are conjugate with respect to the matrix $(\partial^2 f / \partial x^i \partial x^j)(x_{i+1})$ of second partial derivatives of f at x_{i+1} . It may be desirable to “reset” the algorithm by setting $H_{i+1} = G_{i+1}$ every r th step (frequently, $r = n$) because the conjugate gradient method does not, in general, converge in n steps if the function f is nonquadratic. However, if f is closely approximated by a quadratic function, the reset strategy may be expected to converge rapidly, whereas the unmodified algorithm may not be.

Many of these ideas have straightforward generalizations in the geometry of Riemannian manifolds; several of them have already appeared. We need only make the following definition.

Definition 4.1. Given a tensor field ω of type $(0, 2)$ on M such that for p in M , $\omega_p: T_p \times T_p \rightarrow \mathbf{R}$ is a symmetric bilinear form, the tangent vectors X and Y in T_p are said to be ω_p -conjugate or conjugate with respect to ω_p if $\omega_p(X, Y) = 0$.

An outline of the conjugate gradient method on Riemannian manifolds may now be given. Let M be an n -dimensional Riemannian manifold with Riemannian structure g and Levi-Civita connection ∇ , and let $f \in C^\infty(M)$ have a local minimum at \hat{p} . As in the conjugate gradient method on Euclidean space, choose an initial point p_0 in M and compute the (negative) gradient directions $G_0 = H_0 = -(\text{grad}f)_{p_0}$ in T_{p_0} . The recursive part of the algorithm involves minimizing f along the geodesic $t \mapsto \exp_{p_i} tH_i$, $t \in \mathbf{R}$, making a step along the geodesic to the minimum point $p_{i+1} = \exp \lambda_i H_i$, computing $G_{i+1} = -(\text{grad}f)_{p_{i+1}}$, and computing the next direction in $T_{p_{i+1}}$ for geodesic minimization. This direction is given by the formula

$$H_{i+1} = G_{i+1} + \gamma_i \tau H_i, \quad (25)$$

where τ is the parallel translation with respect to the geodesic step from p_i to p_{i+1} , and γ_i is chosen such that τH_i and H_{i+1} are $(\nabla^2 f)_{p_{i+1}}$ -conjugate, i.e.,

$$\gamma_i = -\frac{(\nabla^2 f)_{p_{i+1}}(\tau H_i, G_{i+1})}{(\nabla^2 f)_{p_{i+1}}(\tau H_i, \tau H_i)}. \quad (26)$$

Equation (26) is, in general, expensive to use because the second covariant differential of f appears. However, we can use the Taylor expansion of df about p_{i+1} to compute an efficient approximation of γ_i . By the fact that $p_i = \exp_{p_{i+1}}(-\lambda_i \tau H_i)$ and by Equation (14), we have

$$\tau df_{p_i} = \tau df_{\exp_{p_{i+1}}(-\lambda_i \tau H_i)} = df_{p_{i+1}} - \lambda_i (\nabla^2 f)_{p_{i+1}}(\cdot, \tau H_i) + \text{h.o.t.}$$

Therefore, the numerator of the right hand side of Equation (26) multiplied by the step size λ_i can be approximated by the equation

$$\begin{aligned} \lambda_i (\nabla^2 f)_{p_{i+1}}(\tau H_i, G_{i+1}) &= df_{p_{i+1}}(G_{i+1}) - (\tau df_{p_i})(G_{i+1}) \\ &= -\langle G_{i+1} - \tau G_i, G_{i+1} \rangle \end{aligned}$$

because, by definition, $G_i = -(\text{grad}f)_{p_i}$, $i = 0, 1, \dots$, and for any X in $T_{p_{i+1}}$, $(\tau df_{p_i})(X) = df_{p_i}(\tau^{-1}X) = \langle (\text{grad}f)_{p_i}, \tau^{-1}X \rangle = \langle \tau(\text{grad}f)_{p_i}, X \rangle$. Similarly, the denominator of the right hand side of Equation (26) multiplied by λ_i can be approximated by the equation

$$\begin{aligned} \lambda_i (\nabla^2 f)_{p_{i+1}}(\tau H_i, \tau H_i) &= df_{p_{i+1}}(\tau H_i) - (\tau df_{p_i})(\tau H_i) \\ &= \langle G_i, H_i \rangle \end{aligned}$$

because $\langle G_{i+1}, \tau H_i \rangle = 0$ by the assumption that f is minimized along the geodesic $t \mapsto \exp tH_i$ at $t = \lambda_i$. Combining these two approximations with Equation (26), we obtain a formula for γ_i that is relatively inexpensive to compute:

$$\gamma_i = \frac{\langle G_{i+1} - \tau G_i, G_{i+1} \rangle}{\langle G_i, H_i \rangle}. \quad (27)$$

Of course, as the connection ∇ is compatible with the metric g , the denominator of Equation (27) may be replaced, if desired, by $\langle \tau G_i, \tau H_i \rangle$.

The conjugate gradient method may now be presented in full.

Algorithm 4.2 (Conjugate gradient method). Let M be a complete Riemannian manifold with Riemannian structure g and Levi-Civita connection ∇ , and let f be a C^∞ function on M .

Step 0. Select $p_0 \in M$, compute $G_0 = H_0 = -(\text{grad}f)_{p_0}$, and set $i = 0$.

Step 1. Compute λ_i such that

$$f(\exp_{p_i} \lambda_i H_i) \leq f(\exp_{p_i} \lambda H_i)$$

for all $\lambda \geq 0$.

Step 2. Set $p_{i+1} = \exp_{p_i} \lambda_i H_i$.

Step 3. Set

$$\begin{aligned} G_{i+1} &= -(\text{grad}f)_{p_{i+1}}, \\ H_{i+1} &= G_{i+1} + \gamma_i \tau H_i, \quad \gamma_i = \frac{\langle G_{i+1} - \tau G_i, G_{i+1} \rangle}{\langle G_i, H_i \rangle}, \end{aligned}$$

where τ is the parallel translation with respect to the geodesic from p_i to p_{i+1} . If $i \equiv n-1 \pmod{n}$, set $H_{i+1} = G_{i+1}$. Increment i , and go to Step 1.

Theorem 4.3. *Let $f \in C^\infty(M)$ have a nondegenerate critical point at \hat{p} such that the Hessian $(d^2f)_{\hat{p}}$ is positive definite. Let p_i be a sequence of points in M generated by Algorithm 4.2 converging to \hat{p} . Then there exists a constant $\theta > 0$ and an integer N such that for all $i \geq N$,*

$$d(p_{i+n}, \hat{p}) \leq \theta d^2(p_i, \hat{p}).$$

Note that linear convergence is already guaranteed by Theorem 2.3.

Proof. If $p_j = \hat{p}$ for some integer j , the assertion becomes trivial; assume otherwise. Recall that if X_1, \dots, X_n is some basis for $T_{\hat{p}}$, then the map $\exp_{\hat{p}}(a^1 X_1 + \dots + a^n X_n) \xrightarrow{\nu} (a^1, \dots, a^n)$ defines a set of normal coordinates at \hat{p} . Let $N_{\hat{p}}$ be a normal neighborhood of \hat{p} on which the normal coordinates $\nu = (x^1, \dots, x^n)$ are defined. Consider the map $\nu_* f \stackrel{\text{def}}{=} f \circ \nu^{-1}: \mathbf{R}^n \rightarrow \mathbf{R}$. By the smoothness of f and \exp , $\nu_* f$ has a critical point at $0 \in \mathbf{R}^n$ such that the Hessian

matrix of ν_*f at 0 is positive definite. Indeed, by the fact that $(d\exp)_0 = \text{id}$, the ij th component of the Hessian matrix of ν_*f at 0 is given by $(d^2f)_{\hat{p}}(X_i, X_j)$.

Therefore, there exists a neighborhood U of $0 \in \mathbf{R}^n$, a constant $\theta' > 0$, and an integer N , such that for any initial point $x_0 \in U$, the conjugate gradient method on Euclidean space (with resets) applied to the function ν_*f yields a sequence of points x_i converging to 0 such that for all $i \geq N$,

$$\|x_{i+n}\| \leq \theta' \|x_i\|^2.$$

See Polak (1971, p. 260ff) for a proof of this fact. Let $x_0 = \nu(p_0)$ in U be an initial point. Because \exp is not an isometry, Algorithm 4.2 yields a different sequence of points in \mathbf{R}^n than the classical conjugate gradient method on \mathbf{R}^n (upon equating points in a neighborhood of $\hat{p} \in M$ with points in a neighborhood of $0 \in \mathbf{R}^n$ via the normal coordinates).

Nevertheless, the amount by which \exp fails to preserve inner products can be quantified via the Gauss Lemma and Jacobi's equation; see, e.g., Cheeger and Ebin (1975), or the appendices of Karcher (1977). Let t be small, and let $X \in T_{\hat{p}}$ and $Y \in T_{tX}(T_{\hat{p}}) \cong T_{\hat{p}}$ be orthonormal tangent vectors. The amount by which the exponential map changes the length of tangent vectors is approximated by the Taylor expansion

$$\|d\exp(tY)\|^2 = t^2 - \frac{1}{3}Kt^4 + \text{h.o.t.},$$

where K is the sectional curvature of M along the section in $T_{\hat{p}}$ spanned by X and Y . Therefore, near \hat{p} Algorithm 4.2 differs from the conjugate gradient method on \mathbf{R}^n applied to the function ν_*f only by third order and higher terms. Thus both algorithms have the same rate of convergence. The theorem follows. ■

Example 4.4 (Rayleigh quotient on the sphere). Applied to the Rayleigh quotient on the sphere, the conjugate gradient method provides an efficient technique to compute the eigenvectors corresponding to the largest or smallest eigenvalue of a real symmetric matrix. Let S^{n-1} and $\rho(x) = x^T Q x$ be as in Examples 2.5 and 3.6. From Algorithm 4.2, we have the following algorithm.

Algorithm 4.5 (Conjugate gradient for the extreme eigenvalue/eigenvector). Let Q be a real symmetric n -by- n matrix.

Step 0. Select x_0 in \mathbf{R}^n such that $x_0^T x_0 = 1$, compute $G_0 = H_0 = (Q - \rho(x_0)I)x_0$, and set $i = 0$.

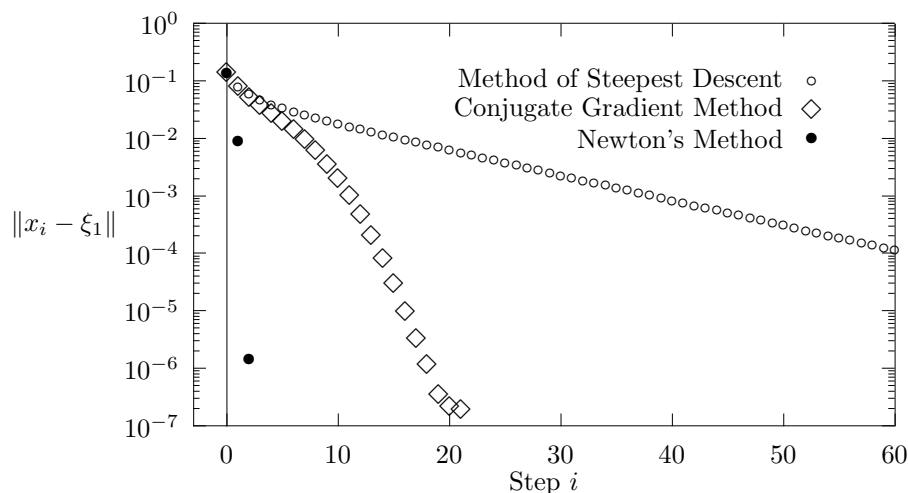

FIGURE 1. Maximization of the Rayleigh quotient $x^T Q x$ on $S^{20} \subset \mathbf{R}^{21}$, where $Q = \text{diag}(21, \dots, 1)$. The i th iterate is x_i , and ξ_1 is the eigenvector corresponding to the largest eigenvalue of Q . Algorithm 3.7 was used for Newton's method and Algorithm 4.5 was used for the conjugate gradient method.

Step 1. Compute c , s , and $v = 1 - c = s^2/(1+c)$, such that $\rho(x_i c + h_i s)$ is maximized, where $c^2 + s^2 = 1$ and $h_i = H_i/\|H_i\|$. This can be accomplished by geodesic minimization, or by the formulae

$$\begin{aligned} c &= \left(\frac{1}{2}(1 + b/r)\right)^{\frac{1}{2}} & s &= \left(\frac{1}{2}(1 - b/r)\right)^{\frac{1}{2}} \\ s &= a/(2rc) & c &= a/(2rs) \end{aligned} \quad \text{if } b \geq 0, \quad \text{or} \quad \text{if } b \leq 0,$$

where $a = 2x_i^T Q h_i$, $b = x_i^T Q x_i - h_i^T Q h_i$, and $r = \sqrt{a^2 + b^2}$.

Step 2. Set

$$x_{i+1} = x_i c + h_i s, \quad \tau H_i = H_i c - x_i \|H_i\| s, \quad \tau G_i = G_i - (h_i^T G_i)(x_i s + h_i v).$$

Step 3. Set

$$\begin{aligned} G_{i+1} &= (Q - \rho(x_{i+1})I)x_{i+1}, \\ H_{i+1} &= G_{i+1} + \gamma_i \tau H_i, \quad \gamma_i = \frac{(G_{i+1} - \tau G_i)^T G_{i+1}}{G_i^T H_i}. \end{aligned}$$

If $i \equiv n - 1 \pmod{n}$, set $H_{i+1} = G_{i+1}$. Increment i , and go to Step 1.

The convergence rate of this algorithm to the eigenvector corresponding to the largest eigenvalue of Q is given by Theorem 4.3. This algorithm requires one matrix-vector multiplication (relatively inexpensive when Q is sparse), one geodesic minimization or computation

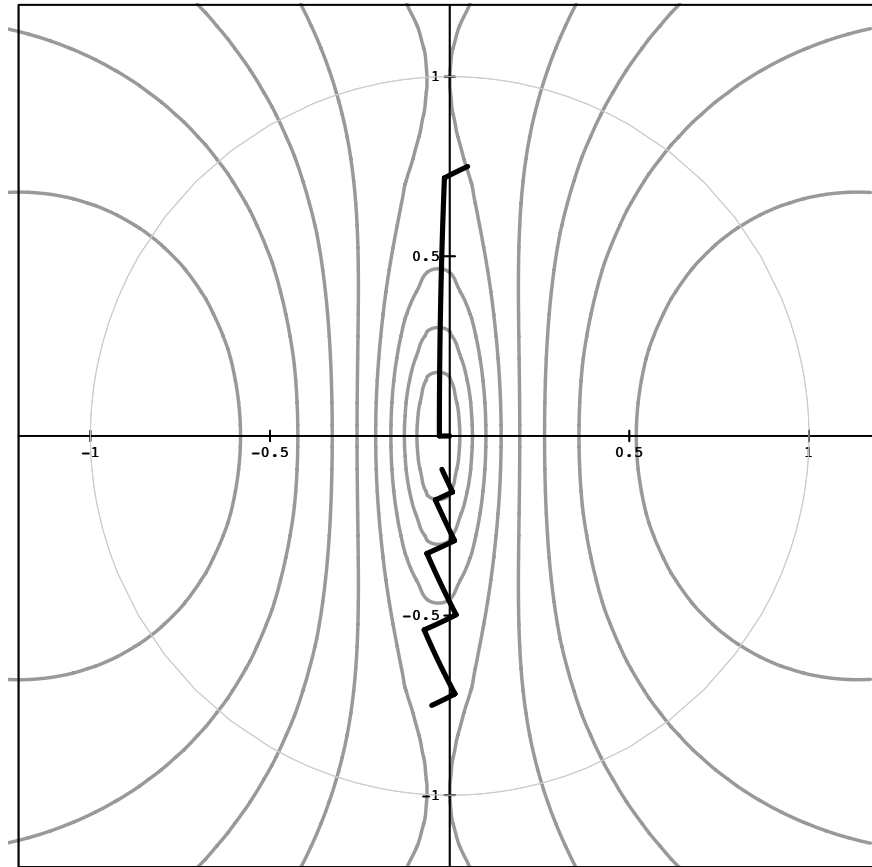

FIGURE 2. Iterates of the conjugate gradient method applied to the Rayleigh quotient on the 2-sphere. The sphere is mapped stereographically onto \mathbf{R}^2 with the north pole at the origin and the equator represented by the thin gray unit circle. Contours of the Rayleigh quotient $x^T Q x$, $Q = \text{diag}(1, 9, 10)$, are represented by the dark gray curves. The iterates of the Algorithm 4.5 are connected by geodesics shown in the upper black path. Note that this function has a nonterminating Taylor series; therefore, the quadratic termination property of the Euclidean conjugate gradient method is not seen. The iterates of the method of steepest descent are shown in the lower black path.

of $\rho(h_i)$, and $10n$ flops per iteration. The results of a numerical experiment demonstrating the convergence of Algorithm 4.5 on S^{20} are shown in Figure 1. A graphical illustration of the conjugate gradient algorithm's performance on the 2-sphere is shown in Figure 2. Stereographic projection is used to map the sphere onto the plane. There are maximum points at the north and south poles, located at the center of the image and at infinity, respectively. There are minimum points and saddle points antipodally located along the equator, which is shown by the thin gray circle. The light gray contours represent the level sets of the function $x^T Q x$ on $S^2 \subset \mathbf{R}^3$, where $Q = \text{diag}(1, 9, 10)$. The conjugate gradient method was used to compute the sequence of points at the top of the figure, and the method

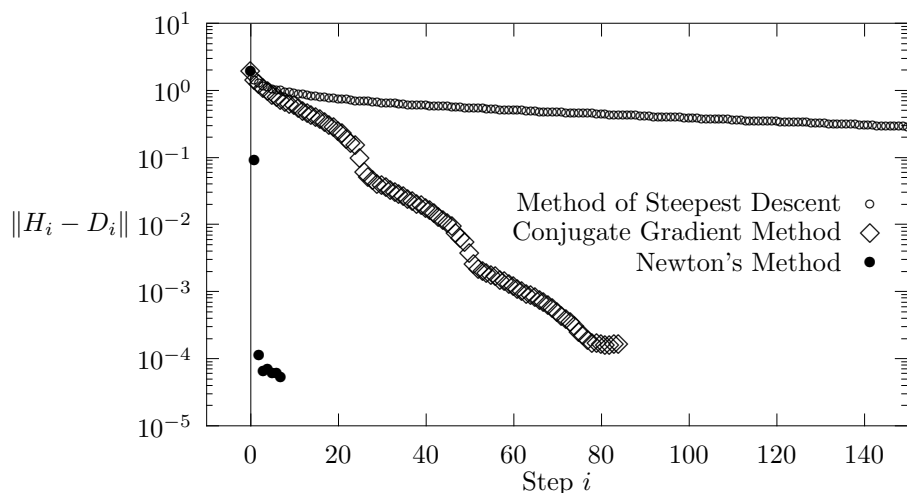

FIGURE 3. Maximization of $\text{tr } \Theta^T Q \Theta N$ on $\mathbf{SO}(20)$ (dimension $\mathbf{SO}(20) = 190$), where $Q = \text{diag}(20, \dots, 1)$ and $N = \text{diag}(20, \dots, 1)$. The i th iterate is $H_i = \Theta_i^T Q \Theta_i$, D_i is the diagonal matrix of eigenvalues of H_i , H_0 is near N , and $\|\cdot\|$ is the norm induced by the standard inner product on $\mathfrak{gl}(n)$. Geodesics and parallel translation were computed using the algorithm of Ward and Gray (1978a, 1978b); the step sizes for the method of steepest descent and the conjugate gradient method were computed using Brockett's estimate (Brockett 1993).

of steepest descent was used to compute the sequence of points at the bottom. Fuhrmann and Liu (1984) provide a conjugate gradient algorithm for the Rayleigh quotient on the sphere that uses an azimuthal projection onto tangent planes.

Example 4.6 (The function $\text{tr } \Theta^T Q \Theta N$). Let Θ , Q , and H be as in Examples 2.6 and 3.10. As before, the natural Riemannian structure of $\mathbf{SO}(n)$ is used, whereby geodesics and parallel translation along geodesics are given by Equations (14) and (15) of Chapter 2. Brockett's estimate (n.b. Equation (13)) for the step size may be used in Algorithm 4.2. The results of a numerical experiment demonstrating the convergence of the conjugate gradient method in $\mathbf{SO}(20)$ are shown in Figure 3.

CHAPTER 5

APPLICATION TO ADAPTIVE FILTERING

Principal component analysis and optimization methods are used to solve a wide variety of engineering problems. Optimization methods, such as gradient following, are often used when the solution to a given problem corresponds to the minimizing value of a real valued function, such as a square error. There are many terms for principal component analysis—the eigenvalue problem in algebra, the Karhunen-Loève expansion in stochastic processes, and factor analysis in statistics—indicating the extent of its application. Many applications use the fact that the best low rank approximation of a symmetric or Hermitian linear mapping of a vector space onto itself is given by the sum of outer products of eigenvectors corresponding to the largest eigenvalues of the linear map.

In the case of linear systems modeling, a given state space model may have an equivalent realization of lower dimension with identical input/output characteristics. Computing this lower dimensional realization is called state space reduction, and the state space model of smallest possible dimension is called a minimal realization. Moore (1981) uses the singular value decomposition of the observability and controllability matrices of a specified finite-dimensional state space model to derive a minimal realization. The process of computing a state space model given its input/output characteristics is called the identification problem. This problem is related to the field of adaptive control, where control methods that use incomplete, inaccurate, or arbitrarily time-varying models are considered. Moonen et al. (1989) use the singular value decomposition of a block Hankel matrix constructed with measured input/output data to identify linear systems. On the other hand, optimization methods for error minimization have long been used for system identification and adaptive control (Lion 1966, Åström 1983, Craig et al. 1987, Slotine & Li 1987, Tosunoglu & Tesar 1988), as well as stochastic methods that use correlation data from input and output measurements (Akaike 1974, Baram 1981, Korenburg & Hunter 1986).

Furthermore, the computation of the dominant modes and buckling modes of mechanical systems are important problems in mechanics. These problems may be expressed naturally either as infinite-dimensional eigenvalue problems or as optimization problems on an infinite dimensional Hilbert space. Approximate solutions to these problems may be obtained via finite element methods (Hughes 1987), which rely upon methods from numerical linear algebra discussed below, such as Lanczos methods. Projected conjugate gradient algorithms such as Fried's (1969) algorithm have also been proposed.

In the past fifteen years, principle component techniques have become increasingly important in the field of adaptive signal processing. This is due primarily to the introduction of new methods for signal parameter estimation which rely upon the signal's covariance structure. Notably, Schmidt (1979) developed a signal subspace algorithm called MUSIC, an acronym for multiple signal classification, which from measurements taken from a completely arbitrary sensor array provides accurate unbiased estimates of a variety of signal parameters, such as number of signals, their directions of arrival, their center frequency, and other parameters. The central idea of MUSIC is to exploit the sensor geometry and the signal subspace determined by the data to compute the desired signal parameters. Bienvenu & Kopp (1983) demonstrate how related techniques may be used when the background noise is nonisotropic.

With the MUSIC algorithm, the signal subspace is first computed from the canonical eigenvalue decomposition of the data covariance matrix. Then, knowledge of the array geometry is used to compute peaks of a function defined on a parameter space. This search is in general computationally expensive. Roy & Kailath (1989) have proposed an algorithm which retains many advantages of the MUSIC algorithm with a significantly reduced computational complexity. This algorithm is called ESPRIT, an acronym for estimation of signal parameters by rotational invariant techniques. It is important to note that the rotational invariance refers to an intrinsic property of the algorithm implied by a restriction on the sensor array; it does not refer to the invariant methods discussed in Chapter 2. It is assumed that the sensor array is comprised of a pair of subarrays that are equivalent with respect to translation. That is, there exists a translation which maps one subarray into the other. Except for this restriction, the sensor array may be arbitrary. This restriction implies that the signal subspace of the array measurements is invariant with respect to a certain complex rotation of the sensor outputs.

The signal subspace methods used in the adaptive algorithms like MUSIC and ESPRIT are especially important in the field of adaptive signal processing. In these contexts, the signal

subspaces may be thought to vary slowly with time, and it is desired to compute the time varying eigenvalue decomposition of the covariance information. Of course, one could use the symmetric QR algorithm at each time step to obtain this decomposition; however, this is prohibitively expensive, especially when only a few of the largest or smallest eigenvalues are desired, and there is a wide choice of other techniques available. In their review, Comon & Golub (1990) provide a thorough and descriptive list of many methods. They are careful to distinguish between methods that are of complexity $O(nk^2)$ and complexity $O(n^2k)$, where n is the dimension of the total space and k is the dimension of the signal subspace to be tracked.

Several of the covariance matrix updating procedures rely upon rank one updates (Owsley 1978, Karhunen 1984, Karasalo 1986, Schreiber 1986). There is a well-known theory (Wilkinson 1965) of computing the updated eigenvalue decomposition of a symmetric matrix updated by a rank one addition, and algorithms for this procedure are available (Bunch et al. 1978). However, this method requires knowledge of the full eigenvalue decomposition to compute the rank one updated decomposition; the algorithm is $O(n^3)$ complexity, which is the same order as the full QR algorithm, thus limiting its attractiveness. If the covariance matrix has at most k nonzero eigenvalues, then this algorithm may be performed in $O(n^2k)$ steps (Yu 1991). This case holds approximately when the signal-to-noise ratio is high, and when a “forgetting” factor is introduced into the covariance matrix updates.

Other updating procedures are also important. For example, a rank one update of the covariance matrix corresponds to the addition of one column to a data matrix. The updated QR decomposition of the data matrix is often desired. Golub & Van Loan (1983) provide several now classical algorithms for this task. Rader (1991) designed and built a wafer scale integrated circuit utilizing on-chip CORDIC transformations to compute the updated Cholesky factorization of a data matrix. Moonen et al. (1992) provide an updating method for the singular value decomposition of the data matrix. Demeure & Scharf (1990) describe the use of updated Toeplitz matrices in linear prediction theory.

Gradient-based algorithms are also widely used. Some of the first adaptive filtering algorithms, such as the LMS (least mean square) and SER (sequential regression) algorithms (Widrow & Stearns 1985) are gradient-based techniques. These two algorithms provide a method to compute a weighting vector for sensor outputs that provides the minimal variance of the error between the weighted measurements and a desired response. These gradient techniques, as well as the ones given by Owsley (1978), Larimore (1983), and Yang & Kaveh (1988), all have a fixed step length, which of course affects their convergence rates.

Other gradient-based algorithms are used to track the eigenvalue decomposition of a slowly varying covariance matrix. So called stochastic gradient methods (Larimore 1983, Hu 1985) are derived with the goal of maximizing the Rayleigh quotient corresponding to the data covariance matrix.

The conjugate gradient method has been suggested by many researchers as an appropriate tool for subspace tracking (Bradbury & Fletcher 1966, Chen et al. 1986, Fuhrmann & Liu 1984), as well as for finite element methods (Fried 1969). However, only Fuhrmann and Liu realized that the formula $\gamma_i = \|G_{i+1}\|^2/\|G_i\|^2$ used to ensure conjugate steps in the Euclidean case is not valid in the general case of the constrained or Riemannian conjugate gradient method, as discussed in Chapter 4, Section 4. They provide a conjugate gradient algorithm on the sphere that depends upon the choice of an azimuthal projection onto tangent planes. This algorithm is also distinguished from the others in that the steps are constrained to the sphere, whereas the others take steps in the ambient Euclidean space, then project onto the constraint surface.

In this chapter we present a new gradient-based algorithm for subspace tracking that draws on the ideas developed in the preceding three chapters. As discussed in Chapter 3, Section 2, the eigenvectors corresponding to the extreme eigenvalues of a symmetric matrix can be obtained by maximizing the generalized Rayleigh quotient. The Riemannian version of the conjugate gradient method, Algorithm 4.2, can be implemented by an efficient $O(nk^2)$ algorithm by exploiting the homogeneous space structure of the Stiefel manifold covered in Chapter 2, Section 3. The resulting conjugate gradient algorithm can be modified so that it is useful in the subspace tracking context described in the aforementioned references.

1. Adaptive estimation techniques

In this section a general data model will be described that is used in much of the literature on adaptive subspace tracking. A discrete time model is used, although this is not necessary; continuous models for subspace tracking are possible (Brockett 1991b). We imagine a collection of m signals or states that span a subspace to be identified. To each signal or state there is associated a real value at times $t = 0, 1, \dots$. Many applications require phase information and therefore use complex numbers, but for simplicity we consider only the real case; the complex version of this treatment and the algorithms to be presented are obvious generalizations. Denote the i th signal or state ($1 \leq i \leq m$) by s^i , whose value at time t is written as $s^i(t)$ or s_t^i . Hereafter we shall simply refer to states, although either signals and states may be used. Thus the states can be viewed as a vector s with components s^i in the

m -dimensional affine space \mathbf{R}^m ; the designation of quiescent values for the states makes this a vector space, which we shall endow with the standard metric. The vector s is called the state vector.

A measurement model for the state vector is now provided. It is assumed that there are n sensors whose outputs are denoted by the real numbers x^1, \dots, x^n , or simply by the data vector $x \in \mathbf{R}^n$. The data vector at time t is given by the equation

$$x_t = As_t + w_t,$$

where A is an n -by- m matrix, possibly parameterized, and w_t is a Gaussian independent random sequence.

The stationary case

Some simplifying assumptions about the state vector s will be made. It is assumed that s_t is a wide-sense stationary random sequence that is ergodic in the mean and ergodic in covariance, i.e.,

$$E[s_0] = \lim_{T \rightarrow \infty} \frac{1}{2T} \sum_{t=-T}^T s_t \quad \text{and} \quad \lim_{T \rightarrow \infty} E[s_0 s_0^T] = \frac{1}{2T} \sum_{t=-T}^T s_t s_t^T.$$

Furthermore, it is assumed for simplicity that $E[s_t] = 0$. Then the covariance matrix $R_{xx} = E[x_t x_t^T]$ of x is given by

$$R_{xx} = AR_{ss}A^T + R_{ww},$$

where R_{ss} and R_{ww} are the covariance matrices of s and w , respectively. The goal is to estimate the principal invariant subspaces of R_{xx} . Several of the covariance estimation techniques mentioned above use an averaging approach to compute an estimate of R_{xx} . For example, the estimate

$$\hat{R}_{xx} = \frac{1}{T} \sum_{t=0}^{T-1} x_t x_t^T,$$

which is easily implemented as a sequence of rank one updates, is often used. Karasalo (1986) provides an algorithm for estimating the covariance matrix of a signal which requires fewer computations than this averaging technique. Standard iterative techniques such as those mentioned above may be used to compute the principal invariant subspaces of \hat{R}_{xx} .

The nonstationary case

If the sequence s_t is nonstationary but has second order statistics that vary slowly with respect to some practical time scale, then many applications require estimates of the principal invariant subspaces of the covariance matrix R_{xx} at any given time. This is known as the tracking problem. One common approach is to form an n -by- l data matrix X from a moving window of the data vectors. I.e., the j th column of X is the data vector x_{t+j} , where $t+1$ is time of the first sample in the moving window and $t+l$ is the last. Typically l is greater than n . The estimate of R_{xx} at time $t+l$ is

$$\hat{R}_{xx} = \frac{1}{l} X X^T = \frac{1}{l} \sum_{\tau=t+1}^{t+l} x_{\tau} x_{\tau}^T. \quad (1)$$

Other approach include the so-called fading memory estimate given by the equations

$$\begin{aligned} P_{t+1} &= \hat{R}_{xx}(t) + x_{t+1} x_{t+1}^T, \\ \hat{R}_{xx}(t+1) &= P_{t+1} / \|P_{t+1}\|, \end{aligned}$$

where $\|\cdot\|$ is the Frobenius norm, or the equation

$$\hat{R}_{xx}(t+1) = \alpha_t \hat{R}_{xx}(t) + \beta_t x_{t+1} x_{t+1}^T,$$

where α and β are real-valued time sequences.

Numerical considerations

On a finite precision machine, there is a loss in accuracy that comes with squaring the data and using the estimated covariance matrix \hat{R}_{xx} explicitly. It is therefore recommended that the data matrix X be used directly. By Equation (1), the eigenvectors of \hat{R}_{xx} correspond to the left singular vectors of X . To reduce the computational effort involved in the iterative eigenvalue algorithms, the matrix X is often decomposed at each time step into the QR decomposition $X = LQ$, where L is an n -by- l lower triangular matrix and Q is an l -by- l orthogonal matrix. Because only the left singular vectors of X are desired, the orthogonal matrix Q is not required, which allows for a reduction of the computational effort. However, there must be a method for updating the QR decomposition of X at each time step.

2. Conjugate gradient method for largest eigenvalues

Computing the extreme eigenvalues and associated eigenvectors of a symmetric matrix is an important problem in general, and specifically in subspace tracking. Perhaps the

best known and most widely used algorithm for this task is the Lanczos algorithm, which may be derived by maximizing the Rayleigh quotient (Golub & Van Loan 1983). The convergence properties of the unmodified Lanczos method on a finite-precision machine are poor, however, because there is an increasing loss of orthogonality among the Lanczos vectors as the algorithm proceeds and Ritz pairs converge. Several modifications have been proposed which yield a successful algorithm, such as complete reorthogonalization, which is prohibitively expensive, selective reorthogonalization (Parlett & Scott 1979), block Lanczos methods, and s -step Lanczos methods (Cullum & Willoughby 1985). The latter methods are an iterative version of the block Lanczos method for computing the largest eigenvalues. Of necessity these algorithms are more costly than the unmodified Lanczos algorithm. Cullum & Willoughby (1985) provide a detailed analysis of practical Lanczos methods as well as a thorough bibliography. Xu and Kailath (Fast estimation, in press, Fast subspace decomposition, in press) provide fast Lanczos methods whose speed depends upon a special structure of the covariance matrix.

Given a symmetric n -by- n matrix A , Cullum (1978) considers the optimization problem

$$\max(\text{tr } X^T A X - \text{tr } Y^T A Y)$$

over all n -by- k matrices X and all n -by- l matrices Y ($k + l \leq n$) such that $X^T X = I$ and $Y^T Y = I$, i.e., $X \in V_{n,k}$ and $Y \in V_{n,l}$. In her paper it is noted that an $(s + 1)$ -step Lanczos method generates eigenvector estimates that are as least as good as an s -step constrained conjugate gradient algorithm. However, the conjugate gradient algorithm presented there is linearly convergent and does not exploit the natural Riemannian structure of the manifold as does Algorithm 4.2 of Chapter 4. See also Cullum & Willoughby (1985, pp. 217ff). Parlett et al. (1982) also use the Lanczos method for computing the largest eigenvalue of a symmetric matrix. Alternatively, O'Leary et al. (1979) propose an algorithm for computing the dominant eigenvalue of a positive definite matrix, which is based upon the power method. This algorithm is useful for rough approximation of the spectral radius of a positive definite matrix. A different point of view is offered by Overton (1992), who considers an eigenvalue optimization problem on a set of parameterized symmetric matrices.

Generalized Rayleigh quotient

Let $V_{n,k}$ be the compact Stiefel manifold of n -by- k matrices ($k \leq n$) with orthonormal columns. Recall from Chapter 3, Section 2 that given an n -by- n symmetric matrix A and a k -by- k diagonal matrix N , the generalized Rayleigh quotient is the function $\rho: V_{n,k} \rightarrow \mathbf{R}$

defined by $p \mapsto \text{tr } p^T A p N$. As described in Corollary 2.4, Chapter 3, if the extreme eigenvalues of A and the diagonal elements of N are distinct, then this function has 2^k maxima where the corresponding eigenvectors of A comprise the columns of the maximum points, modulo k choices of sign. Let us assume that our application requires the eigenvectors of a data covariance matrix corresponding to the largest eigenvalues, so that the diagonal elements of N are all positive.

As discussed in Chapter 2, Section 3, the Stiefel manifold can be identified with the reductive homogeneous space $\mathbf{O}(n)/\mathbf{O}(n-k)$. Let $G = \mathbf{O}(n)$, $M = V_{n,k}$, $o = \begin{pmatrix} I \\ 0 \end{pmatrix}$ the origin in M , and $H = \mathbf{O}(n-k)$ the isotropy group at o . Denote the Lie algebras of G and H by \mathfrak{g} and \mathfrak{h} , respectively, and let $\pi: G \rightarrow M$ be the projection $g \mapsto g \cdot o$. The tangent plane of M at o can be identified with the vector subspace $\mathfrak{m} = \mathfrak{h}^\perp$ of \mathfrak{g} , where orthogonality is with respect to the canonical invariant metric on G/H .

Let $g \in G$ be a coset representative of $p \in M$, i.e., $p = g \cdot o$. Then the tangent plane $T_p M$ can be identified with the vector subspace $\text{Ad}_g(\mathfrak{m})$ of \mathfrak{g} . The choice of coset representative is not unique, so neither is this subspace. Given $x \in \mathfrak{m}$, $x_p = \text{Ad}_g(x) \in \text{Ad}_g(\mathfrak{m})$, the unique geodesic through $o \in M$ in the direction corresponding to $x_p \in \text{Ad}_g(\mathfrak{m})$ is given by $e^{x_p t} \cdot p = g e^{x t} \cdot o$, where $e^{x t}$ denotes matrix exponentiation. As shown in the proof of Proposition 2.2, the first order term of $\rho(g e^{x t} \cdot o)$ can be used to compute the gradient of the generalized Rayleigh quotient at $p \in M$. Given the coset representative g of p , we have

$$\text{Ad}_{g^{-1}} \cdot (\text{grad } \rho)_p = [g^T A g, o N o^T] \quad (2)$$

$$= g^T A p N o^T - o N p^T A g. \quad (2')$$

From a computational standpoint, Equation (2') is preferable to Equation (2) because it can be computed with k matrix vector multiplications, whereas Equation (2) requires n matrix-vector multiplications.

Similarly, by Equation (1), Chapter 4, the second order term of $\rho(g e^{x t} \cdot o)$ can be used to compute the second covariant differential of ρ at p evaluated at (X, X) , where X is the tangent vector in $T_p M$ corresponding to $x \in \mathfrak{m}$. Because the second covariant differential at p is a symmetric bilinear form on $T_p M$, polarization of $(\nabla^2 \rho)_p(X, X)$ may be used to obtain

$$(\nabla^2 \rho)_p(X, Y) = \text{tr}(p^T A g(x y + y x) o N - 2 o^T x g^T A g y o N), \quad (3)$$

where $Y \in T_p M$ corresponds to $y \in \mathfrak{m}$.

Both Equations (2') and (3) will be used to perform the Riemannian version of the conjugate gradient method of the generalized Rayleigh quotient given in Algorithm 4.2.

The choice of coset representatives

Given p in $M = V_{n,k}$, a coset representative g in $G = \mathbf{O}(n)$ must be computed to exploit the underlying structure of the homogeneous space using the methods described above. In the case of the Stiefel manifold, a coset representative of p is simply any n -by- n orthogonal matrix whose first k columns are the k columns of p , as easily seen by examining the equality $p = g \cdot o$. The choice of coset representative is completely arbitrary, thus it is desirable to choose a representative that is least expensive in terms of both computational effort and storage requirements. For example, the element g in G could be computed by performing the Gram-Schmidt orthogonalization process, yielding a real n -by- n orthogonal matrix. This procedure requires $O(n^2k)$ operations and $O(n^2)$ storage, which are relatively expensive.

The QR decomposition, however, satisfies our requirements for low cost. Recall that for any n -by- k matrix F ($k \leq n$), there exists an n -by- n orthogonal matrix Q and an n -by- k upper triangular matrix R such that

$$F = QR.$$

There is an efficient algorithm, called Householder orthogonalization, for computing the QR decomposition of F employing Householder reflections. Specifically, we have

$$P_k \dots P_1 F = R,$$

where the P_i , $i = 1, \dots, k$ are Householder reflections of the form

$$P_i = I - \frac{1}{\beta_i} \nu_i \nu_i^T,$$

$\nu_i \in \mathbf{R}^n$, and $\beta_i = 2/\nu_i^T \nu_i$. This algorithm requires $k^2(n - k/3) + O(nk)$ operations and requires only kn storage units because the orthogonal matrix Q may be stored as a sequence of vectors used for the Householder reflections—the so-called factored form. See Golub & Van Loan (1983) for details and explanations of these facts.

Remark 2.1. Let F be an n -by- k matrix ($n \leq k$) with orthonormal columns. Then the QR decomposition of F yields an upper triangular matrix R whose off-diagonal elements vanish and diagonal elements are ± 1 .

Therefore, the QR decomposition provides an inexpensive method of computing a coset representative of any point p in $V_{n,k}$. Specifically, let $p \in V_{n,k}$ have the QR decomposition $p = QR$, $Q^T = P_k \dots P_1$, and partition R as $R = \begin{pmatrix} R_1 \\ 0 \end{pmatrix}$, where R_1 is a k -by- k upper triangular matrix. Then the coset representative g of p is given by

$$g = Q \cdot \text{diag}(R_1, I).$$

As discussed above, the choice of a coset representative provides an identification of the tangent plane $T_p M$ with the vector subspace \mathfrak{m} . The conjugate gradient algorithm computes a sequence of points p_i in M , all of which necessarily have different coset representatives, as well as a sequence of tangent vectors $H_i \in T_{p_i} M$ which are compared by parallel translation. Thus it will be necessary to compute how the change in the coset representative of a point changes the elements in \mathfrak{m} corresponding to tangent vectors at a point. Let g_1 and g_2 be coset representative of the point p in M , and let X be a tangent vector in $T_p M$. The elements g_1 and g_2 in G define elements x_1 and x_2 in \mathfrak{m} by the equation

$$X = \text{Ad}_{g_1}(x_1) = \text{Ad}_{g_2}(x_2).$$

Given x_1 , we wish to compute x_2 efficiently. By assumption, there exists an $h \in H$ such that $g_2 = g_1 h$. Then

$$\begin{aligned} x_2 &= (\text{Ad}_{g_2^{-1}} \circ \text{Ad}_{g_1})(x_1) \\ &= \text{Ad}_{g_2^{-1} g_1}(x) \\ &= \text{Ad}_{h^{-1}}(x). \end{aligned}$$

The vector subspace \mathfrak{m} is Ad_H -invariant; therefore, x_2 may be computed by conjugating x_1 by g_1 , then by g_2^{-1} .

Any element x in \mathfrak{m} and h in H can be partitioned as

$$\begin{aligned} x &= \begin{pmatrix} a & -b^T \\ b & 0 \end{pmatrix} & a \text{ in } \mathfrak{so}(k) \text{ and } b \text{ } (n-k)\text{-by-}k \text{ arbitrary,} \\ h &= \begin{pmatrix} I & 0 \\ 0 & h' \end{pmatrix} & h' \text{ in } \mathbf{O}(n-k). \end{aligned}$$

It is easy to see that if $x_2 = \text{Ad}_h(x_1)$, then $a_2 = a_1$ and $b_2 = h' b_1$. Thus elements $x \in \mathfrak{m}$, i.e., n -by- n matrices of the form given above, may be stored as n -by- k matrices of the form

$$x = \begin{pmatrix} a \\ b \end{pmatrix},$$

where a is a k -by- k skew-symmetric matrix and b is an $(n-k)$ -by- k matrix.

Geodesic computation

As discussed previously, the unique geodesic through $p = g \cdot o$ in M in direction $X \in T_pM$ is given by the formula

$$\exp_p tX = ge^{xt} \cdot o,$$

where $x \in \mathfrak{m}$ corresponds to $X \in T_pM$ via Ad_g . Thus geodesics in $M = V_{n,k}$ may be computed with matrix exponentiation. The problem of computing the accurate matrix exponential of a general matrix in $\mathfrak{gl}(n)$ is difficult (Moler & Van Loan 1978). However, there are stable, accurate, and efficient algorithms for computing the matrix exponential of symmetric and skew-symmetric matrices that exploit the canonical symmetric or skew-symmetric decompositions (Golub & Van Loan 1983; Ward & Gray 1978a, 1978b). Furthermore, elements in \mathfrak{m} have a special block structure that may be exploited to substantially reduce the required computational effort.

For the remainder of this section, make the stronger assumption on the dimension of $V_{n,k}$ that $2k \leq n$. Let $x = \begin{pmatrix} a & -b^T \\ b & 0 \end{pmatrix}$ be an element in \mathfrak{m} , and let the $(n - k)$ -by- k matrix b have the QR decomposition $b = QR$, where Q is an orthogonal matrix in $\mathbf{O}(n - k)$ and $R = \begin{pmatrix} R_1 \\ 0 \end{pmatrix}$ such that R_1 is a k -by- k upper triangular matrix. Then the following equality holds:

$$\begin{pmatrix} I & 0 \\ 0 & Q^T \end{pmatrix} \begin{pmatrix} a & -b^T \\ b & 0 \end{pmatrix} \begin{pmatrix} I & 0 \\ 0 & Q \end{pmatrix} = \begin{pmatrix} a & -R_1^T & 0 \\ R_1 & 0 & 0 \\ 0 & 0 & 0 \end{pmatrix}.$$

Thus, matrix exponentiation of the n -by- n skew-symmetric matrix x may be obtained by exponentiating the $2k$ -by- $2k$ skew-symmetric matrix

$$x' = \begin{pmatrix} a & -R_1^T \\ R_1 & 0 \end{pmatrix}.$$

Computing the canonical decomposition of an n -by- n skew-symmetric matrix requires about $8n^3 + O(n^2)$ operations (Ward & Gray 1978a). In the case of computing the canonical decomposition of elements in \mathfrak{m} , this is reduced to $8(2k)^3 + O(k^2)$ operations, plus the cost of $k^2(n - 4k/3) + O(nk)$ operations to perform the QR decomposition of b .

Let p in $V_{n,k}$ have the QR decomposition $p = \Psi D$, where $\Psi^T = (P_k \dots P_1) \in \mathbf{O}(n)$ and D is upper triangular such that its top k -by- k block D_1 is of the form $D_1 = \text{diag}(\pm 1, \dots, \pm 1)$. Given $x \in \mathfrak{m}$, let x be partitioned as above such that b has the QR decomposition $b = QR$, where $Q \in \mathbf{O}(n - k)$ and R is upper triangular with top k -by- k block R_1 . Let x' be the $2k$ -by- $2k$ reduced skew-symmetric matrix obtained from x by the method described in the previous paragraph. Let the $2k$ -by- $2k$ matrix x' have the canonical skew-symmetric

decomposition

$$x' = \vartheta s \vartheta^T,$$

where $\vartheta \in \mathbf{O}(2k)$ and s is of the form

$$s = \begin{pmatrix} 0 & \sigma_1 & & & & \\ -\sigma_1 & 0 & & & & \\ & & 0 & \sigma_2 & & \\ & & -\sigma_2 & 0 & & \\ & & & & \ddots & \\ & & & & & 0 & \sigma_k \\ & & & & & -\sigma_k & 0 \end{pmatrix}.$$

Then the geodesic $t \mapsto \exp_p tX = ge^{xt} \cdot o$ may be computed as follows:

$$ge^{xt} \cdot o = P_1 \dots P_k \cdot \begin{pmatrix} D_1 & 0 \\ 0 & I \end{pmatrix} \begin{pmatrix} I & 0 \\ 0 & Q \end{pmatrix} \begin{pmatrix} \vartheta & 0 \\ 0 & I \end{pmatrix} \begin{pmatrix} e^{st} & 0 \\ 0 & I \end{pmatrix} \begin{pmatrix} \vartheta^T & 0 \\ 0 & I \end{pmatrix} \begin{pmatrix} I & 0 \\ 0 & Q^T \end{pmatrix} \begin{pmatrix} I \\ 0 \end{pmatrix}. \quad (4)$$

Note well that these matrices are not partitioned conformably, and that

$$\begin{pmatrix} I & 0 \\ 0 & Q^T \end{pmatrix} \begin{pmatrix} I \\ 0 \end{pmatrix} = \begin{pmatrix} I \\ 0 \end{pmatrix}.$$

These steps may all be performed with $O(nk)$ storage, and the computational requirements are summarized in Table 1. One particularly appealing feature of the geodesic computation of Equation (4) is that within the accuracy of this computation, orthogonality of the columns of p_i is maintained for all i . Thus it is never necessary to reorthogonalize the columns of p_i as in the Lanczos algorithm.

Step direction computation

Let $p_i \in M$, $i \geq 0$, be the iterates generated by Algorithm 4.2 applied to the generalized Rayleigh quotient. The successive direction for geodesic minimization at each iterate $p_{i+1} \in M$ is given by the equation

$$H_{i+1} = G_{i+1} + \gamma_i \tau H_i, \quad \gamma_i = \frac{\langle G_{i+1} - \tau G_i, G_{i+1} \rangle}{\langle G_i, H_i \rangle}, \quad (5)$$

where G_i the the gradient of the function at the point p_i , and τ is the parallelism with respect to the geodesic from p_i to p_{i+1} . Let g_i , $i \geq 0$, be the coset representative of p_i chosen to be the QR decomposition of p_i as described above, let $h_i \in \mathfrak{m}$ correspond to $H_i \in T_{p_i}M$ via Ad_{g_i} , and let λ_i be the step length along this curve such that $p_{i+1} = \exp_{p_i} \lambda_i H_i$. The

TABLE 1.

Computational requirements of geodesic computation

Procedure	Cost
QR decomposition of p	$k^2(n - k/3) + O(nk)$
QR decomposition of x	$k^2(n - 4k/3) + O(nk)$
Canonical decomposition of x'	$64k^3 + O(k^2)$
$\text{diag}(I, Q^T) \cdot o$	0
$\text{diag}(\vartheta^T, I) \cdot o$	0
$\text{diag}(e^{st}, I) \cdot$	$4k^2$
$\text{diag}(\vartheta, I) \cdot$	$4k^3$
$\text{diag}(I, Q) \cdot$	$k^2(2n - 3k) + O(nk)$
$g \cdot$	$k^2(2n - k) + O(nk)$
Total	$6nk^2 + 62\frac{1}{3}k^3 + O(nk)$

computation of τH_i is straightforward because this this is simply the direction of the curve $t \mapsto \exp_{p_i} tH_i$ at p_{i+1} , i.e.,

$$\tau H_i = \left. \frac{d}{dt} \right|_{t=\lambda_i} g_i e^{h_i t} \cdot o.$$

Thus the element h_i in \mathfrak{m} corresponding to H_i in $T_{p_i}M$ via Ad_{g_i} is the same as the element in \mathfrak{m} corresponding to τH_i in $T_{p_{i+1}}M$ via $\text{Ad}_{(g_i e^{h_i \lambda_i})}$. However, the coset representative g_{i+1} chosen for the point p_{i+1} is in general not equal to the coset representative $g_i e^{h_i \lambda_i}$ of p_{i+1} , so the element h_i must be transformed as

$$h_i \mapsto (\text{Ad}_{g_{i+1}^{-1}} \circ \text{Ad}_{g_i e^{h_i \lambda_i}})(h_i). \quad (6)$$

This ensures that h_i is represented in the basis of $T_{p_{i+1}}M$ implied by the conventions previously established. Equation (6) is thus the only computation necessary to compute a representation of τH_i in \mathfrak{m} with respect to the coset representative g_{i+1} .

As discussed at the end of Section 2, Chapter 2, computing the parallel translation of an arbitrary tangent vector along a geodesic requires the solution of the set of structured $\frac{1}{2}k(k-1) + (n-k)k$ linear differential equations given in Equation (16), Chapter 2. In the cases $k \neq 1$ or n , the solution to these differential equations cannot be expressed as the exponential of an n -by- n matrix. Therefore, it appears to be impractical to use parallel translation to compute γ_i of Equation (5).

Instead, we fall back upon the demand that subsequent directions be conjugate with

TABLE 2.

Computational requirements of $(\nabla^2\rho)_p(X, Y)$ computation

Procedure	Cost
$(xy + yx)$	$k^2(3n - 2k)$
$g \cdot$ (thrice)	$3k^2(2n - 3k) + O(nk)$
$A \cdot$ (twice)	$2k$ mat-vec*
$\text{tr } p^T q N$	nk
Total	$9nk^2 - 11k^3 + 2k$ mat-vec + $O(nk)$

* Represents one matrix-vector multiplication.

respect to the second covariant differential of the function at a point, and use the formula

$$\gamma_i = - \frac{(\nabla^2 f)_{p_{i+1}}(\tau H_i, G_{i+1})}{(\nabla^2 f)_{p_{i+1}}(\tau H_i, \tau H_i)}. \quad (7)$$

This avoids the computation of τG_i , which is used in Equation (5), but introduces computation given by Equation (3), which requires $O(nk^2)$ operations plus $2k$ matrix-vector multiplications. The cost of computing γ_i by Equation (7) is summarized in Table 2. The cost of changing the coset representative using Equation (6) is summarized in Table 3.

The stepsize

Once the direction for geodesic minimization H_i is computed, a stepsize λ_i must be computed such that

$$\exp \lambda_i H_i \leq \exp \lambda H_i \quad \text{for all } \lambda \geq 0.$$

In the case $k = 1$ ($V_{n,1} = S^{n-1}$), Algorithm 4.5, Chapter 4, provides an explicit formula for the stepsize (which requires one matrix vector multiplication and a few $O(n)$ inner products). In the case $k = n$ ($V_{n,n} = \mathbf{O}(n)$), Brockett (1993) provides an estimate of the stepsize, which is covered in Example 2.6, Chapter 4. Consider this approach in the general context $1 \leq k \leq n$. Given $p \in M$, $g \in G$ a coset representative of p , and $x \in \mathfrak{m}$, we wish to compute $t > 0$ such that the function $t \mapsto \phi(t) = \rho(p_t) = \text{tr } p_t^T A p_t N$ is minimized, where $p_t = g e^{xt} \cdot o$. Differentiating ϕ twice shows that

$$\begin{aligned} \phi'(t) &= - \text{tr } \text{Ad}_{(g e^{xt})^T}([\text{Ad}_g x, A]) o N o^T, \\ \phi''(t) &= - \text{tr } \text{Ad}_{(g e^{xt})^T}([\text{Ad}_g x, A])[x, o N o^T]. \end{aligned}$$

TABLE 3.

Computational requirements of changing coset representation

Procedure	Cost
QR decomposition of p_i	none*
QR decomposition of p_{i+1}	none*
QR decomposition of x_i	none*
Canonical decomposition of x'_i	none*
$\text{diag}(I, Q^T) \cdot x_i$	$k^2(2n - 3k) + O(nk)$
$\text{diag}(\vartheta^T, I) \cdot$	$4k^3$
$\text{diag}(e^{st}, I) \cdot$	$4k^2$
$\text{diag}(\vartheta, I) \cdot$	$4k^3$
$\text{diag}(I, Q) \cdot$	$k^2(2n - 3k) + O(nk)$
$g_i \cdot$	$k^2(2n - k) + O(nk)$
$g_{i+1}^{-1} \cdot$	$k^2(2n - k) + O(nk)$
Total	$8nk^2 + O(nk)$

* Assumed to be pre-computed in the geodesic computation.

Hence we have $\phi'(0) = 2 \text{tr } p^T A g x o N$, which may be computed with nk^2 flops if the matrix Ap is known. By Schwarz's inequality and the fact that Ad is an isometry, we have

$$|\phi''(t)| \leq \|[\text{Ad}_g x, A]\| \| [x, oNo^T] \|.$$

The term $\| [x, oNo^T] \|$ is easily computed, but there is no efficient, i.e., $O(nk^2)$, method to compute the term $\| [\text{Ad}_g x, A] \|$.

However, there are several line minimization algorithms from classical optimization theory that may be employed in this context. In general, there is a tradeoff between the cost of the line search algorithm and its accuracy; good algorithms allow the user to specify accuracy requirements. The Wolfe-Powell line search algorithm (Fletcher 1987) is one such algorithm. It is guaranteed to converge under mild assumptions, and allows the user to specify bounds on the error of the approximate stepsize to the desired stepsize. Near the minimum of the function, an approximate stepsize may be computed via a Taylor expansion about zero:

$$\phi(t) = \phi(0) + t(\nabla_X \rho)_p + \frac{t^2}{2}(\nabla_X^2 \rho)_p + \text{h.o.t.}$$

Truncating this expansion at the third order terms and solving the resulting quadratic optimization problem yields the approximation

$$\arg \max \phi(t) = -\frac{(\nabla_X \rho)_p}{(\nabla_X^2 \rho)_p}. \quad (8)$$

Some of the information used in the computation of γ_i described above may be used to compute this choice of stepsize. In practice, this choice of stepsize may be used as a trial stepsize for the Wolfe-Powell or similar line searching algorithm. As the conjugate gradient algorithm converges, it will yield increasingly better approximations of the desired stepsize, and the iterations required in the line searching algorithm may be greatly reduced.

The sorting problem

One interesting feature of this type of optimization algorithm, discovered by Brockett (1991a), is its ability to sort lists of numbers. However, from the viewpoint of the tracking application, this property slows the algorithm's convergence because the sequence of points p_i may pass near one of the many saddle points where the columns of p_i are approximately eigenvectors. A practical algorithm would impose convergence near these saddle points because the eigenvectors may be sorted inexpensively with an $O(k \log k)$ algorithm such as heap sort. In the algorithm used in the next section, the diagonal elements of N are sorted similarly to the diagonal elements of $p^T A p$. Whenever a resorting of N occurs, the conjugate gradient algorithm is reset so that its next direction is simply the gradient direction of $\text{tr } p^T A p N$, where the diagonal of N is a sorted version of the original. Conversely, the columns of the matrix p may be re-sorted so that the diagonal of $p^T A p$ is ordered similarly to the diagonal of N . This latter procedure is accomplished efficiently if p is represented in the computer as an array of pointers to vectors.

Experimental results

Algorithm 4.2, Chapter 4, was applied to the generalized Rayleigh quotient defined on the manifold $V_{100,3}$ with $A = \text{diag}(100, 99, \dots, 1)$, $N = \text{diag}(3, 2, 1)$, and p_0 chosen at random from $V_{100,3}$ using Gram-Schmidt orthogonalization. The results are shown in Figure 1 along with the results of the method of steepest descent applied to the generalized Rayleigh quotient. Figure 2 shows the convergence of the estimated eigenvalues of the matrix A . As can be seen in Figure 1, the algorithm converged to machine accuracy in about 50 steps. Figure 2 shows that good estimates of the largest three eigenvalues are obtained in less than 25 steps. Instead of the formula for γ_i specified by this algorithm, which relies upon parallel translation of the previous gradient direction, γ_i was computed using Equation (7) in conjunction with Equation (3). The stepsize was chosen with a modified version of the the Wolfe-Powell line minimization algorithm described by Fletcher (1987) with $\rho = 0.01$ (cf. p. 30 of Fletcher), $\sigma = 0.1$ (ibid., 83), $\tau_1 = 9.0$, $\tau_2 = 0.1$, and $\tau_3 = 0.5$ (ibid., 34–36).

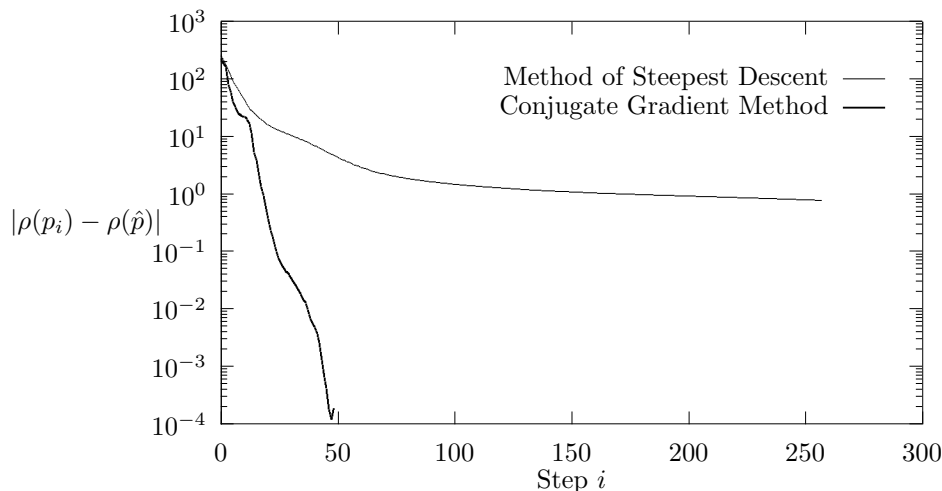

FIGURE 1. Maximization of the generalized Rayleigh quotient $\text{tr } p^T A p N$ on $V_{100,3}$ (dimension $V_{100,3} = 294$) with both the method of steepest descent and the conjugate gradient algorithm of Section 2. Here $A = \text{diag}(100, \dots, 1)$ and $N = \text{diag}(3, 2, 1)$. The i th iterate is p_i and the maximum point is \hat{p} .

The initial test stepsize was computed using Equation (8). The diagonal elements of N were sorted similarly to the diagonal elements of $p_i^T A p_i$, $i \geq 0$, and the conjugate gradient algorithm was reset to the gradient direction every time sorting took place. The algorithm was also programmed to reset every r steps with $r = \text{dimension } V_{100,3} = 294$; however, as the results of Figure 1 show, the algorithm converged to machine accuracy long before the latter type of reset would be used. The algorithm of Ward and Gray (1978a, 1978b) was used to compute the canonical decomposition of the skew-symmetric matrix x' .

Largest left singular values

Let X be an n -by- l matrix with $n \leq l$. The matrix X may be thought of as a data matrix whose principal invariant subspaces are desired, i.e., we wish to compute the eigenvectors corresponding to the largest eigenvalues of $R = X X^T$, or, equivalently, the left singular vectors corresponding to the largest singular values of X . As explained at the end of Section 1, it is desirable to work directly with the data matrix, or with the square root L of R , i.e., $R = L L^T$. This can be obtained from the QR decomposition $X = L Q$, where L is a n -by- l lower triangular matrix and Q is a l -by- l orthogonal matrix.

The conjugate gradient algorithms presented in this section may be modified to compute the largest singular vectors of X . Computations of the form $p^T R q$, where R is a symmetric matrix and p and q are arbitrary n -by- k matrices, must be replaced with the computation

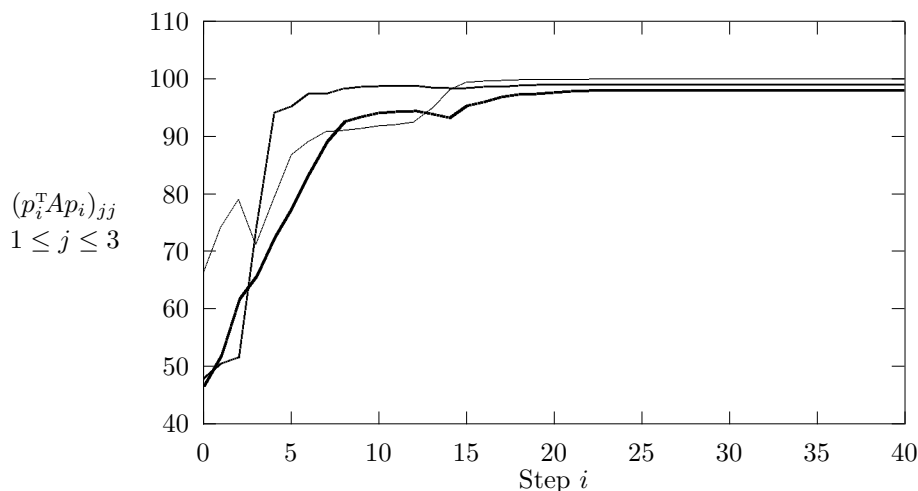

FIGURE 2. Convergence of the diagonal elements of $p_i^T A p_i$ when the conjugate gradient algorithm is applied to the generalized Rayleigh quotient on $V_{100,3}$. Here the i th iterate is p_i , and $A = \text{diag}(100, \dots, 1)$ and $N = \text{diag}(3, 2, 1)$.

$(L^T p)^T (L^T q)$, and computations of the form Rp must be replaced with $L(L^T p)$. While not as bad as explicitly computing $R = XX^T$, these methods do involve squaring the data.

It is worthwhile to ask if this may be avoided. Instead of optimizing the generalized Rayleigh quotient to obtain the largest left singular vectors, consider the function $\sigma: V_{n,k} \rightarrow \mathbf{R}$ defined by the following steps. Let $p \in V_{n,k}$, A an arbitrary n -by- n matrix, and N a real k -by- k diagonal matrix.

Step 1. Compute $B = A^T p$.

Step 2. Compute the QR decomposition of $B =: QR$, where Q is an n -by- n orthogonal matrix and R is an n -by- k upper triangular matrix whose upper k -by- k block R_1 has positive real diagonal entries ordered similarly to the diagonal of N .

Step 3. Set $\sigma(p) = \text{tr } R_1 N$.

This approach avoids the data squaring problem. Using the techniques of Chapter 3, it is straightforward to show that the critical points of σ correspond to points p whose columns are left singular vectors of A . The function σ is maximized when the corresponding singular values are similarly ordered to the diagonal elements of N .

However, computing a formula for the gradient and second covariant differential of σ is difficult. Indeed, when R_1 is singular, this function is not differentiable on $V_{n,k}$. To compute the gradient of $\sigma: V_{n,k} \rightarrow \mathbf{R}$, the first order perturbation of σ with respect to

its argument must be computed. To do this, the first order perturbations of an arbitrary QR decomposition $B_t = Q_t R_t$, where B_t is an n -by- k matrix parameterized by t , must be computed. By assumption $B_0 = Q_0 R_0$ and

$$\begin{aligned} B_t &= B_0 + tB_0Y + \cdots & Y \text{ arbitrary } n\text{-by-}k, \\ Q_t &= Q_0(I + t\Omega + \cdots) & \Omega \text{ in } \mathfrak{so}(n), \\ R_t &= R_0 + t\Psi + \cdots & \Psi \text{ arbitrary } n\text{-by-}k. \end{aligned}$$

The first order terms of $B_t = Q_t R_t$ may be written as

$$R_0 Y = \Omega R_0 + \Psi.$$

For the application we have in mind, Y is a tangent vector of the Stiefel manifold (by Step 1). To fix ideas, we shall consider the case $k = n = 2$, and set

$$Y = \begin{pmatrix} 0 & y \\ -y & 0 \end{pmatrix}, \quad R_0 = \begin{pmatrix} \alpha & \beta \\ 0 & \gamma \end{pmatrix}, \quad \Omega = \begin{pmatrix} 0 & \omega \\ -\omega & 0 \end{pmatrix}, \quad \text{and} \quad \Psi = \begin{pmatrix} \psi_1 & \psi_2 \\ 0 & \psi_3 \end{pmatrix}.$$

Solving for Ω and Ψ , we find

$$\Omega = \frac{\gamma y}{\alpha} \begin{pmatrix} 0 & 1 \\ -1 & 0 \end{pmatrix} \quad \text{and} \quad \Psi = \frac{y}{\alpha} \begin{pmatrix} -\alpha\gamma & \alpha^2 - \gamma^2 \\ 0 & \beta\gamma \end{pmatrix}.$$

There does not appear to be an efficient $O(nk^2)$ algorithm for computing the gradient of σ in general.

We can use Equation (6) of Chapter 3 to define a more tractible function for optimization. Given an arbitrary n -by- n matrix A , let $\sigma': V_{n,k} \rightarrow \mathbf{R}$ be defined by the following steps.

Step 1. Compute $B = A^T p$.

Step 2. Compute the n -by- k matrix q defined by the equation $B =: qD$ such that the columns of q have unit length and D is a k -by- k diagonal matrix.

Step 3. Set $\sigma'(p) = \text{tr } q^T A^T p N$.

This approach also avoids the data squaring problem. It can be shown that the critical points of σ' correspond to matrices $p \in V_{n,k}$ whose columns are the left singular vectors corresponding to the k largest singular values of A . The differential and gradient of σ' are straightforward to compute. Let $\zeta: \mathbf{R}^{n \times k} \rightarrow \mathbf{R}^{n \times k}$ be the projection defined by setting the

diagonal elements of an n -by- k matrix to zero. Let g be a coset representative of p , and let $x \in \mathfrak{m}$ correspond to $X \in T_p M$. Then

$$d\sigma'_p(X) = \text{tr}(\zeta(A^T g x o)^T A p + q^T A g x o) N.$$

By the fact that $\text{tr} \zeta(a)^T b = \text{tr} a^T \zeta(b)$ for $a, b \in \mathbf{R}^{n \times k}$, it is seen that the vector $v \in \mathfrak{m}$ corresponding to $(\text{grad } \sigma')_p$ is given by

$$v = (o N q^T A^T g - q^T A^T \zeta(A^T p N) o^T)_\mathfrak{m}.$$

The second covariant differential of σ' may be computed similarly, yielding the formulas necessary to implement a conjugate gradient algorithm on $V_{n,k}$ yielding the left singular vectors corresponding to the largest singular values of A .

It is also possible to compute the corresponding right singular vectors simultaneously. Consider the function $\sigma'': V_{n,k} \times V_{n,k} \rightarrow \mathbf{R}$ defined by

$$\sigma''(p, q) = \text{tr} p^T A q N.$$

The critical points of σ'' correspond to matrices p and $q \in V_{n,k}$ whose columns are left and right singular vectors of A , respectively. Optimization algorithms developed in this section may be generalized and applied to this function.

3. Conjugate gradient method for subspace tracking

Gradient-based algorithms are very appealing for tracking applications because of their ability to move in the best direction to minimize error. In the idealized scenario, the algorithm yields a sequence of points that are at or near a minimum point. When the minimum point changes, it is assumed to change slowly or continuously so that the gradient algorithm does not have far to go to follow the time varying solution.

In their review of subspace tracking algorithms, Comon & Golub (1990) provide computer simulations of the behavior of a variety of algorithms tracking a step change in the signal subspace. Specifically, they track the principal subspaces of the signal

$$x_t = \begin{cases} s_t^1 e_1 + s_t^2 e_2 & \text{if } 0 \leq t \leq T; \\ s_t^1 e_3 + s_t^2 e_4 & \text{if } t > T, \end{cases}$$

where s_t^1 and s_t^2 are wide-sense stationary random sequences and $e_1, e_2, e_3,$ and e_4 are the first four standard basis elements of \mathbf{R}^{10} . To isolate the tracking problem from the problem of covariance matrix estimation, we choose a slightly different approach here.

Instead of changing the data sample x , and updating its covariance matrix, we shall simply allow the symmetric matrix A to change arbitrarily over time, i.e., A_t is an n -by- n symmetric matrix for each $t = 0, 1, \dots$, and the goal shall be to track the largest k eigenvalues of A_t and their associated eigenvectors. Algorithm 4.2 of Chapter 4 may be modified as follows so that one conjugate gradient step is performed at every time step. Of course, more than one conjugate gradient step per time step may be performed.

Algorithm 3.1 (Conjugate gradient subspace tracking). Let A_i be a symmetric matrix for $i = 0, 1, \dots$, and denote the generalized Rayleigh quotient with respect to A_i by $p \mapsto \rho(p) = \text{tr } p^T A_i p N$. Select $p_0 \in V_{n,k}$ and set $i = 0$.

Step 1. Compute

$$G_i = (\text{grad } \rho)_{p_i}$$

via Equation (2').

Step 2. If $i \equiv 0 \pmod{\dim V_{n,k}}$, then set $H_i = G_i$. If the diagonal elements of $p_i^T A_i p_i$ are not ordered similarly to those of N , then re-sort the diagonal of N , set $H_i = G_i$, and restart the step count. Otherwise, set

$$H_i = G_i + \gamma_{i-1} \tau H_{i-1},$$

where γ_i is given by Equation (7).

Step 3. Compute λ_i such that

$$\rho(\exp_{p_i} \lambda_i H_i) \leq \rho(\exp_{p_i} \lambda H_i)$$

for all $\lambda > 0$. Use Equation (8) for an initial guess of the stepsize for the Wolfe-Powell line search.

Step 4. Set $p_{i+1} = \exp_{p_i} \lambda_i H_i$, increment i , and go to Step 1.

Experimental results

Algorithm 3.1 with $n = 100$ and $k = 4$ was applied to the time varying matrix

$$A_i = \begin{cases} \text{diag}(100, 99, \dots, 1) & \text{if } 0 \leq i \leq 40; \\ \Theta_1 \cdot \text{diag}(100, 99, \dots, 1) \cdot \Theta_1^T & \text{if } i > 40, \end{cases} \quad (9)$$

where

$$\Theta_1 = \begin{pmatrix} \cos 135^\circ & \sin 135^\circ & 0 \\ -\sin 135^\circ & \cos 135^\circ & 0 \\ 0 & 0 & I \end{pmatrix}.$$

I.e., the invariant subspace associated with the largest two eigenvalues of A_i is rotated by 135° at time $t = 40$. A slightly modified version of the algorithm was also tested, whereby the conjugate gradient algorithm was reset at $t = 40$. That is, at this time Step 2 was replaced with

Step 2'. Set $H_i = G_i$ and restart the step count.

The values of $|\rho(p_i) - \rho(\hat{p})|$, where \hat{p} is the minimizing value of ρ , resulting from these two experiments are shown in Figure 3. As may be seen, both algorithms track the step in the matrix A ; however, the reset algorithm, which “forgets” the directional information prior to $t = 40$, has better performance. Thus in a practical subspace tracking algorithm it may be desirable to reset the algorithm if there is a large jump in the value of $|\rho(p_i) - \rho(\hat{p})|$. The diagonal elements of the matrix $p_i^T A_i p_i$ resulting from Algorithm 3.1 (no reset) are shown in Figure 4. As may be seen, good estimates for the largest eigenvalues of A_i are obtained in about 5 iterations beyond the step at $t = 40$. This compares favorably to the subspace tracking algorithms tested by Comon & Golub (1990), where the fastest convergence of about 20 iterations is obtained by the Lanczos algorithm. It is important to note however, that the two experiments are different in several important ways, making a direct comparison difficult. The experiment of Comon and Golub incorporated a covariance matrix estimation technique, whereas our matrix A_i changes instantaneously. Also, Comon and Golub implicitly use the space $V_{10,2}$, whose dimension is much smaller than that of the space $V_{100,3}$ which we have selected.

In the previous experiment, the principal invariant subspace was unchanged and the corresponding eigenvalues were unchanged by the rotation Θ_1 . To test the algorithm's response to a step change in the orientation of the principal invariant subspace along with a step change in its corresponding eigenvalues, the algorithm was applied to the time varying matrix

$$A_i = \begin{cases} \text{diag}(100, 99, 98, 97, 96, 95, \dots, 1) & \text{if } 0 \leq i \leq 40; \\ \Theta_2 \cdot \text{diag}(100, 99, 98, 101, 102, 103, 94, \dots, 1) \cdot \Theta_2^T & \text{if } i > 40, \end{cases} \quad (10)$$

where $\Theta_2 = R_{14}(135^\circ) \cdot R_{25}(135^\circ) \cdot R_{36}(135^\circ)$, and $R_{ij}(\theta)$ is rotation by θ of the plane spanned by the vectors e_i and e_j . Figure 5 shows the value of $|\rho(p_i) - \rho(\hat{p})|$ and Figure 6 shows the estimated eigenvalues.

Finally, we wish to determine the algorithm's performance when principal invariant subspace changes in one step to a mutually orthogonal subspace of itself. This is important because the generalized Rayleigh quotient has many ($2^k \binom{n}{k}$) critical points, most of which

are saddle points. If the algorithm has converged exactly to a minimum point, and a step change is then introduced which makes this point a saddle point, an exact implementation of the conjugate gradient algorithm could not adapt to this change because the gradient is zero at the saddle point. However, numerical inaccuracies on a finite-precision machine eventually drive the iterates from the saddle point to the minimum point. The algorithm was applied to the time varying matrix

$$A_i = \begin{cases} \text{diag}(100, 99, 98, 97, 96, 95, \dots, 1) & \text{if } 0 \leq i \leq 40; \\ \text{diag}(97, 96, 95, 100, 99, 98, 94, \dots, 1) & \text{if } i > 40. \end{cases} \quad (11)$$

Figure 7 shows the value of $|\rho(p_i) - \rho(\hat{p})|$ and Figure 8 shows the estimated eigenvalues. As predicted, the iterates initially stay near the old minimum point, which has become a saddle point. After about fifteen iterations, numerical inaccuracies drive the iterates away from the saddle point to the new minimum point.

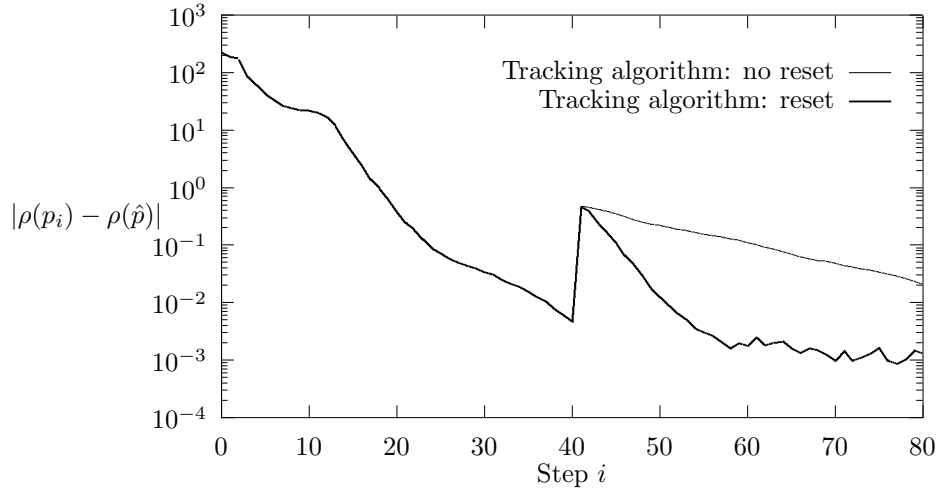

FIGURE 3. Convergence of Algorithm 3.1 on $V_{100,3}$ applied to the matrix A_i (from Eq. (9)), which has a step at $i = 40$. The thin line represents values generated with no reset at $i = 40$, and the thicker line represents values generated when the conjugate gradient algorithm is reset at $i = 40$.

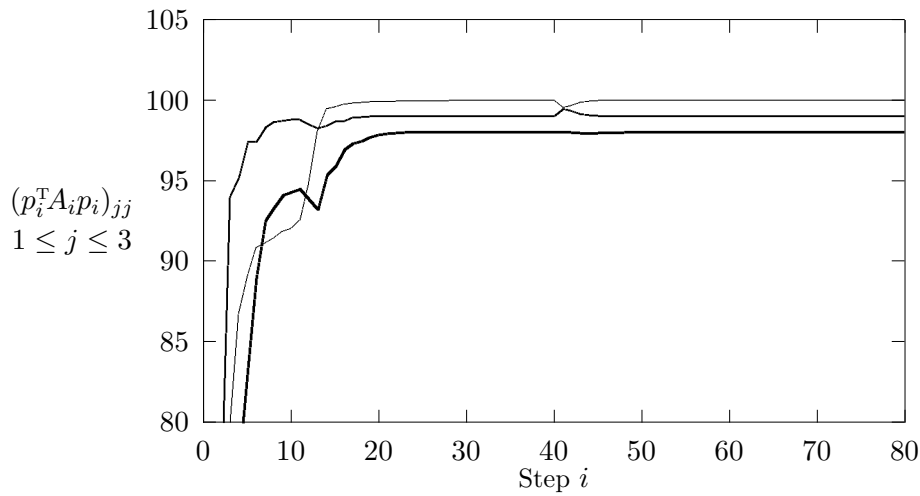

FIGURE 4. The diagonal elements of $p_i^T A_i p_i$ generated by Algorithm 3.1 on $V_{100,3}$, where A_i is define by Eq. (9). The conjugate gradient algorithm was reset at $i = 40$.

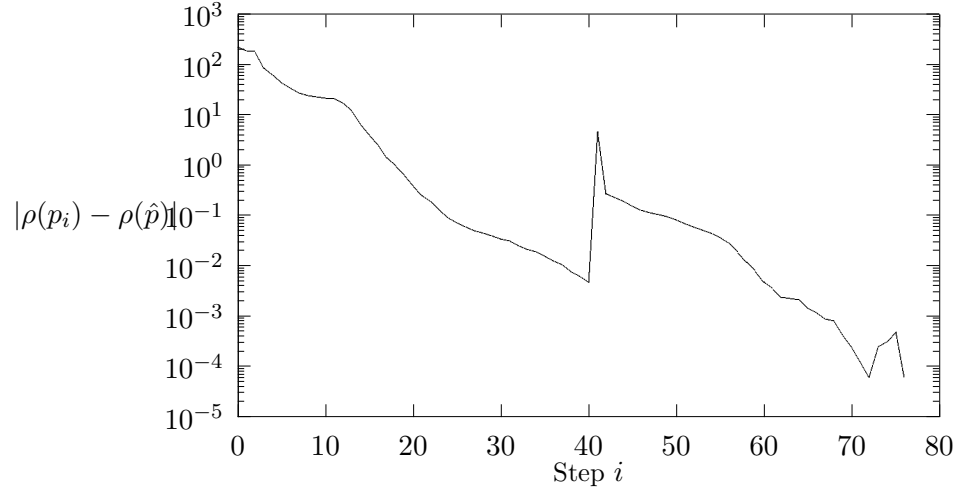

FIGURE 5. Convergence of Algorithm 3.1 on $V_{100,3}$ applied to the matrix A_i (from Eq. (10)), which has a step at $i = 40$.

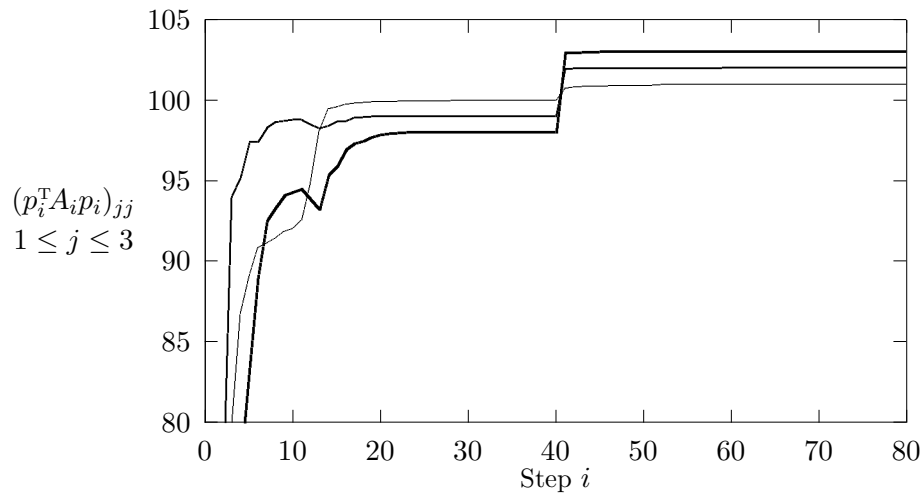

FIGURE 6. The diagonal elements of $p_i^T A_i p_i$ generated by Algorithm 3.1 on $V_{100,3}$, where where A_i is define by Eq. (10).

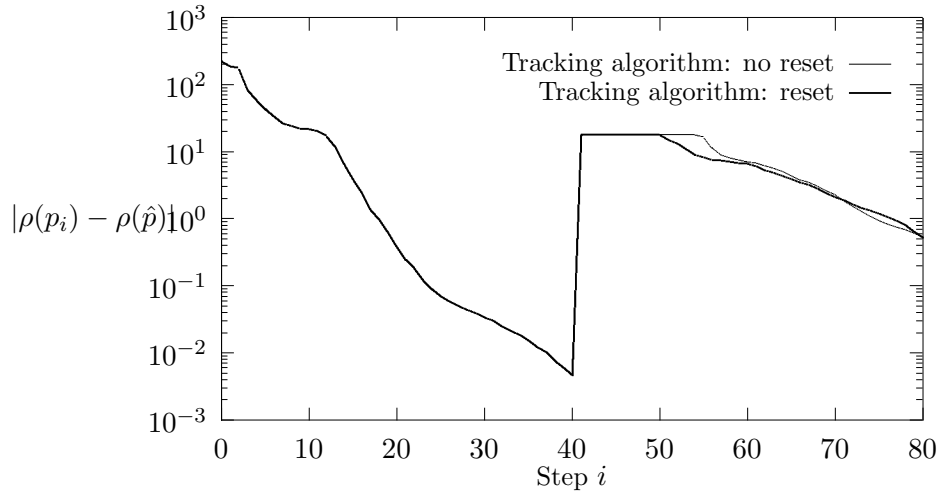

FIGURE 7. Convergence of Algorithm 3.1 on $V_{100,3}$ applied to the matrix A_i (from Eq. (11)), which has a step at $i = 40$. The results show how the algorithm behaves when a maximum point becomes a saddle point.

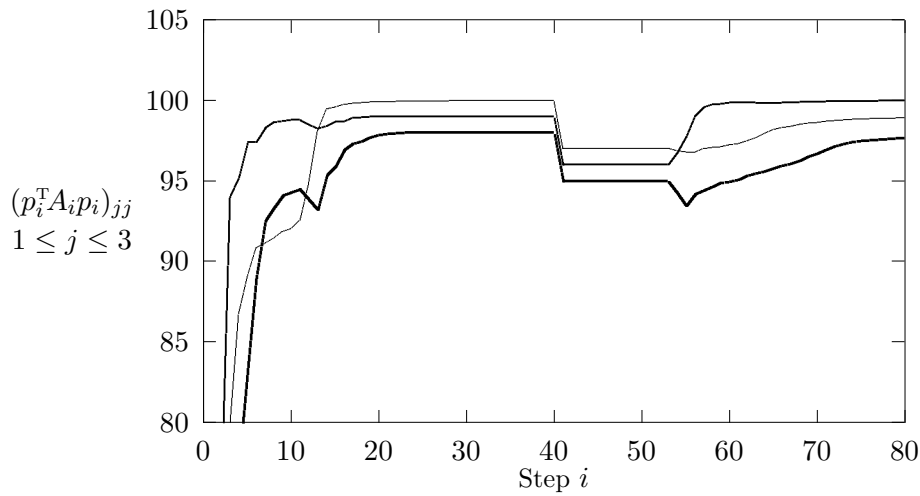

FIGURE 8. The diagonal elements of $p_i^T A_i p_i$ generated by Algorithm 3.1 on $V_{100,3}$, where A_i is defined by Eq. (11). The results show how the eigenvalues of A_i are tracked when a maximum point becomes a saddle point.

CHAPTER 6

CONCLUSIONS

In this thesis a geometric framework for optimization problems and their application in adaptive signal processing is established. Many approaches to the subspace tracking problem encountered in adaptive filtering depend upon its formulation as an optimization problem, namely optimizing a generalized form of the Rayleigh quotient defined on a set of orthonormal vectors. However, previous algorithms do not exploit the natural geometric structure of this constraint manifold. These algorithms are extrinsically defined in that they depend upon the choice of an isometric imbedding of the constraint surface in a higher dimensional Euclidean space. Furthermore, the algorithms that use a projected version of the classical conjugate gradient algorithm on Euclidean space do not account for the curvature of the constraint surface, and therefore achieve only linear convergence.

There exists a special geometric structure in the type of constraint surfaces found in the subspace tracking problem. The geometry of Lie groups and homogeneous spaces, reviewed in Chapter 2, provides analytic expressions for many fundamental objects of interest in these spaces, such as geodesics and parallel translation along geodesics. While such objects may be computationally unfeasible for application to general constrained optimization problems, there is an important class of manifolds which have sufficient structure to yield potentially practical algorithms.

The subspace tracking problem can be expressed as a gradient flow on a Lie group or homogeneous space. This idea, discussed in Chapter 3, covers several examples of gradient flows on Lie groups and homogeneous spaces. All of these gradient flows solve the eigenvalue or singular value problem of numerical linear algebra. The gradient flows considered demonstrate how understanding the differential geometric structure of a problem in numerical linear algebra can illuminate algorithms used to solve that problem. Specifically, the gradient flow of the function $\text{tr } \Theta^T Q \Theta N$ defined on the special orthogonal group $\mathbf{SO}(n)$

is reviewed. This flow yields an ordered eigenvalue decomposition of the matrix Q . The gradient flow of the generalized Rayleigh quotient $\text{tr } p^T A p N$ defined on the Stiefel manifold $V_{n,k}$ is analyzed and its stationary points classified. Finally the gradient flow of the function $\text{tr } \Sigma^T N$ defined on the set of matrices with fixed singular values is analyzed. This gradient flow and a related gradient flow on the homogeneous space $(\mathbf{O}(n) \times \mathbf{O}(k))/\Delta_D \mathbf{O}(n-k)$ yield the singular value decomposition of an arbitrary matrix. A numerical experiment demonstrating this gradient flow is provided and it is shown that the experimental convergence rates are close to the predicted convergence rates.

Because using gradient flows to solve problems in numerical linear algebra is computationally impractical, the theory of large step optimization methods on Riemannian manifolds is developed in Chapter 4. The first method analyzed—the method of steepest descent on a Riemannian manifold—is already well-known. A thorough treatment of this algorithm employing techniques from Riemannian geometry is provided to fix ideas for the development of improved methods. A proof of linear convergence is given. Next, a version of Newton’s method on Riemannian manifolds is developed and analyzed. It is shown that quadratic convergence may be obtained, and that this method inherits several properties from the classical version of Newton’s method on a flat space. Finally, the conjugate gradient method on Riemannian manifolds is developed and analyzed, and a proof of superlinear convergence is provided. Several examples that demonstrate the predicted convergence rates are given throughout this chapter. The Rayleigh quotient on the sphere is optimized using all three algorithms. It is shown that the Riemannian version of Newton’s method applied to this function is efficiently approximated by the Rayleigh quotient iteration. The conjugate gradient algorithm applied to the Rayleigh quotient on the sphere yields a new algorithm for computing the eigenvectors corresponding to the extreme eigenvalues of a symmetric matrix. This superlinearly convergent algorithm requires two matrix-vector multiplications and $O(n)$ operations per iteration.

In Chapter 5 these ideas are brought to bear on the subspace tracking problem of adaptive filtering. The subspace tracking problem is reviewed and it is shown how this problem may be viewed as an optimization problem on a Stiefel manifold. The Riemannian version of the conjugate gradient method is applied to the generalized Rayleigh quotient. By exploiting the homogeneous space structure of the Stiefel manifold, an efficient superlinearly convergent algorithm for computing the eigenvectors corresponding to the k extreme eigenvalues of a symmetric matrix is developed. This algorithm requires $O(k)$ matrix-vector multiplications per iteration and $O(nk^2)$ operations. This algorithm has the advantage

of maintaining orthonormality of the estimated eigenvectors at every step. However, it is important to note that the algorithm is only efficient if $2k \leq n$. The results of a numerical experiment of this algorithm which confirm the predicted convergence properties are shown. In the experiment, the conjugate gradient algorithm on $V_{100,3}$, a manifold of dimension 294, converged to machine accuracy within 50 steps. Good estimates of the eigenvalues are obtained in less than 25 steps. A similar algorithm for computing the largest left singular vectors corresponding to the extreme singular values of an arbitrary matrix is discussed.

A new algorithm for subspace tracking based upon this conjugate gradient algorithm is given. To test the algorithm's tracking properties, the algorithm is used to track several time varying symmetric matrices, each of which has a discontinuous step of some type. The following examples are considered: the principal invariant subspace rotating in its own plane with fixed eigenvalues, rotating out of its plane with changing eigenvalues, and rotating instantaneously to an orthogonal plane. Two versions of the algorithm were tested: one version that reset the conjugate gradient algorithm at the step, and one version that did not. In the first test, the reset version reconverged to machine accuracy in less than 20 steps, and provided accurate estimates of the eigenvalues in less than 10 steps. In the second test, the algorithm reconverged in 30 steps, and provided accurate estimates of the eigenvalues in 5 iterations. The third and final experiment demonstrates how the algorithm behaves when it has converged to a maximum point that suddenly becomes a saddle point. The algorithm stayed close to the saddle point for about 15 iterations.

This thesis has only considered a few Riemannian manifolds which are found in certain types of applications and have sufficient structure to yield efficient algorithms. There are other useful examples which have not yet been mentioned. For example, many applications do not require the eigenvectors and corresponding eigenvalues of principal invariant subspace, but only an arbitrary orthonormal basis for this subspace. In this context, an optimization problem posed on the Grassmann manifold $G_{n,k}$ of k -planes in \mathbf{R}^n would be appropriate. This manifold possesses the structure of a symmetric space and therefore geodesics and parallel translation along geodesics may be computed with matrix exponentiation. Furthermore, the tangent plane of $G_{n,k}$ at the origin as a vector subspace of the Lie algebra of its Lie transformation group contains large zero blocks that could be exploited to yield an efficient algorithm. This thesis also considered only real-valued cases; the unitary version of these algorithms that would be necessary for many signal processing contexts have not been explored.

The subspace tracking methods presented in this thesis have not been applied to par-

ticular examples in adaptive filtering, so there is an opportunity to explore the extent of their usefulness in this area. There is a broad range of adaptive filtering applications which have diverse computational requirements, dimensionality, and assumptions about the signal properties and background noise. The strengths and weaknesses of subspace tracking techniques must be evaluated in the context of the application's requirements.

REFERENCES

- AKAIKE, H. (1974). Stochastic theory of minimal realization. *IEEE Trans. Autom. Control* **AC-19**(6): 667–674.
- ÅSTRÖM, K. J. (1983). Theory and applications of adaptive control—a survey. *Automatica* **19**(5): 471–486.
- ABRAHAM, R. and MARSDEN, J. E. (1985). *Foundations of Mechanics*. 2d ed. Reading, MA: Benjamin/Cummings Publ. Co.
- BALDI, P. and HORNIK, K. (1989). Neural networks and principal component analysis: learning from examples without local minima. *Neural Networks* **2**: 53–58.
- BARAM, Y. (1981). Realization and reduction of markovian models from nonstationary data. *IEEE Trans. Autom. Control* **AC-26**(6): 1225–1231.
- BERTSEKAS, D. P. (1982a). *Constrained Optimization and Lagrange Multiplier Methods*. New York: Academic Press.
- . (1982b). Projected Newton methods for optimization problems with simple constraints. *SIAM J. Cont. Opt.* **20**: 221–246.
- BIENVENU, G. and KOPP, L. (1983). Optimality of high resolution array processing using the eigensystem approach. *IEEE Trans. Acoust., Speech, Signal Processing* **ASSP-31**(5): 1235–1248.
- BLOCH, A. M. (1990). Steepest descent, linear programming, and Hamiltonian flows. In *Contemp. Math. AMS* **114**: 77–88.
- BLOCH, A. M., BROCKETT, R. W., and RATIU, T. S. (1990). A new formulation of the generalized Toda lattice equations and their fixed point analysis via the momentum map. *Bull. Amer. Math. Soc.* **23**(2): 477–485.
- . (1992). Completely integrable gradient flows. *Commun. Math. Phys.* **147**: 57–74.
- BOTSARIS, C. A. (1978). Differential gradient methods. *J. Math. Anal. Appl.* **63**: 177–198.
- . (1981a). A class of differential descent methods for constrained optimization. *J. Math. Anal. Appl.* **79**: 96–112.
- . (1981b). Constrained optimization along geodesics. *J. Math. Anal. Appl.* **79**: 295–306.
- BOURLAND, H. and KAMP, Y. (1988). Auto-association by multilayer perceptrons and singular value decomposition. *Biol. Cybern.* **59**: 291–294.
- BRADBURY, W. W. and FLETCHER, R. (1966). New iterative methods for solution of the eigenproblem. *Numer. Math.* **9**: 259–267.
- BROCKETT, R. W. (1989). Least squares matching problems. *Lin. Alg. Appl.* **122/123/124**: 761–777.
- . (1991a). Dynamical systems that sort lists, diagonalize matrices, and solve linear programming problems. *Lin. Alg. Appl.* **146**: 79–91. See also *Proc. IEEE Conf. Decision and Control*, 799–803, (1988).
- . (1991b). Dynamical systems that learn subspaces. In *Mathematical Systems Theory: The Influence of R. E. Kalman*. Berlin: Springer-Verlag.
- . (1993). Differential geometry and the design of gradient algorithms. In *Proc. Symp. Pure Math.*, ed. R. Green and S. T. Yau, Vol. 54, pt. 1, 69–92. Providence, RI: American Mathematical Society.

102 REFERENCES

- BROWN, A. A. and BARTHOLOMEW-BIGGS, M. C. (1989). Some effective methods for unconstrained optimization based on the solution of systems of ordinary differential equations. *J. Optim. Theory Appl.* **62** (2): 211–224.
- BUNCH, J. R., NIELSON, C. P., and SORENSON, D. C. (1978). Rank-one modification of the symmetric eigenvalue problem. *Numer. Math.* **31**: 111–129.
- CHEEGER, J. and EBIN, D. G. (1975). *Comparison Theorems in Riemannian Geometry*. Amsterdam: North-Holland Publishing Company.
- CHEN, H., SARKAR, T. K., DIANAT, S. A., and BRULÉ, J. D. (1986). Adaptive spectral estimation by the conjugate gradient method. *IEEE Trans. Acoust., Speech, Signal Processing* **ASSP-34** (2): 272–284.
- CHU, M. T. (1986). Curves on S^{n-1} that lead to eigenvalues or their means of a matrix. *SIAM J. Alg. Disc. Meth.* **7** (3): 425–432.
- CHU, M. T. and DRIESSEL, K. R. (1990). The projected gradient method for least squares matrix approximations with spectral constraints. *SIAM J. Numer. Anal.* **27** (4): 1050–1060.
- COMON, P. and GOLUB, G. H. (1990). Tracking a few extreme singular values and vectors in signal processing. *Proc. IEEE* **78** (8): 1327–1343.
- CRAIG, J. J., HSU, P., and SASTRY, S. S. (1987). Adaptive control of mechanical manipulators. *Int. J. Robotics Research* **6** (2): 16–28.
- CULLUM, J. (1978). The simultaneous computation of a few of the algebraically largest and smallest eigenvalues of a large, sparse, symmetric matrix. *BIT* **18**: 265–275.
- CULLUM, J. and WILLOUGHBY, R. (1985). *Lanczos Algorithms for Large Symmetric Eigenvalue Computations*. Vol. 1. Boston: Birkhäuser.
- DAVIDON, W. C. (1959). Variable metric methods for minimization. AEC Research and Development Report ANL-5990 (revised). Argonne, IL: Argonne National Lab.
- DEIFT, P., DEMMEL, J., LI, L.-C., and TOMEI, C. (1991a). Dynamical aspects of the bidiagonal singular value decomposition. In *The Geometry of Hamiltonian Systems*, ed. T. Ratiu. New York: Springer-Verlag.
- . (1991b). The bidiagonal singular value decomposition and Hamiltonian mechanics. *SIAM J. Numer. Anal.* **28** (5): 1463–1516.
- DEIFT, P. and LI, L.-C. (1991). Poisson geometry of the analog of the Miura maps and Bäcklund-Darboux transformations for equations of Toda type and periodic Toda flows. *Commun. Math. Phys.* **143**: 201–214.
- DEMEURE, C. J. and SCHARF, L. L. (1990). Sliding windows and lattice algorithms for computing QR factors in the least squares theory of linear prediction. *IEEE Trans. Acoust., Speech, Signal Processing* **38** (4): 721–725.
- DUNN, J. C. (1980). Newton’s method and the Goldstein step length rule for constrained minimization problems. *SIAM J. Cont. Opt.* **18**: 659–674.
- . (1981). Global and asymptotic convergence rate estimates for a class of projected gradient processes. *SIAM J. Cont. Opt.* **19**: 368–400.
- FAYBUSOVICH, L. (1991). Hamiltonian structure of dynamical systems which solve linear programming problems. *Phys. D* **53**: 217–232.
- FLETCHER, R. (1987). *Practical Methods of Optimization*. 2d ed. New York: John Wiley & Sons.
- FLETCHER, R. and REEVES, C. M. (1964). Function minimization by conjugate gradients. *Comput. J.* **7** (2): 149–154.
- FRIED, I. (1969). Gradient methods for finite element eigenproblems. *AIAA Journal* **7**: 739–741.
- FUHRMANN, D. R. (1988). An algorithm for subspace computation, with applications in signal processing. *SIAM J. Matrix Anal. Appl.* **9** (2): 213–220.
- FUHRMANN, D. R. and LIU, B. (1984). An iterative algorithm for locating the minimal eigenvector of a symmetric matrix. In *Proc. IEEE Int. Conf. Acoust., Speech, Signal Processing*, 45.8.1–4.

- GILL, P. E. and MURRAY, W. (1974). Newton-type methods for linearly constrained optimization. In *Numerical Methods for Constrained Optimization*, ed. P. E. Gill and W. Murray. London: Academic Press.
- GOLUB, G. H. and O'LEARY, D. P. (1989). Some history of the conjugate gradient and Lanczos Algorithms: 1948–1976. *SIAM Review* **31** (1): 50–102.
- GOLUB, G. H. and VAN LOAN, C. (1983). *Matrix Computations*. Baltimore, MD: Johns Hopkins University Press.
- GOLUBITSKY, M. and GUILLEMIN, V. (1973). *Stable Mappings and Their Singularities*. New York: Springer-Verlag.
- HELGASON, S. (1978). *Differential Geometry, Lie Groups, and Symmetric Spaces*. New York: Academic Press.
- HELMKE, U. (1991). Isospectral flows on symmetric matrices and the Riccati equation. *Systems & Control Lett.* **16**: 159–165.
- HELMKE, U. and MOORE, J. B. (1992). Singular-value decomposition via gradient and self-equivalent flow. *Lin. Alg. Appl.* **169**: 223–248.
- HESTENES, M. R. and STIEFEL, E. (1952). Methods of conjugate gradients for solving linear systems. *J. Res. Nat. Bur. Stand.* **49**: 409–436.
- HIRSCH, M. W. and SMALE, S. (1979). On algorithms for solving $f(x) = 0$. *Comm. Pure Appl. Math.* **32**: 281–312.
- HU, Y. H. (1985). Adaptive methods for real time pisarenko spectrum estimate. In *Proc. IEEE Int. Conf. Acoust., Speech, Signal Processing*, 105–108.
- HUGHES, T. J. R. (1987). *The Finite Element Method: Linear Static and Dynamic Finite Element Analysis*. Englewood Cliffs, NJ: Prentice-Hall.
- HUNG, H. and KAVEH, M. (1988). Focusing matrices for coherent signal-subspace processing. *IEEE Trans. Acoust., Speech, Signal Processing* **36** (8): 1272–1281.
- KARASALO, I. (1986). Estimating the covariance matrix by signal subspace averaging. *IEEE Trans. Acoust., Speech, Signal Processing ASSP-34* (1): 8–12.
- KARCHER, H. (1977). Riemannian center of mass and mollifier smoothing. *Comm. Pure Appl. Math.* **30**: 509–541.
- KARHUNEN, J. (1984). Adaptive algorithm for estimating eigenvectors of correlation type matrices. In *Proc. IEEE Int. Conf. Acoust., Speech, Signal Processing*, 14.6.1–4.
- KOBAYASHI, S. and NOMIZU, K. (1969). *Foundations of Differential Geometry*. Vol. 2. New York: Interscience Publishers.
- KORENBURG, M. J. and HUNTER, I. W. (1986). The identification of nonlinear biological systems: LNL cascade models. *Biol. Cybern.* **55**: 125–134.
- LAGARIAS, J. C. (1991). Monotonicity properties of the Toda flow, the QR-flow, and subspace iteration. *SIAM J. Numer. Anal. Appl.* **12** (3): 449–462.
- LARIMORE, M. G. (1983). Adaptation convergence of spectral estimation based on Pisarenko harmonic retrieval. *IEEE Trans. Acoust., Speech, Signal Processing ASSP-31* (4): 955–962.
- LI, L.-C. and PARMENTIER, S. (1989). Nonlinear Poisson structures and r -matrices. *Commun. Math. Phys.* **125**: 545–563.
- LION, P. M. (1966). Rapid identification of linear and nonlinear systems. In *Joint Automatic Control Conference*, 605–615. Seattle, WA.
- LUENBERGER, D. G. (1973). *Introduction to Linear and Nonlinear Programming*. Reading, MA: Addison-Wesley.
- MOLER, C. and VAN LOAN, C. (1978). Nineteen dubious ways to compute the exponential of a matrix. *SIAM Review* **20** (4): 801–836.

104 REFERENCES

- MOONEN, M., DE MOOR, B., VANDENBERGHE, L., and VANDEWALLE, J. (1989). On- and off-line identification of linear state-space models. *Int. J. Control* **49** (1): 219–232.
- MOONEN, M., VAN DOOREN, P., and VANDEWALLE, J. (1992). A singular value decomposition updating algorithm for subspace tracking. *SIAM J. Matrix Anal. Appl.* **13** (4): 1015–1038.
- . (1993). A systolic array for SVD updating. *SIAM J. Matrix Anal. Appl.* **14** (2): 353–371.
- MOORE, B. C. (1981). Principal component analysis in linear systems: Controllability, observability, and model reduction. *IEEE Trans. Automatic Control* **AC-26** (1): 17–32.
- NOMIZU, K. (1954). Invariant affine connections on homogeneous spaces. *Amer. J. Math.* **76**: 33–65.
- OJA, E. (1982). A simplified neuron model as a principal component analyzer. *J. Math. Biology* **15**: 267–273.
- . (1983). *Subspace methods of pattern recognition*. Hertfordshire, England: Research Studies Press, New York: Wiley.
- . (1989). Neural networks, principal components, and subspaces. *Int. J. Neural Systems* **1** (1): 61–68.
- O’LEARY, D. P., STEWART, G. W., and VANDERGRAFT, J. S. (1979). Estimating the largest eigenvalues of a positive definite matrix. *Math. Comp.* **33** (148): 1289–1292.
- OVERTON, M. L. (1992). Large-scale optimization of eigenvalues. *SIAM J. Optimization* **2** (1): 88–120.
- OWSLEY, N. L. (1978). Adaptive data orthogonalization. In *Proc. IEEE Int. Conf. Acoust., Speech, Signal Processing*, 109–112.
- PARLETT, B. (1980). *The Symmetric Eigenvalue Problem*. Englewood Cliffs, NJ: Prentice-Hall.
- PARLETT, B. N., SCOTT, D. N. (1979). The Lanczos algorithm with selective orthogonalization. *Math. Comp.* **33**: 217–238.
- PARLETT, B. N., SIMON, H., and STRINGER, L. M. (1982). On estimating the largest eigenvalue with the Lanczos algorithm. *Math. Comp.* **38** (157): 153–165.
- PERKINS, J. E., HELMKE, U., and MOORE, J. B. (1990). Balanced realizations via gradient flow techniques. *Systems & Control Lett.* **14**: 369–380.
- POLAK, E. (1971). *Computational Methods in Optimization*. New York: Academic Press.
- RADER, C. M. (1991). Wafer-scale integration of a large systolic array for adaptive nulling. *Lincoln Lab. Journal* **4** (1): 3–30.
- ROY, R. and KAILATH, T. (1989). ESPRIT—Estimation of signal parameters via rotational invariance techniques. *IEEE Trans. Acoust., Speech, Signal Processing* **37** (7): 984–995.
- RUBNER, J. and SCHULTEN, K. (1990). Development of feature detectors by self-organization. *Biol. Cybern.* **62**: 193–199.
- RUBNER, J. and TAVAN, P. (1989). A self-organizing network for principal component analysis. *Europhys. Lett.* **10** (7): 693–698.
- RUDIN, W. (1976). *Principles of Mathematical Analysis*. 3d ed. New York: McGraw-Hill.
- SARGENT, R. W. H. (1974). Reduced gradient and projection methods for nonlinear programming. In *Numerical Methods for Constrained Optimization*, ed. P. E. Gill and W. Murray. London: Academic Press.
- SCHMIDT, R. O. (1979). Multiple emitter location and signal parameter estimation. In *Proc. RADC Spectrum Estimation Workshop*. Griffiss Air Force Base, NY. Reprinted in *IEEE Trans. Antennas, Propagation* **AP-34** (3): 276–280, (1986).
- SCHMIDT, R. O. and FRANKS, R. E. (1986). Multiple source DF signal processing: An experimental system. *IEEE Trans. Antennas, Propagation* **AP-34** (3): 281–290.
- SCHREIBER, R. (1986). Implementation of adaptive array algorithms. *IEEE Trans. Acoust., Speech, Signal Processing* **ASSP-34** (5): 1038–1045.
- SHUB, M. (1986). Some remarks on dynamical systems and numerical analysis. In *Dynamical Systems and Partial Differential Equations: Proc. VII ELAM*, ed. L. Lara-Carrero and J. Lewowicz, 69–92. Caracas: Equinoccio, U. Simón Bolívar.

- SHUB, M. and SMALE, S. (1985). Computational complexity: On the geometry of polynomials and a theory of cost, Part I. *Ann. scient. Éc. Norm. Sup.* **4**(18): 107–142.
- . (1986a). Computational complexity: On the geometry of polynomials and a theory of cost, Part II. *SIAM J. Comput.* **15**(1): 145–161.
- . (1986b). On the existence of generally convergent algorithms. *J. Complexity* **2**: 2–11.
- SLOTINE, J. J. E. and LI, W. (1987). On the adaptive control of robot manipulators. *Int. J. Robotics Research* **6**(3): 49–59.
- SMALE, S. (1981). The fundamental theorem of algebra and computational complexity. *Bull. Amer. Math. Soc.* **4**(1): 1–36.
- . (1985). On the efficiency of algorithms in analysis. *Bull. Amer. Math. Soc.* **13**(2): 87–121.
- SMITH, S. T. (1991). Dynamical systems that perform the singular value decomposition. *Systems & Control Lett.* **16**: 319–327.
- . (in press). Optimization techniques on Riemannian manifolds. In *Proc. Fields Inst. Workshop Hamiltonian and Gradient Flows, Algorithms, and Control*, ed. A. Bloch. Providence, RI: American Mathematical Society.
- SPIVAK, M. (1979). *A Comprehensive Introduction to Differential Geometry*. 2d ed. Vols. 1, 2, 5. Houston, TX: Publish or Perish, Inc.
- TOSUNOGLU, S. and TESAR, D. (1988). State of the art in adaptive control in robotic systems. *IEEE Trans. Aerospace and Electronic Systems* **24**(5): 552–561.
- VAN HUFFEL, S., VANDEWALLE, J., and HAEGEMANS, A. (1987). An efficient and reliable algorithm for computing the singular subspace of a matrix, associated with its smallest singular values. *J. Comp. Appl. Math.* **19**: 313–330.
- VON NEUMANN, J. (1937). Some matrix inequalities and metrization of matrix-space. *Tomsk Univ. Rev.* **1**: 286–300. See also Taub, A. H., ed. (1962). *John von Neumann, Collected Works*. Vol. 4. New York: Permagon Press.
- WARD, R. C. and GRAY, L. J. (1978a). Eigensystem computation for skew-symmetric matrices and a class of symmetric matrices. *ACM Trans. Math. Softw.* **4**(3): 278–285.
- . (1978b). Algorithm 530: An algorithm for computing the eigensystem of skew-symmetric matrices and a class of symmetric matrices. *ACM Trans. Math. Softw.* **4**(3): 286–289. See also *Collected Algorithms from ACM*. Vol. 3. New York: Assoc. Comput. Mach., (1978).
- WARNER, F. W. (1983). *Foundations of Differentiable Manifolds and Lie Groups*. New York: Springer-Verlag.
- WATKINS, D. S. and ELSNER, L. (1988). Self-similar flows. *Linear Algebra and Appl.* **110**: 213–242.
- . (1989). Self-equivalent flows associated with the singular value decomposition. *SIAM J. Matrix Anal. Appl.* **10**: 244–258.
- WIDROW, B. and STEARNS, S. (1985). *Adaptive Signal Processing*. Englewood Cliffs, NJ: Prentice-Hall.
- WILKINSON, J. H. (1965). *The Algebraic Eigenvalue Problem*. Oxford: Clarendon Press.
- WOLF, J. A. (1984). *Spaces of Constant Curvature*. Houston, TX: Publish or Perish, Inc.
- XU, G. and KAILATH, T. (in press). Fast estimation of principal eigenspace using Lanczos algorithm. *SIAM J. Mat. Anal. Appl.*
- . (in press). Fast subspace decomposition. *IEEE Trans. Acoust., Speech, Signal Processing*.
- YANG, J.-F. and KAVEH, M. (1988). Adaptive eigenspace algorithms for direction or frequency estimation and tracking. *IEEE Trans. Acoust., Speech, Signal Processing* **36**(2): 241–251.
- YU, K.-B. (1991). Recursive updating the eigenvalue decomposition of a covariance matrix. *IEEE Trans. Signal Processing* **39**(5): 1136–1145.