

HOPF ALGEBRA STRUCTURE ON PACKED SQUARE MATRICES

HAYAT CHEBALLAH, SAMUELE GIRAUDO, AND RÉMI MAURICE

ABSTRACT. We construct a new bigraded Hopf algebra whose bases are indexed by square matrices with entries in the alphabet $\{0, 1, \dots, k\}$, $k \geq 1$, without null rows or columns. This Hopf algebra generalizes the one of permutations of Malvenuto and Reutenauer, the one of k -colored permutations of Novelli and Thibon, and the one of uniform block permutations of Aguiar and Orellana. We study the algebraic structure of our Hopf algebra and show, by exhibiting multiplicative bases, that it is free. We moreover show that it is self-dual and admits a bidendriform bialgebra structure. Besides, as a Hopf subalgebra, we obtain a new one indexed by alternating sign matrices. We study some of its properties and algebraic quotients defined through alternating sign matrices statistics.

CONTENTS

Introduction	1
1. Packed matrices	3
1.1. Definitions	3
1.2. Enumeration	5
1.3. Hopf algebra structure	6
2. Algebraic properties	8
2.1. Multiplicative bases and freeness	8
2.2. Self-duality	11
2.3. Bidendriform bialgebra structure	13
3. Related Hopf algebras	16
3.1. Links with known algebras	16
3.2. Equivalence relations and Hopf subalgebras	20
4. Alternating sign matrices	24
4.1. Hopf algebra structure	25
4.2. Alternating sign matrices statistics	27
4.3. Algebraic interpretation of some statistics	29
References	34

INTRODUCTION

The combinatorial class of permutations is naturally endowed with two operations. One of them, called *shifted shuffle product*, takes two permutations as input and put these together by blending their letters. The other one, called *deconcatenation coproduct*, takes one permutation as input and

Date: November 9, 2017.

Key words and phrases. Hopf algebra; Permutation; Uniform block permutation; Alternating sign matrix; six-vertex model.

Phone number and email address of the corresponding author: +33160957558, samuele.giraud@univ-mlv.fr.

takes it apart by cutting it into prefixes and suffixes. These two operations satisfy certain compatibility relations, resulting in that the vector space spanned by the set of permutations forms a Hopf algebra [MR95], namely the *Malvenuto-Reutenauer Hopf algebra*, also known as **FQSym** [DHT02].

This Hopf algebra plays a central role in algebraic combinatorics for at least two reasons. On the one hand, **FQSym** contains, as Hopf subalgebras, several structures based on well-known combinatorial objects as *e.g.*, standard Young tableaux [DHT02], binary trees [HNT05], and integer compositions [GKL⁺95]. The construction of these substructures revisits many algorithms coming from computer science and combinatorics. Indeed, the insertion of a letter into a Young tableau (following Robinson-Schensted [Sch61]) or in a binary search tree [Knu98] are algorithms which prove to be as enlightening as surprising in this algebraic context [DHT02, HNT02, HNT05]. On the other hand, the polynomial realization of **FQSym** allows to associate a polynomial with any permutation [DHT02] providing a generalization of symmetric functions, the *free quasi-symmetric functions*. This generalization offers alternative ways to prove several properties of (quasi)symmetric functions.

It is thus natural to enrich this theory by proposing generalizations of **FQSym**. In the last years, several generalizations were proposed and each of these depends on the way we regard permutations. By regarding a permutation as a word and allowing repetitions of letters, Hivert introduced in [Hiv99] (see [NT06] for a detailed study) a Hopf algebra **WQSym** on packed words. Additionally, by allowing some jumps for the values of the letters of permutations, Novelli and Thibon defined in [NT07] another Hopf algebra **PQSym** which involves parking functions. These authors also showed in [NT10] that the k -colored permutations admit a Hopf algebra structure $\mathbf{FQSym}^{(k)}$. Furthermore, by regarding a permutation σ as a bijection associating the singleton $\{\sigma(i)\}$ with any singleton $\{i\}$, Aguiar and Orellana constructed [AO08] a Hopf algebra structure **UBP** on uniform block permutations, *i.e.*, bijections between set partitions of $[n]$, where each part has the same cardinality as its image. Finally, by regarding a permutation within its permutation matrix, Duchamp, Hivert and Thibon introduced in [DHT02] a Hopf algebra **MQSym** which involves some kind of integer matrices.

In this paper we propose a new generalization of **FQSym** by regarding permutations as permutation matrices. For this purpose, we consider the set of *1-packed matrices* that are square matrices with entries in the alphabet $\{0, 1\}$ which have at least one 1 by row and by column. By equipping these matrices with a product and a coproduct, we obtain a bigraded Hopf algebra, denoted by \mathbf{PM}_1 . By only considering the gradation offered by the size (resp. the number of nonzero entries) of matrices, we obtain a simply graded Hopf algebra denoted by \mathbf{PMN}_1 (resp. \mathbf{PML}_1). Note that since permutation matrices form a Hopf subalgebra of \mathbf{PMN}_1 (and \mathbf{PML}_1) isomorphic to **FQSym**, \mathbf{PMN}_1 (and \mathbf{PML}_1) provides a generalization of **FQSym**. Now, by allowing the entries different from 0 of a packed matrix to belong to the alphabet $\{1, \dots, k\}$ where k is a positive integer, we obtain the notion of a *k-packed matrix*. The definition of \mathbf{PM}_1 (and \mathbf{PMN}_1 and \mathbf{PML}_1) obviously extends to these matrices and leads to the Hopf algebra \mathbf{PM}_k (and \mathbf{PMN}_k and \mathbf{PML}_k) involving k -packed matrices. Besides, since any k -packed matrix is also a $k + 1$ -packed matrix, $(\mathbf{PM}_k)_{k \geq 1}$ is an increasing infinite sequence of Hopf algebras for inclusion.

Our results are presented as follows. We give in Section 1 some elementary definitions about k -packed matrices, enumerate them according to their size, and then define the Hopf algebra of k -packed matrices by describing its product and its coproduct. Section 2 is devoted to the study of the algebraic properties of \mathbf{PM}_k . In order to show that \mathbf{PM}_k is free as an algebra, we define, by introducing a partial order relation on the k -packed matrices, two multiplicative bases: the bases of the *elementary* and *homogeneous* elements. We then describe the dual Hopf algebra \mathbf{PM}_k^* of \mathbf{PM}_k in explaining the product and the coproduct and show that \mathbf{PM}_k is self-dual. In Section 3, we show how several well-known Hopf algebras are linked with \mathbf{PM}_k . In particular, we show that the Hopf

algebra of the k -colored permutations $\mathbf{FQSym}^{(k)}$ embeds into \mathbf{PMN}_k (and \mathbf{PML}_k) and that the dual \mathbf{UBP}^* of the Hopf algebra of uniform block permutations embeds into \mathbf{PMN}_1 . We also exhibit an injective algebra morphism from \mathbf{PML}_1^* to \mathbf{MQSym} . We conclude this section by providing a method to construct Hopf subalgebras of \mathbf{PM}_k , analogous to the construction of Hopf subalgebras of \mathbf{FQSym} by *good congruences* [HN07, Gir11]. The analogs of the sylvester [HNT02, HNT05], plactic [LS81, Lot02], hypoplactic [KT97, KT99], Bell [Rey07], and Baxter [Gir12] congruences are still good congruences in our context and give rise to Hopf subalgebras of \mathbf{PM}_k . We end this article by Section 4 where we show that \mathbf{PMN}_1 contains a Hopf subalgebra whose bases are indexed by alternating sign matrices, denoted by \mathbf{ASM} . We consider then some well-known statistics on the six-vertex model with domain wall boundary conditions [Kor82], that are combinatorial objects in bijection with alternating sign matrices [Kup96, Bre99]. We study these statistics from the algebraic point of view offered by the Hopf algebra \mathbf{ASM} . This section is concluded with a complete study of quotients of \mathbf{ASM} by equivalence relations defined through these statistics.

Acknowledgements. This work is based on computer exploration and the authors used, for this purpose, the open-source mathematical software Sage [S+12] and one of its extensions, Sage-Combinat [SCc08]. The authors would like to thank the anonymous referees which, by their suggestions, greatly improved Sections 3.2, 4.2, and 4.3.

1. PACKED MATRICES

1.1. **Definitions.** Let $k \geq 1$ be an integer. We denote by $\mathcal{M}_{k,n,\ell}$ the set of $n \times n$ matrices with exactly ℓ nonzero entries in the alphabet $A_k := \{0, 1, \dots, k\}$ and by $N_r(M)$ (resp. $N_c(M)$) the set of the indices of the zero rows (resp. columns) of $M \in \mathcal{M}_{k,n,\ell}$. For example, consider the matrix

$$(1.1.1) \quad M := \begin{bmatrix} 0 & 1 & 0 & 0 & 1 & 0 \\ 0 & 0 & 0 & 1 & 0 & 1 \\ 0 & 1 & 0 & 0 & 0 & 0 \\ 0 & 0 & 0 & 1 & 1 & 0 \\ 0 & 0 & 0 & 0 & 0 & 0 \\ 0 & 0 & 0 & 0 & 0 & 1 \end{bmatrix}.$$

We have

$$(1.1.2) \quad N_r(M) = \{5\} \quad \text{and} \quad N_c(M) = \{1, 3\}.$$

A k -packed matrix M of size n is a matrix in $\bigcup_{\ell \geq 0} \mathcal{M}_{k,n,\ell}$ in which each row and each column contains at least one entry different from 0, that is to say if the subsets $N_r(M)$ and $N_c(M)$ are empty.

We shall denote in the sequel by $\mathcal{P}_{k,n,\ell}$ the set of k -packed matrices of size n with exactly ℓ nonzero entries, by $\mathcal{P}_{k,n,-}$ the set of all k -packed matrices of size n , by $\mathcal{P}_{k,-,\ell}$ the set of all k -packed matrices with exactly ℓ nonzero entries, and by \mathcal{P}_k the set of all k -packed matrices. The k -packed matrix of size 0 is denoted by \emptyset . For instance, the seven 1-packed matrices of size 2 are

$$(1.1.3) \quad \begin{bmatrix} 1 & 0 \\ 0 & 1 \end{bmatrix}, \quad \begin{bmatrix} 0 & 1 \\ 1 & 0 \end{bmatrix}, \quad \begin{bmatrix} 1 & 1 \\ 1 & 0 \end{bmatrix}, \quad \begin{bmatrix} 1 & 1 \\ 0 & 1 \end{bmatrix}, \quad \begin{bmatrix} 1 & 0 \\ 1 & 1 \end{bmatrix}, \quad \begin{bmatrix} 0 & 1 \\ 1 & 1 \end{bmatrix}, \quad \begin{bmatrix} 1 & 1 \\ 1 & 1 \end{bmatrix}.$$

Besides, the ten 1-packed matrices of $\mathcal{P}_{1,-,3}$ are

$$(1.1.4) \quad \begin{bmatrix} 1 & 1 \\ 1 & 0 \end{bmatrix}, \begin{bmatrix} 1 & 1 \\ 0 & 1 \end{bmatrix}, \begin{bmatrix} 1 & 0 \\ 1 & 1 \end{bmatrix}, \begin{bmatrix} 0 & 1 \\ 1 & 1 \end{bmatrix}, \begin{bmatrix} 1 & 0 & 0 \\ 0 & 1 & 0 \\ 0 & 0 & 1 \end{bmatrix}, \begin{bmatrix} 1 & 0 & 0 \\ 0 & 0 & 1 \\ 0 & 1 & 0 \end{bmatrix}, \begin{bmatrix} 0 & 1 & 0 \\ 1 & 0 & 0 \\ 0 & 0 & 1 \end{bmatrix}, \begin{bmatrix} 0 & 0 & 1 \\ 1 & 0 & 0 \\ 0 & 1 & 0 \end{bmatrix}, \begin{bmatrix} 0 & 1 & 0 \\ 0 & 0 & 1 \\ 1 & 0 & 0 \end{bmatrix}, \begin{bmatrix} 0 & 0 & 1 \\ 0 & 1 & 0 \\ 1 & 0 & 0 \end{bmatrix}.$$

Let us now define some operations on packed matrices. We shall denote by Z_n^m the $n \times m$ null matrix. Given M_1 and M_2 two k -packed matrices of respective sizes n_1 and n_2 , set

$$(1.1.5) \quad M_1 / M_2 := \left[\begin{array}{c|c} M_1 & Z_{n_1}^{n_2} \\ \hline Z_{n_2}^{n_1} & M_2 \end{array} \right] \quad \text{and} \quad M_1 \setminus M_2 := \left[\begin{array}{c|c} Z_{n_1}^{n_2} & M_1 \\ \hline M_2 & Z_{n_2}^{n_1} \end{array} \right].$$

Note that these two matrices are k -packed matrices of size $n_1 + n_2$. We shall respectively call $/$ and \setminus the *over* and *under* operators. These two operators are obviously associative.

Given a matrix M whose entries are elements of the alphabet A_k , the *compression* of M is the matrix $\text{cp}(M)$ obtained by deleting in M all null rows and columns. Let M be a k -packed matrix. The tuple (M_1, \dots, M_r) is a *column decomposition* of M , and we write $M = M_1 \bullet \dots \bullet M_r$, if for all $i \in [r]$ the $\text{cp}(M_i)$ are square matrices (and not necessarily column matrices) and

$$(1.1.6) \quad M = [M_1 | \dots | M_r].$$

Similarly, the tuple (M_1, \dots, M_r) is a *row decomposition* of M , and we write $M = M_1 \circ \dots \circ M_r$, if for all $i \in [r]$ the $\text{cp}(M_i)$ are square matrices (and not necessarily row matrices) and

$$(1.1.7) \quad M = \left[\begin{array}{c} M_1 \\ \dots \\ M_r \end{array} \right].$$

For instance, here are a 1-packed matrix of size 5, one of its column decompositions and one of its row decompositions:

$$(1.1.8) \quad \begin{bmatrix} 0 & 1 & 1 & 0 & 0 \\ 0 & 0 & 1 & 0 & 0 \\ 0 & 0 & 0 & 1 & 1 \\ 1 & 0 & 0 & 0 & 0 \\ 0 & 0 & 0 & 1 & 1 \end{bmatrix} = \begin{bmatrix} 0 & 1 & 1 \\ 0 & 0 & 1 \\ 0 & 0 & 0 \\ 1 & 0 & 0 \\ 0 & 0 & 0 \end{bmatrix} \bullet \begin{bmatrix} 0 & 0 \\ 0 & 0 \\ 1 & 1 \\ 0 & 0 \\ 1 & 1 \end{bmatrix} = \begin{bmatrix} 0 & 1 & 1 & 0 & 0 \\ 0 & 0 & 1 & 0 & 0 \end{bmatrix} \circ \begin{bmatrix} 0 & 0 & 0 & 1 & 1 \\ 1 & 0 & 0 & 0 & 0 \\ 0 & 0 & 0 & 1 & 1 \end{bmatrix}.$$

These two decompositions have the following property.

Lemma 1.1. *Let M be a packed square matrix and (M_1, M_2) be a column (resp. row) decomposition of M . Then, there is no integer i such that the i th rows (resp. columns) of M_1 and M_2 contain both a nonzero entry.*

Proof. We prove here the lemma only when (M_1, M_2) is a column decomposition of M . The case of a row decomposition can be proven in an analogous way.

Let us denote by n the size of M and assume that M_1 (resp. M_2) has n_1 (resp. n_2) columns. The lemma follows from the fact that since (M_1, M_2) is a column decomposition of M , there are n_1 nonzero rows in M_1 , n_2 nonzero rows in M_2 , and $n = n_1 + n_2$. \square

Lemma 1.1 provides a sufficient condition to ensure that a given pair (M_1, M_2) of matrices cannot be a column (resp. row) decomposition of a matrix M . Nevertheless, it is not a necessary condition. Indeed, let

$$(1.1.9) \quad M := \begin{bmatrix} 1 & 1 & 0 \\ 0 & 0 & 1 \\ 0 & 0 & 1 \end{bmatrix} \quad \text{and} \quad (M_1, M_2) := \left(\begin{bmatrix} 1 & 1 \\ 0 & 0 \\ 0 & 0 \end{bmatrix}, \begin{bmatrix} 0 \\ 1 \\ 1 \end{bmatrix} \right).$$

Then, even if there is no nonzero entry on the same row in M_1 and M_2 , (M_1, M_2) is not a column decomposition of M .

1.2. **Enumeration.** Using the sieve principle, we obtain the following enumerative result.

Proposition 1.2. *For any $k \geq 1$, $n \geq 0$, and $\ell \geq 0$, the number $\#\mathcal{P}_{k,n,\ell}$ of k -packed matrices of size n with exactly ℓ nonzero entries is*

$$(1.2.1) \quad \#\mathcal{P}_{k,n,\ell} = \sum_{0 \leq i,j \leq n} (-1)^{i+j} \binom{n}{i} \binom{n}{j} \binom{ij}{\ell} k^\ell.$$

Proof. For any subsets R and C of $[n]$ let us define the set

$$(1.2.2) \quad \mathcal{S}(R, C) := \{M \in \mathcal{M}_{k,n,\ell} : N_r(M) = R \text{ and } N_c(M) = C\}.$$

Since $\#\mathcal{P}_{k,n,\ell} = \#\mathcal{S}(\emptyset, \emptyset)$, we shall compute $\#\mathcal{S}(\emptyset, \emptyset)$ to prove (1.2.1).

For that, let us consider the order relation \leq defined on the set of pairs (R, C) of subsets of $[n]$ by

$$(1.2.3) \quad (R_1, C_1) \leq (R_2, C_2) \text{ if and only if } R_1 \subseteq R_2 \text{ and } C_1 \subseteq C_2.$$

We have, by setting $r := \#R$ and $c := \#C$,

$$(1.2.4) \quad \sum_{(R,C) \leq (R',C')} \#\mathcal{S}(R', C') = \binom{(n-r)(n-c)}{\ell} k^\ell$$

since (1.2.4) is the number of matrices $M \in \mathcal{M}_{k,n,\ell}$ such that $R \subseteq N_r(M)$ and $C \subseteq N_c(M)$. Then, by Möbius inversion on the Boolean lattice, we obtain

$$(1.2.5) \quad \#\mathcal{S}(\emptyset, \emptyset) = \sum_{(\emptyset, \emptyset) \leq (R,C)} (-1)^{r+c} \binom{(n-r)(n-c)}{\ell} k^\ell,$$

and (1.2.1) follows. □

Table 1 shows the first few values of $\#\mathcal{P}_{k,n,\ell}$. The enumeration in the case $k = 1$ is Sequence [A055599](#) of [Slo].

(a) Number of 1-packed matrices.										
	0	1	2	3	4	5	6	7	8	9
0	1									
1		1								
2			2	4	1					
3				6	45	90	78	36	9	1

(b) Number of 2-packed matrices.										
	0	1	2	3	4	5	6	7	8	9
0	1									
1		2								
2			8	32	16					
3				48	720	2880	4992	4608	2304	512

TABLE 1. The number of k -packed matrices of size n (vertical values) with exactly ℓ nonzero entries (horizontal values).

Notice that for any $n \geq 0$, since

$$(1.2.6) \quad \mathcal{P}_{k,n,-} = \bigsqcup_{n \leq \ell \leq n^2} \mathcal{P}_{k,n,\ell},$$

the set $\mathcal{P}_{k,n,-}$ is finite. Hence, by using Proposition 1.2, we obtain

$$(1.2.7) \quad \#\mathcal{P}_{k,n,-} = \sum_{0 \leq i,j \leq n} (-1)^{i+j} \binom{n}{i} \binom{n}{j} (k+1)^{ij}.$$

Sequences $(\#\mathcal{P}_{1,n,-})_{n \geq 0}$ and $(\#\mathcal{P}_{2,n,-})_{n \geq 0}$ respectively start with

$$(1.2.8) \quad 1, 1, 7, 265, 41503, 24997921, 57366997447, \quad [\text{Slo, A048291}]$$

and

$$(1.2.9) \quad 1, 2, 56, 16064, 39156608, 813732073472, 147662286695991296.$$

Similarly, since for any $\ell \geq 0$,

$$(1.2.10) \quad \mathcal{P}_{k,-,\ell} = \bigsqcup_{\lceil \sqrt{\ell} \rceil \leq n \leq \ell} \mathcal{P}_{k,n,\ell},$$

the set $\mathcal{P}_{k,-,\ell}$ is finite. Hence, by using Proposition 1.2, we obtain

$$(1.2.11) \quad \#\mathcal{P}_{k,-,\ell} = \sum_{0 \leq i,j \leq n \leq \ell} (-1)^{i+j} \binom{n}{i} \binom{n}{j} \binom{ij}{\ell} k^\ell.$$

Sequences $(\#\mathcal{P}_{1,-,\ell})_{\ell \geq 0}$ and $(\#\mathcal{P}_{2,-,\ell})_{\ell \geq 0}$ respectively start with

$$(1.2.12) \quad 1, 1, 2, 10, 70, 642, 7246, 97052, 1503700, \quad [\text{Slo, A104602}]$$

and

$$(1.2.13) \quad 1, 2, 8, 80, 1120, 20544, 463744, 12422656, 384947200.$$

1.3. Hopf algebra structure. In the sequel, all the algebraic structures have a field \mathbb{K} of characteristic zero as ground field.

Let for any $k \geq 1$

$$(1.3.1) \quad \mathbf{PM}_k := \bigoplus_{n \geq 0} \bigoplus_{\ell \geq 0} \text{Vect}(\mathcal{P}_{k,n,\ell})$$

be the bigraded vector space spanned by the set of all k -packed matrices. The elements \mathbf{F}_M , where the M are k -packed matrices, form a basis of \mathbf{PM}_k . We shall call this basis the *fundamental basis* of \mathbf{PM}_k .

Given M_1 and M_2 two k -packed matrices of respective sizes n_1 and n_2 , set

$$(1.3.2) \quad M_1 \circ n_2 := \begin{bmatrix} M_1 \\ Z_{n_2}^{n_1} \end{bmatrix} \quad \text{and} \quad n_1 \circ M_2 := \begin{bmatrix} Z_{n_1}^{n_2} \\ M_2 \end{bmatrix}.$$

The *column shifted shuffle* $M_1 \sqcup M_2$ of M_1 and M_2 is the set of all matrices obtained by shuffling the columns of $M_1 \circ n_2$ with the columns of $n_1 \circ M_2$.

Let us endow \mathbf{PM}_k with a product \cdot linearly defined, for any k -packed matrices M_1 and M_2 , by

$$(1.3.3) \quad \mathbf{F}_{M_1} \cdot \mathbf{F}_{M_2} := \sum_{M \in M_1 \sqcup M_2} \mathbf{F}_M.$$

For instance, in \mathbf{PM}_1 one has

$$(1.3.4) \quad \mathbf{F} \begin{bmatrix} 0 & 1 \\ 1 & 1 \end{bmatrix} \cdot \mathbf{F} \begin{bmatrix} 1 & 0 \\ 0 & 1 \end{bmatrix} = \mathbf{F} \begin{bmatrix} 0 & 1 & 0 & 0 \\ 1 & 1 & 0 & 0 \\ 0 & 0 & 1 & 0 \\ 0 & 0 & 0 & 1 \end{bmatrix} + \mathbf{F} \begin{bmatrix} 0 & 0 & 1 & 0 \\ 1 & 0 & 1 & 0 \\ 0 & 1 & 0 & 0 \\ 0 & 0 & 0 & 1 \end{bmatrix} + \mathbf{F} \begin{bmatrix} 0 & 0 & 0 & 1 \\ 1 & 0 & 0 & 1 \\ 0 & 1 & 0 & 0 \\ 0 & 0 & 1 & 0 \end{bmatrix} \\ + \mathbf{F} \begin{bmatrix} 0 & 0 & 1 & 0 \\ 0 & 1 & 1 & 0 \\ 1 & 0 & 0 & 0 \\ 0 & 0 & 0 & 1 \end{bmatrix} + \mathbf{F} \begin{bmatrix} 0 & 0 & 0 & 1 \\ 0 & 1 & 0 & 1 \\ 1 & 0 & 0 & 0 \\ 0 & 0 & 1 & 0 \end{bmatrix} + \mathbf{F} \begin{bmatrix} 0 & 0 & 0 & 1 \\ 0 & 0 & 1 & 1 \\ 1 & 0 & 0 & 0 \\ 0 & 1 & 0 & 0 \end{bmatrix}.$$

Moreover, we endow \mathbf{PM}_k with a coproduct Δ linearly defined, for any k -packed matrix M , by

$$(1.3.5) \quad \Delta(\mathbf{F}_M) := \sum_{M=M_1 \bullet M_2} \mathbf{F}_{\text{cp}(M_1)} \otimes \mathbf{F}_{\text{cp}(M_2)}.$$

For instance, in \mathbf{PM}_1 one has

$$(1.3.6) \quad \Delta \mathbf{F} \begin{bmatrix} 1 & 1 & 0 & 0 \\ 0 & 0 & 0 & 1 \\ 1 & 0 & 1 & 0 \\ 0 & 1 & 0 & 0 \end{bmatrix} = \mathbf{F} \begin{bmatrix} 1 & 1 & 0 & 0 \\ 0 & 0 & 0 & 1 \\ 1 & 0 & 1 & 0 \\ 0 & 1 & 0 & 0 \end{bmatrix} \otimes \mathbf{F}_\emptyset + \mathbf{F} \begin{bmatrix} 1 & 1 & 0 \\ 1 & 0 & 1 \\ 0 & 1 & 0 \end{bmatrix} \otimes \mathbf{F}_{[1]} + \mathbf{F}_\emptyset \otimes \mathbf{F} \begin{bmatrix} 1 & 1 & 0 & 0 \\ 0 & 0 & 0 & 1 \\ 1 & 0 & 1 & 0 \\ 0 & 1 & 0 & 0 \end{bmatrix}.$$

Note that by definition, the product and the coproduct of \mathbf{PM}_k are multiplicity free.

Theorem 1.3. *The vector space \mathbf{PM}_k endowed with the product \cdot and the coproduct Δ is a bigraded and connected bialgebra where homogeneous components are finite-dimensional.*

Proof. First, it is plain that the product of \mathbf{PM}_k respects the bigradation. Moreover, Lemma 1.1 implies that it is also the case for its coproduct. Since \emptyset is the only packed matrix of size 0 without nonzero entries, \mathbf{PM}_k is connected. Besides, since for all $n, \ell \geq 0$, the sets $\mathcal{P}_{k,n,\ell}$ are finite, homogeneous components of \mathbf{PM}_k are finite-dimensional.

The associativity of \cdot arises from the associativity of the shifted shuffle operation on words on a totally ordered alphabet. Indeed, a packed matrix M can be seen as a word u where the i th letter of u is the i th column of M . Moreover, the coassociativity of Δ comes from the fact that $(M_1 \bullet M_2) \bullet M_3$ is a column decomposition of a packed matrix M if and only if $M_1 \bullet (M_2 \bullet M_3)$ also is.

It remains to show that Δ is an algebra morphism. Let M_1 and M_2 be two packed matrices. The obvious fact that (L, R) is a column decomposition of a matrix M appearing in the shifted shuffle of M_1 and M_2 if and only if L (resp. R) appears in the shifted shuffle of L_1 and L_2 (resp. R_1 and R_2) where (L_1, R_1) is a column decomposition of M_1 and (L_2, R_2) is a column decomposition of M_2 , ensures that Δ is an algebra morphism. \square

Since \mathbf{PM}_k is, by Theorem 1.3, a bigraded and connected bialgebra, it admits an antipode and hence, is a Hopf algebra. The antipode S of \mathbf{PM}_k satisfies, for any k -packed matrix M ,

$$(1.3.7) \quad S(\mathbf{F}_M) = \sum_{\substack{\ell \geq 1 \\ M=M_1 \bullet \dots \bullet M_\ell \\ M_i \neq \emptyset, i \in [\ell]}} (-1)^\ell \mathbf{F}_{\text{cp}(M_1)} \cdots \mathbf{F}_{\text{cp}(M_\ell)}.$$

For instance, in \mathbf{PM}_1 one has

$$\begin{aligned}
 (1.3.8) \quad S\mathbf{F} \begin{bmatrix} 0 & 1 & 1 \\ 1 & 0 & 0 \\ 0 & 1 & 0 \end{bmatrix} &= -\mathbf{F} \begin{bmatrix} 0 & 1 & 1 \\ 1 & 0 & 0 \\ 0 & 1 & 0 \end{bmatrix} + \mathbf{F}_{[1]} \cdot \mathbf{F} \begin{bmatrix} 1 & 1 \\ 1 & 0 \end{bmatrix} \\
 &= \mathbf{F} \begin{bmatrix} 1 & 0 & 0 \\ 0 & 1 & 1 \\ 0 & 1 & 0 \end{bmatrix} + \mathbf{F} \begin{bmatrix} 0 & 1 & 0 \\ 1 & 0 & 1 \\ 1 & 0 & 0 \end{bmatrix} + \mathbf{F} \begin{bmatrix} 0 & 0 & 1 \\ 1 & 1 & 0 \\ 1 & 0 & 0 \end{bmatrix} - \mathbf{F} \begin{bmatrix} 0 & 1 & 1 \\ 1 & 0 & 0 \\ 0 & 1 & 0 \end{bmatrix}.
 \end{aligned}$$

Note besides that S is not an involution. Indeed,

$$\begin{aligned}
 (1.3.9) \quad S^2\mathbf{F} \begin{bmatrix} 0 & 1 & 1 \\ 1 & 0 & 0 \\ 0 & 1 & 0 \end{bmatrix} &= \mathbf{F} \begin{bmatrix} 1 & 1 & 0 \\ 1 & 0 & 0 \\ 0 & 0 & 1 \end{bmatrix} + \mathbf{F} \begin{bmatrix} 1 & 0 & 1 \\ 1 & 0 & 0 \\ 0 & 1 & 0 \end{bmatrix} + \mathbf{F} \begin{bmatrix} 0 & 1 & 1 \\ 0 & 1 & 0 \\ 1 & 0 & 0 \end{bmatrix} + \mathbf{F} \begin{bmatrix} 0 & 1 & 1 \\ 1 & 0 & 0 \\ 0 & 1 & 0 \end{bmatrix} \\
 &\quad - \mathbf{F} \begin{bmatrix} 1 & 0 & 0 \\ 0 & 1 & 1 \\ 0 & 1 & 0 \end{bmatrix} - \mathbf{F} \begin{bmatrix} 0 & 1 & 0 \\ 1 & 0 & 1 \\ 1 & 0 & 0 \end{bmatrix} - \mathbf{F} \begin{bmatrix} 0 & 0 & 1 \\ 1 & 1 & 0 \\ 1 & 0 & 0 \end{bmatrix}.
 \end{aligned}$$

Notice that since any k -packed matrix is also a $k+1$ -packed matrix, the vector space \mathbf{PM}_k is included in \mathbf{PM}_{k+1} . Hence, and by Theorem 1.3,

$$(1.3.10) \quad \mathbf{PM}_1 \hookrightarrow \mathbf{PM}_2 \hookrightarrow \dots$$

is an increasing infinite sequence of Hopf algebras for inclusion. The first few dimensions of \mathbf{PM}_1 and \mathbf{PM}_2 are given by Table 1.

Let us now set

$$(1.3.11) \quad \mathbf{PMN}_k := \bigoplus_{n \geq 0} \text{Vect}(\mathcal{P}_{k,n,-}) \quad \text{and} \quad \mathbf{PML}_k := \bigoplus_{\ell \geq 0} \text{Vect}(\mathcal{P}_{k,-,\ell})$$

the vector spaces of k -packed matrices respectively graded by the size and by the number of nonzero entries of matrices. By Theorem 1.3, and since each homogeneous component of these vector spaces is finite-dimensional (see Section 1.2), \mathbf{PMN}_k and \mathbf{PML}_k are Hopf algebras. Besides,

$$(1.3.12) \quad \mathbf{PMN}_1 \hookrightarrow \mathbf{PMN}_2 \hookrightarrow \dots \quad \text{and} \quad \mathbf{PML}_1 \hookrightarrow \mathbf{PML}_2 \hookrightarrow \dots$$

are increasing infinite sequences of Hopf algebras for inclusion. The first few dimensions of \mathbf{PMN}_1 and \mathbf{PMN}_2 are given by (1.2.8) and (1.2.9), and the first few dimensions of \mathbf{PML}_1 and \mathbf{PML}_2 are given by (1.2.12) and (1.2.13). In the sequel, we shall denote by $\mathcal{H}_{k,n}(t)$ (resp. $\mathcal{H}_{k,\ell}(t)$) the Hilbert series of \mathbf{PMN}_k (resp. \mathbf{PML}_k).

2. ALGEBRAIC PROPERTIES

2.1. Multiplicative bases and freeness.

2.1.1. *Poset structure.* We endow the set \mathcal{P}_k with a binary relation \rightarrow defined in the following way. If M_1 and M_2 are two k -packed matrices of size n , we have $M_1 \rightarrow M_2$ if there is an index $i \in [n-1]$ such that, denoting by s the number of 0 ending the i th column of M_1 , and by p the number of 0 starting the $(i+1)$ st column of M_1 , one has $s+p \geq n$ and M_2 is obtained from M_1 by exchanging its i th and $(i+1)$ st columns (see Figure 1).

We now endow \mathcal{P}_k with the partial order relation $\leq_{\mathbb{M}}$ defined as the reflexive and transitive closure of \rightarrow . Figure 2 shows an interval of this partial order.

Notice that by regarding a permutation σ of \mathfrak{S}_n as its *permutation matrix* (i.e., the 1-packed matrix M of size n satisfying $M_{ij} = 1$ if and only if $\sigma_j = i$), the poset $(\mathcal{P}_{k,n,-}, \leq_{\mathbb{M}})$ restricted to permutation matrices is the right weak order on permutations [GR63].

Lemma 2.1. *Let M , A and B be three packed matrices. Then,*

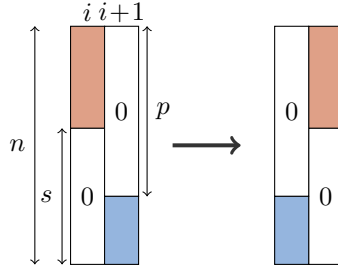

FIGURE 1. The condition for swapping the i th and $(i + 1)$ st columns of a packed matrix according to the relation \rightarrow . The darker regions contain any entries and the white ones, only zeros.

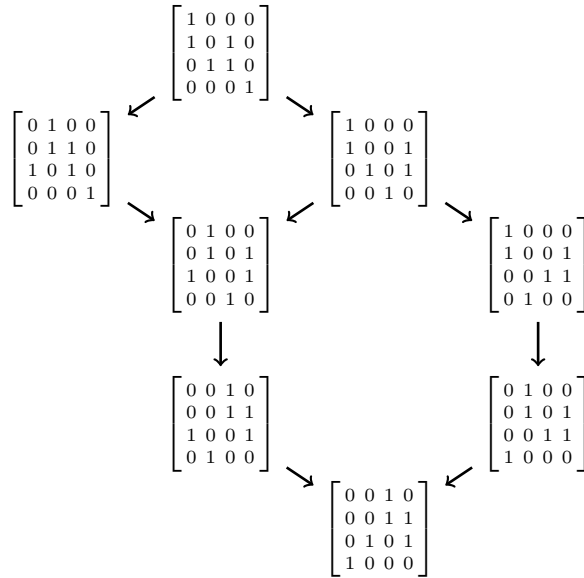

FIGURE 2. The Hasse diagram of an interval for the order \leq_M on packed matrices.

- (1) $A/B \leq_M M$ if and only if there are two packed matrices A' and B' such that $A \leq_M A'$, $B \leq_M B'$, and $M \in A' \sqcup B'$;
- (2) $M \leq_M A \setminus B$ if and only if there are two packed matrices A' and B' such that $A' \leq_M A$, $B' \leq_M B$, and $M \in A' \sqcup B'$.

Proof. Assume that $A/B \leq_M M$. By definition of the order \leq_M , M can be obtained from A/B by swapping columns coming from A to obtain a matrix A' satisfying $A \leq_M A'$, by swapping columns coming from B to obtain a matrix B' satisfying $B \leq_M B'$, and then, by swapping columns coming from A' and from B' together. Thereby, $M \in A' \sqcup B'$.

Conversely assume that $A \leq_M A'$, $B \leq_M B'$, and $M \in A' \sqcup B'$. Then, by definition of the shifted shuffle product and the over operator, $A'/B' \leq_M M$. This implies $A/B \leq_M M$.

By very similar arguments, (2) is established. □

2.1.2. *Multiplicative bases.* By mimicking definitions of the bases of symmetric functions, for any k -packed matrix M , the *elementary elements* \mathbf{E}_M and the *homogeneous elements* \mathbf{H}_M are respectively defined by

$$(2.1.1) \quad \mathbf{E}_M := \sum_{M \leq_{\mathfrak{M}} M'} \mathbf{F}_{M'} \quad \text{and} \quad \mathbf{H}_M := \sum_{M' \leq_{\mathfrak{M}} M} \mathbf{F}_{M'}.$$

By triangularity, these two families are bases of \mathbf{PM}_k . For instance, in \mathbf{PM}_1 one has

$$(2.1.2) \quad \mathbf{E} \begin{bmatrix} 1 & 0 & 0 & 0 \\ 1 & 0 & 0 & 1 \\ 0 & 0 & 1 & 1 \\ 0 & 1 & 0 & 0 \end{bmatrix} = \mathbf{F} \begin{bmatrix} 1 & 0 & 0 & 0 \\ 1 & 0 & 0 & 1 \\ 0 & 0 & 1 & 1 \\ 0 & 1 & 0 & 0 \end{bmatrix} + \mathbf{F} \begin{bmatrix} 0 & 1 & 0 & 0 \\ 0 & 1 & 0 & 1 \\ 0 & 0 & 1 & 1 \\ 1 & 0 & 0 & 0 \end{bmatrix} + \mathbf{F} \begin{bmatrix} 0 & 0 & 1 & 0 \\ 0 & 0 & 1 & 1 \\ 0 & 1 & 0 & 1 \\ 1 & 0 & 0 & 0 \end{bmatrix},$$

and

$$(2.1.3) \quad \mathbf{H} \begin{bmatrix} 0 & 1 & 0 & 0 \\ 0 & 1 & 0 & 1 \\ 1 & 0 & 0 & 1 \\ 0 & 0 & 1 & 0 \end{bmatrix} = \mathbf{F} \begin{bmatrix} 0 & 1 & 0 & 0 \\ 0 & 1 & 0 & 1 \\ 1 & 0 & 0 & 1 \\ 0 & 0 & 1 & 0 \end{bmatrix} + \mathbf{F} \begin{bmatrix} 0 & 1 & 0 & 0 \\ 0 & 1 & 1 & 0 \\ 1 & 0 & 1 & 0 \\ 0 & 0 & 0 & 1 \end{bmatrix} + \mathbf{F} \begin{bmatrix} 1 & 0 & 0 & 0 \\ 1 & 0 & 0 & 1 \\ 0 & 1 & 0 & 1 \\ 0 & 0 & 1 & 0 \end{bmatrix} + \mathbf{F} \begin{bmatrix} 1 & 0 & 0 & 0 \\ 1 & 0 & 1 & 0 \\ 0 & 1 & 1 & 0 \\ 0 & 0 & 0 & 1 \end{bmatrix}.$$

Proposition 2.2. *The elements appearing in a product of \mathbf{PM}_k expressed in the fundamental basis form an interval for the $\leq_{\mathfrak{M}}$ -partial order. More precisely, for any k -packed matrices M_1 and M_2 ,*

$$(2.1.4) \quad \mathbf{F}_{M_1} \cdot \mathbf{F}_{M_2} = \sum_{M_1 / M_2 \leq_{\mathfrak{M}} M \leq_{\mathfrak{M}} M_1 \setminus M_2} \mathbf{F}_M.$$

Proof. It is plain that the left and right-hand side of (2.1.4) are multiplicity-free. Then, it is enough to show that the sets $M_1 \sqcup M_2$ and $[M_1 / M_2, M_1 \setminus M_2]$ are equal. This is a consequence of Lemma 2.1. \square

Proposition 2.3. *The product of \mathbf{PM}_k satisfies, for any k -packed matrices M_1 and M_2 ,*

$$(2.1.5) \quad \mathbf{E}_{M_1} \cdot \mathbf{E}_{M_2} = \mathbf{E}_{M_1 / M_2} \quad \text{and} \quad \mathbf{H}_{M_1} \cdot \mathbf{H}_{M_2} = \mathbf{H}_{M_1 \setminus M_2}.$$

Proof. We shall prove the product rule for the elementary basis by expanding $\mathbf{E}_{M_1} \cdot \mathbf{E}_{M_2}$ and \mathbf{E}_{M_1 / M_2} over the fundamental basis. First, since any element \mathbf{F}_N , where N is a packed matrix, appearing in $\mathbf{E}_{M_1} \cdot \mathbf{E}_{M_2}$ is obtained by shifting and shuffling two matrices N_1 and N_2 such that $M_1 \leq_{\mathfrak{M}} N_1$ and $M_2 \leq_{\mathfrak{M}} N_2$, $\mathbf{E}_{M_1} \cdot \mathbf{E}_{M_2}$ is multiplicity-free over the fundamental basis. Moreover, by definition of the elementary basis, \mathbf{E}_{M_1 / M_2} is multiplicity-free over the fundamental basis.

Therefore, it is enough to prove that the sets

$$(2.1.6) \quad \{N \in N_1 \sqcup N_2 : M_1 \leq_{\mathfrak{M}} N_1 \text{ and } M_2 \leq_{\mathfrak{M}} N_2\}$$

and

$$(2.1.7) \quad \{N \in \mathcal{P}_k : M_1 / M_2 \leq_{\mathfrak{M}} N\}$$

are equal. This is exactly (1) of Lemma 2.1.

The proof for the homogeneous basis is analogous. \square

2.1.3. *Freeness.* Given a k -packed matrix $M \neq \emptyset$, we say that M is *connected* (resp. *anti-connected*) if, for all k -packed matrices M_1 and M_2 , $M = M_1 / M_2$ (resp. $M = M_1 \setminus M_2$) implies $M_1 = M$ or $M_2 = M$.

Theorem 2.4. *The Hopf algebra \mathbf{PM}_k is freely generated as an algebra by the elements \mathbf{E}_M (resp. \mathbf{H}_M) where the M are connected (resp. anti-connected) k -packed matrices.*

Proof. Since any packed matrix M can be written as

$$(2.1.8) \quad M = M_1 / \dots / M_r,$$

where the M_i are connected packed matrices, by Proposition 2.3, we have

$$(2.1.9) \quad \mathbf{E}_M = \mathbf{E}_{M_1} \cdot \dots \cdot \mathbf{E}_{M_r},$$

showing that the \mathbf{E}_M , where M is a connected packed matrix, generate \mathbf{PM}_k as an algebra. Besides, the obvious unicity of the factorization (2.1.8) shows that this family is free.

The proof for the homogeneous basis is analogous. □

Theorem 2.4 also implies that \mathbf{PMN}_k and \mathbf{PML}_k are freely generated by the \mathbf{E}_M (resp. \mathbf{H}_M) where the M are connected (resp. anti-connected) k -packed matrices. Hence, the generating series $\mathcal{G}_{k,n}(t)$ and $\mathcal{G}_{k,\ell}(t)$ of algebraic generators of \mathbf{PMN}_k and \mathbf{PML}_k satisfy respectively

$$(2.1.10) \quad \mathcal{G}_{k,n}(t) = 1 - \frac{1}{\mathcal{H}_{k,n}(t)} \quad \text{and} \quad \mathcal{G}_{k,\ell}(t) = 1 - \frac{1}{\mathcal{H}_{k,\ell}(t)}.$$

The first few numbers of algebraic generators of \mathbf{PMN}_1 and \mathbf{PMN}_2 are respectively

$$(2.1.11) \quad 0, 1, 6, 252, 40944, 24912120, 57316485000$$

and

$$(2.1.12) \quad 0, 2, 52, 15848, 39089872, 813573857696, 147659027604370240.$$

The first few numbers of algebraic generators of \mathbf{PML}_1 and \mathbf{PML}_2 are respectively

$$(2.1.13) \quad 0, 1, 1, 7, 51, 497, 5865, 81305, 1293333$$

and

$$(2.1.14) \quad 0, 2, 4, 56, 816, 15904, 375360, 10407040, 331093248.$$

2.2. Self-duality.

2.2.1. *Dual Hopf algebra.* Let us denote by \mathbf{PM}_k^* the bigraded dual vector space of \mathbf{PM}_k , by \mathbf{F}_M^* , where the M are k -packed matrices, the adjoint basis of the fundamental basis of \mathbf{PM}_k , and by $\langle -, - \rangle$ the associated duality bracket.

Let M_1 and M_2 be two k -packed matrices of respective sizes n_1 and n_2 . By duality, the product in \mathbf{PM}_k^* satisfies

$$(2.2.1) \quad \mathbf{F}_{M_1}^* \cdot \mathbf{F}_{M_2}^* = \sum_{M \in \mathcal{P}_k} \langle \Delta(\mathbf{F}_M), \mathbf{F}_{M_1}^* \otimes \mathbf{F}_{M_2}^* \rangle \mathbf{F}_M^*.$$

Let us set

$$(2.2.2) \quad M_1 \bullet n_2 := [M_1 | Z_{n_1}^{n_2}] \quad \text{and} \quad n_1 \bullet M_2 := [Z_{n_2}^{n_1} | M_2].$$

The *row shifted shuffle* $M_1 * M_2$ of M_1 and M_2 is the set of all matrices obtained by shuffling the rows of $M_1 \bullet n_2$ with the rows of $n_1 \bullet M_2$. By a routine computation, we obtain the following expression for the product of \mathbf{PM}_k^* :

$$(2.2.3) \quad \mathbf{F}_{M_1}^* \cdot \mathbf{F}_{M_2}^* = \sum_{M \in M_1 * M_2} \mathbf{F}_M^*.$$

For instance, in \mathbf{PM}_1^* one has

$$(2.2.4) \quad \mathbf{F}^* \begin{bmatrix} 0 & 1 \\ 1 & 1 \end{bmatrix} \cdot \mathbf{F}^* \begin{bmatrix} 1 & 0 \\ 0 & 1 \end{bmatrix} = \mathbf{F}^* \begin{bmatrix} 0 & 1 & 0 & 0 \\ 1 & 1 & 0 & 0 \\ 0 & 0 & 1 & 0 \\ 0 & 0 & 0 & 1 \end{bmatrix} + \mathbf{F}^* \begin{bmatrix} 0 & 1 & 0 & 0 \\ 0 & 0 & 1 & 0 \\ 1 & 1 & 0 & 0 \\ 0 & 0 & 0 & 1 \end{bmatrix} + \mathbf{F}^* \begin{bmatrix} 0 & 0 & 1 & 0 \\ 0 & 1 & 0 & 0 \\ 1 & 1 & 0 & 0 \\ 0 & 0 & 0 & 1 \end{bmatrix} \\ + \mathbf{F}^* \begin{bmatrix} 0 & 1 & 0 & 0 \\ 0 & 0 & 1 & 0 \\ 0 & 0 & 0 & 1 \\ 1 & 1 & 0 & 0 \end{bmatrix} + \mathbf{F}^* \begin{bmatrix} 0 & 0 & 1 & 0 \\ 0 & 1 & 0 & 0 \\ 0 & 0 & 0 & 1 \\ 1 & 1 & 0 & 0 \end{bmatrix} + \mathbf{F}^* \begin{bmatrix} 0 & 0 & 1 & 0 \\ 0 & 0 & 0 & 1 \\ 0 & 1 & 0 & 0 \\ 1 & 1 & 0 & 0 \end{bmatrix}.$$

Let M be a k -packed matrix. By duality, the coproduct in \mathbf{PM}_k^* satisfies

$$(2.2.5) \quad \Delta(\mathbf{F}_M^*) = \sum_{M_1, M_2 \in \mathcal{P}_k} \langle \mathbf{F}_{M_1} \cdot \mathbf{F}_{M_2}, \mathbf{F}_M^* \rangle \mathbf{F}_{M_1}^* \otimes \mathbf{F}_{M_2}^*.$$

By a routine computation, we obtain the following expression for the coproduct of \mathbf{PM}_k^* :

$$(2.2.6) \quad \Delta(\mathbf{F}_M^*) = \sum_{M=M_1 \circ M_2} \mathbf{F}_{\text{cp}(M_1)}^* \otimes \mathbf{F}_{\text{cp}(M_2)}^*.$$

For instance, in \mathbf{PM}_1^* one has

$$(2.2.7) \quad \Delta \mathbf{F}^* \begin{bmatrix} 0 & 0 & 1 & 0 \\ 0 & 0 & 0 & 1 \\ 1 & 0 & 0 & 0 \\ 1 & 1 & 0 & 0 \end{bmatrix} = \mathbf{F}^* \begin{bmatrix} 0 & 0 & 1 & 0 \\ 0 & 0 & 0 & 1 \\ 1 & 0 & 0 & 0 \\ 1 & 1 & 0 & 0 \end{bmatrix} \otimes \mathbf{F}_\emptyset^* + \mathbf{F}^* \begin{bmatrix} 1 & 0 \\ 1 & 1 \end{bmatrix} \otimes \mathbf{F}^* \begin{bmatrix} 1 & 0 \\ 0 & 1 \end{bmatrix} + \mathbf{F}^* \begin{bmatrix} 0 & 0 & 1 \\ 1 & 0 & 0 \\ 1 & 1 & 0 \end{bmatrix} \otimes \mathbf{F}_{[1]}^* + \mathbf{F}_\emptyset^* \otimes \mathbf{F}^* \begin{bmatrix} 0 & 0 & 1 & 0 \\ 0 & 0 & 0 & 1 \\ 1 & 0 & 0 & 0 \\ 1 & 1 & 0 & 0 \end{bmatrix}.$$

Let us denote by M^T the transpose of M .

Proposition 2.5. *The map $\phi : \mathbf{PM}_k \rightarrow \mathbf{PM}_k^*$ linearly defined for any k -packed matrix M by*

$$(2.2.8) \quad \phi(\mathbf{F}_M) := \mathbf{F}_{M^T}^*$$

is a Hopf isomorphism.

Proof. The product and the coproduct of \mathbf{PM}_k in the fundamental basis handle the columns of the matrices while the product and the coproduct of \mathbf{PM}_k^* in the adjoint basis of the fundamental basis handle the rows. Since the transpose of a matrix swaps its rows and its columns, ϕ is a Hopf isomorphism. \square

Since the transpose of any packed matrix of $\mathcal{P}_{k,n,\ell}$ also belongs to $\mathcal{P}_{k,n,\ell}$, Proposition 2.5 also implies that \mathbf{PMN}_k and \mathbf{PML}_k are self-dual for the isomorphism ϕ .

2.2.2. *Primitive elements.* For any k -packed matrix M , define

$$(2.2.9) \quad \mathbf{W}^M := \mathbf{F}_{M_1}^* \cdots \mathbf{F}_{M_r}^*$$

where the M_i are connected packed matrices (see Section 2.1.3) and $M = M_1 / \dots / M_r$. Then, we have

$$(2.2.10) \quad \mathbf{W}^M = \mathbf{F}_M^* + \sum_{M' \in R} \mathbf{F}_{M'}^*$$

where any matrix M' of R satisfies $M^T \leq_M M'^T$ since the product in \mathbf{PM}_k^* consists in shifting and shuffling rows of matrices. Thus, by triangularity, the \mathbf{W}^M form a basis of \mathbf{PM}_k^* . Moreover, for any k -packed matrices M_1 and M_2 , the product of \mathbf{PM}_k^* is expressed as

$$(2.2.11) \quad \mathbf{W}^{M_1} \cdot \mathbf{W}^{M_2} = \mathbf{W}^{M_1 / M_2}.$$

Let us denote by \mathbf{V}_M , where the M are k -packed matrices, the adjoint elements of the \mathbf{W}^M .

Proposition 2.6. *The elements \mathbf{V}_M , where M are connected k -packed matrices, form a basis of the vector space of primitive elements of \mathbf{PM}_k .*

Proof. Since \mathbf{W}^M is indecomposable, by duality, \mathbf{V}_M is primitive. Moreover, let X be a primitive element of \mathbf{PM}_k . Then, X is expressed as

$$(2.2.12) \quad X = \sum_{M \in \mathcal{P}_k} c_M \mathbf{V}_M.$$

Let M be a nonconnected k -packed matrix and $M = M_1 / M_2$ be a nontrivial factorization. Then, by duality, the coefficient of $\mathbf{V}_{M_1} \otimes \mathbf{V}_{M_2}$ in $\Delta(X)$ is c_M . Since X is primitive, $c_M = 0$, showing that X is a sum of \mathbf{V}_M where M are connected k -packed matrices. \square

By Proposition 2.6, the \mathbf{V}_M , where M are connected k -packed matrices, generate the Lie algebra of primitive elements of \mathbf{PM}_k . The first few dimensions of the Lie algebras of primitive elements of \mathbf{PMN}_1 , \mathbf{PMN}_2 , \mathbf{PML}_1 , \mathbf{PML}_2 are respectively given by (2.1.11), (2.1.12), (2.1.13), and (2.1.14).

2.3. Bidendriform bialgebra structure.

2.3.1. *Dendriform algebra structure.* An algebra (\mathcal{A}, \cdot) admits a *dendriform algebra structure* [Lod01] if its product can be split into two operations

$$(2.3.1) \quad \cdot = \prec + \succ,$$

where $\prec, \succ: \mathcal{A} \otimes \mathcal{A} \rightarrow \mathcal{A}$ are non-degenerated linear maps such that, by denoting by \mathcal{A}^+ the augmentation ideal of \mathcal{A} , for all $x, y, z \in \mathcal{A}^+$, the following relations hold

$$(2.3.2a) \quad (x \prec y) \prec z = x \prec (y \cdot z),$$

$$(2.3.2b) \quad (x \succ y) \prec z = x \succ (y \prec z),$$

$$(2.3.2c) \quad (x \cdot y) \succ z = x \succ (y \succ z).$$

For any nonempty matrix M , we shall denote by $\text{last}_c(M)$ its last column. Let us endow \mathbf{PM}_k^+ with two products \prec and \succ linearly defined, for any nonempty k -packed matrices M_1 and M_2 of respective sizes n_1 and n_2 , by

$$(2.3.3) \quad \mathbf{F}_{M_1} \prec \mathbf{F}_{M_2} := \sum_{\substack{M \in M_1 \boxplus M_2 \\ \text{last}_c(M) = \text{last}_c(M_1 \circ n_2)}} \mathbf{F}_M$$

and

$$(2.3.4) \quad \mathbf{F}_{M_1} \succ \mathbf{F}_{M_2} := \sum_{\substack{M \in M_1 \sqcup M_2 \\ \text{last}_c(M) = \text{last}_c(n_1 \circ M_2)}} \mathbf{F}_M.$$

In other words, the matrices appearing in a \prec -product (resp. \succ -product) in the fundamental basis involving M_1 and M_2 are the matrices M obtained by shifting and shuffling the columns of M_1 and M_2 such that the last column of M comes from M_1 (resp. M_2). For example,

$$(2.3.5) \quad \mathbf{F} \begin{bmatrix} 0 & 1 \\ 1 & 1 \end{bmatrix} \prec \mathbf{F} \begin{bmatrix} 1 & 0 \\ 0 & 1 \end{bmatrix} = \mathbf{F} \begin{bmatrix} 0 & 0 & 0 & 1 \\ 1 & 0 & 0 & 1 \\ 0 & 1 & 0 & 0 \\ 0 & 0 & 1 & 0 \end{bmatrix} + \mathbf{F} \begin{bmatrix} 0 & 0 & 0 & 1 \\ 0 & 1 & 0 & 1 \\ 1 & 0 & 0 & 0 \\ 0 & 0 & 1 & 0 \end{bmatrix} + \mathbf{F} \begin{bmatrix} 0 & 0 & 0 & 1 \\ 0 & 0 & 1 & 1 \\ 1 & 0 & 0 & 0 \\ 0 & 1 & 0 & 0 \end{bmatrix},$$

$$(2.3.6) \quad \mathbf{F} \begin{bmatrix} 0 & 1 \\ 1 & 1 \end{bmatrix} \succ \mathbf{F} \begin{bmatrix} 1 & 0 \\ 0 & 1 \end{bmatrix} = \mathbf{F} \begin{bmatrix} 0 & 1 & 0 & 0 \\ 1 & 1 & 0 & 0 \\ 0 & 0 & 1 & 0 \\ 0 & 0 & 0 & 1 \end{bmatrix} + \mathbf{F} \begin{bmatrix} 0 & 0 & 1 & 0 \\ 1 & 0 & 1 & 0 \\ 0 & 1 & 0 & 0 \\ 0 & 0 & 0 & 1 \end{bmatrix} + \mathbf{F} \begin{bmatrix} 0 & 0 & 1 & 0 \\ 0 & 1 & 1 & 0 \\ 1 & 0 & 0 & 0 \\ 0 & 0 & 0 & 1 \end{bmatrix}.$$

Since the last column of any matrix appearing in the shifted shuffle of two matrices comes from one of the two operands, for any nonempty packed matrices M_1 and M_2 , one obviously has

$$(2.3.7) \quad \mathbf{F}_{M_1} \cdot \mathbf{F}_{M_2} = \mathbf{F}_{M_1} \prec \mathbf{F}_{M_2} + \mathbf{F}_{M_1} \succ \mathbf{F}_{M_2}.$$

Proposition 2.7. *The Hopf algebra \mathbf{PM}_k admits a dendriform algebra structure for the products \prec and \succ .*

Proof. We have to prove that (2.3.2a), (2.3.2b), and (2.3.2c) hold. Let M_1 , M_2 , and M_3 be three packed matrices of respective sizes n_1 , n_2 and n_3 .

By definition of \prec and \succ , and since \sqcup is associative, the set S of matrices indexing the support of $(\mathbf{F}_{M_1} \succ \mathbf{F}_{M_2}) \prec \mathbf{F}_{M_3}$ satisfies

$$(2.3.8) \quad \begin{aligned} S &= \{M \in (M_1 \sqcup M_2) \sqcup M_3 : \text{last}_c(M) = \text{last}_c(n_1 \circ M_2 \circ n_3)\} \\ &= \{M \in M_1 \sqcup (M_2 \sqcup M_3) : \text{last}_c(M) = \text{last}_c(n_1 \circ M_2 \circ n_3)\}. \end{aligned}$$

Hence, S also is the set of matrices indexing the support of $\mathbf{F}_{M_1} \succ (\mathbf{F}_{M_2} \prec \mathbf{F}_{M_3})$. Since the shifted shuffle of packed matrices is multiplicity-free, (2.3.2b) holds.

By definition of \prec and \succ , and since \sqcup is associative, the set T of matrices indexing the support of $(\mathbf{F}_{M_1} \prec \mathbf{F}_{M_2}) \prec \mathbf{F}_{M_3}$ satisfies

$$(2.3.9) \quad \begin{aligned} T &= \{M \in (M_1 \sqcup M_2) \sqcup M_3 : \text{last}_c(M) = \text{last}_c(M_1 \circ (n_2 + n_3))\} \\ &= \{M \in M_1 \sqcup (M_2 \sqcup M_3) : \text{last}_c(M) = \text{last}_c(M_1 \circ (n_2 + n_3))\}. \end{aligned}$$

Hence, by (2.3.7), T also is the set of matrices indexing the support of $\mathbf{F}_{M_1} \prec (\mathbf{F}_{M_2} \cdot \mathbf{F}_{M_3})$. Since the shifted shuffle of packed matrices is multiplicity-free, (2.3.2a) holds. By a very similar argument, (2.3.2c) also holds. \square

2.3.2. Codendriform coalgebra structure. By dualizing the notion of dendriform algebra structure, one obtains the notion of *codendriform coalgebra structure* [Foi07]. A coalgebra (\mathcal{C}, Δ) admits a codendriform coalgebra structure if its coproduct can be split into two operations

$$(2.3.10) \quad \Delta = 1 \otimes I + \Delta_{\prec} + \Delta_{\succ} + I \otimes 1,$$

where $\Delta_{\prec}, \Delta_{\succ} : \mathcal{C} \rightarrow \mathcal{C} \otimes \mathcal{C}$ are non-degenerated linear maps such that following relations hold

$$(2.3.11a) \quad (\Delta_{\prec} \otimes I) \circ \Delta_{\prec} = (I \otimes \bar{\Delta}) \circ \Delta_{\prec},$$

$$(2.3.11b) \quad (\Delta_{\succ} \otimes I) \circ \Delta_{\prec} = (I \otimes \Delta_{\prec}) \circ \Delta_{\succ},$$

$$(2.3.11c) \quad (\bar{\Delta} \otimes I) \circ \Delta_{\succ} = (I \otimes \Delta_{\succ}) \circ \Delta_{\succ},$$

where $\bar{\Delta} := \Delta_{\prec} + \Delta_{\succ}$.

For any nonempty matrix M , we shall denote by $\text{last}_r(M)$ its last row. Let us endow \mathbf{PM}_k with two coproducts Δ_{\prec} and Δ_{\succ} linearly defined, for any nonempty k -packed matrix M , by

$$(2.3.12) \quad \Delta_{\prec}(\mathbf{F}_M) := \sum_{\substack{M=L \bullet R \\ \text{last}_r(L \bullet R) = \text{last}_r(M)}} \mathbf{F}_{\text{cp}(L)} \otimes \mathbf{F}_{\text{cp}(R)}$$

and

$$(2.3.13) \quad \Delta_{\succ}(\mathbf{F}_M) := \sum_{\substack{M=L \bullet R \\ \text{last}_r(\ell \bullet R) = \text{last}_r(M)}} \mathbf{F}_{\text{cp}(L)} \otimes \mathbf{F}_{\text{cp}(R)},$$

where r (resp. ℓ) is the number of columns of R (resp. L). In other words, the pairs of matrices appearing in a Δ_{\prec} -coproduct (resp. Δ_{\succ} -coproduct) in the fundamental basis are the pairs (L, R) of packed matrices such that the last row of L (resp. R) comes from the last row of M . For example,

$$(2.3.14) \quad \Delta_{\prec} \mathbf{F} \begin{bmatrix} 1 & 0 & 0 & 0 & 0 & 0 \\ 0 & 1 & 1 & 0 & 0 & 0 \\ 0 & 0 & 0 & 0 & 0 & 1 \\ 0 & 0 & 0 & 1 & 0 & 0 \\ 0 & 0 & 0 & 1 & 1 & 0 \\ 0 & 0 & 1 & 0 & 0 & 0 \end{bmatrix} = \mathbf{F} \begin{bmatrix} 1 & 0 & 0 \\ 0 & 1 & 1 \\ 0 & 0 & 1 \end{bmatrix} \otimes \mathbf{F} \begin{bmatrix} 0 & 0 & 1 \\ 1 & 0 & 0 \\ 1 & 1 & 0 \end{bmatrix} + \mathbf{F} \begin{bmatrix} 1 & 0 & 0 & 0 & 0 \\ 0 & 1 & 1 & 0 & 0 \\ 0 & 0 & 0 & 1 & 0 \\ 0 & 0 & 0 & 1 & 1 \\ 0 & 0 & 1 & 0 & 0 \end{bmatrix} \otimes \mathbf{F}_{[1]},$$

$$(2.3.15) \quad \Delta_{\succ} \mathbf{F} \begin{bmatrix} 1 & 0 & 0 & 0 & 0 & 0 \\ 0 & 1 & 1 & 0 & 0 & 0 \\ 0 & 0 & 0 & 0 & 0 & 1 \\ 0 & 0 & 0 & 1 & 0 & 0 \\ 0 & 0 & 0 & 1 & 1 & 0 \\ 0 & 0 & 1 & 0 & 0 & 0 \end{bmatrix} = \mathbf{F}_{[1]} \otimes \mathbf{F} \begin{bmatrix} 1 & 1 & 0 & 0 & 0 \\ 0 & 0 & 0 & 0 & 1 \\ 0 & 0 & 1 & 0 & 0 \\ 0 & 0 & 1 & 1 & 0 \\ 0 & 1 & 0 & 0 & 0 \end{bmatrix}.$$

Since by Lemma 1.1, one cannot vertically split a packed matrix by separating two nonzero entries on a same row, for any nonempty packed matrix M , one has

$$(2.3.16) \quad \Delta(\mathbf{F}_M) = 1 \otimes \mathbf{F}_M + \Delta_{\prec}(\mathbf{F}_M) + \Delta_{\succ}(\mathbf{F}_M) + \mathbf{F}_M \otimes 1.$$

Proposition 2.8. *The Hopf algebra \mathbf{PM}_k admits a codendriform coalgebra structure for the coproducts Δ_{\prec} and Δ_{\succ} .*

Since the proof of this statement is similar to that of Proposition 2.7 it has been omitted.

2.3.3. Bidendriform bialgebra structure. A bialgebra $(\mathcal{B}, \cdot, \Delta)$ admits a *bidendriform bialgebra structure* [Foi07] if \mathcal{B} admits both a dendriform algebra $(\mathcal{B}, \prec, \succ)$ and a codendriform coalgebra $(\mathcal{B}, \Delta_{\prec}, \Delta_{\succ})$ structure with some extra compatibility relations between (\prec, \succ) and $(\Delta_{\prec}, \Delta_{\succ})$.

Theorem 2.9. *The Hopf algebra \mathbf{PM}_k admits a bidendriform bialgebra structure for the products \prec, \succ and the coproducts $\Delta_{\prec}, \Delta_{\succ}$.*

Proof. By Propositions 2.7 and 2.8, \mathbf{PM}_k admits a dendriform algebra and a codendriform coalgebra structure.

The required extra compatibility relations (see [Foi07]) between (\prec, \succ) and $(\Delta_{\prec}, \Delta_{\succ})$ are established by arguments similar to the ones used in the proofs of Propositions 2.7 and 2.8. \square

Theorem 2.9 also implies that \mathbf{PMN}_k and \mathbf{PML}_k admit a bidendriform bialgebra structure. Recall that an element x of a Hopf algebra admitting a bidendriform bialgebra structure is *totally primitive* if $\Delta_{\leftarrow}(x) = 0 = \Delta_{\rightarrow}(x)$. Following [Foi07], the generating series $\mathcal{T}_{k,n}(t)$ and $\mathcal{T}_{k,\ell}(t)$ of totally primitive elements of \mathbf{PMN}_k and \mathbf{PML}_k satisfy respectively

$$(2.3.17) \quad \mathcal{T}_{k,n}(t) = \frac{\mathcal{H}_{k,n}(t) - 1}{\mathcal{H}_{k,n}(t)^2} \quad \text{and} \quad \mathcal{T}_{k,\ell}(t) = \frac{\mathcal{H}_{k,\ell}(t) - 1}{\mathcal{H}_{k,\ell}(t)^2}.$$

The first few dimensions of totally primitive elements of \mathbf{PMN}_1 and \mathbf{PMN}_2 are respectively

$$(2.3.18) \quad 0, 1, 5, 240, 40404, 24827208, 57266105928$$

and

$$(2.3.19) \quad 0, 2, 48, 15640, 39023776, 813415850016, 147655768992433664.$$

The first few dimensions of totally primitive elements of \mathbf{PML}_1 and \mathbf{PML}_2 are respectively

$$(2.3.20) \quad 0, 1, 0, 5, 36, 381, 4720, 67867, 1109434$$

and

$$(2.3.21) \quad 0, 2, 0, 40, 576, 12192, 302080, 8686976, 284015104.$$

3. RELATED HOPF ALGEBRAS

In this section, we list some already known Hopf algebras and describe their links with \mathbf{PM}_k . Next, we provide a method to construct Hopf subalgebras of \mathbf{PM}_k .

3.1. Links with known algebras.

3.1.1. *Hopf algebra of colored permutations.* Recall that a k -colored permutation is a pair (σ, c) where σ is a permutation of size n and c is a word of length n on the alphabet $A_k \setminus \{0\}$.

In [NT10], the authors endowed the vector spaces $\mathbf{FQSym}^{(k)}$ spanned by the set of all k -colored permutations with a Hopf algebra structure. The elements $\mathbf{F}_{(\sigma,c)}$, where the (σ, c) are k -colored permutations, form the fundamental basis of $\mathbf{FQSym}^{(k)}$. These Hopf algebras provide a generalization of \mathbf{FQSym} since $\mathbf{FQSym} = \mathbf{FQSym}^{(1)}$.

Proposition 3.1. *The map $\alpha_k : \mathbf{FQSym}^{(k)} \rightarrow \mathbf{PMN}_k$ linearly defined, for any k -colored permutation (σ, c) by*

$$(3.1.1) \quad \alpha_k(\mathbf{F}_{(\sigma,c)}) := \mathbf{F}_{M^{(\sigma,c)}}$$

where $M^{(\sigma,c)}$ is the k -packed matrix satisfying $M_{ij}^{(\sigma,c)} = c_j \delta_{i,\sigma_j}$ is an injective Hopf morphism.

In particular, Proposition 3.1 shows that \mathbf{PMN}_1 contains \mathbf{FQSym} . Notice that the map α_k is still well-defined on the codomain \mathbf{PML}_k instead of \mathbf{PMN}_k .

3.1.2. *Hopf algebra of uniform block permutations.* Recall that a *uniform block permutation*, or a *UBP* for short, of size n is a bijection $\pi : \pi^d \rightarrow \pi^c$ where π^d and π^c are set partitions of $[n]$, and, for any $e \in \pi^d$, e and $\pi(e)$ have same cardinality.

For instance, the map π defined by

$$(3.1.2) \quad \pi(\{1, 4, 5\}) := \{2, 5, 6\}, \quad \pi(\{2\}) := \{1\}, \quad \text{and} \quad \pi(\{3, 6\}) := \{3, 4\}$$

is a UBP of size 6.

In [AO08], the authors endowed the vector space \mathbf{UBP} spanned by the set of all UBPs with a Hopf algebra structure. The elements \mathbf{F}_π , where the π are UBPs, form the fundamental basis of \mathbf{UBP} . The dimensions of \mathbf{UBP} form Sequence [A023998](#) of [Slo] and the first few terms are

$$(3.1.3) \quad 1, 1, 3, 16, 131, 1496, 22482, 426833, 9934563, 277006192, 9085194458.$$

Proposition 3.2. *The map $\beta : \mathbf{UBP}^* \rightarrow \mathbf{PMN}_1$ linearly defined, for any UBP π by*

$$(3.1.4) \quad \beta(\mathbf{F}_\pi^*) := \mathbf{F}_{M^\pi}$$

where M^π is the 1-packed matrix satisfying

$$(3.1.5) \quad M_{ij}^\pi := \begin{cases} 1 & \text{if there is } e \in \pi^d \text{ such that } j \in e \text{ and } i \in \pi(e), \\ 0 & \text{otherwise.} \end{cases}$$

is an injective Hopf morphism.

For example, with the UBP π defined in (3.1.2), we have

$$(3.1.6) \quad \beta(\mathbf{F}_\pi^*) = \mathbf{F} \begin{bmatrix} 0 & 1 & 0 & 0 & 0 & 0 \\ 1 & 0 & 0 & 1 & 1 & 0 \\ 0 & 0 & 1 & 0 & 0 & 1 \\ 0 & 0 & 1 & 0 & 0 & 1 \\ 1 & 0 & 0 & 1 & 1 & 0 \\ 1 & 0 & 0 & 1 & 1 & 0 \end{bmatrix}.$$

Corollary 3.3. *The Hopf algebra \mathbf{UBP}^* is a free, cofree, and self-dual Hopf algebra which admits a bidendriform bialgebra structure.*

Proof. By Proposition 3.2 and the definition of the product on the fundamental basis of \mathbf{UBP}^* (see [AO08]), we can see \mathbf{UBP}^* as a Hopf subalgebra of \mathbf{PMN}_1 restricted on the elements \mathbf{F}_M where the M are 1-packed matrices such that there are UBPs π satisfying $M^\pi = M$. This shows that \mathbf{UBP}^* inherits from the bidendriform bialgebra structure of \mathbf{PMN}_1 (see Theorem 2.9). Now, since \mathbf{UBP}^* admits a bidendriform bialgebra structure, by [Foi07], it is free, cofree, and self-dual. \square

By using same arguments as those used in Section 2.1, one can build multiplicative bases of \mathbf{UBP}^* by setting, for any UBP π ,

$$(3.1.7) \quad \mathbf{E}_{M^\pi}^* := \sum_{M^\pi \leq_n M'} \mathbf{F}_{M'} \quad \text{and} \quad \mathbf{H}_{M^\pi}^* := \sum_{M^{\pi'} \leq_n M^\pi} \mathbf{F}_{M^{\pi'}}.$$

This gives another way to prove the freeness of \mathbf{UBP}^* by using same arguments as those of Theorem 2.4. Hence, \mathbf{UBP}^* is freely generated by the elements $\mathbf{E}_{M^\pi}^*$ (resp. $\mathbf{H}_{M^\pi}^*$) where the π are UBPs such that the M^π are connected (resp. anti-connected) 1-packed matrices. The first few numbers of algebraic generators of \mathbf{UBP}^* are

$$(3.1.8) \quad 0, 1, 2, 11, 98, 1202, 19052, 375692, 8981392, 255253291, 8488918198$$

and the first few dimensions of totally primitive elements are

$$(3.1.9) \quad 0, 1, 1, 7, 72, 962, 16135, 330624, 8117752, 235133003, 7929041828.$$

Moreover, since for any UBP π , there exists a UBP π^{-1} such that the transpose of M^π is $M^{\pi^{-1}}$, by Proposition 2.5, the map $\phi : \mathbf{UBP}^* \rightarrow \mathbf{UBP}$ linearly defined for any UBP π by

$$(3.1.10) \quad \phi(\mathbf{F}_{M^\pi}^*) := \mathbf{F}_{M^{\pi^{-1}}}$$

is an isomorphism.

3.1.3. Algebra of matrix quasi-symmetric functions. In [DHT02] (see also [Hiv99]), the authors defined the vector space \mathbf{MQSym} spanned by the set of the (not necessarily square) matrices with entries in \mathbb{N} , and such that each row and each column contains at least one nonzero entry. In this section, we simply call *matrices* such sort of matrices. The elements \mathbf{MS}_M such that M is a matrix form the *quasi-multiword basis* of \mathbf{MQSym} . The degree of a \mathbf{MS}_M is given by the sum of the entries of M .

This vector space is endowed with an algebra structure where the product of two basis elements is provided by the *augmented shuffle* \sqcup . Let M_1 and M_2 be two matrices. Any matrix M of $M_1 \sqcup M_2$ is obtained by concatenating N_1 and N_2 where N_1 (resp. N_2) is obtained from M_1 (resp. M_2) by inserting some null rows and so that N_1 and N_2 have both a same number of rows and each row of M has at least one nonzero entry. For example,

$$(3.1.11) \quad \mathbf{MS}_{\begin{bmatrix} 2 & 1 \\ 0 & 1 \end{bmatrix}} \cdot \mathbf{MS}_{\begin{bmatrix} 1 & 3 \end{bmatrix}} = \mathbf{MS}_{\begin{bmatrix} 2 & 1 & 0 & 0 \\ 0 & 1 & 0 & 0 \\ 0 & 0 & 1 & 3 \end{bmatrix}} + \mathbf{MS}_{\begin{bmatrix} 2 & 1 & 0 & 0 \\ 0 & 1 & 1 & 3 \end{bmatrix}} + \mathbf{MS}_{\begin{bmatrix} 2 & 1 & 0 & 0 \\ 0 & 0 & 1 & 3 \\ 0 & 1 & 0 & 0 \end{bmatrix}} + \mathbf{MS}_{\begin{bmatrix} 2 & 1 & 1 & 3 \\ 0 & 1 & 0 & 0 \end{bmatrix}} + \mathbf{MS}_{\begin{bmatrix} 0 & 0 & 1 & 3 \\ 2 & 1 & 0 & 0 \\ 0 & 1 & 0 & 0 \end{bmatrix}}.$$

Let us endow the set of matrices indexing \mathbf{MQSym} with a binary relation \rightarrow defined in the following way. If M_1 and M_2 are two matrices such that M_1 has n rows and m columns, we have $M_1 \rightarrow M_2$ if there is an index $i \in [n-1]$ such that, denoting by s the number of 0 which end the i th row of M_1 , and by p the number of 0 which start the $(i+1)$ st row of M_1 , one has $s+p \geq m$ and M_2 is obtained from M_1 by overlaying its i th and $(i+1)$ st rows (see Figure 3).

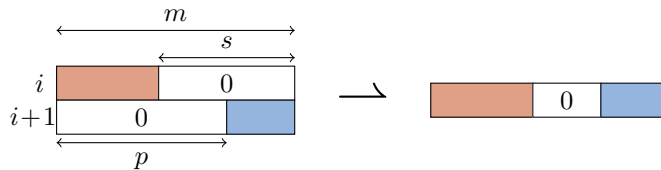

FIGURE 3. The condition for overlaying the i th and $(i+1)$ st rows of a (not necessarily square) packed matrix according to the relation \rightarrow . The darker regions contain any entries and the white ones, only zeros.

We now endow the set of matrices that index \mathbf{MQSym} with the partial order relation $\leq_{\mathbf{MQ}}$ defined as the reflexive and transitive closure of \rightarrow . Figure 4 shows an interval of this partial order.

Lemma 3.4. *Let A and B be two k -packed matrices. Then,*

$$(3.1.12) \quad \{C' : C \leq_{\mathbf{MQ}} C', C \in A * B\} = \{C' \in A' \sqcup B' : A \leq_{\mathbf{MQ}} A', B \leq_{\mathbf{MQ}} B'\},$$

where $*$ is the row shifted shuffle of k -packed matrices and \sqcup is the augmented shuffle of matrices.

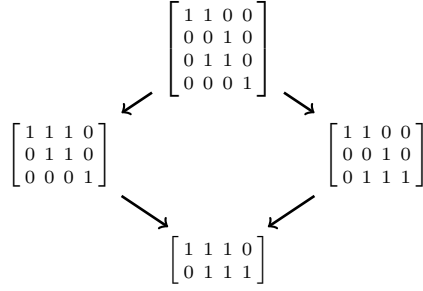

FIGURE 4. The Hasse diagram of an interval for the order \leq_{MQ} on (not necessarily square) packed matrices.

Proof. Let C' be a matrix such that $C \leq_{\text{MQ}} C'$ and $C \in A * B$. By definition of the order \leq_{MQ} and the product $*$, C' can be obtained from C by overlaying rows coming from A , rows coming from B , or rows coming from A and B . Let us denote by A' (resp. B') the matrix obtained from A (resp. B) by overlaying some of its rows. Then, we have $A \leq_{\text{MQ}} A'$ and $B \leq_{\text{MQ}} B'$, and, by definition of the augmented shuffle, $C' \in A' \sqcup B'$.

Conversely, let $C' \in A' \sqcup B'$ where A' and B' are matrices satisfying $A \leq_{\text{MQ}} A'$ and $B \leq_{\text{MQ}} B'$. Then, by definition of the augmented shuffle of matrices, C' can be obtained from a matrix C of $A * B$ by overlaying rows coming from A , rows coming from B , or rows coming from A and B . Hence, $C \leq_{\text{MQ}} C'$. \square

Proposition 3.5. *The map $\gamma : \text{PML}_1^* \rightarrow \text{MQSym}$ linearly defined, for any 1-packed matrix M by*

$$(3.1.13) \quad \gamma(\mathbf{F}_M^*) := \sum_{M \leq_{\text{MQ}} M'} \text{MS}_{M'},$$

is an injective algebra morphism.

Proof. Let M_1 and M_2 be two 1-packed matrices. By definition of γ , $\gamma(\mathbf{F}_{M_1}^* \cdot \mathbf{F}_{M_2}^*)$ is multiplicity-free over the quasi-multiword basis of MQSym . Moreover, since the augmented shuffle is multiplicity-free, $\gamma(\mathbf{F}_{M_1}^*) \cdot \gamma(\mathbf{F}_{M_2}^*)$ also is. Lemma 3.4 implies that these two elements are equal and then, that γ is an algebra morphism. The injectivity of γ follows by triangularity. \square

For instance, one has

$$(3.1.14) \quad \gamma \mathbf{F}^* \begin{bmatrix} 1 & 1 & 0 & 0 \\ 0 & 0 & 1 & 0 \\ 0 & 1 & 1 & 0 \\ 0 & 0 & 0 & 1 \end{bmatrix} = \text{MS} \begin{bmatrix} 1 & 1 & 0 & 0 \\ 0 & 0 & 1 & 0 \\ 0 & 1 & 1 & 0 \\ 0 & 0 & 0 & 1 \end{bmatrix} + \text{MS} \begin{bmatrix} 1 & 1 & 1 & 0 \\ 0 & 1 & 1 & 0 \\ 0 & 0 & 0 & 1 \end{bmatrix} + \text{MS} \begin{bmatrix} 1 & 1 & 0 & 0 \\ 0 & 0 & 1 & 0 \\ 0 & 1 & 1 & 1 \end{bmatrix} + \text{MS} \begin{bmatrix} 1 & 1 & 1 & 0 \\ 0 & 1 & 1 & 1 \end{bmatrix}.$$

Notice that γ is not a Hopf morphism since it is not a coalgebra morphism. Indeed, we have

$$(3.1.15) \quad \Delta \gamma \mathbf{F}^* \begin{bmatrix} 1 & 1 \\ 1 & 0 \end{bmatrix} = 1 \otimes \text{MS} \begin{bmatrix} 1 & 1 \\ 1 & 0 \end{bmatrix} + \text{MS} \begin{bmatrix} 1 & 1 \\ 1 & 0 \end{bmatrix} \otimes 1,$$

but

$$(3.1.16) \quad (\gamma \otimes \gamma) \Delta \mathbf{F}^* \begin{bmatrix} 1 & 1 \\ 1 & 0 \end{bmatrix} = 1 \otimes \text{MS} \begin{bmatrix} 1 & 1 \\ 1 & 0 \end{bmatrix} + \text{MS} \begin{bmatrix} 1 & 1 \\ 1 & 1 \end{bmatrix} \otimes \text{MS} \begin{bmatrix} 1 & 1 \\ 1 & 1 \end{bmatrix} + \text{MS} \begin{bmatrix} 1 & 1 \\ 1 & 0 \end{bmatrix} \otimes 1.$$

3.1.4. *Diagram of embeddings.* The following diagram summarizes the relations between known Hopf algebras related to \mathbf{PM}_k and, more specifically, to its simple gradations \mathbf{PMN}_k and \mathbf{PML}_k . Plain arrows are Hopf algebra morphisms and the dotted arrow is an algebra morphism. The Hopf algebra \mathbf{ASM} is the subject of Section 4.

(3.1.17)

3.2. **Equivalence relations and Hopf subalgebras.** Several Hopf algebras can be constructed as Hopf subalgebras of the Malvenuto-Reutenauer Hopf algebra \mathbf{FQSym} [MR95, DHT02]. The main examples are the Hopf algebra \mathbf{PBT} based on planar binary trees, first defined by Loday and Ronco [LR98] and reconstructed by Hivert, Novelli, and Thibon [HNT05], and \mathbf{FSym} based on standard Young tableaux, first discovered by Poirier and Reutenauer [PR95] and reconstructed by Duchamp, Hivert, and Thibon [DHT02].

The starting point of these constructions is to define a congruence \equiv on the free monoid A^* where A is a totally ordered infinite alphabet. Then, when \equiv satisfies some properties [HN07, Gir11], the elements

$$(3.2.1) \quad \mathbf{P}_{[\sigma]_{\equiv}} := \sum_{\sigma \in [\sigma]_{\equiv}} \mathbf{F}_{\sigma}$$

span a Hopf subalgebra of \mathbf{FQSym} indexed by the \equiv -equivalence classes restricted to permutations. We shall show in this section that an analogous construction works to construct Hopf subalgebras of \mathbf{PM}_k .

3.2.1. *The sylvester and the plactic congruences.* Recall that the congruence allowing to reconstruct \mathbf{PBT} is the *sylvester congruence* (see [HNT02, HNT05]). It is denoted by \equiv_S and is the reflexive and transitive closure of the sylvester adjacency relation \longleftrightarrow_S defined for $u \in A^*$ and $a, b, c \in A$ by

$$(3.2.2) \quad acub \longleftrightarrow_S caub \quad \text{where } a \leq b < c.$$

For example, the \equiv_S -equivalence class of the permutation 15423 (see Figure 5) is

$$(3.2.3) \quad \{12543, 15243, 15423, 51243, 51423, 54123\}.$$

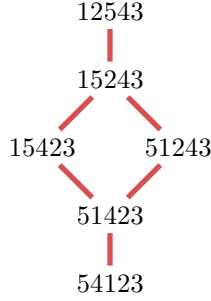

FIGURE 5. The sylvester equivalence class of the permutation 15423. Edges represent sylvester adjacency relations.

Besides, recall that the congruence allowing to reconstruct **FSym** is the *plactic congruence* (see [LS81, Lot02]). It is denoted by \equiv_P and is the reflexive and transitive closure of the plactic adjacency relation \longleftrightarrow_P defined for $a, b, c \in A$ by

$$(3.2.4a) \quad acb \longleftrightarrow_P cab \quad \text{where } a \leq b < c,$$

$$(3.2.4b) \quad bac \longleftrightarrow_P bca \quad \text{where } a < b \leq c.$$

3.2.2. *The monoid of words of columns.* Let C_k^* be the free monoid generated by the set C_k of all $n \times 1$ -matrices with entries in A_k , for all $n \geq 1$. In other words, the elements of C_k^* are words whose letters are columns and its product \bullet is the concatenation of such words. When all the letters of an element $M \in C_k^*$ have, as columns, a same number of rows, M is a matrix and we shall denote it as such in the sequel.

The alphabet C_k is naturally equipped with the total order \leq where, for any $c_1, c_2 \in C_k$, $c_1 \leq c_2$ if and only if the bottom to top reading of the column c_1 is lexicographically smaller than the bottom to top reading of c_2 . For instance,

$$(3.2.5) \quad \begin{bmatrix} 1 \\ 0 \\ 0 \end{bmatrix} \leq \begin{bmatrix} 0 \\ 0 \\ 1 \end{bmatrix}, \quad \begin{bmatrix} 0 \\ 0 \\ 1 \\ 0 \\ 1 \end{bmatrix} \leq \begin{bmatrix} 0 \\ 0 \\ 1 \\ 1 \\ 1 \end{bmatrix}, \quad \begin{bmatrix} 1 \\ 0 \end{bmatrix} \leq \begin{bmatrix} 0 \\ 1 \\ 1 \\ 0 \end{bmatrix}, \quad \begin{bmatrix} 2 \\ 1 \\ 0 \end{bmatrix} \leq \begin{bmatrix} 1 \\ 2 \\ 0 \end{bmatrix}.$$

Since C_k is then totally ordered and C_k^* is a free monoid, one can consider the previous two congruences on C_k^* instead on A^* . For instance, Figure 6 represents a \equiv_S -equivalence class and a \equiv_P -equivalence class of packed matrices.

The order relation \leq on C_k is compatible with the shifted shuffle of packed matrices in the following sense. Let M_1 and M_2 be two nonempty packed matrices and M be a matrix appearing in $M_1 \sqcup M_2$. Then, if c_1 (resp. c_2) is a column of M coming from M_1 (resp. M_2), we necessarily have $c_1 \leq c_2$ and $c_1 \neq c_2$. The obvious analogous property holds for words of A^* and the shifted shuffle of words.

3.2.3. *Properties of equivalence relations.* An equivalence relation \equiv on C_k^* is a *monoid congruence* if for all $u, v, u', v' \in C_k^*$,

$$(3.2.6) \quad u \equiv u' \quad \text{and} \quad v \equiv v' \quad \text{imply} \quad u \bullet v \equiv u' \bullet v'.$$

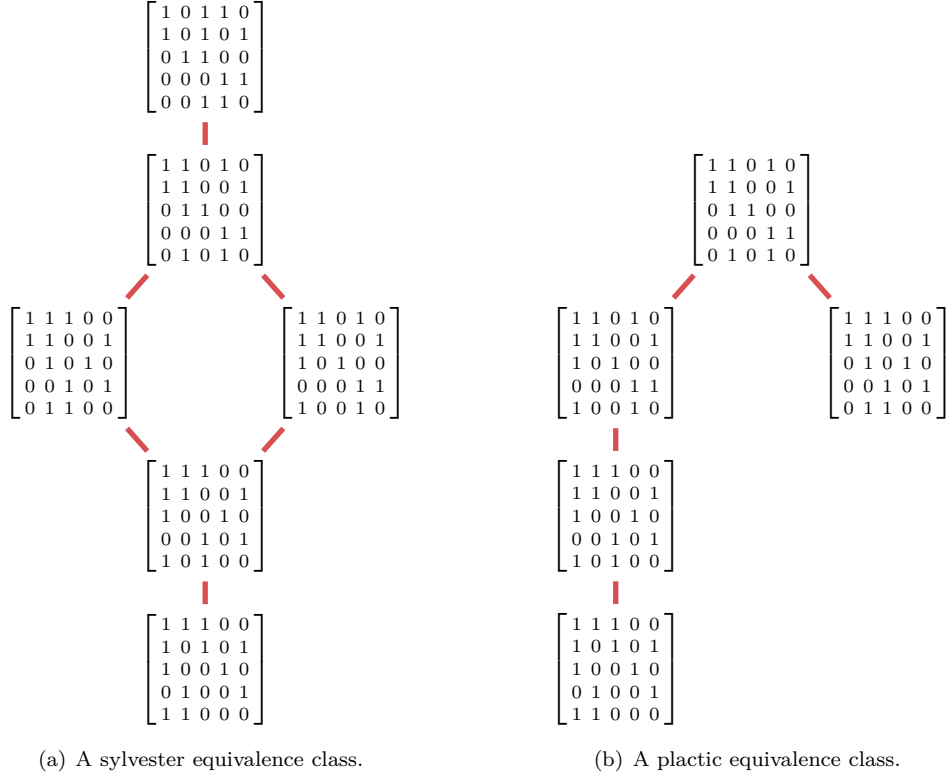

FIGURE 6. Two equivalence classes of packed matrices.

Besides, we say that \equiv is *compatible with the restriction to alphabet intervals* if for any interval I of C_k and for all $u, v \in C_k^*$,

$$(3.2.7) \quad u \equiv v \quad \text{implies} \quad u|_I \equiv v|_I,$$

where $u|_I$ denotes the word obtained by erasing in u the letters that are not in I .

Finally, we say that \equiv is *compatible with the decompression process* if for all $u, v \in C_k^*$ such that u and v are matrices,

$$(3.2.8) \quad u \equiv v \quad \text{if and only if} \quad \text{cp}(u) \equiv \text{cp}(v) \quad \text{and} \quad \text{ev}(u) = \text{ev}(v),$$

where $\text{ev}(u)$ denotes the commutative image of u .

3.2.4. Construction of Hopf subalgebras. Given an equivalence relation \equiv on the words of C_k^* and a \equiv -equivalence class $[M]_{\equiv}$ of packed matrices of C_k^* , we consider the elements

$$(3.2.9) \quad \mathbf{P}_{[M]_{\equiv}} := \sum_{M' \in [M]_{\equiv}} \mathbf{F}_{M'}$$

of \mathbf{PM}_k .

One has for instance

$$(3.2.10) \quad \mathbf{P} \left[\begin{bmatrix} 1 1 0 1 0 \\ 1 1 0 0 1 \\ 0 1 1 0 0 \\ 0 0 0 1 1 \\ 0 1 0 1 0 \end{bmatrix} \right]_{\equiv_{\mathbf{P}}} = \mathbf{F} \begin{bmatrix} 1 1 0 1 0 \\ 1 1 0 0 1 \\ 0 1 1 0 0 \\ 0 0 0 1 1 \\ 0 1 0 1 0 \end{bmatrix} + \mathbf{F} \begin{bmatrix} 1 1 0 1 0 \\ 1 1 0 0 1 \\ 1 0 1 0 0 \\ 0 0 0 1 1 \\ 1 0 0 1 0 \end{bmatrix} + \mathbf{F} \begin{bmatrix} 1 1 1 0 0 \\ 1 1 0 0 1 \\ 0 1 0 1 0 \\ 0 0 1 0 1 \\ 0 1 1 0 0 \end{bmatrix} + \mathbf{F} \begin{bmatrix} 1 1 1 0 0 \\ 1 1 0 0 1 \\ 1 0 0 1 0 \\ 0 0 1 0 1 \\ 1 0 1 0 0 \end{bmatrix} + \mathbf{F} \begin{bmatrix} 1 1 1 0 0 \\ 1 0 1 0 1 \\ 1 0 0 1 0 \\ 0 1 0 0 1 \\ 1 1 0 0 0 \end{bmatrix}.$$

In particular, if \equiv is compatible with the decompression process, any \equiv -equivalence class of a packed matrix only contains packed matrices. The family $\mathbf{P}_{[M]_{\equiv}}$, where the $[M]_{\equiv}$ are \equiv -equivalence classes of packed matrices, forms then a basis of a vector subspace of \mathbf{PM}_k denoted by \mathbf{PM}_k^{\equiv} .

Theorem 3.6. *Let \equiv be an equivalence relation on the words of C_k^* such that \equiv*

- (1) *is a monoid congruence on C_k^* ;*
- (2) *is compatible with the restriction to alphabet intervals;*
- (3) *is compatible with the decompression process.*

Then, \mathbf{PM}_k^{\equiv} is a Hopf subalgebra of \mathbf{PM}_k .

Proof. Let us show that the product is well-defined on \mathbf{PM}_k^{\equiv} . Let $[M_1]_{\equiv}$ and $[M_2]_{\equiv}$ be two \equiv -equivalence classes of k -packed matrices. We have

$$(3.2.11) \quad \mathbf{P}_{[M_1]_{\equiv}} \cdot \mathbf{P}_{[M_2]_{\equiv}} = \sum_{\substack{M_1 \in [M_1]_{\equiv} \\ M_2 \in [M_2]_{\equiv}}} \sum_{M \in M_1 \sqcup M_2} \mathbf{F}_M.$$

Let M be a k -packed matrix such that \mathbf{F}_M appears in (3.2.11) and M' be a k -packed matrix such that $M' \equiv M$. Then, there is a pair of k -packed matrices (M_1, M_2) such that $M_1 \in [M_1]_{\equiv}$, $M_2 \in [M_2]_{\equiv}$, and $M \in M_1 \sqcup M_2$. By definition of the shifted shuffle, this pair is unique. Let m_1 (resp. m_2) be the size of M_1 (resp. M_2). Let c_1 (resp. d_1) be the smallest (resp. greatest) column of $M_1 \circ m_2$ and c_2 (resp. d_2) be the smallest (resp. greatest) column of $m_1 \circ M_2$. Then, since all columns of $M_1 \circ m_2$ are strictly smaller than the ones of $m_1 \circ M_2$, the intervals $[c_1, d_1]$ and $[c_2, d_2]$ are disjoint. By (2), $M \equiv M'$ implies $M_{|[c_1, d_1]} \equiv M'_{|[c_1, d_1]}$ and $M_{|[c_2, d_2]} \equiv M'_{|[c_2, d_2]}$. Moreover, by (3) and by definition of \circ , we have

$$(3.2.12) \quad M_1 = \text{cp}(M_{|[c_1, d_1]}) \equiv \text{cp}(M'_{|[c_1, d_1]}) =: M'_1$$

and

$$(3.2.13) \quad M_2 = \text{cp}(M_{|[c_2, d_2]}) \equiv \text{cp}(M'_{|[c_2, d_2]}) =: M'_2.$$

Thus, we have $M' \in M'_1 \sqcup M'_2$, showing that $\mathbf{F}_{M'}$ also appears in (3.2.11) and that the product is well-defined on \mathbf{PM}_k^{\equiv} .

Let us now show that the coproduct is well-defined on \mathbf{PM}_k^{\equiv} . Let $[M]_{\equiv}$ be a \equiv -equivalence class of k -packed matrices. We have

$$(3.2.14) \quad \Delta(\mathbf{P}_{[M]_{\equiv}}) = \sum_{M \in [M]_{\equiv}} \sum_{M=L \bullet R} \mathbf{F}_{\text{cp}(L)} \otimes \mathbf{F}_{\text{cp}(R)}.$$

Let M_1 and M_2 be two k -packed matrices such that $\mathbf{F}_{M_1} \otimes \mathbf{F}_{M_2}$ appears in (3.2.14) and M'_1 and M'_2 two k -packed matrices such that $M'_1 \equiv M_1$ and $M'_2 \equiv M_2$. Then, there is a k -packed matrix $M \in [M]_{\equiv}$ such that $M = L \bullet R$, $\text{cp}(L) = M_1$, and $\text{cp}(R) = M_2$. By (3), M'_1 (resp. M'_2) is a permutation of M_1 (resp. M_2). Thus, there exist two elements L' and R' of C_k^* that are respectively permutations of L and R which satisfy $\text{cp}(L') = M'_1$ and $\text{cp}(R') = M'_2$. Again by (3), we have $L' \equiv L$ and $R' \equiv R$. Now, by (1),

$$(3.2.15) \quad M = L \bullet R \equiv L' \bullet R' =: M'.$$

Hence, $M' \equiv M$ and $\mathbf{F}_{M'_1} \otimes \mathbf{F}_{M'_2}$ also appears in (3.2.14).

We have shown that the product and the coproduct of \mathbf{PM}_k are still well-defined on \mathbf{PM}_k^{\equiv} . Hence, \mathbf{PM}_k^{\equiv} is a Hopf subalgebra of \mathbf{PM}_k . \square

We say that an equivalence relation \equiv on C_k^* is a *good congruence* if it satisfies (1), (2) and (3) of Theorem 3.6. Let \equiv be a good congruence. Note that since \equiv is compatible with the decompression process, any matrix contained in a \equiv -equivalence class $[M]_{\equiv}$ is obtained by switching columns of M . Then, any \equiv -equivalence class $[M]_{\equiv}$ of k -packed matrices only contains matrices whose size and number of nonzero entries are the same as in M . Hence, Theorem 3.6 also implies that the family (3.2.9) forms a basis of Hopf subalgebras of both \mathbf{PMN}_k and \mathbf{PML}_k . We respectively denote these by \mathbf{PMN}_k^{\equiv} and \mathbf{PML}_k^{\equiv} .

3.2.5. *Computer experiments.* Let us recall here the definitions of some well-known good congruences.

The *Baxter congruence* (see [Gir12]), denoted by \equiv_{Bx} , is the reflexive and transitive closure of the Baxter adjacency relation $\longleftrightarrow_{\text{Bx}}$ defined for $u, v \in A^*$ and $\mathbf{a}, \mathbf{b}, \mathbf{c}, \mathbf{d} \in A$ by

$$(3.2.16a) \quad \mathbf{c} u \mathbf{a} \mathbf{d} v \mathbf{b} \longleftrightarrow_{\text{Bx}} \mathbf{c} u \mathbf{d} \mathbf{a} v \mathbf{b} \quad \text{where } \mathbf{a} \leq \mathbf{b} < \mathbf{c} \leq \mathbf{d},$$

$$(3.2.16b) \quad \mathbf{b} u \mathbf{d} \mathbf{a} v \mathbf{c} \longleftrightarrow_{\text{Bx}} \mathbf{b} u \mathbf{a} \mathbf{d} v \mathbf{c} \quad \text{where } \mathbf{a} < \mathbf{b} \leq \mathbf{c} < \mathbf{d}.$$

The *Bell congruence* (see [Rey07]), denoted by \equiv_{B1} , is the reflexive and transitive closure of the Bell adjacency relation $\longleftrightarrow_{\text{B1}}$ defined for $u \in A^*$ and $\mathbf{a}, \mathbf{b}, \mathbf{c} \in A$ by

$$(3.2.17) \quad \mathbf{a} \mathbf{c} u \mathbf{b} \longleftrightarrow_{\text{B1}} \mathbf{c} \mathbf{a} u \mathbf{b} \quad \text{where } \mathbf{a} \leq \mathbf{b} < \mathbf{c} \text{ and for all } \mathbf{d} \in u, \mathbf{d} \geq \mathbf{c}.$$

The *hypoplactic congruence* (see [KT97, KT99]), denoted by \equiv_{H} , is the reflexive and transitive closure of the hypoplactic adjacency relation $\longleftrightarrow_{\text{H}}$ defined for $u \in A^*$ and $\mathbf{a}, \mathbf{b}, \mathbf{c} \in A$ by

$$(3.2.18a) \quad \mathbf{a} \mathbf{c} u \mathbf{b} \longleftrightarrow_{\text{H}} \mathbf{c} \mathbf{a} u \mathbf{b} \quad \text{where } \mathbf{a} \leq \mathbf{b} < \mathbf{c},$$

$$(3.2.18b) \quad \mathbf{b} u \mathbf{c} \mathbf{a} \longleftrightarrow_{\text{H}} \mathbf{b} u \mathbf{a} \mathbf{c} \quad \text{where } \mathbf{a} < \mathbf{b} \leq \mathbf{c}.$$

The *total congruence* equivalence relation, denoted by \equiv_{T} , is the reflexive and transitive closure of the total adjacency relation $\longleftrightarrow_{\text{T}}$ defined by $u \equiv_{\text{T}} v$ for any $u, v \in A^*$ such that $\text{ev}(u) = \text{ev}(v)$.

By Theorem 3.6, all these congruences lead to bigraded Hopf subalgebras of \mathbf{PM}_k . Table 2 shows first few dimensions of the Hopf subalgebras of \mathbf{PMN}_1 and \mathbf{PML}_1 obtained from these congruences, computed by computer exploration.

4. ALTERNATING SIGN MATRICES

Recall that an *alternating sign matrix* [MRR83], or an *ASM* for short, of size n is a square matrix of order n with entries in the alphabet $\{0, +, -\}$ such that every row and column starts and ends by $+$ and in every row and column, the $+$ and the $-$ alternate. For instance,

$$(4.0.19) \quad \delta := \begin{bmatrix} 0 & + & 0 & 0 & 0 \\ 0 & 0 & + & 0 & 0 \\ + & - & 0 & 0 & + \\ 0 & + & - & + & 0 \\ 0 & 0 & + & 0 & 0 \end{bmatrix}$$

is an ASM of size 5.

Hopf algebra	First dimensions								
$\mathbf{PMN}_1^{\equiv \text{Bx}}$	1	1	7	265	38051				
$\mathbf{PMN}_1^{\equiv \text{Bl}}$	1	1	7	221	25789				
$\mathbf{PMN}_1^{\equiv \text{S}}$	1	1	7	221	24243				
$\mathbf{PMN}_1^{\equiv \text{P}}$	1	1	7	177	17339				
$\mathbf{PMN}_1^{\equiv \text{H}}$	1	1	7	177	13887				
$\mathbf{PMN}_1^{\equiv \text{T}}$	1	1	4	57	2306				
$\mathbf{PML}_1^{\equiv \text{Bx}}$	1	1	2	10	68	578	5782	65745	
$\mathbf{PML}_1^{\equiv \text{Bl}}$	1	1	2	9	53	390	3389	33881	
$\mathbf{PML}_1^{\equiv \text{S}}$	1	1	2	9	52	364	2918	26138	
$\mathbf{PML}_1^{\equiv \text{P}}$	1	1	2	8	41	266	1976	16569	
$\mathbf{PML}_1^{\equiv \text{H}}$	1	1	2	8	39	220	1396	9716	
$\mathbf{PML}_1^{\equiv \text{T}}$	1	1	1	3	11	43	191	939	

TABLE 2. First few dimensions of the Hopf subalgebras \mathbf{PMN}_1^{\equiv} and \mathbf{PML}_1^{\equiv} , where \equiv is successively the Baxter, Bell, sylvester, plactic, hypoplactic, and total congruence.

4.1. **Hopf algebra structure.** Let δ be an ASM. We denote by M^δ the matrix satisfying

$$(4.1.1) \quad M_{ij}^\delta := \begin{cases} 1 & \text{if } \delta_{ij} \in \{+, -\}, \\ 0 & \text{otherwise.} \end{cases}$$

For instance, with the ASM δ defined above, we obtain

$$(4.1.2) \quad M^\delta = \begin{bmatrix} 0 & 1 & 0 & 0 & 0 \\ 0 & 0 & 1 & 0 & 0 \\ 1 & 1 & 0 & 0 & 1 \\ 0 & 1 & 1 & 1 & 0 \\ 0 & 0 & 1 & 0 & 0 \end{bmatrix}.$$

It is immediate that M^δ is a 1-packed matrix of the same size than δ . Besides, observe that since the $+$ and the $-$ alternate in an ASM, by starting from a 1-packed matrix M , there is at most one ASM δ such that $M^\delta = M$.

Let \mathbf{ASM} be the vector space spanned by the set of all ASMs. For any ASM δ , let us denote by \mathbf{F}_δ the element \mathbf{F}_{M^δ} . Due to the above observation, the family \mathbf{F}_δ , where δ are ASMs, spans \mathbf{ASM} . Moreover, since the map $\mathbf{F}_\delta \mapsto \mathbf{F}_{M^\delta}$ is an injective morphism from \mathbf{ASM} to \mathbf{PM}_1 , this family forms a basis.

The product and the coproduct of \mathbf{PM}_1 induce the product and the coproduct of \mathbf{ASM} . For example, we have

$$(4.1.3) \quad \mathbf{F} \begin{bmatrix} 0 & + & 0 \\ + & - & + \\ 0 & + & 0 \end{bmatrix} \cdot \mathbf{F}_{[+]} = \mathbf{F} \begin{bmatrix} 0 & + & 0 & 0 \\ + & - & + & 0 \\ 0 & + & 0 & 0 \\ 0 & 0 & 0 & + \end{bmatrix} + \mathbf{F} \begin{bmatrix} 0 & + & 0 & 0 \\ + & - & 0 & + \\ 0 & + & 0 & 0 \\ 0 & 0 & + & 0 \end{bmatrix} + \mathbf{F} \begin{bmatrix} 0 & 0 & + & 0 \\ + & 0 & - & + \\ 0 & 0 & + & 0 \\ 0 & + & 0 & 0 \end{bmatrix} + \mathbf{F} \begin{bmatrix} 0 & 0 & + & 0 \\ 0 & + & - & + \\ 0 & 0 & + & 0 \\ + & 0 & 0 & 0 \end{bmatrix},$$

and

$$(4.1.4) \quad \Delta \mathbf{F} \begin{bmatrix} 0 & + & 0 & 0 \\ 0 & 0 & 0 & + \\ + & - & + & 0 \\ 0 & + & 0 & 0 \end{bmatrix} = \mathbf{F}_\emptyset \otimes \mathbf{F} \begin{bmatrix} 0 & + & 0 & 0 \\ 0 & 0 & 0 & + \\ + & - & + & 0 \\ 0 & + & 0 & 0 \end{bmatrix} + \mathbf{F} \begin{bmatrix} 0 & + & 0 \\ + & - & + \\ 0 & + & 0 \end{bmatrix} \otimes \mathbf{F}_{[+]} + \mathbf{F} \begin{bmatrix} 0 & + & 0 & 0 \\ 0 & 0 & 0 & + \\ + & - & + & 0 \\ 0 & + & 0 & 0 \end{bmatrix} \otimes \mathbf{F}_\emptyset.$$

Theorem 4.1. *The vector space \mathbf{ASM} , endowed with the product and coproduct of \mathbf{PM}_1 , forms a free, cofree, and self-dual bigraded Hopf algebra which admits a bidendriform bialgebra structure.*

Proof. Let δ_1 and δ_2 be two ASMs of respective sizes n_1 and n_2 and let $M \in M^{\delta_1} \square M^{\delta_2}$. Let us denote by M_1 (resp. M_2) the matrix consisting in the first n_1 (resp. last n_2) rows of M . By construction, M_1 contains columns coming from δ_1 and some null columns. The relative order of columns of M^{δ_1} is the same as in M_1 , *i.e.*, the i th column of M^{δ_1} is the i th nonzero column of M_1 . Hence, the rows of M_1 start and end with $+$ and then $+$ and $-$ alternate. Similarly, the same property is satisfied in M_2 . Furthermore, the nonzero column of M_1 are followed by null columns of M_2 and the nonzero column of M_2 are preceded by null columns of M_1 . Hence, the columns of M start and end with $+$ and $+$ and $-$ alternate. Thus M is an ASM so that \mathbf{ASM} is stable for the product of \mathbf{PM}_1 .

Let δ be an ASM and $L \bullet R$ be a column decomposition of M^δ . By Lemma 1.1, a column decomposition never splits a matrix by separating two nonzero entries on a same row. Then, the nonzero rows of L and R start and end with $+$ and $+$ and $-$ alternate. Thus, $\text{cp}(L)$ and $\text{cp}(R)$ are ASMs and \mathbf{ASM} is stable for the coproduct of \mathbf{PM}_1 .

This shows that \mathbf{ASM} is a Hopf subalgebra of \mathbf{PM}_1 and also that \mathbf{ASM} inherits from the bidendriform bialgebra structure of \mathbf{PM}_1 (see Theorem 2.9). Finally, since \mathbf{ASM} admits a bidendriform bialgebra structure, by [Foi07], it is free, cofree, and self-dual. \square

From now, we shall see \mathbf{ASM} as a simply graded Hopf algebra so that the degree of any \mathbf{F}_δ , where δ is an ASM, is the size of δ . The dimensions of \mathbf{ASM} form Sequence [A005130](#) of [Slo] and the first few terms are

$$(4.1.5) \quad 1, 1, 2, 7, 42, 429, 7436, 218348, 10850216, 911835460, 129534272700.$$

By using same arguments as those used in Section 2.1, one can build multiplicative bases of \mathbf{ASM} by setting, for any ASM δ ,

$$(4.1.6) \quad \mathbf{E}_\delta := \sum_{M^\delta \leq_n M^{\delta'}} \mathbf{F}_{\delta'} \quad \text{and} \quad \mathbf{H}_\delta := \sum_{M^{\delta'} \leq_n M^\delta} \mathbf{F}_{\delta'}.$$

This gives another way to prove the freeness of \mathbf{ASM} by using same arguments as those of Theorem 2.4. Hence, \mathbf{ASM} is freely generated by the elements \mathbf{E}_δ (resp. \mathbf{H}_δ) where the δ are ASMs such that the M^δ are connected (resp. anti-connected) 1-packed matrices. The first few numbers of algebraic generators of \mathbf{ASM} are

$$(4.1.7) \quad 0, 1, 1, 4, 29, 343, 6536, 202890, 10403135, 889855638, 127697994191$$

and the first few dimensions of totally primitive elements are

$$(4.1.8) \quad 0, 1, 0, 2, 20, 277, 5776, 188900, 9980698, 868571406, 125895356788.$$

Moreover, since the transpose of an ASM is also an ASM, by Proposition 2.5, the map $\phi : \mathbf{ASM} \rightarrow \mathbf{ASM}^*$ linearly defined for any ASM δ by

$$(4.1.9) \quad \phi(\mathbf{F}_\delta) := \mathbf{F}_{\delta^T}^*$$

is an isomorphism.

4.2. Alternating sign matrices statistics. We recall here the definitions of some statistics on ASMs. Their description passes through six-vertex configurations and osculating paths, combinatorial objects in bijection with ASMs.

The statistics discussed in this article have been already exploited in the literature. For instance, in [EKLP92], the authors focused on these statistics to understand the relationship between domino tilings of Aztec diamonds and ASMs.

4.2.1. Six-vertex configurations. A *six-vertex configuration* (see for example [Bre99, Bax08] for further information and references) of size n is a $n \times n$ square grid with oriented edges so that each vertex has two incoming and two outgoing edges. There are six possible configurations for each vertex. We consider here the six-vertex model with *domain wall boundary conditions* [Kor82] *i.e.*, all horizontal (resp. vertical) edges on the boundary of this model are oriented inwardly (resp. outwardly) (see Figure 8(c)).

The bijection [Kup96] between ASMs of size n and six-vertex configurations of the same size consists in replacing each vertex configuration by 0, +, or - according to the rules described in Figure 7. Reciprocally, to recover a six-vertex model from an ASM δ , we first replace each nonzero

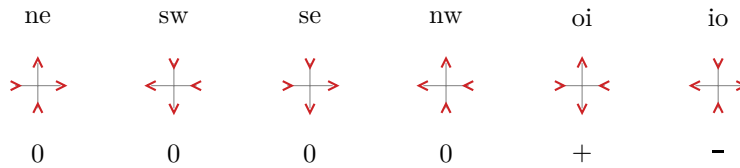

FIGURE 7. Correspondence between vertices of six-vertex configurations and entries of ASMs.

entry of δ by the corresponding vertex configuration (see the last two configurations of Figure 7). Then, for each zero entry of δ , we look at the sum ℓ (resp. a) of the entries to the left (resp. above) of it and in the same row (resp. column). By the alternating property of the ASMs, ℓ and a belong to $\{0, 1\}$. Now, set in δ the configuration \leftarrow (resp. \rightarrow) if $\ell = 1$ (resp. $\ell = 0$) together with the configuration \downarrow (resp. \uparrow) if $a = 1$ (resp. $a = 0$). Figures 8(a) and 8(c) form an example.

4.2.2. Statistics on six-vertex configurations and ASMs. Let us denote by $ne(\delta)$ (resp. $sw(\delta)$, $se(\delta)$, $nw(\delta)$, $oi(\delta)$, $io(\delta)$) the number of vertices ne (resp. sw , se , nw , oi , io) in the six-vertex configuration in bijection with the ASM δ . Let $\mathfrak{Z} := \{se, nw, sw, ne\}$ be the set of the statistics counting the four configurations of 0 and $\mathfrak{N} := \{io, oi\}$ be the set of the statistics counting the two nonzero configurations.

4.2.3. Sets of osculating paths. These statistics share some symmetries that are naturally interpreted on sets of osculating paths (see [BMH95, Beh08]). Let Π be a $n \times n$ square of lattice points with rows (resp. columns) labelled from 1 to n from top to bottom (resp. from left to right). A *lattice path* on Π is a sequence (v_0, v_1, \dots, v_r) of vertices of Π such that $v_i - v_{i-1} \in \{(1, 0), (0, -1)\}$ for all $i \in [r]$. A *set of osculating paths* on Π is a set of lattice paths on Π in which different paths do not cross each other but can share some vertices.

We can associate a set of osculating paths with any six-vertex configuration according to the rules described in Figure 9. Domain boundary conditions ensure that each path starts at $(i, 1)$ and ends at $(1, j)$ for some i and j . Figures 8(c) and 8(d) form an example.

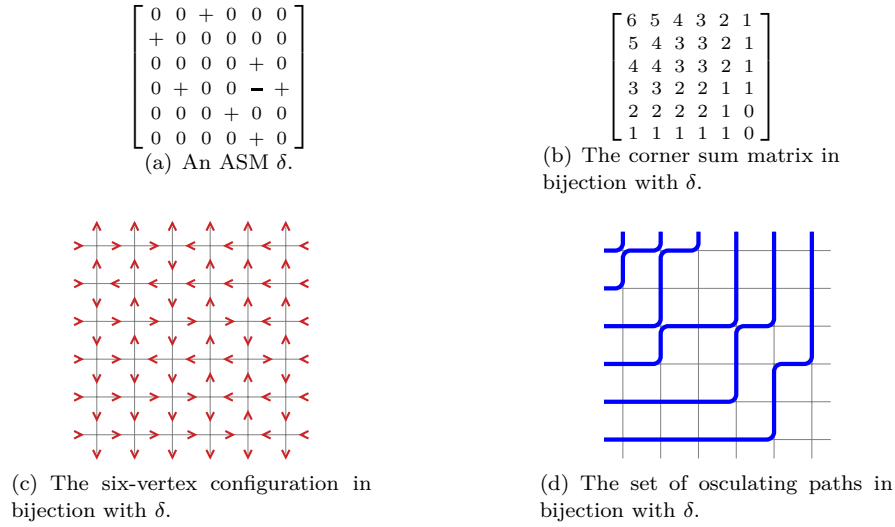

FIGURE 8. Four objects in correspondence: ASMs, six-vertex configurations, corner sum matrices, and sets of osculating paths.

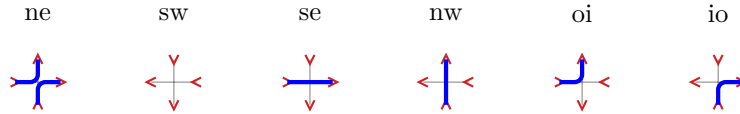

FIGURE 9. Correspondence between vertices of six-vertex configurations and osculating paths.

The direct interpretation of ASMs in terms of sets of osculating paths is directly based upon the corner sum matrix introduced in [RR86]: given an $n \times n$ matrix M , the *corner sum matrix* \bar{M} of M is defined by

$$(4.2.1) \quad \bar{M}_{i,j} := \sum_{\substack{i \leq k \leq n \\ j \leq \ell \leq n}} M_{k,\ell}.$$

Figures 8(a) and 8(b) form an example. We associate with any ASM δ of size n the set of osculating paths described as follows. By regarding $\bar{\delta}$ as a $(n + 1) \times (n + 1)$ square of lattice points, we draw on it the south and the east boundaries of the areas consisting in a same value greater than zero. This produces a set of n osculating paths. Figures 8(b) and 8(d) form an example. Since the steps of the paths in the first row (resp. column) are, by construction, always vertical (resp. horizontal), this set of osculating paths can be seen without loss of information on the $n \times n$ square of lattice points.

The different 2×2 submatrices configurations in a corner sum matrix of an ASM are exactly

$$(4.2.2) \quad \begin{array}{|c|c|} \hline 2+a & 1+a \\ \hline 1+a & a \\ \hline \end{array}, \quad \begin{array}{|c|c|} \hline a & a \\ \hline a & a \\ \hline \end{array}, \quad \begin{array}{|c|c|} \hline 1+a & 1+a \\ \hline a & a \\ \hline \end{array}, \quad \begin{array}{|c|c|} \hline 1+a & a \\ \hline 1+a & a \\ \hline \end{array}, \quad \begin{array}{|c|c|} \hline 1+a & a \\ \hline a & a \\ \hline \end{array}, \quad \begin{array}{|c|c|} \hline 1+a & 1+a \\ \hline 1+a & a \\ \hline \end{array}.$$

They obviously describe the correspondence given in Figure 9.

4.2.4. *Symmetries between ASMs statistics.*

Proposition 4.2. *Let δ be an ASM of size n . Then,*

$$(4.2.3) \quad \text{se}(\delta) = \text{nw}(\delta), \quad \text{ne}(\delta) = \text{sw}(\delta), \quad \text{oi}(\delta) = \text{io}(\delta) + n.$$

Proof. Consider the set of osculating paths P associated with δ and the correspondence between the vertices of six-vertex configurations and osculating paths (see Figure 9). The first identity of (4.2.3) is equivalent to say that there are in P as many horizontal steps as vertical steps. Since in P , any osculating path connects the i th vertex of the first column with the i th vertex of the first row of the grid, for any $i \in [n]$, this property holds. Whence the first identity.

Consider now the ASM δ' where, for any $i \in [n]$, the i th row of δ' is the $(n - i + 1)$ st row of δ . Then, in the six-vertex configuration in bijection with δ' , all ne (resp. sw) configurations come from se (resp. nw) configurations of the six-vertex configuration in bijection with δ . Then, the second identity follows from the first one.

The last identity follows immediately from the fact that any row and column of δ starts and ends by +, and the + and the - alternate. \square

4.3. Algebraic interpretation of some statistics. We provide algebraic interpretations of the statistics on ASMs recalled in the previous section by using the Hopf algebra **ASM**. To be more precise, we study the algebraic quotients of **ASM** by equivalence relations defined via ASMs statistics.

4.3.1. *Maps from **ASM** to q -rational functions.* Let us recall the following notations in the algebra $\mathbb{K}(q)$ of q -rational functions:

$$(4.3.1) \quad [n]_q := 1 + q + \dots + q^{n-1}, \quad n \geq 1,$$

$$(4.3.2) \quad [0]_q! := 1, \quad [n]_q! := [1]_q [2]_q \dots [n]_q, \quad n \geq 1,$$

$$(4.3.3) \quad \begin{bmatrix} n_1+n_2 \\ n_1, n_2 \end{bmatrix}_q := \frac{[n_1+n_2]_q!}{[n_1]_q! [n_2]_q!}, \quad n_1, n_2 \geq 0.$$

Lemma 4.3. *Let $\delta, \delta_1,$ and δ_2 be three ASMs such that $M^\delta \in M^{\delta_1} \boxplus M^{\delta_2}$. Then, for any $s \in \mathfrak{N}$,*

$$(4.3.4) \quad s(\delta) = s(\delta_1) + s(\delta_2).$$

Proof. The two statistics oi and io of \mathfrak{N} , respectively count the number of entries + and - in ASMs. This result follows from the fact that the shifted shuffle of packed matrices does not add nor remove nonzero entries and the fact that any nonzero entry encoding a + (resp. -) in the operands M^{δ_1} and M^{δ_2} gives rise to a + (resp. -) in M^δ . \square

Here is the product (4.1.3) in **ASM**, seen on six-vertex configurations, where boldfaced vertices are of kind io.

$$(4.3.5) \quad \mathbf{F} \begin{array}{c} \uparrow \downarrow \\ \leftarrow \rightarrow \\ \uparrow \downarrow \\ \leftarrow \rightarrow \\ \uparrow \downarrow \\ \leftarrow \rightarrow \end{array} \cdot \mathbf{F} \begin{array}{c} \uparrow \downarrow \\ \leftarrow \rightarrow \\ \uparrow \downarrow \\ \leftarrow \rightarrow \\ \uparrow \downarrow \\ \leftarrow \rightarrow \end{array} = \mathbf{F} \begin{array}{c} \uparrow \downarrow \\ \leftarrow \rightarrow \\ \uparrow \downarrow \\ \leftarrow \rightarrow \\ \uparrow \downarrow \\ \leftarrow \rightarrow \end{array} + \mathbf{F} \begin{array}{c} \uparrow \downarrow \\ \leftarrow \rightarrow \\ \uparrow \downarrow \\ \leftarrow \rightarrow \\ \uparrow \downarrow \\ \leftarrow \rightarrow \end{array} + \mathbf{F} \begin{array}{c} \uparrow \downarrow \\ \leftarrow \rightarrow \\ \uparrow \downarrow \\ \leftarrow \rightarrow \\ \uparrow \downarrow \\ \leftarrow \rightarrow \end{array} + \mathbf{F} \begin{array}{c} \uparrow \downarrow \\ \leftarrow \rightarrow \\ \uparrow \downarrow \\ \leftarrow \rightarrow \\ \uparrow \downarrow \\ \leftarrow \rightarrow \end{array} + \mathbf{F} \begin{array}{c} \uparrow \downarrow \\ \leftarrow \rightarrow \\ \uparrow \downarrow \\ \leftarrow \rightarrow \\ \uparrow \downarrow \\ \leftarrow \rightarrow \end{array}$$

Proposition 4.4. *The map $\phi_s : \mathbf{ASM} \rightarrow \mathbb{K}(q)$ linearly defined, for any $s \in \mathfrak{N}$ and any ASM δ of size n by*

$$(4.3.6) \quad \phi_s(\mathbf{F}_\delta) := \frac{q^{s(\delta)}}{n!}$$

is an algebra morphism.

Proof. This result follows immediately from Lemma 4.3 and the fact that the product of two matrices of sizes n_1 and n_2 in \mathbf{ASM} over the fundamental basis contains $\binom{n_1+n_2}{n_1}$ terms. \square

Lemma 4.5. *Let δ , δ_1 , and δ_2 be three ASMs such that $M^\delta \in M^{\delta_1} \square M^{\delta_2}$. Let m be the size of δ_2 (resp. δ_1) and $\{k_1 < k_2 < \dots < k_m\}$ be the set of the indices of the columns of M^δ coming from M^{δ_2} (resp. M^{δ_1}). Then, for any $s \in \{\text{nw}, \text{se}\}$ (resp. $s \in \{\text{sw}, \text{ne}\}$),*

$$(4.3.7) \quad s(\delta) = s(\delta_1) + s(\delta_2) + \sum_{1 \leq j \leq m} (k_j - j).$$

Proof. Let us prove the statement for the nw statistic. Let us denote by n_1 the size of δ_1 and by M_1 (resp. M_2) the first n_1 (resp. the last m) rows of δ .

Notice that the zero columns of M_2 have no nw configuration and that the nw configurations lying in the nonzero columns of M_1 (resp. M_2) are those of δ_1 (resp. δ_2). It remains to count, for all $j \in [m]$, the number of nw configurations in the k_j th column of M_1 . Observe that the sums of the entries above any zero of the k_j th column are 0. Besides, there are exactly $k_j - j$ zeros in the k_j th column such that the sums of the entries to their left are 1. These zeros are, by definition, nw configurations, whence (4.3.7).

This is also valid for the statistic sw since the symmetry consisting in swapping the i th and $(n - i + 1)$ st row of ASMs of size n exchanges the nw configurations into sw configurations. By Proposition 4.2, this also proves the statement of the se and ne statistics. \square

Here is the product (4.1.3) in \mathbf{ASM} , seen on six-vertex configurations, where boldfaced vertices are of kind nw.

$$(4.3.8) \quad \mathbf{F} \begin{array}{c} \uparrow \uparrow \uparrow \uparrow \\ \rightarrow \rightarrow \rightarrow \rightarrow \\ \leftarrow \leftarrow \leftarrow \leftarrow \\ \downarrow \downarrow \downarrow \downarrow \end{array} \cdot \mathbf{F} \begin{array}{c} \uparrow \uparrow \\ \rightarrow \rightarrow \\ \leftarrow \leftarrow \\ \downarrow \downarrow \end{array} = \mathbf{F} \begin{array}{c} \uparrow \uparrow \uparrow \uparrow \\ \rightarrow \rightarrow \rightarrow \rightarrow \\ \leftarrow \leftarrow \leftarrow \leftarrow \\ \downarrow \downarrow \downarrow \downarrow \end{array} + \mathbf{F} \begin{array}{c} \uparrow \uparrow \uparrow \uparrow \\ \rightarrow \rightarrow \rightarrow \rightarrow \\ \leftarrow \leftarrow \leftarrow \leftarrow \\ \downarrow \downarrow \downarrow \downarrow \end{array} + \mathbf{F} \begin{array}{c} \uparrow \uparrow \uparrow \uparrow \\ \rightarrow \rightarrow \rightarrow \rightarrow \\ \leftarrow \leftarrow \leftarrow \leftarrow \\ \downarrow \downarrow \downarrow \downarrow \end{array} + \mathbf{F} \begin{array}{c} \uparrow \uparrow \uparrow \uparrow \\ \rightarrow \rightarrow \rightarrow \rightarrow \\ \leftarrow \leftarrow \leftarrow \leftarrow \\ \downarrow \downarrow \downarrow \downarrow \end{array} + \mathbf{F} \begin{array}{c} \uparrow \uparrow \uparrow \uparrow \\ \rightarrow \rightarrow \rightarrow \rightarrow \\ \leftarrow \leftarrow \leftarrow \leftarrow \\ \downarrow \downarrow \downarrow \downarrow \end{array}$$

Proposition 4.6. *The map $\phi'_s : \mathbf{ASM} \rightarrow \mathbb{K}(q)$ linearly defined, for any $s \in \mathfrak{J}$ and any ASM δ of size n by*

$$(4.3.9) \quad \phi'_s(\mathbf{F}_\delta) := \frac{q^{s(\delta)}}{[n]_q!}$$

is an algebra morphism.

Proof. Let us prove the statement of nw statistic; the three other cases are analogous. Let δ_1 and δ_2 be two ASMs of respective sizes n_1 and n_2 . Lemma 4.5 implies

$$\begin{aligned} \phi'_{\text{nw}}(\mathbf{F}_{\delta_1} \cdot \mathbf{F}_{\delta_2}) &= \frac{q^{\text{nw}(\delta_1) + \text{nw}(\delta_2)}}{[n_1 + n_2]_q!} \sum_{\{k_1, \dots, k_{n_2}\} \subset \{1, \dots, n_1 + n_2\}} q^{(k_1 - 1) + \dots + (k_{n_2} - n_2)} \\ &= \frac{q^{\text{nw}(\delta_1) + \text{nw}(\delta_2)}}{[n_1 + n_2]_q!} [n_1 + n_2]_{n_1, n_2, q} \\ &= \phi'_{\text{nw}}(\mathbf{F}_{\delta_1}) \cdot \phi'_{\text{nw}}(\mathbf{F}_{\delta_2}). \quad \square \end{aligned}$$

By similar arguments, all previous results remain valid in the dual \mathbf{ASM}^* of \mathbf{ASM} . Hence,

Proposition 4.7. *The maps $\psi_s : \mathbf{ASM}^* \rightarrow \mathbb{K}(q)$ and $\psi'_t : \mathbf{ASM}^* \rightarrow \mathbb{K}(q)$ linearly defined, for any $s \in \mathfrak{N}$, $t \in \mathfrak{Z}$, and any ASM δ of size n by*

$$(4.3.10) \quad \psi_s(\mathbf{F}_\delta^*) := \frac{q^{s(\delta)}}{n!} \quad \text{and} \quad \psi'_t(\mathbf{F}_\delta^*) := \frac{q^{t(\delta)}}{[n]_q!}$$

are algebra morphisms.

Here is the product (4.1.3) in \mathbf{ASM}^* , seen on six-vertex configurations, where the vertices represented by squares are of kind io while those represented by circles are of kind nw.

$$(4.3.11) \quad \mathbf{F}^* \cdot \mathbf{F}^* = \mathbf{F}^* + \mathbf{F}^* + \mathbf{F}^* + \mathbf{F}^* + \mathbf{F}^* .$$

4.3.2. Equivalence relations on ASMs and associated subspaces of \mathbf{ASM} . Let $S \subseteq \mathfrak{Z} \cup \mathfrak{N}$ be a set of statistics and \sim_S be the equivalence relation on the set of ASMs defined, for any ASMs δ_1 and δ_2 of the same size, by

$$(4.3.12) \quad \delta_1 \sim_S \delta_2 \quad \text{if and only if} \quad s(\delta_1) = s(\delta_2) \quad \text{for all } s \in S.$$

We denote by I_S the associated vector space spanned by

$$(4.3.13) \quad \{\mathbf{F}_{\delta_1} - \mathbf{F}_{\delta_2}, \delta_1 \sim_S \delta_2\}.$$

4.3.3. The algebra $\mathbf{ASM}/I_{\text{io}}$. Let us first study the statistic $\text{io} \in \mathfrak{N}$.

Proposition 4.8. *The quotient $\mathbf{ASM}/I_{\text{io}}$ is a commutative algebra.*

Proof. The subspace I_{io} of \mathbf{ASM} is a two-sided ideal of \mathbf{ASM} . Indeed, let δ , δ_1 , and δ_2 be three ASMs such that $\delta_1 \sim_{\text{io}} \delta_2$. Since the products $\mathbf{F}_\delta \cdot \mathbf{F}_{\delta_i}$ and $\mathbf{F}_{\delta_i} \cdot \mathbf{F}_\delta$ for $i \in \{1, 2\}$ have the same number of terms, Lemma 4.3 implies that the products $\mathbf{F}_\delta \cdot (\mathbf{F}_{\delta_1} - \mathbf{F}_{\delta_2})$ and $(\mathbf{F}_{\delta_1} - \mathbf{F}_{\delta_2}) \cdot \mathbf{F}_\delta$ are in I_{io} . Hence, $\mathbf{ASM}/I_{\text{io}}$ is an algebra.

Besides, the ideal I_{io} contains the commutators. Indeed, let δ_1 and δ_2 be two ASMs. Since the products $\mathbf{F}_{\delta_1} \cdot \mathbf{F}_{\delta_2}$ and $\mathbf{F}_{\delta_2} \cdot \mathbf{F}_{\delta_1}$ have the same number of terms, Lemma 4.3 implies that $\mathbf{F}_{\delta_1} \cdot \mathbf{F}_{\delta_2} - \mathbf{F}_{\delta_2} \cdot \mathbf{F}_{\delta_1}$ is in I_{io} . Thus, $\mathbf{ASM}/I_{\text{io}}$ is commutative as an algebra. \square

Note however that $\mathbf{ASM}/I_{\text{io}}$ does not inherit the structure of a coalgebra of \mathbf{ASM} because even if

$$(4.3.14) \quad x := \mathbf{F} \begin{bmatrix} 0 & + & 0 & 0 \\ + & - & + & 0 \\ 0 & + & 0 & 0 \\ 0 & 0 & 0 & + \end{bmatrix} - \mathbf{F} \begin{bmatrix} 0 & + & 0 & 0 \\ + & - & 0 & + \\ 0 & + & 0 & 0 \\ 0 & 0 & + & 0 \end{bmatrix}$$

is an element of I_{io} , the element

$$(4.3.15) \quad \Delta(x) = 1 \otimes x + \mathbf{F} \begin{bmatrix} 0 & + & 0 \\ + & - & + \\ 0 & + & 0 \end{bmatrix} \otimes \mathbf{F}[+] + x \otimes 1$$

is not in $\mathbf{ASM} \otimes I_{\text{io}} + I_{\text{io}} \otimes \mathbf{ASM}$. Hence, I_{io} is not a coideal.

Proposition 4.9. *The dimension A_n^{io} of the n th graded component of $\mathbf{ASM}/I_{\text{io}}$ is $\lfloor \frac{n^2}{4} \rfloor + 1$.*

Proof. Let δ be an ASM of size n with a maximal number of io configurations (*i.e.*, a maximal number of $-$). Then, it is easy to see that

$$(4.3.16) \quad \text{io}(\delta) = \sum_{i=0}^{\lfloor \frac{n}{2} \rfloor - 1} i + \sum_{i=1}^{\lfloor \frac{n-1}{2} \rfloor} i.$$

Indeed, the first and last row of an ASM can contain only one $+$ and no $-$. Let $i \geq 2$ and let A_{i-1} be the matrix consisting in the first $i-1$ rows of A . The $-$ s in row i can only be in those columns for which the corresponding column sum of the submatrix A_{i-1} is 1. Since the row sums of A_{i-1} are 1 and the column sums of A_{i-1} are 0 or 1, exactly $i-1$ of the column sums of A_{i-1} are 1. We conclude that there are at most $(i-1)$ $-$ s in row i . The same argument applies to the column sums taken from bottom to top. Hence, the rows i and $n-i+1$ are at most $(i-1)$ $-$ s. If n is odd, then the row $(n+1)/2$ has only nonzero entries, alternating between $+$ and $-$, and the row $(n+1)/2$ has $\lfloor \frac{n}{2} \rfloor$ $-$ s.

Now, since for any $0 \leq k \leq \text{io}(\delta)$, there exists an ASM δ' such that $\text{io}(\delta') = k$, we obtain, by a simple computation, the statement of the proposition. \square

The dimensions of $\mathbf{ASM}/I_{\text{io}}$ form Sequence [A033638](#) of [Slo] and the first few terms are

$$(4.3.17) \quad 1, 1, 1, 2, 3, 5, 7, 10, 13, 17, 21.$$

A basic argument on generating series implies that these dimensions cannot be the ones of a free commutative algebra and hence, $\mathbf{ASM}/I_{\text{io}}$ is not free as a commutative algebra.

Using the symmetry between the statistics io and oi provided by Proposition 4.2, we immediately have $\sim_{\text{oi}} = \sim_{\text{io}}$ and then, $\mathbf{ASM}/I_{\text{oi}} = \mathbf{ASM}/I_{\text{io}}$.

4.3.4. *The algebra $\mathbf{ASM}/I_{\text{nw}}$.* Let us now study the statistic $\text{nw} \in \mathfrak{J}$.

Proposition 4.10. *The quotient $\mathbf{ASM}/I_{\text{nw}}$ is a commutative algebra.*

Proof. The subspace I_{nw} of \mathbf{ASM} is a two-sided ideal of \mathbf{ASM} . Indeed, let δ , δ_1 and δ_2 be three ASMs of respective sizes n , n_1 and n_2 such that $\delta_1 \sim_{\text{nw}} \delta_2$. Lemma 4.5 implies that the number of nw configurations of an ASM δ' such that $\mathbf{F}_{\delta'}$ appears in $\mathbf{F}_{\delta} \cdot \mathbf{F}_{\delta_1}$ (resp. $\mathbf{F}_{\delta} \cdot \mathbf{F}_{\delta_2}$) depends only on the number of nw configurations in δ and δ_1 (resp. δ_2) and a subset of $[n+n_1]$ (resp. $[n+n_2]$) of size n_1 (resp. n_2) corresponding to the positions in δ' of the columns coming from δ_1 (resp. δ_2).

Since $\delta_1 \sim_{\text{nw}} \delta_2$, the product $\mathbf{F}_\delta \cdot (\mathbf{F}_{\delta_1} - \mathbf{F}_{\delta_2})$ is in I_{nw} . Similarly $(\mathbf{F}_{\delta_1} - \mathbf{F}_{\delta_2}) \cdot \mathbf{F}_\delta$ also is in I_{nw} . Hence, $\mathbf{ASM}/I_{\text{nw}}$ is an algebra.

The ideal I_{nw} contains the commutators. Indeed, let δ_1 and δ_2 be two ASMs of respective sizes n_1 and n_2 . The symmetry of q -binomial coefficients implies that there are as many subsets $S_{1,2}$ of $[n_1 + n_2]$ of size n_2 as subset $S_{2,1}$ of $[n_1 + n_2]$ of size n_1 such that the sum of elements of $S_{1,2}$ is equal to the sum of elements of $S_{2,1}$. Lemma 4.3 implies that $\mathbf{F}_{\delta_1} \cdot \mathbf{F}_{\delta_2} - \mathbf{F}_{\delta_2} \cdot \mathbf{F}_{\delta_1}$ is in I_{nw} . Thus, $\mathbf{ASM}/I_{\text{nw}}$ is commutative as an algebra. \square

Note however that $\mathbf{ASM}/I_{\text{nw}}$ does not inherit the structure of a coalgebra of \mathbf{ASM} because even if

$$(4.3.18) \quad x := \mathbf{F} \begin{bmatrix} 0 & 0 & 0 & + \\ + & 0 & 0 & 0 \\ 0 & 0 & + & 0 \\ 0 & + & 0 & 0 \end{bmatrix} - \mathbf{F} \begin{bmatrix} 0 & 0 & + & 0 \\ 0 & + & 0 & 0 \\ + & 0 & - & + \\ 0 & 0 & + & 0 \end{bmatrix}$$

is an element of I_{nw} , the element

$$(4.3.19) \quad \Delta(x) = 1 \otimes x + \mathbf{F}_{[+]} \otimes \mathbf{F} \begin{bmatrix} 0 & 0 & + \\ 0 & + & 0 \\ + & 0 & 0 \end{bmatrix} + \mathbf{F} \begin{bmatrix} + & 0 \\ 0 & + \end{bmatrix} \otimes \mathbf{F} \begin{bmatrix} 0 & + \\ + & 0 \end{bmatrix} + \mathbf{F} \begin{bmatrix} + & 0 & 0 \\ 0 & 0 & + \\ 0 & + & 0 \end{bmatrix} \otimes \mathbf{F}_{[+]} + x \otimes 1$$

is not in $\mathbf{ASM} \otimes I_{\text{nw}} + I_{\text{nw}} \otimes \mathbf{ASM}$. Hence, I_{nw} is not a coideal.

Proposition 4.11. *The dimension A_n^{nw} of the n th graded component of $\mathbf{ASM}/I_{\text{nw}}$ is $\binom{n}{2} + 1$.*

Proof. Let us first show that there are at least $\binom{n}{2} + 1$ \sim_{nw} -equivalence classes of ASMs of size n by considering a process that associates with a permutation matrix M_1 of size n a permutation matrix M_2 such that $\text{nw}(M_2) = \text{nw}(M_1) + 1$. If M_1 is not the permutation matrix I_n of the identity, there is a greatest integer $k \geq 0$ such that $M_1 = I_k / M'_1$ and M'_1 is not empty. Consider now the matrix $M_2 := I_k / M'_2$ where M'_2 is the matrix obtained by swapping the $(i-1)$ st and the i th columns of M'_1 so that i is the index of the column of M'_1 containing its uppermost 1. Starting with the matrix M_1 of size n of the form $1 \setminus \cdots \setminus 1$, we can iteratively apply the previous process $\binom{n}{2}$ times. Since each iteration obviously increases by one the number of nw configurations, all the $\binom{n}{2} + 1$ permutation matrices are in different \sim_{nw} -equivalence classes.

Let us then show that there are no more than $\binom{n}{2} + 1$ \sim_{nw} -equivalence classes of ASMs of size n . Each entry of an ASM δ of size n gives rise to a configuration among the six possible. Then,

$$(4.3.20) \quad n^2 = \text{nw}(\delta) + \text{ne}(\delta) + \text{sw}(\delta) + \text{nw}(\delta) + \text{io}(\delta) + \text{oi}(\delta).$$

By using the symmetries provided by Proposition 4.2, (4.3.20) becomes

$$(4.3.21) \quad n^2 = 2\text{sw}(\delta) + 2\text{nw}(\delta) + 2\text{io}(\delta) + n$$

and we deduce that $\text{nw}(\delta) \leq \frac{n^2 - n}{2} = \binom{n}{2}$. \square

The dimensions of $\mathbf{ASM}/I_{\text{nw}}$ form Sequence [A152947](#) of [Slo] and the first few terms are

$$(4.3.22) \quad 1, 1, 2, 4, 7, 11, 16, 22, 29, 37, 46, 56.$$

A basic argument on generating series implies that these dimensions cannot be the ones of a free commutative algebra and hence, $\mathbf{ASM}/I_{\text{nw}}$ is not free as a commutative algebra.

Using the symmetry between the statistics nw and se provided by Proposition 4.2, we immediately have $\sim_{\text{se}} = \sim_{\text{nw}}$ and then, $\mathbf{ASM}/I_{\text{se}} = \mathbf{ASM}/I_{\text{nw}}$. Moreover, by using the same arguments as before, $\mathbf{ASM}/I_{\text{sw}}$ and $\mathbf{ASM}/I_{\text{ne}}$ are the same commutative algebras.

Note that the map $\theta : \mathbf{ASM}/I_{\text{nw}} \rightarrow \mathbf{ASM}/I_{\text{sw}}$ linearly defined for any ASM δ by

$$(4.3.23) \quad \theta(\pi_{\text{nw}}(\mathbf{F}_\delta)) := \pi_{\text{sw}}(\mathbf{F}_{\overleftarrow{\delta}}),$$

where π_{nw} (resp. π_{sw}) is the canonical projection from \mathbf{ASM} to $\mathbf{ASM}/I_{\text{nw}}$ (resp. $\mathbf{ASM}/I_{\text{sw}}$) and $\overleftarrow{\delta}$ is the ASM where, for any $i \in [n]$, the i th column of $\overleftarrow{\delta}$ is the $(n - i + 1)$ st column of δ , is an isomorphism between $\mathbf{ASM}/I_{\text{nw}}$ and $\mathbf{ASM}/I_{\text{sw}}$.

4.3.5. *The algebra $\mathbf{ASM}/I_{\text{io,nw}}$.* Let us finally study the set of statistics $\{\text{io, nw}\}$.

Proposition 4.12. *The quotient $\mathbf{ASM}/I_{\text{io,nw}}$ is a commutative algebra.*

Proof. This follows directly from Propositions 4.8 and 4.10. \square

Note however that $\mathbf{ASM}/I_{\text{io,nw}}$ does not inherit the structure of a coalgebra of \mathbf{ASM} because even if

$$(4.3.24) \quad x := \mathbf{F} \begin{bmatrix} 0 & + & 0 & 0 \\ + & - & + & 0 \\ 0 & 0 & 0 & + \\ 0 & + & 0 & 0 \end{bmatrix} - \mathbf{F} \begin{bmatrix} 0 & + & 0 & 0 \\ 0 & 0 & + & 0 \\ + & - & 0 & + \\ 0 & + & 0 & 0 \end{bmatrix}$$

is an element of $I_{\text{io,nw}}$, the element

$$(4.3.25) \quad \Delta(x) = 1 \otimes x + \mathbf{F} \begin{bmatrix} 0 & + & 0 \\ + & - & + \\ 0 & + & 0 \end{bmatrix} \otimes \mathbf{F}_{[+]} + x \otimes 1$$

is not in $\mathbf{ASM} \otimes I_{\text{io,nw}} + I_{\text{io,nw}} \otimes \mathbf{ASM}$. Hence, $I_{\text{io,nw}}$ is not a coideal.

By computer exploration, the first few dimensions of $\mathbf{ASM}/I_{\text{io,nw}}$ are

$$(4.3.26) \quad 1, 1, 2, 5, 13, 31, 66, 127, 225,$$

and seems to be Sequence [A116701](#) of [Slo].

A basic argument on generating series implies that these dimensions cannot be the ones of a free commutative algebra and hence, $\mathbf{ASM}/I_{\text{io,nw}}$ is not free as a commutative algebra.

4.3.6. *Others quotients of \mathbf{ASM} .* Using the symmetries provided by Proposition 4.2, all the algebras \mathbf{ASM}/I_S , where S contains two nonsymmetric statistics, are equal to $\mathbf{ASM}/I_{\text{io,nw}}$. Moreover, note that by using the same arguments as before, one can prove that for any $S \in \mathfrak{J} \cup \mathfrak{N}$, \mathbf{ASM}/I_S is a commutative algebra isomorphic to $\mathbf{ASM}/I_{\text{io}}$, $\mathbf{ASM}/I_{\text{nw}}$, or $\mathbf{ASM}/I_{\text{io,nw}}$.

REFERENCES

- [AO08] M. Aguiar and R. C. Orellana. The Hopf algebra of uniform block permutations. *J. Algebraic Combin.*, 28(1):115–138, 2008.
- [Bax08] R.-J. Baxter. *Exactly Solved Models in Statistical Mechanics (Dover Books on Physics)*. Dover Publications, 2008.
- [Beh08] R. E. Behrend. Osculating paths and oscillating tableaux. *Elec. J. of Comb.*, 15(1):60 pp, 2008.
- [BMH95] M. Bousquet-Mélou and L. Habsieger. Sur les matrices à signes alternants. *Discrete Math.*, 139:57–72, 1995.
- [Bre99] D. M. Bressoud. *Proofs and Confirmations, The Story of the Alternating Sign Matrix Conjecture*. Cambridge University Press, Cambridge, 1999.
- [DHT02] G. Duchamp, F. Hivert, and J.-Y. Thibon. Noncommutative Symmetric Functions VI: Free Quasi-Symmetric Functions and Related Algebras. *Int. J. of Algebra and Computation*, 12:671–717, 2002.
- [EKLP92] N. Elkies, G. Kuperberg, M. Larsen, and J. Propp. Alternating-sign matrices and domino tilings. II. *J. Algebraic Combin.*, 1(3):219–234, 1992.
- [Foi07] L. Foissy. Bidendriform bialgebras, trees, and free quasi-symmetric functions. *J. Pure Appl. Algebra*, 209(2):439–459, 2007.

- [GKL⁺95] I.M. Gelfand, D. Krob, A. Lascoux, B. Leclerc, V.S. Retakh, and J.-Y. Thibon. Noncommutative symmetric functions I. *Adv. Math.*, 112, 1995.
- [Gir11] S. Giraudo. *Combinatoire algébrique des arbres*. PhD thesis, Université de Marne la Vallée, 2011.
- [Gir12] S. Giraudo. Algebraic and combinatorial structures on pairs of twin binary trees. *J. Algebra*, 360:115–157, 2012.
- [GR63] G. Th. Guilbaud and P. Rosenstiehl. Analyse algébrique d’un scrutin. *Mathématiques et sciences humaines*, tome 4:9–33, 1963.
- [Hiv99] F. Hivert. *Combinatoire des fonctions quasi-symétriques*. PhD thesis, Université de Marne la Vallée, 1999.
- [HNT02] F. Hivert, J.-C. Novelli, and J.-Y. Thibon. An analogue of the plactic monoid for binary search trees. *Comptes-Rendus Mathématique*, 335, Number 7:577–580, 2002.
- [HNT05] F. Hivert, J.-C. Novelli, and J.-Y. Thibon. The Algebra of Binary Search Trees. *Theor. Comput. Sci.*, 339, Issue 1:129–165, 2005.
- [HN07] F. Hivert and J. Nzeutchap. Dual graded graphs in combinatorial Hopf algebras. *unpublished*, 2007.
- [Knu98] D. Knuth. *The Art of Computer Programming. Volume 3. Sorting and searching*. Addison Wesley Longman, 1998.
- [Kor82] V. Korepin. Calculation of norms of Bethe wave functions. *Comm. Math. Phys.*, 86(3):319–418, 1982.
- [KT97] D. Krob and J.-Y. Thibon. Noncommutative symmetric functions IV : Quantum linear groups and Hecke algebras at $q = 0$. *Journal of Algebraic Combinatorics* 6, 4:339–376, 1997.
- [KT99] D. Krob and J.-Y. Thibon. Noncommutative symmetric functions V : A degenerate version of $U_q(\mathfrak{gl}_N)$. *Internat. J. Algebra Comput.* 9, 3-4:405–430, 1999.
- [Kup96] G. Kuperberg. Another proof of the alternating-sign matrix conjecture. *Internat. Math. Res. Notices*, 3:139–150, 1996.
- [LS81] A. Lascoux and M.-P. Schützenberger. Le monoïde plaxique. In *Noncommutative structures in algebra and geometric combinatorics (Naples, 1978)*, volume 109 of *Quad. “Ricerca Sci.”*, pages 129–156. CNR, Rome, 1981.
- [Lod01] J.-L. Loday. Dialgebras. *Lect. Notes Math.*, 1763:7–66, 2001.
- [LR98] J.-L. Loday and M. Ronco. Hopf Algebra of the Planar Binary Trees. *Adv. Math.*, 139:293–309, 1998.
- [Lot02] M. Lothaire. *Algebraic combinatorics on words*. Cambridge University Press, 2002.
- [MR95] C. Malvenuto and C. Reutenauer. Duality between quasi-symmetric functions and the Solomon descent algebra. *J. Algebra*, 177(3):967–982, 1995.
- [MRR83] W.H. Mills, D.P. Robbins, and H. Jr. Rumsey. Alternating sign matrices and descending plane partitions. *J. Combin. Th. Ser. A.*, 34:340–359, 1983.
- [NT06] J.-C. Novelli and J.-Y. Thibon. Polynomial realizations of some trialgebras. *FPSAC*, 2006.
- [NT07] J.-C. Novelli and J.-Y. Thibon. Hopf algebras and dendriform structures arising from parking functions. *Fundamenta Mathematicae*, 193:189–241, 2007.
- [NT10] J.-C. Novelli and J.-Y. Thibon. Free quasi-symmetric functions and descent algebras for wreath products, and noncommutative multi-symmetric functions. *Discrete Math.*, 310(24):3584–3606, 2010.
- [PR95] S. Poirier and C. Reutenauer. Algèbres de Hopf de tableaux. *Ann. Sci. Math. Québec*, 19:79–90, 1995.
- [Rey07] M. Rey. Algebraic constructions on set partitions. *Formal Power Series and Algebraic Combinatorics*, 2007.
- [RR86] D.P. Robbins and H. Jr. Rumsey. Determinants and alternating sign matrices. *Adv. in Math.*, 62(2):169–184, 1986.
- [SCc08] The Sage-Combinat community. *Sage-Combinat: enhancing Sage as a toolbox for computer exploration in algebraic combinatorics*, 2008. <http://combinat.sagemath.org>.
- [Sch61] C. Schensted. Longest increasing and decreasing subsequences. *Canadian J. of Math.*, 13:179–191, 1961.
- [Slo] N. J. A. Sloane. The On-Line Encyclopedia of Integer Sequences. <http://www.research.att.com/~njas/sequences/>.
- [S⁺12] W. A. Stein et al. *Sage Mathematics Software (Version 5.0.1)*. The Sage Development Team, 2012. <http://www.sagemath.org>.

GREYC CNRS UMR 6072, BOULEVARD MARÉCHAL JUIN, F-14032 CAEN CEDEX, FRANCE
E-mail address: hayat.cheballah@unicaen.fr

LABORATOIRE D’INFORMATIQUE GASPARD-MONGE, UNIVERSITÉ PARIS-EST MARNE-LA-VALLÉE, 5 BOULEVARD DESCARTES, CHAMPS-SUR-MARNE, 77454 MARNE-LA-VALLÉE CEDEX 2, FRANCE
E-mail address: samuele.giraudo@univ-mlv.fr

LABORATOIRE D’INFORMATIQUE GASPARD-MONGE, UNIVERSITÉ PARIS-EST MARNE-LA-VALLÉE, 5 BOULEVARD DESCARTES, CHAMPS-SUR-MARNE, 77454 MARNE-LA-VALLÉE CEDEX 2, FRANCE
E-mail address: remi.maurice@univ-mlv.fr