

Removing Colors $2k$, $2k-1$, and k

Pedro Lopes
 Department of Mathematics
 Instituto Superior Técnico
 Universidade de Lisboa
 Av. Rovisco Pais
 1049-001 Lisbon
 Portugal
 pelopes@math.ist.utl.pt

August 23, 2013

Abstract

We prove that if a link admits non-trivial $(2k+1)$ -colorings, with prime $2k+1 > 7$, it also admits non-trivial $(2k+1)$ -colorings not involving colors $2k$, $2k-1$, nor k .

MSC 2010: 57M27

1 Introduction

In [1] Oshiro proved that colors 6, 5 and 3 can always be removed from a non-trivial 7-coloring. We mimic Oshiro's approach to prove the following.

Theorem 1.1. *Let $p = 2k+1 > 7$ be a prime. Let L be a non-split link which admits non-trivial $(2k+1)$ -colorings. Then colors $2k$, $2k-1$, and k are not needed in order to assemble a non-trivial $(2k+1)$ -coloring of L .*

We now give an outline of the proof. We consider a diagram endowed with a non-trivial $(2k+1)$ -coloring. For each color, c , to be removed the strategy is the following. First we check if the color is used in the coloring. If it is not we are done. Else we consider the following three possibilities, in turn. The first is to ascertain if the color c is used in a monochromatic crossing. If it is not we go to the next step. Else we remove the color c from each monochromatic crossing in the diagram until there is no monochromatic crossing involving color c . The next step is to check if c is used in an over-arc. If it is not we go to the next step. Else we remove c from each over-arc until there is no over-arc with color c . Finally we check if c is used in an under-arc. If it is not we are done. Else we remove it from each under-arc until there is no under-arc using color c . This ends the removal of color c from the coloring. The actual removal of the color at each step is done by performing Reidemeister moves on the diagram and consistently re-assigning colors in the neighborhoods affected by the transformations.

The proof is split into three Sections. In Section 2 we show how to remove $2k$; in Section 3 we show how to remove color $2k-1$, provided color $2k$ is no longer being used; and in Section 4 we show how to remove color k provided colors $2k$ and $2k-1$ are no longer being used.

In the sequel, in any Figure the right-most diagram is the candidate to a diagram without the color under scrutiny, see Figure 1 below, for example. For that the colors in the new arcs are analyzed. These colors are forced to equal the forbidden colors so that we identify the new situations we have to tackle. In the first cases we do the explicit calculations but later on we rely on displaying in tables the forbidden identities (in the first row) and their consequences (in the second row). These consequences can be either

an inconsistency (which is marked by an X) and we can dismiss the situation, or an expression which helps us identify the new situation to be tackled. These new situations, in turn, are dealt with below in the text. We remark also that the inconsistencies are of the sort “arc assuming a forbidden color” or “ $2k + 1 = a$ prime less than 11 or a composite integer”, among others.

Expressions and equalities will be understood modulo $2k + 1$.

2 Removal of Color $2k$

2.1 Removal of Color $2k$ from a Monochromatic Crossing (Figure 1).

View Figure 1. We remark that the details of some crossings are irrelevant for the reasonings here. Since we are trying to remove color $2k$ we would not want $2a + 1$ in the diagram on the right-hand side to equal $2k$. Let us look into the consequences of such identity. If $2a + 1 = 2k$ then $2a + 1 = 2k + 2k + 1$ which amounts to $a = 2k$. But if there is no pair of crossings in the diagram as depicted in Figure 1 such that $a \neq 2k$, then the whole coloring is monochromatic which conflicts with the standing assumption of a non-trivial coloring. (This corresponds to the inconsistencies we discussed above. Below in the tables these instances will be marked with an X .) Hence, by repeating this operation we can assume we remove all the monochromatic crossings with color $2k$.

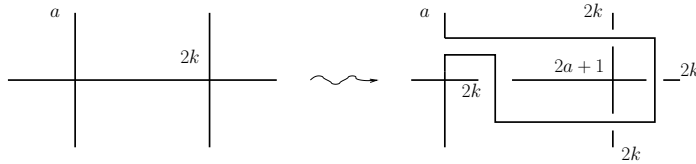

Figure 1: Removing color $2k$ from a monochromatic crossing

2.2 Removal of Color $2k$ from an Over-Arc (Figure 2).

View Figure 2. We have already seen that $a = 2k$ is equivalent to $2a + 1 = 2k$ and we now note that $a = 2k$ is also equivalent to $3a + 2 = 2k$. In this way we have achieved the goal of removing color $2k$ from over-arcs.

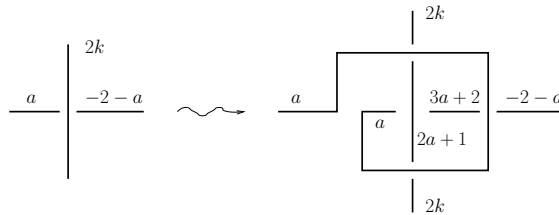

Figure 2: Removing color $2k$ from an over-arc

2.3 Removal of Color $2k$ from an Under-Arc (Figure 3).

View Figure 3.

$2a-b=-1$	$2a-2b-1=-1$
$b=2a+1$	$b=a$

Table 2.1: Equalities which should not occur in Figure 3 (1st row) and their consequences (2nd row). These situations are dealt with in 2.3.1 and 2.3.2 below.

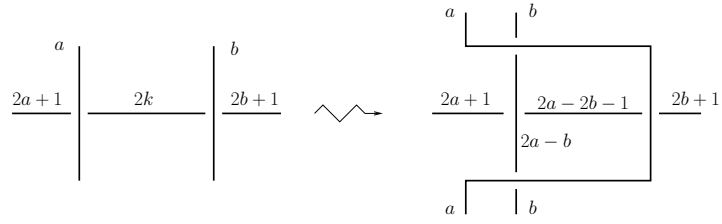

Figure 3: Removing color $2k$ from an under-arc: the initial setting

2.3.1 The $b = 2a + 1$ instance (Figure 4).

View Figure 4.

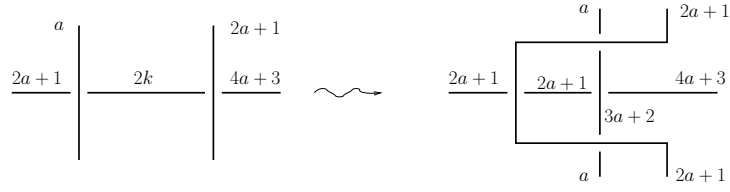

Figure 4: Removing color $2k$ from an under-arc: the $b = 2a + 1$ instance.

$3a+2=-1$
$a=-1$ X

Table 2.2: Equalities which should not occur in Figure 4 (1st row) and their consequences (2nd row). X's stand for conflicts with assumptions thus not requiring further considerations.

2.3.2 The $b = a$ instance (Figure 5).

View Figure 5.

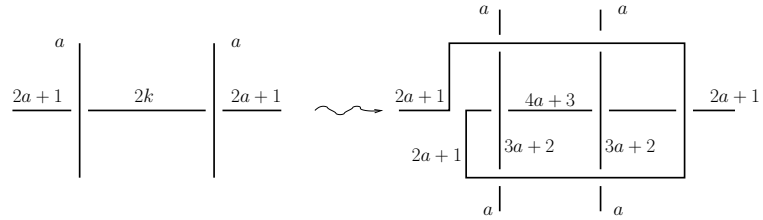

Figure 5: Removing color $2k$ from an under-arc: the $b = a$ instance

$3a+2=-1$	$4a+3=-1$
$a=-1$ X	$a=-1$ X

Table 2.3: Equalities which should not occur in Figure 5 (1st row) and their consequences (2nd row). X's stand for conflicts with assumptions thus not requiring further considerations.

This concludes the removal of color $2k$ from under-arcs and consequently concludes the removal of color $2k$ from the coloring.

3 Removal of Color $2k - 1$, provided color $2k$ has already been removed

3.1 Removal of Color $2k - 1$ from a Monochromatic Crossing (Figures 6 and 7).

View Figure 6. If $2a+2 = -2$ then $a = -2$ which conflicts with the assumptions. If $2a+2 = -1+2k+1$ then $a = k - 1$. In Figure 6 if the arc receiving color $a = k - 1$ is an over-arc then the under-arc to its left receives color $2(k - 1) - (2k - 1) = -1$ which conflicts with the standing assumptions. The remaining instance is contemplated in Figure 7.

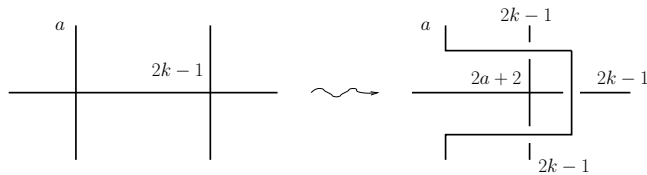

Figure 6: Removing color $2k - 1$ from a monochromatic crossing

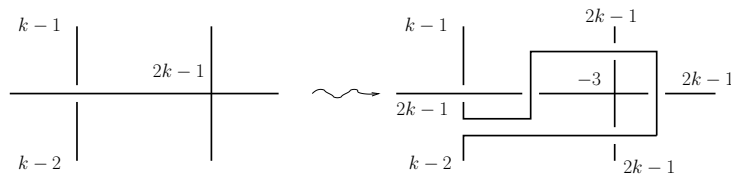

Figure 7: Removing color $2k - 1$ from a monochromatic crossing (remaining instance)

3.2 Removal of Color $2k - 1$ from an Over-Arc (Figures 8 and 9).

View Figure 8.

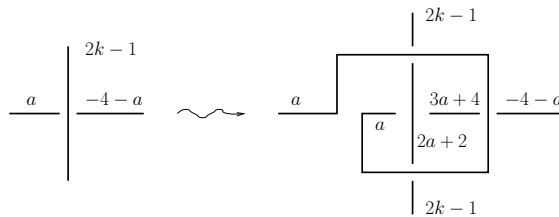

Figure 8: Removing color $2k - 1$ from an over-arc

$2a+2=-1$	$2a+2=-2$	$3a+4=-1$	$3a+4=-2$
$a=k-1$	$a=-2$ X	$3a=-5$	$a=-2$ X

Table 3.1: Equalities which should not occur in Figure 8 (1st row) and their consequences (2nd row). X's stand for conflicts with assumptions thus not requiring further considerations. The other situations are dealt with below in 3.2.1 and 3.2.2.

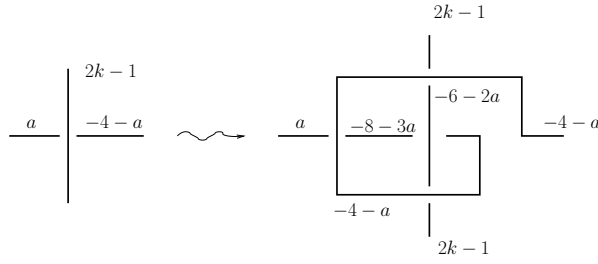

Figure 9: Removing color $2k - 1$ from an over-arc

3.2.1 The $a = k - 1$ instance (Figure 9).

View Figure 9. In this case

$$-6 - 2a = -6 - 2k + 2 = -3$$

$$-8 - 3a = -8 - 3k + 3 = k - 3$$

$k-3=-1$	$k-3=-2$
$2k+1=5$ X	$2k+1=3$ X

Table 3.2: Equalities which should not occur in Figure 9 in the $a = k - 1$ instance (1st row) and their consequences (2nd row). X 's stand for conflicts with assumptions thus not requiring further considerations.

3.2.2 The $3a = -5$ instance (Figure 9)

View Figure 9 again. In this case

$$-8 - 3a = -8 + 5 = -3$$

$$-6 - 2a = -6 - 3a + a = -6 + 5 + a = a - 1$$

$a-1=-1 \Rightarrow a=0 \Rightarrow -5=3a=0$	$a-1=-2$
$2k+1=5$ X	$a=-1$ X

Table 3.3: Equalities which should not occur in Figure 9 in the $-3a = 5$ instance (1st row) and their consequences (2nd row). X 's stand for conflicts with assumptions thus not requiring further considerations.

3.3 Removal of Color $2k - 1$ from an Under-Arc (Figure 10).

View Figure 10.

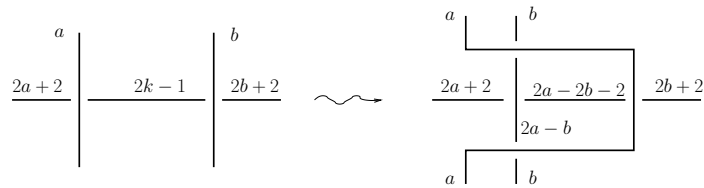

Figure 10: Removing color $2k - 1$ from an under-arc

$2a-b=2k$	$2a-b=2k-1$	$2a-2b-2=2k$	$2a-2b-2=2k-1$
$b=2a+1$	$b=2a+2$	$b=a+k$	$b=a$

Table 3.4: Equalities which should not occur in Figure 10 (1st row) and their consequences (2nd row). X 's stand for conflicts with assumptions thus not requiring further considerations. These situations are dealt with below in 3.3.1, 3.3.2, 3.3.3, and 3.3.4.

3.3.1 The $b = 2a + 1$ instance (Figure 11).

View Figure 11. A few words about the sub-instance $3a + 2 = 2k - 1$, see Table 3.5. In order to solve this equation for a it is useful to know how the modulus $2k + 1$ can be expressed mod 3. If $2k + 1 = 3l$ for some integer l then $2k + 1$ would be composite which conflicts with the assumptions. So the possibilities are $2k + 1 = 3l + 1$ or $2k + 1 = 2l + 2$. This is how the two consequences in the bottom right slot of Table 3.5 come about. Similar situations occur below with a parameter being multiplied by a constant. They are dealt with analogously.

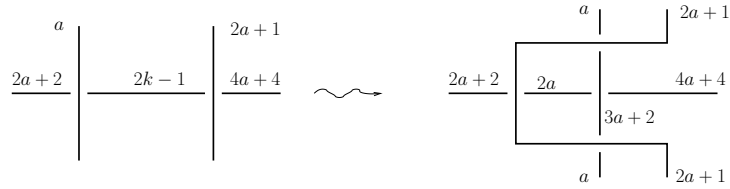

Figure 11: Removing color $2k - 1$ from an under-arc: the $b = 2a + 1$ instance

$2a=2k$	$2a=2k-1$	$3a+2=2k$	$3a+2=2k-1$
$a=k$	$a=-1$ X	$a=-1$ X	$a=3l+1$ or $a=3l+2$

Table 3.5: Equalities which should not occur in Figure 11 (1st row) and their consequences (2nd row). X 's stand for conflicts with assumptions thus not requiring further considerations. The other situations are dealt with below in 3.3.1.1, 3.3.1.2, and 3.3.1.3

3.3.1.1 The $a = k$ instance (Figure 12) Working over modulus $2k + 1$ with $a = k$, then $2a + 2 = 2k + 2 = 1$, $2a + 1 = 2k + 1 = 0$ and $4a + 4 = 4k + 4 = 2(2k + 1) + 2 = 2$. Now Figure 12 should be self-explanatory.

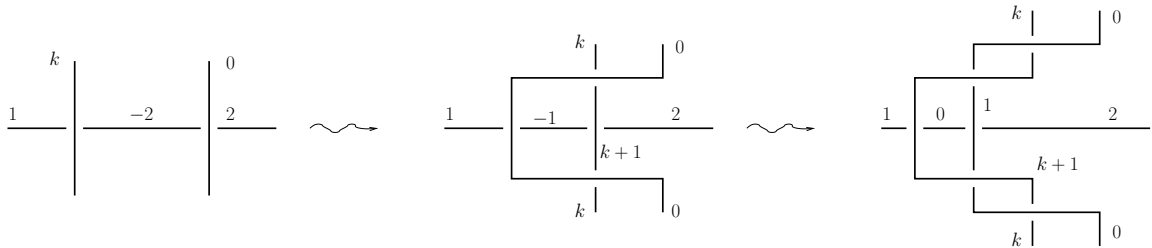

Figure 12: Removing color $2k - 1$ from an under-arc: the $b = 2a + 1$ with $a = k$ sub-instance

3.3.1.2 The $a = l - 1 \pmod{3l + 1}$ instance (Figure 13) Working over modulus $3l + 1$ with $a = l - 1$, then $2a + 1 = 2(l - 1) + 1 = 2l - 1$, $2a + 2 = 2l$ and $4a + 4 = 4l = 3l + 1 + l - 1 = l - 1$. Remarking that $l \geq 4$, figure 13 should now be self-explanatory.

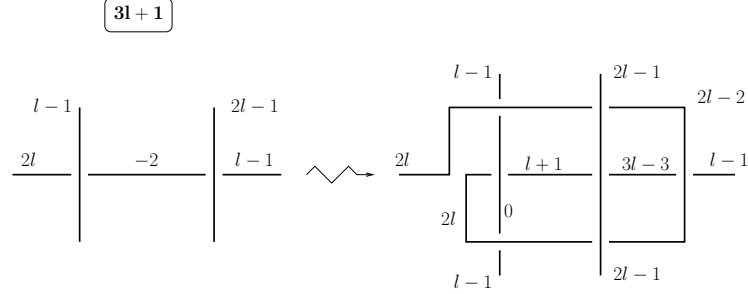

Figure 13: Removing color $2k - 1$ from an under-arc: the $b = 2a + 1$ with $a = l - 1$ sub-instance

$l+1=3l$	$l+1=3l-1$	$3l-3=3l$	$3l-3=3l-1$
$l+1(\leq 2l)<3l$ X	$l=1$ X	$3=0$ X	$2=0$ X

Table 3.6: Equalities which should not occur in Figure 13 (1st row) and their consequences (2nd row). X's stand for conflicts with assumptions thus not requiring further considerations.

3.3.1.3 The $a = 2l \pmod{3l + 2}$ instance (Figure 14) Working over modulus $3l + 2$ with $a = 2l$, then $2a + 1 = 2(2l) + 1 = 4l + 1 = 3l + 2 + l - 1 = l - 1$, $2a + 2 = l$, and $4a + 4 = 2l$. $l \geq 3$ and Figure 14 should now be self-explanatory.

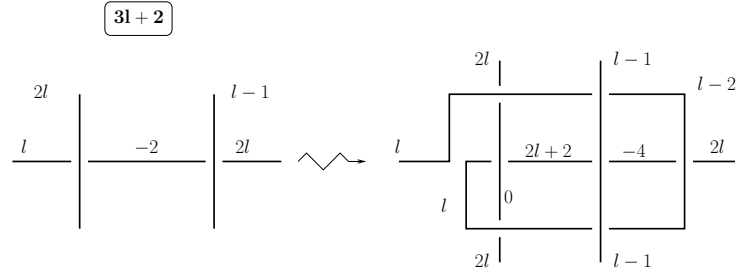

Figure 14: Removing color $2k - 1$ from an under-arc: the $b = 2a + 1$ with $a = 2l$ sub-instance

$2l+2=3l+1$	$2l+2=3l$
$l=1$ X	$l=2$ X

Table 3.7: Equalities which should not occur in Figure 14 (1st row) and their consequences (2nd row). X's stand for conflicts with assumptions thus not requiring further considerations.

3.3.2 The $b = 2a + 2$ instance (Figure 15).

View Figure 15.

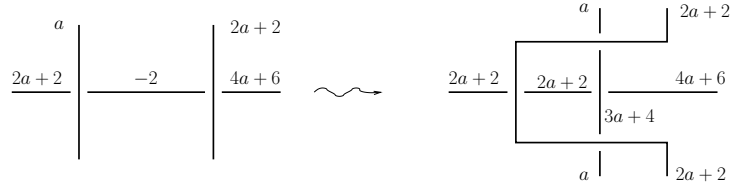

Figure 15: Removing color $2k - 1$ from an under-arc: the $b = 2a + 2$ instance

$3a+4 = 2k$	$3a+4=2k-1$
$a=3l+1$ or $a=3l+2$	$a=-2$ X

Table 3.8: Equalities which should not occur in Figure 15 (1st row) and their consequences (2nd row). X's stand for conflicts with assumptions thus not requiring further considerations. The other situations are dealt with below in 3.3.2.1, and 3.3.2.2

3.3.2.1 The $b = 2a + 2$ with $a = 2l - 1 \pmod{3l + 1}$ instance (Figure 16) Working over modulus $3l + 1$ with $a = 2l - 1$, then $2a + 2 = 2(2l - 1) + 2 = 4l = 3l + 1 + l - 1 = l - 1$ and $4a + 6 = 2l$

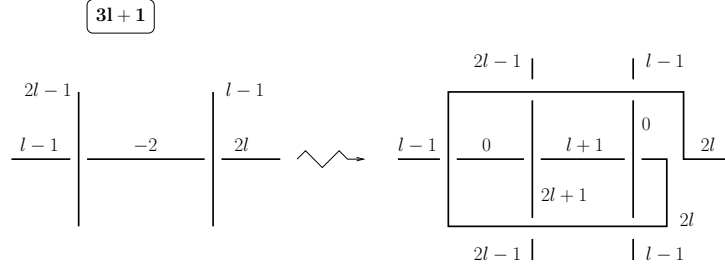

Figure 16: Removing color $2k - 1$ from an under-arc: the $b = 2a + 2$ with $a = 2l - 1$ sub-instance

$1+1=3l$	$1+1=3l-1$	$2l+1=3l$	$2l+1=3l-1$
$1+1(\leq 2l) < 3l$ X	$1=1$ X	$1=1$ X	$1=2$ X

Table 3.9: Equalities which should not occur in Figure 16 (1st row) and their consequences (2nd row). X's stand for conflicts with assumptions thus not requiring further considerations.

3.3.2.2 The $b = 2a + 2$ with $a = l - 1 \pmod{3l + 2}$ instance (Figure 17) Working over modulus $3l + 2$ with $a = l - 1$, then $2a + 2 = 2(l - 1) + 2 = 2l$ and $4a + 6 = 4(l - 1) + 6 = 4l + 2 = 3l + 2 + l = l$

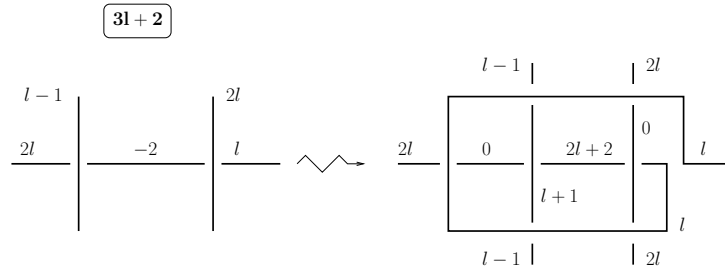

Figure 17: Removing color $2k - 1$ from an under-arc: the $b = 2a + 2$ with $a = l - 1$ sub-instance

$l+1=3l+1$	$l+1=3l$	$2l+2=3l+1$	$2l+2=3l$
$l=0$ or $2=0$ X	$l+1(\leq 2l)<3l$ X	$l=1$ X	$l=2$ X

Table 3.10: Equalities which should not occur in Figure 17 (1st row) and their consequences (2nd row). X's stand for conflicts with assumptions thus not requiring further considerations.

3.3.3 The $b = a + k$ instance (Figure 18).

View Figure 18.

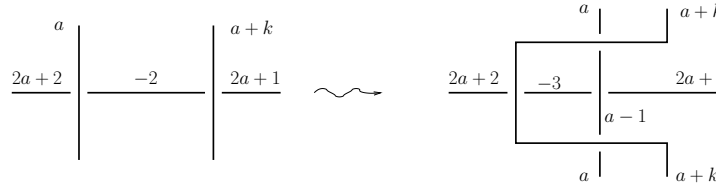

Figure 18: Removing color $2k - 1$ from an under-arc: the $b = a + k$ instance. The $a = 0$ situation has been contemplated in Figure 12; $a - 1 = -2$ conflicts with the assumption $a \neq -1$.

3.3.4 The $b = a$ instance (Figure 19).

View Figure 19.

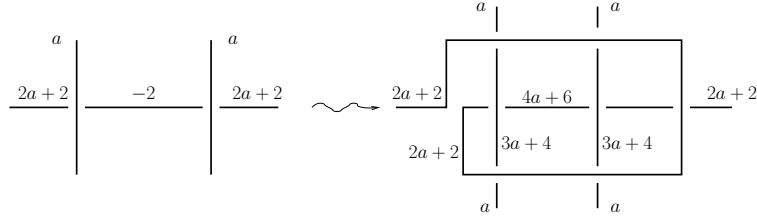

Figure 19: Removing color $2k - 1$ from an under-arc: the $b = a$ instance

$4a+6=2k$	$4a+6=2k-1$	$3a+4=2k$	$3a+4=2k-1$
$a=4l+1$ or $a=4l+3$	$a=-2$ X	$a=3l+1$ or $a=3l+2$	$a=-2$ X

Table 3.11: Equalities which should not occur in Figure 19 (1st row) and their consequences (2nd row). X's stand for conflicts with assumptions thus not requiring further considerations. The other situations are dealt with below in 3.3.4.1 and in 3.3.4.2.

3.3.4.1 The $b = a$ with $a = 3l - 1 \pmod{4l + 1}$ instance (Figure 20). With $a = 3l - 1 \pmod{4l + 1}$, $2a + 2 = 6l = 4l + 1 + 2l - 1 = 2l - 1$. Noting that $l \geq 4$, Figure 20 is self-explanatory.

3.3.4.2 The $b = a$ with $a = l - 1 \pmod{4l + 3}$ instance (Figure 21). With $a = l - 1 \pmod{4l + 3}$, $2a + 2 = 2l$.

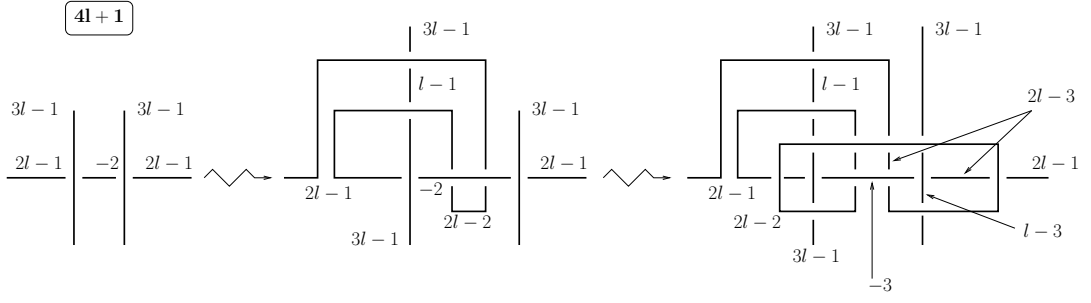

Figure 20: Removing color $2k - 1$ from an under-arc: the $b = a$ with $a = 3l - 1$ sub-instance

$l-3=-1$	$l-3=-2$	$l-1=-1$	$l-1=4l-1$	$2l-3=-1$	$2l-3=4l-1$	$2l-2=4l$	$2l-2=-2$
$l=2$ X	$l=1$ X	$l=0$ X	$l=0$ or $3=0$ X	$l=1$ X	$2l-3(<3l-2)<4l-1$ X	$2l-1(<3l)<4l$ X	$l=0$ or $2=0$ X

Table 3.12: Equalities which should not occur in Figure 20 (1st row) and their consequences (2nd row). X's stand for conflicts with assumptions thus not requiring further considerations.

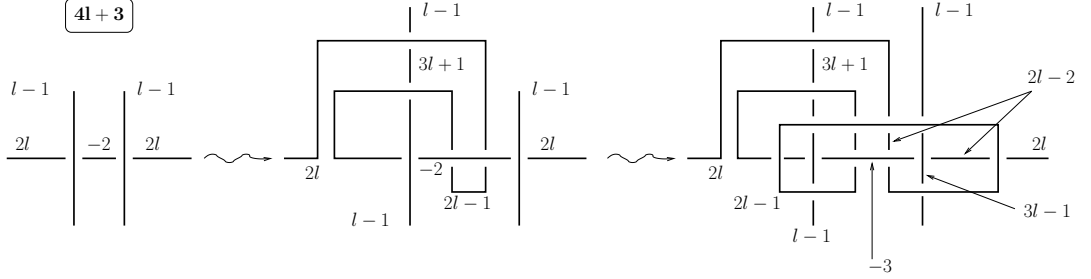

Figure 21: Removing color $2k - 1$ from an under-arc: the $b = a$ with $a = l - 1$ sub-instance

$2l-2=-1$	$2l-2=-2$	$2l-1=-1$	$2l-1=-2$	$3l-1=-1$	$3l-1=-2$	$3l+1=-1$	$3l+1=-2$
$2l-2(<3l)<4l+2$ X	$l=0$ X	$l=0$ X	$2l-1(<3l)<4l+1$ X	$l=0$ X	$3l-1<4l+1$ X	$3l+1<4l+2$ X	$l=0$ X

Table 3.13: Equalities which should not occur in Figure 21 (1st row) and their consequences (2nd row). X's stand for conflicts with assumptions thus not requiring further considerations.

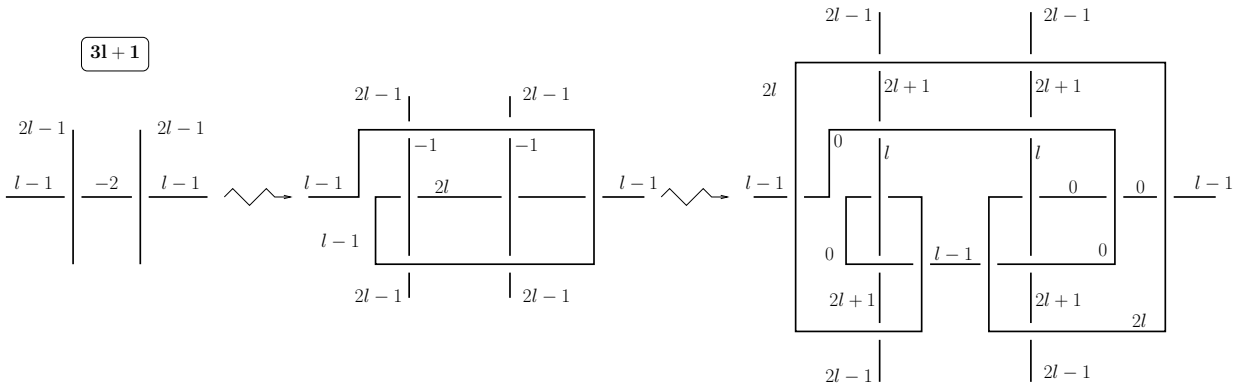

Figure 22: Removing color $2k - 1$ from an under-arc: the $b = a$ with $a = 2l - 1$ sub-instance

3.3.4.3 The $b = a$ with $a = 2l - 1 \pmod{3l + 1}$ instance (Figure 22). With $a = 2l - 1 \pmod{3l + 1}$, $2a + 2 = 4l = l - 1$.

$l=-1$	$l=-2$	$2l+1=-1$	$2l+1=-2$
$l=0$ or $2=0$ X	$l(<2l)<3l-1$ X	$l=1$ X	$l=2$ X

Table 3.14: Equalities which should not occur in Figure 22 (1st row) and their consequences (2nd row). X's stand for conflicts with assumptions thus not requiring further considerations.

3.3.4.4 The $b = a$ with $a = l - 1 \pmod{3l + 2}$ instance (Figure 23). With $a = l - 1 \pmod{3l + 2}$, $2a + 2 = 2l$.

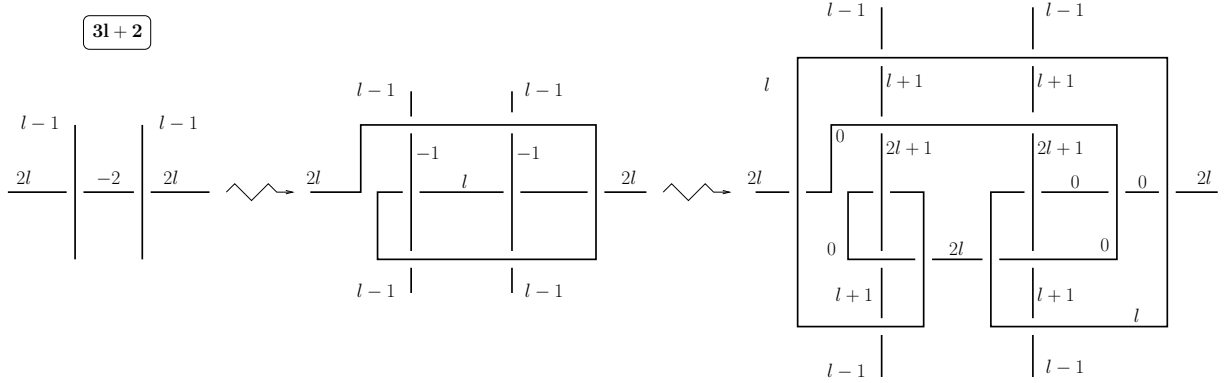

Figure 23: Removing color $2k - 1$ from an under-arc: the $b = a$ with $a = l - 1$ sub-instance

$l=-1$	$l=-2$	$l+1=-1$	$l+1=-2$	$2l+1=-1$	$2l+1=-2$
$l<3l+1$ X	$l<3l$ X	$l=0$ or $2=0$ X	$l+1(\leq 2l)<3l$ X	$l=0$ X	$l=1$ X

Table 3.15: Equalities which should not occur in Figure 23 (1st row) and their consequences (2nd row). X's stand for conflicts with assumptions thus not requiring further considerations.

This completes the proof that colors $2k - 1$ and $2k$ can be removed from a non-trivial $2k + 1$ -coloring.

4 Removal of color k provided colors $2k$ and $2k - 1$ have been removed

4.1 Removal of Color k from a Monochromatic Crossing

View Figure 24.

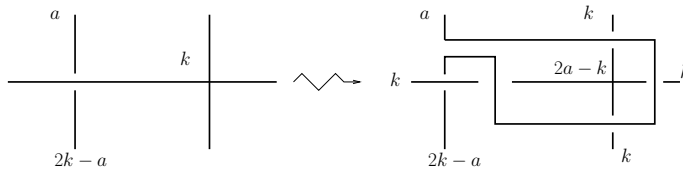

Figure 24: Removing color k from a monochromatic crossing (1st instance).

4.2 Removal of Color k from an Over-Arc

View Figure 26.

$2a-k = -1$	$2a-k=-2$	$2a-k=k$
$2a=k-1$	$2a=k-2$	$a=k$ X

Table 4.1: Equalities which should not occur in Figure 24 (1st row) and their consequences (2nd row). X's stand for conflicts with assumptions thus not requiring further considerations.

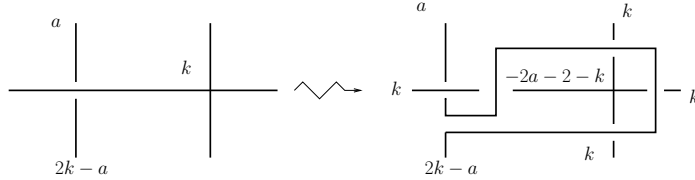

Figure 25: Removing color k from a monochromatic crossing (2nd instance).

$2a-k = -1$	$2a-k=-2$
$-2a-2-k=0$ V	$-2a-2-k=1$ V

Table 4.2: Equalities which should not occur in Figure 24 (1st row) and their consequences in Figure 25 (2nd row). V's stand for "admissible value" thus not requiring further considerations. Note the different reasoning here.

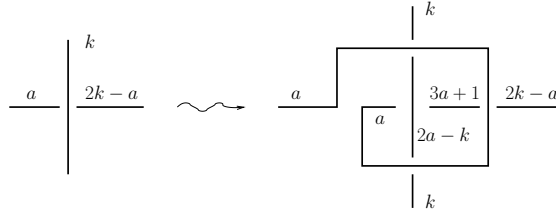

Figure 26: Removing color k from an over-arc.

$2a-k=-1$	$2a-k=-2$	$2a-k=k$	$3a+1=-1$	$3a+1=-2$	$3a+1=k$
$a=4l+13l$ or $a=4l+3l$	$a=4l+1l-1$ or $a=4l+3l+1$	$a=k$ X	$a=3l+12l$ or $a=3l+2l$	$a=-1$ X	$a=k$ X

Table 4.3: Equalities which should not occur in Figure 26 (1st row) and their consequences (2nd row). X's stand for conflicts with assumptions thus not requiring further considerations. The other situations are dealt with in 4.2.1.1, 4.2.1.2, 4.2.2.1, and in 4.2.2.2.

4.2.1 The $2a = k - 1$ instance.

4.2.1.1 The $k = 2l$ and $a = 3l, \text{ mod } 4l + 1$ sub-instance. View Figure 27.

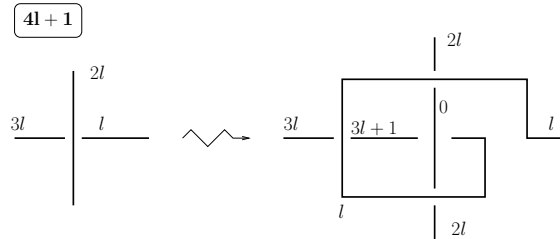

Figure 27: Removing color k from an over-arc. The $2a = k - 1$ with $k = 4l+1 2l$ sub-instance; ($k = 2l < a = 3l < 4l$)

$3l+1=4l$	$3l+1=4l-1$	X
$l=1$	$l=2$	X

Table 4.4: Equalities which should not occur in Figure 27 (1st row) and their consequences (2nd row). X's stand for conflicts with assumptions thus not requiring further considerations.

4.2.1.2 The $k = 2l + 1$ and $a = l$, mod $4l + 3$ sub-instance. View Figure 28.

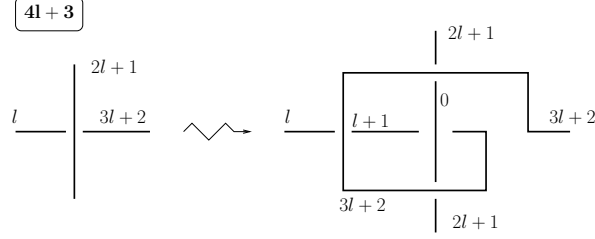

Figure 28: Removing color k from an over-arc. The $2a = k - 1$ with $k =_{4l+3} 2l + 1$ sub-instance; $(0 <)a = l (< k = 2l + 1 < 4l + 1 < 4l + 2)$.

$0 < l + 1 < 2l + 1 < 3l + 1 < 4l + 1 < 4l + 2$

Table 4.5: $l + 1$ can only take on admissible values, in Figure 28.

4.2.2 The $2a = k - 2$ instance.

4.2.2.1 The $k = 2l$ and $a = l - 1$, mod $4l + 1$ sub-instance. View Figure 29.

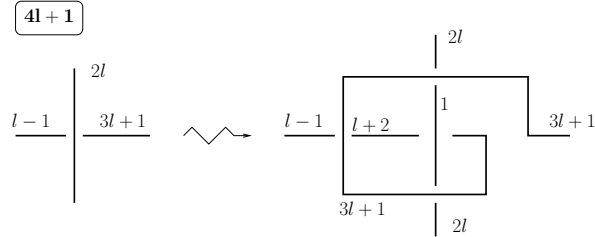

Figure 29: Removing color k from an over-arc. The $2a = k - 2$ with $k =_{4l+1} 2l$ sub-instance; $a = l - 1 (< k = 2l < 4l - 1 < 4l)$.

$l+2 = 2l$	$l+2 = 4l-1$	$l+2 = 4l$
$4l+1 = 9$	$4l+1 = 5$	$3l=2$
X	X	X

Table 4.6: $l + 2$ can only take on admissible values, in Figure 29.

4.2.2.2 The $k = 2l + 1$ and $a = 3l + 1$, mod $4l + 3$ sub-instance. . View Figure 30.

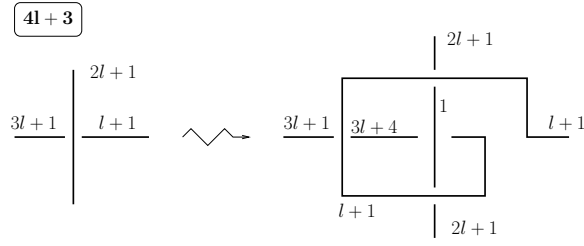

Figure 30: Removing color k from an over-arc. The $2a = k - 2$ with $k =_{4l+3} 2l + 1$ sub-instance; ($k = 2l + 1 < a = 3l + 1 < 4l + 1 < 4l + 2$).

$2l + 1 < 3l + 4$	$3l+4=4l+1$	$3l+4=4l+2$ X
$2l + 1 < 3l + 4$ X	$4l+3=15$ X	$l=2$ and $4l+3=11$

Table 4.7: Equalities which should not occur in Figure 30 (1st row) and their consequences (2nd row). X's stand for conflicts with assumptions thus not requiring further considerations.

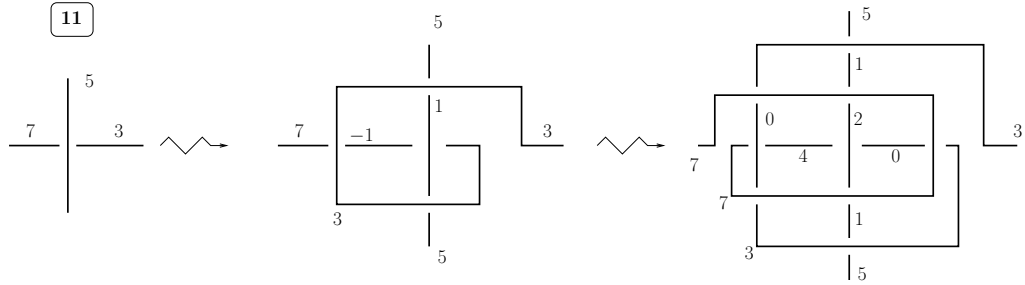

Figure 31: Removing color $k = 5 \pmod{11}$ from an over-arc. The $2a = k - 2$ with $k =_{4l+3} 2l + 1$ and $l = 2$ sub-sub-instance.

- The $l = 2$ sub-instance. View Figure 31

4.2.3 The $3a = -2$ instance.

4.2.3.1 The $k = 3l$ and $a = 4l \pmod{6l + 1}$ sub-instance. View Figure 32.

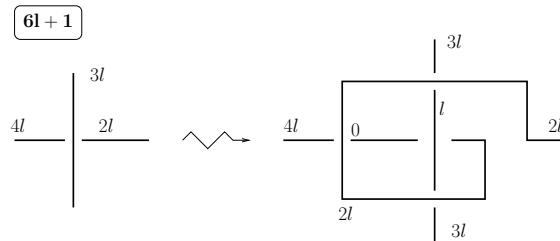

Figure 32: Removing color k from an over-arc. The $3a = -2$ with $k =_{6l+1} 3l$ sub-instance; ($k = 3l < a = 4l < 6l - 1 < 6l$).

4.2.3.2 The $k = 3l + 2$ and $a = 2l + 1, \pmod{6l + 5}$ sub-instance. View Figure 33.

$$l < 3l < 6l - 1 < 6l$$

Table 4.8: l can only take on admissible values, in Figure 32.

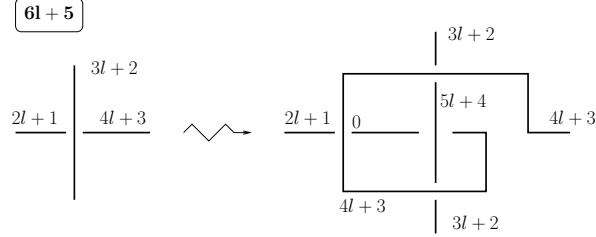

Figure 33: Removing color k from an over-arc. The $3a = -2$ with $k =_{6l+5} 3l + 2$ sub-instance; $a = 2l + 1 (< k = 3l + 2 < 6l + 3 < 6l + 4)$.

$3l+2 < 5l+4$	$5l+4 = 6l+3$	$5l+4 < 6l+4$
$3l+2 < 5l+4$ X	$6l+5=11$	$5l+4 < 6l+4$ X

Table 4.9: Equalities which should not occur in Figure 33 (1st row) and their consequences (2nd row). The $6l + 5 = 11$ ($l = 1$) instance is solved in Figure 31.

4.3 Removal of Color k from an Under-Arc

View Figure 34.

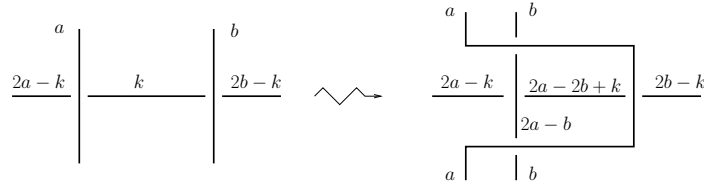

Figure 34: Removing color k from an under-arc

$2a-b=-1$	$2a-b=-2$	$2a-b=k$	$2a-2b+k=-1$	$2a-2b+k=-2$	$2a-2b+k=k$
$b=2a+1$	$b=2a+2$	$b=2a-k$	$b=_{4l+1}a+3l+1$ or $b=_{4l+3}a+1+1$	$b=_{4l+1}a+1+1$ or $b=_{4l+3}a+3l+3$	$b=a$

Table 4.10: Equalities which should not occur in Figure 34 (1st row) and their consequences (2nd row). X 's stand for conflicts with assumptions thus not requiring further considerations. The other instances are dealt with in 4.3.1, 4.3.2, 4.3.3, 4.3.4, 4.3.5, 4.3.6

4.3.1 The $b = 2a + 1$ instance

View Figure 35.

$2a+2+k=-1$	$2a+2+k=-2$	$2a+2+k=k$	$3a+2=-1$	$3a+2=-2$	$3a+2=k$
$2a-k=-2$ X	$a=_{4l+1}3l-1$ or $a=_{4l+3}l-1$	$a=-1$ X	$a=-1$ X	$a=_{3l+1}l-1$ or $a=_{3l+2}2l$	$a=_{6l+1}5l$ or $a=_{6l+5}l$

Table 4.11: Equalities which should not occur in Figure 35 (1st row) and their consequences (2nd row). X 's stand for conflicts with assumptions thus not requiring further considerations. The other instances are dealt with in 4.3.1.1, 4.3.1.2, 4.3.1.3, 4.3.1.4, 4.3.1.5, and 4.3.1.7.

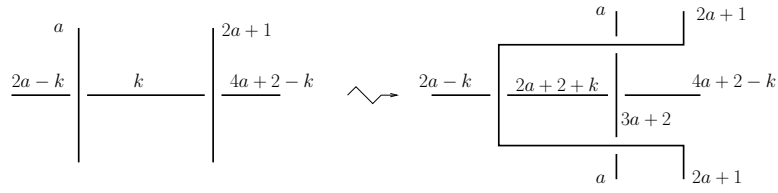

Figure 35: Removing color k from an under-arc: the $b = 2a + 1$ instance

4.3.1.1 The $b = 2a + 1$, $2a = k - 3$; $k = 2l$, $a = 3l - 1$, mod $4l + 1$ sub-instance View Figure 36.

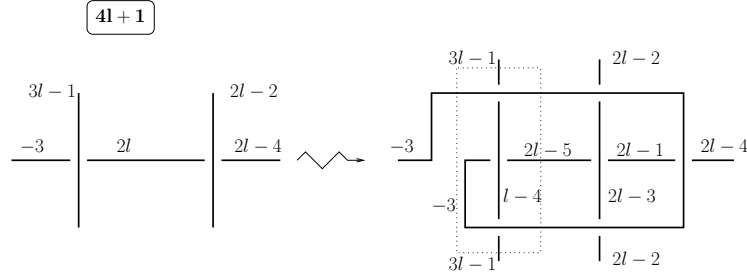

Figure 36: Removing color k from an under-arc: the $b = 2a + 1$, $2a = k - 3$; $k = 2l$, $a = 3l - 1$, mod $4l + 1$ sub-instance. Note that $k(= 2l) \leq a(= 3l - 1) < 4l - 1 < 4l$

$l-4 = 2l$	$l-4 = -1$	$l-4 = -2$	$2l-5 = 2l$	$2l-5 = -1$	$2l-5 = -2$	$2l-3 = 2l$	$2l-3 = -1$	$2l-3 = -2$	$2l-1 = 2l$	$2l-1 = -1 = 0$	$2l-1 = -2$
$l-4 < 2l$ X	$l = 3$	$4l+1 = 9$ X	$2l-5 < 2l$	$4l+1 = 9$ X	$2l = 3$ X	$2l-3 < 2l$ X	$4l+1 = 5$ X	$2l = 1$ X	$2l-1 < 2l$ X	X	$2l = -1$ X

Table 4.12: Equalities which should not occur in Figure 36 (1st row) and their consequences (2nd row). An inequality in the second row stands for an obvious statement which contradicts the equality above it. X's stand for conflicts with assumptions thus not requiring further considerations. The region boxed by the dotted lines contains a forbidden color for $l = 3$ which is dealt with in Figure 37

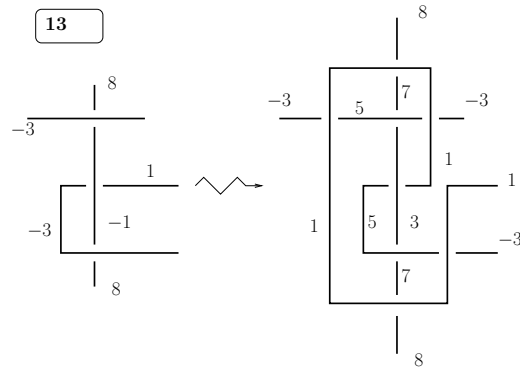

Figure 37: Removing color k from an under-arc: the $b = 2a + 1$, $2a = k - 3$; $k = 2l$, $a = 3l - 1$, mod $4l + 1$ sub-instance: fixing the boxed region in Figure 36 for $l = 3$.

4.3.1.2 The $b = 2a + 1$, $2a = k - 3$; $k = 2l + 1$, $a = l - 1$ mod $4l + 3$ sub-instance. View Figure 38.

4.3.1.3 The $b = 2a + 1$, $3a = k - 2$; $k = 3l$, $a = 5l$ mod $6l + 1$ sub-instance. View Figure 39.

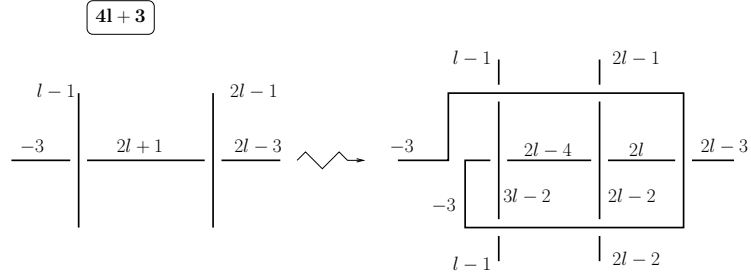

Figure 38: Removing color k from an under-arc: the $b = 2a + 1$, $2a = k - 3$; $k = 2l + 1$, $a = l - 1 \pmod{4l + 3}$ sub-instance. Note that $a(= l - 1) < k(= 2l + 1) < 4l + 1 < 4l + 2$

$$\boxed{2l - 4 < 2l - 2 < 2l < k(= 2l + 1) \leq 3l - 2 < 4l + 1 < 4l + 2}$$

Table 4.13: $l \geq 2$. The equality $2l + 1 \leq 3l - 2$ implies $4l + 3 = 15$ which conflicts with the assumptions. There are no further considerations to be made about Figure 38.

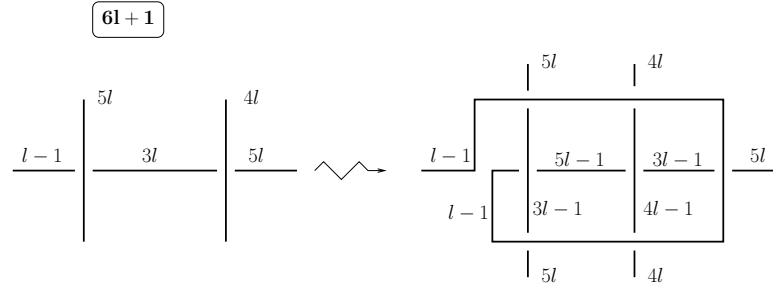

Figure 39: Removing color k from an under-arc: the $b = 2a + 1$, $3a = k - 2$; $k = 3l$, $a = 5l \pmod{6l + 1}$ sub-instance. ($k = 3l < a(= 5l) \leq 6l - 1 < 6l$).

$$\boxed{3l - 1 < k(= 3l) \leq 4l - 1 < 5l - 1 < 6l - 1 < 6l}$$

Table 4.14: The equality $3l = 4l - 1$ leads to $6l + 1 = 7$ which conflicts with the assumptions. There are no further considerations to be made about Figure 39.

4.3.1.4 The $b = 2a + 1$, $3a = k - 2$; $k = 3l + 2$, $a = l \pmod{6l + 5}$ sub-instance View Figure 40.

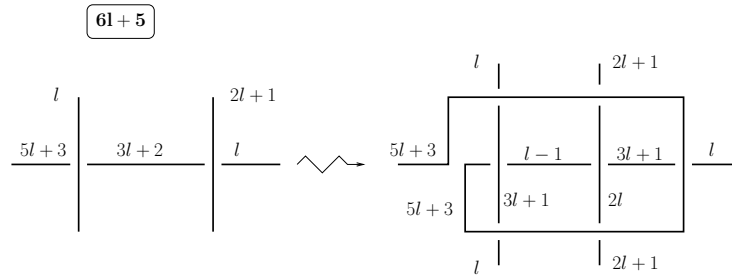

Figure 40: Removing color k from an under-arc: the $b = 2a + 1$, $3a = k - 2$, $k = 3l$ sub-instance. $a = l (< k = 3l + 2 < 6l + 3 < 6l + 4)$.

4.3.1.5 The $b = 2a + 1$, $3a = -4$; $k = 3l$, $a = 2l - 1 \pmod{6l + 1}$ sub-instance View Figure 41.

$$\boxed{l-1 < 2l < 3l+1 < k(=3l+2) < 6l+3 < 6l+4}$$

Table 4.15: $l \geq 1$ and there are no further considerations to be made about Figure 40.

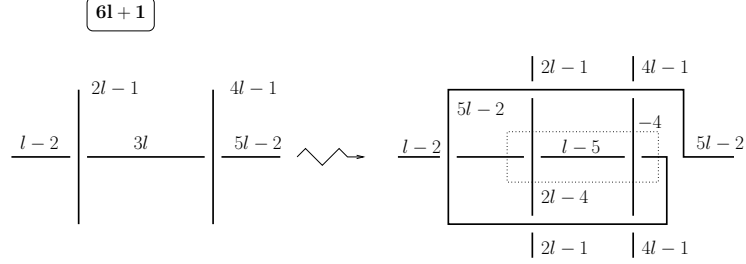

Figure 41: Removing color k from an under-arc: the $b = 2a + 1$, $3a = k - 2$, $k = 3l$ sub-instance. $a = 2l - 1 (< k = 3l < 6l - 1 < 6l)$. The boxed region is fixed in Figure 42 for $l = 3$.

$$\boxed{l-5 < 2l-4 < 3l-3 < k(=3l)}$$

Table 4.16: $l \geq 2$ and the equality $l - 5 = -1$ leads to an inconsistency whereas $l - 5 = -2$ leads to the $l = 3$ instance which is dealt with in Figure 44. Nothing else gives rise to further considerations on Figure 41.

4.3.1.6 The $b = 2a + 1$, $3a = -4$, $k = 3l$, $l = 3$ sub-instance View Figure 42.

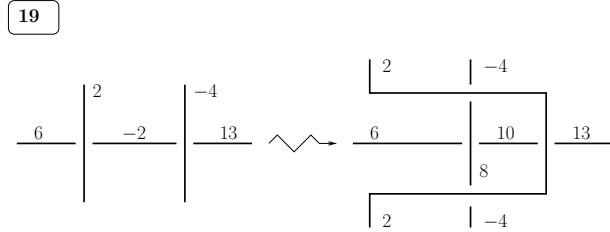

Figure 42: Removing color k from an under-arc: the $b = 2a + 1$, $3a = k - 2$, $k = 3l$ sub-instance: fixing the boxed region in Figure 41 for $l = 3$.

4.3.1.7 The $b = 2a + 1$, $3a = k - 2$; $k = 3l + 2$, $a = 4l + 2 \pmod{6l + 5}$ sub-instance View Figure 43.

$$\boxed{l-3 < 2l-1 < 3l+1 < k(=3l+2) < 6l+3 < 6l+4}$$

Table 4.17: $l \geq 1$ and the equality $l - 3 = -2$ leads to an inconsistency $l - 2 = -1$, whereas $l - 3 = -1$ leads to the $l = 2$ instance which is dealt with in Figure 44. Nothing else gives rise to further considerations on Figure 43.

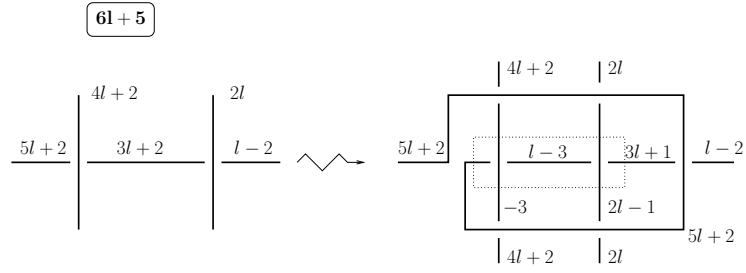

Figure 43: Removing color k from an under-arc: the $b = 2a + 1$, $3a = k - 2$; $k = 3l + 2$ $a = 4l + 2 \pmod{6l + 5}$ sub-instance. ($k = 3l + 2 < a = 4l + 2 < 6l + 3 < 6l + 4$). The boxed region is fixed in Figure 44 for $l = 2$.

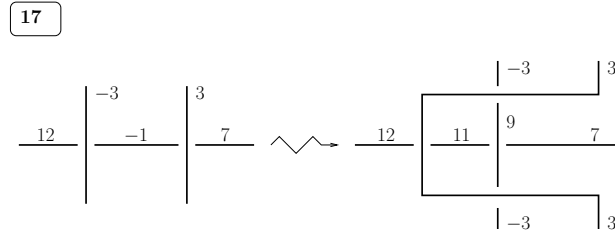

Figure 44: Removing color k from an under-arc: the $b = 2a + 1$, $3a = k - 2$; $k = 3l + 2$ $a = 4l + 2 \pmod{6l + 5}$ sub-instance: fixing the boxed region in Figure 43 for $l = 2$.

4.3.2 The $b = 2a + 2$ instance

View Figure 45.

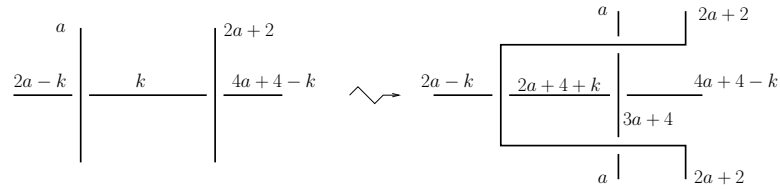

Figure 45: Removing color k from an under-arc: the $b = 2a + 2$ instance

$2a+4+k=-1$	$2a+4+k=-2$	$2a+4+k=k$	$3a+4=-1$	$3a+4=-2$	$3a+4=k(=3k+1)$
$a=4l+1$ or $a=4l+3$	$a=4l+1$ or $a=4l+3$	$a=-2$ X	$a=6l+1$ or $a=6l+5$	$a=-2$ X	$2a+2=-1$ X

Table 4.18: Equalities which should not occur in Figure 45 (1st row) and their consequences (2nd row). X's stand for conflicts with assumptions thus not requiring further considerations. The other situations are dealt with in 4.3.2.1, 4.3.2.2, 4.3.2.3, 4.3.2.4, 4.3.2.5, and 4.3.2.6.

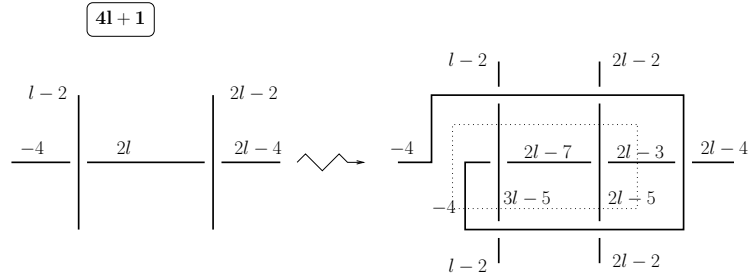

Figure 46: Removing color k from an under-arc: the $b = 2a + 2$, $2a = k - 4$; $k = 2l$, $a = l - 2 \pmod{4l + 1}$ sub-instance. $a = l - 2 (< k = 2l < 4l - 1 < 4l)$.

$$\boxed{l \geq 3 \quad 2l - 7 < 2l - 5 < 2l - 3 < k(= 2l) \leq 3l - 5 < 4l - 1 < 4l}$$

Table 4.19: Consider Figure 46. $l \geq 3$. The equalities $2l - 7 = -1$, and $2l = 3l - 5$ only give rise to further consideration with $l = 3$. This corresponds to the elimination of color $2l - 7 = -1$, for $l = 3$, in the boxed region in Figure 46 and is dealt with in Figure 47.

4.3.2.1 The $b = 2a + 2$, $2a = k - 4$; $k = 2l$, $a = l - 2 \pmod{4l + 1}$ sub-instance View Figure 46.

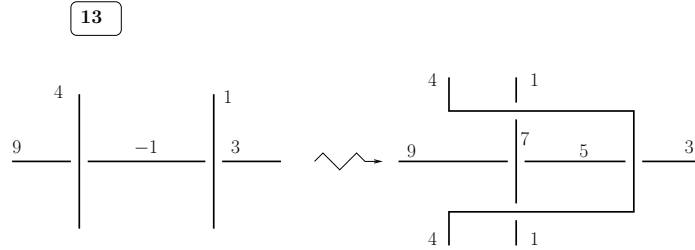

Figure 47: Removing color k from an under-arc: the $b = 2a + 2$, $2a = k - 4$, $k = 2l$ sub-instance: fixing the boxed region in Figure 46 for $l = 3$.

4.3.2.2 The $b = 2a + 2$, $2a = k - 4$; $k = 2l + 1$, $a = 3l \pmod{4l + 3}$ sub-instance. View Figure 48.

$$\boxed{l \geq 2 \quad l - 5 \leq 2l - 6 < 2l - 4 < 2l - 2 < k(= 2l + 1) < 4l + 1 < 4l + 2}$$

Table 4.20: Consider Figure 48. $l \geq 2$. The equalities $l - 5 = 2l - 6$, $l - 5 = -1$, $l - 5 = -2$, $2l - 6 = -1$ and $2l - 6 = -2$ only give rise to further considerations for $l = 2$ or $l = 4$. This corresponds to the elimination of color $2l - 6 = -2$, for $l = 2$, in the vertically boxed region in Figure 46 and to the horizontally boxed region in the same Figure. These situations are dealt with in Figures 50 and 49.

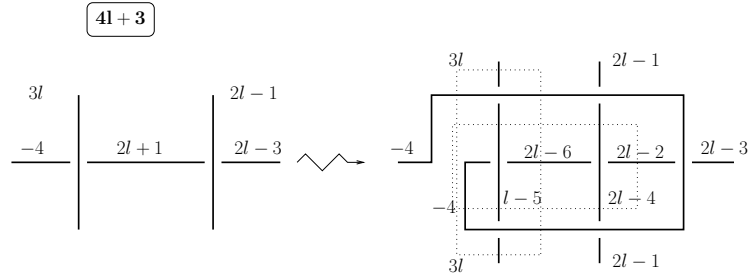

Figure 48: Removing color k from an under-arc: the $b = 2a + 2$, $2a = k - 4$; $k = 2l + 1$ $a = 3l \pmod{4l + 3}$ sub-instance. $a = 3l (< 4l + 1 < 4l + 2)$. The vertically boxed region is fixed for $l = 4$ in Figure 50 and the horizontally boxed region is fixed for $l = 2$ in Figure 49

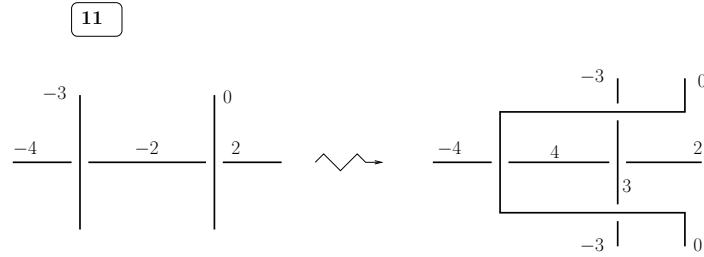

Figure 49: Removing color k from an under-arc: the $b = 2a + 2$, $2a = k - 4$; $k = 2l + 1$ $a = 3l \pmod{4l + 3}$ sub-instance. Fixing the horizontally boxed region for $l = 2$ in Figure 48

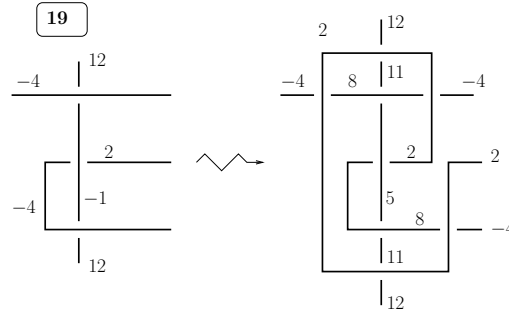

Figure 50: Removing color k from an under-arc: the $b = 2a + 2$, $2a = k - 4$; $k = 2l + 1$ $a = 3l \pmod{4l + 3}$ sub-instance. Fixing the vertically boxed region for $l = 4$ in Figure 48

4.3.2.3 The $b = 2a + 2$, $2a = k - 5$; $k = 2l$, $a = 3l - 2 \pmod{4l + 1}$ sub-instance View Figure 51.

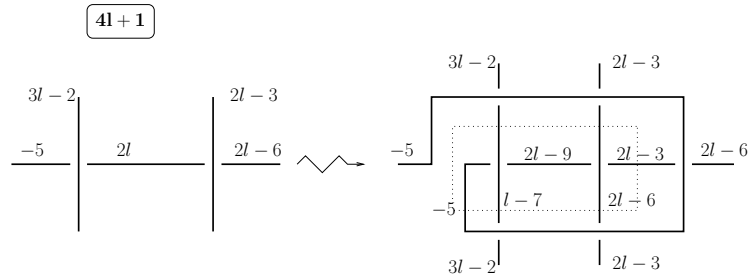

Figure 51: Removing color k from an under-arc: the $b = 2a + 2$, $2a = k - 5$; $k = 2l$ $a = 3l - 2 \pmod{4l + 1}$ sub-instance. $a = 3l - 2 (< 4l - 1 < 4l)$.

$$\boxed{l \geq 2 \quad l - 7 \leq 2l - 9 < k(= 2l) < 4l - 1 < 4l}$$

Table 4.21: Consider Figure 51. $l \geq 2$. The equalities $l - 7 = 2l - 9$, $l - 7 = -1$, $l - 7 = -2$, $2l - 9 = -1$, and $2l - 9 = -2$ only give rise to further considerations for $l = 4$. This corresponds to the elimination of color $2l - 9 = -1$, for $l = 4$, in the boxed region in Figure 51. This situation is dealt with in Figure 52.

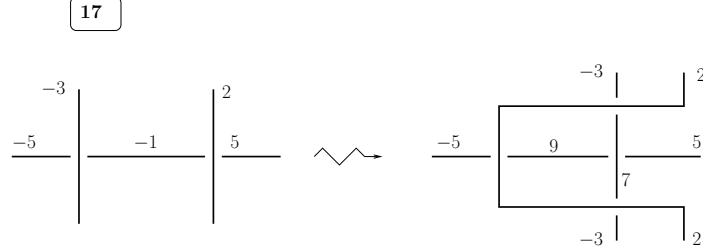

Figure 52: Removing color k from an under-arc: the $b = 2a + 2$, $2a = k - 5$; $k = 2l$, $a = 3l - 2 \pmod{4l + 1}$ sub-instance: fixing the boxed region in Figure 51 for $l = 4$.

4.3.2.4 The $b = 2a + 2$, $2a = k - 5$; $k = 2l + 1$, $a = l - 2 \pmod{4l + 3}$ sub-instance. View Figure 53.

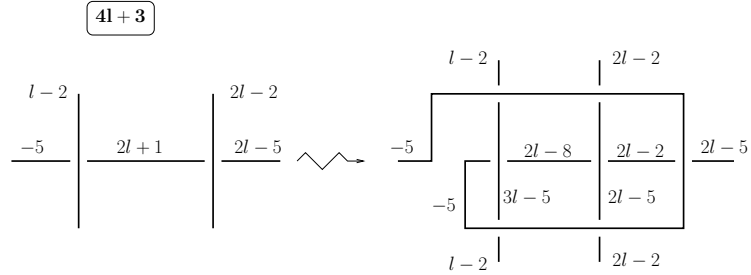

Figure 53: Removing color k from an under-arc: the $b = 2a + 2$, $2a = k - 4$; $k = 2l + 1$, $a = l - 2 \pmod{4l + 3}$ sub-instance. $a = l - 2 (< k = 2l + 1 < 4l + 1 < 4l + 2)$.

$$\boxed{2l - 8 < k(= 2l + 1) \leq 3l - 5 < 4l + 1 < 4l + 2}$$

Table 4.22: Consider Figure 53. $l \geq 2$. The equalities $2l + 1 = 3l - 5$, $2l - 8 = -1$, and $2l - 8 = -2$ do not give rise to further considerations.

4.3.2.5 The $b = 2a + 2$, $3a = -5$; $k = 3l$, $a = 4l - 1 \pmod{6l + 1}$ sub-instance View Figure 54.

4.3.2.6 The $b = 2a + 2$, $3a = -5$; $k = 3l + 2$, $a = 2l \pmod{6l + 5}$ sub-instance View Figure 56.

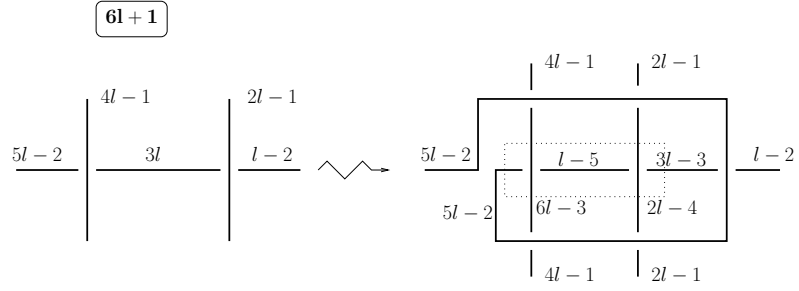

Figure 54: Removing color k from an under-arc: the $b = 2a + 2$, $3a = -5$; $k = 3l$ $a = 4l - 1 \pmod{6l + 1}$ sub-instance. $a = 4l - 1 (< 6l - 1 < 6l)$. The boxed region will be fixed for $l = 3$ in Figure 55.

$$l \geq 2 \quad l - 5 < 2l - 4 < 3l - 3 < k(= 3l) \leq 6l - 3 < 6l - 1 < 6l$$

Table 4.23: Consider Figure 54. $l \geq 2$. The equalities $6l - 5 = 3l$, $l - 5 = -1$, and $l - 5 = -2$ only give rise to further consideration with $l = 3$. This corresponds to the the elimination of color $l - 5 = -2$, for $l = 3$, in the boxed region in Figure 54 and is dealt with in Figure 55.

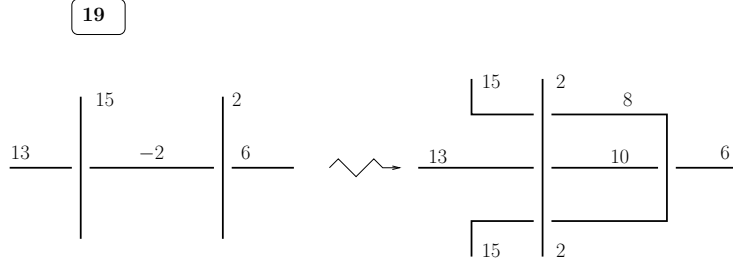

Figure 55: Removing color k from an under-arc: the $b = 2a + 2$, $3a = -5$; $k = 3l$ $a = 4l - 1 \pmod{6l + 1}$ sub-instance. $a = 4l - 1 (< 6l - 1 < 6l)$. Fixing the boxed region in Figure 54 for $l = 3$.

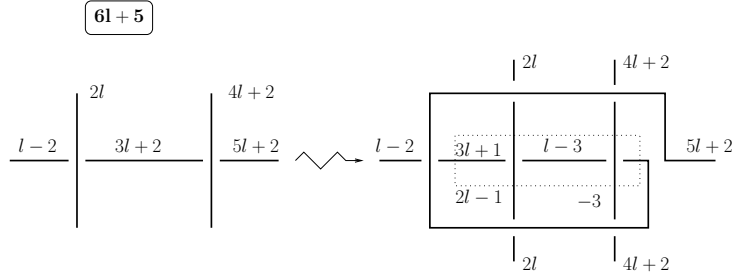

Figure 56: Removing color k from an under-arc: the $b = 2a + 2$, $3a = -5$; $k = 3l + 2$, $a = 2l \pmod{6l + 5}$ sub-instance. $a = 2l (< k = 3l + 2 < 6l + 3 < 6l + 4)$. The boxed region will be fixed for $l = 2$ in Figure 57.

$$l \geq 1 \quad l - 3 < 2l - 1 < 3l + 1 < k(= 3l + 2) < 6l + 3 < 6l + 4$$

Table 4.24: Consider Figure 56. $l \geq 1$. The equalities $l - 3 = -1$, and $l - 3 = -2$ only give rise to further consideration with $l = 2$. This corresponds to the boxed region in Figure 56 and is dealt with in Figure 57.

4.3.3 The $b = 2a - k$ instance

View Figure 58.

17

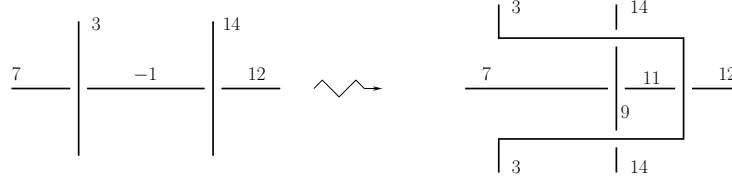

Figure 57: Removing color k from an under-arc: the $b = 2a + 2$, $3a = -5$; $k = 3l + 2$, $a = 2l \pmod{6l + 5}$ sub-instance. $a = 2l (< k = 3l + 2 < 6l + 3 < 6l + 4)$. Fixing the boxed region for $l = 2$ in Figure 56.

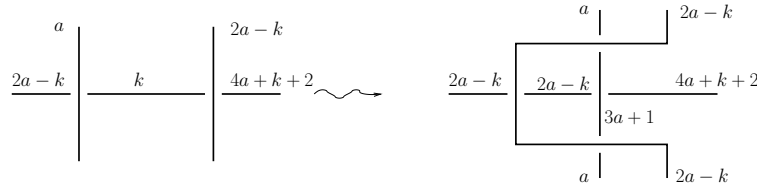

Figure 58: Removing color k from an under-arc: the $b = 2a - k$ instance

$3a+1=-1$	$3a+1=-2$	$3a+1=k(=3k+1)$
$a=6l+14l$ or $a=6l+52l+1$	$a=-1$ X	$a=k$ X

Table 4.25: Equalities which should not occur in Figure 58 (1st row) and their consequences (2nd row). X's stand for conflicts with assumptions thus not requiring further considerations. The other situations are dealt with in Figures 59 and 60.

6l + 1

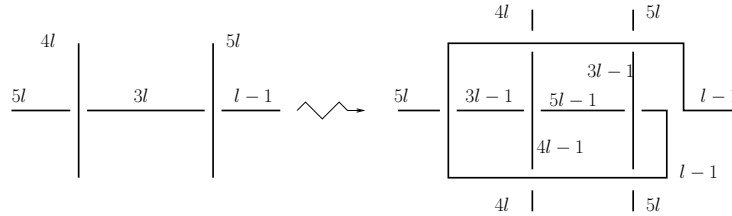

Figure 59: Removing color k from an under-arc: the $b = 2a - k$; $k = 3l$, $a = 4l \pmod{6l + 1}$ instance. ($k = 3l < a = 4l < 6l - 1 < 6l$).

$l \geq 2$	$3l - 1 < k(= 3l) < 4l - 1 < 5l - 1 < 6l - 1 < 6l$
------------	--

Table 4.26: Consider Figure 59. $l \geq 2$. The equality $3l = 4l - 1$ does not give rise to further considerations.

$l \geq 1$	$l - 1 < 2l < 3l + 1 < k(= 3l + 2) < 6l + 3 < 6l + 4$
------------	---

Table 4.27: Consider Figure 60. $l \geq 1$. There are no further considerations to be made here.

4.3.4 The $2a - 2b + k = -1$ instance

4.3.4.1 The $2a - 2b + k = -1$ instance with $k = 2l$ and $b = a + 3l + 1 \pmod{4l + 1}$. View Figure 61.

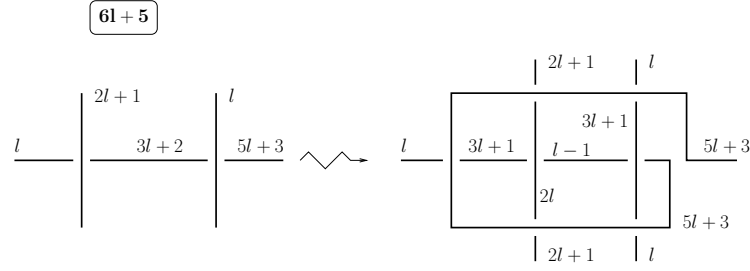

Figure 60: Removing color k from an under-arc: the $b = 2a - k$, $k = 3l + 2$ instance. $a = 2l + 1 (< k = 3l + 2 < 6l + 3 < 6l + 4)$.

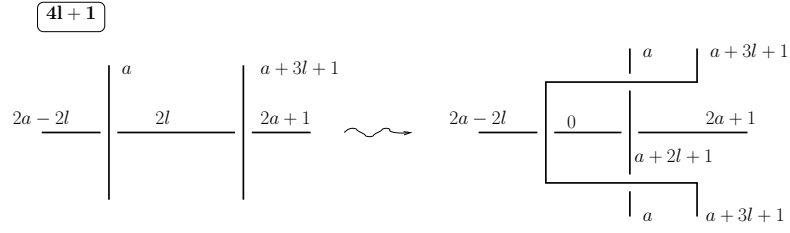

Figure 61: Removing color k from an under-arc: the $2a - 2b + k = -1$ instance with $k = 2l$ and $b = a + 3l + 1 \pmod{4l + 1}$.

$a+2l+1=2l$	$a+2l+1=-1$	$a+2l+1=-2$
$a=-1$ X	$2a+1=4l-1=-2$ X	$a=2l-2$

Table 4.28: Equalities which should not occur in Figure 61 (1st row) and their consequences (2nd row). X's stand for conflicts with assumptions thus not requiring further considerations.

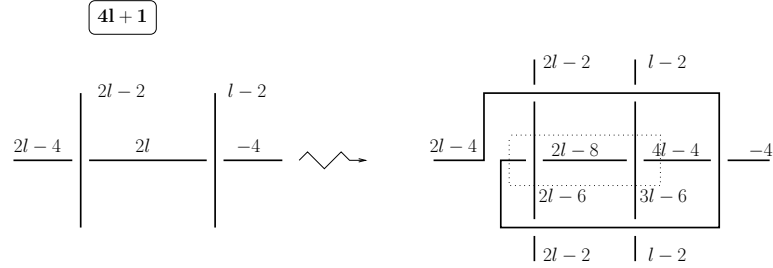

Figure 62: Removing color k from an under-arc: the $2a - 2b + k = -1$ instance with $k = 2l$, $b = a + 3l + 1$ and $a = 2l - 2, \pmod{4l + 1}$. The boxed region will be fixed for $l = 3$ in Figure 60.

$$l \geq 3 \quad 2l - 8 < 2l - 6 < k (= 2l) \leq 3l - 6 < 4l - 4$$

Table 4.29: Consider Figure 62. $l \geq 3$. The equalities $3l - 6 = 2l$, $2l - 8 = -1$, and $2l - 8 = -2$ only give rise to further consideration with $l = 3$. This corresponds to the boxed region in Figure 62 and is dealt with in Figure 63.

4.3.4.2 The $2a - 2b + k = -1$ instance with $k = 2l + 1$ and $b = a + l + 1 \pmod{4l + 3}$. View Figure 64.

4.3.5 The $2a - 2b + k = -2$ instance

4.3.5.1 The $2a - 2b + k = -2$ instance with $k = 2l$ and $b = a + l + 1 \pmod{4l + 1}$. View Figure 68.

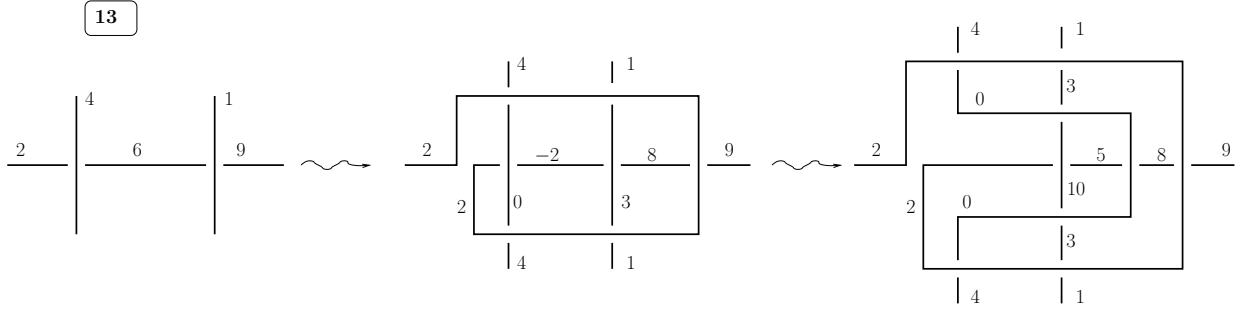

Figure 63: Removing color k from an under-arc: the $2a - 2b + k = -1$ instance with $k = 2l$, $b = a + 3l + 1$ and $a = 2l - 2$, mod $4l + 1$: fixing the boxed region for $l = 3$ in Figure 62.

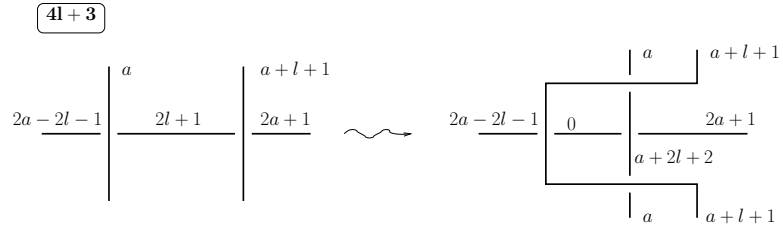

Figure 64: Removing color k from an under-arc: the $2a - 2b + k = -1$ instance with $k = 2l + 1$ and $b = a + l + 1$ mod $4l + 3$.

$a+2l+2=2l+1$	$a+2l+2=-1$	$a+2l+2=-2$
$a=-1$ X	$2a+1=4l+1=-2$ X	$a=2l-1$

Table 4.30: Equalities which should not occur in Figure 64 (1st row) and their consequences (2nd row). X's stand for conflicts with assumptions thus not requiring further considerations.

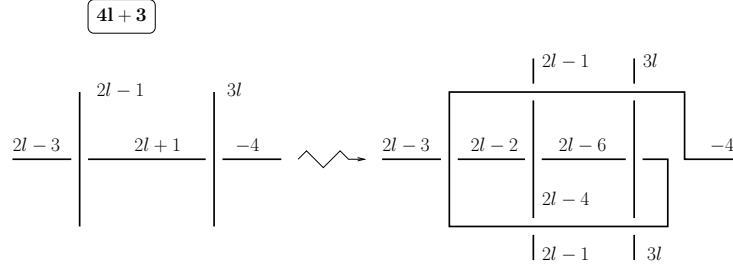

Figure 65: Removing color k from an under-arc: the $2a - 2b + k = -1$ instance with $k = 2l + 1$, $b = a + l + 1$ and $a = 2l - 1$, mod $4l + 3$. The boxed region will be fixed for $l = 3$ in Figure 60.

$$l \geq 2 \quad l - 5 \leq 2l - 6 < 2l - 4 < 2l - 2 < k (= 2l + 1) < 4l + 1 < 4l + 3$$

Table 4.31: Consider Figure 65. $l \geq 2$. The equalities $l - 5 = 2l - 6$, $l - 5 = -1$, $l - 5 = -2$, $2l - 6 = -1$, and $2l - 6 = -2$ only give rise to further consideration for $l = 2$ or for $l = 4$. These situations are dealt with in Figures 66 and 67.

4.3.5.2 The $2a - 2b + k = -2$ instance with $k = 2l + 1$ and $b = a + 3l + 3$ mod $4l + 3$. View Figure 68.

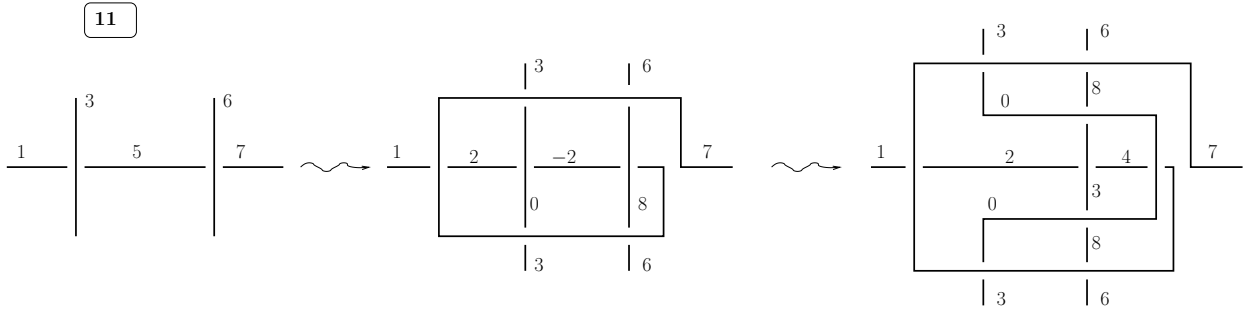

Figure 66: Removing color k from an under-arc: the $2a - 2b + k = -1$ instance with $k = 2l + 1$, $b = a + l + 1$ and $a = 2l - 1$, $\text{mod } 4l + 3$: fixing the boxed region for $l = 2$ in Figure 65.

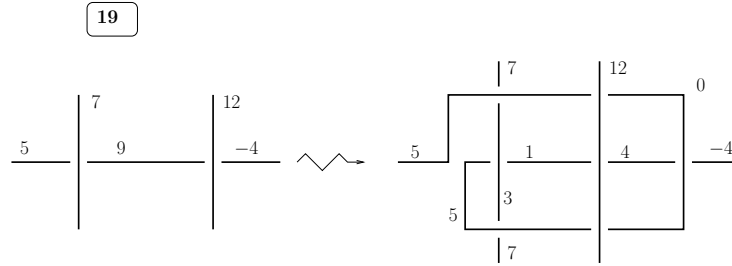

Figure 67: Removing color k from an under-arc: the $2a - 2b + k = -1$ instance with $k = 2l + 1$, $b = a + l + 1$ and $a = 2l - 1$, $\text{mod } 4l + 3$: fixing the boxed region for $l = 4$ in Figure 65.

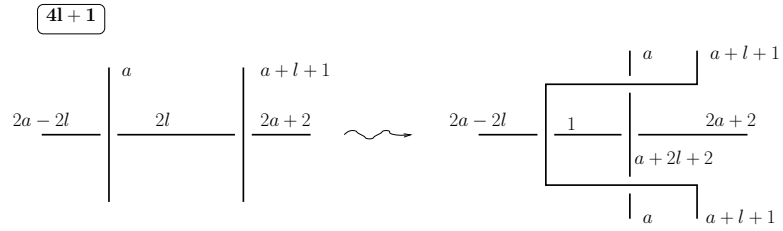

Figure 68: Removing color k from an under-arc: the $2a - 2b + k = -2$ instance with $k = 2l$ and $b = a + l + 1$ $\text{mod } 4l + 1$.

$a + 2l + 2 = 2l$	$a + 2l + 2 = -1$	$a + 2l + 2 = -2$
$a = -2$ X	$a = 2l - 2$	$a = 2l - 3$

Table 4.32: Equalities which should not occur in Figure 68 (1st row) and their consequences (2nd row). X's stand for conflicts with assumptions thus not requiring further considerations.

$$l \geq 3 \quad l - 7 \leq 2l - 8 < 2l - 6 < k(= 2l) < 4l - 5 < 4l - 1 < 4l$$

Table 4.33: Consider Figure 69. $l \geq 3$. The equalities $l - 7 = -1$, $l - 7 = -2$, $2l - 8 = -1$, and $2l - 8 = -2$ only give rise to further consideration for $l = 3$. This situation is dealt with in Figure 70.

$$l \geq 3 \quad l - 7 \leq 2l - 9 < k(= 2l) < 4l - 1 < 4l$$

Table 4.34: Consider Figure 71. $l \geq 3$. The equalities $l - 7 = -1$, $l - 7 = -2$, $2l - 9 = -1$, and $2l - 9 = -2$ give rise to further consideration for $l = 4$. This situation is dealt with in Figure 72.

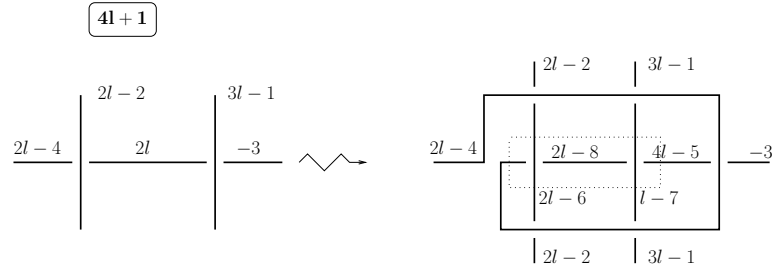

Figure 69: Removing color k from an under-arc: the $2a - 2b + k = -2$ instance with $k = 2l$, $b = a + l + 1$ and $a = 2l - 2 \pmod{4l + 1}$. The boxed region will be fixed for $l = 3$ in Figure 70.

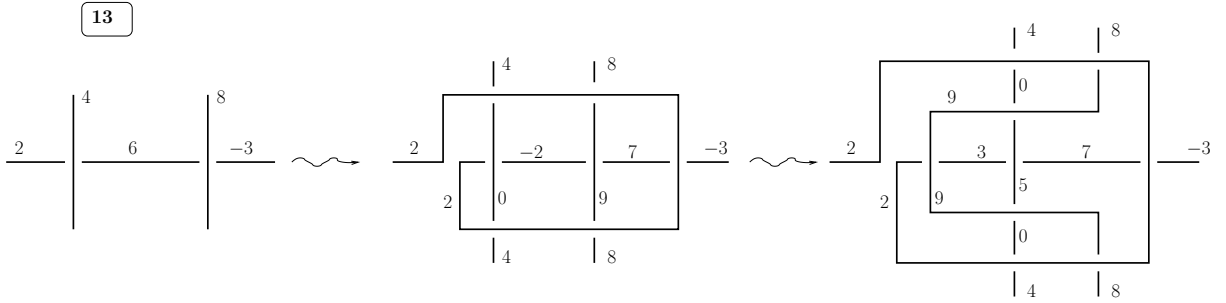

Figure 70: Removing color k from an under-arc: the $2a - 2b + k = -2$ instance with $k = 2l$, $b = a + l + 1$, and $a = 2l - 2 \pmod{4l + 1}$: fixing the boxed region for $l = 3$ in Figure 69.

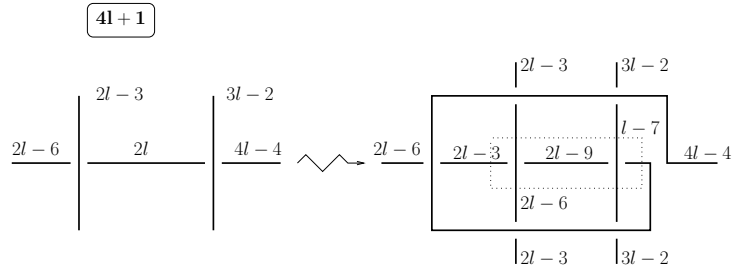

Figure 71: Removing color k from an under-arc: the $2a - 2b + k = -2$ instance with $k = 2l$, $b = a + l + 1$, and $a = 2l - 3 \pmod{4l + 1}$. The boxed region will be fixed for $l = 4$ in Figure 72.

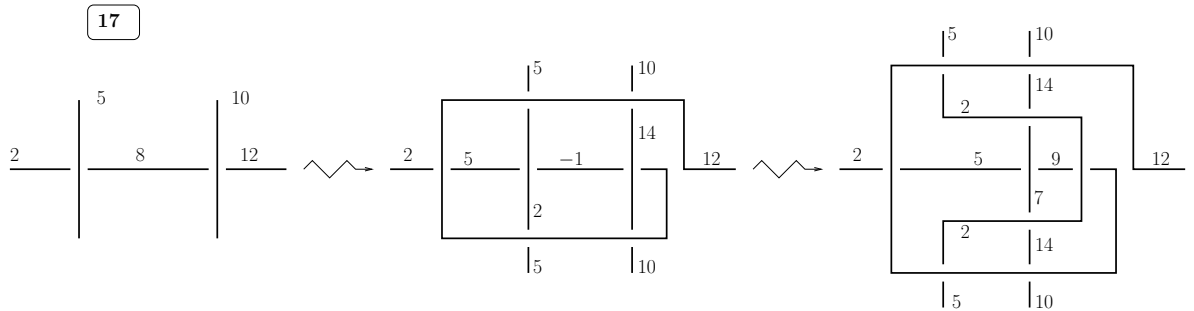

Figure 72: Removing color k from an under-arc: the $2a - 2b + k = -2$ instance with $k = 2l$, $b = a + l + 1$, and $a = 2l - 3 \pmod{4l + 1}$: fixing the boxed region for $l = 4$ in Figure 71.

4.3.6 The $b = a$ instance

View Figure 77.

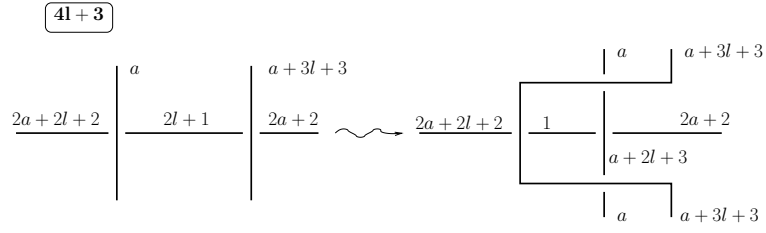

Figure 73: Removing color k from an under-arc: the $2a - 2b + k = -2$ instance with $k = 2l + 1$ and $b = a + 3l + 3 \pmod{4l + 3}$.

$a+2l+3=2l+1$	$a+2l+3=-1$	$a+2l+3=-2$
$a=-2$ X	$a=2l-1$	$a=2l-2$

Table 4.35: Equalities which should not occur in Figure 73 (1st row) and their consequences (2nd row). X's stand for conflicts with assumptions thus not requiring further considerations.

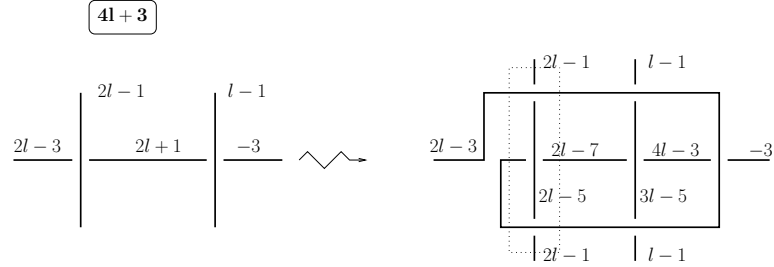

Figure 74: Removing color k from an under-arc: the $2a - 2b + k = -2$ instance with $k = 2l + 1$, $b = a + 3l + 3$, and $a = 2l - 1$, $\pmod{4l + 3}$. The boxed region will be fixed for $l = 2$ in Figure 75.

$l \geq 2$	$2l - 7 < 2l - 5 < k(= 2l + 1) \leq 3l - 5 < 4l - 3 < 4l + 1 < 4l + 2$
------------	--

Table 4.36: Consider Figure 74. $l \geq 2$. The equalities $2l + 1 = 3l - 5$, $2l - 7 = -1$, $2l - 7 = -2$, $2l - 5 = -1$, and $2l - 5 = -2$ give rise to further consideration for $l = 2$. This situation is dealt with in Figure 75.

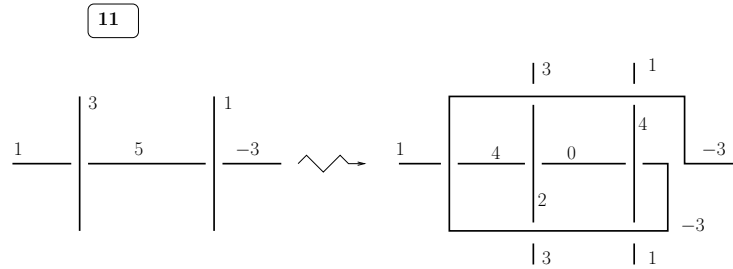

Figure 75: Removing color k from an under-arc: the $2a - 2b + k = -2$ instance with $k = 2l + 1$, $b = a + 3l + 3$, and $a = 2l - 1$, $\pmod{4l + 3}$: fixing the boxed region for $l = 2$ in Figure 74.

$l \geq 2$	$2l - 8 < k(= 2l + 1) \leq 3l - 5 < 4l + 1 < 4l + 2$
------------	--

Table 4.37: Consider Figure 76. $l \geq 2$. The equalities $2l + 1 = 3l - 5$, $2l - 8 = -1$, and $2l - 8 = -2$ do not give rise to further considerations.

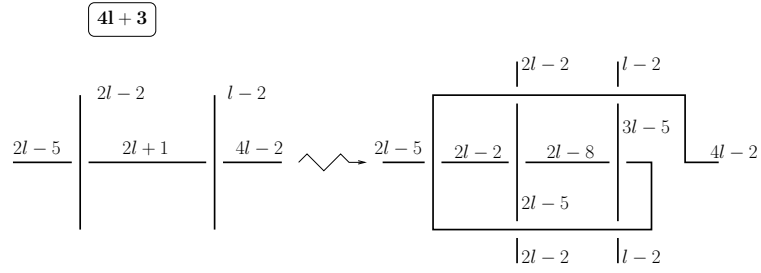

Figure 76: Removing color k from an under-arc: the $2a - 2b + k = -2$ instance with $k = 2l + 1$, $b = a + 3l + 3$, and $a = 2l - 2 \pmod{4l + 3}$.

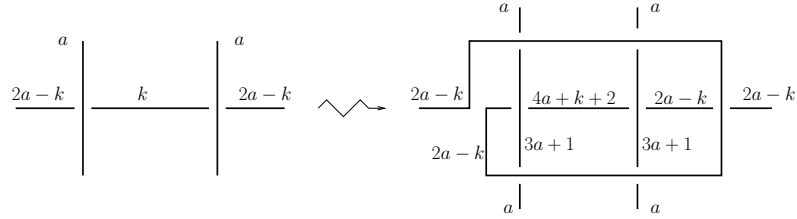

Figure 77: Removing color k from an under-arc: recalling the setting for the $b = a$ instance.

$3a+1=k$	$3a+1=-1$	$3a+1=-2$	$4a+k+2=k$	$4a+k+2=-1$	$4a+k+2=-2$
$a=k$ X	$a=6l+14l$ or $a=6l+52l+1$	$a=-1$ X	$a=k$ X	$a=8l+15l$ or $a=8l+37l+2$ or $a=8l+51$ or $a=8l+73l+2$	$a=8l+17l$ or $a=8l+35l+1$ or $a=8l+53l+1$ or $a=8l+71$

Table 4.38: Equalities which should not occur in Figure 77 (1st row) and their consequences (2nd row). X 's stand for conflicts with assumptions thus not requiring further considerations. The other situations are dealt with in 4.3.6.1, 4.3.6.2, 4.3.6.3, 4.3.6.4, 4.3.6.5, 4.3.6.6, 4.3.6.7, 4.3.6.8, 4.3.6.9, and in 4.3.6.10.

4.3.6.1 The $b = a$ instance with $3a + 1 = -1$; and $k = 3l$, $a = 4l \pmod{6l + 1}$. View Figure 78.

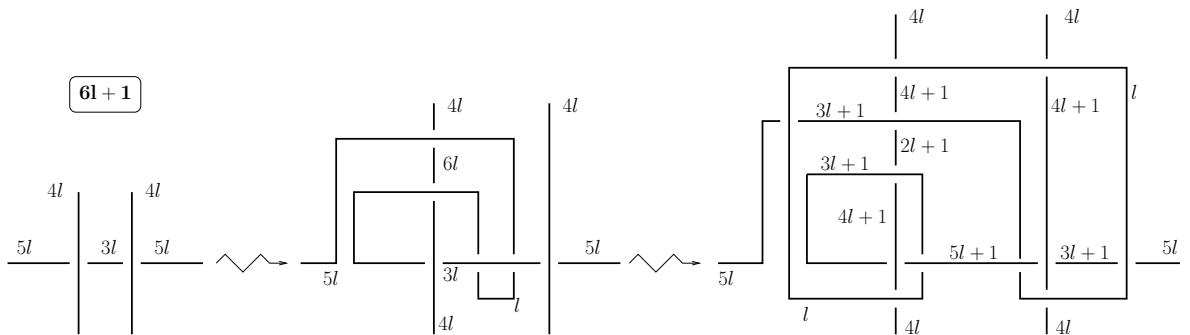

Figure 78: Removing color k from an under-arc: $b - a$ instance with $3a + 1 = -1$; and $k = 3l$, $a = 4l \pmod{6l + 1}$. ($k = 3l < a = 4l < 6l - 1 < 6l$).

$$\boxed{l \geq 2 \quad 2l + 1 \leq 3l < 3l + 1 < 4l + 1 < 5l + 1 \leq 6l - 1 < 6l}$$

Table 4.39: Consider Figure 78. $l \geq 2$. The equalities $2l + 1 = 3l$, $5l + 1 = 6l - 1$, and $5l + 1 = 6l$ give rise to further considerations for $l = 2$ alone. This situation is dealt with in Figure 79.

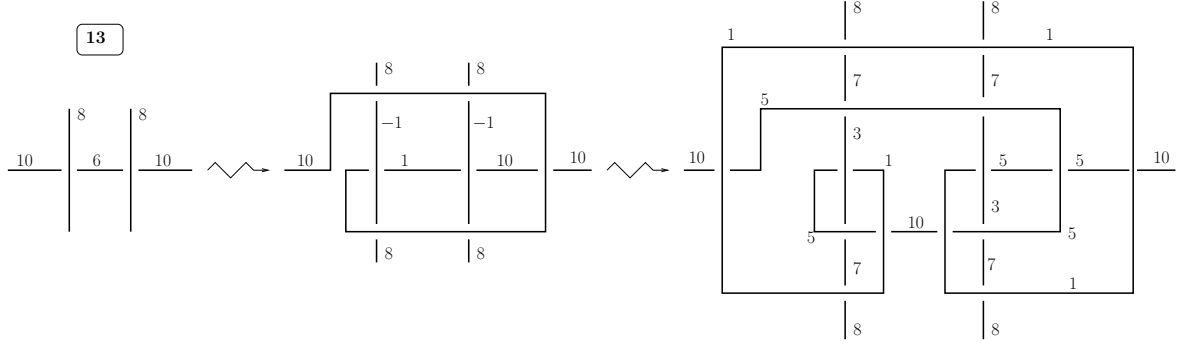

Figure 79: Removing color k from an under-arc: $b - a$ instance with $3a + 1 = -1$; and $k = 3l$, $a = 4l \pmod{6l + 1}$ and $l = 2$.

4.3.6.2 The $b - a$ instance with $3a + 1 = -1$; and $k = 3l + 2$, $a = 2l + 1 \pmod{6l + 5}$ $a = 2l + 1 (< k = 3l + 2 < 6l + 3 < 6l + 4)$. View Figure 80.

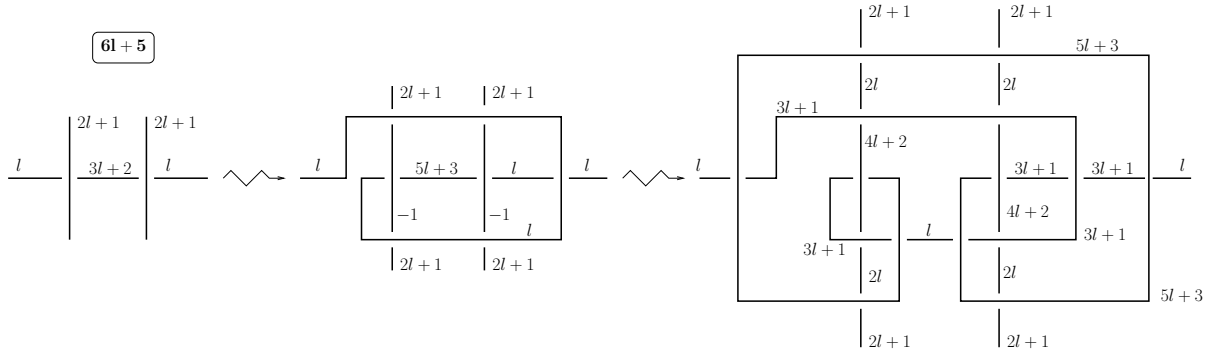

Figure 80: Removing color k from an under-arc: the $b = a$ instance with $3a + 1 = -1$; and $k = 3l + 2$, $a = 2l + 1 \pmod{6l + 5}$. $a = 2l + 1 (< k = 3l + 2 < 6l + 3 < 6l + 4)$.

$$\boxed{l \geq 1 \quad 2l < 3l + 1 < k(= 3l + 2) < 4l + 2 < 5l + 3 < 6l + 3 < 6l + 4}$$

Table 4.40: Consider Figure 80. $l \geq 2$. There are no further considerations, here.

4.3.6.3 The $b = a$ instance with $4a + k + 2 = -1$; and $k = 4l$, $a = 5l \pmod{8l + 1}$. so $(k = 4l < a = 5l < 8l - 1 < 8l)$. View Figure 81.

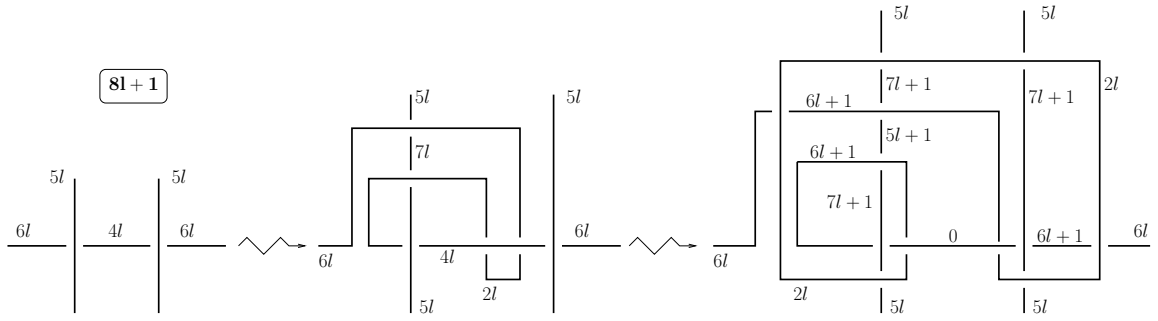

Figure 81: Removing color k from an under-arc: the $b = a$ instance with $4a + k + 2 = -1$; and $k = 4l$, $a = 5l \pmod{8l + 1}$. ($k = 4l < a = 5l < 8l - 1 < 8l$).

$$\boxed{l \geq 2 \quad 2l < k(=4l) < 5l + 1 < 6l + 1 < 7l + 1 \leq 8l - 1 < 8l}$$

Table 4.41: Consider Figure 81. $l \geq 2$. The equalities $7l + 1 = 8l - 1$, and $7l + 1 = 8l$ give rise to further considerations for $l = 2$ alone. This situation is dealt with in Figures 82 and 83.

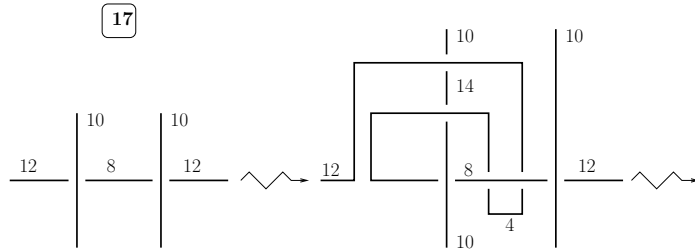

Figure 82: Removing color k from an under-arc: the $b = a$ instance with $4a + k + 2 = -1$; and $k = 4l$, $a = 5l \pmod{8l + 1}$. Fixing the $l = 2$ case (part I).

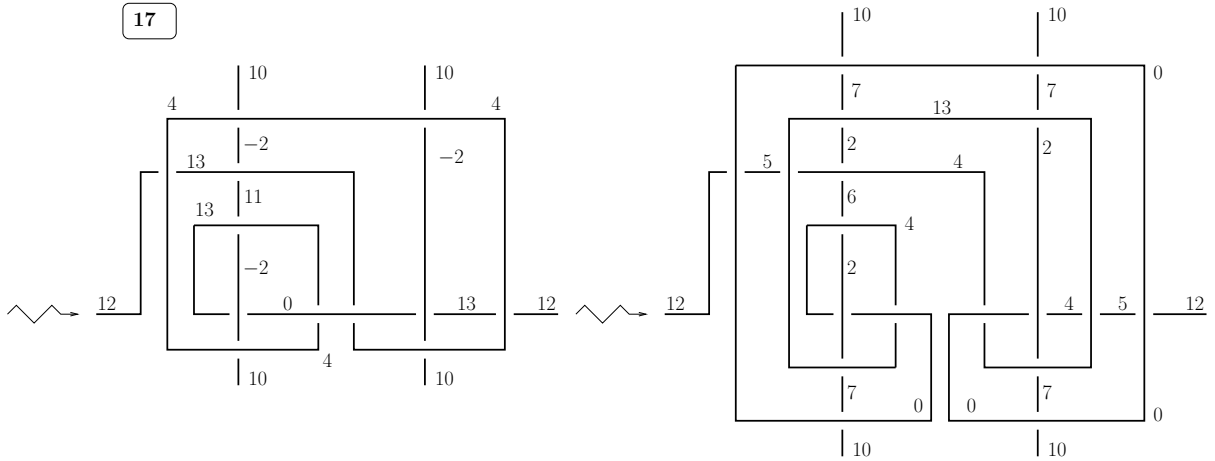

Figure 83: Removing color k from an under-arc: the $b = a$ instance with $4a + k + 2 = -1$; and $k = 4l$, $a = 5l \pmod{8l + 1}$. Fixing the $l = 2$ case (part II).

4.3.6.4 The $b = a$ instance with $4a + k + 2 = -1$; and $k = 4l + 1$, $a = 7l + 2 \pmod{8l + 3}$. ($k = 4l + 1 < a = 7l + 2 < 8l + 1$). View Figure 84.

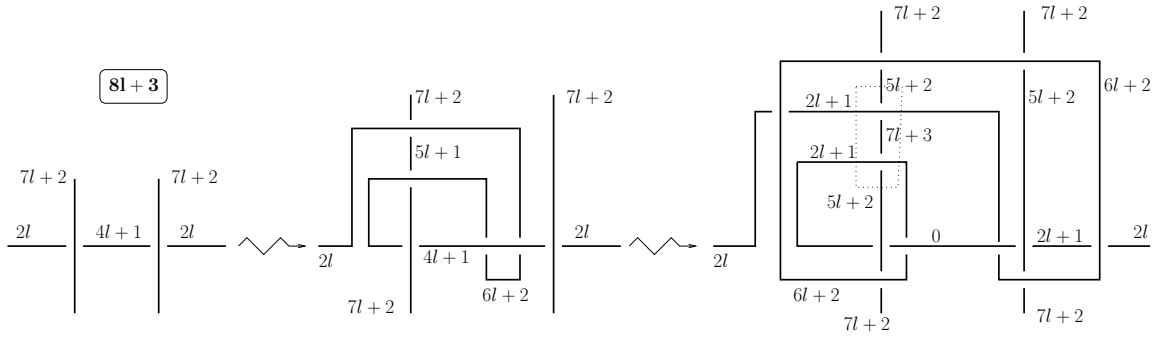

Figure 84: Removing color k from an under-arc: the $b = a$ instance with $4a + k + 2 = -1$; and $k = 4l + 1$, $a = 7l + 2 \pmod{8l + 3}$. ($k = 4l + 1 < a = 7l + 2 < 8l + 1$). The boxed region is fixed for $l = 2$ in Figure 85.

$$\boxed{l \geq 1 \quad 2l + 1 < k (= 4l + 1) < 5l + 2 < 6l + 2 < 7l + 3 \leq 8l + 1 < 8l + 2}$$

Table 4.42: Consider Figure 84. $l \geq 1$. The equalities $7l + 3 = 8l + 1$, and $7l + 3 = 8l + 2$ give rise to further considerations for $l = 2$ alone. This situation is dealt with in Figure 85.

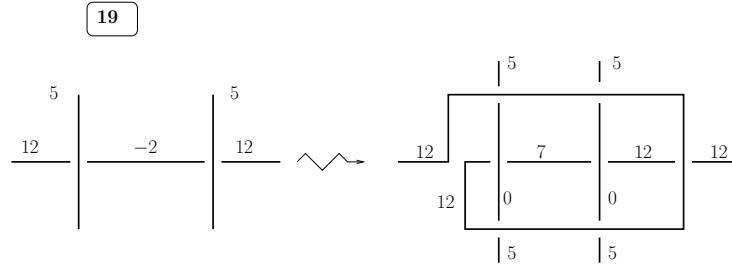

Figure 85: Removing color k from an under-arc: the $b - a$ instance with $4a = k - 2$ and $k = 4l + 1$ so ($k = 4l + 1 < a = 7l + 2 < 8l + 1$). Fixing the boxed region for $l = 2$ in Figure 84.

4.3.6.5 The $b = a$ instance with $4a + k + 2 = -1$; and $k = 4l + 2$, $a = l \pmod{8l + 5}$. $a = l < k = 4l + 2 < 8l + 3 < 8l + 4$. View Figure 86.

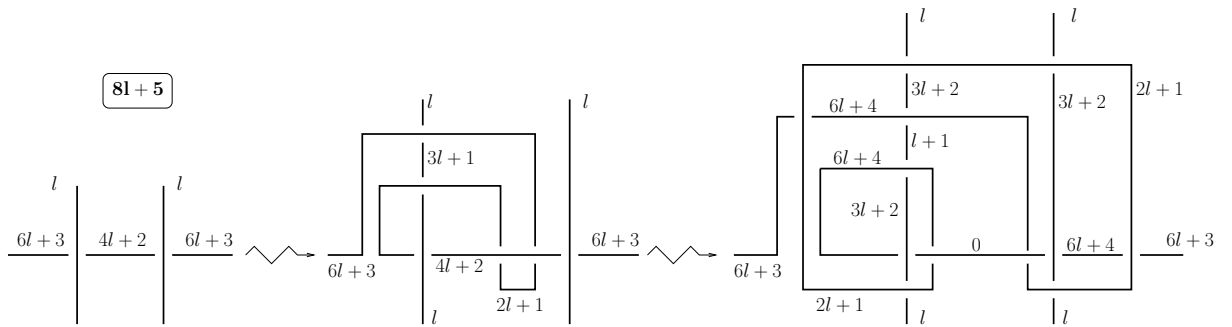

Figure 86: Removing color k from an under-arc: the $b = a$ instance with $4a + k + 2 = -1$; and $k = 4l + 2$, $a = l \pmod{8l + 5}$. $a = l < k = 4l + 2 < 8l + 3 < 8l + 4$.

$$l \geq 1 \quad l+1 < 2l+1 < 3l+2 < k(=4l+2) < 6l+4 < 8l+3 < 8l+4$$

Table 4.43: Consider Figure 86. $l \geq 1$. There are no further considerations here.

4.3.6.6 The $b = a$ instance with $4a + k + 2 = -1$; and $k = 4l + 3$, $a = 3l + 2 \pmod{8l + 7}$. $a = 3l + 2 (< k = 4l + 3 < 8l + 5 < 8l + 6)$. View Figure 87.

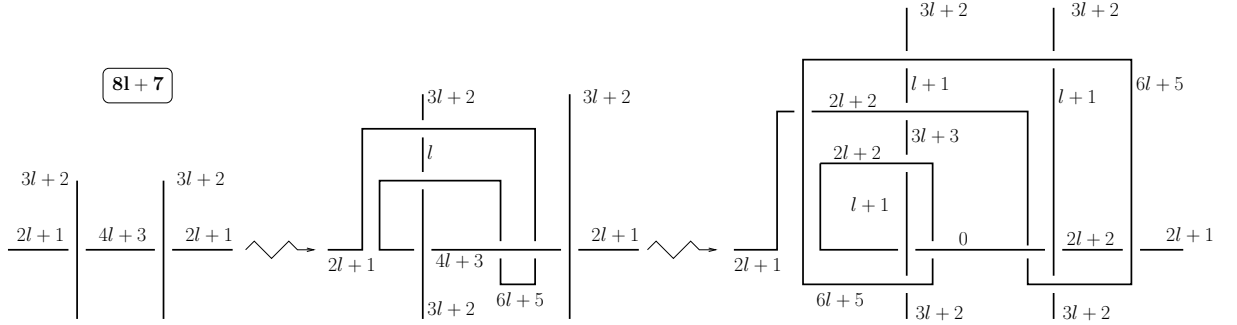

Figure 87: Removing color k from an under-arc: the $b = a$ instance with $4a + k + 2 = -1$; and $k = 4l + 3$, $a = 3l + 2 \pmod{8l + 7}$. $a = 3l + 2 (< k = 4l + 3 < 8l + 5 < 8l + 6)$.

$$l \geq 2 \quad l+1 < 2l+2 < 3l+3 < k(=4l+3) < 6l+5 < 8l+5 < 8l+6$$

Table 4.44: Consider Figure 87. $l \geq 2$. There are no further considerations here.

4.3.6.7 The $b = a$ instance with $4a + k + 2 = -2$; and $k = 4l$, $a = 7l \pmod{8l + 1}$. ($k = 4l < a = 7l < 8l$). View Figure 88.

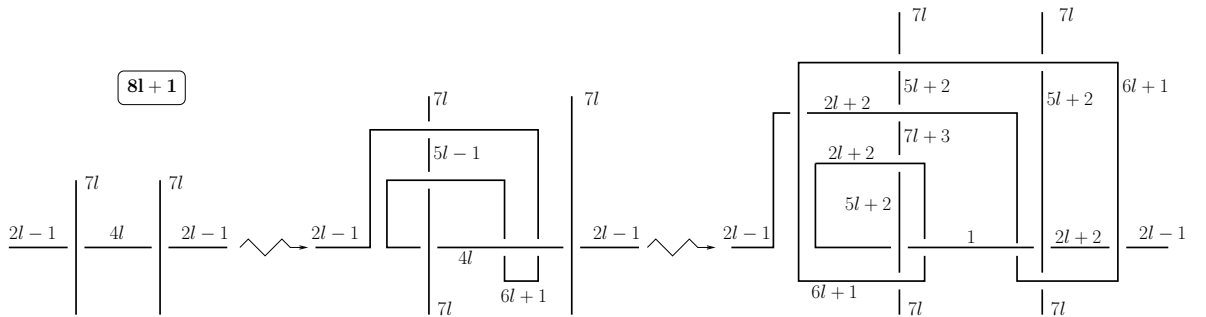

Figure 88: Removing color k from an under-arc: the $b = a$ instance with $4a + k + 2 = -2$; and $k = 4l$, $a = 7l \pmod{8l + 1}$. ($k = 4l < a = 7l < 8l$).

$$\boxed{l \geq 2 \quad 2l + 2 \leq k(= 4l) < 5l + 2 \leq 6l + 1 < 7l + 3 \leq 8l - 1 < 8l}$$

Table 4.45: Consider Figure 88. $l \geq 2$. The equalities $2l + 2 = 4l$, $6l + 1 = 8l - 1$, $7l + 3 = 8l - 1$, and $7l + 3 = 8l$ do not give rise to further considerations.

4.3.6.8 The $b = a$ instance with $4a + k + 2 = -2$; and $k = 4l + 1$, $a = 5l + 1 \pmod{8l + 3}$. ($k = 4l + 1 < a = 5l + 1 < 8l + 1 < 8l + 2$). View Figure 89.

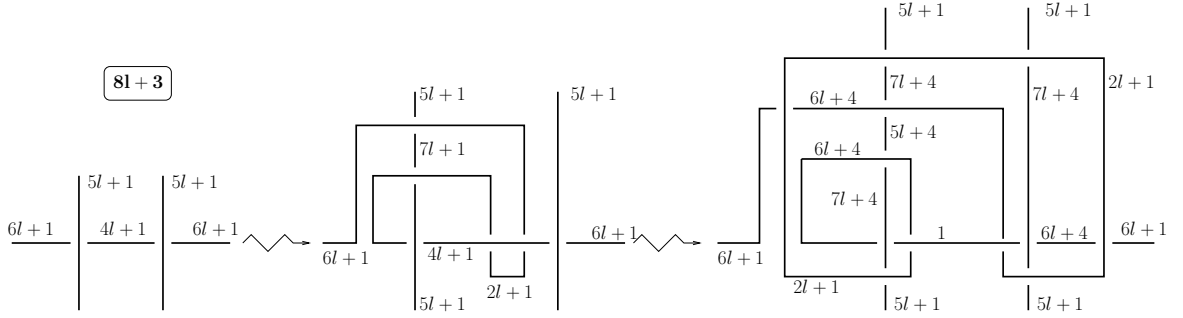

Figure 89: Removing color k from an under-arc: the $b - a$ instance with $4a = k - 2$ and $k = 4l + 1$ so ($k = 4l + 1 < a = 5l + 2 < 8l + 1 < 8l + 2$) (continued in Figure 90).

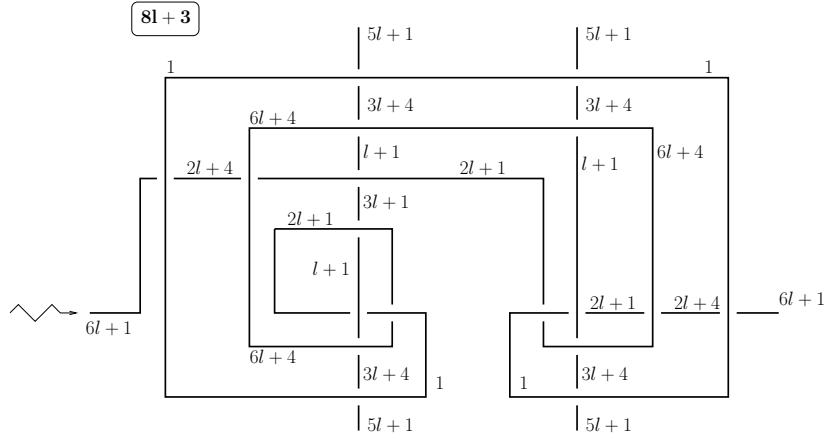

Figure 90: Removing color k from an under-arc: the $b - a$ instance with $4a = k - 2$ and $k = 4l + 1$ so ($k = 4l + 1 < a = 5l + 2 < 8l + 1 < 8l + 2$) (continued from Figure 89).

$$\boxed{l \geq 1 \quad l + 1 < 2l + 1 < 2l + 4 < 3l + 4 \leq k(= 4l + 1) < 5l + 1 < 6l + 4 \leq 8l + 1 < 8l + 2}$$

Table 4.46: Consider Figure 90. $l \geq 2$. The equalities $2l + 4 = 4l + 1$, $3l + 4 = 4l + 1$, $6l + 4 = 8l + 1$, and $6l + 4 = 8l + 2$ do not give rise to further considerations.

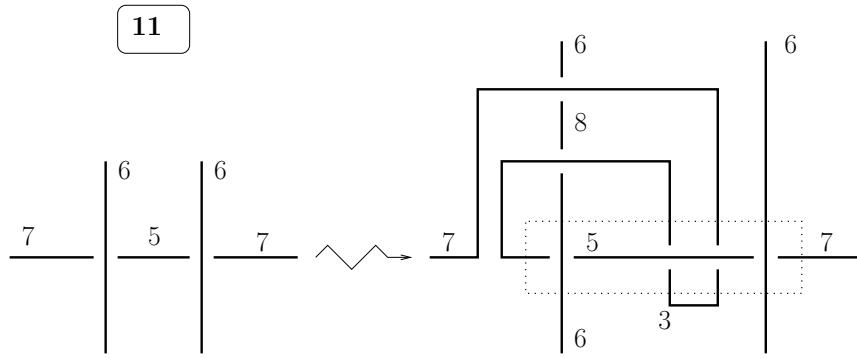

Figure 91: Fixing the $l = 1$ situation in Figure 90.

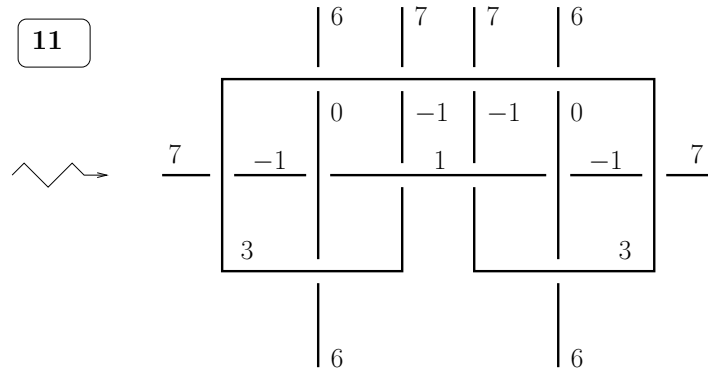

Figure 92: Fixing the $l = 1$ situation in Figure 90 (cont'd).

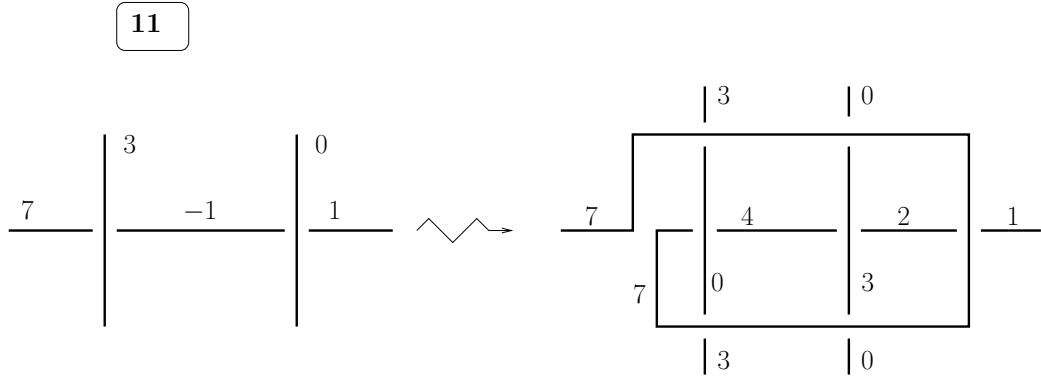

Figure 93: Fixing the $l = 1$ situation in Figure 90.

$$\boxed{l \geq 1 \quad l + 2 < 2l + 3 < 3l + 4 \leq 4l + 2 < 8l + 3 < 8l + 4}$$

Table 4.47: Consider Figure 95. $l \geq 1$. The equality $3l + 4 = 4l + 2$ does not give rise to further considerations.

4.3.6.9 The $b = a$ instance with $4a + k + 2 = -2$; and $k = 4l + 2$, $a = 3l + 1 \pmod{8l + 5}$. $a = 3l + 1 (< k = 4l + 2 < 8l + 3 < 8l + 4)$. View Figure 95.

4.3.6.10 The $b = a$ instance with $4a + k + 2 = -2$; and $k = 4l + 2$, $a = l \pmod{8l + 7}$. $a = l (< k = 4l + 3 < 8l + 5 < 8l + 6)$. View Figure 96.

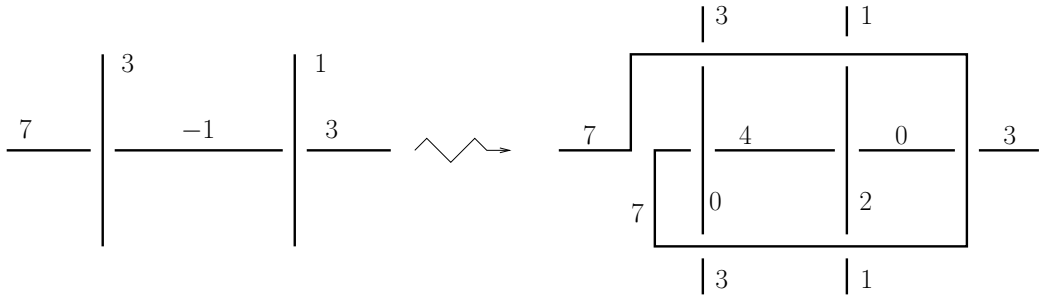

Figure 94: Fixing the $l = 1$ situation in Figure 90.

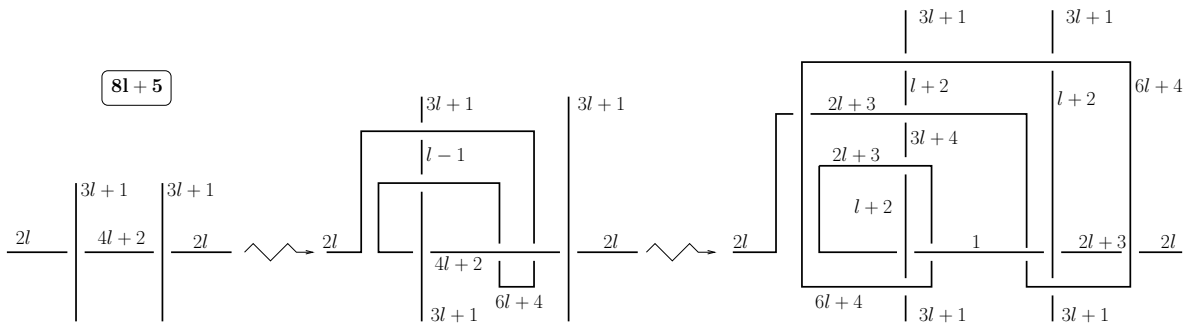

Figure 95: Removing color k from an under-arc: the $b = a$ instance with $4a + k + 2 = -2$; and $k = 4l + 2$, $a = 3l + 1 \pmod{8l + 5}$. $a = 3l + 1 (< k = 4l + 2 < 8l + 3 < 8l + 4)$.

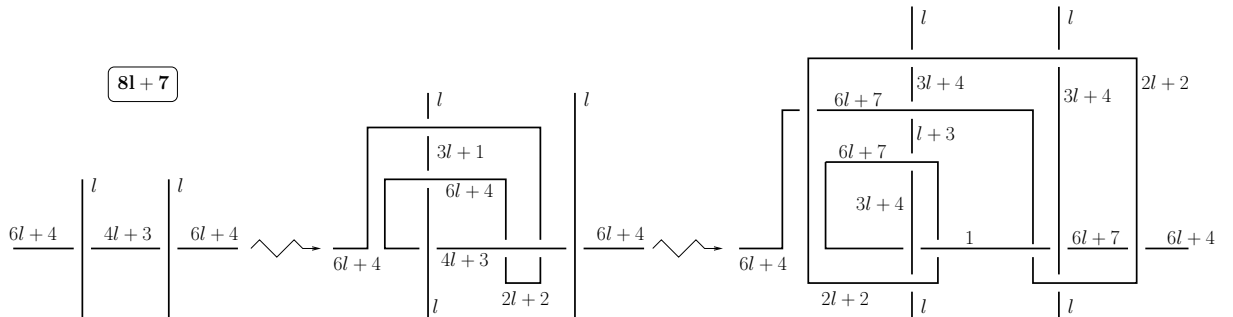

Figure 96: Removing color k from an under-arc: the $b = a$ instance with $4a + k + 2 = -2$; and $k = 4l + 2$, $a = l \pmod{8l + 7}$. $a = 3l + 2 (< k = 4l + 3 < 8l + 5 < 8l + 6)$.

$$l \geq 2 \quad l + 3 \leq 2l + 2 < 3l + 4 \leq 4l + 3 < 6l + 7 \leq 8l + 5 < 8l + 6$$

Table 4.48: Consider Figure 96. $l \geq 2$. The equalities $3l + 4 = 4l + 3$, $6l + 7 = 8l + 5$, and $6l + 7 = 8l + 6$ do not give rise to further considerations.

References

[1] K. Oshiro, *Any 7-colorable knot can be colored by four colors*, J. Math. Soc. Japan, **62**, no. 3 (2010), 963–973