

ON CUBES OF FROBENIUS EXTENSIONS

BEN ELIAS, NOAH SNYDER AND GEORDIE WILLIAMSON

ABSTRACT. Given a hypercube of Frobenius extensions between commutative algebras, we provide a diagrammatic description of some natural transformations between compositions of induction and restriction functors, in terms of colored transversely-intersecting planar 1-manifolds. The relations arise in the first and third author's work on (singular) Soergel bimodules.

1. INTRODUCTION AND RESULTS

1.1. Basic Setup. Let \mathbb{k} be a base field. We will work entirely within the context of commutative \mathbb{k} -algebras.

Definition 1.1. A (commutative) *Frobenius extension* is an extension of rings $\iota: A \hookrightarrow B$, where B is free and finitely generated as an A -module, equipped with an A -linear map $\partial = \partial_A^B: B \rightarrow A$, called the *trace*. The trace is required to be *non-degenerate*. That is, we assume that we can equip B with a pair of bases $\{x_\alpha\}$ and $\{y_\alpha\}$ as an A -module, such that $\partial(x_\alpha y_\beta) = \delta_{\alpha\beta}$. These are called *dual bases*.

This data also equips one with a comultiplication map $\Delta_A^B: B \rightarrow B \otimes_A B$ sending $1 \mapsto \sum_\alpha x_\alpha \otimes y_\alpha$, an element which is independent of the choice of dual bases. Note that if $A \subset B$ and $B \subset C$ are Frobenius extensions, then $A \subset C$ is a Frobenius extension as well, with trace $\partial_A^C = \partial_A^B \partial_B^C$. A typical example to have in mind is $\mathbb{k}[x^2] \subset \mathbb{k}[x]$ with the trace $\partial(f) = (f(x) - f(-x))/x$.

A more familiar situation is when $A = \mathbb{k}$, at which point B is called a Frobenius algebra. Commutative Frobenius algebras are in bijection with 2-dimensional TQFTs. Frobenius extensions (or Frobenius objects in any category) are no less ubiquitous. An extension $A \subset B$ of commutative algebras is Frobenius if and only if the functors Ind_A^B and Res_A^B are biadjoint. There are numerous standard examples:

- The inclusion $\mathbb{C}[H] \subset \mathbb{C}[G]$ of group algebras for an inclusion $H \subset G$ of finite abelian (if we want to keep the commutative assumption) groups.
- The inclusion of symmetric polynomials in all polynomials.
- Various examples constructed using convolution functors in geometry.

For more background information see [3].

Rather than just a single Frobenius extension, we will be studying several compatible Frobenius extensions. For example, we might have a square of extensions $A \subset B$, $B \subset C$, $A \subset D$, and $D \subset C$. More generally, instead of a square of inclusions we might have a larger hypercube.

Definition 1.2. A *hypercube of Frobenius extensions* or a *Frobenius hypercube* will be the following datum.

- A finite set Γ . We also use Γ to designate the entire datum. We consider the hypercube with vertices labelled by subsets of Γ . An edge in this hypercube corresponds to $I \setminus \gamma \subset I$ for some $\gamma \in I \subset \Gamma$, and parallel edges correspond to the same γ .
- A (contravariant) assignment of rings R^I to vertices in the cube, so that $I \subset J \implies R^J \subset R^I$.
- For each edge, a trace map $\partial_I^{I \setminus \gamma}: R^{I \setminus \gamma} \rightarrow R^I$ making $R^{I \setminus \gamma}$ a Frobenius extension of R^I .

We call this hypercube *compatible* if, for every square $I \subset J, J' \subset K$ (so that $I = K \setminus \{\gamma, \gamma'\}$) we have $\partial_K^J \partial_J^I = \partial_K^{J'} \partial_{J'}^I$. In this case, there is a well-defined map $\partial_J^I: R^I \rightarrow R^J$ for every $I \subset J$, which endows the extension $R^J \subset R^I$ with the structure of a Frobenius extension. We assume henceforth that every hypercube of Frobenius extensions is compatible.

We sometimes drop the notation for the empty set, so that ∂_J denotes ∂_J^\emptyset .

Definition 1.3. Let \mathbf{Bim} denote the 2-category whose objects are algebras, and where $\text{Hom}_{\mathbf{Bim}}(A, B)$ is the category of finitely generated (B, A) -bimodules. Horizontal composition is given by tensor product. Given a (B, A) -bimodule M , we sometimes write it as ${}_B M_A$ to emphasize which algebras act on it. For a Frobenius hypercube Γ , we will denote by $\mathcal{C}(\Gamma)$ the full sub-2-category of \mathbf{Bim} whose objects are the rings of each vertex, and whose 1-morphisms are generated monoidally by the induction bimodule ${}_B B_A$ and the restriction bimodule ${}_A B_B$ for each edge $A \subset B$.

Note that $\mathcal{C}(\Gamma)$ does not consist of all bimodules isomorphic to compositions of induction and restriction; it consists only of the compositions themselves. Therefore the objects of $\mathcal{C}(\Gamma)$ can be encoded combinatorially as paths through the hypercube, and the monoidal structure is concatenation of paths. This monoidal structure is strict, in the sense that it is associative up to equality of 1-morphisms, not just associative up to isomorphism. The diagrammatic language for describing 2-categories which we use in this paper, and which is common in the modern literature, is designed to work only with strict 2-categories, which explains why we do not include bimodules isomorphic to compositions over paths. In particular, for $I \subset J$ which is not an edge, the bimodule Ind_J^I is not an object in $\mathcal{C}(\Gamma)$, even though this bimodule is isomorphic to the composition of inductions along any path from I up to J . The influence of the bimodule Ind_J^I can still be felt in $\mathcal{C}(\Gamma)$, evident in the existence of natural isomorphisms between the inductions for different paths from I to J .

Example 1.4. Here is the example which motivated the authors of this paper. Let Γ be the vertices of a Dynkin diagram, let W be its Weyl group, and for any subset $I \subset \Gamma$ let W_I denote the corresponding parabolic subgroup. Let $R = \mathbb{C}[\mathfrak{h}]$ denote the polynomial ring of regular functions on the reflection representation of W , and let R^I denote the

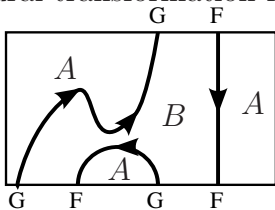
FIGURE 1. A natural transformation from $GFGF$ to GF 

subring invariant under W_I . This gives a hypercube of Frobenius extensions, and the 2-category $\mathcal{C}(\Gamma)$ (or rather, its Karoubi envelope) is the category of singular Soergel bimodules, as defined by the second author in [10], elaborating on ideas of Soergel [9]. Understanding the 2-morphisms in this 2-category can help solve natural questions in the geometry of flag varieties and Kazhdan-Lusztig theory.

Example 1.5. The most familiar version of the Soergel cube is where $R = \mathbb{C}[x_1, \dots, x_n]$, equipped with the natural action of $W = S_n$. This example plays a key role in the categorification of quantum \mathfrak{sl}_2 given by Khovanov and Lauda [6].

It is well-known that biadjoint functors and the natural transformations between them (such as the 2-morphisms in $\mathcal{C}(A \subset B)$ for a Frobenius extension) can be described using diagrams in the planar strip $\mathbb{R} \times [0, 1]$. The goal of this paper is to provide a framework whereby 2-morphisms in $\mathcal{C}(\Gamma)$ for a Frobenius hypercube can be described by collections of colored oriented 1-manifolds with boundary, and to give some standard relations which hold under some reasonable restrictions.

1.2. Diagrammatics. We assume the reader is familiar with diagrammatics for 2-categories with biadjoints, and the definition of cyclicity for a 2-morphism. An introduction to the topic can be found in chapter 4 of [7]. If $F: \mathcal{A} \rightarrow \mathcal{B}$ and $G: \mathcal{B} \rightarrow \mathcal{A}$ are biadjoint functors, then one might draw a particular natural transformation as in Figure 1. Cups and caps correspond to various units and counits of adjunction. Note that one can deduce the labeling of regions from the orientation, or vice versa, so that some information is redundant. Not every oriented 1-manifold gives rise to a consistent labeling of regions, and only the consistent ones give rise to natural transformations.

Let $A \subset B$ be a Frobenius extension, and consider diagrams for $\mathcal{C}(A \subset B)$. We let an upward-oriented line denote the bimodule ${}_B B_A$ which corresponds to the functor of induction, and a downward-oriented line denote the restriction bimodule ${}_A B_B$. Technically speaking, these 1-morphisms are denoted by oriented points, and their identity 2-morphisms by oriented lines, but we shall abuse notation like this henceforth. A consistent oriented 1-manifold in the planar strip (up to boundary-preserving isotopy) will unambiguously denote a bimodule morphism. The 4 possible oriented cups and caps correspond to: inclusion $\iota: A \hookrightarrow B$, trace $\partial: B \rightarrow A$, multiplication $m: B \otimes_A B \rightarrow B$, and comultiplication $\Delta: B \rightarrow B \otimes_A B$.

There are additional bimodule morphisms in $\mathcal{C}(A \subset B)$ which arise from the action of the rings on themselves. Since each ring $R = A, B$ is commutative, multiplication

by $f \in R$ is an R -bimodule endomorphism of R . We depict this endomorphism as a *box* containing f , located in a region labelled R . For an example, see (1.4) and following. Because the word “element” is overused, we refer to elements of any ring as *polynomials*, even though we do not assume that the rings in question are polynomial rings. We sometimes refer to boxes and polynomials interchangeably.

Now let Γ be a hypercube of Frobenius extensions, and consider diagrams for $\mathcal{C}(\Gamma)$. Regions should be labelled by subsets $I \subset \Gamma$. The generating 1-morphisms will be $\text{Ind}_I^{I \setminus \gamma}$ and $\text{Res}_I^{I \setminus \gamma}$ for each edge. In addition to labeling regions, we add the redundant data of placing orientations and colors on each generating 1-morphism. We orient induction and restriction as above, and color each line based on the element γ which is added or subtracted, so that parallel edges have the same color.

Suppose that $A \subset B \subset C$ are Frobenius extensions, so that $\text{Ind}_A^C \cong \text{Ind}_B^C \text{Ind}_A^B$. In other words, there is a natural isomorphism $C \otimes_B B \otimes_A A \rightarrow C$ as (C, A) -bimodules, which sends $f \otimes g \otimes h = fgh \otimes 1 \otimes 1 \mapsto fgh$. In section 3.2 of [4], a diagrammatic calculus is developed for a 2-category including the bimodule Ind_A^C as well as Ind_B^C and Ind_A^B , which would depict the natural isomorphism above with a trivalent vertex.

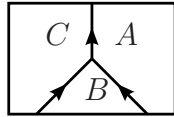

Now suppose that $A \subset B \subset C$ corresponds to $I \subset I \cup \gamma \subset I \cup \{\gamma, \gamma'\}$ in Γ . As discussed in the previous section, Ind_B^C and Ind_A^B are objects in $\mathcal{C}(\Gamma)$, but Ind_A^C is not, so that there is no use for such a trivalent vertex. However, if B' corresponds to $I \cup \gamma'$ then one has a Frobenius square $A \subset B, B' \subset C$, and an isomorphism $\varphi: \text{Ind}_B^C \text{Ind}_A^B \rightarrow \text{Ind}_{B'}^C \text{Ind}_A^{B'}$ factoring through Ind_A^C , which sends $f \otimes 1 \otimes 1 \in C \otimes_B B \otimes_A A$ to $f \otimes 1 \otimes 1 \in C \otimes_{B'} B' \otimes_A A$. We call this map the *induction isomorphism*, and note that its inverse has the same form.

With our drawing convention above, this map φ should be drawn as a crossing of two differently-colored 1-manifolds.

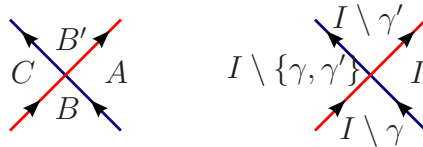

We draw the equivalent isomorphism $1 \otimes 1 \otimes f \mapsto 1 \otimes 1 \otimes f$ for Res_A^C (the *restriction isomorphism*) as a downward-oriented crossing.

Note that the upward-oriented red strand separating A from B' , and the one separating B from C , represent two entirely different bimodules; the interpretation of an upward-oriented red strand depends on the ambient region labels. Though this may cause some initial confusion, it results in a diagrammatic convention whose utility outweighs this minor hurdle.

The following claim guarantees that an *isotopy class* of diagram will unambiguously represent a bimodule morphism. The proof is easy, and appears in Section 2.

Claim 1.6. *For a square of Frobenius algebras, the induction isomorphism is cyclic, and rotating it by 180 degrees yields the restriction isomorphism.*

Note that it is impossible for two 1-manifolds of the same color to cross, since that would result in an inconsistent labeling of regions. Given caps and cups of each color, as well as crossings between different colors, we may produce collections of oriented colored 1-manifolds in the planar strip, such that the intersection between manifolds of a different color is always transverse. Not every collection of 1-manifolds will be considered, but only the diagrams which result in consistent labelings of regions, which we call *consistent diagrams*.

Finally, multiplication by a polynomial $f \in R^I$ is an endomorphism of R^I as an R^I -bimodule, which we depict as a box. There is now a bimodule morphism interpretation of any linear combination of consistent diagrams with boxes in various regions, where a box in a region labeled I is itself labeled by a polynomial in R^I .

1.3. Relations. Here are some relations among bimodule maps which hold for any Frobenius extension or hypercube. All proofs are found in Section 2.

Throughout we apply the following convention: Given a Frobenius square Γ and two subsets $I \subset J$ the set of all subsets lying between I and J indexes a smaller Frobenius hypercube. Any relations which hold in this smaller hypercube are also valid in the larger one. Also, converting a relation in a smaller hypercube to that of a larger one simply involves adding the subset I to all labels in the relation. We will state all relations in their “minimal” form (with $|\Gamma| = 1, 2$ or 3) but in proofs we allow ourselves the flexibility of adding any indices to relations we have already established.

The relations below will use Sweedler notation for coproducts. Suppose that $I \subset J$. The existence of $\Delta_{J(1)}^I$ and $\Delta_{J(2)}^I$ inside a box in a diagram implies that we take the sum over α (where α indexes dual bases $\{x_\alpha\}$ and $\{y_\alpha\}$ of R^I over R^J) of the diagram with x_α replacing $\Delta_{J(1)}^I$ and y_α replacing $\Delta_{J(2)}^I$. We also use μ_J^I to represent the product $\Delta_{J(1)}^I \Delta_{J(2)}^I \in R^I$. We write μ_J instead of μ_J^0 .

First we have the *isotopy relations*, which are necessary for isotopic diagrams to represent the same map.

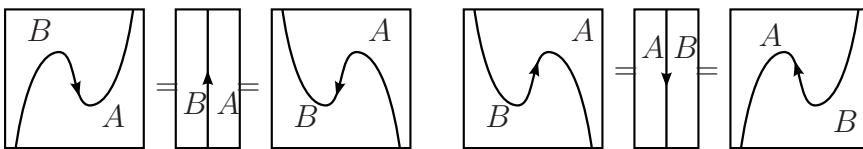
(1.1) 

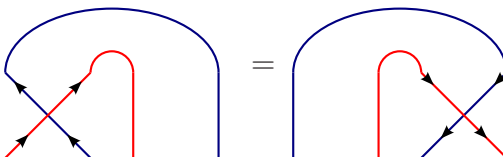
(1.2) 

$$(1.3) \quad \begin{array}{c} \text{Diagram 1} \\ \text{Diagram 2} \end{array} = \begin{array}{c} \text{Diagram 3} \\ \text{Diagram 4} \end{array}$$

All future relations hold when rotated or with the colors switched, but not generally with the orientations reversed. Now we have the relations which hold for any Frobenius extension $\iota: A \subset B$.

$$(1.4) \quad \begin{array}{c} \text{Diagram 1} \\ \text{Diagram 2} \end{array} = \begin{array}{c} \text{Diagram 3} \end{array}$$

$$(1.5) \quad \begin{array}{c} \text{Diagram 1} \\ \text{Diagram 2} \end{array} = \begin{array}{c} \text{Diagram 3} \\ \text{Diagram 4} \end{array}$$

$$(1.6) \quad \begin{array}{c} \text{Diagram 1} \\ \text{Diagram 2} \end{array} = \begin{array}{c} \text{Diagram 3} \\ \text{Diagram 4} \end{array}$$

$$(1.7) \quad \begin{array}{c} \text{Diagram 1} \\ \text{Diagram 2} \end{array} = \begin{array}{c} \text{Diagram 3} \\ \text{Diagram 4} \end{array}$$

$$(1.8) \quad \begin{array}{c} \text{Diagram 1} \\ \text{Diagram 2} \end{array} = \begin{array}{c} \text{Diagram 3} \\ \text{Diagram 4} \end{array}$$

Now consider a Frobenius square. We call these the *Reidemeister II relations*. We assume that $\Gamma = \{r, b\}$ where the colors red and blue are assigned to r and b .

$$(1.9) \quad \begin{array}{c} \text{Diagram 1} \\ \text{Diagram 2} \end{array} = \begin{array}{c} \text{Diagram 3} \\ \text{Diagram 4} \end{array}$$

$$(1.10) \quad \begin{array}{c} \text{Diagram 1} \\ \text{Diagram 2} \end{array} = \begin{array}{c} \text{Diagram 3} \\ \text{Diagram 4} \end{array}$$

In fact, there is a more general version of this relation.

$$(1.11) \quad \boxed{\begin{array}{c} \text{---} \text{---} \text{---} \\ \curvearrowright \text{---} \text{---} \text{---} \\ \text{---} \text{---} \text{---} \\ \text{---} \text{---} \text{---} \\ \curvearrowleft \text{---} \text{---} \text{---} \\ \text{---} \text{---} \text{---} \end{array}} = \boxed{\begin{array}{c} \Delta_{rb,(1)}^b \\ \updownarrow \\ \partial_r(f\Delta_{rb,(2)}^b) \end{array}}$$

It is implied by (1.10) so long as R is generated by R^r and R^b . There are a few stronger assumptions one might wish to make, which hold in example 1.5.

Definition 1.7. We say that a Frobenius square satisfies condition \star if we may choose dual bases $\{x_\alpha\}$ and $\{y_\alpha\}$ of R over R^b such that $x_\alpha \in R^r$. We say that a Frobenius hypercube satisfies \star if every square inside it does.

Condition \star implies that R is generated by R^r and R^b , but a priori is stronger. They are equivalent if all the R^I are fields, or if the R^I are positively graded algebras over a field and the degree 0 part is just the scalars. This second case includes the Soergel bimodule examples.

Definition 1.8. We say that our Frobenius cube has *no μ -zero divisors* if $\mu_\Gamma \in R$ is not a zero divisor (in particular $\mu_\Gamma \neq 0$).

Assume Γ has no μ -zero divisors. Using the identity $\mu_J = \mu_J^I \mu_I$ we see first that μ_I is not a zero divisor for any $I \subset \Gamma$, and then that that $\mu_J^I \in R^I$ are not zero divisors either, for any $I \subset J$. This explains the terminology.

Remark 1.9. If a Frobenius cube has no μ -zero divisors then each extension $R^J \subset R^I$ splits when we invert μ_J^I . Hence, after localizing one can regard the cube as being “semi-simple”. Here it can be easier to check relations. Furthermore, because all bi-modules involved inject into their localizations, any relations which hold in the localized Frobenius cube also hold in Γ .

Definition 1.10. We say that a Frobenius cube satisfies condition R3, if for every triple of colors r, g, b we have that the $\mu_{gr}\mu_{rb}\mu_{gb} \mid \mu_{grb}\mu_g\mu_r\mu_b$.

Remark 1.11. Again, after localization every Frobenius cube satisfies condition R3. In fact, it’s easy to see that $\frac{\mu_{grb}\mu_g\mu_r\mu_b}{\mu_{gr}\mu_{rb}\mu_{gb}}$ makes sense if you localize by any of μ_{gr} , μ_{rb} , or μ_{gb} . Furthermore, if R is a UFD and μ_{gr} , μ_{rb} , and μ_{gb} are relatively prime then R3 automatically holds.

We now turn to the consequences of these assumptions. When R is generated by R^r and R^b , we also have the following relation.

$$(1.12) \quad \boxed{\begin{array}{c} \text{---} \text{---} \text{---} \\ \curvearrowright \text{---} \text{---} \text{---} \\ \text{---} \text{---} \text{---} \\ \text{---} \text{---} \text{---} \\ \curvearrowleft \text{---} \text{---} \text{---} \\ \text{---} \text{---} \text{---} \end{array}} = \boxed{\begin{array}{c} \text{---} \text{---} \text{---} \\ \updownarrow \text{---} \text{---} \text{---} \\ \text{---} \text{---} \text{---} \\ \updownarrow \text{---} \text{---} \text{---} \\ \text{---} \text{---} \text{---} \end{array}}$$

The polynomial in the box is $\partial_r(\Delta_{rb(1)}^b)\Delta_{rb(2)}^b$. When the square satisfies \star and has no μ -zero divisors, then there is a nicer expression for $\partial_r(\Delta_{rb(1)}^b)\Delta_{rb(2)}^b$, which is $\frac{\mu_{rb}}{\mu_r\mu_b}$. Consequently, $\frac{\mu_{rb}}{\mu_r\mu_b}$ is a genuine polynomial, not just an element of the localization.

Now consider a Frobenius cube. We call these the *Reidemeister III relations*. We assume that $\Gamma = \{r, b, g\}$ where green denotes g .

$$(1.13) \quad \begin{array}{c} \text{Diagram 1} \\ \text{Diagram 2} \end{array} = \begin{array}{c} \text{Diagram 3} \\ \text{Diagram 4} \end{array}$$

Our final relation holds if the square satisfies \star , has no μ -zero divisors, and satisfies condition R3: it is

$$(1.14) \quad \begin{array}{c} \text{Diagram 1} \\ \text{Diagram 2} \end{array} = \begin{array}{c} \text{Diagram 3} \\ \text{Diagram 4} \end{array}$$

The polynomial in the box is $\frac{\mu_{grb}\mu_g\mu_r\mu_b}{\mu_{gr}\mu_{rb}\mu_{gb}}$, which is a genuine polynomial by assumption R3.

Definition 1.12. Suppose that Γ satisfies \star . We denote by $\mathcal{D}(\Gamma)$ the diagrammatic 2-category whose objects are subsets $I \subset \Gamma$, whose 1-morphisms are generated by up and down arrows for each edge of the hypercube, and whose 2-morphisms are (linear combinations of) consistent diagrams of colored transversely-intersecting oriented planar 1-manifolds with boxes, modulo the relations above. Let \mathcal{F} be the obvious 2-functor $\mathcal{D}(\Gamma) \rightarrow \mathcal{C}(\Gamma)$, sending cups caps and crossings to the appropriate bimodule maps.

We do not claim that \mathcal{F} is full or faithful. In any reasonable example there will be additional relations which do not hold in the general case, so that \mathcal{F} will not be faithful. For the Soergel bimodule example \mathcal{F} is full, though we do not know if \mathcal{F} will be full in general. We also do not assert that this is a complete list of relations for a generic Frobenius hypercube, or that every generic relation can be expressed with diagrams using at most 3 colors.

Remark 1.13. It is a consequence of the relations that any diagram in $\mathcal{D}(\Gamma)$ with only 2 colors can be “simplified,” i.e. expressed as a linear combination of diagrams without any closed 1-manifold components. Any 2-color diagram without boundary will reduce to a box. The simplification procedure is to pull apart strands using the Reidemeister II relations, until we separate a closed component from the rest of the diagram, and reduce it to a box using one-color relations.

Diagrams with 3 colors can not be simplified: we are only allowed to apply the Reidemeister III move (1.14) in one direction, unless the appropriate polynomials are present. This deficiency can not be remedied: for Example 1.5, there are bimodule morphisms which can not be expressed by diagrams without closed 1-manifolds.

Remark 1.14. We quickly comment on the form of the polynomials in relations (1.12) and (1.14) under the assumption that Γ has no μ -zero divisors. It is easy to show that $\mu_K^I = \mu_J^I \mu_K^J \in R^I$ whenever $I \subset J \subset K$. One can use this to show the existence of an element $\Pi_I \in R[\mu_\Gamma^{-1}]$ for each subset $I \subset \Gamma$, with $\Pi_\emptyset = 1$, such that μ_I is the product of Π_J over all $J \subset I$. For example if $\Gamma = \{r, b\}$ then using that

$$\mu_{rb} = \mu_{rb}^b \mu_b = \mu_{rb}^r \mu_r$$

we have $\Pi_{rb} = \mu_{rb}^b / \mu_r = \mu_{rb}^r / \mu_b = \mu_{rb} / \mu_r \mu_b$. Similarly $\frac{\mu_{grb} \mu_g \mu_b \mu_r}{\mu_{rb} \mu_r \mu_g \mu_b} = \Pi_{grb}$ etc.

In the setting of 1.5, these polynomials are easy to compute. When $I = \{i, i+1, \dots, j\}$ is an interval, then $\Pi_I = x_i - x_{j+1}$ is the highest root of W_I . When I is not an interval, $\Pi_I = 1$. Similar statements hold for any finite Weyl group, in the setting of 1.4.

Remark 1.15. A finite index von Neumann subfactor $N \subset M$ is an example of a Frobenius extension. Chains and squares of extensions have been studied before by people who work in the field of subfactors [1, 2, 5, 8]. In that context, the 2-category defined above is called the standard invariant, and similar diagrammatics have been developed for standard invariants of lattices of subfactors. However, there is a major difference between the subfactor world and ours: the rings they use are non-commutative but their center is trivial. Thus the complicated parts of their theory (non-commuting or non-cocommuting quadrilaterals) do not appear here, while the complicated part our theory (the behavior of the boxes) does not appear there. For example, in the subfactor setting a relation like (1.10) or (1.14) must be trivial if it exists, in the sense that the polynomial(s) appearing are equal to 1.

2. FURTHER DETAILS AND PROOFS

2.1. Frobenius Extensions. Suppose that $A \subset B$ is a Frobenius extension. The following statements are all standard, and hold for all $f \in B$.

$$(2.1) \quad f\Delta = \Delta f \in B \otimes_A B$$

$$(2.2) \quad \Delta_{(1)} \otimes \partial(f\Delta_{(2)}) = f \otimes 1 \in B \otimes_A B$$

$$(2.3) \quad \Delta_{(1)} \partial(f\Delta_{(2)}) = f \in B$$

These three equations are sufficient to prove (1.1) and (1.8). Relations (1.4) and (1.5) are obvious properties of polynomials. Relations (1.6) and (1.7) can be checked on the element 1, and follow immediately. The relation (1.8) implies the splitting of B into a free A module by decomposing the identity element into a sum of orthogonal idempotents.

Claim 2.1. *The 2-functor $\mathcal{F}: \mathcal{D}(A \subset B) \rightarrow \mathcal{C}(A \subset B)$ is an equivalence of categories.*

Proof. Let M and N be any two 1-morphisms between the same two objects in $\mathcal{D} = \mathcal{D}(A \subset B)$. The relations of \mathcal{D} imply biadjointness of ${}_A B_B$ and ${}_B B_A$, and the isomorphism ${}_A B_A \cong ({}_A A_A)^{\oplus n}$ where n is the rank of B over A . Using only these two facts, it is a simple exercise to express $\text{Hom}_{\mathcal{D}}(M, N)$ as a direct sum of copies of $\text{End}({}_A A_A)$ and $\text{End}({}_B B_B)$. In \mathcal{C} , the same expression for $\text{Hom}_{\mathcal{C}}(M, N)$ works, and the functor \mathcal{F} preserves both the adjunction morphisms and the direct sum decomposition, meaning that this expression for $\text{Hom}(M, N)$ is functorial under \mathcal{F} . Therefore, \mathcal{F} is fully faithful if and only if it induces isomorphisms on $\text{End}({}_A A_A)$ and $\text{End}({}_B B_B)$.

Since there is only one color, it is a simple inductive argument to show that any nested combination of circles and boxes in \mathcal{D} will reduce to a box. In particular, an

endomorphism of an empty region labelled A reduces to a box labelled by $f \in A$, so that it is generated as an A -module by the identity map. This A -module maps under \mathcal{F} to the free rank 1 A -module $\text{End}_C({}_A A)$, and therefore this map is an isomorphism. The same holds true for B . \square

2.2. Chains of Frobenius Extensions. Suppose that $A \subset B \subset C$ is a chain of Frobenius extensions. We equip C over A with a trace map $\partial_A^C = \partial_A^B \partial_B^C$. If $\{x_\alpha\}$ and $\{y_\alpha\}$ are dual bases of B over A , and $\{p_\beta\}$ and $\{q_\beta\}$ are dual bases of C over B , then $\{x_\alpha p_\beta\}$ and $\{y_\alpha q_\beta\}$ are dual bases of A over C . This makes it easy to see that $\Delta_A^C = \Delta_A^B \Delta_B^C$, where $\Delta_B^C: C \rightarrow C \otimes_B C \cong C \otimes_B B \otimes_B C$, and Δ_A^B is applied to the middle factor to reach $C \otimes_B B \otimes_A B \otimes_B C \cong C \otimes_A C$. In general, we will always identify $C \otimes_B B \otimes_A A$ with $C \otimes_A A$ using the canonical isomorphism. We have:

$$(2.4) \quad \Delta_A^C = \Delta_A^B \Delta_B^C$$

$$(2.5) \quad \mu_A^C = \mu_B^C \mu_A^B$$

$$(2.6) \quad \Delta_{A(1)}^C \otimes \partial_B^C(\Delta_{A(2)}^C) = \iota_B^C(\Delta_{A(1)}^B) \otimes \Delta_{A(2)}^B.$$

$$(2.7) \quad f \iota_B^C(\Delta_{A(1)}^B) \otimes \Delta_{A(2)}^B = \Delta_{A(1)}^C \otimes \partial_B^C(f \Delta_{A(2)}^C) \text{ for any } f \in C.$$

$$(2.8) \quad \Delta_{A(1)}^C \partial_B^C(\Delta_{A(2)}^C) = \mu_A^B$$

Similar statements hold when applying the operator ∂ to the left side instead of the right. We shall always assume this right-left symmetry.

The interesting equations (2.6) and (2.7) follow from unraveling this equality.

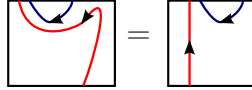

2.3. Squares of Frobenius Extensions. Suppose that $\Gamma = \{r, b\}$.

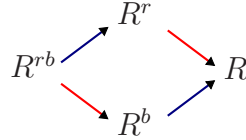

Recall that we label trace maps, comultiplications and the like by subsets of Γ . For instance, $\partial_{r^b}^r: R^r \rightarrow R^{rb}$, or $\Delta_b: R \rightarrow R \otimes_b R$, which is short for $R \otimes_{R^b} R$. Assume that this square is compatible, so that $\partial_{r^b}^r \partial_r = \partial_{r^b}^b \partial_b = \partial_{r^b}$. This implies the dual statement about comultiplication. We shall let inclusion maps ι be implied, so that $\partial_b(f)$ for $f \in R^r$ denotes $\partial_b(\iota_r(f))$.

Claim 2.2. *Relations (1.2) and (1.3) hold, so that an isotopy class of diagram unambiguously represents a morphism.*

Proof. For (1.2) these diagrams represent maps $R \rightarrow R^b$ as R^b -bimodules. The LHS sends $f \in R$ to $\partial_{rb}^r \partial_r f$ and the RHS to $\partial_{rb}^b \partial_b f$, which we have assumed are equal. For (1.3) these diagrams represent maps $R \otimes_{rb} R \rightarrow R$, and both sides are simply multiplication. \square

The oriented Reidemeister II move (1.9) is obvious. To examine the non-oriented Reidemeister II moves, we find formulae for sideways crossings. The left-pointing crossing gives a map from $R \rightarrow R^r \otimes_{rb} R^b$, for which the image of f is clearly the element in the next equality.

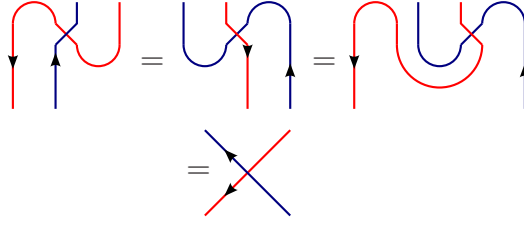

$$(2.9) \quad \Delta_{rb(1)}^r \otimes \partial_b(f \Delta_{rb(2)}^r) = \partial_r(f \Delta_{rb(1)}^b) \otimes \Delta_{rb(2)}^b = \partial_r(f \Delta_{rb(1)}) \otimes \partial_b(\Delta_{rb(2)}) \in R^r \otimes_{rb} R^b.$$

The right-pointing crossing gives a map $R^r \otimes_{rb} R^b \rightarrow R$, which can easily be verified to be the multiplication map. The counterclockwise Reidemeister II move (1.10) and its analog (1.11) are now obvious. Because the maps are (R^r, R^b) -linear, one can check these equalities on the image of $1 \otimes 1$.

Consider the clockwise Reidemeister II move (1.12), an equality of endomorphisms of R as an (R^r, R^b) -bimodule. The RHS is a morphism which is R -linear, while the LHS is not obviously R -linear. The image of 1 under both sides is $\partial_r(\Delta_{rb(1)}^b) \Delta_{rb(2)}^b$, or any of its equivalent presentations above. Therefore the relation will hold if and only if the LHS is R -linear. Suppose that R is generated as an algebra by its subalgebras R^r and R^b . Then the (R^r, R^b) -bilinearity of the LHS will actually imply R -linearity.

Claim 2.3. *If the square satisfies \star and has no μ -zero divisors then*

$$\partial_r(\Delta_{rb(1)}^b) \Delta_{rb(2)}^b = \frac{\mu_{rb}}{\mu_r \mu_b}.$$

Proof. Choose dual bases $\{x_\alpha\}$ and $\{y_\alpha\}$ of R over R^b such that $x_\alpha \in R^r$. Also choose dual bases $\{p_\beta\}$ and $\{q_\beta\}$ of R^b over R^{rb} . Then we are examining $\sum_\beta \partial_r(p_\beta) q_\beta$. Multiplying this by μ_b , we obtain

$$\sum_{\alpha, \beta} x_\alpha \partial_r(p_\beta) y_\alpha q_\beta = \sum_{\alpha, \beta} \partial_r(x_\alpha p_\beta) y_\alpha q_\beta = \partial_r(\Delta_{rb(1)}) \Delta_{rb(2)} = \mu_{rb}^r = \frac{\mu_{rb}}{\mu_r}.$$

So dividing by μ_b again, we get $\frac{\mu_{rb}}{\mu_r \mu_b}$. \square

Proposition 2.4. *Suppose that all the Reidemeister II relations hold. Any morphism in $\mathcal{D}(\Gamma)$ for a Frobenius square is a linear combination of diagrams with no closed components of either color.*

Proof. We show this by induction on subdiagrams, and on the total number of components. The base case is the empty diagram, perhaps with a box. Given a general diagram, let us assume inductively that all proper closed subdiagrams may be reduced to boxes. Suppose there is a closed red component. If any blue strands intersect it, we choose an “innermost” strand, so that there is an instance of the LHS of some Reidemeister II relation without any additional blue strands crossing the red one in the picture. There may be other junk on the interior of the picture, but the interior is a proper closed subdiagram so we may reduce the interior to a box. Depending on the orientation, we may either slide the box out and apply (1.12) or (1.9), or may simply apply (1.11), so that the blue strand no longer intersects the red component. Repeating this argument, we may assume that no blue strands intersect the red component. Then we reduce the interior of the component to a box, and use the circle relations (1.6) and (1.7) to eliminate the red component in question. This entire procedure may have added boxes in various regions, but did not otherwise affect the topology of the diagram except by removing components. By induction, the remaining diagram can be reduced. \square

Remark 2.5. We do not have an analog of Claim 2.1 for the case of two colors. By simplifying diagrams, we know that the endomorphisms of an empty region labelled I are isomorphic to R^I , as desired. However, adjunction and direct sum decompositions are not sufficient to reduce any Hom space to this form. In Example 1.4 for a finite rank 2 Coxeter group, an additional relation is required.

2.4. Cubes of Frobenius Extensions. Suppose that $\Gamma = \{r, b, g\}$, and we have a compatible cube of Frobenius extensions.

For the obvious reasons, any upward-oriented Reidemeister III equality (1.13) will hold.

Consider diagrams which look like Reidemeister III but with different orientations. Any picture where the interior triangle does *not* have an oriented boundary will be a rotation of the upward-oriented Reidemeister III move, and thus we are allowed to slide one line over the crossing. Any picture with an interior triangle which has clockwise or counter-clockwise orientation will not permit such a slide, requiring a relation like (1.14). Our proof assumes condition \star , that there are no μ -zero divisors, and condition $R3$.

Proof of (1.14). We can write

$$\Pi_{grb} = \frac{\mu_{rgb}\mu_r\mu_g\mu_b}{\mu_{rg}\mu_{rb}\mu_{gb}} = pq^{-1}$$

where

$$p = \frac{\mu_{grb}\mu_g}{\mu_{rg}\mu_{bg}} = \frac{\mu_{rgb}^g}{\mu_{rg}^g\mu_{bg}^g} \quad \text{and} \quad q = \frac{\mu_{rb}}{\mu_r\mu_b}.$$

Then we have

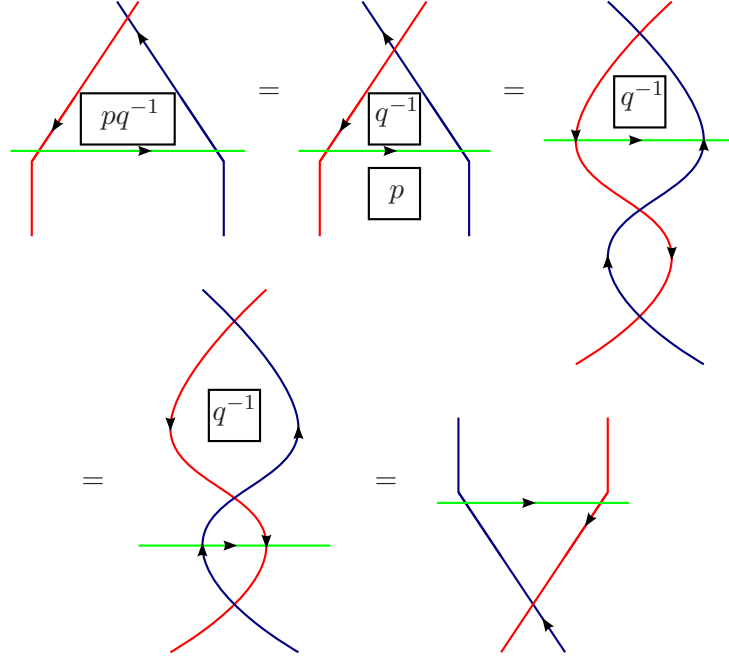

where for the last equality we are claiming

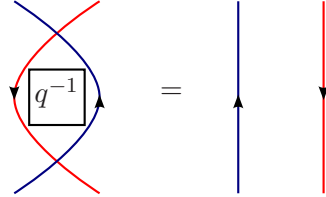

In other words, by (1.11) we have reduced the proof to the identity:

$$(2.10) \quad \Delta_{rb,(1)}^b \otimes \partial_r(q^{-1}\Delta_{rb,(2)}^b) = 1 \otimes 1 \quad \text{in } R^b \otimes_{R^rb} R^r.$$

Note that

$$q^{-1} = (\mu_{rb}^b)^{-1}\mu_r$$

and by condition \star we can choose dual bases $\{c_\alpha\}$ and $\{d_\alpha\}$ for R^r over R such that $c_\alpha \in R^b$. Then we have

$$q^{-1} = \sum_{\alpha} (\mu_{rb}^b)^{-1} c_\alpha d_\alpha$$

and we get identity (2.10) as follows:

$$\begin{aligned} \Delta_{rb,(1)}^b \otimes \partial_r(q^{-1}\Delta_{rb,(2)}^b) &= \sum_{\alpha} \Delta_{rb,(1)}^b \otimes \partial_r((\mu_{rb}^b)^{-1} c_\alpha d_\alpha \Delta_{rb,(2)}^b) \\ &\stackrel{(1)}{=} \sum_{\alpha} (\mu_{rb}^b)^{-1} \Delta_{rb,(1)}^b c_\alpha \otimes \partial_r(d_\alpha \Delta_{rb,(2)}^b) \\ &\stackrel{(2)}{=} (\mu_{rb}^b)^{-1} \Delta_{rb,(1)}^b \Delta_{rb,(2)}^b \otimes 1 = 1 \otimes 1. \end{aligned}$$

For (1) we have used (2.9), which implies that

$$\Delta_{rb,(1)}^b \otimes \partial_r((fg\Delta_{rb,(2)}^b)) = f\Delta_{rb,(1)}^b \otimes \partial_r((g\Delta_{rb,(2)}^b)) \quad \text{for } f \in R^b.$$

Finally, (2) follows from (2.7) with $A = B = R^r$ and $C = R$. \square

REFERENCES

- [1] D. Bisch and V. F. R. Jones, Algebras associated to intermediate subfactors, *Invent. Math.* **128** (1997), 89–157.
- [2] P. Grossman and V. F. R. Jones, Intermediate subfactors with no extra structure, preprint 2005, arXiv:math/0412423v3.
- [3] L. Kadison, New examples of Frobenius algebras, *AMS University Lecture Series* **14** (1999).
- [4] M. Khovanov, Heisenberg algebra and a graphical calculus, preprint 2010, arXiv:1009.3295v1.
- [5] Z. Landau, Fuss-Catalan algebras and chains of intermediate subfactors, *Pac. J. of Math.* **197** (2001), no. 2, 325–367.
- [6] M. Khovanov and A. Lauda, A diagrammatic approach to categorification of quantum groups I, *Represent. Theory* **13** (2009), 309–347.
- [7] A. Lauda, A categorification of quantum $\mathfrak{sl}(2)$, *Adv. in Math.* **225** (2010), no. 6, 3327–3424. arXiv:0803.3652.
- [8] T. Sano and Y. Watatani, Angles between two subfactors, *J. Operator Thry.* **32** (1994), 209–241.
- [9] W. Soergel, The combinatorics of Harish-Chandra bimodules, *J. Reine Angew. Math.* **429** (1992), 49–74.
- [10] G. Williamson, Singular Soergel Bimodules, *Int. Math. Res. Not.* 2011, No. 20, 4555–4632 (2011).