

THE SYMPLECTIC PROPERTIES OF THE $\mathrm{PGL}(n, \mathbb{C})$ -GLUING EQUATIONS

STAVROS GAROUFALIDIS AND CHRISTIAN K. ZICKERT

ABSTRACT. In [12] we studied $\mathrm{PGL}(n, \mathbb{C})$ -representations of a 3-manifold via a generalization of Thurston's gluing equations. Neumann has proved some symplectic properties of Thurston's gluing equations that play an important role in recent developments of exact and perturbative Chern-Simons theory. In this paper, we prove the symplectic properties of the $\mathrm{PGL}(n, \mathbb{C})$ -gluing equations for all ideal triangulations of compact oriented 3-manifolds.

CONTENTS

1. Introduction	2
2. Preliminaries and statement of results	3
2.1. Triangulations	3
2.2. Thurston's gluing equations	3
2.3. Neumann's chain complex	4
2.4. Symplectic properties of the gluing equations	5
2.5. Statement of results	6
2.6. A side comment on quivers	7
3. Shape assignments and gluing equations	7
3.1. X -coordinates	9
4. Definition of the chain complex	9
4.1. Formulas for β and β^*	10
4.2. Formulas for α and α^*	10
5. Characterization of $\mathrm{Im}(\beta^*)$	11
5.1. Quad relations	11
5.2. Hexagon relations	12
6. The outer homology groups	13
6.1. Computation of $H_1(\mathcal{J}^g)$	13
6.2. Computation of $H_2(\mathcal{J}^g)$	14
6.3. Computation of $H_4(\mathcal{J}^g)$ and $H_5(\mathcal{J}^g)$.	19
7. The middle homology group	20
7.1. Cellular decompositions of the boundary	20

Date: October 8, 2013.

The authors were supported in part by the National Science Foundation.

1991 *Mathematics Classification.* Primary 57N10. Secondary 57M27.

Key words and phrases: ideal triangulations, generalized gluing equations, $\mathrm{PGL}(n, \mathbb{C})$ -gluing equations, shape coordinates, symplectic properties, Neumann-Zagier equations, quivers.

7.2. The intersection pairing	21
7.3. Definition of δ	22
7.4. Definition of γ	23
7.5. Proof of Theorem 2.8	28
8. Cusp equations and rank	28
8.1. Cusp equations	29
8.2. Linearizing the cusp equations	29
8.3. Proof of Corollaries 2.10 and 2.11	31
Acknowledgment	32
References	33

1. INTRODUCTION

Thurston’s gluing equations are a system of polynomial equations that were introduced to concretely construct hyperbolic structures. They are defined for every compact, oriented 3-manifold M with arbitrary, possibly empty, boundary together with a topological ideal triangulation \mathcal{T} . The system has the form

$$(1.1) \quad \prod_j z_j^{A_{ij}} \prod_j (1 - z_j)^{B_{ij}} = \epsilon_i,$$

where A and B are matrices whose columns are parametrized by the simplices of \mathcal{T} and ϵ_i is a sign. Each (non-degenerate) solution explicitly determines (up to conjugation) a representation of $\pi_1(M)$ in $\mathrm{PGL}(2, \mathbb{C})$.

The matrices A and B in (1.1) have some remarkable symplectic properties that play a fundamental role in exact and perturbative Chern-Simons theory for $\mathrm{SL}(2, \mathbb{C})$ [9, 4, 6, 8, 11, 13, 5].

In [12] Garoufalidis, Goerner and Zickert generalized Thurston’s gluing equations to representations in $\mathrm{PGL}(n, \mathbb{C})$, i.e. they constructed a system of the form (1.1) such that each solution determines a representation of $\pi_1(M)$ in $\mathrm{PGL}(n, \mathbb{C})$. The $\mathrm{PGL}(n, \mathbb{C})$ -gluing equations are expected to play a similar role in $\mathrm{PGL}(n, \mathbb{C})$ -Chern-Simons theory as Thurston’s gluing equations play in $\mathrm{PSL}(2, \mathbb{C})$ -Chern-Simons theory.

In this paper we focus on the symplectic properties of the $\mathrm{PGL}(n, \mathbb{C})$ -gluing equations. This was initiated in [12], where we proved that the rows of $(A|B)$ are symplectically orthogonal. The symplectic properties for $n = 2$ play a key role in the definition of the formal power series invariants of [8] (conjectured to be asymptotic to all orders of the Kashaev invariant) and in the definition of the 3D-index of Dimofte–Gaiotto–Gukov [6] whose convergence and topological invariance was established in [11] and [13]. Our results fulfill a wish of the physics literature [5], and may be used for an extension of the work [8, 13, 3] to the setting of the $\mathrm{PGL}(n, \mathbb{C})$ -representations.

2. PRELIMINARIES AND STATEMENT OF RESULTS

2.1. Triangulations. Let M be a compact, oriented 3-manifold with (possibly empty) boundary, and let \widehat{M} be the space obtained from M by collapsing each boundary component to a point.

Definition 2.1. A (topologically ideal) *triangulation* of M is an identification of M with a space obtained from a collection of simplices by gluing together pairs of faces via affine homeomorphisms. A *concrete triangulation* is a triangulation together with an identification of each simplex of M with a standard ordered 3-simplex. A concrete triangulation is *oriented* if for each simplex, the orientation induced by the identification with a standard simplex agrees with the orientation of M .

Remark 2.2. Unless otherwise specified, a triangulation always refers to an *oriented* triangulation. The census triangulations are concrete triangulations, which are oriented when M is orientable. All of our results can be generalized to arbitrary concrete triangulations (e.g. ordered triangulations) by introducing additional signs. We will not pursue this here.

2.2. Thurston's gluing equations. We briefly review Thurston's gluing equations. For details, see Thurston [18] or Neumann–Zagier [17]. Let $z_j \in \mathbb{C} \setminus \{0, 1\}$ be complex numbers, one for each simplex Δ_j of \mathcal{T} . Assign *shape parameters* z_j , $z'_j = \frac{1}{1-z_j}$ and $z''_j = 1 - \frac{1}{z_j}$ to the edges of Δ_j as in Figure 1.

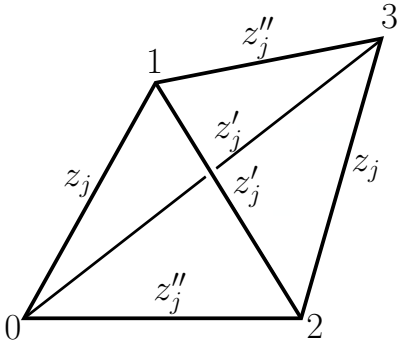

Figure 1. Shape parameters.

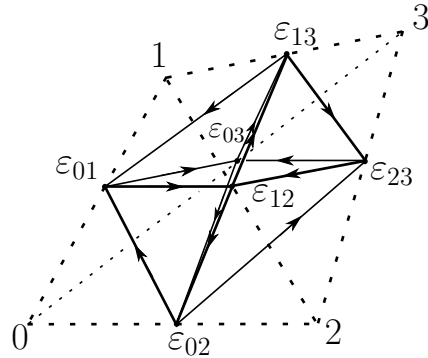

Figure 2. Quiver representation of Ω .

2.2.1. Edge equations. We have a gluing equation for each 1-cell e of \mathcal{T} defined by setting equal to 1 the product of all shape parameters assigned to the edges of e . The gluing equation for e can thus be written in the form

$$(2.1) \quad \prod_j (z_j)^{A'_{e,j}} \prod_j (z'_j)^{B'_{e,j}} \prod_j (z''_j)^{C'_{e,j}} = 1, \quad \text{or} \quad \prod_j (z_j)^{A_{e,j}} \prod_j (1 - z_j)^{B_{e,j}} = \varepsilon_e$$

where $A = A' - C'$ and $B = C' - B'$ are the so-called gluing equation matrices. Each solution determines a representation $\pi_1(M) \rightarrow \mathrm{PGL}(2, \mathbb{C})$. Note that the rows of the gluing equation matrices are parametrized by 1-cells, and the columns by the simplices of \mathcal{T} .

2.2.2. *Cusp equations.* Each solution $z = \{z_j\}$ to the edge equations gives rise to a cohomology class $C(z) \in H^1(\partial M; \mathbb{C}^*)$ obtained by taking the product of the shape parameters along normal curves. This class vanishes if and only if the representation corresponding to z is boundary-unipotent. The vanishing of $C(z)$ is equivalent to a system of equations

$$(2.2) \quad \prod_j (z_j)^{A_{\alpha,j}^{\text{cusp}'}} \prod_j (z'_j)^{B_{\alpha,j}^{\text{cusp}'}} \prod_j (z''_j)^{C_{\alpha,j}^{\text{cusp}'}} = 1, \quad \text{or} \quad \prod_j (z_j)^{A_{\alpha,j}^{\text{cusp}}} \prod_j (1 - z_j)^{B_{\alpha,j}^{\text{cusp}}} = \varepsilon_\alpha$$

of the form (2.1) with an equation for each generator α of $H_1(\partial M)$. These equations are called *cusp equations*. Note that the rows of the cusp equation matrices are parametrized by generators α of $H_1(\partial M)$, and the columns by the simplices of \mathcal{T} .

sub.Nchain

2.3. **Neumann's chain complex.** For an ordered 3-simplex Δ , let J_Δ denote the free abelian group generated by the *unoriented* edges of Δ subject to the relations

$$(2.3) \quad \varepsilon_{01} = \varepsilon_{23}, \quad \varepsilon_{12} = \varepsilon_{03}, \quad \varepsilon_{02} = \varepsilon_{13}$$

$$(2.4) \quad \varepsilon_{01} + \varepsilon_{12} + \varepsilon_{02} = 0.$$

Here ε_{ij} denotes the edge between vertices i and j of Δ . Note that (2.3) states that two opposite edges are equal, and that (2.3) and (2.4) together imply that the sum of the edges incident to a vertex is 0.

The space J_Δ is endowed with a non-degenerate skew symmetric bilinear form Ω defined uniquely by

$$(2.5) \quad \Omega(\varepsilon_{01}, \varepsilon_{12}) = \Omega(\varepsilon_{12}, \varepsilon_{02}) = \Omega(\varepsilon_{02}, \varepsilon_{01}) = 1.$$

The form Ω may be represented by the quiver in Figure 2. Namely, each edge corresponds to a vertex of the quiver, and $\Omega(\varepsilon, \varepsilon') = 1$ if and only if there is a directed edge in the quiver going from ε to ε' .

Neumann [16, Thm 4.1] encoded the symplectic properties of the gluing equations in terms of a chain complex $\mathcal{J} = \mathcal{J}(\mathcal{T})$ (indexed such that $\mathcal{J}_5 = \mathcal{J}_1 = C_0(\mathcal{T})$)

$$(2.6) \quad 0 \longrightarrow C_0(\mathcal{T}) \xrightarrow{\alpha} C_1(\mathcal{T}) \xrightarrow{\beta} J(\mathcal{T}) \xrightarrow{\beta^*} C_1(\mathcal{T}) \xrightarrow{\alpha^*} C_0(\mathcal{T}) \longrightarrow 0$$

defined combinatorially from the triangulation \mathcal{T} . Here

- $C_i(\mathcal{T})$ is the free \mathbb{Z} -module of the unoriented i -simplices of \mathcal{T} .
- $J(\mathcal{T}) = \bigoplus_{\Delta \in \mathcal{T}} J_\Delta$, with Ω extended orthogonally.
- α takes a 0-cell to the sum of incident 1-cells.
- β takes a 1-cell to the sum of its edges.
- α^* maps an edge to the sum of its endpoints.
- β^* is the unique rotation preserving map taking ε_{01} to $[\varepsilon_{03}] + [\varepsilon_{12}] - [\varepsilon_{02}] - [\varepsilon_{13}]$.

Since $\beta^* \circ \beta = 0$, $\text{Ker}(\beta^*)$ is orthogonal to $\text{Im}(\beta)$, so Ω descends to a form on $H_3(\mathcal{J})$, which is non-degenerate modulo torsion.

Theorem 2.3 (Neumann [16, Thm 4.2]). *The homology groups of \mathcal{J} are given by*

$$(2.7) \quad \begin{aligned} H_5(\mathcal{J}) &= 0, & H_4(\mathcal{J}) &= \mathbb{Z}/2\mathbb{Z}, & H_3(\mathcal{J}) &= K \oplus H^1(\widehat{M}; \mathbb{Z}/2\mathbb{Z}) \\ H_2(\mathcal{J}) &= H_1(\widehat{M}; \mathbb{Z}/2\mathbb{Z}), & H_1(\mathcal{J}) &= \mathbb{Z}/2\mathbb{Z}, \end{aligned}$$

where $K = \mathrm{Ker}(H_1(\partial M, \mathbb{Z}) \longrightarrow H_1(M, \mathbb{Z}/2\mathbb{Z}))$. Moreover, the isomorphism

$$(2.8) \quad H_3(\mathcal{J})/\mathrm{torsion} \cong K$$

identifies Ω with the intersection form on $H_1(\partial M)$.

Remark 2.4. Under the isomorphism

$$(2.9) \quad H_3(\mathcal{J}) \otimes \mathbb{Z}[1/2] \cong H_1(\partial M; \mathbb{Z}[1/2]),$$

the form Ω corresponds to *twice* the intersection form.

2.4. Symplectic properties of the gluing equations. Neumann's result implies some important symplectic properties of the gluing equation matrices. We formulate them here in a way that generalizes to the $\mathrm{PGL}(n, \mathbb{C})$ setting.

By the definition of β we have for each 1-cell e an element

$$(2.10) \quad \beta(e) = \sum_j A'_{e,j} \varepsilon_{01,j} + \sum_j B'_{e,j} \varepsilon_{12,j} + \sum_j C'_{e,j} \varepsilon_{02,j} = \sum_j A_{e,j} \varepsilon_{01,j} + \sum_j B_{e,j} \varepsilon_{12,j}$$

in $\mathrm{Im}(\beta)$. Similarly, for a generator α of $H_1(\partial M)$, we have the element

$$(2.11) \quad \delta(\alpha) = \sum_j A'_{e,j} \varepsilon_{01,j} + \sum_j B'_{e,j} \varepsilon_{12,j} + \sum_j C'_{e,j} \varepsilon_{02,j} = \sum_j A_{e,j} \varepsilon_{01,j} + \sum_j B_{e,j} \varepsilon_{12,j},$$

which Neumann shows is in $\mathrm{Ker}(\beta^*)$.

Corollary 2.5. Let w_J be the standard symplectic form on \mathbb{Z}^{2t} given by $J = \begin{pmatrix} 0 & I \\ -I & 0 \end{pmatrix}$, where t is the number of simplices of \mathcal{T} and let ι denote the intersection form on $H_1(\partial M)$.

- (i) For any rows x and y of $(A|B)$, $w(x, y) = 0$.
- (ii) For any rows x of $(A|B)$ and y of $(A^{\mathrm{cusp}}|B^{\mathrm{cusp}})$, $w(x, y) = 0$.
- (iii) For any rows x and y of $(A^{\mathrm{cusp}}|B^{\mathrm{cusp}})$ corresponding to α and β in $H_1(M, \partial M)$, respectively, $w(x, y) = \Omega(\delta(\alpha), \delta(\beta)) = 2\iota(\alpha, \beta)$.

Proof. The first and second statement follow from the fact that $\beta^* \circ \beta = 0$, which implies that $\mathrm{Ker}(\beta^*)$ is symplectically orthogonal to $\mathrm{Im}(\beta)$. The third result is proved in Neumann [16], c.f. Remark 2.4. Namely $\delta: H_1(\partial M) \rightarrow H_3(\mathcal{J})$ induces the isomorphism in (2.9). \square

Corollary 2.6. The rank of $(A|B)$ is the number of edges minus the number of cusps.

Proof. This follows from the fact that $H_4(\mathcal{J})$ is zero modulo torsion. \square

Remark 2.7. A simple argument that uses the Euler characteristic shows that the number of edges of \mathcal{T} equals $t + c - h$, where t is the number of simplices, $h = \frac{1}{2} \mathrm{rank}(H_1(\partial M))$ and c is the number of boundary components. Hence, the matrix $(A|B)$ has dimension $(t + c - h) \times 2t$. In particular, if all boundary components are tori (the case of most interest), the dimension is $t \times 2t$. If we extend a basis for the row span of $(A|B)$ by cusp equations, the resulting $t \times 2t$ matrix has full rank, and is the upper half of a symplectic matrix. Such matrices play a crucial role in [4, 8, 7, 6, 13].

2.5. Statement of results. As described in [12] (and reviewed in Section 3 below), there is a $\mathrm{PGL}(n, C)$ -gluing equation for each non-vertex integral point p of \mathcal{T} . The gluing equation for p can be written as

$$(2.12) \quad \prod_{(s,\Delta)} (z_{s,\Delta})^{A_{p,(s,\Delta)}} \prod_{(s,\Delta)} (1 - z_{s,\Delta})^{B_{p,(s,\Delta)}} = \varepsilon_p$$

for matrices A and B whose rows are parametrized by the (non-vertex) integral points of \mathcal{T} and columns by the set of subsimplices of the simplices of \mathcal{T} .

Furthermore there is a cusp equation for each generator $\alpha \otimes e_r$ of $H_1(\partial M; \mathbb{Z}^{n-1})$ of the form

$$(2.13) \quad \prod_{(s,\Delta)} (z_{s,\Delta})^{A_{\alpha \otimes e_r, (s,\Delta)}^{\mathrm{cusp}}} \prod_{(s,\Delta)} (1 - z_{s,\Delta})^{B_{\alpha \otimes e_r, (s,\Delta)}^{\mathrm{cusp}}} = \varepsilon_{\alpha \otimes e_r}$$

for matrices A^{cusp} and B^{cusp} whose rows are parametrized by generators $\alpha \otimes e_r$ of $H_1(\partial M; \mathbb{Z}^{n-1})$ and columns by the set of subsimplices of the simplices of \mathcal{T} .

In Section 4 below we define a chain complex $\mathcal{J}^{\mathfrak{g}} = \mathcal{J}^{\mathfrak{g}}(\mathcal{T})$ (indexed such that $\mathcal{J}_5^{\mathfrak{g}} = \mathcal{J}_1^{\mathfrak{g}} = C_0^{\mathfrak{g}}(\mathcal{T})$)

$$(2.14) \quad 0 \longrightarrow C_0^{\mathfrak{g}}(\mathcal{T}) \xrightarrow{\alpha} C_1^{\mathfrak{g}}(\mathcal{T}) \xrightarrow{\beta} J^{\mathfrak{g}}(\mathcal{T}) \xrightarrow{\beta^*} C_1^{\mathfrak{g}}(\mathcal{T}) \xrightarrow{\alpha^*} C_0^{\mathfrak{g}}(\mathcal{T}) \longrightarrow 0$$

generalizing (2.6). Here \mathfrak{g} denotes the Lie algebra of $\mathrm{SL}(n, \mathbb{C})$, the notation being in anticipation of a generalization to arbitrary simple, complex Lie algebras. The three middle terms of $\mathcal{J}^{\mathfrak{g}}$ appeared already in Garoufalidis–Goerner–Zickert [12]. There is a non-degenerate antisymmetric form on $J^{\mathfrak{g}}(\mathcal{T})$ descending to a non-degenerate form on $H_3(\mathcal{J}^{\mathfrak{g}})$ modulo torsion.

Theorem 2.8. *Let $h = \frac{1}{2} \mathrm{rank}(H_1(\partial M))$. The homology groups of $\mathcal{J}^{\mathfrak{g}}$ are given by*

$$(2.15) \quad \begin{aligned} H_5(\mathcal{J}^{\mathfrak{g}}) &= 0, & H_4(\mathcal{J}^{\mathfrak{g}}) &= \mathbb{Z}/n\mathbb{Z}, & H_3(\mathcal{J}^{\mathfrak{g}}) &= K \oplus H^1(\widehat{M}; \mathbb{Z}/n\mathbb{Z}) \\ H_2(\mathcal{J}^{\mathfrak{g}}) &= H_1(\widehat{M}; \mathbb{Z}/n\mathbb{Z}), & H_1(\mathcal{J}^{\mathfrak{g}}) &= \mathbb{Z}/n\mathbb{Z}, \end{aligned}$$

where $K \subset H_1(\partial M; \mathbb{Z}^{n-1})$ is a subgroup of index n^h . Moreover, the isomorphism

$$(2.16) \quad H_3(\mathcal{J}^{\mathfrak{g}}) \otimes \mathbb{Z}[1/n] \cong H_1(\partial M; \mathbb{Z}[1/n]^{n-1})$$

identifies Ω with the non-degenerate form $\omega_{A_{\mathfrak{g}}}$ on $H_1(\partial M; \mathbb{Z}[1/n]^{n-1})$ given by

$$(2.17) \quad \omega_{A_{\mathfrak{g}}}(\alpha \otimes v, \beta \otimes w) = \iota(\alpha, \beta) \langle v, A_{\mathfrak{g}} w \rangle,$$

where ι is the intersection form and $A^{\mathfrak{g}}$ is the Cartan matrix of \mathfrak{g} . □

Remark 2.9. Presumably, $K = \mathrm{Ker}(H_1(\partial M; \mathbb{Z}^{n-1}) \rightarrow H_1(M; \mathbb{Z}/n\mathbb{Z}))$, where $\mathbb{Z}/n\mathbb{Z}$ is regarded as the quotient of \mathbb{Z}^{n-1} by the Cartan matrix. This would be analogous to Neumann's result Theorem 2.3.

For each integral point p , the element

$$(2.18) \quad \sum_{(s,\Delta)} A_{p,(s,\Delta)}(s, \varepsilon_{01})_{\Delta} + \sum_{s,\Delta} B_{p,(s,\Delta)}(s, \varepsilon_{12})_{\Delta}$$

equals $\beta(p)$, and is thus in $\mathrm{Im}(\beta)$. For each generator $\alpha \otimes e_r$ of $H_1(\partial M; \mathbb{Z}^{n-1})$ we show that the element

$$(2.19) \quad \sum_{(s, \Delta)} A_{\alpha \otimes e_r, (s, \Delta)}^{\mathrm{cusp}}(s, \varepsilon_{01})_{\Delta} + \sum_{(s, \Delta)} B_{\alpha \otimes e_r, (s, \Delta)}^{\mathrm{cusp}}(s, \varepsilon_{12})_{\Delta},$$

is in the kernel of β^* . In fact it equals $\delta'(\alpha \otimes e_r)$ for a map $\delta': H_1(\partial M; \mathbb{Z}^{n-1})$ which induces the isomorphism (2.16).

Analogously to Corollary 2.5 we have.

Corollary 2.10. The rows of $(A|B)$ and $(A^{\mathrm{cusp}}|B^{\mathrm{cusp}})$ are orthogonal with respect to the standard symplectic form ω_J . Moreover, if x and y are rows of $(A^{\mathrm{cusp}}|B^{\mathrm{cusp}})$ corresponding to $\alpha \otimes e_r$ and $\beta \otimes e_s$, respectively, we have

$$(2.20) \quad \omega_J(x, y) = \Omega(\delta'(\alpha \otimes e_r), \delta'(\beta \otimes e_s)) = \iota(\alpha, \beta)\langle e_r, A_{\mathfrak{g}}e_s \rangle. \quad \square$$

Corollary 2.11. The rank of $(A|B)$ is the number of non-vertex integral points minus $c(n-1)$, where c is the number of boundary components. \square

Remark 2.12. If all boundary components are tori, $(A|B)$ has twice as many columns as rows, and $c(n-1) = \frac{1}{2} \mathrm{rank} H_1(\partial M; \mathbb{Z}^{n-1})$. It follows that one can extend a basis for the row space of $(A|B)$ by adding cusp equations to obtain a matrix with full rank. This matrix is the upper part of a symplectic matrix and as stated in the introduction plays a crucial role in extending the work of [4, 8, 7, 6, 13] to the $\mathrm{PGL}(n, \mathbb{C})$ setting. This will be discussed in a future publication.

2.6. A side comment on quivers. If you take a quiver as in Figure 2 for each subsimplex and superimpose them canceling edges with opposite orientations, you get the quiver shown in Figure 3. Everything cancels in the interior. The quiver on the face equals the quiver in Fock–Goncharov [10, Fig. 1.5], and also appears for $n = 3$ in Bergeron–Falbel–Guilloux [2, Fig. 4]. One can go from the quiver on two of the faces to the quiver on the two other faces by performing quiver mutations (see e.g. Keller [15]). The quiver mutations change the X -coordinates and Ptolemy coordinates by cluster mutations [1], and there is a one-one correspondence between quiver mutations and subsimplices. Although we do not need any of this here, this observation was a major motivation for [14] and [12].

3. SHAPE ASSIGNMENTS AND GLUING EQUATIONS

Fix a manifold M with a triangulation \mathcal{T} . We identify each simplex of M with the simplex

$$(3.1) \quad \Delta_n^3 = \{(x_0, x_1, x_2, x_3) \in \mathbb{R}^4 \mid 0 \leq x_i \leq n, x_0 + x_1 + x_2 + x_3 = n\}.$$

Let $\Delta_n^3(\mathbb{Z})$ and denote the integral points of Δ_n^3 , and $\dot{\Delta}_n^3(\mathbb{Z})$ denote the integral points with the 4 vertex points removed. The natural left A_4 -action on Δ_n^3 given by

$$(3.2) \quad \sigma(x_0, \dots, x_3) = (x_{\sigma^{-1}(0)}, \dots, x_{\sigma^{-1}(3)})$$

induces A_4 -actions on $\Delta_n^3(\mathbb{Z})$ and $\dot{\Delta}_n^3(\mathbb{Z})$ as well.

Definition 3.1. A *subsimplex* of Δ_n^3 is a subset S of Δ_n^3 obtained by translating $\Delta_2^3 \subset \mathbb{R}^4$ by an element s in $\Delta_{n-2}^3(\mathbb{Z}) \subset \mathbb{Z}^4$, i.e. $S = s + \Delta_2^3$.

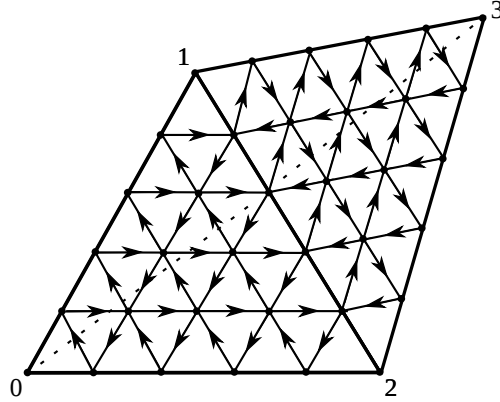

Figure 3. Superposition of copies of the quiver in Figure 2, one for each subsimplex.

We shall identify the edges of an ordered simplex with $\dot{\Delta}_2^3(\mathbb{Z})$, e.g. the edges ε_{01} and ε_{12} correspond to (1100) and (0110).

Definition 3.2. A shape assignment on Δ_n^3 is an assignment

$$(3.3) \quad z: \Delta_{n-2}^3(\mathbb{Z}) \times \dot{\Delta}_2^3(\mathbb{Z}) \rightarrow \mathbb{C} \setminus \{0, 1\}, \quad (s, e) \mapsto z_s^e$$

satisfying the *shape parameter relations*

$$(3.4) \quad z_s^{\varepsilon_{01}} = z_s^{\varepsilon_{23}} = \frac{1}{1 - z_s^{\varepsilon_{02}}}, \quad z_s^{\varepsilon_{12}} = z_s^{\varepsilon_{03}} = \frac{1}{1 - z_s^{\varepsilon_{01}}}, \quad z_s^{\varepsilon_{02}} = z_s^{\varepsilon_{13}} = \frac{1}{1 - z_s^{\varepsilon_{12}}}$$

One may think of a shape assignment as an assignment of shape parameters to the edges of each subsimplex. The ad hoc indexing of the shape parameters by z , z' and z'' is replaced by an indexing scheme, in which a shape parameter is indexed according to the edge to which it is assigned.

Definition 3.3. An *integral point* of \mathcal{T} is an equivalence class of points in $\Delta_n^3(\mathbb{Z})$ identified by the face pairings of \mathcal{T} . We view an integral point as a set of pairs (t, Δ) with $t \in \Delta_n^3(\mathbb{Z})$ and $\Delta \in \mathcal{T}$. An integral point is either a *vertex point*, an *edge point*, a *face point*, or an *interior point*.

Definition 3.4. A shape assignment on \mathcal{T} is a shape assignment $z_{s,\Delta}^e$ on each simplex $\Delta \in \mathcal{T}$ such that for each non-vertex integral point p , the *generalized gluing equation*

$$(3.5) \quad \prod_{(t,\Delta) \in p} \prod_{t=s+e} z_{s,\Delta}^e = 1.$$

is satisfied.

The gluing equation for p sets equal to 1 the product of the shape parameters of all edges of subsimplices having p as midpoint, see Figures 4 and 5 (taken from [12]).

Note that the gluing equation for p can be written in the form

$$(3.6) \quad \prod_{(s,\Delta)} (z_{(s,\Delta)})^{A_{p,(s,\Delta)}} \prod_{(s,\Delta)} (1 - z_{(s,\Delta)})^{B_{p,(s,\Delta)}} = \varepsilon_p$$

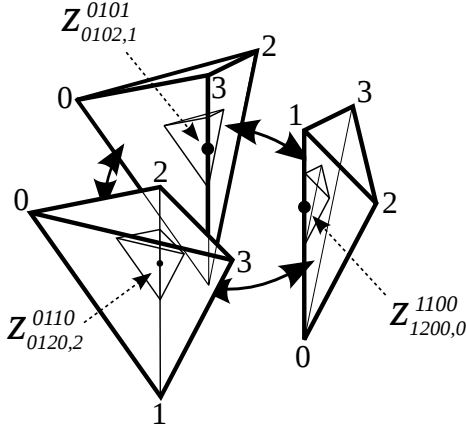

Figure 4. Edge equation for $n = 5$:

$$z_{1200,0}^{1100} z_{0102,1}^{0101} z_{0120,2}^{0110} = 1.$$

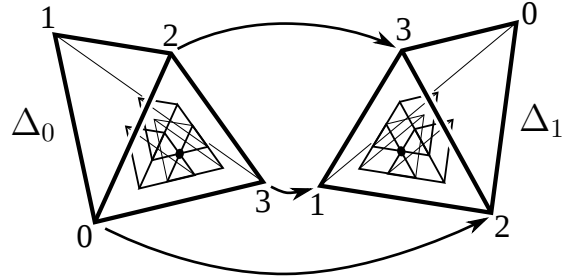

Figure 5. Face equation for $n = 6$:

$$z_{2011,0}^{0011} z_{1021,0}^{1001} z_{1012,0}^{1010} z_{0211,1}^{0011} z_{0121,1}^{0101} z_{0112,1}^{0110} = 1.$$

Theorem 3.5 (Garoufalidis–Goerner–Zickert [12]). *A shape assignment on \mathcal{T} determines a representation $\pi_1(M) \rightarrow \mathrm{PGL}(n, \mathbb{C})$.*

3.1. **X -coordinates.** The X -coordinates are defined on the face points of \mathcal{T} , and are used in Section 8 to define the cusp equations. They agree with the X -coordinates of Fock and Goncharov [10].

Definition 3.6. Let z be a shape assignment on Δ_n^3 and let $t \in \Delta_n^3(\mathbb{Z})$ be a face point. The X -coordinate at t is given by

$$(3.7) \quad X_t = - \prod_{s+e=t} z_s^e,$$

i.e. it equals (minus) the product of the shape parameters of the 3 edges of subsimplices having t as a midpoint.

Remark 3.7. Note that the gluing equation for a face point $p = \{(t_1, \Delta_1), (t_2, \Delta_2)\}$ states that $X_{t_1} X_{t_2} = 1$.

4. DEFINITION OF THE CHAIN COMPLEX

Let $C_0^{\mathfrak{g}}(\mathcal{T}) = C_0(\mathcal{T}) \otimes \mathbb{Z}^{n-1}$. Letting e_1, \dots, e_n , denote the standard basis vectors of \mathbb{Z}^{n-1} , it follows that $C_0^{\mathfrak{g}}(\mathcal{T})$ is generated by symbols $x \otimes e_i$, where x is a 0-cell of \mathcal{T} . It will occasionally be convenient to define $e_0 = e_n = 0$. Let $C_1^{\mathfrak{g}}(\mathcal{T})$ be the free abelian group on the non-vertex integral points of \mathcal{T} , and let

$$(4.1) \quad J^{\mathfrak{g}}(\mathcal{T}) = \bigoplus_{\Delta \in \mathcal{T}} \bigoplus_{s \in \Delta_{n-2}^3} J_{\Delta_2^3},$$

be a direct sum of copies of $J_{\Delta_2^3}$, one for each subsimplex of each simplex of \mathcal{T} . Note that $J^{\mathfrak{g}}(\mathcal{T})$ is generated by the set of all edges of all subsimplices of the simplices of \mathcal{T} . We denote a generator by $(s, e)_{\Delta}$. The form Ω on $J_{\Delta_2^3}$ induces by orthogonal extension a form on $J^{\mathfrak{g}}(\mathcal{T})$ also denoted by Ω . Since Ω is non-degenerate it induces a natural identification of $J^{\mathfrak{g}}(\mathcal{T})$

with its dual. Similarly, the natural bases of $C_0^{\mathfrak{g}}(\mathcal{T})$ and $C_1^{\mathfrak{g}}(\mathcal{T})$ induce natural identifications with their respective duals.

4.1. **Formulas for β and β^* .** Define

$$(4.2) \quad \beta: C_1^{\mathfrak{g}}(\mathcal{T}) \rightarrow J^{\mathfrak{g}}(\mathcal{T}), \quad p = \{(t, \Delta)\} \mapsto \sum_{(\Delta, t) \in p} \sum_{e+s=t} (s, e)_{\Delta}.$$

Hence, β takes p to the formal sum of all the edges of subsimplices whose midpoint is p . By [12, Lemma 7.3], the dual map $\beta^*: J^{\mathfrak{g}}(\mathcal{T}) \rightarrow C_1^{\mathfrak{g}}(\mathcal{T})$ is given by

$$(4.3) \quad \begin{aligned} (s, \varepsilon_{01})_{\Delta} &\mapsto [(s + \varepsilon_{03}, \Delta)] + [(s + \varepsilon_{12}, \Delta)] - [(s + \varepsilon_{02}, \Delta)] - [(s + \varepsilon_{13}, \Delta)] \\ (s, \varepsilon_{12})_{\Delta} &\mapsto [(s + \varepsilon_{02}, \Delta)] + [(s + \varepsilon_{13}, \Delta)] - [(s + \varepsilon_{01}, \Delta)] - [(s + \varepsilon_{23}, \Delta)] \\ (s, \varepsilon_{02})_{\Delta} &\mapsto [(s + \varepsilon_{01}, \Delta)] + [(s + \varepsilon_{23}, \Delta)] - [(s + \varepsilon_{23}, \Delta)] - [(s + \varepsilon_{12}, \Delta)]. \end{aligned}$$

We refer to an element of the form $\beta^*(s, \varepsilon_{ij})$ as an *elementary quad relation*, see Figures 6, 7 and 8.

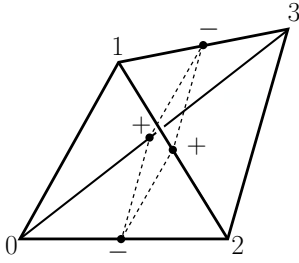

Figure 6. $\beta^*(s, \varepsilon_{01})$.

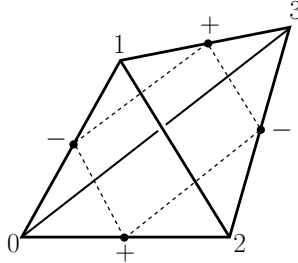

Figure 7. $\beta^*(s, \varepsilon_{12})$.

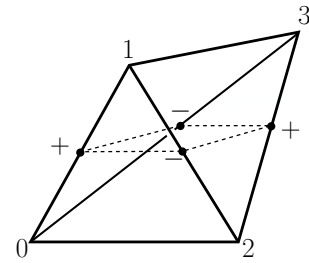

Figure 8. $\beta^*(s, \varepsilon_{02})$.

Lemma 4.1 (Garoufalidis–Goerner–Zickert [12, Prop. 7.4]). $\beta^* \circ \beta = 0$. \square

4.2. **Formulas for α and α^* .** For a 0-cell x of \mathcal{T} and a simplex Δ , let $I_{\Delta}(x) \subset \{0, 1, 2, 3\}$ be the set of vertices of Δ that are identified with x . Also, for $t \in \Delta_n^3(\mathbb{Z})$ and $k \in \{1, \dots, n-1\}$, let

$$(4.4) \quad c_{t, \Delta, k} = |\{i \in I_{\Delta}(x) \mid t_i = k\}|.$$

Note that if (t, Δ) and (t', Δ') define the same integral point, then $c_{t, \Delta, k} = c_{t', \Delta', k}$. Define

$$(4.5) \quad \alpha: C_0^{\mathfrak{g}}(\mathcal{T}) \rightarrow C_1^{\mathfrak{g}}(\mathcal{T}), \quad x \otimes e_k \mapsto \sum_p c_{t, \Delta, k} p.$$

Also, define

$$(4.6) \quad \alpha^*: C_1^{\mathfrak{g}}(\mathcal{T}) \rightarrow C_0^{\mathfrak{g}}(\mathcal{T}), \quad [(t, \Delta)] \mapsto \sum_{i=0}^3 x_i \otimes e_{t_i},$$

where x_i is the 0-cell of \mathcal{T} defined by the i th vertex of Δ . It is elementary to check that α^* is well defined, and that it is the dual of α .

Lemma 4.2. We have $\alpha^* \circ \beta^* = 0$.

Proof. Let $s \in \Delta_{n-2}^3(\mathbb{Z})$ be a subsimplex. We have

$$\begin{aligned} \alpha^* \circ \beta^*(s, \varepsilon_{01})_\Delta &= \alpha^*([(s + \varepsilon_{03}, \Delta)]) + \alpha^*([(s + \varepsilon_{12}, \Delta)]) \\ &\quad - \alpha^*([(s + \varepsilon_{02}, \Delta)]) - \alpha^*([(s + \varepsilon_{13}, \Delta)]) \\ &= x_0 \otimes e_{s_0+1} + x_1 \otimes e_{s_1} + x_2 \otimes e_{s_2} + x_3 \otimes e_{s_3+1} \\ &\quad + x_0 \otimes e_{s_1} + x_1 \otimes e_{s_1+1} + x_2 \otimes e_{s_2+1} + x_3 \otimes e_{s_3} \\ &\quad - x_0 \otimes e_{s_0+1} - x_1 \otimes e_{s_1} - x_2 \otimes e_{s_2+1} - x_3 \otimes e_{s_3} \\ &\quad - x_0 \otimes e_{s_0} - x_1 \otimes e_{s_1+1} - x_2 \otimes e_{s_2} - x_3 \otimes e_{s_3+1} = 0 \end{aligned}$$

Likewise, $\alpha^* \circ \beta^*(s, \varepsilon_{12})_\Delta = \alpha^* \circ \beta^*(s, \varepsilon_{02})_\Delta = 0$. \square

By duality, $\beta \circ \alpha$ is also 0, so we have a chain complex $\mathcal{J}^{\mathfrak{g}}(\mathcal{T})$:

$$(4.7) \quad 0 \longrightarrow C_0^{\mathfrak{g}}(\mathcal{T}) \xrightarrow{\alpha} C_1^{\mathfrak{g}}(\mathcal{T}) \xrightarrow{\beta} \mathcal{J}^{\mathfrak{g}}(\mathcal{T}) \xrightarrow{\beta^*} C_1^{\mathfrak{g}}(\mathcal{T}) \xrightarrow{\alpha^*} C_0^{\mathfrak{g}}(\mathcal{T}) \longrightarrow 0$$

Note that when $n = 2$, $\mathcal{J}^{\mathfrak{g}}$ equals \mathcal{J} .

Convention 4.3. When there can be no confusion, we shall sometimes suppress the simplex Δ from the notation. For example, we sometimes write (s, e) instead of $(s, e)_\Delta$, and if t is an integral point of a simplex Δ of \mathcal{T} , we denote the corresponding integral point of \mathcal{T} by $[t]$ or sometimes just t instead of $[(t, \Delta)]$.

5. CHARACTERIZATION OF $\mathrm{Im}(\beta^*)$

We develop some relations in $C_1^{\mathfrak{g}}(\mathcal{T})/\mathrm{Im}(\beta^*)$ that are needed for computing $H_2(\mathcal{J}^{\mathfrak{g}})$. These relations may be of independent interest.

5.1. Quad relations.

Definition 5.1. A *quadrilateral* (*quad* for short) in Δ_n^3 is the convex hull of 4 points

$$(5.1) \quad p_0 = a + (k, 0, 0, l), \quad p_1 = a + (k, 0, l, 0), \quad p_2 = a + (0, k, l, 0), \quad p_3 = a + (0, k, 0, l),$$

or the image of such under a permutation in S_4 . Here k, l are positive integers with $k + l \leq n$ and $a \in \Delta_{n-k-l}(\mathbb{Z})$. A quad determines a *quad relation* in $C_1^{\mathfrak{g}}(\mathcal{T})$ given by the alternating sum $p_0 - p_1 + p_2 - p_3$ of its corners.

Figure 9 shows 3 quad relations for $n = 4$.

Lemma 5.2. A quad relation is in the image of β^* , and is thus zero in $H_2(\mathcal{J}^{\mathfrak{g}})$.

Proof. Algebraically, we have

$$(5.2) \quad p_0 - p_1 + p_2 - p_3 = \sum_{1 < i \leq k, l < j \leq l} \beta^*(a + (k - i, i - 1, j - 1, l - j), \varepsilon_{01}).$$

For a geometric proof, note that any quad relation is a sum of the elementary quad relations in Figures 6, 7 and 8. \square

Recall that we have divided integral points into edge points, face points and interior points. We shall need a finer division.

Definition 5.3. The *type* of a point $t \in \Delta_n(\mathbb{Z})$ is the orbit of t under the S_4 action.

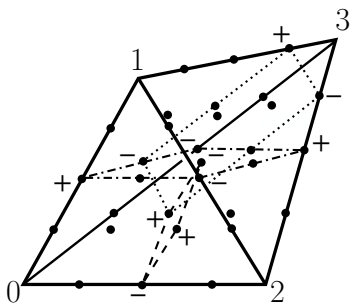

Figure 9. Quad relations.

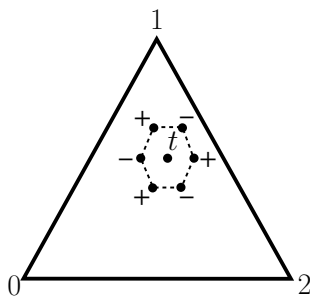

Figure 10. Hexagon relation.

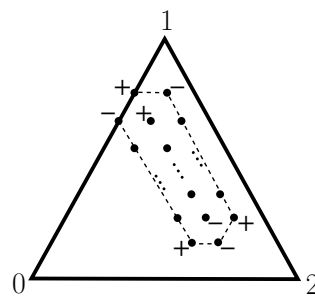

Figure 11. Long hexagon relation.

Note that the type is preserved under face pairings, so it makes sense to define the type of an integral point $p = \{(t, \Delta)\}$ to be the type of any representative.

Proposition 5.4. Let p and q be integral points of the same type. Then

$$(5.3) \quad p - q \in \text{Im}(\beta^*) + E,$$

where E is the subgroup of $C_1^g(\mathcal{T})$ generated by edge points.

Proof. We may assume that p and q lie in the same simplex. The quad relation (together with similar relations obtained by permutations)

$$(5.4) \quad (a_1, a_0, a_2, a_3) + (a_0, a_1, a_2 + a_3, 0) - (a_1, a_0, a_2 + a_3, 0) - (a_0, a_1, a_2, a_3)$$

shows that the difference between two interior points is equal modulo $\text{Im}(\beta^*)$ to the difference between two face points. Similarly, the relation

$$(5.5) \quad (a, b, 0, c) - (a, b, c, 0) + (0, a + b, c, 0) - (0, a + b, 0, c)$$

shows that the difference between two face points in distinct faces is in $\text{Im}(\beta^*) + E$. Finally, the two quad relations

$$(5.6) \quad \begin{aligned} (0, a, b, c) &= (a, 0, b, c) + (0, a, 0, b + c) - (a, 0, 0, c + b), \\ (0, a, c, b) &= (a, 0, c, b) + (0, a, b + c, 0) - (a, 0, b + c, 0) \end{aligned}$$

in $C_1^g(\mathcal{T})/\text{Im}(\beta^*)$ imply that the difference between two face points in the same face is also in $\text{Im}(\beta^*) + E$. This concludes the proof. \square

5.2. Hexagon relations. Besides the quad relations, we shall need further relations that lie entirely in a face.

Lemma 5.5. For any face point t , the element $\beta^*(\sum_{s+e=t}(s, e))$ is an alternating sum of the corners of a hexagon with center at t (see Figure 10).

Proof. By rotational symmetry, we may assume that $t = (t_0, t_1, t_2, 0)$. We thus have

$$(5.7) \quad \beta^*\left(\sum_{s+e=t}(s, e)\right) = \beta^*(t - \varepsilon_{01}, \varepsilon_{01}) + \beta^*(t - \varepsilon_{12}, \varepsilon_{12}) + \beta^*(t - \varepsilon_{02}, \varepsilon_{02}).$$

Using the formula (4.3) for β^* , (5.7) easily simplifies to

$$(5.8) \quad \beta^* \left(\sum_{s+e=t} (s, e) \right) = -[t + (-1, 1, 0, 0)] + [t + (-1, 0, 1, 0)] - [t + (0, -1, 1, 0)] \\ + [t + (1, -1, 0, 0)] - [t + (1, 0, -1)] + [t + (0, 1, -1, 0)].$$

This corresponds to the configuration in Figure 10. \square

Definition 5.6. An element as in Lemma 5.5 is called a *hexagon relation*. By taking sums of hexagon relation, we obtain relations as shown in Figure 11. We refer to these as *long hexagon relations* (a hexagon relation is also regarded as a long hexagon relation).

6. THE OUTER HOMOLOGY GROUPS

We focus on here on the computation of $H_1(\mathcal{J}^g)$ and $H_2(\mathcal{J}^g)$; the computation of $H_5(\mathcal{J}^g)$ and $H_4(\mathcal{J}^g)$ will follow by a duality argument (see Section 6.3).

6.1. Computation of $H_1(\mathcal{J}^g)$.

Proposition 6.1. $H_1(\mathcal{J}^g) = \mathbb{Z}/n\mathbb{Z}$.

Proof. Consider the map

$$\epsilon: C_0^g(\mathcal{T}) \rightarrow \mathbb{Z}/n, \quad x \otimes e_k \mapsto k.$$

One easily checks that $\mathrm{Im}(\alpha^*) \subset \mathrm{Ker}(\epsilon)$. To prove the other inclusion, let $[\sigma] \in H_1(\mathcal{J})$, and $\sigma = \sum_{i=1}^N \varepsilon_i x_i \otimes e_{k_i}$ a representative with N minimal and $\varepsilon_i = \pm 1$. We wish to prove that $N = 0$, so suppose $N > 0$. We start by showing that modulo $\mathrm{Im}(\alpha^*)$

$$(6.1) \quad x \otimes e_k + y \otimes e_{n-k} = 0, \quad x \otimes e_k - y \otimes e_k = 0.$$

Pick an edge path of odd length between x and y with vertices $x_0 = x, x_1, \dots, x_{2k-1} = y$. For z, w vertices joined by an edge e , let $(z, w; k)$ be the edge point on e at distance k from w . Then $\alpha^*(z, w; k) = z \otimes e_k + w \otimes e_{n-k}$. We thus have

$$(6.2) \quad x \otimes e_k + y \otimes e_{n-k} = \alpha^*((x, x_1; k) - (x_1, x_2; n-k) + \dots + (x_{2k-2}, y; k)).$$

This proves the first equation in (6.1). The second follows similarly by considering an edge path of even length. We may thus assume that $N \geq 3$. Without loss of generality $\varepsilon_0 = 1$, so that

$$(6.3) \quad \sigma = x_0 \otimes e_{k_0} + \varepsilon_1 x_1 \otimes e_{k_1} + \sum_{i=2}^n \varepsilon_i x_i \otimes e_{k_i}.$$

Using (6.1), we may assume that $k_0 + k_1 \leq n$ if $\varepsilon_1 = 1$ and $k_1 \geq k_0$ if $\varepsilon_1 = -1$. Fix three 0-cells x, y, z lying on a face, and let p be the unique integral point satisfying

$$(6.4) \quad \alpha^*(p) = \begin{cases} x \otimes e_{k_0} + y \otimes e_{k_1} + z \otimes e_{n-k_0-k_1} & \text{if } \varepsilon_1 = 1 \\ x \otimes e_{k_0} + y \otimes e_{n-k_1} + z \otimes e_{k_1-k_0} & \text{if } \varepsilon_1 = -1. \end{cases}$$

Subtracting $\alpha^*(p)$ from σ and using (6.1), we can thus construct a representative of $[\sigma]$ with fewer than N terms, contradicting minimality of N . Hence, $\sigma = 0$. \square

6.2. Computation of $H_2(\mathcal{J}^{\mathfrak{g}})$. In this section we prove that $H_2(\mathcal{J}^{\mathfrak{g}}) = H_1(\widehat{M}; \mathbb{Z}/n\mathbb{Z})$. The fact that $H_2(\mathcal{J}^{\mathfrak{g}})$ is torsion is crucial, and is used in the proof of Proposition 7.10. We see no way of proving that $H_2(\mathcal{J}^{\mathfrak{g}})$ is torsion without computing it explicitly.

We assume for convenience that the triangulation is ordered, i.e. that the face pairings are order preserving. The general case differs only in notation. Let $\varepsilon_{ij}^{\text{ori}}$ denote the *oriented* edge (from i to j) between i and j .

6.2.1. *Definition of a map $\nu: H_2(\mathcal{J}^{\mathfrak{g}}) \rightarrow H_1(\widehat{M}; \mathbb{Z}/n\mathbb{Z})$.* Consider the map

$$(6.5) \quad \nu: \mathbb{Z}[\dot{\Delta}_n^3(\mathbb{Z})] \rightarrow C_1(\Delta^3; \mathbb{Z}/n\mathbb{Z}), \quad (t_0, t_1, t_2, t_3) \mapsto t_1\varepsilon_{01}^{\text{ori}} + t_2\varepsilon_{02}^{\text{ori}} + t_3\varepsilon_{03}^{\text{ori}}.$$

Modulo boundaries in $C_1(\Delta^3; \mathbb{Z}/n\mathbb{Z})$, we have

$$(6.6) \quad t_1\varepsilon_{01}^{\text{ori}} + t_2\varepsilon_{02}^{\text{ori}} + t_3\varepsilon_{03}^{\text{ori}} = t_0\varepsilon_{10}^{\text{ori}} + t_2\varepsilon_{12}^{\text{ori}} + t_3\varepsilon_{13}^{\text{ori}} = t_0\varepsilon_{20}^{\text{ori}} + t_1\varepsilon_{21}^{\text{ori}} + t_3\varepsilon_{23}^{\text{ori}} = t_0\varepsilon_{30}^{\text{ori}} + t_1\varepsilon_{31}^{\text{ori}} + t_2\varepsilon_{32}^{\text{ori}}.$$

Lemma 6.2. The map

$$(6.7) \quad \nu: C_1^{\mathfrak{g}}(\mathcal{T}) \rightarrow C_1(\widehat{M}; \mathbb{Z}/n\mathbb{Z})/\{\text{boundaries}\}$$

induced by (6.7) takes cycles to cycles and boundaries to 0.

Proof. To see that cycles map to cycles consider the diagram

$$(6.8) \quad \begin{array}{ccc} C_1^{\mathfrak{g}}(\mathcal{T}) & \xrightarrow{\nu} & C_1(\widehat{M}; \mathbb{Z}/n\mathbb{Z})/\{\text{boundaries}\} \\ \downarrow \alpha^* & & \downarrow \partial \\ C_0^{\mathfrak{g}}(\mathcal{T}) & \xrightarrow{\nu_0} & C_0(\widehat{M}; \mathbb{Z}/n\mathbb{Z}), \end{array}$$

where ν_0 is the map given by

$$(6.9) \quad \nu_0: C_0^{\mathfrak{g}}(\mathcal{T}) \rightarrow C_0(\widehat{M}; \mathbb{Z}/n\mathbb{Z}), \quad x \otimes e_i \mapsto ix.$$

We must prove that (6.8) is commutative. This follows from

$$(6.10) \quad \begin{aligned} \partial(\nu(t)) &= \partial(t_1\varepsilon_{01}^{\text{ori}} + t_2\varepsilon_{02}^{\text{ori}} + t_3\varepsilon_{03}^{\text{ori}}) = \\ &= t_1(x_1 - x_0) + t_2(x_2 - x_0) + t_3(x_3 - x_0) = t_0x_0 + t_1x_1 + t_2x_2 + t_3x_3 = \alpha^*(t). \end{aligned}$$

We must check that image of $J^{\mathfrak{g}}(\mathcal{T})$ maps to 0. By rotational symmetry, it is enough to prove that ν takes $\beta^*(s, \varepsilon_{01})$ to 0. Using (4.3) we have

$$(6.11) \quad \begin{aligned} \nu(\beta^*(s, \varepsilon_{01})) &= (s_1\varepsilon_{01}^{\text{ori}} + s_2\varepsilon_{02}^{\text{ori}} + (s_3 + 1)\varepsilon_{03}^{\text{ori}}) + ((s_1 + 1)\varepsilon_{01}^{\text{ori}} + (s_2 + 1)\varepsilon_{02}^{\text{ori}} + s_3\varepsilon_{03}^{\text{ori}}) \\ &\quad - (s_1\varepsilon_{01}^{\text{ori}} + (s_2 + 1)\varepsilon_{02}^{\text{ori}} + s_3\varepsilon_{03}^{\text{ori}}) - ((s_1 + 1)\varepsilon_{01}^{\text{ori}} + s_2\varepsilon_{02}^{\text{ori}} + (s_3 + 1)\varepsilon_{03}^{\text{ori}}) = 0. \end{aligned}$$

This concludes the proof. \square

Hence, ν induces a map

$$(6.12) \quad \nu: H_2(\mathcal{J}^{\mathfrak{g}}) \rightarrow H_1(\widehat{M}; \mathbb{Z}/n\mathbb{Z}).$$

6.2.2. *Construction of a map $\mu: H_1(\widehat{M}; \mathbb{Z}/n\mathbb{Z}) \rightarrow H_2(\mathcal{J}^g)$.* We prove that ν is an isomorphism by constructing an explicit inverse. Let $k \in \{1, 2, \dots, n-1\}$.

Definition 6.3. Let e be an oriented edge of \mathcal{T} . If f is a face containing e , the path consisting of the two other edges in f is called a *tooth* of e .

Given a tooth T_e of an edge e , let $\mu_k(e)_{T_e} \in C_1^g$ be the element shown in Figure 12.

Lemma 6.4. For any two teeth T_e and T'_e of e , we have

$$(6.13) \quad \mu_k(e)_{T_e} = \mu_k(e)_{T'_e} \in C_1^g(\mathcal{T})/\mathrm{Im}(\beta^*).$$

Proof. Since any two teeth of e are connected through a sequence of flips past a simplex in the link of e , it is enough to prove the result when T_e and T'_e are teeth in a single simplex. Hence, we must prove that a configuration as in Figure 13 represents zero in $C_1^g(\mathcal{T})/\mathrm{Im}(\beta^*)$. This is a consequence of the quad relation. \square

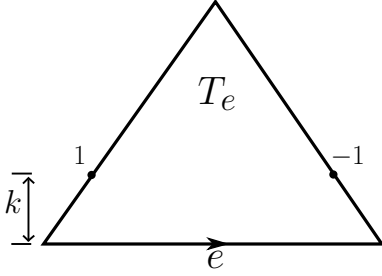

Figure 12. A tooth T_e of e and $\mu_k(e)_{T_e}$.

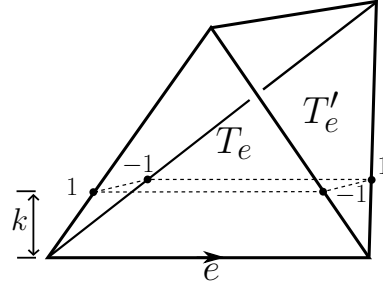

Figure 13. $\mu_k(e)_{T_e} - \mu_k(e)_{T'_e}$ is a quad relation.

It follows that we have a map

$$(6.14) \quad \mu_k: C_1(\widehat{M}) \rightarrow C_1^g(\mathcal{T}), \quad e \mapsto \mu_k(e)_{T_e}.$$

We shall also consider the map $\bar{\mu}_k: C_1(\widehat{M}) \rightarrow C_1^g(\mathcal{T})$ taking an oriented edge e of \mathcal{T} to the integral point on e at distance k from the initial point of e . Note that if f_1 and f_2 are the first and second edge of some tooth of e , $\mu_k(e) = \bar{\mu}_k(f_1) - \bar{\mu}_{n-k}(f_2)$. This is immediate from the definition of μ_k and $\bar{\mu}_k$.

Lemma 6.5. If e_1 and e_2 are two successive oriented edges,

$$(6.15) \quad \mu_k(e_1 + e_2) = \bar{\mu}_k(e_1) - \bar{\mu}_{n-k}(e_2) \in C_1^g(\mathcal{T})/\mathrm{Im}(\beta^*).$$

Proof. We must show that a configuration as in Figure 14 represents 0 in $C_1^g(\mathcal{T})/\mathrm{Im}(\beta^*)$. By flipping the teeth of e_1 and e_2 (which by Lemma 6.4 does not change the element in $C_1^g(\mathcal{T})/\mathrm{Im}(\beta^*)$), we can transform the configuration into a configuration as in Figure 15 where the two teeth meet at a common edge e . This configuration also represents $\mu_k(e)_{T_e} - \mu_k(e)_{T'_e}$ for two teeth T_e and T'_e of e , so is zero by Lemma 6.4. \square

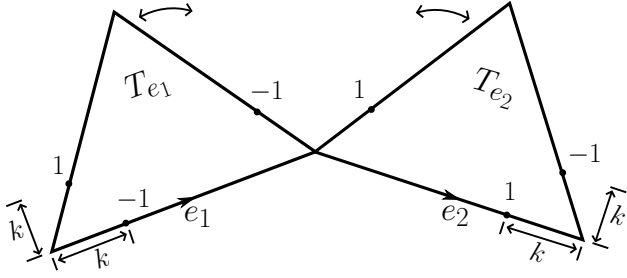

Figure 14. Configuration representing $\mu_k(e_1 + e_2) - \bar{\mu}_k(e_1) + \bar{\mu}_{n-k}(e_2)$.

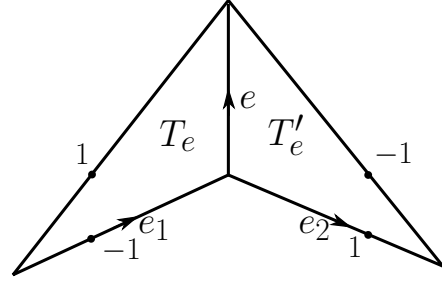

Figure 15. Configuration representing $\mu_k(e)_{T_e} - \mu_k(e)_{T'_e} = 0$.

Corollary 6.6. μ_k induces a map $\mu_k: H_1(\widehat{M}) \rightarrow H_2(\mathcal{J}^g)$.

Proof. The fact that μ_k takes cycles to cycles is immediate from the definition of α^* . Let $e_1 + e_2 + e_3$ be an oriented path representing the boundary of a face in \mathcal{T} . We have

$$(6.16) \quad \mu_k(e_1 + e_2 + e_3) = \mu_k(e_1 + e_2) + \mu_k(e_3) = \bar{\mu}_k(e_1) - \bar{\mu}_{n-k}(e_2) + \mu_k(e_3) = -\mu_k(e_3) + \mu_k(e_3) = 0,$$

where the third equality follows from the fact that $e_1 + e_2$ is a tooth of e_3 . This proves the result. \square

Lemma 6.7. We have $\mu_k = -\mu_{n-k}: H_1(\widehat{M}) \rightarrow H_2(\mathcal{J}^g)$.

Proof. Let $\alpha \in H_1(\widehat{M})$. Since $H_1(\widehat{M})$ is generated by edge cycles, we may assume that α is represented by an edge cycle $e_1 + e_2 + \dots + e_{2l}$, which we may assume to have even length. We thus have (indices modulo $2l$)

$$(6.17) \quad \mu_k(\alpha) = \sum_{i=1}^l (\bar{\mu}_k(e_{2i-1}) - \bar{\mu}_{n-k}(e_{2i})) = \sum_{i=1}^l (-\bar{\mu}_{n-k}(e_{2i}) + \bar{\mu}_k(e_{2i+1})) = -\mu_{n-k}(\alpha),$$

where the second and fourth equality follow from Lemma 6.5 and the third equality follows from shifting indices by 1. \square

Lemma 6.8. For each k , we have $\mu_k = k\mu_1: H_1(\widehat{M}) \rightarrow H_2(\mathcal{J}^g)$.

Proof. Let $\alpha = e_1 + e_2 + \dots + e_{2l}$ as in the proof of Lemma 6.5. We can represent $k\mu_1(e_i) - \mu_k(e_i)$ as in Figure 16. By applying the long hexagon relations ($k-d$ relations at distance d from e_i), the configuration is equivalent to that of Figure 17. Now consider two consecutive edges e_i and e_{i+1} as in Figure 18. By flipping teeth (which doesn't change the homology class), we may transform the configuration into that of Figure 19, and by further flipping, we may assume that the configuration lies in a single simplex. It is now evident, that the points near the common edge e represents a sum of $k-1$ quad relations. Hence, all the points near e vanish. By flipping the teeth back, we end up with a configuration as in Figure 18, but with no points in the middle. Since α is a cycle, it follows that everything sums to zero. \square

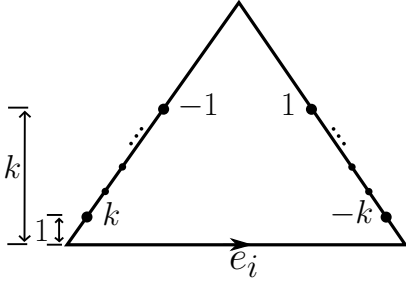
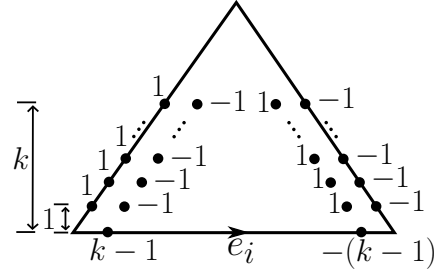
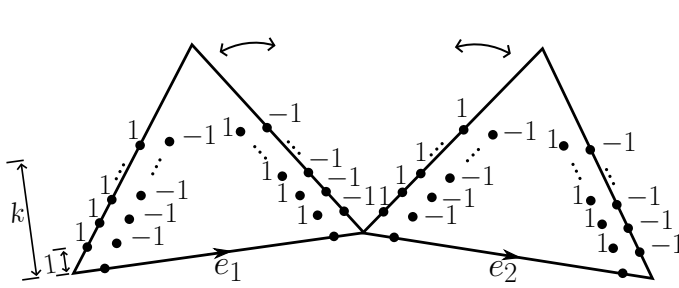
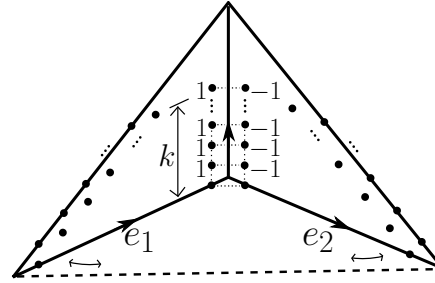
Figure 16. $k\mu_1(e_i) - \mu_k(e_i)$.

Figure 17. $k\mu_1(e_i) - \mu_k(e_i)$ after adding long hexagon relations.

Figure 18. $k\mu_1(e_i) - \mu_k(e_i)$.

Figure 19. $k\mu_1(e_i) - \mu_k(e_i)$ after adding long hexagon relations.

By the above lemmas we have a map

$$(6.18) \quad \mu: H_1(\widehat{M}; \mathbb{Z}/n\mathbb{Z}) \rightarrow H_2(\mathcal{J}^g), \quad e \otimes k \mapsto \mu_k(e).$$

6.2.3. μ is the inverse of ν .

Lemma 6.9. The composition $\nu \circ \mu$ is the identity on $H_1(\widehat{M}; \mathbb{Z}/n\mathbb{Z})$.

Proof. First observe that for each 1-cell e of \mathcal{T} , we have $\nu \circ \bar{\mu}_k(e) = ke$. Consider a representative $\alpha = e_1 + \dots + e_{2l} \in C_1(\widehat{M}; \mathbb{Z})$ of a homology class in $H_1(\widehat{M})$. As in (6.17), we have

$$(6.19) \quad \nu \circ \mu_k(\alpha) = \nu \left(\sum_{i=1}^l (\bar{\mu}_k(e_{2i-1}) - \bar{\mu}_{n-k}(e_{2i})) \right) = \sum_{i=1}^l e_{2i-1} \otimes k - e_{2i} \otimes (n-k) = \alpha \otimes k \in C_1(\widehat{M}; \mathbb{Z}/n\mathbb{Z}) / \{\text{boundaries}\}.$$

This proves the result. \square

We now show that $\mu \circ \nu$ is the identity on $H_2(\mathcal{J}^g)$. The idea is that every homology class in $H_2(\mathcal{J}^g)$ can be represented by edge points. Consider the set

$$(6.20) \quad T = \{(a, b, c, 0) \in \dot{\Delta}_n^3(\mathbb{Z}) \mid a \geq b \geq c \geq 0\}.$$

By Proposition 5.4, we can represent each homology class by an element $\tau + e$, where e consists entirely of edge points, and τ consists of terms (a, b, c, d) with $a \geq b \geq c \geq d \geq 0$ lying in a single simplex. Since an interior point is a sum of two face points minus an edge point, we may assume that $d = 0$, i.e. that all terms of l are in T . Note that by adding and subtracting edge points in T to τ , one may further assume that $\alpha^*(\tau) = 0$. Hence, we shall study elements in $\text{Ker}(\alpha^*)$ of the form

$$(6.21) \quad \tau = \sum_{t \in T} k_t t, \quad k_t \in \mathbb{Z}.$$

We say that a term $t \in T$ is in τ if $k_t \neq 0$. For $j = 1, \dots, n-1$, consider the map

$$(6.22) \quad \pi_j: C_0^g(\mathcal{T}) \rightarrow \mathbb{Z}, \quad x \otimes e_i \mapsto \delta_{ij},$$

where δ_{ij} is the Kronecker δ .

Lemma 6.10. Let $\tau = \sum_{t \in T} k_t t \in \text{Ker}(\alpha^*)$. For any term t in τ , $t_1 < t_0^{\max}$.

Proof. We must show that $u = (t_0^{\max}, t_0^{\max}, n - 2t_0^{\max})$ can't be a term in τ . If $2t_0^{\max} > n$, $u \notin T$, so assume that $2t_0^{\max} \leq n$. Since u is the unique element in T with $t_2 = n - 2t_0^{\max}$, we have $\pi_{n-2t_0^{\max}} \circ \alpha^*(\tau) = k_u$. Since $\alpha^*(\tau) = 0$, it follows that $k_u = 0$. Hence, u is not a term in τ . \square

We can write $\tau = \tau^{\max} + \tau^{\text{rest}}$, where τ^{\max} involves all the terms with $t_0 = t_0^{\max}$, and τ^{rest} involves all the rest.

Lemma 6.11. The maximal part τ^{\max} of τ is a linear combination of terms of the form

$$(6.23) \quad C_{t_1, t'_1} = (t_0^{\max}, t_1, t_2, 0) - (t_0^{\max}, t'_1, t'_2, 0), \quad t_1 > t'_1.$$

Proof. It is enough to prove that $\sum_{t|t_0=t_0^{\max}} k_t = 0$. Since $\alpha^*(\tau) = 0$, this follows from

$$(6.24) \quad 0 = \pi_{t_0^{\max}} \circ \alpha^*(\tau) = \sum_{t|t_0=t_0^{\max}} k_t,$$

where the second equality follows directly from the definition of α^* . \square

Proposition 6.12. The kernel of $\alpha^*: C_1^g(\mathcal{T}) \rightarrow C_0^g(\mathcal{T})$ is generated modulo $\text{Im}(\beta^*)$ by edge points. In other word, each homology class can be represented by edge points.

Proof. Let $x \in H_2(\mathcal{J}^g)$. As explained above, we can represent x by an element $\tau + e$, where e consists entirely of edge points, and $\tau = \sum_{t \in T} k_t t \in \text{Ker}(\alpha^*)$. We wish to show that τ is a linear combination of long hexagon relations. The idea is to add (and subtract) long hexagon relations to τ until we end up with an element τ' with $t_0^{\max}(\tau') > t_0^{\max}$. This process can then be repeated, and since $t_0 < n$ for all $t \in T$, we will eventually end with 0. More precisely, we start by adding (or subtracting the long hexagons) with corners at the two terms involved in C_{t_1, t'_1} from Lemma 6.11. If a long hexagon has a vertex outside of T , this vertex is replaced by the unique vertex in T of the same type. Lemma 6.10 implies that the element τ' thus

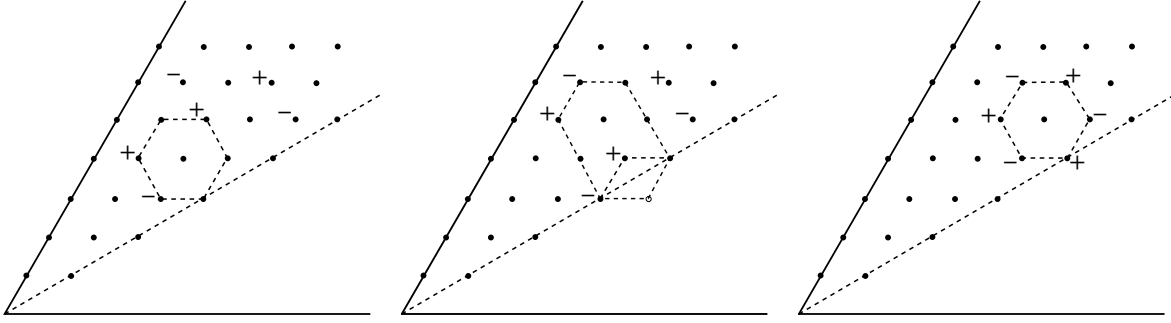

Figure 20. Writing τ as a sum of long hexagon relations.

obtained satisfies $t_0^{\max}(\tau') > t_0^{\max}$. The process is illustrated in Figure 20. Note that at the second step, the required long hexagon has a vertex outside of T . \square

Corollary 6.13. The composition $\mu \circ \nu$ is the identity on $H_2(\mathcal{J}^{\mathfrak{g}})$.

Proof. By Proposition 6.12, one may represent a class in $H_2(\mathcal{J}^{\mathfrak{g}})$ by a linear combination x of edge points. Since $\alpha^*(x) = 0$, x must be a linear combination of elements of the form

$$(6.25) \quad \sigma = \sum_{i=1}^l (\bar{\mu}_k(e_{2i}) - \bar{\mu}_{n-k}(e_{2i-1}))$$

To see this compare with the standard proof that cycles in $C_1(M; \mathbb{Z})$ are generated by edge cycles. We now have

$$(6.26) \quad \mu \circ \nu(\sigma) = \mu((e_1 + \cdots + e_{2l}) \otimes k) = \mu_k(e_1 + \cdots + e_{2l}) = \sigma,$$

where the first equality follows from (6.19), and the third from Lemma 6.5. \square

6.3. Computation of $H_4(\mathcal{J}^{\mathfrak{g}})$ and $H_5(\mathcal{J}^{\mathfrak{g}})$. Since $\mathcal{J}^{\mathfrak{g}}$ is self dual, the universal coefficient theorem implies that

$$(6.27) \quad H_k(\mathcal{J}^{\mathfrak{g}}) = H_{6-k}((\mathcal{J}^{\mathfrak{g}})^*) \cong \mathrm{Hom}(H_{6-k}(\mathcal{J}^{\mathfrak{g}}), \mathbb{Z}) \oplus \mathrm{Ext}(H_{6-k-1}(\mathcal{J}^{\mathfrak{g}}), \mathbb{Z}).$$

It thus follows that $H_5(\mathcal{J}^{\mathfrak{g}}) = 0$ and that $H_4(\mathcal{J}^{\mathfrak{g}}) = \mathbb{Z}/n\mathbb{Z}$.

Remark 6.14. One can show that the sum τ of all integral points of \mathcal{T} generates $H_4(\mathcal{J}^{\mathfrak{g}}) = \mathbb{Z}/n\mathbb{Z}$. If M has a single boundary component, corresponding to the 0-cell x of \mathcal{T} , we have

$$(6.28) \quad n\tau = \alpha\left(\sum_{i=1}^{n-1} ix \otimes e_i\right).$$

We shall not need this, so we leave the proof to the reader.

7. THE MIDDLE HOMOLOGY GROUP

By (6.27), the torsion in $H_3(\mathcal{J}^g)$ equals $\text{Ext}(H_1(\widehat{M}; \mathbb{Z}/n\mathbb{Z})) \cong H^1(\widehat{M}; \mathbb{Z}/n\mathbb{Z})$. We now analyze the free part. Following Neumann [16, Section 4], the idea is to construct maps

$$(7.1) \quad \delta: H_1(\partial M; \mathbb{Z}^{n-1}) \rightarrow H_3(\mathcal{J}^g), \quad \gamma: H_3(\mathcal{J}^g) \rightarrow H_1(\partial M; \mathbb{Z}^{n-1}),$$

which are adjoint with respect to the intersection form w on $H_1(\partial M; \mathbb{Z}^{n-1})$ and the form Ω on $H_3(\mathcal{J}^g)$. When $n = 2$, our δ and γ agree with those of [16].

7.1. Cellular decompositions of the boundary. The ideal triangulation \mathcal{T} of M induces a decomposition of M into truncated simplices such that the cut-off triangles triangulate the boundary of M . We call this decomposition of ∂M the *standard decomposition* and denote it by $\mathcal{T}_{\partial M}^\Delta$. The superscript Δ is to stress that the 2-cells are triangles. We shall also consider another decomposition of ∂M , the *polyhedral decomposition* $\mathcal{T}_{\partial M}^\diamond$, which is obtained from $\mathcal{T}_{\partial M}^\Delta$ by replacing the link of each vertex v of $\mathcal{T}_{\partial M}^\Delta$ with the polygon whose vertices are the midpoints of the edges incident to v . The polyhedral decomposition thus has a vertex for each edge of $\mathcal{T}_{\partial M}^\Delta$, 3 edges for each face of $\mathcal{T}_{\partial M}^\Delta$, and 2 types of faces; a *triangular face* for each face of $\mathcal{T}_{\partial M}^\Delta$, and a *polygonal face* (which may or may not be a triangle) for each vertex of $\mathcal{T}_{\partial M}^\Delta$.

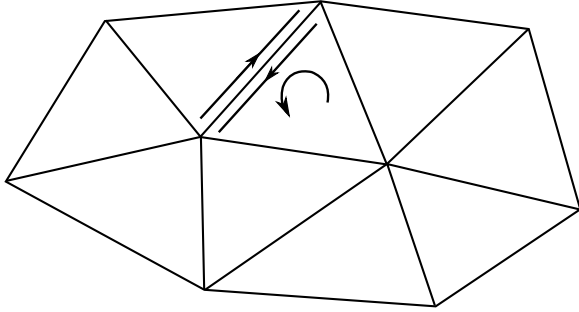

Figure 21. The standard decomposition.

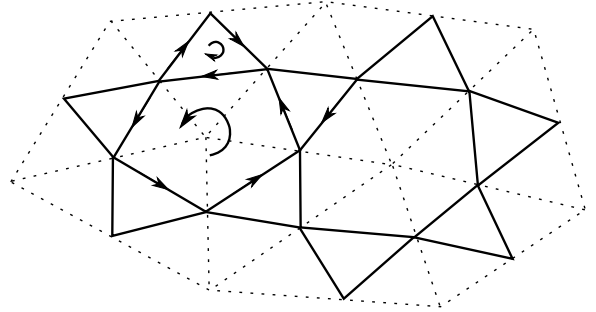

Figure 22. The polyhedral decomposition.

We denote the cellular chain complexes corresponding to the two decompositions by $C_*(\mathcal{T}_{\partial M}^\Delta)$ and $C_*(\mathcal{T}_{\partial M}^\diamond)$, respectively. Hence, we have canonical isomorphisms

$$(7.2) \quad H_*(C_*(\mathcal{T}_{\partial M}^\diamond)) = H_*(C_*(\mathcal{T}_{\partial M}^\Delta)) = H_*(\partial M).$$

7.1.1. Labeling and orientation conventions. We orient ∂M with the counter-clockwise orientation as viewed from an ideal point. The edges of $\mathcal{T}_{\partial M}^\diamond$ each lie in a unique simplex of \mathcal{T} and we orient them in the unique way that agrees with the counter-clockwise orientation for a polygonal face, and the clockwise orientation for a triangular face. The triangular faces of $\mathcal{T}_{\partial M}^\diamond$ are thus oriented opposite to the orientation inherited from ∂M . An edge of $\mathcal{T}_{\partial M}^\Delta$ is only naturally oriented after specifying which simplex it belongs to.

We denote the triangular 2-faces of $\mathcal{T}_{\partial M}^{\hat{\square}}$ and $\mathcal{T}_{\partial M}^{\Delta}$ by τ_{Δ}^i and T_{Δ}^i , respectively, where i is the nearest vertex. The polygonal 2-face of $\mathcal{T}_{\partial M}^{\hat{\square}}$ whose boundary edges are e_{Δ}^{ij} is denoted by $p^{\{i,j\}}$. The (oriented) edge of $\mathcal{T}_{\partial M}^{\hat{\square}}$ near vertex i and perpendicular to edge ij of Δ is denoted by e_{Δ}^{ij} , and the (oriented) edge of $\mathcal{T}_{\partial M}^{\Delta}$ near vertex i and parallel to the edge jk of Δ is denoted by E_{Δ}^{ijk} . The vertex of $\mathcal{T}_{\partial M}^{\hat{\square}}$ near the i th vertex of Δ on the face opposite the j th vertex is denoted by v_{Δ}^{ij} , and the vertex of $\mathcal{T}_{\partial M}^{\Delta}$ near the i th vertex on the edge ij is denoted by V_{Δ}^{ij} . The subscript Δ will occasionally be omitted (e.g. when only one simplex is involved).

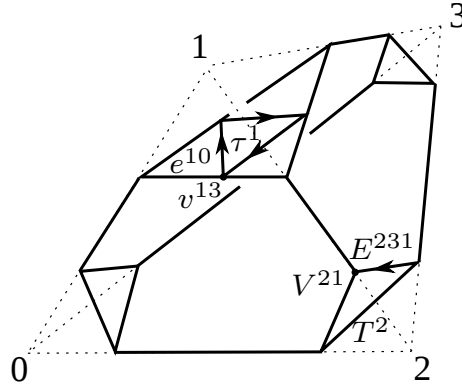

Figure 23. Labeling of vertices, edges and faces of $\mathcal{T}_{\partial M}^{\Delta}$ and $\mathcal{T}_{\partial M}^{\hat{\square}}$.

7.2. The intersection pairing. Consider the pairing

$$(7.3) \quad \iota: C_1(\mathcal{T}_{\partial M}^{\hat{\square}}) \times C_1(\mathcal{T}_{\partial M}^{\Delta}) \rightarrow \mathbb{Z},$$

given by counting intersections with signs (see Figures 24 and 25). We have

$$(7.4) \quad \iota(e_{\Delta}^{ij}, E_{\Delta}^{i'j'k'}) = \begin{cases} 1 & \text{if } i = i', j = k' \\ -1 & \text{if } i = i', j = j' \\ 0 & \text{otherwise.} \end{cases}$$

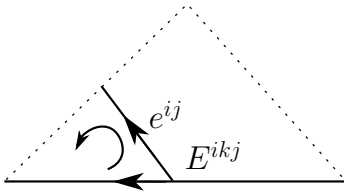

Figure 24. Positive intersection.

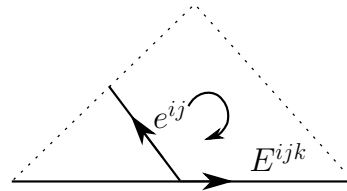

Figure 25. Negative intersection.

Lemma 7.1. The pairing (7.3) induces the intersection pairing on $H_1(\partial M)$.

Proof. Since the pairing counts signed intersection numbers, all we need to prove is that pairing cycles with boundaries gives zero. Consider the maps (star denotes dual)

$$(7.5) \quad \Psi: C_2(\mathcal{T}_{\partial M}^\Delta) \rightarrow C_0(\mathcal{T}^\diamond)^*, \quad \Phi: C_2(\mathcal{T}_{\partial M}^\diamond) \rightarrow C_0(\mathcal{T}_{\partial M}^\diamond)^*,$$

where Ψ takes T^i to $-(v^{ij})^* - (v^{ik})^* - (v^{il})^*$ and Φ takes a triangular face to 0 and a polygonal face to (the dual of) its midpoint. One now easily checks that

$$(7.6) \quad \iota(\partial\tau, E) = \Phi(\tau)(\partial E), \quad \iota(e, \partial T) = \Psi(T)(\partial e)$$

from which the result follows. \square

Consider the chain complexes

$$(7.7) \quad C_*(\mathcal{T}_{\partial M}^\diamond; \mathbb{Z}^{n-1}) = C_*(\mathcal{T}_{\partial M}^\diamond) \otimes \mathbb{Z}^{n-1}, \quad C_*(\mathcal{T}_{\partial M}^\Delta; \mathbb{Z}^{n-1}) = C_*(\mathcal{T}_{\partial M}^\Delta) \otimes \mathbb{Z}^{n-1}.$$

The intersection form induces a non-degenerate pairing

$$(7.8) \quad \omega: C_1(\mathcal{T}_{\partial M}^\diamond; \mathbb{Z}^{n-1}) \times C_1(\mathcal{T}_{\partial M}^\diamond; \mathbb{Z}^{n-1}) \rightarrow \mathbb{Z}, \quad (\alpha \otimes v, \beta \otimes w) \mapsto \iota(\alpha, \beta)\langle v, w \rangle,$$

where $\langle \cdot, \cdot \rangle$ is the standard inner product on \mathbb{Z}^{n-1} . This pairing induces a pairing

$$(7.9) \quad \omega: H_1(\partial M; \mathbb{Z}^{n-1}) \times H_1(\partial M; \mathbb{Z}^{n-1}) \rightarrow \mathbb{Z}.$$

7.3. Definition of δ . Define

$$(7.10) \quad \delta: C_1(\mathcal{T}_{\partial M}^\diamond; \mathbb{Z}^{n-1}) \rightarrow J^\mathfrak{g}(\mathcal{T}), \quad e_\Delta^{ij} \otimes e_r \mapsto \sum_{t_i=r} \sum_{s+e=t} t_j(s, e)_\Delta.$$

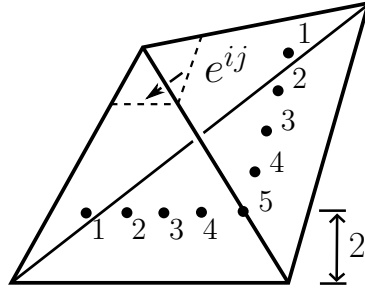

Figure 26. $\delta(e^{ij} \otimes e_2)$ for $n = 7$. Each dot represents an integral point t contributing a term $\sum_{s+e=t}(s, e)$. Interior terms are not shown, c.f. Remark 7.4.

Note that δ preserves rotational symmetry, i.e. it is a map of $\mathbb{Z}[A_4]$ -modules, where A_4 acts trivially on \mathbb{Z}^{n-1} .

Proposition 7.2. The map δ induces a map

$$(7.11) \quad \delta: H_1(\partial M; \mathbb{Z}^{n-1}) \rightarrow H_3(J^\mathfrak{g}).$$

Proof. The result will follow by proving that there is a commutative diagram

$$(7.12) \quad \begin{array}{ccccc} C_2(\mathcal{T}_{\partial M}^{\diamond}; \mathbb{Z}^{n-1}) & \xrightarrow{\partial} & C_1(\mathcal{T}_{\partial M}^{\diamond}; \mathbb{Z}^{n-1}) & \xrightarrow{\partial} & C_0(\mathcal{T}_{\partial M}^{\diamond}; \mathbb{Z}^{n-1}) \\ \downarrow \delta_2 & & \downarrow \delta & & \downarrow \delta_0 \\ C_1^{\mathfrak{g}}(\mathcal{T}) & \xrightarrow{\beta} & J^{\mathfrak{g}}(\mathcal{T}) & \xrightarrow{\beta^*} & C_1^{\mathfrak{g}}(\mathcal{T}). \end{array}$$

Define δ_2 by

$$(7.13) \quad \rho^{\{i,j\}} \otimes e_r \mapsto \sum_{l=1}^m \sum_{t_i=r} t_{jl} t_{\Delta_l}, \quad \tau_{\Delta}^i \otimes e_r \mapsto \sum_{t_i=r} (n-r) t_{\Delta}$$

Commutativity of the lefthand square is obvious for polygonal edges, and for triangular edges it follows from

$$(7.14) \quad \begin{aligned} \delta \circ \partial(\tau_{\Delta}^i \otimes e_r) &= \sum_{j \neq i} \delta(e_{\Delta}^{ij} \otimes e_r) \\ &= \sum_{t_i=r} \sum_{e+s=t} \sum_{j \neq i} t_j(e, s) \\ &= \sum_{t_i=r} \sum_{e+s=t} (n-t_i)(e, s) \\ &= \beta \circ \delta_2(\tau_{\Delta}^i \otimes e_r). \end{aligned}$$

Note that $\beta^* \circ \delta(e^{ij} \otimes e_r) = \sum_{t_i=r} t_j \beta^*(\sum_{s+e} t_j(s, e))$, which is a sum of hexagon relations (interior terms cancel). These involve only points on the faces determined by the start and end point of e , proving the existence of δ_0 . \square

Remark 7.3. Bergeron, Falbel and Guilloux [2] consider a map $H_3(\partial M; \mathbb{Z}^2) \rightarrow H_3(\mathcal{J}^{\mathfrak{g}})$ defined when $n = 3$ using a different, but isomorphic chain complex. One can show that their map equals $\delta \circ (\mathrm{id} \otimes \begin{pmatrix} 1 & 0 \\ 0 & 2 \end{pmatrix})$.

Remark 7.4. In the formula for δ interior points may be ignored. This is because if t is an interior point, then $\sum_{s+e=t} t_j(s, e) = t_j \beta(t)$.

7.4. Definition of γ . The group A_4 acts transitively on the set of pairs of opposite edges of a simplex with stabilizer

$$(7.15) \quad D_4 = \langle \mathrm{id}, (01)(23), (02)(13), (03)(12) \rangle \subset A_4.$$

Hence, there is a one-one correspondence between D_4 -cosets in A_4 and pairs of opposite edges. Explicitly,

$$(7.16) \quad \begin{aligned} \Phi: A_4/D_4 &\mapsto \{ \{\varepsilon_{01}, \varepsilon_{23}\}, \{\varepsilon_{12}, \varepsilon_{03}\}, \{\varepsilon_{02}, \varepsilon_{13}\} \} \\ D_4 &\mapsto \{\varepsilon_{01}, \varepsilon_{23}\}, \quad (012)D_4 \mapsto \{\varepsilon_{12}, \varepsilon_{03}\}, \quad (021)D_4 \mapsto \{\varepsilon_{02}, \varepsilon_{13}\}. \end{aligned}$$

Let \bar{e} denote the opposite edge of e . Consider the map

$$(7.17) \quad \begin{aligned} \gamma: J^{\mathfrak{g}}(\mathcal{T}) &\rightarrow C_1(\mathcal{T}_{\partial M}^{\Delta}; \mathbb{Z}^{n-1}) \\ (s, e) &\mapsto \sum_{\sigma \in \Phi^{-1}(\{e, \bar{e}\})} E^{\sigma(1)\sigma(2)\sigma(3)} \otimes v_{s, \sigma(1)}, \quad v_{s,i} = e_{s_i+1} - e_{s_i} \end{aligned}$$

The map γ is illustrated in Figures 27, 28, and 29. For example, we have

$$(7.18) \quad \gamma(s, \varepsilon_{01}) = \gamma(s, \varepsilon_{23}) = E^{032} \otimes v_{s,0} + E^{123} \otimes v_{s,1} + E^{210} \otimes v_{s,2} + E^{301} \otimes v_{s,3}.$$

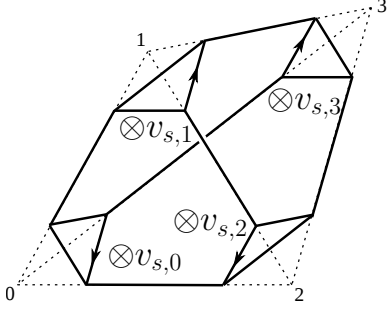

Figure 27. $\gamma(s, \varepsilon_{01})$.

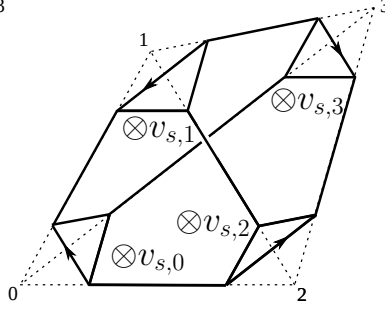

Figure 28. $\gamma(s, \varepsilon_{12})$.

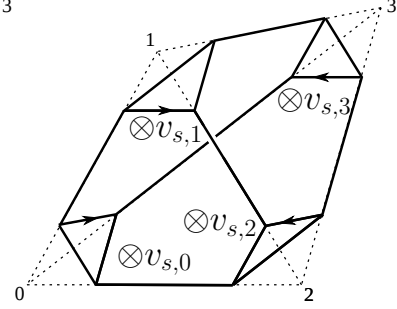

Figure 29. $\gamma(s, \varepsilon_{02})$.

To see that γ is well defined, note that $(s, \varepsilon_{01}) + (s, \varepsilon_{12}) + (s, \varepsilon_{02})$ maps to the boundary of $\sum_{i=0}^3 T^i \otimes v_{s,i}$.

Lemma 7.5. γ takes cycles to cycles and boundaries to boundaries.

Proof. We wish to show that γ fits in a commutative diagram

$$(7.19) \quad \begin{array}{ccccc} C_1^{\mathfrak{g}}(\mathcal{T}) & \xrightarrow{\beta} & J^{\mathfrak{g}}(\mathcal{T}) & \xrightarrow{\beta^*} & C_1^{\mathfrak{g}}(\mathcal{T}) \\ \downarrow \gamma_2 & & \downarrow \gamma & & \downarrow \gamma_0 \\ C_2(\mathcal{T}_{\partial M}^{\Delta}; \mathbb{Z}^{n-1}) & \xrightarrow{\partial} & C_1(\mathcal{T}_{\partial M}^{\Delta}; \mathbb{Z}^{n-1}) & \xrightarrow{\partial} & C_0(\mathcal{T}_{\partial M}^{\Delta}; \mathbb{Z}^{n-1}), \end{array}$$

where γ_2 and γ_0 are defined by

$$(7.20) \quad \gamma_2(p) = \begin{cases} \sum_{(t,\Delta) \in p} \sum_{i|t_i > 0} T_{\Delta}^i \otimes (e_{t_i} - e_{t_{i-1}}) & p = \text{edge point} \\ \sum_{(t,\Delta) \in p} \sum_i T_{\Delta}^i \otimes (e_{t_i} - e_{t_{i-1}}) & p = \text{face point} \\ \sum_{(t,\Delta) \in p} \sum_i T_{\Delta}^i \otimes (e_{t_{i+1}} - e_{t_{i-1}}) & p = \text{interior point} \end{cases}, \quad \gamma_0(p) = - \sum_{i,j} t_j V_{\Delta}^{ij} \otimes e_{t_i}.$$

In the formula for γ_0 , (t, Δ) is any representative of p . Commutativity of the lefthand side is clear from the geometry, and is shown for edge points in Figure 30. To prove commutativity of the righthand side it is by rotational symmetry enough to consider (s, ε_{01}) . We have

$$(7.21) \quad \partial \circ \gamma(s, \varepsilon_{01}) = (V^{02} - V^{03}) \otimes (e_{s_0+1} - e_{s_0}) + (V^{13} - V^{12}) \otimes (e_{s_1+1} - e_{s_1}) + \\ (V^{13} - V^{12}) \otimes (e_{s_2+1} - e_{s_2}) + (V^{31} - V^{30}) \otimes (e_{s_3+1} - e_{s_3}).$$

When expanding $\gamma_0 \circ \beta^*(s, \varepsilon_{01})$, one gets a sum of 12 (possibly vanishing) terms of the form $C_{ij} V^{ij} \otimes w_{ij}$, where $C_{ij} \in \mathbb{Z}$, $w_{ij} \in \mathbb{Z}^{n-1}$, and one must check that the terms agree

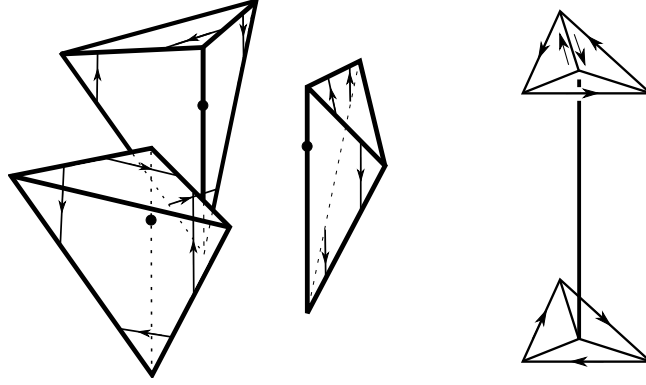

Figure 30. $\beta \circ \gamma(p)$ and $\delta \circ \gamma_2(p)$ for an edge point p .

with (7.21) (for example, we must have $C_{03} = 1$, $w_{03} = e_{s_0+1} - e_{s_0}$). We check this for the terms involving V^{01} and V^{02} , and leave the verification of the other terms to the reader. Since, $\beta^*(s, \varepsilon_{01}) = [s + \varepsilon_{03}] + [s + \varepsilon_{12}] - [s + \varepsilon_{02}] - [s + \varepsilon_{13}]$, the term of $\gamma_0 \circ \beta^*(s, e)$ involving V^{01} equals

$$(7.22) \quad s_1 V^{01} \otimes e_{s_0+1} + (s_1 + 1) V^{01} \otimes e_{s_0} - s_1 V^{01} \otimes e_{s_0+1} - (s_1 + 1) V^{01} \otimes e_{s_0} = 0.$$

Similarly, the term involving V^{02} equals

$$(7.23) \quad -s_2 V^{02} \otimes e_{s_0+1} - (s_2 + 1) V^{02} \otimes e_{s_0} + (s_2 + 1) V^{02} \otimes e_{s_0+1} + s_2 V^{02} \otimes e_{s_0} = V^{02} \otimes (e_{s_0+1} - e_{s_0}).$$

This proves the result. \square

Hence, we have

$$(7.24) \quad \gamma: H_3(J^g) \rightarrow H_1(\partial M; \mathbb{Z}^{n-1}).$$

Proposition 7.6. The maps δ and γ are adjoint, i.e. we have

$$(7.25) \quad \Omega(\delta(e^{ij} \otimes e_r), (s, e)) = \omega(e^{ij} \otimes e_r, \gamma(s, e)).$$

Proof. By rotational symmetry it is enough to prove this for $e = \varepsilon_{01}$. We have

$$(7.26) \quad \Omega(\delta(e^{ij} \otimes e_r), (s, \varepsilon_{01})) = \Omega\left(\sum_{t_i=r} \sum_{s+\varepsilon=t} t_j(s, \varepsilon), (s, \varepsilon_{01})\right).$$

Since $\Omega((s', e'), (s, e)) = 0$ when $s \neq s'$, it follows that

$$(7.27) \quad \Omega(\delta(e^{ij} \otimes e_r), (s, \varepsilon_{01})) = \begin{cases} \Omega\left(\sum_{\varepsilon_i=0} (s_j + \varepsilon_j)(s, \varepsilon), (s, \varepsilon_{01})\right) & s_i = r \\ \Omega\left(\sum_{\varepsilon_i=1} (s_j + \varepsilon_j)(s, \varepsilon), (s, \varepsilon_{01})\right) & s_i = r - 1 \\ 0 & \text{otherwise.} \end{cases}$$

Letting $f(i, j) = \langle \varepsilon_{ij}, \varepsilon_{01} \rangle$, an inspection of Figure 2 shows that

$$(7.28) \quad \Omega(\delta(e^{ij} \otimes e_r), (s, \varepsilon_{01})) = \begin{cases} -f(i, j)(-1)^{r-s_i} & \text{if } s_i = r \text{ or } s_i = r - 1 \\ 0 & \text{otherwise.} \end{cases}$$

The fact that this equals $\omega(e^{ij} \otimes e_r, \gamma(s, \varepsilon_{01}))$ follows from (7.3) using Figures 27, 28 and 29. \square

It will be convenient to rewrite the formula for δ .

Lemma 7.7. We have

$$(7.29) \quad \delta(e^{ij} \otimes e_r) = \sum_{s_i=r-1} (s, \varepsilon_{ij}) - \sum_{s_i=r} (s, \varepsilon_{kl}),$$

where k and l are such that $\{i, j, k, l\} = \{0, 1, 2, 3\}$.

Proof. By rotational symmetry, we may assume that $i = 1$ and $j = 0$. Using the relations $(s, \varepsilon_{01}) + (s, \varepsilon_{12}) + (s, \varepsilon_{02}) = 0$ and $(s, e) + (s, \bar{e}) = 0$, we have

$$(7.30) \quad \begin{aligned} \delta(e^{10} \otimes e_r) &= \sum_{t_1=r} \sum_{s+e=t} t_0(s, e) \\ &= \sum_{s_1=r-1} (s_0 + 1)(s, \varepsilon_{01}) + \sum_{s_1=r} s_0(s, \varepsilon_{23}) + \\ &\quad \sum_{s_1=r-1} s_0(s, \varepsilon_{12}) + \sum_{s_1=r} (s_0 + 1)(s, \varepsilon_{03}) + \\ &\quad \sum_{s_1=r-1} s_0(s, \varepsilon_{13}) + \sum_{s_1=r} (s_0 + 1)(s, \varepsilon_{02}) \\ &= \sum_{s_i=r-1} (s, \varepsilon_{01}) - \sum_{s_i=r} (s, \varepsilon_{23}). \end{aligned}$$

This proves the result. \square

Lemma 7.8. Let $D = \text{diag}(\{n - i\}_{i=1}^{n-1})$ and $A_{\mathfrak{g}}$ denote the Cartan matrix of \mathfrak{g} .

$$(7.31) \quad \gamma \circ \delta(e^{ij} \otimes e_r) = E^{ikl} \otimes \left(\frac{1}{2} D A_{\mathfrak{g}} D e_r\right) + (E^{jlk} + E^{kij} + E^{lji}) \otimes e_{n-r}.$$

where k and l are such that the permutation taking $ijkl$ to 0123 is positive.

Proof. May assume that $i = 1$ and $j = 0$. Then $k = 2$ and $l = 3$. One thus has

$$(7.32) \quad \begin{aligned} \gamma \circ \delta(e^{10} \otimes e_r) &= \sum_{s_1=r-1} \gamma(s, \varepsilon_{01}) - \sum_{s_0=r} \gamma(s, \varepsilon_{23}) \\ &= \sum_{s_1=r-1} E^{123} \otimes (e_r - e_{r-1}) - \sum_{s_1=r} E^{123} \otimes (e_{r+1} - e_r) + \\ &\quad \sum_{s_1=r-1} E^{032} \otimes (e_{s_0+1} - e_{s_0}) - \sum_{s_1=r} E^{032} \otimes (e_{s_0+1} - e_{s_0}) + \\ &\quad \sum_{s_1=r-1} E^{210} \otimes (e_{s_0+1} - e_{s_0}) - \sum_{s_1=r} E^{210} \otimes (e_{s_0+1} - e_{s_0}) + \\ &\quad \sum_{s_1=r-1} E^{301} \otimes (e_{s_0+1} - e_{s_0}) - \sum_{s_1=r} E^{301} \otimes (e_{s_0+1} - e_{s_0}). \end{aligned}$$

The number of subsimplices with $s_1 = c$ equals $\frac{1}{2}(n-c)(n-c-1)$. We thus have

$$(7.33) \quad \sum_{s_1=r-1} (e_r - e_{r-1}) - \sum_{s_1=r} (e_{r+1} - e_r) = \\ -\frac{1}{2}(n-r+1)(n-r)e_{r-1} + (n-r)^2e_r - \frac{1}{2}(n-r)(n-r-1)e_{r+1} = \frac{1}{2}DA_{\mathfrak{g}}De_r.$$

By telescoping, we have (i and j now general, not 1 and 0))

$$(7.34) \quad \sum_{s_1=r-1} E^{ijk} \otimes (e_{s_0+1} - e_{s_0}) - \sum_{s_1=r} E^{ijk} \otimes (e_{s_0+1} - e_{s_0}) = \\ E^{ijk} \otimes \sum_{s_0=0}^{n-1-r} (e_{s_0+1} - e_{s_0}) = E^{ijk} \otimes e_{n-r}.$$

Plugging (7.33) and (7.34) into (7.32) we end up with

$$(7.35) \quad \gamma \circ \delta(e^{10} \otimes e_r) = E^{123} \otimes \frac{1}{2}DA_{\mathfrak{g}}De_r + E^{032} \otimes e_{n-r} + E^{210} \otimes e_{n-r} + E^{301} \otimes e_{n-r},$$

which proves the result. \square

Proposition 7.9. The composition $\gamma \circ \delta: H_1(\partial M; \mathbb{Z}^{n-1}) \rightarrow H_1(\partial M; \mathbb{Z}^{n-1})$ is given by

$$(7.36) \quad \gamma \circ \delta = \mathrm{id} \otimes DA_{\mathfrak{g}}D.$$

Proof. Let $\alpha = \sum a_m e_{\Delta_m}^{i_m j_m}$ be a cycle in $C_1(\mathcal{T}_{\widehat{\partial M}})$. In the proof of [16, Lemma 4.3] (see also Bergeron–Falbel–Guilloux [2, Figures 12,13]), Neumann proves that the “near contribution”

$$(7.37) \quad \sum a_m E^{i_m k_m l_m}$$

is homologous to 2α , whereas the “far contribution”

$$(7.38) \quad \sum a_m (E^{j_m l_m k_m} + E^{k_m i_m j_m} + E^{l_m j_m i_m})$$

is null-homologous. The result now follows from Lemma 7.8. \square

Proposition 7.10. The groups $H_3(\mathcal{J}^{\mathfrak{g}})$ and $H_1(\partial M; \mathbb{Z}^{n-1})$ have equal rank.

Proof. Since all the outer homology groups have rank 0, the rank of $H_3(\mathcal{J})$ is the Euler characteristic $\chi(\mathcal{J})$ of \mathcal{J} . Let v , e , f , and t denote the number of vertices, edges, faces and tetrahedra, respectively, of \mathcal{T} . By a simple counting argument we have

$$(7.39) \quad \mathrm{rank}(C_0^{\mathfrak{g}}(\mathcal{T})) = (n-1)v, \quad \mathrm{rank}(\mathcal{J}^{\mathfrak{g}}(\mathcal{T})) = 2 \binom{n+1}{3}, \\ \mathrm{rank}(C_1^{\mathfrak{g}}(\mathcal{T})) = (n-1)e + \frac{(n-1)(n-2)}{2}f + \frac{(n-1)(n-2)(n-3)}{6}t.$$

Using the fact that $f = 2t$ we obtain

$$(7.40) \quad \chi(\mathcal{J}) = 2 \mathrm{rank}(C_0^{\mathfrak{g}}(\mathcal{T})) - 2 \mathrm{rank}(C_1^{\mathfrak{g}}(\mathcal{T})) + \mathrm{rank}(\mathcal{J}^{\mathfrak{g}}(\mathcal{T})) = \\ 2(n-1)(v - e + t) = 2(n-1)(v - e + f - t) = 2(n-1)\chi(\widehat{M}).$$

The result now follows from the elementary fact (proved by an Euler characteristic count) that $\chi(\widehat{M}) = 1/2 \text{rank}(H_1(\partial M))$. \square

Corollary 7.11. The groups $H_3(\mathcal{J}^{\mathfrak{g}})$ and $H_1(\partial M; \mathbb{Z}^{n-1})$ are isomorphic modulo torsion. \square

7.5. Proof of Theorem 2.8. We now conclude the proof of Theorem 2.8. All that remains are the statements about the free part of $H_3(\mathcal{J}^{\mathfrak{g}})$. We first show that γ and δ admit factorizations

$$(7.41) \quad \begin{aligned} \delta: H_1(\partial M; \mathbb{Z}^{n-1}) &\xrightarrow{\text{id} \otimes D} H_1(\partial M; \mathbb{Z}^{n-1}) \xrightarrow{\delta'} H_3(\mathcal{J}^{\mathfrak{g}}) \\ \gamma: H_3(\mathcal{J}^{\mathfrak{g}}) &\xrightarrow{\gamma'} H_1(\partial M; \mathbb{Z}^{n-1}) \xrightarrow{\text{id} \otimes D} H_1(\partial M; \mathbb{Z}^{n-1}). \end{aligned}$$

The factorization of δ is constructed in the next section (see Proposition 8.5), and the factorization of γ thus follows from Proposition 7.6. By Proposition 7.9, we thus have

$$(7.42) \quad \gamma' \circ \delta' = \text{id} \otimes A.$$

Since $\det(\mathcal{A}_{\mathfrak{g}}) = n$, it follows that γ' maps onto a subgroup of $H_1(\partial M; \mathbb{Z}^{n-1})$ of index h^n . This shows that δ' induces an isomorphism $H_1(\partial M; \mathbb{Z}[1/n]^{n-1}) \rightarrow H_3(\mathcal{J}^{\mathfrak{g}}) \otimes \mathbb{Z}[1/n]$ with inverse γ' . The fact that Ω corresponds to $\omega_{A_{\mathfrak{g}}}$ follows from

$$(7.43) \quad \omega_{A_{\mathfrak{g}}}(\alpha \otimes v, \beta \otimes w) = \omega(\alpha \otimes v, \beta \otimes Aw) = \omega(\alpha \otimes v, \gamma' \circ \delta'(\beta \otimes w)) = \Omega(\delta'(\alpha \otimes v), \delta'(\beta \otimes w)).$$

8. CUSP EQUATIONS AND RANK

We express the cusp equations in terms of yet another decomposition of ∂M . This decomposition was introduced in Garoufalidis–Goerner–Zickert [12], and is the induced decomposition on ∂M induced by the decomposition of M obtained by truncating both vertices and edges. We call it the *doubly truncated decomposition*. As in [12], we label the edges by γ^{ijk} and β^{ijk} . The superscript ijk of an edge indicates the initial vertex (denoted by v^{ijk}) of the edge, i being the nearest vertex of Δ , ij , the nearest edge and ijk the nearest face. As in Section 7.1.1, we label the hexagonal faces by τ^i and the polygonal faces by $p^{\{i,j\}}$.

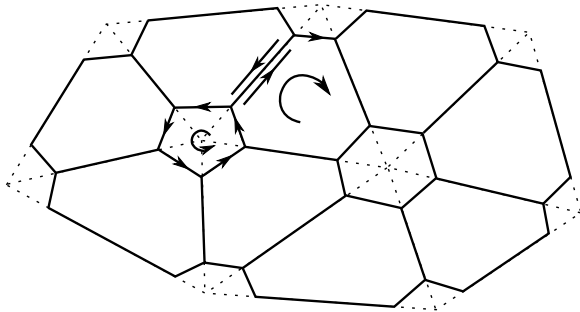

Figure 31. Doubly truncated decomposition of ∂M .

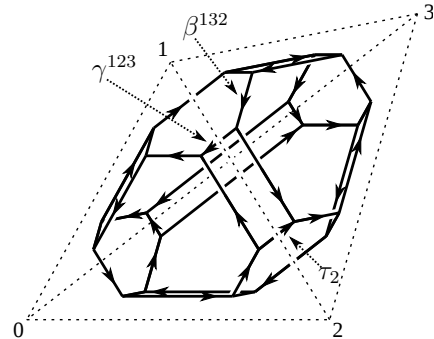

Figure 32. Labeling conventions.

8.1. **Cusp equations.** For a shape assignment z consider the map

$$(8.1) \quad C(z): C_1(\mathcal{T}_{\partial M}^{\square}; \mathbb{Z}^{n-1}) \rightarrow \mathbb{C}^*,$$

$$\gamma^{ijk} \otimes e_r \mapsto (z_{(r-1)v_i + (n-r-1)v_j}^{\varepsilon_{ij}})^{-\varepsilon_{ij}^{ijk}}, \quad \beta^{ijk} \mapsto \prod_{\substack{t \in \text{face}(ijk) \\ t_i=r}} (X_t)^{\varepsilon_{ij}^{ijk}},$$

where ε_{ij}^{ijk} is the sign of the permutation taking $ijkl$ to 0123. It follows from [12, Section 13] that $C(z)$ is a cocycle (it is the ratio of consecutive diagonal entries in the *natural cocycle* [12] associated to z). Hence, $C(z)$ may be regarded as a cohomology class $C(z) \in H^1(\partial M; (\mathbb{C}^*)^{n-1})$. This class vanishes if and only if for each representative $\alpha \in C_1(\mathcal{T}_{\partial M}^{\square})$ of each generator of $H_1(\partial M)$, we have

$$(8.2) \quad C(z)(\alpha \otimes e_r) = 1.$$

This discussion is summarized in the result below.

Theorem 8.1 (Garoufalidis–Goerner–Zickert [12]). *The $\mathrm{PGL}(n, \mathbb{C})$ -representation determined by a shape assignment z is boundary-unipotent if and only if all cusp equations are satisfied. Equivalently, if and only if $C(z)$ is trivial in $H^1(\partial M; (\mathbb{C}^*)^{n-1})$. \square*

The cusp equation (8.2) for $\alpha \otimes e_r$ can be written in the form

$$(8.3) \quad \prod_{s, \Delta} z_{s, \Delta}^{A_{\alpha \otimes e_r, (s, \Delta)}^{\text{cusp}}} \prod_{s, \Delta} (1 - z_{s, \Delta})^{B_{\alpha \otimes e_r, (s, \Delta)}^{\text{cusp}}} = \pm 1.$$

8.2. **Linearizing the cusp equations.** Consider the map

$$(8.4) \quad \delta': C_1(\mathcal{T}_{\partial M}^{\square}; \mathbb{Z}^{n-1}) \rightarrow J^{\mathfrak{g}}(\mathcal{T})$$

$$\gamma^{ijk} \otimes e_r \mapsto -\varepsilon_{ij}^{ijk}(rv_i + (n-r)v_j, \varepsilon_{ij}), \quad \beta^{ijk} \otimes e_r \mapsto \varepsilon_{ij}^{ijk} \sum_{\substack{t \in \text{face}(ijk) \\ t_i=r}} \sum_{(s, e)=t} (s, e)$$

We wish to prove that δ' induces a map in homology.

Lemma 8.2. For each $r = 1, \dots, n-1$, we have

$$(8.5) \quad \sum_{t \in \mathring{\Delta}_n^3(\mathbb{Z}), t_i=r} \beta(t) = - \sum_{t \in \partial \Delta_n^3(\mathbb{Z}), t_i=r} \sum_{s+e=t} (s, e).$$

Proof. Consider a slice of $\Delta_n^3(\mathbb{Z})$ consisting of integral points with $t_i = r$ as shown in Figure 33 for $n-r = 4$. Each dot represents an integral point t and each vertex of each triangle intersecting t represents an edge e of a subsimplex s with $s+e=t$. By (2.3) and (2.4) the sum of the vertices (regarded as pairs (s, e)) of each triangle is zero. Using this it easily follows that the sum of all interior edges equals minus the sum of the boundary edges. Figure 33 shows the proof for $n-r = 4$. \square

Proposition 8.3. The map δ' induces a map on homology.

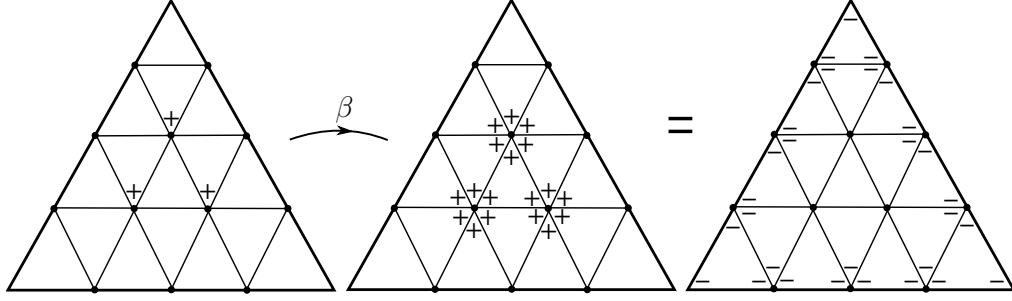

Figure 33. Proof of Lemma 8.2 for $n - r = 4$.

Proof. We wish to extend δ' to a commutative diagram

$$(8.6) \quad \begin{array}{ccccc} C_2(\mathcal{T}_{\partial M}^\circ; \mathbb{Z}^{n-1}) & \xrightarrow{\partial} & C_1(\mathcal{T}_{\partial M}^\circ; \mathbb{Z}^{n-1}) & \xrightarrow{\partial} & C_0(\mathcal{T}_{\partial M}^\circ; \mathbb{Z}^{n-1}) \\ \downarrow \delta'_2 & & \downarrow \delta & & \downarrow \delta'_0 \\ C_1^{\mathfrak{g}}(\mathcal{T}) & \xrightarrow{\beta} & J^{\mathfrak{g}}(\mathcal{T}) & \xrightarrow{\beta^*} & C_1^{\mathfrak{g}}(\mathcal{T}). \end{array}$$

Define

$$(8.7) \quad \begin{aligned} \delta'_2: C_2(\mathcal{T}_{\partial M}^\circ; \mathbb{Z}^{n-1}) &\rightarrow C_1^{\mathfrak{g}}(\mathcal{T}) \\ \tau^i \otimes e_r &\mapsto - \sum_{t \in \Delta_n^3(\mathbb{Z}), t_i=r} t, \quad p^{i_j i} \mapsto \{(rv_i + (n-r)v_j, \Delta_l)\} \end{aligned}$$

and

$$(8.8) \quad \begin{aligned} \delta'_0: C_0(\mathcal{T}_{\partial M}^\circ; \mathbb{Z}^{n-1}) &\rightarrow C_1^{\mathfrak{g}}(\mathcal{T}), \\ v^{ijk} \otimes e_r &\mapsto ((r+1)v_i + (n-r-1)v_j) - (rv_i + (n-r)v_j) \\ &\quad + ((r-1)v_i + v_k + (n-r)v_j) - (rv_i + v_k + (n-r-1)v_j) \end{aligned}$$

The fact that $\beta \circ \delta'_2(p^{i_j i} \otimes e_r) = \delta' \circ \partial(p^{i_j i} \otimes e_r)$ is immediate, and the fact that $\beta \circ \delta'_2(\tau^i \otimes e_r) = \delta' \circ \partial(\tau^i \otimes e_r)$ follows from Lemma 8.2. The terms involved in $\delta'_0 \circ \partial(\beta^{ijk} \otimes e_r)$ are the ones involved in the long hexagon relation shown in Figure 34, and exactly corresponds to $\beta^* \circ \delta'(\beta^{ijk} \otimes e_r)$. Finally, the equality $\beta^* \circ \delta'(\gamma^{ijk} \otimes e_r) = \delta'_0 \circ \partial(\gamma^{ijk} \otimes e_r)$ follows from the fact that the four edge terms of $\delta'_0 \circ \partial(\gamma^{ijk} \otimes e_r)$ cancel out, and the remaining 4 terms are exactly those of $\beta^* \circ \delta'(\gamma^{ijk} \otimes e_r)$. \square

Let z be a shape assignment on \mathcal{T} . Since $z_{s,\Delta}^{1100} z_{s,\Delta}^{0110} z_{s,\Delta}^{1010} = -1$ for each subsimplex s of each simplex Δ of \mathcal{T} , it follows that z defines an element $z \in \text{Hom}(J^{\mathfrak{g}}(\mathcal{T}); \mathbb{C}^*/\{\pm 1\})$, and since the gluing equations are satisfied, we obtain an element $z \in H^3(\mathcal{J}^{\mathfrak{g}}; \mathbb{C}^*/\{\pm 1\})$.

Dual to δ' we have $\delta'^*: H^3(\mathcal{J}^{\mathfrak{g}}; \mathbb{C}^*) \rightarrow H^1(\partial M; (\mathbb{C}^*)^{n-1})$. The following follows immediately from the definitions.

Proposition 8.4. We have $\delta'^*(z) = C(z) \in H^1(\partial M; (\mathbb{C}^*/\{\pm 1\})^{n-1})$. \square

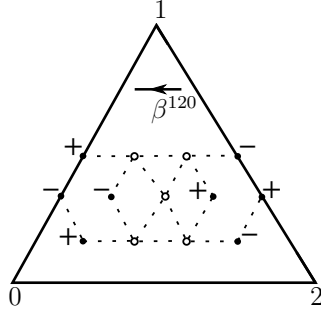

Figure 34. $\delta'_0 \circ \partial(\beta^{120})$.

In particular,

$$(8.9) \quad \delta^{r*}(z) = \prod_{s, \Delta} z_{s, \Delta}^{A_{\alpha, (s, \Delta)}} \prod_{s, \Delta} (1 - z_{s, \Delta})^{B_{\alpha, (s, \Delta)}}.$$

For any abelian group A , we shall use the canonical identifications

$$(8.10) \quad \mathrm{Hom}(H_1(\partial M; \mathbb{Z}^{n-1}), A) \cong (\mathrm{Hom}(H_1(\partial M), A))^{n-1} \cong H^1(\partial M; A^{n-1}).$$

If ϕ is an element of $\mathrm{Hom}(H_1(\partial M; \mathbb{Z}^{n-1}), A)$ or $H^1(\partial M; A^{n-1})$, we let $\phi_r: H_1(\partial M) \rightarrow A$ denote the r th coordinate function.

Proposition 8.5. We have

$$(8.11) \quad \delta = \delta' \circ (\mathrm{id} \otimes D) \in \mathrm{Hom}(H_1(\partial M; \mathbb{Z}^{n-1}), H_3(\mathcal{J}^g)), \quad D = \mathrm{diag}(\{n - i\}_{i=1}^{n-1}).$$

Equivalently, $\delta_r = (n - r)\delta'_r$ for all $r = 1, \dots, n - 1$.

Proof. We prove the second statement. Every class in $H_1(\partial M)$ can be represented by a curve α which is a sequence of left and right turns as shown in Figure 35. We can represent α in $C_1(\mathcal{T}_{\partial M}^{\diamond})$ and $C_1(\mathcal{T}_{\partial M}^{\square})$ as shown in Figure 36. Namely, the representation in $C_1(\mathcal{T}_{\partial M}^{\diamond})$ is the natural one, and the representation in $C_1(\mathcal{T}_{\partial M}^{\square})$ is obtained by replacing a left turn by its corresponding γ edge, and a right turn by a concatenation $\beta\gamma\beta$. The contribution to $\delta'_r(\alpha)$ and $\delta_r(\alpha)$ from a left and right turn are shown schematically in Figures 37 and 38 (the interior points are ignored, c.f. Remark 7.4). Each dot represents an integral point t , contributing the terms $\sum_{s+e=t}(s, e)$. We wish to prove that $\delta_r(\alpha) = (n - r)\delta'_r(\alpha)$, whenever α is a cycle. This can be seen by inspecting Figures 39 and 40; recall that when two faces are paired the terms on each side differ by an element in the image of β . \square

8.3. Proof of Corollaries 2.10 and 2.11. By comparing the generalized gluing equation (3.5) with the definition (4.2) of β we obtain that

$$(8.12) \quad \beta(p) = \sum_{(s, \Delta)} A_{p, (s, \Delta)}(s, \varepsilon_{01}) + \sum_{s, \Delta} B_{p, (s, \Delta)}(s, \varepsilon_{12}).$$

Also, by definition of δ' , we have

$$(8.13) \quad \delta'(p) = \sum_{(s, \Delta)} A_{\alpha \otimes e_r, (s, \Delta)}^{\mathrm{cusp}}(s, \varepsilon_{01}) + \sum_{s, \Delta} B_{\alpha \otimes e_r, (s, \Delta)}^{\mathrm{cusp}}(s, \varepsilon_{12}),$$

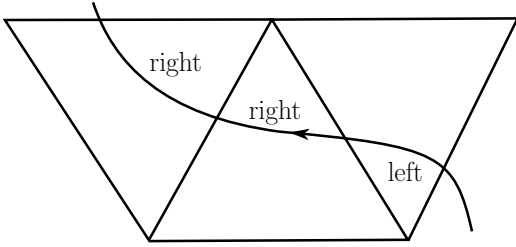

Figure 35. Left and right turns.

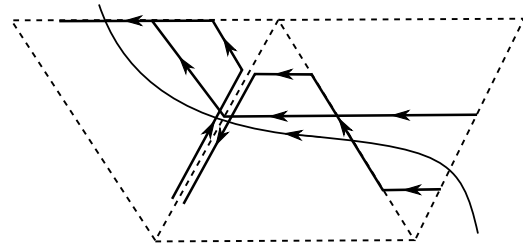

Figure 36. Representing a curve in $C_1(\mathcal{T}_{\partial M}^{\circlearrowleft})$ and $C_1(\mathcal{T}_{\partial M}^{\circlearrowright})$.

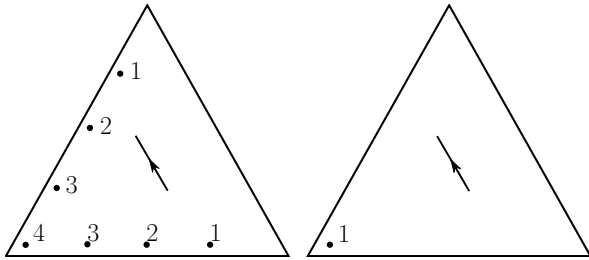

Figure 37. δ and δ' for a left turn.

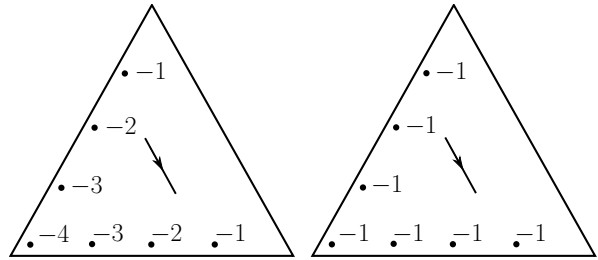

Figure 38. δ and δ' for a right turn.

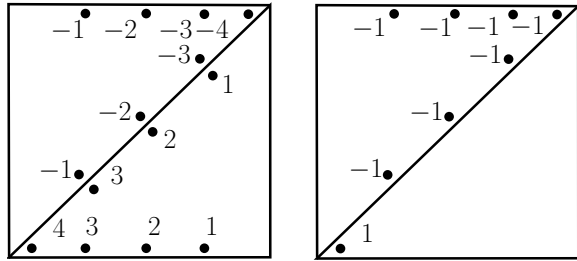

Figure 39. δ and δ' for a left turn followed by a right turn.

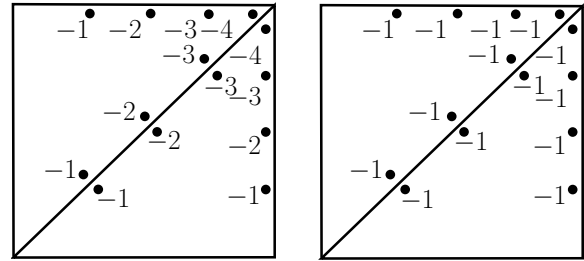

Figure 40. δ and δ' for two right turns.

and is in $\text{Ker}(\beta^*)$. Since $\beta^* \circ \beta = 0$, $\text{Ker}(\beta^*)$ is orthogonal to $\text{Im}(\beta)$ proving the first statement of Corollary 2.10. The second statement follows from (7.43). Finally, Corollary 2.11 follows immediately from the fact that $H_4(\mathcal{J}^g)$ is zero modulo torsion.

Acknowledgment. The authors wish to thank Matthias Goerner and Walter Neumann for useful conversations.

REFERENCES

- [1] Arkady Berenstein, Sergey Fomin, and Andrei Zelevinsky. Cluster algebras. III. Upper bounds and double Bruhat cells. *Duke Math. J.*, 126(1):1–52, 2005.
- [2] Nicolas Bergeron, Elisha Falbel, and Antonin Guilloux. Tetrahedra of flags, volume and homology of $\mathrm{SL}(3)$. *arXiv:1101.2742*. Preprint 2011.
- [3] Francis Bonahon and Helen Wong. The Witten-Reshetikhin-Turaev representation of the Kauffman skein algebra. *arXiv:1309.0921*. Preprint 2013.
- [4] Tudor Dimofte. Quantum Riemann surfaces in Chern-Simons theory. *arXiv:1102.4847*. Preprint 2011.
- [5] Tudor Dimofte, Maxime Gabella, and Alexander B. Goncharov. K-Decompositions and 3d Gauge Theories. *arXiv:1301.0192*. Preprint 2013.
- [6] Tudor Dimofte, Davide Gaiotto, and Sergei Gukov. 3-manifolds and 3d indices. *arXiv:1112.5179*. Preprint 2011.
- [7] Tudor Dimofte, Davide Gaiotto, and Sergei Gukov. Gauge theories labelled by three-manifolds. *arXiv:1108.4389*. Preprint 2011.
- [8] Tudor Dimofte and Stavros Garoufalidis. The quantum content of the gluing equations. *Geom. Topol.*, 17(3):1253–1315, 2013.
- [9] Tudor Dimofte, Sergei Gukov, Jonatan Lenells, and Don Zagier. Exact results for perturbative Chern-Simons theory with complex gauge group. *Commun. Number Theory Phys.*, 3(2):363–443, 2009.
- [10] Vladimir Fock and Alexander Goncharov. Moduli spaces of local systems and higher Teichmüller theory. *Publ. Math. Inst. Hautes Études Sci.*, (103):1–211, 2006.
- [11] Stavros Garoufalidis. The 3D index of an ideal triangulation and angle structures. *arXiv:1208.1663*. Preprint 2012.
- [12] Stavros Garoufalidis, Matthias Goerner, and Christian K. Zickert. Gluing equations for $\mathrm{PGL}(n, \mathbb{C})$ -representations of 3-manifolds. *arXiv:1207.6711*, Preprint 2012.
- [13] Stavros Garoufalidis, Craig D. Hodgson, Hyam Rubinstein, and Henry Segerman. 1-efficient triangulations and the index of a cusped hyperbolic 3-manifold. *arXiv:1303.5278*. Preprint 2013.
- [14] Stavros Garoufalidis, Dylan P. Thurston, and Christian K. Zickert. The complex volume of $\mathrm{SL}(n, \mathbb{C})$ -representations of 3-manifolds. *ArXiv:math.GT/1111.2828*, 2011.
- [15] Bernhard Keller. Cluster algebras and derived categories. In *Derived categories in algebraic geometry*, EMS Ser. Congr. Rep., pages 123–183. Eur. Math. Soc., Zürich, 2012.
- [16] Walter D. Neumann. Combinatorics of triangulations and the Chern-Simons invariant for hyperbolic 3-manifolds. In *Topology '90 (Columbus, OH, 1990)*, volume 1 of *Ohio State Univ. Math. Res. Inst. Publ.*, pages 243–271. de Gruyter, Berlin, 1992.
- [17] Walter D. Neumann and Don Zagier. Volumes of hyperbolic three-manifolds. *Topology*, 24(3):307–332, 1985.
- [18] William P. Thurston. The geometry and topology of three-manifolds. 1980 Princeton lecture notes, available at <http://library.msri.org/books/gt3m/>.

SCHOOL OF MATHEMATICS, GEORGIA INSTITUTE OF TECHNOLOGY, ATLANTA, GA 30332-0160, USA
<http://www.math.gatech.edu/~stavros>
E-mail address: stavros@math.gatech.edu

UNIVERSITY OF MARYLAND, DEPARTMENT OF MATHEMATICS, COLLEGE PARK, MD 20742-4015, USA
<http://www2.math.umd.edu/~zickert>
E-mail address: zickert@umd.edu