

NETWORKING SEIFERT SURGERIES ON KNOTS III

ARNAUD DERUELLE, KATURA MIYAZAKI AND KIMIHIKO MOTEGI

Dedicated to Sadayoshi Kojima on the occasion of his 60th birthday

ABSTRACT. How do Seifert surgeries on hyperbolic knots arise from those on torus knots? We approach this question from a networking viewpoint introduced in [8]. The Seifert Surgery Network is a 1-dimensional complex whose vertices correspond to Seifert surgeries; two vertices are connected by an edge if one Seifert surgery is obtained from the other by a single twist along a trivial knot called a seiferter or along an annulus cobounded by seiferters. Successive twists along a “hyperbolic seiferter” or a “hyperbolic annular pair” produce infinitely many Seifert surgeries on hyperbolic knots. In this paper, we investigate Seifert surgeries on torus knots which have hyperbolic seiferters or hyperbolic annular pairs, and obtain results suggesting that such surgeries are restricted.

1. INTRODUCTION

How do Seifert surgeries on hyperbolic knots arise from those on torus knots? In [8] we formulate this question from a viewpoint of the Seifert Surgery Network. Let us recall some basic notions given in [8] and an example illustrating our idea. A pair (K, m) of a knot K in S^3 and an integer m is a *Seifert surgery* if the result $K(m)$ of m -Dehn surgery on K has a Seifert fibration; we allow the fibration to be degenerate, i.e. it contains an exceptional fiber of index 0 as a degenerate fiber. It is shown in [8, Proposition 2.8] that if $K(m)$ admits a degenerate Seifert fibration, then it is either a lens space or a connected sum of two lens spaces. In the latter case, Greene [14] recently shows that K is a torus knot or a cable of a torus knot.

Definition 1.1 (seiferter). Let (K, m) be a Seifert surgery. A knot c in $S^3 - N(K)$ is called a *seiferter* for (K, m) if c satisfies (1) and (2) below.

- (1) c is a trivial knot in S^3 .
- (2) c becomes a fiber in a Seifert fibration of $K(m)$.

We also consider pairs of seiferters.

Definition 1.2 (annular pair of seiferters). Let c_1, c_2 be seiferters for a Seifert surgery (K, m) . We call $\{c_1, c_2\}$ a *pair of seiferters* if c_1 and c_2 simultaneously become fibers in a Seifert fibration of $K(m)$. A pair of seiferters $\{c_1, c_2\}$ is called a *Hopf pair* if $c_1 \cup c_2$ is a Hopf link in S^3 . A pair of seiferters $\{c_1, c_2\}$ is called an *annular pair of seiferters* (or *annular pair* for short) if c_1 and c_2 cobound an annulus in S^3 .

2010 *Mathematics Subject Classification.* Primary 57M25, 57M50 Secondary 57N10

Key words and phrases. Dehn surgery, hyperbolic knot, Seifert fiber space, seiferter, Seifert Surgery Network, band-sum

For a Seifert surgery (K, m) with a seiferter c , let K_p and m_p be the images of K and m under p -twist along c , respectively. Then, (K_p, m_p) remains a Seifert surgery for any integer p , and (the image of) c is also a seiferter for (K_p, m_p) ([8, Proposition 2.6]). Similarly, if (K, m) has an annular pair $\{c_1, c_2\}$, then under twisting along the annulus cobounded by c_1, c_2 , we obtain a new Seifert surgery for which (the image of) $\{c_1, c_2\}$ remains an annular pair ([8, Proposition 2.33(1)]). We call a twist along an annulus cobounded by $c_1 \cup c_2$ a *twist along an annular pair of seiferters*. We say that a seiferter c (resp. an annular pair $\{c_1, c_2\}$) for a Seifert surgery (K, m) is *hyperbolic* if $S^3 - K \cup c$ (resp. $S^3 - K \cup c_1 \cup c_2$) admits a complete, hyperbolic metric with finite volume.

Remark 1.3. Suppose that a seiferter c for (K, m) bounds a disk in $S^3 - K$. Since no twist along c changes (K, m) , we call c *irrelevant*. We do not regard an irrelevant seiferter as a seiferter. However, for pairs of seiferters $\{c_1, c_2\}$ we allow c_i to be an irrelevant seiferter. Let $\{c_1, c_2\}$ be an annular pair for (K, m) . If either c_1 and c_2 cobound an annulus disjoint from K or there is a 2-sphere in S^3 separating c_i and $c_j \cup K$, then twists along $\{c_1, c_2\}$ do not change (K, m) or have the same effect on K as twists along c_j . We thus call such an annular pair *irrelevant*, and exclude it from annular pairs of seiferters. Note that if $S^3 - K \cup c_1 \cup c_2$ is hyperbolic, then $\{c_1, c_2\}$ is not irrelevant.

Regard each Seifert surgery as a vertex, and connect two vertices by an edge if one is obtained from the other by a single twist along a seiferter or an annular pair of seiferters. We then obtain a 1-dimensional complex, called the *Seifert Surgery Network*.

Let us take a look at seiferters for Seifert surgeries on torus knots $T_{p,q}$. Throughout this paper we assume, without loss of generality, that $|p| > q \geq 1$, and denote a trivial knot $T_{p,1}$ by O .

Example 1.4 (the subcomplex \mathcal{T}). Since the exterior of a torus knot $T_{p,q}$ is a Seifert fiber space, $(T_{p,q}, m)$ is a Seifert surgery for any integer m . Let s_p, s_q be exceptional fibers in the Seifert fibration of the exterior of $T_{p,q}$ with indices $|p|, q$, respectively, and c_μ a meridian of $T_{p,q}$; see Figure 1.1. Then s_p and s_q remain exceptional fibers in $T_{p,q}(m)$. Note that c_μ is isotopic in $T_{p,q}(m)$ to the core of the filled solid torus, which is a fiber of index $|pq - m|$ and in particular a degenerate fiber in $T_{p,q}(pq)$. Hence, the trivial knots s_p, s_q, c_μ are seiferters for $(T_{p,q}, m)$ for any integer m , and called *basic seiferters* for $(T_{p,q}, m)$. We denote by \mathcal{T} the subcomplex such that its vertices are Seifert surgeries on torus knots and its edges correspond to basic seiferters.

The following example motivates us to consider the Seifert Surgery Network.

- Example 1.5.**
- (1) The meridian c_μ for $T_{-3,2}$ is a seiferter for all $(T_{-3,2}, m)$ ($m \in \mathbb{Z}$). Twisting along c_μ yields the horizontal line in Figure 1.2, which consists of all the integral Seifert surgeries on $T_{-3,2}$.
 - (2) The trivial knot $c \subset S^3 - T_{-3,2}$ in Figure 1.2 is a seiferter for the Seifert surgery $(T_{-3,2}, -2)$ (Section 2, Figure 2.2). A (-2) -twist of $T_{-3,2}$ along c yields the figure-eight knot. Since the linking number between c and $T_{-3,2}$ is zero, the surgery slope -2 does not change under the twisting. Thus we obtain the right vertical line in Figure 1.2.
 - (3) The trivial knot $c' \subset S^3 - T_{-3,2}$ in Figure 1.2 is a seiferter for $(T_{-3,2}, -7)$ ([8, Example 2.21(2)]). A 1-twist of $T_{-3,2}$ along c' yields the $(-2, 3, 7)$

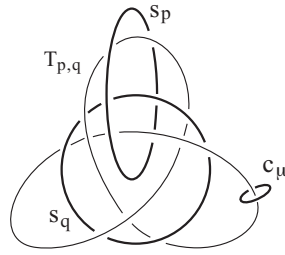

FIGURE 1.1. Basic Seiferters

pretzel knot $P(-2, 3, 7)$ ([9]). Since the linking number between c' and $T_{-3,2}$ is 5, the surgery slope changes from -7 to $-7 + 5^2 = 18$. We thus obtain the lens surgery $(P(-2, 3, 7), 18)$ first found by Fintushel and Stern [12]. This gives the left vertical line in Figure 1.2.

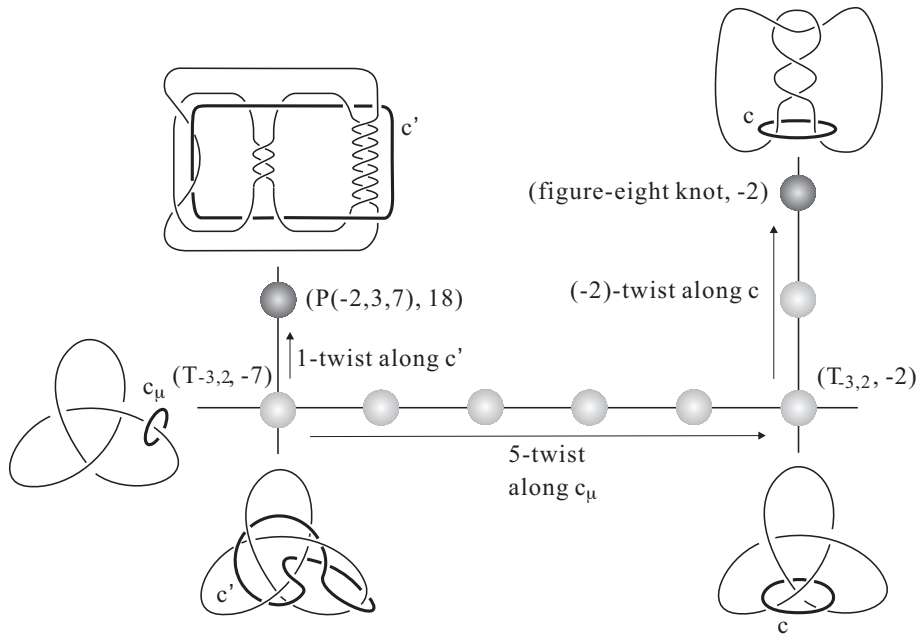

FIGURE 1.2. Seifert Surgery Network

A path from (K, m) to $(K', m') \in \mathcal{T}$ in the network shows that the Seifert surgery (K, m) is obtained from the m' -surgery on the torus knot K' by a sequence of twists along seiferters or annular pairs. For example, vertical paths in Figure 1.2 from (figure-eight knot, -2) and $(P(-2, 3, 7), 18)$ to vertices in \mathcal{T} explain how these surgeries arise from surgeries on a trefoil knot. In [7, 8, 6], we find paths from various known Seifert surgeries to vertices in \mathcal{T} ; the list includes Seifert surgeries on graph knots, Berge's lens surgeries [3], and Seifert surgeries constructed by using Montesinos trick [10, 11].

In the present paper, we explore Seifert surgeries on torus knots which have edges going out of \mathcal{T} , and try to classify such surgeries. We focus on Seifert surgeries on torus knots which have hyperbolic seiferters or hyperbolic annular pairs. By Thurston's hyperbolic Dehn surgery theorem [28, 29, 2, 25, 4], if $(T_{p,q}, m)$ has a hyperbolic seiferters (resp. a hyperbolic annular pair), then all but finitely many vertices of the 1-complex generated by successive twists along the seiferters (resp. the annular pair) are Seifert surgeries on hyperbolic knots. Hence, we call $(T_{p,q}, m)$ with a hyperbolic seiferters or a hyperbolic annular pair a *spreader*. Previously known examples of spreaders [7, 8, 6, 9] have specific patterns and lead us to the following conjecture.

Conjecture 1.6. If $(T_{p,q}, m)$ is a spreader, then $q = 1, 2$, or $m = pq, pq \pm 1$.

In Section 2, we review the definition of m -moves introduced in [8], which are in fact Kirby calculus handle-slides over m -framed knots. A trivial knot obtained from a seiferters for (K, m) by a sequence of m -moves is also a seiferters for (K, m) if K is nontrivial. In Sections 3 and 4, we exploit m -moves to find seiferters for $(T_{p,q}, m)$ where $q = 1, 2$. Theorems 3.1 and 4.1 imply the following.

Theorem 1.7. *For each integer m , $(T_{p,1}, m) = (O, m)$ and $(T_{p,2}, m)$ are spreaders. In particular, (O, m) has infinitely many hyperbolic annular pairs as well as infinitely many hyperbolic seiferters.*

Regarding seiferters for $(T_{p,q}, m)$ where $q \geq 3$, we consider two cases according as $T_{p,q}(m)$ has a unique Seifert fibration up to isotopy or not: the case when $|m - pq| \geq 2$ and the case when $m = pq, pq \pm 1$. In the latter case, we prove the theorem below, which follows from Propositions 5.1, 5.4 and 5.5.

Theorem 1.8. *Each of $(T_{p,q}, pq)$ ($q \geq 2, (p, q) \neq (\pm 3, 2)$) and $(T_{2n \pm 1, n}, n(2n \pm 1) - 1)$ ($n \geq 2$) has a hyperbolic seiferters which cannot be obtained from basic seiferters or a regular fiber of the exterior of the torus knot by any sequence of m -moves.*

Conjecture 1.6 above implies that if $q \geq 3$ and $m \neq pq, pq \pm 1$, $(T_{p,q}, m)$ has no hyperbolic seiferters. Theorem 1.9 below shows the difficulty of obtaining such a hyperbolic seiferters.

Theorem 1.9. *Suppose that $q \geq 3$ and $m \neq pq, pq \pm 1$ (i.e. $T_{p,q}(m)$ is not a connected sum of lens spaces, a lens space, or a prism manifold). Then every seiferters for $(T_{p,q}, m)$ is obtained from a basic seiferters or a regular fiber of $S^3 - N(T_{p,q})$ by a sequence of m -moves (Proposition 2.2). However, to obtain a hyperbolic seiferters for $(T_{p,q}, m)$ in such a manner we need to apply m -moves at least twice (Corollary 6.8(2)).*

We close the introduction with the following question.

Question 1.10. Does every lens surgery $(T_{p,q}, pq \pm 1)$ have a hyperbolic seiferters?

Acknowledgments. We would like to thank Mario Eudave-Muñoz, Cameron Gordon, John Luecke, Daniel Matignon, José María Montesinos, Kunio Murasugi, Kouki Taniyama, Masakazu Teragaito, and Akira Yasuhara for useful discussions and encouragements. We would also like to thank the referee for careful reading and useful comments.

The third author has been partially supported by JSPS Grants-in-Aid for Scientific Research (C) (No.17540097 and No.21540098), The Ministry of Education,

Culture, Sports, Science and Technology, Japan and Joint Research Grant of Institute of Natural Sciences at Nihon University for 2012.

2. SEIFERTERS FOR TORUS KNOTS AND SEIFERT FIBRATIONS OF TORUS KNOT SPACES

Definition 2.1 (*m*-move). Let K be a knot in S^3 , and c a knot in $S^3 - N(K)$. Take a simple closed curve α_m on $\partial N(K)$ representing a slope m . Let b be a band in $S^3 - \text{int}N(K)$ connecting α_m and c , and let $b \cap \alpha_m = \tau_{\alpha_m}$, $b \cap c = \tau_c$. We set $\tau'_{\alpha_m} = \alpha_m - \text{int}\tau_{\alpha_m}$ and $\tau'_c = c - \text{int}\tau_c$. Then the band connected sum $c \natural_b \alpha_m = \tau'_c \cup (\partial b - \text{int}(\tau_c \cup \tau_{\alpha_m})) \cup \tau'_{\alpha_m}$ is a knot in $S^3 - \text{int}N(K)$. Pushing $c \natural_b \alpha_m$ away from $\partial N(K)$, we obtain a knot c' in $S^3 - N(K)$; see Figure 2.1. We say that c' is obtained from c by an *m*-move using the band b .

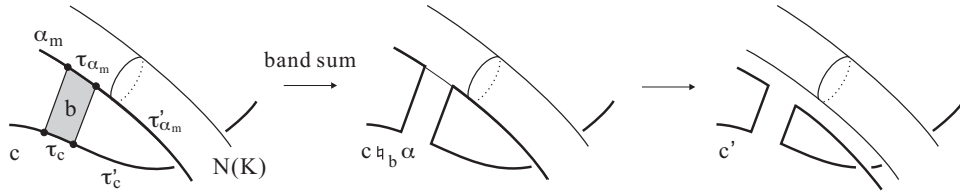

FIGURE 2.1. *m*-move

Let K be a knot in S^3 , and c_1, c_2 knots in $S^3 - N(K)$. Assume that c_2 is obtained from c_1 after a finite sequence of *m*-moves and isotopies in $S^3 - \text{int}N(K)$. We then say that c_2 is *m*-equivalent to c_1 . Note that c_2 is isotopic to c_1 in the surgered manifold $K(m)$ ([8, Proposition 2.19(1)]). Hence, if (K, m) is a Seifert surgery, c_1 is a seiferter for (K, m) , and c_2 is a trivial knot, then c_2 is a possibly irrelevant seiferter for (K, m) . Proposition 2.19(3) in [8] shows that c_2 is not irrelevant if K is a nontrivial knot. Figure 2.2 illustrates how an *m*-move works, where $K = T_{-3,2}$, $m = -2$, $c_1 = s_{-3}$. It follows that c_2 is a seiferter for $(T_{-3,2}, -2)$. See Section 3 for *m*-moves of annular pairs of seiferters.

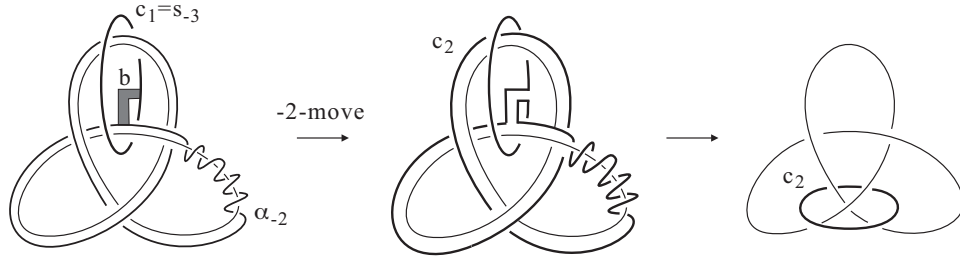

FIGURE 2.2. *m*-move; $m = -2$, and c_2 is a seiferter for $(T_{-2,3}, -2)$.

Most seiferters for $(T_{p,q}, m)$ are *m*-equivalent to basic seiferters or regular fibers of Seifert fibrations of $S^3 - \text{int}N(T_{p,q})$. Precise statements are as follows.

Proposition 2.2. Let $T_{p,q}$ be a nontrivial torus knot, and c a seiferter for $(T_{p,q}, m)$, where $m \neq pq$.

- (1) Suppose that c is an exceptional fiber in some Seifert fibration of $T_{p,q}(m)$. If $T_{p,q}(m)$ is a lens space, we assume that the base surface is S^2 . Then c is m -equivalent to a basic seiferter s_p , s_q or c_μ .
- (2) Suppose that c is a regular fiber in some Seifert fibration of $T_{p,q}(m)$. If $T_{p,q}(m)$ is neither a lens space nor a prism manifold, then c is m -equivalent to a regular fiber in $S^3 - N(T_{p,q})$.

Proof of Proposition 2.2. We denote by \mathcal{F} a Seifert fibration on $T_{p,q}(m)$ in which c is an exceptional fiber or a regular fiber.

Case 1. $T_{p,q}(m)$ is not a lens space.

By [8, Proposition 2.8], if $T_{p,q}(m)$ admits a degenerate Seifert fibration, then it is either a lens space or a connected sum of two lens spaces. It follows that \mathcal{F} is a non-degenerate Seifert fibration. Let \mathcal{F}_0 be a natural extension of the Seifert fibration of $S^3 - \text{int}N(T_{p,q})$ over $T_{p,q}(m)$. The base space of \mathcal{F}_0 is the 2-sphere, and its exceptional fibers are s_p, s_q , and a core of the filled solid torus, whose indices are $|p|, q$, and $|pq - m|$, respectively. We note that c_μ is isotopic in $T_{p,q}(m)$ to the third exceptional fiber of \mathcal{F}_0 . Let t be a regular fiber of $\mathcal{F}_0|(S^3 - N(T_{p,q}))$.

Subcase 1. $T_{p,q}(m)$ is not a prism manifold.

It then follows from [20, Corollary 3.12] that two Seifert fibrations \mathcal{F} and \mathcal{F}_0 are isotopic. Hence, if c is an exceptional fiber in $T_{p,q}(m)$, then c is isotopic to one of s_p, s_q and c_μ in $T_{p,q}(m)$, and thus m -equivalent to a basic seiferter s_p, s_q or c_μ . Similarly, if c is a regular fiber in $T_{p,q}(m)$, then c is isotopic to t in $T_{p,q}(m)$ and thus m -equivalent to the regular fiber t ([8, Proposition 2.19(1)]).

Subcase 2. $T_{p,q}(m)$ is a prism manifold and c is an exceptional fiber.

A Seifert fibration of a prism manifold is either over S^2 with three exceptional fibers of indices $2, 2, x$ or over $\mathbb{R}P^2$ with at most one exceptional fiber ([19, VI.16(b)]). Hence, \mathcal{F}_0 is a Seifert fibration over the base orbifold $S^2(2, 2, x)$ for some odd integer $x(\geq 3)$. Now let us show that $T_{p,q}(m)$ has a Seifert fibration over S^2 with c an exceptional fiber even if the base space of \mathcal{F} is not S^2 . Assume that \mathcal{F} is a Seifert fibration over $\mathbb{R}P^2$; then $\mathcal{F}|(T_{p,q}(m) - \text{int}N(c))$ is a Seifert fibration over the Möbius band with no exceptional fiber. Hence $T_{p,q}(m) - \text{int}N(c)$ admits a Seifert fibration over the disk with two exceptional fibers of indices $2, 2$. Extending this fibration over $T_{p,q}(m)$, we obtain a Seifert fibration over S^2 with c an exceptional fiber, as claimed. For simplicity, denote the new Seifert fibration by the same symbol \mathcal{F} . Then, \mathcal{F} is a Seifert fibration over the base orbifold $S^2(2, 2, x')$ for some odd integer $x'(\geq 3)$. Since a regular fiber of \mathcal{F} (resp. \mathcal{F}_0) generates the center of $\pi_1(T_{p,q}(m))$, the quotient of $\pi_1(T_{p,q}(m))$ by its center is the dihedral group of order $2x'$ (resp. $2x$). It follows that $x = x'$.

Claim 2.3. *There exists an orientation preserving homeomorphism f of $T_{p,q}(m)$ which carries fibers of \mathcal{F} to fibers of \mathcal{F}_0 .*

Proof of Claim 2.3. We denote the normalized Seifert invariant of \mathcal{F} by $(b, \frac{1}{2}, \frac{1}{2}, \frac{y}{x})$ ($b \in \mathbb{Z}$, $0 < y < x$), and that of \mathcal{F}_0 by $(b', \frac{1}{2}, \frac{1}{2}, \frac{y'}{x})$ ($b' \in \mathbb{Z}$, $0 < y' < x$). Note that the order of $H_1(T_{p,q}(m))$ is given by $4|(b+1)x + y| = 4|(b'+1)x + y'|$. Hence we have $b = b'$, $y = y'$ or $b + b' = -3$, $x = y + y'$. In the former case, we have an orientation preserving homeomorphism of $T_{p,q}(m)$ which carries fibers of \mathcal{F} to those of \mathcal{F}_0 as desired; see [24], [22], and [15]. We show that the latter does not occur. If we have the latter case, then $(b', \frac{1}{2}, \frac{1}{2}, \frac{y'}{x}) = (-b - 3, \frac{1}{2}, \frac{1}{2}, \frac{x-y}{x})$. On the other hand, $-T_{p,q}(m)$ ($T_{p,q}(m)$ with orientation reversed) has a Seifert invariant

$(-b, -\frac{1}{2}, -\frac{1}{2}, -\frac{y}{x})$, which is normalized to $(-b - 3, \frac{1}{2}, \frac{1}{2}, \frac{x-y}{x})$. Thus we have an orientation preserving homeomorphism from $-T_{p,q}(m)$ to $T_{p,q}(m)$ ([24], [22], and [15]), i.e. $T_{p,q}(m)$ admits an orientation reversing homeomorphism. This contradicts the fact that a prism manifold has no orientation reversing homeomorphism ([1], [22, 8.4], [26]). \square (Claim 2.3)

Then, [20, Lemma 3.5] implies that f is isotopic to a homeomorphism preserving \mathcal{F} . This implies that \mathcal{F}_0 is isotopic to \mathcal{F} . Hence just as in Subcase 1, the exceptional fiber c is m -equivalent to one of s_p, s_q and c_μ .

Case 2. $T_{p,q}(m)$ is a lens space, and c is an exceptional fiber.

Then $T_{p,q}(m)$ has a natural Seifert fibration over S^2 in which s_p and s_q are exceptional fibers of indices $|p|, q$. Note also that s_p and s_q give a genus one Heegaard splitting $T_{p,q}(m) = V \cup W$ of the lens space $T_{p,q}(m)$; s_p and s_q are cores of the solid tori V and W . We recall that the base space of the Seifert fibration \mathcal{F} is S^2 from the assumption of Proposition 2.2(1). Then, \mathcal{F} also gives a genus one Heegaard splitting $T_{p,q}(m) = V' \cup W'$ such that the exceptional fiber c in \mathcal{F} is a core of V' . Since a genus one Heegaard splitting is unique up to isotopy by [5, 17], c is isotopic to s_p or s_q in $T_{p,q}(m)$. Proposition 2.19(1) in [8] thus shows that c is m -equivalent to a basic seiferter s_p or s_q as desired. \square (Proposition 2.2)

Remark 2.4. Assumptions in Proposition 2.2 are necessary.

- (1) As we will see in Proposition 5.1, each $(T_{p,q}, pq)$ where $(p, q) \neq (\pm 3, 2)$ has a seiferter which is not pq -equivalent to any basic seiferter nor a regular fiber of $S^3 - N(T_{p,q})$.
- (2) If $T_{p,q}(m)$ is a prism manifold (i.e. $q = 2$ and $m = 2p \pm 2$), then there exists a seiferter c for $(T_{p,q}, m)$ which is a regular fiber in a Seifert fibration over the projective plane ([8, Corollary 3.15(6)]). Then c is not m -equivalent to a regular fiber of $S^3 - N(T_{p,q})$.
- (3) Propositions 5.4 and 5.5 show that for some lens surgeries $(T_{p,q}, m)$ ($m = pq \pm 1$), there exist seiferters which are not m -equivalent to any basic seiferters nor regular fibers of $S^3 - N(T_{p,q})$.

3. ANNULAR PAIRS OF SEIFERTERS FOR (O, m)

Let $\{c_1, c_2\}$ be an annular pair of seiferters. When we mention the linking number $\text{lk}(c_1, c_2)$, c_1 and c_2 are oriented so as to be homologous in an annulus cobounded by c_1, c_2 . If $c_1 \cup c_2$ is not a Hopf link, then this convention determines the linking number without specifying the annulus. A Hopf link cobounds two non-isotopic annuli according as $\text{lk}(c_1, c_2) = 1$ or -1 . For details see Lemma 2.30 and Remark 2.31 in [8].

In [8] an annular pair $\{c_1, c_2\}$ is defined to be an ordered pair of c_1 and c_2 to specify the direction of twist along the annulus cobounded by $c_1 \cup c_2$. However, since we do not perform annulus twists in this paper, annular pairs are presented as unordered pairs.

Let K be a knot in S^3 , and $c_1 \cup c_2$ a link in $S^3 - N(K)$. Let c'_1 be a knot obtained from c_1 by an m -move using a band disjoint from c_2 and connects c_1 and a simple closed curve on $\partial N(K)$ with slope m . We then say that $c'_1 \cup c_2$ is obtained from $c_1 \cup c_2$ by an m -move. The link $c'_1 \cup c_2$ is isotopic to $c_1 \cup c_2$ in the surgered manifold $K(m)$ as ordered links ([8, Lemma 2.25(1)]). If $\{c_1, c_2\}$ is a pair of seiferters for a

Seifert surgery (K, m) and c'_1 is trivial in S^3 , then $\{c'_1, c_2\}$ is also a pair of seiferters for (K, m) ([8, Lemma 2.25(2)]). The theorem below complements Theorem 6.21 in [8].

Theorem 3.1. (1) *For each integer m , there are infinitely many hyperbolic Hopf pairs of seiferters for (O, m) .*
 (2) *For any integers $m \neq 0$ and $p \geq 2$ except $(m, p) = (\pm 1, 2)$, there is a hyperbolic annular pair of seiferters $\{c_1, c_2\}$ for (O, m) with $\text{lk}(c_1, c_2) = p$.*

Proof of Theorem 3.1. (1) Assertion (1) follows from Lemma 3.2 below.

(2) Assume that $m \neq 0$, $p \geq 2$, and $(m, p) = (\pm 1, 2)$. Then, if $m \neq 1$, $\{c, c_{p+1, m}\}$ in Proposition 3.10 with q replaced by $p + 1$ is a hyperbolic annular pair for (O, m) with $\text{lk}(c, c_{p+1, m}) = p$, as desired in assertion (2). If $m \neq -1$, $\{c, c'_{p-1, m}\}$ in Proposition 3.13 has the desired property. \square (Theorem 3.1)

Lemma 3.2. *Let $O \cup c \cup c_p$ be the link in Figure 3.1, where p is an odd integer with $|p| \geq 3$. Then, $\{c, c_p\}$ is a hyperbolic Hopf pair of seiferters for (O, m) if $p \neq 2m \pm 1$. For each m , $\{c, c_p\}$ ($p \geq m, p \neq 2m \pm 1$) are mutually distinct, hyperbolic Hopf pairs.*

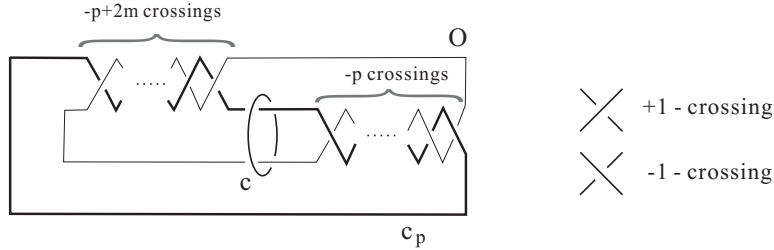

FIGURE 3.1.

Proof of Lemma 3.2. Consider the link consisting of a torus knot $T_{p,2}$ ($|p| \geq 3$) and its basic seiferters s_2, s_p . Regard s_2 as the trivial knot O , and set $c = s_p$. See the first figure of Figure 3.2. There is a Seifert fibration of $S^3 - \text{int}N(O)$ in which $T_{p,2}$ is a regular fiber and c is the exceptional fiber of index $|p|$. Let c_p be the trivial knot obtained from $T_{p,2}$ in $S^3 - N(O)$ by the m -move in Figure 3.2. Since $c \cup T_{p,2}$ is isotopic in $O(m)$ to $c \cup c_p$, $c \cup c_p$ is also the union of fibers in a Seifert fibration of $O(m)$. It follows that $\{c, c_p\}$ in the second figure of Figure 3.2 is a pair of seiferters for (O, m) . After isotopy, the link $O \cup c \cup c_p$ in the last figure of Figure 3.2 is the same link as $O \cup c \cup c_p$ in Figure 3.1. Hence, $\{c, c_p\}$ in Figure 3.1 is a Hopf pair of seiferters for (O, m) .

Suppose $p \neq 2m \pm 1$. Let us show that $\{c, c_p\}$ is a hyperbolic Hopf pair, i.e. $O \cup c \cup c_p$ is a hyperbolic link. Assume for a contradiction that $X = S^3 - \text{int}N(O \cup c \cup c_p)$ is Seifert fibered. Then, the exterior of $O \cup c \cup c_p$, which is obtained from X by Dehn filling along $\partial N(c)$, is a non-degenerate Seifert fiber space or a reducible manifold. On the other hand, since $O \cup c_p$ ($p \neq 2m \pm 1$) is a 2-bridge link and not a torus link, it is a hyperbolic link. (For details refer to the proof of Theorem 6.21 in [8].) This is a contradiction, so that X is not Seifert fibered. Figure 3.3 shows that X is homeomorphic to the exterior of the Montesinos link $L = M(\frac{1}{2m-p-1}, \frac{1}{2}, \frac{1}{2})$. The proof of

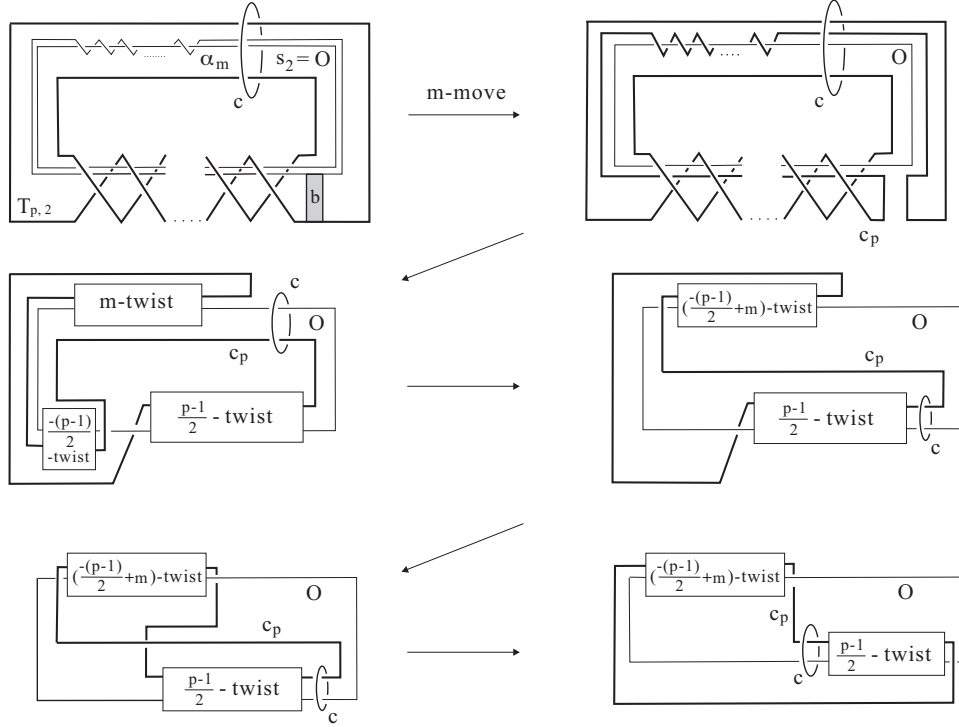

FIGURE 3.2.

[23, Corollary 5] shows that X is hyperbolic if X is not Seifert fibered, and L is not equivalent to the Montesinos links $M(\frac{1}{2}, \frac{1}{2}, \frac{-1}{2}, \frac{-1}{2})$, $M(\frac{2}{3}, \frac{-1}{3}, \frac{-1}{3})$, $M(\frac{1}{2}, \frac{-1}{4}, \frac{-1}{4})$, $M(\frac{1}{2}, \frac{-1}{3}, \frac{-1}{6})$, or the mirror images of these links. The 2-fold branched cover of S^3 along L is a prism manifold, which has a finite fundamental group. However, the 2-fold branched covers along the four Montesinos links above have infinite fundamental groups. Therefore, X is hyperbolic.

We note that $\{|\text{lk}(c, O)|, |\text{lk}(c_p, O)|\} = \{1, |m-p|\}$. Hence, if $O \cup c \cup c_p$ is isotopic to $O \cup c \cup c_q$ ($p, q \geq m$) in S^3 with O sent to O , then $p = q$. It follows that for each m the pairs of seiferters $\{c, c_p\}$ where $p \geq m$ are mutually distinct. \square (Lemma 3.2)

Remark 3.3. Corollary 5 in [23] states that a Montesinos link is hyperbolic if it is not a torus link, and not equivalent to the four Montesinos links listed above or their mirror images. However, in the proof the author assumes that links whose exteriors are Seifert fibered are torus links, which is not true. We thus obtain the corrected Corollary 5 in [23] by replacing the word “torus link” with “link whose exterior is Seifert fibered”.

The Hopf pair of seiferters $\{c, c_p\}$ satisfies $|\text{lk}(c, c_p)| = 1$. Now for a given integer $p > 1$, let us find an annular pair of seiferters $\{c_1, c_2\}$ with $\text{lk}(c_1, c_2) = p$ as claimed in Theorem 3.1(2). We will give such examples in Propositions 3.10 and 3.13. To prove the hyperbolicity of these examples, we prepare some general results.

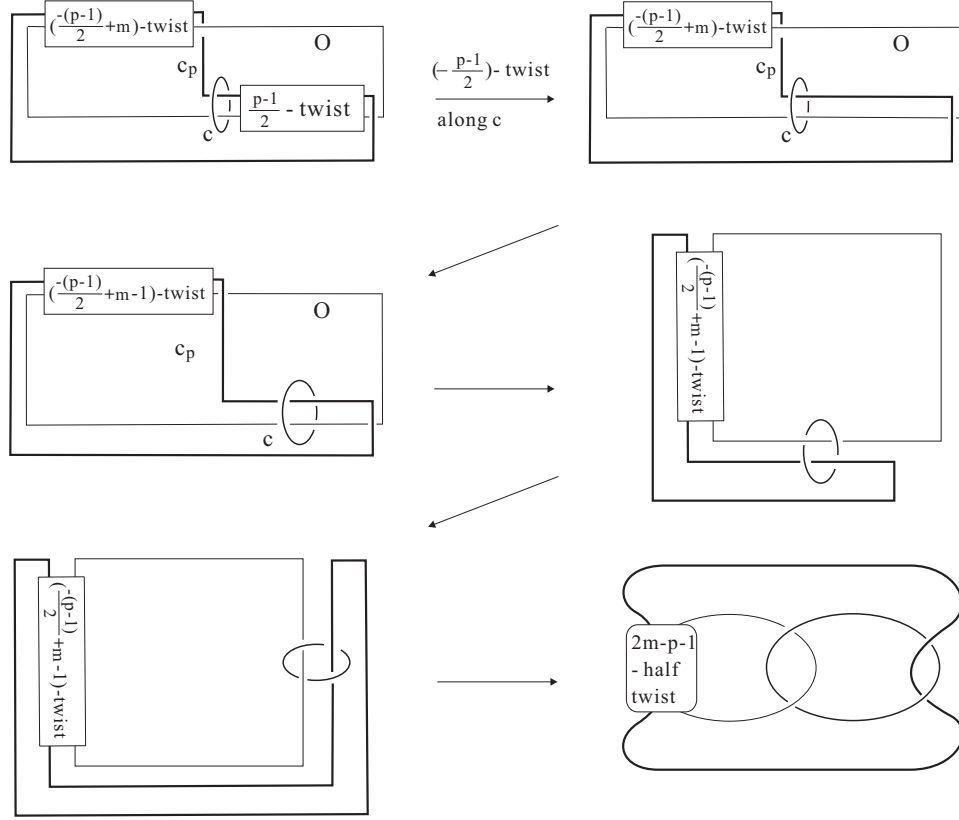

FIGURE 3.3. Continued from Figure 3.2.

Proposition 3.4. *Let $l_1 \cup \dots \cup l_n$ be an n -component link in a solid torus V . Suppose that there is a meridional disk D for V satisfying (1), (2) below.*

- (1) *The winding number of l_i in V equals $|D \cap l_i|$ for any i .*
- (2) *$V - \text{int}N(D \cup (\cup_{i=1}^n l_i))$ is homeomorphic to a handlebody.*

Then, if $V - \text{int}N(\cup_{i=1}^n l_i)$ contains an essential torus, it bounds a solid torus in V .

Proof of Proposition 3.4. We identify V split along D with $D^2 \times I$, where $I = [0, 1]$, and $D^2 \times \{0\}$ and $D^2 \times \{1\}$ are identified with D in V . Let a_1, \dots, a_m be the arcs in $D^2 \times I$ obtained by cutting $\cup_{i=1}^n l_i$ by D ; each a_i connects $D^2 \times \{0\}$ and $D^2 \times \{1\}$ by condition (1).

Assume that $V - \text{int}N(\cup_{i=1}^n l_i)$ contains an essential torus T . Isotope T in $V - \text{int}N(\cup_{i=1}^n l_i)$ so as to minimize the number of components $|D \cap T|$. Note that condition (2) implies $D \cap T \neq \emptyset$. Then D splits T into essential annuli A_1, A_2, \dots, A_k properly embedded in $D^2 \times I - \cup_{i=1}^m a_i$ such that a component of ∂A_i and a component of ∂A_{i+1} are identified in V , where $1 \leq i \leq k$, and if $i = k$ we regard $i + 1 = k + 1$ as 1.

Claim 3.5. *Each annulus A_i connects $D^2 \times \{0\}$ and $D^2 \times \{1\}$.*

Proof of Claim 3.5. Assume for a contradiction that some A_{i_0} satisfies $\partial A_{i_0} \subset D^2 \times \{\alpha\}$, where $\alpha = 0$ or 1 . Let B_1, B_2 be the disks in $D^2 \times \{\alpha\}$ bounded by the components of ∂A_{i_0} . If $B_1 \cap B_2 = \emptyset$, then B_1 intersects some arc a_{j_0} and $B_1 \cup A_{i_0} \cup B_2$ bounds a 3-ball in $D^2 \times I$. This implies $\partial a_{j_0} \subset D^2 \times \{\alpha\}$, a contradiction to condition (1) in Proposition 3.4. It follows that $B_1 \subset \text{int} B_2$ or $B_2 \subset \text{int} B_1$. Without loss of generality, we assume that the former holds. Let M be the 3-submanifold in $D^2 \times I$ bounded by the torus $A_{i_0} \cup (B_2 - \text{int} B_1)$. Condition (1) then implies that $M \cap a_i = \emptyset$ for any i .

Case 1. M is boundary irreducible.

If ∂M is incompressible in $X = V - \text{int} N(\cup_{i=1}^n l_i) - \text{int} M$, then after pushing ∂M in $V - \text{int} N(\cup_{i=1}^n l_i)$ off D , ∂M is an essential torus in $D^2 \times I - \text{int} N(\cup_{i=1}^m a_i)$. This contradicts condition (2) in Proposition 3.4. Hence, an essential simple closed curve c in ∂M bounds a disk in X . On the other hand, ∂B_1 is also an essential simple closed curve in ∂M bounding the disk B_1 in $V - \text{int} M$. Since the rank of $\text{Ker}(H_1(\partial M) \rightarrow H_1(V - \text{int} M))$ is less than or equal to one by the Poincaré duality, we see that $[c] = [\partial B_1]$ in $H_1(\partial M)$ and thus ∂B_1 bounds a disk in X . This contradicts the fact that A_{i_0} is essential in $D^2 \times I - \cup_{i=1}^m a_i$.

Case 2. M is boundary reducible.

It follows that M is a solid torus. Since $\partial B_1 \subset \partial M$ bounds the disk B_1 in $S^3 - \text{int} M$, a meridian of M and ∂B_1 intersect in one point. This implies that the annulus A_{i_0} is parallel to $B_1 - \text{int} B_2$ in M , and contradicts the fact that A_{i_0} is essential in $D^2 \times I - \cup_{i=1}^m a_i$. \square (Claim 3.5)

By Claim 3.5 the union of A_i and the two disks in $D^2 \times \{0, 1\}$ bounded by ∂A_i bounds a 3-ball V_i in $D^2 \times I$. Note that for any distinct i, j we have $V_i \cap V_j = \emptyset$, $V_i \subset V_j - A_j$, or $V_j \subset V_i - A_i$. If V_1, V_2, \dots, V_k are mutually disjoint, then $\cup_{i=1}^k V_i$ forms a solid torus in V bounded by T as claimed in Proposition 3.4. So assume that $V_i \subset V_j - A_j$ for some i, j . Then by Claim 3.5, $V_{i+\varepsilon} \subset V_{j+\varepsilon} - A_{j+\varepsilon}$, where $\varepsilon = \pm 1$ and we regard $k+1, 0$ as $1, k$, respectively. Repeating this argument, we see that for any V_i there exists V_j such that $V_i \subset V_j - A_j$. This does not occur for a finite number of 3-balls V_1, V_2, \dots, V_k . This completes the proof of Proposition 3.4. \square (Proposition 3.4)

The following proposition will be useful.

Proposition 3.6. *Let $l_1 \cup l_2$ be a 2-component link in a solid torus V such that l_1 is a (p, q) cable of V where $q \geq 2$, l_2 is a core of V , and $l_1 \cup l_2$ satisfies conditions (1), (2) in Proposition 3.4. Then, $l_1 \cup l_2$ is a hyperbolic link in V if we cannot isotope l_2 in $V - \text{int} N(l_1)$ so as to be disjoint from a cabling annulus for $N(l_1) \subset V$.*

Proof of Proposition 3.6. First we remark that since l_i ($i = 1, 2$) wraps V geometrically at least once, $V - \text{int} N(l_1 \cup l_2)$ is irreducible.

Assume for a contradiction that $V - \text{int} N(l_1 \cup l_2)$ contains an essential torus T .

Claim 3.7. *T is parallel to ∂V and separates l_1 and l_2 , and l_2 lies between T and ∂V .*

Proof of Claim 3.7. Since T is not essential in $V - \text{int} N(l_1)$, there are three cases: (1) T is compressible in $V - \text{int} N(l_1)$, (2) T is parallel to $\partial N(l_1)$ in $V - \text{int} N(l_1)$, and (3) T is parallel to ∂V in $V - \text{int} N(l_1)$. Case (3) implies Claim 3.7. So we derive a contradiction in cases (1), (2).

Let V' be the solid torus in V bounded by T (Proposition 3.4); V' contains at least one of l_1 and l_2 . Since each l_i is not contained in a 3-ball in V , V' is not contained in a 3-ball in V , either. It follows that $T = \partial V'$ is incompressible in $V - \text{int}V'$. Now assume case (1) occurs. Then $l_2 \subset V'$, and T separates l_1 and l_2 . Since $V - \text{int}N(l_2) \cong T^2 \times I$, T is parallel to $\partial N(l_2)$ in $V - \text{int}N(l_1 \cup l_2)$. This contradicts the fact that T is essential. Assume case (2) occurs. Since T is essential in $V - \text{int}N(l_1 \cup l_2)$, we have $l_2 \subset V'$. Then the winding number of l_2 in V is a multiple of $q(\geq 2)$. This contradicts the fact that l_2 is a core of V . \square (Claim 3.7)

Claim 3.8. *For any cabling annulus A for $N(l_1)$ in V , we can isotope l_2 in $V - \text{int}N(l_1)$ so as to be disjoint from A .*

Proof of Claim 3.8. Let W be the submanifold of $V - \text{int}N(l_1)$ cobounded by ∂V and T . Identify W and $\partial V \times I$ so that ∂V and T correspond to $\partial V \times \{0\}$ and $\partial V \times \{1\}$ respectively, and let $\pi : W = \partial V \times I \rightarrow I$ be the natural projection. Since $A' = A \cap W$ is a compact submanifold of W , $\pi(A')$ is a compact and thus closed subset of I . It follows that $\inf \pi(A') \in \pi(A')$ and $0 < \inf \pi(A')$, since $A \subset \text{int}V$. Now isotope $l_2 \cup T$ in W so that T becomes $\partial V \times \{\frac{1}{2} \inf \pi(A')\}$. After this isotopy l_2 becomes disjoint from A . \square (Claim 3.8)

Claim 3.8 contradicts the assumption in Proposition 3.6. Hence, $V - \text{int}N(l_1 \cup l_2)$ contains no essential torus.

Claim 3.9. *$X = V - \text{int}N(l_1 \cup l_2)$ contains no essential annulus.*

Proof of Claim 3.9. Assume for a contradiction that X contains an essential annulus. Since X contains no essential torus, and is irreducible and boundary irreducible, this assumption implies that X is a Seifert fiber space. Then X contains an essential annulus A connecting $\partial N(l_1)$ and ∂V ; note that A is also an essential annulus in the cable space $V - \text{int}N(l_1)$. Take a regular neighborhood $N(\partial V \cup A)$ in X . Then the closure of $\partial N(\partial V \cup A) - \partial X$ is a cabling annulus for $N(l_1)$ in V . Since the cabling annulus is disjoint from l_2 , this fact contradicts the assumption in Proposition 3.6. \square (Claim 3.9)

The proof of Proposition 3.6 is thus completed. \square (Proposition 3.6)

Proposition 3.10. *Let $c \cup c_{q,m}$ be the link obtained from $c \cup T_{1,q}$ in $S^3 - N(O)$ by an m -move using the band b in Figure 3.4(1) and an isotopy. Assume that $q \geq 3$, $m \neq 0, 1$, and $(m, q) \neq (-1, 3)$. Then, $\{c, c_{q,m}\}$ is a hyperbolic annular pair of seiferters for (O, m) with $\text{lk}(c, c_{q,m}) = q - 1$.*

Proof of Proposition 3.10. Since $S^3 - \text{int}N(O)$ admits a Seifert fibration in which c and $T_{1,q}$ in Figure 3.4(1) are fibers, $\{c, T_{1,q}\}$ is an annular pair of seiferters for (O, m) . After the m -move in Figure 3.4, $c_{q,m}$ and c in Figure 3.4(2) remain fibers in $O(m)$. Note that $c_{q,m}$ is the torus knot $T_{1,q-1}$, a trivial knot in S^3 , and $c \cup c_{q,m}$ bounds an annulus. It follows that $\{c, c_{q,m}\}$ is an annular pair of seiferters for (O, m) . Note that $\text{lk}(c, c_{q,m}) = q - 1$. It remains to show that $O \cup c \cup c_{q,m}$ is a hyperbolic link.

Let V be the solid torus $S^3 - \text{int}N(c)$ containing $O \cup c_{q,m}$. Then O is a core of V and $c_{q,m}$ is a $(1, q - 1)$ cable of V . The meridional disk D for V described

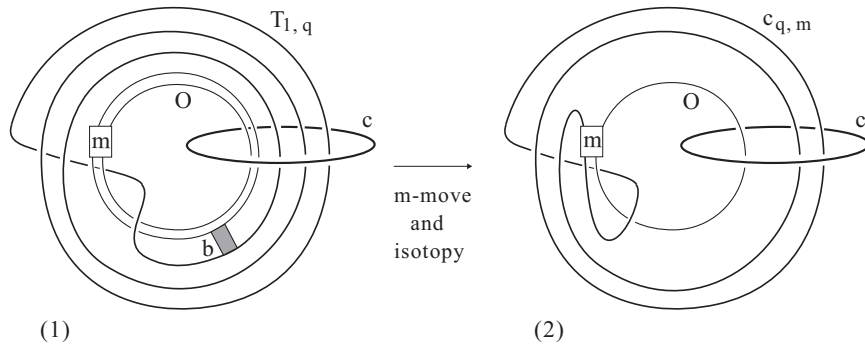

FIGURE 3.4. Annular pair of seiferters $\{c, c_{q,m}\}$; $q = 3$

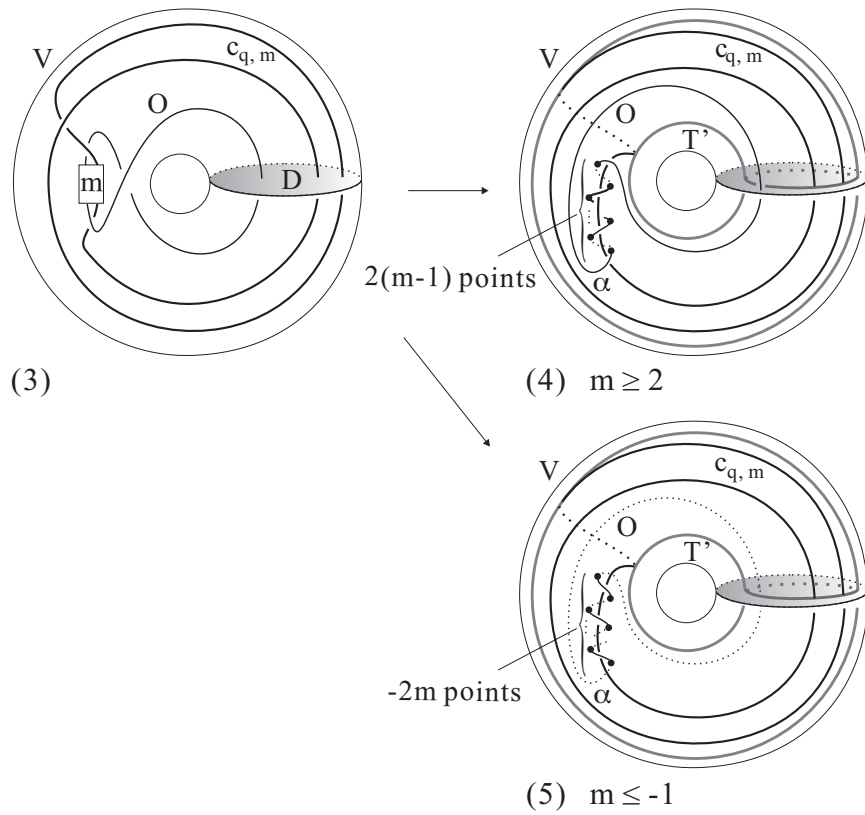

FIGURE 3.5. In (4), (5), the intersection points between O and T' are indicated by “dots”.

in Figure 3.5(3) intersects O in one point and $c_{q,m}$ in $q - 1$ points. Note also that $V - \text{int}N(D \cup O \cup c_{q,m})$ is homeomorphic to a handlebody. The link $O \cup c_{q,m}$ in V thus satisfies conditions (1), (2) with $n = 2$ in Proposition 3.4. Then by Proposition 3.6, in order to show that $O \cup c_{q,m}$ is hyperbolic in V , it is sufficient

to show that O cannot be isotoped in $V - \text{int}N(c_{q,m})$ off a cabling annulus for $N(c_{q,m}) \subset V$.

Now let T' be the torus in V containing $c_{q,m}$ as described in Figure 3.5(4), (5); then $A = T' - \text{int}N(c_{q,m})$ is a cabling annulus for $N(c_{q,m}) \subset V$. We note that T' intersects O in $2(m-1)$ points if $m \geq 2$, and in $-2m$ points if $m \leq -1$. We denote by α the closure of the component of $O - T'$ intersecting D . Let V' be the solid torus in V bounded by T' . Concerning the arc components of $O \cap V'$ and $O \cap (V - \text{int}V')$, we can check the following.

- Claim 3.11.**
- (1) In $V - \text{int}V'$ (resp. V'), the arc α in Figure 3.5(4) (resp. (5)) is isotopic with $\partial\alpha$ fixed to an arc in T' intersecting $c_{q,m}$ algebraically twice.
 - (2) In $V - \text{int}V'$ (resp. V'), each component β of $O \cap (V - \text{int}V')$ (resp. $O \cap V'$) other than α is isotopic with $\partial\beta$ fixed to an arc in T' intersecting $c_{q,m}$ once.

Using Claim 3.11, we show that there is no isotopy of O in $V - \text{int}N(c_{q,m})$ which makes the intersection between O and the cabling annulus A empty. Assume for a contradiction that there is an isotopy $f : S^1 \times I \rightarrow V - \text{int}N(c_{q,m})$ such that $f(S^1 \times \{0\}) = O$ and $f(S^1 \times \{1\}) \cap A = \emptyset$. We may assume that f is transverse to A ; then $f^{-1}(A)$ is a 1-submanifold properly embedded in $S^1 \times I$. Since $f(S^1 \times \{1\}) \cap A = \emptyset$, we see $f^{-1}(A) \cap (S^1 \times \{1\}) = \emptyset$, so that each arc component of $f^{-1}(A)$ has its end points in $S^1 \times \{0\}$. If $f^{-1}(A)$ has a circle component bounding a disk in $S^1 \times I$, then by the loop theorem and the incompressibility of A in $V - \text{int}N(c_{q,m})$ f restricted on the innermost circle is null-homotopic in A . Hence we can modify f so that the innermost circle is eliminated. Thus by re-choosing f we may assume $f^{-1}(A)$ does not contain null-homotopic circles in $S^1 \times I$. For two arc components a_1, a_2 of $f^{-1}(A)$, we say that a_1 is closer to $S^1 \times \{0\}$ than a_2 if the disk cobounded by a_2 and an arc in $S^1 \times \{0\}$ contains a_1 . Let c_1 be an arc component of $f^{-1}(A)$ closest to $S^1 \times \{0\}$, and c_2 the arc in $S^1 \times \{0\}$ such that $c_1 \cup c_2$ cobounds a disk in $S^1 \times I$. Note that $f(c_2)$ is the closure of a component of $O - A$, and $f(c_1)$ is an immersed arc in A with $\partial f(c_1) = \partial f(c_2)$.

Claim 3.12. *It holds that $q = 3$, $m \leq -1$, and $f(c_2)$ is the arc α ($\subset V'$) in Figure 3.5(5).*

Proof of Claim 3.12. Set $X = V'$ if $f(c_2) \subset V'$, and $X = V - \text{int}V'$ if $f(c_2) \subset V - \text{int}V'$. Then $f(c_1) \subset A$ is homotopic in X to the component $f(c_2)$ of $O \cap X$ with its end points fixed. Combining this homotopy and the isotopies in Claim 3.11, we see that $f(c_1)$ is homotopic in X with its end points fixed to an arc γ in T' intersecting $c_{q,m}$ once (if $f(c_2)$ is an arc β in Claim 3.11(2)) or algebraically twice (if $f(c_2)$ is the arc α in Claim 3.11(1)). Hence, the closed curve $f(c_1) \cup \gamma$ in T' intersecting $c_{q,m}$ once or algebraically twice is null-homotopic in X . Since $V - \text{int}V' \cong T^2 \times I$, $f(c_1) \cup \gamma$, which is not null-homotopic in T' , is not null-homotopic in $V - \text{int}V'$. It follows that $X = V'$ and thus $f(c_2) \subset V'$. Since $c_{q,m}$ is the $(1, q-1)$ cable of V' where $q \geq 3$, a meridian of V' intersects $c_{q,m}$ algebraically $q-1$ times. It follows that $q = 3$ and γ intersects $c_{q,m}$ algebraically twice. Furthermore, we see that $f(c_2)$ is the arc α in Figure 3.5(5) and so $m \leq -1$. \square (Claim 3.12)

By Claim 3.12 c_1 is the only arc component of $f^{-1}(A)$ closest to $S^1 \times \{0\}$. Hence all arc components of $f^{-1}(A)$ are parallel to c_1 in $S^1 \times I$. The assumption

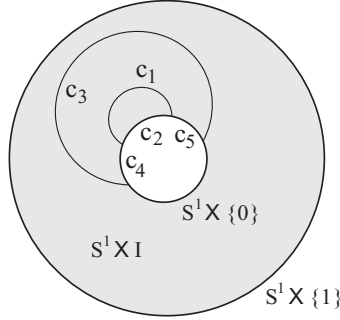

FIGURE 3.6.

$(m, q) \neq (-1, 3)$ in Proposition 3.10 together with Claim 3.12 implies $m \leq -2$, so that A intersects O in $-2m(\geq 4)$ points and hence $f^{-1}(A)$ has at least two arc components. Let c_3 be the second closest arc component of $f^{-1}(A)$ to $S^1 \times \{0\}$, and c_4, c_5 the subarcs of $S^1 \times \{0\}$ connecting ∂c_1 and ∂c_3 ; see Figure 3.6. Note that $f(c_4)$ and $f(c_5)$ are the components of $O \cap (V - \text{int}V')$ adjacent to $f(c_2) = \alpha$. Now we give the arcs c_4 and c_5 the orientations induced from an orientation of $S^1 \times \{0\}$. Then, Figure 3.5(5) shows that $f(c_4)$ and $f(c_5)$ are isotopic to arcs in T' whose algebraic intersection numbers with $c_{q,m}$ are both one under an adequate orientation of $c_{q,m}$. This implies that the closed curve $f(c)$ where $c = c_1 \cup c_5 \cup c_3 \cup c_4$ is homotopic in $V - \text{int}V'$ to a closed curve in T' intersecting $c_{q,m}$ algebraically twice. Then, $f(c)$ is not null-homotopic in $V - \text{int}V' \cong T^2 \times I$. On the other hand, since c bounds a disk in $S^1 \times I$ whose image under f is contained in $V - \text{int}V'$, $f(c)$ is null-homotopic in $V - \text{int}V'$. This is a contradiction. \square (Proposition 3.10)

Proposition 3.13. *Let $c \cup c'_{q,m}$ be the link obtained from $c \cup T_{1,q}$ in $S^3 - N(O)$ by an m -move using the band b' in Figure 3.7(1) and an isotopy. Assume that $q \geq 1$, $m \neq -1, 0$, and $(m, q) \neq (1, 1)$. Then $\{c, c'_{q,m}\}$ is a hyperbolic annular pair of seiferters for (O, m) with $\text{lk}(c, c'_{q,m}) = q + 1$.*

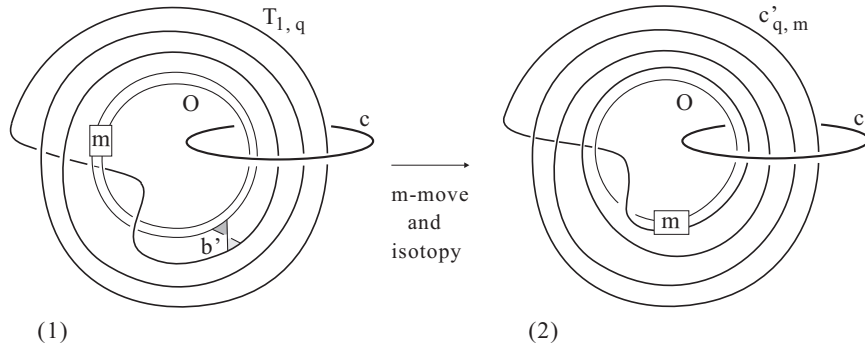

FIGURE 3.7. Annular pair of seiferters $\{c, c'_{q,m}\}$; $q = 3$

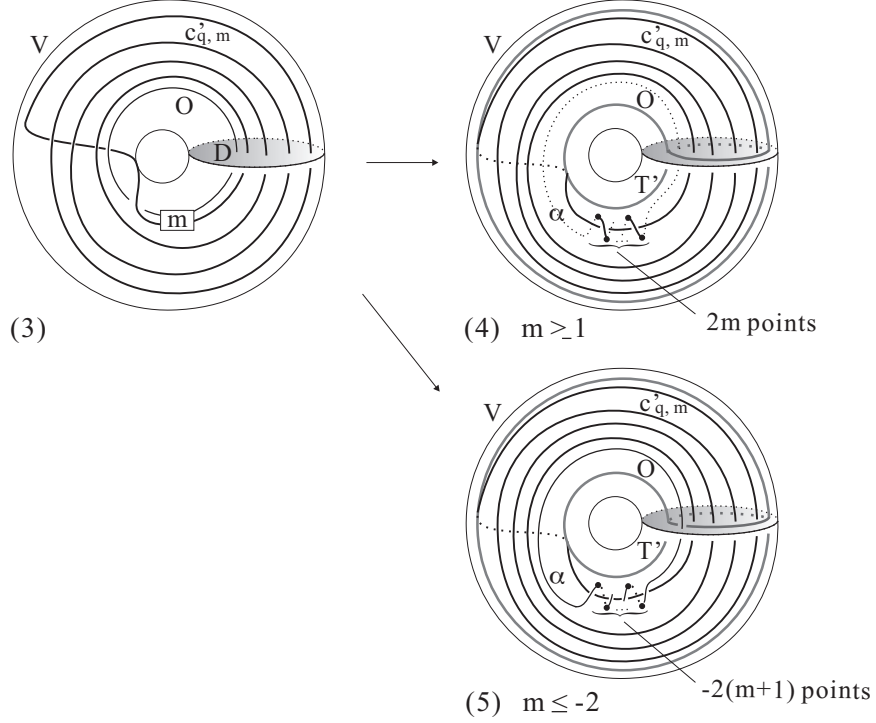

FIGURE 3.8. In (4), (5), the intersection points between O and T' are indicated by “dots”.

Proof of Proposition 3.13. Apply the same argument as in the proof of Proposition 3.10 with replacement of Claims 3.11 and 3.12 by Claims 3.14 and 3.15 below. \square (Proposition 3.13)

- Claim 3.14.** (1) In V' (resp. $V - \text{int}V'$), the arc α in Figure 3.8(4) (resp. (5)) is isotopic with $\partial\alpha$ fixed to an arc in T' intersecting $c'_{q,m}$ algebraically twice.
- (2) In V' (resp. $V - \text{int}V'$), each component β of $O \cap V'$ (resp. $O \cap (V - \text{int}V')$) other than α is isotopic with $\partial\beta$ fixed to an arc in T' intersecting $c'_{q,m}$ once.

Claim 3.15. It holds that $q = 1$, $m \geq 1$, and $f(c_2)$ is the arc $\alpha \subset V'$ in Figure 3.8(4).

Remark 3.16. Assume that $p \geq 2$, $m \neq 0, \pm 1$. Then $\{c, c_{p+1,m}\}$ in Proposition 3.10 and $\{c, c'_{p-1,m}\}$ in Proposition 3.13 are both hyperbolic annular pairs of seiferters for (O, m) with $\text{lk}(c, c_{p+1,m}) = \text{lk}(c, c'_{p-1,m}) = p$. Since $\{|\text{lk}(c, O)|, |\text{lk}(c_{p+1,m}, O)|\} = \{1, |1 - m|\}$ does not coincide with $\{|\text{lk}(c, O)|, |\text{lk}(c'_{p-1,m}, O)|\} = \{1, |1 + m|\}$, $\{c, c_{p+1,m}\}$ and $\{c, c'_{p-1,m}\}$ are distinct, annular pairs for (O, m) .

4. SEIFERTERS AND HOPF PAIRS FOR $(T_{p,2}, m)$

Theorem 4.1. For nontrivial torus knots $T_{p,2}$ ($|p| \geq 3$), the following hold.

- (1) Each Seifert surgery $(T_{p,2}, m)$ has a hyperbolic Hopf pair of seiferters.
- (2) A Seifert surgery $(T_{p,2}, m)$ has a hyperbolic seiferter if $m \neq 2p \pm 1$ and $(m, p) \neq (4, 3), (-4, -3)$.

Proof of Theorem 4.1. Theorem 4.1(1) follows from Proposition 4.2(1) below.

Theorem 4.1(2) follows from Proposition 4.2(2) if $|p| \geq 5$ and $m \neq 2p$. The case when $m = 2p$ follows from the fact that $(T_{p,q}, pq)$ has a hyperbolic seiferter for any nontrivial torus knot $T_{p,q}$ (Claim 5.2 and [21, Lemma 9.1]). The remaining case is when $|p| = 3$. For trefoil knots, various seiferters and annular pairs are found in [9]. For example, we see from Remark 4.6(1) that $(T_{3,2}, m)$ (resp. $(T_{-3,2}, m)$) has a hyperbolic seiferter if $m \neq 4$ (resp. $m \neq -4$). This shows Theorem 4.1(2) with $|p| = 3$. \square (Theorem 4.1)

Proposition 4.2. *Let c_m be the knot obtained from the basic seiferter s_2 for $(T_{p,2}, m)$ ($|p| \geq 3$) by an m -move using the band b described in Figure 4.1. Then the following hold.*

- (1) For the meridional seiferter c_μ as in Figure 4.1, $\{c_\mu, c_m\}$ is a hyperbolic Hopf pair of seiferters for $(T_{p,2}, m)$.
- (2) The knot c_m is a hyperbolic seiferter for $(T_{p,2}, m)$ if $|p| \geq 5$ and $m \neq 2p, 2p \pm 1$.

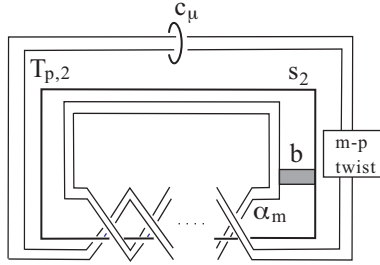

FIGURE 4.1. $c_m = s_2 \natural_b \alpha_m$

Remark 4.3. If $m = 2p$, then c_m in Proposition 4.2 is the same as the basic seiferter s_2 for $T_{p,2}$. If $m = 2p \pm 1$, then c_m is $(1, \frac{m \pm 1}{2})$ cable of s_p for $T_{p,2}$, i.e. c_m is the seiferter $s_{p, \pm 1}$ for $(T_{p,2}, 2p \pm 1)$ defined in [8, Corollary 3.15(2)].

Proof of Proposition 4.2. In (1) we may assume that $p \geq 3$ because the corresponding result for $p \leq -3$ can be derived by taking mirror images. For the same reason we may assume $p \geq 5$ in (2).

(1) The sequence of isotopies in Figures 4.2 and 4.3 shows that c_m is a trivial knot. Since c_m is obtained from s_2 by an m -move and $T_{p,2}$ is a nontrivial knot, c_m is a seiferter for $(T_{p,2}, m)$ by Proposition 2.19(3) in [8]. Furthermore, since $\{c_\mu, s_2\}$ is a pair of seiferters for $(T_{p,2}, m)$ and the band b is disjoint from c_μ in Figure 4.1, $\{c_\mu, c_m\}$ is a pair of seiferters [8, Lemma 2.25(2)]. The last figure of Figure 4.4 shows that $\{c_\mu, c_m\}$ is a Hopf pair of seiferters. Let us verify that no annulus cobounded by c_μ and c_m intersects $T_{p,2}$ if $m \neq p \pm 1$. This implies that $\{c_\mu, c_m\}$ ($m \neq p \pm 1$) is not irrelevant and thus an annular pair (Remark 1.3); in particular, $\{c_\mu, c_0\}$ is

an annular pair of seiferters. Since $|\text{lk}(c_m, T_{p,2})| = |m - p| \neq 1 = |\text{lk}(c_\mu, T_{p,2})|$, c_m is not homologous to c_μ in $S^3 - T_{p,2}$. It follows that c_μ and c_m does not cobound an annulus disjoint from $T_{p,2}$, as desired.

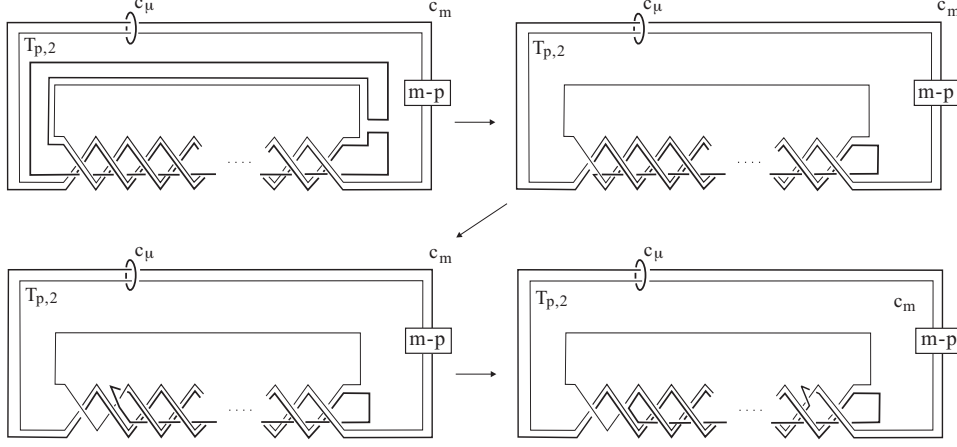

FIGURE 4.2. Isotopy of $T_{p,2} \cup c_\mu \cup c_m$

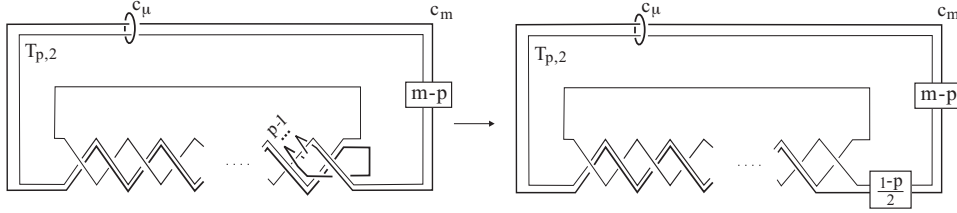

FIGURE 4.3. Continued from Figure 4.2

Let us show that $\{c_\mu, c_m\}$ is a hyperbolic annular pair for any m . In the last figure of Figure 4.4, $(-m)$ -twist along c_μ changes $T_{p,2} \cup c_m$ to $T_{p,2} \cup c_0$. Hence, there is an orientation preserving homeomorphism from $S^3 - T_{p,2} \cup c_\mu \cup c_m$ to $S^3 - T_{p,2} \cup c_\mu \cup c_0$. Thus it is sufficient to show that $S^3 - T_{p,2} \cup c_\mu \cup c_0$ is hyperbolic. Since $c_\mu \cup c_0$ is isotopic to $c_\mu \cup s_2$ in $T_{p,2}(0)$, c_μ and c_0 are exceptional fibers of indices $2p$ and 2 , respectively in the small Seifert fiber space $T_{p,2}(0)$ over $S^2(2, p, 2p)$. Then apply Theorem 3.24 in [8] to the annular pair $\{c_\mu, c_0\}$. We see that $\{c_\mu, c_0\}$ is a hyperbolic annular pair or a basic annular pair, i.e. a pair of basic seiferters c_μ, s_2, s_p as drawn in Figure 1.1. However, the latter does not occur because $|\text{lk}(c_\mu, c_0)| = 1$. Hence, $\{c_\mu, c_0\}$ and thus $\{c_\mu, c_m\}$ are hyperbolic annular pairs for $(T_{p,2}, m)$.

(2) Assume that $m \neq 2p, 2p \pm 1$, and $p \geq 5$. As shown in (1) c_m is isotopic to s_2 in $T_{p,2}(m)$, and thus an exceptional fiber of index 2 in $T_{p,2}(m)$, a Seifert fiber space over $S^2(2, p, |2p - m|)$. Then, [8, Corollary 3.15] shows that c_m is either a basic or a hyperbolic seiferters. Therefore, Claim 4.4 below implies that c_m is a hyperbolic seiferters for $(T_{p,2}, m)$, as claimed in Proposition 4.2(2). \square (Proposition 4.2)

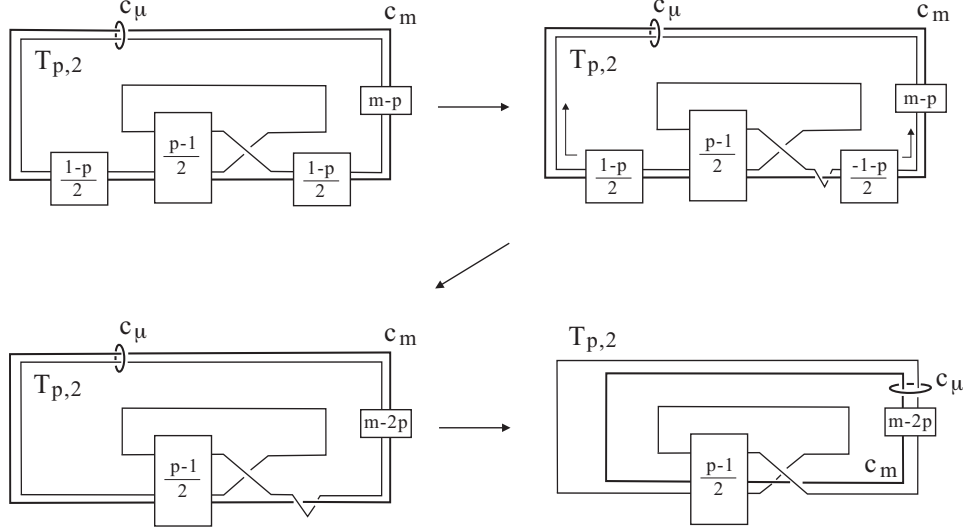

FIGURE 4.4. Continued from Figure 4.3

Claim 4.4. *The seiferter c_m in Figure 4.1 is not a basic seiferter for $(T_{p,2}, m)$.*

Proof of Claim 4.4. We observe the following from the last figure in Figure 4.4.

- (i) The seiferter c_{2p} is the same as the basic seiferter s_2 for $T_{p,2}$.
- (ii) The link $T_{p,2} \cup c_m$ is obtained from $T_{p,2} \cup s_2$ after $(m - 2p)$ -twist along c_{μ} .

Let $M = S^3 - \text{int}N(T_{p,2} \cup c_{\mu} \cup c_{2p})$; M is proved to be hyperbolic in the proof of Proposition 4.2(1). We see from observations (i), (ii) above that the $\frac{1}{2p-m}$ -Dehn filling $M(\frac{1}{2p-m})$ along $\partial N(c_{\mu})$ is homeomorphic to $S^3 - \text{int}N(T_{p,2} \cup c_m)$, and $M(\frac{1}{0}) \cong S^3 - \text{int}N(T_{p,2} \cup s_2)$ is a Seifert fiber space. Now assume for a contradiction that c_m is a basic seiferter for $T_{p,2}$; then $S^3 - \text{int}N(T_{p,2} \cup c_m)$ is Seifert fibered. By [13, Corollary 1.2] we obtain $|2p - m| \leq 3$. Since $m \neq 2p, 2p \pm 1$, it follows $|2p - m| = 2$ or 3 .

Assume $|2p - m| = 2$; then $|\text{lk}(c_m, T_{p,2})| = m - p = p + 2 (> 0)$ or $p - 2 (> 0)$. If c_m is the same as s_2 , then we have $|\text{lk}(c_m, T_{p,2})| = |\text{lk}(s_2, T_{p,2})| = p$, a contradiction. If c_m is the same as s_p , then we have $|\text{lk}(c_m, T_{p,2})| = 2$, so that $p = 0$ or 4 . This is not the case because p is an odd integer. If c_m is the same as c_{μ} , then since $|\text{lk}(c_{\mu}, T_{p,2})| = 1$, we obtain $p = -1, 3$. This contradicts the assumption $p \geq 5$.

Assume $|2p - m| = 3$; then $|\text{lk}(c_m, T_{p,2})| = m - p = p + 3 (> 0)$ or $p - 3 (> 0)$. By comparing linking numbers as above, we can see that c_m is distinct from s_2, c_{μ} , and thus c_m is the same as s_p and $p = 5$. Since c_m is also isotopic to s_2 in $T_{p,2}(m)$, $T_{p,2}(m) - \text{int}N(s_2)$ (a Seifert fiber space over $D^2(p, |2p - m|) = D^2(5, 3)$) is homeomorphic to $T_{5,2}(m) - \text{int}N(s_5)$ (a Seifert fiber space over $D^2(2, 3)$). This homeomorphism does not preserve Seifert fibrations up to isotopy, a contradiction to [19, Theorem VI.18]. \square (Claim 4.4)

As for $T_{-3,2}$ we find various seiferters and annular pairs of seiferters in [9].

Proposition 4.5 ([9]). *Take the knot c^m in $S^3 - T_{3,2}$ illustrated in Figure 4.5; then c^m is a hyperbolic seiferter for $(T_{3,2}, m)$, $(T_{3,2}, m+1)$, and $(T_{3,2}, m+2)$ except when $m = 2, 3, 4, 5$. In particular, $(T_{3,2}, m)$ has a hyperbolic seiferter if $m \neq 4, 5$.*

- Remark 4.6.*
- (1) By setting $n = 2$ in Proposition 5.5, we see that $(T_{3,2}, 5)$ has a hyperbolic seiferter. This together with Proposition 4.5 shows that $(T_{3,2}, m)$ has a hyperbolic seiferter for $m \neq 4$.
 - (2) The seiferter c^m in Figure 4.5 for $(T_{3,2}, m)$ is isotopic in $S^3 - T_{3,2}$ to the seiferter c_{m+2} for $(T_{3,2}, m+2)$ in Figure 4.1.

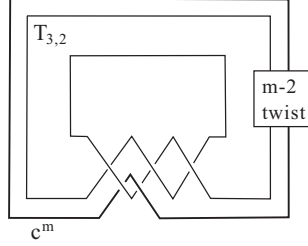

FIGURE 4.5. Seiferter $c^m (= c_{m+2})$ for $(T_{3,2}, m)$

5. SEIFERTERS NOT ORIGINATING IN SEIFERT FIBRATIONS OF TORUS KNOT SPACES

As shown in Proposition 2.2, if $m \neq pq, pq \pm 1$ and $T_{p,q}(m)$ is not a prism manifold, then any seiferter for $(T_{p,q}, m)$ is m -equivalent to a basic seiferter or a regular fiber of $S^3 - N(T_{p,q})$. On the contrary, as shown in this section, there exist seiferters for $(T_{p,q}, m)$ which cannot be obtained from basic seiferters or regular fibers by a sequence of m -moves. In fact, for all $T_{p,q}$ but $T_{\pm 3,2}$ the degenerate Seifert surgery $(T_{p,q}, pq)$ has a hyperbolic seiferter not pq -equivalent to a basic seiferter or a regular fiber in $S^3 - N(T_{p,q})$; for some $T_{p,q}$ Seifert surgeries $(T_{p,q}, m)$ where $m = pq + 1$ or $pq - 1$ have such seiferters. Examples of the former statement will be given in Proposition 5.1, and those of the latter in Propositions 5.4, 5.5.

Proposition 5.1. *Each Seifert surgery $(T_{p,q}, pq)$ ($|p| > q \geq 2$) where $(p, q) \neq (\pm 3, 2)$ has a hyperbolic seiferter which is not pq -equivalent to any basic seiferter for $T_{p,q}$ or a regular fiber of $S^3 - N(T_{p,q})$. Furthermore, if $|p+q|$ and $|p-q|$ are both greater than one, then $(T_{p,q}, pq)$ has at least two such hyperbolic seiferters.*

Proof of Proposition 5.1. Let c_+, c_- be the knots in the exterior of a nontrivial torus knot $T_{p,q}$ as described in Figure 5.1. The link $T_{p,q} \cup c_+$ is exactly the same as the link $T_{p,q} \cup c$ in [8, Figure 4.2]; see also [21, Fig. 13]. Note that $\text{lk}(c_+, T_{p,q}) = p+q$ and $\text{lk}(c_-, T_{p,q}) = p-q$. The result on c_+ in Claim 5.2 below is essentially obtained in [21, Lemma 9.1]. Since the link $T_{p,q} \cup c_-$ is the mirror image of $T_{-p,q} \cup c_+$, the statement on c_- also holds.

Claim 5.2. *The knots c_{\pm} are seiferters for $(T_{p,q}, pq)$. Each of c_{\pm} is a degenerate Seifert fiber in $T_{p,q}(pq)$ such that $T_{p,q}(pq) - \text{int}N(c_{\pm})$ is a Seifert fiber space over the disk with two exceptional fibers of indices $|p|, q$. Furthermore, if $|p+q| \neq 1$ (resp. $|p-q| \neq 1$), then c_+ (resp. c_-) is a hyperbolic seiferter for $(T_{p,q}, pq)$; otherwise, c_+ (resp. c_-) is a meridian of $T_{p,q}$.*

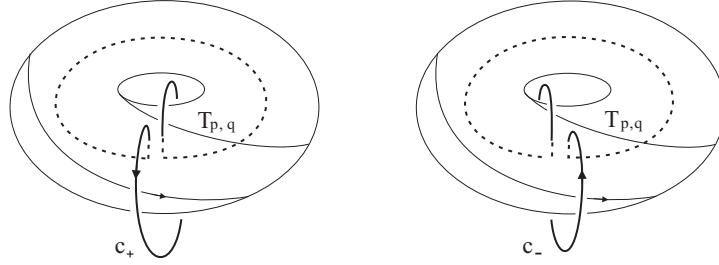
FIGURE 5.1. Hyperbolic seiferters c_+ and c_- for $(T_{p,q}, pq)$

Since there are no p, q ($|p| > q \geq 2$) satisfying $|p+q| = |p-q| = 1$, at least one of c_+, c_- is a hyperbolic seiferters for $(T_{p,q}, pq)$. Set $c = c_+$ if $|p+q| \neq 1$, and otherwise $c = c_-$.

Let us show that c is not pq -equivalent to any basic seiferters if $(p, q) \neq (3, \pm 2)$. If c were pq -equivalent to s_p (resp. s_q), then the Seifert fiber space $T_{p,q}(pq) - \text{int}N(c)$ would be homeomorphic to $T_{p,q}(pq) - \text{int}N(s_p) \cong S^1 \times D^2 \# L(q, p)$ (resp. $T_{p,q}(pq) - \text{int}N(s_q) \cong S^1 \times D^2 \# L(p, q)$), a contradiction to Claim 5.2. If c were pq -equivalent to a meridional seiferters c_μ , then [8, Proposition 2.22(1)] would show that $\text{lk}(c, T_{p,q}) = \pm 1 + xpq$ for some integer x . Since $\text{lk}(c, T_{p,q}) = p \pm q$, a simple computation shows $(p, q) = (\pm 3, 2)$, a contradiction to our assumption. If c were pq -equivalent to a regular fiber t in $S^3 - N(T_{p,q})$, then the Seifert fiber space $T_{p,q}(pq) - \text{int}N(c)$ would be homeomorphic to $T_{p,q}(pq) - \text{int}N(t) \cong S^1 \times D^2 \# L(p, q) \# L(q, p)$, a contradiction.

Suppose that $|p+q|$ and $|p-q|$ are both greater than one. We then see that c_+ and c_- are both hyperbolic seiferters for $(T_{p,q}, pq)$ with the required property. Since $|\text{lk}(c_+, T_{p,q})| = |p+q| \neq |p-q| = |\text{lk}(c_-, T_{p,q})|$, c_+ and c_- are distinct seiferters. \square (Proposition 5.1)

Remark 5.3. $(T_{p,q}, pq)$ may have a hyperbolic seiferters other than c_+ and c_- . For example, $(T_{3,5}, 15)$ has a hyperbolic seiferters c such that $\text{lk}(c, T_{3,5}) = 4$. Since $4 \neq |3 \pm 5|$, c is neither c_+ nor c_- . See [8, Remark 9.20(1)].

A seiferters for $(T_{p,q}, pq)$ which is not pq -equivalent to any basic seiferters or a regular fiber of $S^3 - N(T_{p,q})$ arises because of non-uniqueness of degenerate Seifert fibrations of $T_{p,q}(pq)$. Similarly, non-uniqueness of Seifert fibrations of lens spaces make it possible for some lens surgeries to have such seiferters.

Proposition 5.4. *The lens surgery $(T_{2n+1,n}, n(2n+1)-1)$ ($n \geq 2$) has a hyperbolic seiferters which is not $(n(2n+1)-1)$ -equivalent to any basic seiferters for $T_{2n+1,n}$ or a regular fiber of $S^3 - N(T_{2n+1,n})$.*

Proof of Proposition 5.4. In [7, Proposition 3.7], we prove that c described in Figure 5.2(1) is a seiferters for the lens surgery $(T_{-2n-3,n+2}, (-2n-3)(n+2)+1)$. Twisting $T_{-2n-3,n+2}$ once along the seiferters c , we obtain Figure 5.2(2). Figure 5.3 demonstrates that the image of $T_{-2n-3,n+2}$ after the twisting is $T_{2n+1,n}$; since $\text{lk}(c, T_{-2n-3,n+2}) = 2n+2$, the resulting surgery slope is $(-2n-3)(n+2)+1+(2n+2)^2 = n(2n+1)-1$. Thus we obtain the lens surgery $(T_{2n+1,n}, n(2n+1)-1)$ for which c remains a seiferters. Note that $\text{lk}(c, T_{2n+1,n}) = \text{lk}(c, T_{-2n-3,n+2}) = 2n+2$.

FIGURE 5.2. An n -Dehn twist is performed along the annulus A .

FIGURE 5.3.

Let (K_p, m_p) be the Seifert surgery obtained from $(T_{2n+1, n}, n(2n+1) - 1)$ after p -twist along c . Then (K_p, m_p) ($p \in \mathbb{Z}$) are Berge's lens surgeries on Type III knots. Proposition 3.8 in [7] shows that each lens space $K_p(m_p)$ has a Seifert fibration \mathcal{F} over S^2 such that \mathcal{F} has two exceptional fibers and c (the image of c after twisting) is a regular fiber of \mathcal{F} . Hence, $K_p(m_p) - \text{int}N(c)$ is a Seifert fiber space over the disk with two exceptional fibers.

Since $\text{lk}(c, T_{2n+1, n}) = 2n + 2 \notin \{1, n, 2n + 1\}$, the seifert c is not a basic seifert for $T_{2n+1, n}$. Then, if c were not a hyperbolic seifert for $(K_0, m_0) = (T_{2n+1, n}, n(2n+1) - 1)$, case (2), (4), (5), (6), or (7) in Corollary 3.15 in [8] would occur.

In these cases, c is a $(1, x)$ cable ($|x| \geq 2$) of an unknotted solid torus V in S^3 , K_0 is a knot in $U = S^3 - \text{int}V$, and a Seifert fibration of $K_0(m_0)$ restricts to that of V with c a regular fiber. Now for a knot k in a 3-manifold $X (\subset S^3)$, let us denote by $X(k; \gamma)$ the manifold obtained from X after γ -surgery on k . If $|p| \geq 2$, then $V(c; -\frac{1}{p})$ has a Seifert fibration over the disk in which a core of the filled solid torus is an exceptional fiber of index $|px+1|$ and a core of V is another exceptional fiber of index $|x|$. In cases (2), (4), (5), and (7), $U(K_0; m_0)$ has a Seifert fibration over the disk with at most two exceptional fibers. Hence $K_p(m_p) = U(K_0; m_0) \cup V(c; -\frac{1}{p})$ is either a Seifert fiber space with more than two exceptional fibers or a lens space which has two exceptional fibers with c (the image of c after p -twist) one of them. The former case contradicts the fact that (K_p, m_p) is a lens surgery for any p . The latter implies $K_p(m_p) - \text{int}N(c)$ is a solid torus, a contradiction. The remaining case is (6) in Corollary 3.15 in [8]. In this case, $K_0(m_0) - \text{int}N(c)$ is a Seifert fiber space over the Möbius band with one exceptional fiber, a contradiction. It follows that c is a hyperbolic seifert for (K_0, m_0) .

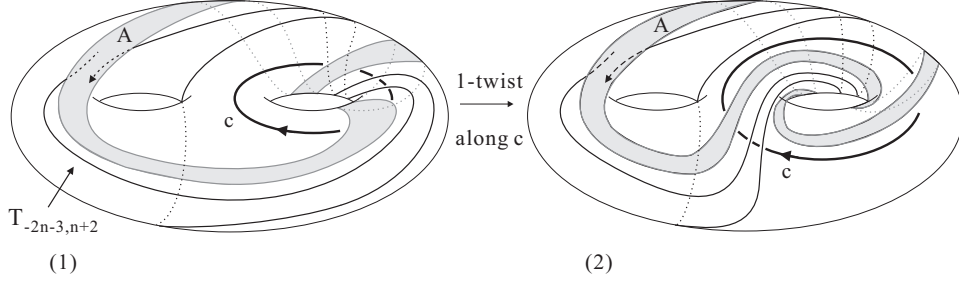
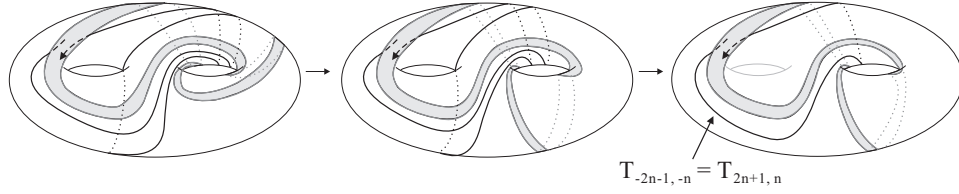
Finally we show that c is not m_0 -equivalent to any basic seifert for $K_0 = T_{2n+1, n}$ or a regular fiber in $S^3 - N(K_0)$, where $m_0 = n(2n+1) - 1$. If c

is m_0 -equivalent to a basic seifert s_{2n+1} or s_n for K_0 , then c is an exceptional fiber in the lens space $K_0(m_0)$. It follows that $K_0(m_0) - \text{int}N(c)$ is a solid torus, a contradiction. Let us suppose that c is m_0 -equivalent to c_μ . Then, since $|\text{lk}(c_\mu, K_0)| = 1$, [8, Proposition 2.22(1)] implies $\text{lk}(c, K_0) = \pm 1 + xm_0$ for some integer x . On the other hand, $\text{lk}(c, K_0) = 2n + 2$. We thus have $\pm 1 + xm_0 = 2n + 2$, where $n \geq 2$. Then $x = \frac{2n+1}{2n^2+n-1}$ or $\frac{2n+3}{2n^2+n-1}$; these cannot be integers because $2n^2 + n - 1 > 2n + 3 > 2n + 1 > 0$ for $n \geq 2$. Hence c cannot be m_0 -equivalent to c_μ . Let us show that the seifert c for (K_0, m_0) is not m_0 -equivalent to a regular fiber of $S^3 - N(K_0)$. Since the linking number between $T_{2n+1, n}$ and a regular fiber of $S^3 - N(T_{2n+1, n})$ is $\pm n(2n + 1)$. We obtain $\pm n(2n + 1) + xm_0 = 2n + 2$ for some integer x ([8, Proposition 2.22(1)]), where $n \geq 2$. Then $x = -1 + \frac{2n+1}{2n^2+n-1}$ or $1 + \frac{2n+3}{2n^2+n-1}$, which cannot be integers for any n . Hence c cannot be m_0 -equivalent to a regular fiber in $S^3 - N(K_0)$. \square (Proposition 5.4)

Proposition 5.5. *The lens surgery $(T_{2n-1, n}, n(2n-1)-1)$ ($n \geq 2$) has a hyperbolic seifert which is not $(n(2n-1)-1)$ -equivalent to any basic seifert for $T_{2n-1, n}$ or a regular fiber of $S^3 - N(T_{2n-1, n})$.*

Proof of Proposition 5.5. In [7, Section 4], we prove that c' described in Figure 5.4(1) is a seifert for the lens surgery $(T_{-2n-3, n+1}, (-2n-3)(n+1)+1)$. Twisting $T_{-2n-3, n+1}$ once along c' , we obtain Figure 5.4(2). Figure 5.5 demonstrates that the image of $T_{-2n-3, n+1}$ after the twisting is $T_{2n-1, n}$; since $\text{lk}(c', T_{-2n-3, n+1}) = 2n+1$, the resulting surgery slope is $(-2n-3)(n+1)+1+(2n+1)^2 = n(2n-1)-1$. Thus we obtain a lens surgery $(T_{2n-1, n}, n(2n-1)-1)$ for which c' remains a seifert. Note that $\text{lk}(c', T_{2n-1, n}) = \text{lk}(c', T_{-2n-3, n+1}) = 2n+1$.

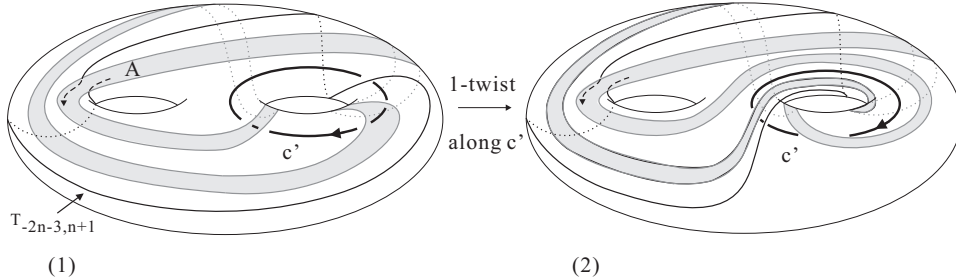

FIGURE 5.4. An n -Dehn twist is performed along the annulus A .

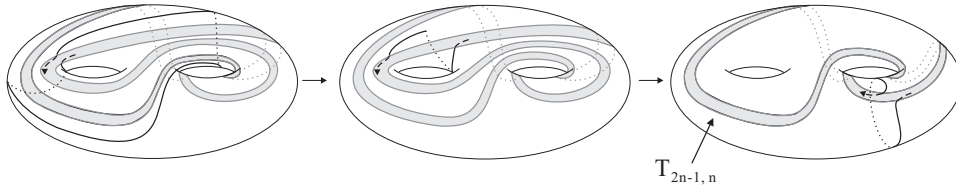

FIGURE 5.5.

Let (K_p, m_p) be the Seifert surgery obtained from $(T_{2n-1,n}, n(2n-1) - 1)$ after p -twist along c' . Then (K_p, m_p) ($p \in \mathbb{Z}$) are Berge's lens surgeries on Type IV knots. In [7, Section 4] it is shown that each lens space $K_p(m_p)$ has a Seifert fibration \mathcal{F} over S^2 such that \mathcal{F} has two exceptional fibers and c' (the image of c' after twisting) is a regular fiber of \mathcal{F} . Since $\text{lk}(c', T_{2n-1,n}) = 2n+1 \notin \{1, n, 2n-1\}$, the seiferter c' is not a basic seiferter for $T_{2n-1,n}$. Then the argument in the proof of Proposition 5.4 shows that c' is a hyperbolic seiferter for the lens surgery $(T_{2n-1,n}, n(2n-1) - 1)$, and is not $(n(2n-1) - 1)$ -equivalent to a basic seiferter or a regular fiber of $S^3 - N(T_{2n-1,n})$. \square (Proposition 5.5)

Remark 5.6. The lens surgery $(T_{2n+1,n}, n(2n+1) - 1)$ ($n \geq 3$) has, other than c in Figure 5.2(2), a hyperbolic seiferter which is not $(n(2n+1) - 1)$ -equivalent to a basic seiferter or a regular fiber of $S^3 - N(T_{2n+1,n})$. Let us put $m = n+1$, where $n \geq 2$; then the lens surgery $(T_{-2n-3, n+1}, (-2n-3)(n+1) + 1)$ in the proof of Proposition 5.5 becomes $(T_{-2m-1, m}, m(-2m-1) + 1)$, and $\text{lk}(c', T_{-2m-1, m}) = 2m-1$, where c' is as in Figure 5.4(1). Let $T_{2m+1, m} \cup c'^*$ be the mirror image of the link $T_{-2m-1, m} \cup c'$. Writing n for m (≥ 3), we have the hyperbolic seiferter c'^* for $(T_{2n+1, n}, n(2n+1) - 1)$ which is not $(n(2n+1) - 1)$ -equivalent to a basic seiferter or a regular fiber of $S^3 - N(T_{2n+1, n})$. Since $|\text{lk}(c'^*, T_{2n+1, n})| = 2n-1$ is not equal to $|\text{lk}(c, T_{2n+1, n})| = 2n+2$, the seiferter c'^* is distinct from c .

6. BAND SUMS AND SEIFERTERS

For a 2-component link $k_1 \cup k_2$, we call a band b connecting k_1 and k_2 a *trivializing band* if the band sum $k_1 \natural_b k_2$ is a trivial knot in S^3 . Theorem 6.1 below determines when we have a trivializing band connecting a torus knot $T_{p,q}$ and its basic seiferters s_p, s_q, c_μ .

Theorem 6.1. *Let $T_{p,q}$ be a nontrivial torus knot with $|p| > q \geq 2$. Then the following hold.*

- (1) *There exists a trivializing band connecting s_q and $T_{p,q}$ if and only if $q = 2$.*
- (2) *There exists a trivializing band connecting s_p and $T_{p,q}$ if and only if $(p, q) = (\pm 3, 2)$.*
- (3) *There exists a trivializing band connecting c_μ and $T_{p,q}$ if and only if $(p, q) = (\pm 3, 2)$.*

Proof of Theorem 6.1. The band sum of $T_{p,2}$ and s_2 described in the first figure of Figure 6.1 is a trivial knot in S^3 . Moreover, if $p = 3$, the band sums of $T_{3,2}$ and basic seiferters s_3 and c_μ described in the second and the third figures of Figure 6.1 are both trivial knots. This fact proves the if parts of Theorem 6.1.

The only if part of assertion (3) is proved in [18]; it is further shown that if a band sum of c_μ and $T_{3,2}$ is a trivial knot, then the band is isotopic to b_μ in Figure 6.1. Thus it is enough to prove the only if parts of (1), (2). The proof is done by relating the band sums to basic seiferters for the degenerate Seifert surgery $(T_{p,q}, pq)$.

(1) Let b_q be a band connecting s_q and $T_{p,q}$, and write $k_q = s_q \natural_{b_q} T_{p,q}$. Take a tubular neighborhood of $T_{p,q}$ so that $N(T_{p,q}) \cap s_q = \emptyset$, and $\partial N(T_{p,q}) \cap b_q$ is an arc. Let α_{pq} be a simple closed curve on $\partial N(T_{p,q})$ with slope pq such that $\alpha_{pq} \cap b_q = \partial N(T_{p,q}) \cap b_q$. Then, $b'_q = b_q - \text{int}N(T_{p,q})$ is a band connecting α_{pq} and s_q (Figure 6.2). Let c be a knot in $S^3 - N(T_{p,q})$ which is obtained from the

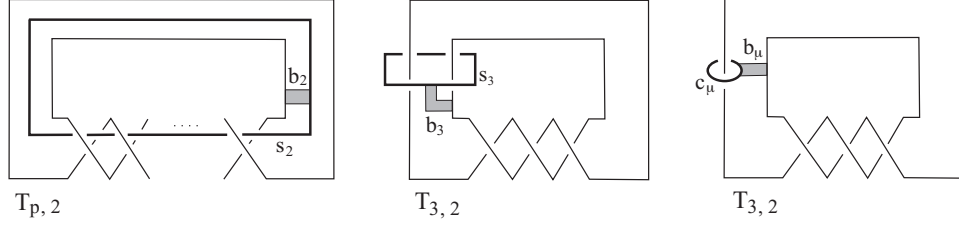

FIGURE 6.1. Band sums $s_2 \natural_{b_2} T_{p,2}$, $s_3 \natural_{b_3} T_{3,2}$, and $c_\mu \natural_{b_\mu} T_{3,2}$ are trivial knots.

band sum $s_q \natural_{b'_q} \alpha_{pq}$ by pushing away from $\partial N(T_{p,q})$; c is obtained from the basic seiferter s_q by a single pq -move using the band b'_q . Note that c is isotopic to k_q in S^3 .

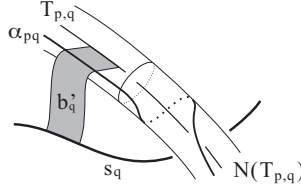

FIGURE 6.2. Band sum of s_q and $T_{p,q}$, and band sum of s_q and α_{pq}

Now suppose that the band sum k_q is a trivial knot in S^3 . Then, c is a seiferter for $(T_{p,q}, pq)$; moreover, since c is isotopic in $T_{p,q}(pq)$ to the basic seiferter s_q , c is a non-degenerate exceptional fiber of index q in $T_{p,q}(pq)$. Let V be the solid torus $S^3 - \text{int}N(c)$. We prove the claim below on the position of $T_{p,q}$ in V .

Lemma 6.2. *The position of $T_{p,q}$ in V is one of the following.*

- (i) $T_{p,q}$ is a (q, p) cable of V .
- (ii) $T_{p,q}$ is a (q, p) cable of a $(1, s)$ cable of V for some integer s such that $|s| \geq 2$ and $q = sp \pm 1$.

Proof of Lemma 6.2. Since c is a non-degenerate exceptional fiber in $T_{p,q}(pq) \cong L(p, q) \natural L(q, p)$, we have four possibilities (Corollary 3.21(2) and Theorem 3.19(2)(iii) in [8]).

- (i) $T_{p,q}$ is a (q, p) cable of V .
- (i') $T_{p,q}$ is a (p, q) cable of V .
- (ii) $T_{p,q}$ is a (q, p) cable of a $(1, s)$ cable of V for some integer s such that $|s| \geq 2$ and $q = sp \pm 1$.
- (ii') $T_{p,q}$ is a (p, q) cable of a $(1, s)$ cable of V for some integer s such that $|s| \geq 2$ and $p = sq \pm 1$.

Since c is isotopic to s_q in $T_{p,q}(pq)$, we see $V(T_{p,q}; pq) = T_{p,q}(pq) - \text{int}N(c) \cong T_{p,q}(pq) - \text{int}N(s_q)$. This manifold is homeomorphic to $S^1 \times D^2 \natural L(p, q)$ because $T_{p,q}$ is the (q, p) cable of the solid torus $S^3 - \text{int}N(s_q)$. On the other hand, in cases (i') and (ii'), $V(T_{p,q}; pq) \cong S^1 \times D^2 \natural L(q, p)$. Thus cases (i') and (ii') do not occur. \square (Lemma 6.2)

In case (i) in Lemma 6.2, $|\text{lk}(c, T_{p,q})| = p$. On the other hand, since c is obtained from s_q by a single pq -move, we have $\text{lk}(c, T_{p,q}) = \text{lk}(s_q, T_{p,q}) + \varepsilon pq$, where $c, s_q, T_{p,q}$ are oriented adequately and $\varepsilon \in \{\pm 1\}$ ([8, Proposition 2.22(1)]). Hence, $|p + \varepsilon pq| = |p|$. It follows that $q = 0, \pm 2$. Since $q \geq 2$, we obtain $q = 2$ as claimed in Theorem 6.1.

Now let us consider case (ii) in Lemma 6.2 where $T_{p,q}$ is a (q, p) cable of a $(1, s)$ cable of V ; then $\text{lk}(c, T_{p,q}) = \pm ps$. It follows that $|p + \varepsilon pq| = |ps|$ and thus $|1 + \varepsilon q| = |s|$. Combining this equality with $|ps - q| = 1$ in case (ii), we obtain the inequalities below.

$$|ps| - 1 \leq |ps\varepsilon + 1| \leq |1 + \varepsilon q| + |ps\varepsilon - \varepsilon q| = |s| + 1$$

It follows $|ps| \leq |s| + 2$. Since $|s| \geq 2$, $|p| \leq 1 + \frac{2}{|s|} \leq 2$. This contradicts the assumption $|p| > q \geq 2$. Assertion (1) is thus proved.

(2) Starting with a band sum $k_p = s_p \natural_{b_p} T_{p,q}$, we follow the argument in (1) with p and q exchanged. Then, we obtain the same statement as in cases (i) and (ii) in Lemma 6.2 with p and q exchanged. The modified case (i) then leads to $p = 0, \pm 2$. However, this is impossible because $|p| > q \geq 2$. The modified case (ii) leads to the inequality $|qs| \leq |s| + 2$, so that $q \leq 1 + \frac{2}{|s|}$. Then, using the fact $|p| > q \geq 2$ and $|s| \geq 2$, we see that $q = 2$ and $|s| = 2$. Since $|1 + \varepsilon q| = |s|$ holds in case (ii), $|1 + \varepsilon p| = |s|$ holds in the modified case (ii). We then obtain $p = \pm 3$ and $q = 2$, as desired in assertion (2). \square (Theorem 6.1)

Theorem 6.1 implies the following results on seiferters obtained by m -moves.

Theorem 6.3. *Let $(T_{p,q}, m)$ be a Seifert surgery on a torus knot $T_{p,q}$ with $|p| > q > 2$. Then, there is no seiferters for $(T_{p,q}, m)$ which is obtained from a basic seiferters by an m -move.*

Proof of Theorem 6.3. Theorem 6.1 shows that all band sums of $T_{p,q}$ ($|p| > q > 2$) and basic seiferters for $T_{p,q}$ are nontrivial knots in S^3 . Let α_m be a simple closed curve in $\partial N(T_{p,q})$ with slope m . It follows that all band sums of α_m and basic seiferters for $T_{p,q}$ are nontrivial knots because α_m is isotopic in $N(T_{p,q})$ to the core $T_{p,q}$. Thus an arbitrary knot obtained from each basic seiferters for $T_{p,q}$ by an m -move is not a seiferters. \square (Theorem 6.3)

Theorem 6.4. *Let $(T_{p,q}, m)$ be a Seifert surgery on a torus knot $T_{p,q}$ with $|p| > q \geq 2$. Suppose that c is a seiferters for $(T_{p,q}, m)$ which is obtained from a regular fiber of $S^3 - N(T_{p,q})$ by an m -move. Then, c is a $(1, m - pq)$ cable of a meridian of $T_{p,q}$, and thus a non-hyperbolic seiferters for $(T_{p,q}, m)$.*

Proof of Theorem 6.4. Suppose that c is a seiferters for $(T_{p,q}, m)$ which is obtained from a regular fiber t in $S^3 - N(T_{p,q})$ by an m -move using a band $b(\subset S^3 - \text{int}N(T_{p,q}))$; c is a knot in $S^3 - N(T_{p,q})$ obtained by pushing the band sum $t \natural_b \alpha_m$ away from $\partial N(T_{p,q})$, where α_m is a simple closed curve on $\partial N(T_{p,q})$ with slope m . Our purpose is to show that c is a $(1, m - pq)$ cable of a meridian of $T_{p,q}$.

In the Seifert fibration of $S^3 - \text{int}N(T_{p,q})$, take a regular fiber α_{pq} on $\partial N(T_{p,q})$, which represents the slope pq . We may assume that there is a small annulus M on $\partial N(T_{p,q})$ such that the core curve of M is a meridian of $T_{p,q}$, and that α_m and α_{pq} restrict to the same essential arc in the annulus $\partial N(T_{p,q}) - \text{int}M$.

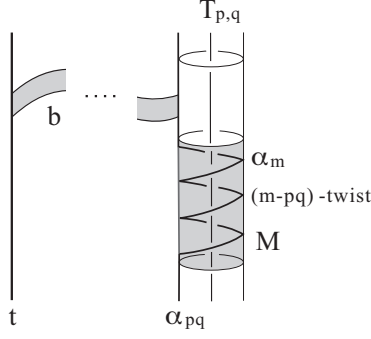
 FIGURE 6.3. A band sum of α_m and a regular fiber t

Now isotope b so that $b \cap \alpha_m$ is contained in $\partial N(T_{p,q}) - \text{int}M$, and take the band sum $t \natural_b \alpha_{pq}$. Note that $t \natural_b \alpha_m$ and $t \natural_b \alpha_{pq}$ coincide outside of M and are isotopic in S^3 . Let c_{pq} be a knot obtained by pushing $t \natural_b \alpha_{pq}$ away from $\partial N(T_{p,q})$. Since c is a trivial knot in S^3 , c_{pq} is also trivial in S^3 . Since c_{pq} is isotopic in $T_{p,q}(pq)$ to the regular fiber t , c_{pq} is a regular fiber in a degenerate Seifert fibration of $T_{p,q}(pq)$. On the other hand, Theorem 3.21(1) in [8] shows that no seiferter for the degenerate Seifert surgery $(T_{p,q}, pq)$ is a regular fiber. Hence, c_{pq} is not a seiferter. It follows that c_{pq} is an irrelevant seiferter, and so bounds a disk in $S^3 - T_{p,q}$ (Remark 1.3).

On the position of the band b the following holds.

Lemma 6.5. *There exists an annulus S in $S^3 - \text{int}N(T_{p,q})$ such that $\partial S = t \cup \alpha_{pq}$ and $b \subset S$.*

Using the annulus S obtained by this lemma, we complete the proof of Theorem 6.4. By an isotopy we may assume further that $S \cap N(T_{p,q}) = \alpha_{pq}$. Since S contains the band b , $t \natural_b \alpha_m$ is the union of the two arcs $\alpha_m \cap M$ and $\tau = \partial(\overline{S - b}) - \text{int}M$; τ is isotopic in S with its end points fixed to the arc τ' in Figure 6.4. Note that $(\alpha_m \cap M) \cup \tau'$ is a $(1, m - pq)$ cable of a meridian of $T_{p,q}$. This shows that $t \natural_b \alpha_m$ and thus c is isotopic in $S^3 - T_{p,q}$ to the $(1, m - pq)$ cable of a meridian of $T_{p,q}$, as claimed. \square (Theorem 6.4)

Proof of Lemma 6.5. Let A be an annulus in $S^3 - \text{int}N(T_{p,q})$ with $\partial A = t \cup \alpha_{pq}$. (Since t and α_{pq} are regular fibers in the Seifert fibration of $S^3 - \text{int}N(T_{p,q})$, such an annulus is obtained as a union of regular fibers.) Choose orientations of t and α_{pq} which are consistent in $t \natural_b \alpha_{pq}$. We consider two cases according as t and α_{pq} are homologous in A or not. First suppose that t and α_{pq} are homologous in A . Then $\text{lk}(c_{pq}, T_{p,q}) = \text{lk}(t, T_{p,q}) + \text{lk}(\alpha_{pq}, T_{p,q}) = 2pq \neq 0$. However, this contradicts the fact that c_{pq} bounds a disk in $S^3 - T_{p,q}$. Now assume that t and α_{pq} are not homologous in A . Then the (adequately oriented) annulus A in $S^3 - \text{int}N(T_{p,q})$ is a Seifert surface for the oriented link $t \cup \alpha_{pq}$. Here, a Seifert surface F for an oriented link L is a compact oriented surface such that no component of F is closed and $\partial F = L$. We define $\chi(L)$ to be the maximal Euler characteristic of all Seifert surfaces for L . Since $t \natural_b \alpha_{pq}$ is a trivial knot in S^3 , we see $\chi(t \natural_b \alpha_{pq}) = 1$. Since the oriented link $t \cup \alpha_{pq}$ is non-splittable, it follows $\chi(t \cup \alpha_{pq}) = \chi(A) = 0$. Then, the minor revision of [16, Theorem 1.6] below shows that the oriented link $t \cup \alpha_{pq}$ cobounds an annulus S containing the band b , as claimed. By an isotopy we may

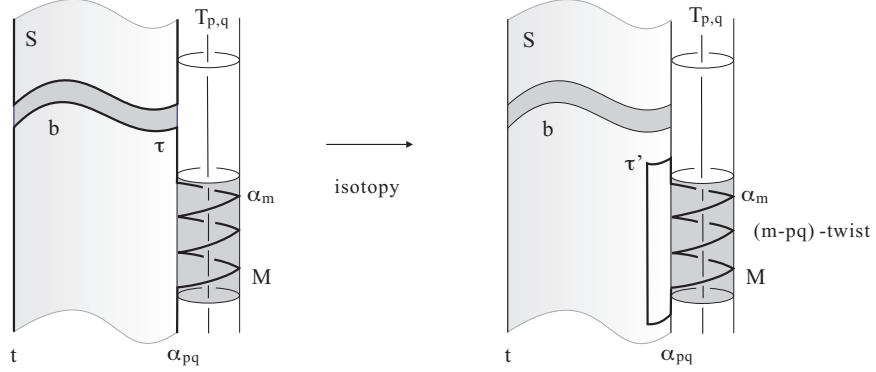
FIGURE 6.4. τ is isotopic to τ' .

assume that $S \subset S^3 - \text{int}N(T_{p,q})$.

□(Lemma 6.5)

Theorem 6.6 (a minor revision of Theorem 1.6 in [16]). *Let L be an oriented link, and b a band connecting (possibly the same) components of L such that L and b induce opposite orientations to their intersection $L \cap b$. Denote the self band sum of L using b by L_b , an oriented link. Then, $\chi(L) \leq \chi(L_b) - 1$ if and only if L has a Seifert surface S such that $\chi(S) = \chi(L)$ and $b \subset S$.*

Proof of Theorem 6.6. For a Seifert surface $S(\subset M = S^3 - \text{int}N(L))$ for L , consider the three conditions below.

- (1) S is taut in $(M, \partial M)$, i.e. S is incompressible and minimizes the Thurston norm of $[S, \partial S] \in H_2(M, N)$, where N is a tubular neighborhood of ∂S in ∂M .
- (2) $\chi(L) = \chi(S)$
- (3) S is a minimal genus Seifert surface for L , i.e. the sum of the genera of the components of S is minimal.

Theorem 1.6 in [16] states that $\chi(L) \leq \chi(L_b) - 1$ if and only if L has a minimal genus Seifert surface S such that $b \subset S$. In the proof the authors assume that (3) \Rightarrow (2) and (1) \Leftrightarrow (3) are true. However, these are not true; if a minimal genus Seifert surface S for a link L is disconnected, then by tubing two components of S , we obtain a minimal genus, compressible Seifert surface S' with $\chi(S') < \chi(L)$. On the other hand, (1) \Leftrightarrow (2) holds by [27, Lemma 1.2]. By replacing the word “minimal genus” in the proof of [16, Theorem 1.6] with “taut”, we obtain a proof of Theorem 6.6. □(Theorem 6.6)

Remark 6.7. Among connected Seifert surfaces for a given link, a Seifert surface S has minimal genus if and only if $\chi(S)$ is maximal. Thus, [16, Theorem 1.6] holds for links which have only connected Seifert surfaces. Theorem 6.1(3) is, in fact, proved in [18] by using Theorem 1.6 in [16]. However, in the proof Theorem 1.6 in [16] is applied only to links with only connected Seifert surfaces.

Corollary 6.8. *Let c be a hyperbolic seiferter for $(T_{p,q}, m)$, where $|p| > q > 2$ and $m \neq pq, pq \pm 1$. Then,*

- (1) c is m -equivalent to a basic seiferter for $T_{p,q}$ (resp. a regular fiber of $S^3 - N(T_{p,q})$) if c is an exceptional fiber (resp. a regular fiber) in some Seifert fibration of $T_{p,q}(m)$.
- (2) c cannot be obtained from a basic seiferter or a regular fiber of $S^3 - N(T_{p,q})$ by a single m -move.

Proof of Corollary 6.8. It follows from the assumption $|p| > q > 2$ and $m \neq pq$, $pq \pm 1$ that $T_{p,q}(m)$ is not a connected sum of lens spaces, a lens space, or a prism manifold. Hence, (1) follows from Proposition 2.2, and (2) follows from Theorems 6.3 and 6.4. \square (Corollary 6.8)

REFERENCES

1. K. Asano; Homeomorphisms of prism manifolds, *Yokohama Math. J.* **26** (1978), 19–25.
2. R. Benedetti and C. Petronio; Lectures on hyperbolic geometry, Universitext, Springer-Verlag, 1992.
3. J. Berge; Some knots with surgeries yielding lens spaces, Unpublished manuscript.
4. M. Boileau and J. Porti; Geometrization of 3-orbifolds of cyclic type, *Astérisque* **272** (2001), 208pp.
5. F. Bonahon and J.-P. Otal; Scindements de Heegaard des espaces lenticulaires, *Ann. Sci. Ecole Norm. Sup.* **16** (1983), 451–466.
6. A. Deruelle, M. Eudave-Muñoz, K. Miyazaki and K. Motegi; Networking Seifert Surgeries on Knots IV: Seiferters and branched coverings, *Contemp. Math. Amer. Math. Soc.* **597** (2013), 235–262.
7. A. Deruelle, K. Miyazaki and K. Motegi; Networking Seifert Surgeries on Knots II: Berge’s lens surgeries, *Topology Appl.* **156** (2009), 1083–1113.
8. A. Deruelle, K. Miyazaki and K. Motegi; Networking Seifert Surgeries on Knots, *Mem. Amer. Math. Soc.* **217** (2012), no. 1021, viii+130.
9. A. Deruelle, K. Miyazaki and K. Motegi; Neighbors of Seifert surgeries on a trefoil knot in the Seifert Surgery Network, preprint.
10. M. Eudave-Muñoz; Non-hyperbolic manifolds obtained by Dehn surgery on a hyperbolic knot, In: *Studies in Advanced Mathematics vol. 2, part 1*, (ed. W. Kazez), 1997, Amer. Math. Soc. and International Press, pp. 35–61.
11. M. Eudave-Muñoz; On hyperbolic knots with Seifert fibered Dehn surgeries, *Topology Appl.* **121** (2002), 119–141.
12. R. Fintushel and R. J. Stern; Constructing lens spaces by surgery on knots, *Math. Z.* **175** (1980), 33–51.
13. C. McA. Gordon and Y.-Q. Wu; Annular Dehn fillings, *Comment. Math. Helv.* **75** (2000), 430–456.
14. J. E. Greene; L -space surgeries, genus bound, and the cabling conjecture, 2012, preprint.
15. A. E. Hatcher; Notes on basic 3-manifold topology, freely available at <http://www.math.cornell.edu/hatcher>.
16. M. Hirasawa and K. Shimokawa; Dehn surgeries on strongly invertible knots which yield lens spaces, *Proc. Amer. Math. Soc.* **128** (2000), 3445–3451.
17. C. Hodgson and J. H. Rubinstein; Involutions and isotopies of lens spaces, *Knot theory and manifolds (Vancouver, B.C., 1983)*, *Lect. Notes in Math.*, vol. 1144, Springer-Verlag, 1985, pp.60–96.
18. K. Ishihara and K. Motegi; Band sum operations yielding trivial knots, *Bol. Soc. Mat. Mexicana* **15** (2009), 103–108.
19. W. Jaco; Lectures on three manifold topology, *CBMS Regional Conference Series in Math.*, vol. 43, Amer. Math. Soc., 1980.
20. B. Jiang and S. Wang and Y.-Q. Wu; Homeomorphisms of 3-manifolds and the realization of Nielsen number, *Comm. Anal. Geom.* **9** (2001), 825–877.
21. K. Miyazaki and K. Motegi; Seifert fibred manifolds and Dehn surgery, *Topology* **36** (1997), 579–603.

22. W. D. Neumann and F. Raymond; Seifert manifolds, plumbing, μ -invariant and orientation reversing maps, Algebraic and geometric topology (Proc. Sympos., Univ. California, Santa Barbara, Calif., 1977), Lect. Notes in Math., vol. 664, Springer-Verlag, 1978, pp.161–196.
23. U. Oertel; Closed incompressible surfaces in complements of star links, Pacific J. Math. **111** (1984), 209–230.
24. P. Orlik; Seifert manifolds, Lect. Notes in Math., vol. 291, Springer-Verlag, 1972.
25. C. Petronio and J. Porti; Negatively oriented ideal triangulations and a proof of Thurston’s hyperbolic Dehn filling theorem, Expo. Math. **18** (2000), 1–35.
26. J.H. Rubinstein; On 3-manifolds that have finite fundamental groups and contain Klein bottles, Trans. Amer. Math. Soc. **251** 1979, 129–137.
27. M. Scharlemann and A. Thompson; Link genus and the Conway moves, Comment. Math. Helv. **64** (1989), 527–535.
28. W. P. Thurston; The geometry and topology of 3-manifolds, Lecture notes, Princeton University, 1979.
29. W. P. Thurston; Three dimensional manifolds, Kleinian groups and hyperbolic geometry, Bull. Amer. Math. Soc. **6** (1982), 357–381.

Institute of Natural Sciences
Nihon University
3-25-40 Sakurajosui, Setagaya-ku
Tokyo 156-8550
Japan
e-mail: aderuelle@math.chs.nihon-u.ac.jp

Faculty of Engineering
Tokyo Denki University
5 Senju-Asahi-cho, Adachi-ku
Tokyo 120-8551
Japan
e-mail: miyazaki@cck.dendai.ac.jp

Department of Mathematics
Nihon University
3-25-40 Sakurajosui, Setagaya-ku
Tokyo 156-8550
Japan
e-mail: motegi@math.chs.nihon-u.ac.jp