

# THE NOVIKOV-VESELOV EQUATION: THEORY AND COMPUTATION

R. CROKE, J. L. MUELLER, M. MUSIC, P. PERRY, S. SILTANEN, AND A. STAHEL

ABSTRACT. We review recent progress in theory and computation for the Novikov-Veselov (NV) equation with potentials decaying at infinity, focusing mainly on the zero-energy case. The inverse scattering method for the zero-energy NV equation is presented in the context of Manakov triples, treating initial data of conductivity type rigorously. Special closed-form solutions are presented, including multisolitons, ring solitons, and breathers. The computational inverse scattering method is used to study zero-energy exceptional points and the relationship between supercritical, critical, and subcritical potentials.

## CONTENTS

1. Introduction	2
2. Background for the Zero-Energy NV Equation	6
2.1. Dispersion, group velocity and phase velocity	7
2.2. Symmetries and Scaling	8
2.3. Conservation Laws for the NV equation	9
3. Inverse Scattering via Manakov Triples	12
3.1. The Direct Scattering Map	13
3.2. Computation of Scattering Transforms	14
3.3. The Inverse Scattering Map	15
3.4. Computation of Inverse Scattering Transforms	17
3.5. Time Evolution of NCGO Solutions	17
3.6. Solution by Inverse Scattering	19
4. Special Solutions	22
4.1. KdV-type Solutions	23
4.2. Closed-form Solutions	29
4.3. Scattering transform of the ring soliton at time zero	33
5. Zero-energy exceptional points	34
6. Open Problems	38
6.1. Applications of the NV Equation	38
6.2. Exceptional Sets and Large-Time Behavior for the NV Equation	38
Appendix A. Some Useful Analysis	40
A.1. Faddeev's Green's Function at Zero Energy	40
A.2. The Cauchy Transform and the Beurling Operator	41
References	44

---

*Date:* December 17, 2013.

Michael Music supported in part by NSF Grant DMS-1208778.

Peter Perry supported in part by NSF Grant DMS-1208778.

Samuli Siltanen supported in part by the Finnish Centre of Excellence in Inverse Problems Research 2012-2017 (Academy of Finland CoE-project 250215).

## 1. INTRODUCTION

The Novikov-Veselov (NV) equation is the completely integrable, nonlinear dispersive equation

$$(1.1) \quad \begin{aligned} q_t &= 4 \operatorname{Re} (4\partial^3 q + \partial(qw) - E\partial w) \\ \bar{\partial} w &= -3\partial q \end{aligned}$$

Here  $E$  is a real parameter, the unknown function  $q$  is a real-valued function of two space variables and time, and the operators  $\partial$  and  $\bar{\partial}$  are given by

$$\begin{aligned} \partial &= \frac{1}{2} (\partial_{x_1} - i\partial_{x_2}) \\ \bar{\partial} &= \frac{1}{2} (\partial_{x_1} + i\partial_{x_2}). \end{aligned}$$

At zero energy ( $E = 0$ ) it can also be written (after trivial rescalings) as

$$(1.2) \quad q_t = -\partial_z^3 q - \bar{\partial}^3 q + 3\partial_z(q\nu) + 3\bar{\partial}_z(q\bar{\nu}), \quad \text{where } \bar{\partial}_z \nu = \partial_z q.$$

The NV equation (1.2) generalizes the celebrated Korteweg-de Vries (KdV) equation

$$q_t = -6qq_x - q_{xxx}$$

in the sense that, if  $q(x_1, t)$  solves KdV and  $\nu_{x_1}(x_1, t) = -3q_{x_1}(x_1, t)$ , then  $q(x_1, t)$  solves NV.

The NV equation was introduced by Novikov and Veselov in [64, 92] as one of a hierarchy of completely integrable equations that generate isospectral flows for the two-dimensional Schrödinger operator at fixed energy  $E$ . Indeed, the Novikov-Veselov equation (1.1) admits the Manakov Triple Representation [49]

$$(1.3) \quad \dot{L} = [A, L] - BL$$

where

$$\begin{aligned} L &= -\Delta + q - E, \\ A &= 8 \left( \partial^3 + \bar{\partial}^3 \right) + 2 (w\partial + \bar{w}\bar{\partial}), \\ B &= -2 (\partial w + \bar{\partial}\bar{w}). \end{aligned}$$

Here  $B$  is the operator of multiplication by the function  $2(\partial w + \bar{\partial}\bar{w})$ . That is, a pair  $(q, w)$  solves the NV equation if and only if the operator equation (1.3) holds.

The Manakov triple representation implies that the NV equation is, formally at least, a completely integrable equation. Thus one expects that, for a suitable notion of “scattering data for  $L$  at fixed energy  $E$ ,” the associated scattering transform will linearize the flow.

For nonzero energy  $E$  and potentials  $q$  which vanish at infinity, the scattering transform and inverse scattering method was developed by P. Grinevich, R. G. Novikov, and S.-P. Novikov (see Kazeykina’s thesis [38] for an excellent survey and see [25, 26, 29, 30] for the original papers). Roughly and informally, there is a scattering transform  $\mathcal{T}$  which maps the potential  $q$  to scattering data that obey a linear equation if  $q$  obeys the NV equation, and an inverse scattering transform  $\mathcal{Q}$  which inverts  $\mathcal{T}$ , so that the function

$$(1.4) \quad q(x, \tau) = \mathcal{Q} \left[ e^{i\tau(\diamond^3 + (\diamond)^3)} \mathcal{T}(q_0) \right] (x)$$

solves the NV equation with initial data  $q_0$ . The inverse scattering method may be visualized by the following commutative diagram:

$$(1.5) \quad \begin{array}{ccc} \mathbf{t}_0(k) & \xrightarrow{\exp(i\tau(k^3 + \bar{k}^3))(\cdot)} & \mathbf{t}_\tau(k) \\ \mathcal{T} \uparrow & & \downarrow \mathcal{Q} \\ q_0(z) & \xrightarrow{\text{Novikov-Veselov evolution}} & q_\tau^{\text{NV}}(z), \end{array}$$

where  $\mathcal{T}$  and  $\mathcal{Q}$  stand for the direct and inverse nonlinear Fourier transform, respectively, and the function  $\mathbf{t}_\tau : \mathbb{C} \rightarrow \mathbb{C}$  is called the *scattering transform*. In the case  $E = 0$ , the inverse scattering method was studied by Boiti et. al. [9], Tsai [88], Nachman [59], Lassas-Mueller-Siltanen [45], Lassas-Mueller-Siltanen-Stahel [46, 47], Music [55], Music-Perry [56], and Perry [67].

Recently, Angelopoulos [1] used Bourgain's Fourier restriction method (see [10, 11] and the lectures of Tao [87]) together with subtle bilinear estimates on the nonlinearity to prove that the Novikov-Veselov equation at  $E = 0$  is locally well-posed in the Sobolev spaces  $H^s(\mathbb{R}^2)$  for  $s > 1/2$ . Here  $H^s(\mathbb{R}^2)$  is the space of square integrable functions  $u$  on  $\mathbb{R}^2$  whose Fourier transforms  $\hat{u}$  obey

$$\|u\|_{H^s}^2 := \int (1 + |\xi|)^{2s} |\hat{u}(\xi)|^2 d\xi < \infty.$$

Angelopoulos' results place the local well-posedness theory for this equation on a sound footing. The inverse scattering method is expected to elucidate—for a more restrictive but nonetheless rich class of initial data—the *global* behavior of the solutions, including global existence in time, blow-up, and asymptotics.

The case  $E = 0$  is intimately connected with the following trichotomy of behaviors for the two-dimensional Schrödinger operator  $L$  at zero energy.

**Definition 1.1.** *The operator  $L = -\Delta + q$  is said to be:*

- (i) *subcritical if the operator  $L$  has a positive Green's function and the equation  $L\psi = 0$  has a strictly positive distributional solution,*
- (ii) *critical if  $L\psi = 0$  has a bounded strictly positive solution but no positive Green's function, and*
- (iii) *supercritical otherwise.*

This distinction first arose in the study of Schrödinger semigroups, i.e., the operators  $e^{-tL}$  where  $L = -\Delta + q$ . Simon [77, 78] (see also Simon's comprehensive review [79] on Schrödinger semigroups) studied  $L^p$ -mapping properties of  $e^{-tL}$  and asymptotics of  $\|e^{-tL}\|_{p,p}$ , where  $\|\cdot\|_{p,p}$  denotes the operator norm as maps from  $L^p$  to itself. Simon shows that

$$\alpha_p(q) = \lim_{t \rightarrow \infty} t^{-1} \ln \|e^{-tL}\|_{p,p}$$

is independent of  $p \in [1, \infty]$ . In the language of Schrödinger semigroups, a potential  $q$  is:

- (i) subcritical if  $\alpha_\infty((1 + \varepsilon)q) = 0$  for some  $\varepsilon > 0$ ,
- (ii) critical if  $\alpha_\infty(q) = 0$  but  $\alpha_\infty((1 + \varepsilon)q) > 0$  for all  $\varepsilon > 0$ , and

(iii) supercritical if  $\alpha_\infty(q) > 0$ .

Clearly, a sufficient condition for  $q$  to be supercritical is that  $L$  have a negative eigenvalue.

In [53], Murata showed that, for two-dimensional Schrödinger operators with potentials  $q$  with  $q(x)$  uniformly Hölder continuous and  $q(x) = \mathcal{O}(|x|^{-4-\epsilon})$  for some  $\epsilon > 0$ , the trichotomy of behaviors for Schrödinger semigroups is equivalent to Definition 1.1. Murata further studied the existence and properties of positive solutions of the Schrödinger equation in [53], and showed that for his class of potentials, the trichotomy could be characterized as follows: a potential is

(i) subcritical if and only if  $L\psi = 0$  has a strictly positive solution of the form  $c \log(|x|) + d + \mathcal{O}(|x|^{-1})$  with  $c \neq 0$ ,

(ii) critical if  $L\psi = 0$  if and only if  $L\psi = 0$  has a strictly positive bounded solution, and

(iii) supercritical if  $L\psi = 0$  has no strictly positive solutions.

Extending Murata's result, Gesztesy and Zhao [22] used Brownian motion techniques to prove the following optimal result for critical potentials. Suppose that  $q$  is a real-valued measurable function with

$$\lim_{\alpha \downarrow 0} \left\{ \sup_{x \in \mathbb{R}^2} \int_{|x-y| \leq \alpha} \ln(|x-y|^{-1}) |q(y)| dy \right\} = 0$$

and

$$\int_{|y| \geq 1} \ln(|y|) |q(y)| dy < \infty.$$

Then  $q$  is critical if and only if there exists a positive, bounded distributional solution  $\psi$  of  $H\psi = 0$ . These two conditions mean essentially that

$$q(x) = \mathcal{O}\left(|x|^{-2} (\ln(|x|))^{-2-\epsilon}\right)$$

for some  $\epsilon > 0$ . We refer the reader to [22] for further references and history.

As we will see, corresponding to the trichotomy in Definition 1.1, the scattering transform of  $q$  is either mildly singular, nonsingular, or highly singular. This is illustrated dramatically in the examples studied by Music, Perry, and Siltanen [57], described in Section 5 below. One would expect the singularities of the scattering transform to be mirrored in the behavior of solutions to the NV equation. We will discuss the following conjecture, and some partial results toward its resolution, in the last section of this paper:

**Conjecture 1.2.** *The Novikov-Veselov equation (1.1) has a global solution for critical and subcritical initial data, but its solution may blow up in finite time for supercritical initial data.*

To elucidate this conjecture, it is helpful to recall how the scattering transform for Schrödinger's equation is connected with Calderón's inverse conductivity problem [14] (see [3] for the solution to Calderón's problem for  $L^\infty$  conductivities and for references to the extensive literature on this problem). Critical potentials are also known in the literature as "potentials of conductivity type" because of their connection with the Calderón inverse conductivity problem: suppose one wishes to determine the conductivity  $\sigma$  of a bounded plane region  $\Omega$  by boundary measurements. The potential  $u$  of  $\Omega$  with voltage  $f$  on the boundary is determined by the

equation

$$\begin{aligned}\nabla \cdot (\sigma \nabla u) &= 0 \\ u|_{\partial\Omega} &= f\end{aligned}$$

Calderón's problem is to reconstruct  $\sigma$  from knowledge of the *Dirichlet-to-Neumann* map, defined as follows. If  $\Omega$  has smooth boundary then the above boundary value problem has a unique solution  $u$  for given  $f \in H^{1/2}(\partial\Omega)$ , so that

$$\Lambda_\sigma f = \sigma \frac{\partial u}{\partial \nu} \Big|_{\partial\Omega}$$

is uniquely determined. The map  $\Lambda_\sigma : H^{1/2}(\partial\Omega) \rightarrow H^{-1/2}(\partial\Omega)$  is the *Dirichlet-to-Neumann map*.

This boundary value problem is equivalent, under the change of variables  $u = \sigma^{-1/2}\psi$ , to the Schrödinger problem

$$\Delta\psi - q\psi = 0$$

where  $q = \sigma^{-1/2}\Delta(\sigma^{1/2})$ . A potential of this form for strictly positive  $\sigma \in L^\infty$  (and some additional regularity) is called a *potential of conductivity type*. More precisely, the class of potentials originally studied by Nachman [59] is as follows. We denote by  $L_\rho^p(\mathbb{R}^2)$  the space of measurable functions with norm  $\|f\|_{L_\rho^p} = \|\langle x \rangle^\rho f\|_p$ .

**Definition 1.3.** *Let  $p \in (1, 2)$  and  $\rho > 1$ . A real-valued measurable function  $q \in L_\rho^p(\mathbb{R}^2)$  is a potential of conductivity type if there is a function  $\sigma \in L^\infty(\mathbb{R}^2)$  with  $\sigma(x) \geq c_0 > 0$  so that  $q = \sigma^{-1/2}\Delta(\sigma^{1/2})$  in the sense of distribution derivatives.*

A real-valued potential in  $L_\rho^p(\mathbb{R}^2)$  is of conductivity type if and only if it is critical: the bounded, positive solution to  $\Delta\psi - q\psi = 0$  is exactly  $\psi = \sigma^{1/2}$ .

As shown by Murata [53, 54], critical potentials are very unstable: if  $w \in C_0^\infty(\mathbb{C})$  is a nonnegative bump function and  $q_0$  is a critical potential, the potential  $q_\lambda = q_0 + \lambda w$  is supercritical for any  $\lambda > 0$ . This means that the set of critical potentials is nowhere dense in any reasonable function space! Music, Siltanen, and Perry [57] studied the behavior of the scattering transform for families of this type when  $q_0$  and  $w$  are both smooth, compactly supported, and radial. The corresponding scattering transforms are mildly singular for subcritical potentials, regular for critical potentials, and have circles of singularities for supercritical potentials.

The NV equation may be solved by inverse scattering for subcritical and critical potentials, but it is not yet clear how to construct a solution by inverse scattering for supercritical potentials.

In this article, we will focus primarily on the Novikov-Veselov equation at zero energy. For the Novikov-Veselov equation at nonzero energy, we refer the reader to the thesis of Kazeykina [38] and to the papers [36, 37, 39, 40, 41] for other recent work on qualitative properties of solutions and for further references to the literature. We will report on recent progress on both the theoretical and the numerical analysis of this equation, and pose a number of open problems. In section 2 we review the history of the inverse scattering method, the dispersion relation, symmetries and scaling properties, and conservation laws for the NV equation. In section 3, we give an exposition of the inverse scattering method for the NV equation at zero energy from the point of view of the Manakov triple representation, treating with full mathematical rigor the case of “smooth potentials of conductivity type” (see Definition 3.2). We discuss the numerical implementation of the maps  $\mathcal{T}$  and

$\mathcal{Q}$  in sections 3.2 and 3.3, respectively. In section 4, we discuss special closed-form solutions of the NV equation including ring solitons and breathers. In section 5, the computational inverse scattering method is used to study zero-energy exceptional points and the relationship between supercritical, critical, and subcritical potentials. Finally, in section 6, we discuss open problems. In an appendix, we collect some useful tools for the mathematical analysis of the direct and inverse scattering maps.

*Notation.* In what follows, we use the variable  $t$  to denote time except when discussing the solution of NV via the inverse scattering method. In this case,  $\tau$  denotes time in order to distinguish  $t$  from  $\mathbf{t}$ , the scattering transform. We denote the spatial variable by  $z = x + iy$ . Functions  $q(z)$ ,  $q(z, t)$ , etc., are functions of  $x$  and  $y$  but are generally *not* analytic in  $z$ .

## 2. BACKGROUND FOR THE ZERO-ENERGY NV EQUATION

First, we summarize the historical progress that led to the completion of the diagram (1.5) for the NV equation at zero energy. In 1987, Boiti, Leon, Manna and Pempinelli [9] studied the evolution under the assumption that  $q_0$  is such that the solution  $q_\tau^{\text{NV}}$  to (1.1) exists and does not have exceptional points and established that the scattering data evolves as  $\mathcal{T}(q_\tau^{\text{NV}}) = e^{i\tau(k^3 + \bar{k}^3)}\mathcal{T}(q_0)$ . In 1994, Tsai [88] considered a certain class of small and rapidly decaying initial data (which excludes conductivity-type potentials) and assumed that  $q_0$  has no exceptional points and that  $q_\tau$  is well-defined. Under such assumptions, he then showed that  $q_\tau$  is a solution of the Novikov-Veselov equation (1.1). In 1996, Nachman [59] established that initial data of conductivity type does not have exceptional points and the scattering data  $\mathcal{T}(q_0)$  is well-defined. Nachman's work paved the way for rigorous results: all studies about diagram (1.5) published before [59] were formal as they had to assume the absence of exceptional points without specifying acceptable initial data. In 2007, [45] established for smooth, compactly supported conductivity-type initial data with  $\sigma \equiv 1$  outside  $\text{supp}(q_0)$  that there is a well-defined continuous function  $q_\tau : \mathbb{R}^2 \rightarrow \mathbb{C}$  from the inverse scattering method satisfying the estimate  $|q_\tau(z)| \leq C(1 + |z|)^{-2}$  for all  $\tau > 0$ . In [46] it was shown that an initially radially-symmetric conductivity-type potential evolved under the ISM does not have exceptional points and is itself of conductivity-type. Note that in [57] the set of conductivity type potentials is shown to be unstable under  $C_0^\infty$  perturbations. In [47] evolutions computed from a numerical implementation of the inverse scattering method of rotationally symmetric, compactly supported conductivity type initial data are compared to evolutions of the NV equation computed from a semi-implicit finite-difference discretization of NV and are found to agree with high precision. This supported the integrability conjecture that was then established in [67] for a larger class of initial data using the inverse scattering map for the Davey-Stewartson equation and Bogdanov's Miura transform.

In Section 4 of this paper, we present several closed-form solutions of the NV equation. We briefly review earlier constructions of solutions for the NV equation without presenting an exhaustive list. Grinevich, Manakov and R. G. Novikov constructed soliton solutions using nonlocal Riemann problem techniques in [24, 25, 26, 27, 28] for nonzero energy and with small initial data. Also, solitons are constructed by Grinevich using rational potentials in [24] (see also the survey [25]), by Tagami using the Hirota method in [80], by Athorne and Nimmo using Moutard

transformation in [4], by Hu and Willox using a nonlinear superposition formula in [35], by Xia, Li and Zhang using hyperbola function method and Wu-elimination method in [94], by Ruan and Chen using separation of variables in [69, 70, 71, 96], and by J.-L. Zhang, Wang, Wang and Fang using the homogeneous balance principle and Bäcklund transformation in [35]. Lump solutions are constructed by Dubrovsky and Formusatik using the  $\bar{\partial}$ -dressing method in [18]. Dromion solutions are constructed by Ohta and Ünal using Pfaffians in [65, 89]. The Darboux transformation is used by Hu, Lou, Liu, Rogers, Konopelchenko, Stallybrass and Schief to construct solutions in [34, 68]. Taimanov and Tsarëv [82, 83, 84, 85, 86] use the Moutard transformation to construct examples of Schrödinger operators  $L$  with  $L^2$  eigenvalues at zero energy, and solutions of NV which blow up in finite time. In [95, 97] Zheng, J.-F. Zhang and Sheng explore chaotic and fractal properties of solutions to the NV equation.

**2.1. Dispersion, group velocity and phase velocity.** Solitons form when there is a balance between nonlinearity and dispersion. The dispersion relation is the relation that gives the frequency as a function of the wave vector  $(k_1, k_2)$ . To find the dispersion relation for the NV equation, consider the linear part of the equation

$$(2.1) \quad q_t = -\frac{1}{4}q_{xxx} + \frac{3}{4}q_{xyy}$$

The plane wave functions  $q(x, y, t) = e^{k_1 x + k_2 y - \omega t}$  are solutions to (2.1) provided

$$(2.2) \quad \omega = -\frac{1}{4}k_1^3 + \frac{3}{4}k_1 k_2^2.$$

Equation (2.2) defines the dispersion relation for the NV equation.

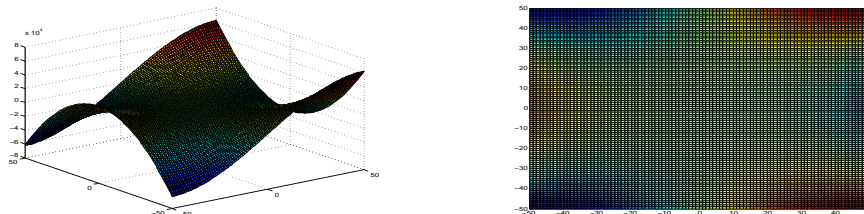

FIGURE 1. Surface plot (left) and heat map (right) of the NV dispersion relation  $\omega(k) = k_1^3/4 + 3k_1 k_2^2/4$

The phase velocity,  $\mathbf{c}_p$ , which gives the velocity of the wavefronts, is defined by  $\mathbf{c}_p = \frac{\omega(\mathbf{k})}{|\mathbf{k}|^2}(k_1, k_2)$  and for the NV equation is

$$(2.3) \quad \mathbf{c}_p = \frac{k_1^3 - 3k_1 k_2^2}{4(k_1^2 + k_2^2)^{3/2}}(k_1, k_2).$$

The group velocity, which gives the velocity of the wave packet, is

$$\mathbf{c}_g \equiv \nabla \omega = \frac{3}{4}(-k_1^2 + k_2^2, 2k_1 k_2).$$

The group velocity is bounded below by 0, and the sign of the phase velocity depends on  $\text{sgn}(k_1^3 - 3k_1k_2^2)$ .

**2.2. Symmetries and Scaling.** To understand how scaling of the dependent and independent variables change the NV equation, let us first consider the auxilliary  $\bar{\partial}$  equation in equation (1.2) in the form

$$\bar{\partial}\nu = \partial q, \quad \nu = v + iw.$$

Note that under the transformation  $r(x, y, t) \equiv \gamma\nu(\alpha t, \beta x, \beta y)$  and  $s(x, y, t) \equiv \gamma q(\alpha t, \beta x, \beta y)$ , the  $\bar{\partial}$  equation remains unchanged, i.e  $\bar{\partial}\nu = \partial q$  if and only if  $\bar{\partial}r = \partial s$ . Then  $r_x(x, y, t) = \beta\gamma\nu_x(\alpha t, \beta x, \beta y)$  and  $r_y(x, y, t) = \beta\gamma\nu_y(\alpha t, \beta x, \beta y)$ .

Now, we examine the main equation as presented in equation (1.2). Note that  $s_t(x, y, t) = \alpha\gamma q_t(\alpha t, \beta x, \beta y)$ ,  $s_{xxx}(x, y, t) = \beta^3\gamma q_{xxx}(\alpha t, \beta x, \beta y)$ ,  $s_{xyy}(x, y, t) = \beta^3\gamma q_{xyy}(\alpha t, \beta x, \beta y)$ , and  $(qv)_x + (qw)_y = \gamma^2\beta((s\Re(r))_x + (s\Im(r))_y)$ . Assuming  $q$  is a solution to the NV equation (1.1), we find

$$\begin{aligned} 4q_t &= -u_{xxx} + 3q_{xyy} + 3(qv)_x + 3(qw)_y \\ \implies \frac{4}{\alpha\gamma}s_t &= -\frac{1}{\beta^3\gamma}s_{xxx} + \frac{3}{\beta^3\gamma}s_{xyy} + \frac{3}{\beta\gamma^2}(s\Re(r))_x + \frac{3}{\beta\gamma^2}(s\Im(r))_y. \end{aligned}$$

Multiplying by  $\alpha\gamma$  leads to

$$(2.4) \quad 4s_t = -\frac{\alpha}{\beta^3}s_{xxx} + \frac{3\alpha}{\beta^3}s_{xyy} + \frac{3\alpha}{\beta\gamma}((sr_1)_x + (sr_2)_y).$$

The table below shows the possible sign conventions possible for each term of the right hand side of equation (2.4).

$\alpha$	$\beta$	$\gamma$	Signs in (2.4)		
+	+	+	-	+	+
-	-	+	-	+	+
-	+	+	+	-	-
+	-	+	+	-	-
+	+	-	-	+	-
-	-	-	-	+	-
-	+	-	+	-	+
+	-	-	+	-	+

Thus, there is a fixed ratio of -3 of the coefficients of the linear spatial terms, and any other coefficient is possible by proper rescaling of independent and dependent variables.

We also consider under what rotations the Novikov-Vesolov is invariant. Writing the NV equation as

$$(2.5) \quad q_t = -\partial^3 q - \bar{\partial}^3 q + 3\partial(q\nu) + 3\bar{\partial}(q\bar{\nu}),$$

$$(2.6) \quad \bar{\partial}\nu = \partial q,$$

it is easy to see by conjugating (2.5), that if  $q$  is real at time  $t_0$ , then  $q$  stays real.

To consider rotations let  $x = x' \cos(\theta) - y' \sin(\theta)$  and  $y = x' \sin(\theta) + y' \cos(\theta)$ . so that

$$\begin{aligned} \partial_z &= e^{i\theta} \partial_{z'} \\ \bar{\partial}_z &= e^{-i\theta} \bar{\partial}_{z'} \end{aligned}$$



Under such rotations, equation (2.5) becomes

$$(2.7) \quad q_t = e^{i\theta} \partial_{z'}(\nu' q) + e^{i\theta} \bar{\partial}_{z'}(\bar{\nu}' q) - e^{-3i\theta} \bar{\partial}_{z'}^3 q - e^{-3i\theta} \partial_{z'}^3 q$$

where  $\nu' = e^{-i\theta} \nu$ . The auxiliary equation becomes

$$e^{i\theta} \bar{\partial}_{z'} \nu' = e^{i\theta} \partial_{z'} q$$

or

$$\bar{\partial}_{z'} \nu' = e^{-3i\theta} \partial_{z'} q,$$

and so we have invariant solutions under rotations of  $2\pi/3$  and  $4\pi/3$ . This shows that if a solution to the NV equation has this symmetry, it must be preserved under the evolution. It does not mean that all solutions will display this type of symmetry.

**2.3. Conservation Laws for the NV equation.** In order to present the conservation laws for (1.1), we need to recall some ideas from the inverse scattering method. A rigorous derivation of the conservation laws for smooth potentials of conductivity type is given below in section 3.

Suppose that  $q \in L^p(\mathbb{R}^2)$  for some  $p \in (1, 2)$ . The scattering data, or *scattering transform*  $\mathbf{t} : \mathbb{C} \rightarrow \mathbb{C}$  of  $q$  is defined via Faddeev's [20] complex geometric optics (CGO) solutions, which we now recall. Let  $z = x + iy$  and  $k = k_1 + ik_2$ . For  $k \in \mathbb{C}$  with  $k \neq 0$ , the function  $\psi(z, k)$  is the exponentially growing solution of the Schrödinger equation

$$(2.8) \quad (-\Delta + q)\psi(\cdot, k) = 0$$

with asymptotic behavior  $\psi(z, k) \sim e^{ikz}$  in the following sense: for  $\tilde{p}$  defined by  $\frac{1}{\tilde{p}} = \frac{1}{p} - \frac{1}{2}$ , we have

$$(2.9) \quad e^{-ikz} \psi(z, k) - 1 \in L^{\tilde{p}}(\mathbb{R}^2) \cap L^\infty(\mathbb{R}^2).$$

It is more convenient to work with the *normalized complex geometric optics solutions* (NCGO)  $\mu(z, k)$  defined by

$$(2.10) \quad \mu(z, k) = \psi(z, k) e^{-ikz}.$$

A straightforward computation shows that  $\mu$  obeys the equation

$$(2.11) \quad \bar{\partial}(\partial + ik)\mu = \frac{1}{4}q\mu, \quad \mu(\cdot, k) - 1 \in L^{\tilde{p}} \cap L^\infty.$$

One can reduce the problem (2.11) to an integral equation of Fredholm type (see the discussion in section 3). Faddeev's Green's function  $g_k$  is the fundamental solution for the equation

$$-4\bar{\partial}(\partial + ik)u = f$$

(the factor of  $-4$  is chosen so that, if  $k = 0$ , the equation reduces to  $-\Delta u = f$  whose fundamental solution is the logarithmic potential; see Appendix A.1 for details).

One has

$$(2.12) \quad \mu = 1 - g_k * (q\mu)$$

(where  $*$  denotes convolution) and it can be shown that the operator  $\varphi \mapsto g_k * (q\varphi)$  is compact on  $L^{\tilde{p}}$ . Thus, for given  $k$ , the solution  $\mu(z, k)$  exists if and only if it is unique.

It is known that such solutions exist for any  $q \in L^p$  provided that  $|k|$  is sufficiently large. In general, however, the equation (2.11) need not have a unique solution for every  $k$ .

Points for which uniqueness fails, i.e., points for which the homogeneous problem

$$\begin{aligned}\bar{\partial}(\partial + ik)\mu &= \frac{1}{4}q\mu, \\ \mu(\cdot, k) &\in L^{\bar{p}} \cap L^\infty.\end{aligned}$$

has a nontrivial solution are called *exceptional points*. It is known that the exceptional points form a bounded closed set in  $\mathbb{C}$ . Nachman [59] proved that the exceptional set is empty for potentials of conductivity type; more recently, Music [55] has shown that the same is true for subcritical potentials. We discuss this further in section 5.

Let

$$(2.13) \quad e_k(z) = e^{i(kz + \bar{k}\bar{z})}.$$

Then, if  $q$  decays rapidly at infinity (say  $q \in \mathcal{S}(\mathbb{R}^n)$ ), the function  $\mu(z, k)$  obeys the large- $z$  asymptotic formula

$$(2.14) \quad \mu(z, k) \sim 1 + \frac{1}{4\pi ikz}s(k) - \frac{e^{-k(z)}}{4\pi i \bar{k}\bar{z}}\mathbf{t}(k) + \mathcal{O}(|z|^{-2})$$

where

$$(2.15) \quad \mathbf{t}(k) = \int e_k(z)q(z)\mu(z, k) dz,$$

$$(2.16) \quad s(k) = \int q(z)\mu(z, k) dz.$$

Note that  $s(k)$  and  $\mathbf{t}(k)$  are *always* defined for large  $|k|$ , whether the potential  $q$  is subcritical, critical, or supercritical.

The asymptotic formula (2.14) is a consequence of the following simple lemma.

**Lemma 2.1.** *Suppose  $k \in \mathbb{C}$  and  $k \neq 0$ , that  $p > 2$  and suppose that  $u \in C^2(\mathbb{C}) \cap L^p(\mathbb{C})$  satisfies*

$$-4\bar{\partial}(\partial + ik)u = f$$

for  $f \in \mathcal{S}(\mathbb{C})$ . Then

$$(2.17) \quad u(z) \underset{|z| \rightarrow \infty}{\sim} \sum_{\ell \geq 0} \frac{a_\ell}{z^{\ell+1}} + e^{-k(z)} \frac{b_\ell}{\bar{z}^{\ell+1}}$$

where

$$\begin{aligned}a_0 &= \frac{1}{4\pi ik} \int f(z) dz, \\ b_0 &= \frac{1}{4\pi i \bar{k}} \int e_k(z)f(z) dz.\end{aligned}$$

*Proof.* The conditions on  $u$  imply that

$$u = g_k * f$$

so using the asymptotic expansion (A.3) for  $g_k$  we obtain

$$(2.18) \quad \begin{aligned}u(z) &= -\frac{1}{4\pi} \sum_{j=0}^N \int \left[ \frac{j!}{(ik(z-z'))^{j+1}} + e^{-i(kz + \bar{k}\bar{z})} \frac{j!}{(-i\bar{k}(z-z'))^{j+1}} \right] f(z') dz' \\ &\quad + \mathcal{O}(|z|^{-N-2})\end{aligned}$$

It is not difficult to see that for  $f \in \mathcal{S}(\mathbb{C})$  and any positive integer  $N$ , the expansion

$$\int \frac{1}{(z - z')^j} f(z') dz' = \sum_{\ell=0}^N c_{\ell,j} z^{-j-\ell} + \mathcal{O}(|z|^{-N-1-j})$$

holds, with an analogous expansion for the terms involving  $\bar{z} - \bar{z}'$ . The existence of the expansion (2.17) is immediate. The leading terms come from the  $j = 0$  term of (2.18).  $\square$

If  $q(z, \tau)$  solves the NV equation at zero energy, it can be shown that  $\mathbf{t}(\cdot, \tau)$ , the scattering transform of  $q(\cdot, \tau)$ , is then given by

$$(2.19) \quad \mathbf{t}(k, \tau) = \mathbf{m}(k, \tau) \mathbf{t}(k, 0),$$

where

$$\mathbf{m}(k, \tau) = \exp(i\tau(k^3 + \bar{k}^3)).$$

On the other hand,

$$(2.20) \quad s(k, \tau) = s(k, 0).$$

Here  $\mathbf{t}(k, \tau)$  and  $s(k, \tau)$  are computed from the solution  $\mu(z, k, \tau)$  of

$$(2.21) \quad \bar{\partial}_z (\partial_z + ik) \mu(z, k, \tau) = \frac{1}{4} q(z, \tau) \mu(z, k, \tau).$$

A rigorous proof of (2.19) and (2.20) for smooth potentials of conductivity type is given in section 3 below.

If  $q$  is smooth, rapidly decreasing, and either critical or subcritical, the Schrödinger potential  $q$  can be recovered using the  $\bar{\partial}$ -method of Beals and Coifman [5] (see [45] for the critical case, and [55] for the subcritical case). Both of these papers use techniques developed by Nachman [59] in the context of the inverse conductivity problem.

We can now derive a set of conservation laws for the NV equation by using the large- $k$  asymptotic expansion of  $s(k)$ . Since  $s(k, \tau)$  is conserved we set  $\tau = 0$  and suppress  $\tau$ -dependence henceforward. We will give a formal derivation of the conserved quantities by using a large- $k$  asymptotic expansion of  $\mu(z, k)$  and inserting this expansion into the formula (2.16). Since  $s(k)$  is conserved, the coefficients of that large- $k$  expansion are also conserved quantities. For the moment, we assume that  $\mu(z, k)$  admits a large- $k$  expansion of the form

$$(2.22) \quad \mu(z, k) \sim 1 + \sum_{j=1}^{\infty} \frac{a_j(z)}{k^j}.$$

We will derive such an expansion for smooth potentials of conductivity type in the next section (see Lemma 3.7). It is expected to hold in general.

Substituting the series (2.22) into (2.21), we may solve the resulting system for the coefficients  $a_j$

$$(2.23) \quad - \sum_{j=1}^{\infty} \frac{\Delta a_j(z)}{k^j} - \sum_{j=1}^{\infty} \frac{4i \bar{\partial} a_j(z)}{k^{j-1}} + q \sum_{j=1}^{\infty} \frac{a_j(z)}{k^j} = -q.$$

We find

$$a_1 = \frac{1}{4i} \bar{\partial}^{-1} q.$$

A recursion formula can then be derived,

$$(2.24) \quad a_{j+1} = \frac{1}{4i} \bar{\partial}^{-1} (-4\bar{\partial}\partial a_j + qa_j) = i\partial a_j + \frac{1}{4i} \bar{\partial}^{-1}(qa_j).$$

From this, it is clear that

$$s(k) \sim \sum_{j=0}^{\infty} \frac{s_j}{k^j}, \quad s_j = \int_{\mathbb{R}^2} q(z) a_j(z) dz.$$

Thus, the first three conserved quantities are

$$\begin{aligned} s_0 &= \int_{\mathbb{R}^2} q(z) dz, \\ s_1 &= \int_{\mathbb{R}^2} \frac{1}{4i} q(z) (\bar{\partial}^{-1} q)(z) dz, \\ s_2 &= \int_{\mathbb{R}^2} \left( \frac{1}{4} q(z) v(z) - \frac{1}{16} q \bar{\partial}^{-1} (q \bar{\partial}^{-1} q)(z) \right) dz, \end{aligned}$$

where with  $z = x + iy$  and  $\zeta = \zeta_1 + i\zeta_2$ ,

$$(\bar{\partial}^{-1} q)(z) = \frac{1}{\pi} \int_{\mathbb{R}^2} \frac{q(\zeta) d\zeta}{z - \zeta}.$$

### 3. INVERSE SCATTERING VIA MANAKOV TRIPLES

In this section we develop the inverse scattering method to solve the Cauchy problem for the Novikov-Veselov (NV) equation at zero energy

$$(3.1) \quad \begin{aligned} q_\tau &= 2 \operatorname{Re} \left( \partial^3 q - \frac{3}{4} \partial(uq) \right) \\ \bar{\partial} u &= \partial q \\ q|_{\tau=0} &= q_0 \end{aligned}$$

for smooth Cauchy data  $q_0$  of *conductivity type* (see Definition 3.2). Note that our convention for the NV equation differs slightly from (1.1); the form used here is more convenient for the zero-energy inverse scattering formalism. This section should be regarded as expository and the material here is undoubtedly “well known to the experts” (see the Manakov [49], Nizhnik [61], and see e.g. Boiti, Leon, Manna, and Pempennelli [9] for the NV equation), although we give an essentially self-contained and mathematically rigorous presentation.

Earlier, Perry [67] exploited Bogdanov’s [6] observation that the NV equation is connected to the modified Novikov-Veselov (mNV) equation by a map analogous to the Miura map that connects the mKdV and KdV equations [50]. The mNV equation belongs to the Davey-Stewartson hierarchy, and the Miura map from mNV to NV has range precisely in the potentials of conductivity type. Building on the analysis of the Davey-Stewartson scattering maps in [66], Perry solves the NV equation for initial data of conductivity type with additional smoothness and decay assumptions.

The approach taken here is more robust because it works directly with the scattering transform for NV and avoids the Miura-type map. An extension of these ideas to subcritical potentials will appear in [55] and [56].

To analyze the scattering transform for NV, we draw on previous work of Lassas, Mueller, and Siltanen [45], Lassas, Mueller, Siltanen, and Stahel [46], and Perry [66],

particularly for mapping properties of the scattering transform and its inverse on the space of smooth functions of conductivity type as defined below. The main ingredient in our analysis (as contrasted to [45, 47, 67]) is the systematic use of the Manakov triple representation for the NV equation.

To describe the Manakov triple representation, suppose that  $q$  is a smooth function of  $z$  and  $\tau$ . Suppose that there is a smooth function  $u(z, \tau)$  with the property that  $\bar{\partial}u = \partial q$  (existence of such a function for suitable classes of  $q$  can be deduced from properties of the Beurling transform; see the Appendix). Define<sup>1</sup>

$$(3.2) \quad L = \partial\bar{\partial} - q/4,$$

$$(3.3) \quad A = \partial^3 + \bar{\partial}^3 - \frac{3}{4}(u\partial + \bar{u}\bar{\partial}),$$

$$(3.4) \quad B = \frac{3}{4}(\partial u + \bar{\partial}\bar{u}),$$

where  $B$  is a multiplication operator. The  $(L, A, B)$  representation means the following:

**Proposition 3.1.** *Let  $q \in C^1([0, T]; C^\infty(\mathbb{C}))$  and suppose that there is a smooth function  $u$  with  $\bar{\partial}u = \partial q$ . Then  $q$  is a classical solution to the Cauchy problem (3.1) if and only if the operator identity*

$$(3.5) \quad \dot{L} = [A, L] - BL$$

*holds.*

The proof is a straightforward calculation. The significance of the Manakov triple is that it defines a scattering problem at zero energy for the operator  $L$ , and a law of evolution of scattering data through the operator  $A$ . We will fully describe the inverse scattering method for smooth initial data of conductivity type, defined as follows:

**Definition 3.2.** *A function  $q_0 \in C^\infty(\mathbb{C})$  is a smooth function of conductivity type if*

$$q_0 = 2\partial u_0 + |u_0|^2$$

*for some  $u_0 \in \mathcal{S}(\mathbb{C})$  with  $\partial u_0 = \bar{\partial}\bar{u}_0$ .*

The regularity requirements can be considerably relaxed but we make them here to ease the exposition. To compare this definition with Nachman's definition (see Definition 1.3 in the introduction), one should think of  $u_0$  as  $2\bar{\partial}\log\sigma$ .

We develop in turn the direct scattering transform, the inverse scattering transform, and the solution formula for NV. We also comment on numerical methods for implementing the direct and inverse scattering transforms.

**3.1. The Direct Scattering Map.** To compute the scattering transform of  $q_0$ , one first constructs the complex geometric optics (CGO) solutions to (2.8). Analytically, it is more convenient to study the normalized complex geometric optics (NCGO) solutions  $\mu$  defined by (2.10). As shown by Nachman [59], there exists a unique solution of (2.11) for every nonzero  $k$ , so that  $\mathbf{t}(k)$  is defined for every nonzero  $k$ . Nachman also shows that  $\mathbf{t}(k)$  is  $\mathcal{O}(|k|^\varepsilon)$  as  $k \rightarrow 0$  for conductivity-type potentials.

---

<sup>1</sup>This Manakov triple differs from that of the introduction by numerical factors since we use, for convenience, the version (3.1) of the NV equation.

**Definition 3.3.** *The map  $\mathcal{T} : q \mapsto \mathbf{t}$  defined by the problem (2.11) and the representation formula (2.15) is called the direct scattering map.*

We will use without proof the following result of Lassas, Mueller, Siltanen, Stahel [46] (see also [67] for a different proof)

**Lemma 3.4.** *Suppose that  $q$  is a smooth function of conductivity type, and let  $\mathbf{t}$  be the scattering transform of  $q$ . Then  $\mathbf{t}(k)/\bar{k} \in \mathcal{S}(\mathbb{C})$ .*

**3.2. Computation of Scattering Transforms.** We describe two approaches for the computation of  $\mathbf{t} = \mathcal{T}q$  for a given compactly supported and continuous  $q$ . The *LS method* is most accurate for  $k$  away from zero, and the *DN method* is more effective for  $k$  near zero. Matlab codes for both approaches are available at the webpage of the book [52].

Without loss of generality we can assume that  $\text{supp}(q) \subset \Omega$  where  $\Omega \subset \mathbb{R}^2$  is the open unit disc. The LS method is based on the definition

$$(3.6) \quad \mathbf{t}(k) = \int_{\mathbb{R}^2} e^{i\bar{k}\bar{z}} q(z) \psi(z, k) dz,$$

and the DN method uses integration by parts to transform (3.6) into

$$(3.7) \quad \mathbf{t}(k) = \int_{\partial\Omega} e^{i\bar{k}\bar{z}} (\Lambda_q - \Lambda_0) \psi(\cdot, k) dS(z),$$

where  $\Lambda_q$  is the *Dirichlet-to-Neumann map* defined below. A rigorous derivation of formulas (3.6) and (3.7) was given by Nachman in [59].

The LS method requires numerical evaluation of the *complex geometrical optics solutions*  $\psi(z, k)$ . Numerically, it is better to solve the Lippmann-Schwinger equation for  $\mu$

$$(3.8) \quad \mu(z, k) = 1 - \int_{\Omega} g_k(z-w) q(w) \mu(w, k) dw.$$

A rigorous solvability analysis for equation (3.8) can be found in [57, 58, 59]. Here  $g_k$  is the fundamental solution satisfying  $(-\Delta - 4ik\bar{\partial})g_k(z) = \delta(z)$ . The origin of  $g_k$  is Faddeev's 1965 article [20]. Computationally,  $g_1(z)$  can be evaluated using the Matlab expression "`exp(-1i*z).*real(expint(-1i*z))/(2*pi);`" The symmetry relation  $g_k(z) = g_1(kz)$  extends this to all values  $k \neq 0$ . Note that  $g_k$  has a  $\log k$  singularity when  $k \rightarrow 0$ , causing numerical difficulties for  $k$  near zero.

Equation (3.8) is defined in the whole plane  $z \in \mathbb{R}^2$ , so some kind of truncation is needed for practical computation. The first numerical computation of complex geometrical optics solutions was reported in [74] in the context of (3.8). That computation was used as a part of the first numerical implementation [75] of the  $\bar{\partial}$  method for electrical impedance tomography. A more effective approach for computing  $\mu$  is based on the periodization technique introduced by Gennadi Vainikko in [90]; see also [72, Section 10.5]. The adaptation of Vainikko's method to equation (3.8) was first introduced in [51]. For more details see [52, Section 14.3].

Now let us turn to the DN method. This method has practical use in the  $\bar{\partial}$  reconstruction method for electrical impedance tomography. (See [52] and the relevant references therein.) We first define the Dirichlet-to-Neumann map  $\Lambda_q$  for the Dirichlet problem

$$(3.9) \quad \begin{aligned} (-\Delta + q)u &= 0 \text{ in } \Omega \\ u|_{\partial\Omega} &= f. \end{aligned}$$

If zero is not a Dirichlet eigenvalue of  $-\Delta + q$  in  $\Omega$ , the problem (3.9) has a unique solution  $u$  for given  $f \in H^{1/2}(S^1)$ , and we set

$$(3.10) \quad \Lambda_q f = \frac{\partial u}{\partial \nu} \Big|_{\partial \Omega}$$

where  $\partial/\partial \nu$  denotes differentiation with respect to the outward normal on  $\partial \Omega$ .

Formula (3.7) requires the trace  $\psi(\cdot, k)|_{\partial \Omega}$ . According to [59], the traces can be solved from the boundary integral equation

$$(3.11) \quad \psi(z, k)|_{\partial \Omega} = e^{ikz} - \int_{\partial \Omega} G_k(z-w) (\Lambda_q - \Lambda_0) \psi(w, k)|_{\partial \Omega} dS(w),$$

if  $k$  is not an exceptional point of  $q$ . Here  $G_k(z) := e^{ikz} g_k(z)$  is Faddeev's Green function for the Laplace operator. For details of the numerical solution of (3.11) see [52, Section 15.3].

**3.3. The Inverse Scattering Map.** It turns out the the NCGO solutions  $\mu(z, k)$  also solve a  $\bar{\partial}$ -problem in the  $k$  variable determined by  $\mathbf{t}(k)$ . Letting

$$(3.12) \quad \mathbf{t}^\sharp(k) = \frac{\mathbf{t}(k)}{4\pi k},$$

we have, for any  $p > 2$ :

**Lemma 3.5.** *Suppose that  $q$  is a smooth potential of conductivity type, and let  $\mu(z, k)$  be the corresponding NCGO solutions. Then:*

$$(3.13) \quad \begin{aligned} \bar{\partial}_k \mu(z, k) &= e_{-k} \mathbf{t}^\sharp(k) \overline{\mu(z, k)} \\ \mu(z, \cdot) - 1 &\in L^p(\mathbb{C}). \end{aligned}$$

Moreover,  $q(z)$  is recovered from  $\mathbf{t}$  and  $\mu(z, k)$  by the formula

$$(3.14) \quad q(z) = \frac{4i}{\pi} \bar{\partial}_z \left( \int e_{-k}(z) \mathbf{t}^\sharp(k) \overline{\mu(z, k)} dk \right)$$

*Remark 3.6.* This equation has at most one solution for each  $z$ , provided only that  $\mathbf{t}^\sharp \in L^2$  by a standard uniqueness theorem for the  $\bar{\partial}$ -problem (see Brown-Uhlmann [13], Corollary 3.11).

The fact that  $\mu(z, k)$  obeys a  $\bar{\partial}$ -equation in the  $k$ -variable also implies a large- $k$  asymptotic expansion for  $\mu(z, k)$ .

**Lemma 3.7.** *Suppose that  $q$  is a smooth potential of conductivity type, and let  $\mu(z, k)$  be the corresponding NCGO solution. Then*

$$(3.15) \quad \mu(z, k) \sim 1 + \sum_{j \geq 0} \frac{c_j(z)}{k^{j+1}}$$

where

$$(3.16) \quad c_0 = -\frac{i}{4} \bar{\partial}^{-1} q$$

$$(3.17) \quad c_1 = -\frac{1}{4} \partial \bar{\partial}^{-1} q + \frac{1}{16} \bar{\partial}^{-1} \left( q \bar{\partial}^{-1} q \right).$$

and the remaining  $c_j$  are determined by the recurrence

$$(3.18) \quad i \bar{\partial} c_{j+1} = \left( \frac{q}{4} - \partial \bar{\partial} \right) c_j$$

*Proof.* The coefficients in the asymptotic expansion may be computed recursively from the equation  $\bar{\partial}(\partial + ik)\mu = (q/4)\mu$  once the existence of the asymptotic expansion is established. To do so, note that

$$\mu(z, k) = 1 + \frac{1}{\pi} \int_{\mathbb{C}} \frac{1}{k - \kappa} e_{-k} \mathbf{t}^{\sharp}(\kappa) \overline{\mu(z, \kappa)} dm(\kappa).$$

Writing

$$(k - \kappa)^{-1} = k^{-1} \sum_{j=0}^N \left(\frac{\kappa}{k}\right)^j + \left(\frac{\kappa}{k}\right)^{N+1} \frac{1}{k - \kappa}$$

we obtain an expansion of the desired form with

$$c_j(z) = \frac{1}{\pi} \int \kappa^j e_{-k} \mathbf{t}^{\sharp}(\kappa) \overline{\mu(z, \kappa)} dm(\kappa)$$

and remainder

$$\frac{1}{\pi} k^{-(N+1)} \int \frac{1}{k - \kappa} \kappa^{N+1} e_{-k} \mathbf{t}^{\sharp}(\kappa) \overline{\mu(z, \kappa)} dm(\kappa)$$

Finally to obtain explicit formulae for the  $c_j$ , we substitute the expansion (3.15) into (2.11) to obtain

$$i\bar{\partial}c_0 = \frac{1}{4}q$$

and the recurrence (3.18) from which (3.17) follows.  $\square$

Motivated by these results, suppose given  $\mathbf{t}^{\sharp} \in \mathcal{S}(\mathbb{C})$  and let  $\mu(z, k)$  be the unique solution to (3.13). Define  $q$  by the reconstruction formula (3.14). Then the solution  $\mu$  of (3.13) obeys the partial differential equation

$$\bar{\partial}(\partial + ik)\mu = \frac{q}{4}\mu, \quad \lim_{|z| \rightarrow \infty} \mu(z, \cdot) - 1 = 0.$$

**Definition 3.8.** The map  $\mathcal{Q} : \mathbf{t} \rightarrow q$  defined by (3.13) and (3.14) is called the inverse scattering map.

We conclude this subsection by obtaining a full asymptotic expansion for  $\mu(z, k)$  which encodes relations between  $s$  and  $\mathbf{t}$ .

**Lemma 3.9.** Suppose that  $q$  is a smooth potential of conductivity type, and let  $\mathbf{t}^{\sharp}$  be given by (3.12). Then, the expansion

$$(3.19) \quad \mu(z, k) \underset{|z| \rightarrow \infty}{\sim} 1 + \sum_{\ell \geq 0} \left( \frac{a_{\ell}}{z^{\ell+1}} + e_{-k} \frac{b_{\ell}}{\bar{z}^{\ell+1}} \right)$$

holds, where:

$$a_0 = -i\bar{\partial}_k^{-1} \left( |\mathbf{t}^{\sharp}|^2 \right),$$

$$b_0 = i\mathbf{t}^{\sharp}$$

and the subsequent  $a_{\ell}, b_{\ell}$  are determined by the recurrence relations

$$\bar{\partial}_k a_{\ell} = \mathbf{t}^{\sharp} \bar{b}_{\ell},$$

$$b_{\ell+1} = i\bar{a}_{\ell} \mathbf{t}^{\sharp} - i\bar{\partial}_k b_{\ell}.$$

*Proof.* The existence of an expansion of the form (3.19) was already established in Lemma 2.1. To compute the coefficients, we substitute the asymptotic series into (3.13).  $\square$



*Remark 3.10.* Comparing Lemmas 2.1 and 3.9, we see that

$$s(k) = 4\pi k \bar{\partial}_k^{-1} \left( |\mathbf{t}^\sharp|^2 \right)$$

**3.4. Computation of Inverse Scattering Transforms.** The first step in the computation of the inverse scattering map is to solve the  $\bar{\partial}$  equation

$$(3.20) \quad \frac{\partial}{\partial \bar{k}} \mu_\tau(z, k) = \frac{\mathbf{t}_\tau(k)}{4\pi \bar{k}} e_{-k}(z) \overline{\mu_\tau(z, k)}$$

with a fixed parameter  $z \in \mathbb{R}^2$  and requiring large  $|k|$  asymptotics  $\mu_\tau(z, \cdot) - 1 \in L^\infty \cap L^r(\mathbb{C})$  for some  $2 < r < \infty$ . Since  $q_0(z)$  is compactly supported and of conductivity type, by [45] the scattering transform  $\mathbf{t}_\tau(k)$  is in the Schwartz class, and the solution  $\mu_\tau$  to equation (3.20) can be computed by numerically solving the integral equation

$$(3.21) \quad \mu_\tau(z, k) = 1 + \frac{1}{4\pi^2} \int_{\mathbb{R}^2} \frac{\mathbf{t}_\tau(k')}{k'(k-k')} e_{-k'}(z) \overline{\mu_\tau(z, k')} dk'.$$

To compute the solution of the  $\bar{\partial}$  equation (3.20), the scattering transform  $\mathbf{t}_\tau(k)$  is truncated to a large disc of radius  $R$ , generally chosen by inspection of the scattering transform. The truncated integral equation is solved numerically by the method described in [43] for each point  $z$  at which the evolved potential is to be computed. The method in [43] is based on Vainikko's periodic method [90]; see also [72, Section 10.5]. Note that since the  $\bar{\partial}$  equation (3.20) is real-linear and not complex-linear due to the complex conjugate on the right-hand side of (3.20), one must write the real and imaginary parts of the unknown function  $\mu$  separately in the vector of function values at the grid points. It is proven in [42] that the error decreases as  $R$  tends to infinity. The first computational solutions of equation (3.20) can be found in [75], and the first computations based on [90] are found in [43]; for more details see [52, Section 15.4].

The inverse scattering transform is defined by

$$(3.22) \quad (\mathcal{Q}\mathbf{t}_\tau)(z) := \frac{i}{\pi^2} \bar{\partial}_z \int_{\mathbb{C}} \frac{\mathbf{t}_\tau(k)}{\bar{k}} e^{-ikz} \overline{\psi_\tau(z, k)} dk,$$

where  $\psi_\tau(z, k) := e^{ikz} \mu_\tau(z, k)$ . The inverse transform (3.22) first appeared in [9, formula (4.10)]. See [45] and the references therein for an analysis of the solvability of (3.20) and the domain of definition for (3.22). Under the assumption that real-valued, smooth initial data of conductivity type remain of conductivity type under evolution by the ISM, the conductivity  $\gamma_\tau$  associated with the potential  $q_\tau$  is given by

$$\gamma_\tau^{1/2}(z) = \mu_\tau(z, 0).$$

Then  $q_\tau$  is computed by numerical differentiation of  $\gamma_\tau$  by the formula

$$q_\tau(z) = \gamma_\tau^{-1/2} \Delta \gamma_\tau^{1/2}.$$

The reader is referred to [47] for numerical examples of the computation of the time evolution of conductivity-type potentials by the ISM.

**3.5. Time Evolution of NCGO Solutions.** In order to prove the solution formula (1.4), we first study the time evolution of NCGO solutions using the Manakov triple representation. First we note the following important uniqueness theorem which is actually a special case of results of Nachman.

**Theorem 3.11.** *Let  $k \in \mathbb{C}$ ,  $k \neq 0$ . Suppose that  $q$  is a smooth potential of conductivity type and that  $\psi$  is a solution of  $L\psi = 0$  with  $\lim_{|z| \rightarrow \infty} (e^{-ikz}\psi(z)) = 0$ . Then  $\psi(z) = 0$ .*

Now suppose that  $q(z, \tau)$  solves the NV equation and that  $t \mapsto q(z, \tau)$  is a  $C^1$  map from  $[0, T]$  into  $\mathcal{S}(\mathbb{C})$ . Suppose that, for each  $\tau$ ,  $\varphi(\tau)$  solves  $L(\tau)\varphi(\tau) = 0$ . Differentiating the equation  $L(\tau)\varphi(\tau) = 0$  and using the Manakov triple representation, we find

$$[A(\tau), L(\tau)]\varphi(\tau) + L(\tau)\dot{\varphi}(\tau) = 0$$

or

$$L(\tau)[\dot{\varphi}(\tau) - A(\tau)\varphi(\tau)] = 0$$

From this simple computation and Theorem 3.11, we can derive an equation of motion for the NCGO solutions, and recover (2.19) and (2.20) from a careful calculation of asymptotics. Later, we will show by explicit construction that, if  $q_0$  is a smooth function of conductivity type, then there is a solution  $q(z, \tau)$  of the NV equation so that  $q(z, \tau)$  is smooth and of conductivity type for each  $\tau$ .

**Lemma 3.12.** *Suppose that  $q(z, \tau)$  is a solution of the NV equation where, for each  $\tau$ ,  $q(z, \tau)$  is a smooth function of conductivity type. Let  $u = \bar{\partial}^{-1}\partial q$ . Then*

$$(3.23) \quad \dot{\mu} = ik^3\mu + (\partial + ik)^3\mu + \bar{\partial}^3\mu - \frac{3}{4}u(\partial + ik)\mu - \frac{3}{4}\bar{u}\bar{\partial}\mu$$

*Proof.* Before giving the proof we make several remarks. Since  $\psi = e^{ikz}\mu$ , the evolution equation (3.23) is equivalent to

$$(3.24) \quad \dot{\psi} = ik^3\psi + \partial^3\psi + \bar{\partial}^3\psi - \frac{3}{4}(u\partial + \bar{u}\bar{\partial})\psi.$$

Next, let  $\varphi(z, k, \tau) = e^{iS}\mu(z, k, \tau)$  with  $S(z, k, \tau) = kz - k^3\tau$ . From the argument above we have

$$L(\tau)[\dot{\varphi}(\tau) - A(\tau)\varphi(\tau)] = 0.$$

To conclude that  $\dot{\varphi}(\tau) = A(\tau)\varphi(\tau)$ , we must show that

$$\lim_{|z| \rightarrow \infty} (e^{-ikz}[\dot{\varphi}(\tau) - A(\tau)\varphi(\tau)]) = 0.$$

Write

$$f \sim_k g$$

if

$$\lim_{|z| \rightarrow \infty} [e^{-ikz}(f - g)] = 0$$

Noting that  $\mu - 1$  and its derivatives in  $z$  and  $\bar{z}$  vanish as  $|z| \rightarrow \infty$ , a simple calculation shows that

$$\begin{aligned} \dot{\varphi} - A\varphi &\sim_k e^{iS} \left( -ik^3\mu - (\partial + ik)^3\mu \right) \\ &\sim_k 0 \end{aligned}$$

Hence  $\dot{\varphi} = A\varphi$  from which (3.24) follows.  $\square$

Hence:

**Lemma 3.13.** *Suppose that  $q(z, \tau)$  is a solution of the NV equation where, for each  $\tau$ ,  $q(z, \tau)$  is a smooth function of conductivity type. Let  $\mu(z, k, \tau)$  be the corresponding NCGO solution with*

$$(3.25) \quad \mu(z, k, \tau) \sim 1 + \frac{1}{4\pi i k z} s(k, \tau) - \frac{e_{-k}(z)}{4\pi i \bar{k} \bar{z}} \mathbf{t}(k, \tau) + \mathcal{O}(|z|^{-2}).$$

Then

$$(3.26) \quad \dot{s}(k, \tau) = 0,$$

$$(3.27) \quad \dot{\mathbf{t}}(k, \tau) = i \left( k^3 + \bar{k}^3 \right) \mathbf{t}(k, \tau).$$

*Proof.* Substituting the asymptotic relation (3.25) into (3.23), we may compute, modulo terms of order  $z^{-2}$ ,

$$\frac{1}{\pi i k z} \dot{s} - \frac{e_{-k}(z)}{\pi i \bar{k} \bar{z}} \dot{\mathbf{t}} = -\frac{e_{-k}(z)}{\pi i \bar{k} \bar{z}} \left( i k^3 + i \bar{k}^3 \right) \mathbf{t}.$$

The computation uses the following facts. If

$$\mu(z, k, \tau) = 1 + \frac{a_0}{z} + e_{-k} \frac{b_0}{\bar{z}} + \mathcal{O}(|z|^{-2})$$

then (“ $\sim$ ” means “is asymptotic as  $|z| \rightarrow \infty$  to”) modulo  $\mathcal{O}(|z|^{-2})$

$$\partial^3 \mu \sim e_{-k} (-ik)^3 \frac{b_0}{\bar{z}},$$

$$\bar{\partial}^3 \mu \sim e_{-k} (-i\bar{k})^3 \frac{b_0}{\bar{z}},$$

$$3ik\partial^2\mu - 3k^2\partial\mu \sim 0$$

together with the fact that  $u$  defined by  $\bar{\partial}u = \partial q$  satisfies  $u = \mathcal{O}(|z|^{-2})$ . The identities (3.26) and (3.27) are immediate.  $\square$

**3.6. Solution by Inverse Scattering.** Motivated by the computations of the preceding subsection, we now consider the problem

$$(3.28) \quad \begin{aligned} \bar{\partial}_k \mu &= e^{i\tau S} \mathbf{t}^\# \mu \\ \mu(z, \cdot, \tau) - 1 &\in L^p(\mathbb{C}) \end{aligned}$$

for a function  $\mu(z, k, \tau)$  and the putative reconstruction

$$(3.29) \quad q(z, \tau) = \frac{4i}{\pi} \bar{\partial}_z \left( \int_{\mathbb{C}} e^{i\tau S} \mathbf{t}^\#(k) \overline{\mu(z, k, \tau)} dk \right).$$

Here

$$(3.30) \quad S(z, k, \tau) = -\frac{1}{\tau} (kz + \bar{k}\bar{z}) + \left( k^3 + \bar{k}^3 \right)$$

and  $\mathbf{t}^\#$  is obtained from the Cauchy data  $q_0$ . We will show that  $q(z, \tau)$  solves the NV equation by deriving an equation of motion for  $\mu(z, k, \tau)$  and using this equation to compute  $q_\tau$  if  $q$  is given by (3.29) and  $\mu$  is the unique solution of (3.28)

First, we establish an equation of motion for the solution  $\mu$  of (3.28). Although this equation is the same equation as (3.23) for the solution of the direct problem, our starting point here is (3.28).

**Lemma 3.14.** *Suppose that  $\mathbf{t}^\sharp \in \mathcal{S}(\mathbb{C})$  and  $\mu$  solves (3.28). For each  $\tau$ , define  $q(z, \tau)$  by (3.29) and define  $u(z, \tau)$  by  $u = \bar{\partial}^{-1} \partial q$ . Then*

$$\dot{\mu} = ik^3 \mu + (\partial + ik)^3 \mu + \bar{\partial}^3 \mu - \frac{3}{4} u (\partial + ik) \mu - \frac{3}{4} \bar{u} \bar{\partial} \mu$$

where  $\partial$  and  $\bar{\partial}$  denote differentiation with respect to the  $z$  and  $\bar{z}$  variables.

*Proof.* Let

$$w = \dot{\mu} - \left( ik^3 \mu + (\partial + ik)^3 \mu + \bar{\partial}^3 \mu - \frac{3}{4} u (\partial + ik) \mu - \frac{3}{4} \bar{u} \bar{\partial} \mu \right).$$

We will show that  $w = 0$  in two steps. First, we show that

$$\bar{\partial}_k w = e^{i\tau S} \mathbf{t}^\sharp \bar{w}.$$

This is an easy consequence of the formulas

$$\begin{aligned} \bar{\partial}_k (\partial + ik) \mu &= e^{i\tau S} \mathbf{t}^\sharp \bar{\partial} \mu, \\ \bar{\partial}_k (\bar{\partial} \mu) &= e^{i\tau S} \mathbf{t}^\sharp \overline{(\partial + ik) \mu} \end{aligned}$$

and holds for any smooth function  $u$ .

Next, we show that for any fixed values of the parameters  $\tau$  and  $z$ ,

$$\lim_{|k| \rightarrow \infty} w(z, k, \tau) = 0.$$

Here we must choose  $u = \bar{\partial}^{-1} \partial q$  in order for the assertion to be correct. Owing to Lemma 3.7 and the formula

$$w = \dot{\mu} - \left( \partial^3 \mu + \bar{\partial}^3 \mu + 3ik\partial^2 \mu - 3k^2 \partial \mu - \frac{3}{4} u (\partial + ik) \mu - \frac{3}{4} \bar{u} \bar{\partial} \mu \right),$$

we have

$$\begin{aligned} w &= -3ik\partial^2 \mu + 3k^2 \partial \mu + \frac{3}{4} u (\partial + ik) \mu + \mathcal{O}(k^{-1}) \\ &= A_{-1} k + A_0 + \mathcal{O}(k^{-1}) \end{aligned}$$

where

$$A_{-1} = 3 \left( \partial a_0 + \frac{i}{4} u \right)$$

and

$$A_0 = 3 \left[ -i\partial^2 a_0 + \partial a_1 + \frac{i}{4} u a_0 \right].$$

The condition  $A_{-1} = 0$  forces the choice  $u = \bar{\partial}^{-1} \partial q$ . We may then compute

$$A_0 = \frac{3}{16} \left[ \partial \bar{\partial}^{-1} \left( q \bar{\partial}^{-1} q \right) - \left( \bar{\partial}^{-1} q \right) \cdot \left( \partial \bar{\partial}^{-1} q \right) \right].$$

On the one hand,  $A_0$  vanishes as  $|z| \rightarrow \infty$  for each fixed  $\tau$  by the decay of  $q$ . On the other hand, a straightforward computation shows that  $\bar{\partial} A_0 = 0$ . It now follows from Liouville's Theorem that  $A_0 = 0$ , and hence  $w = \mathcal{O}(k^{-1})$ . We now used the generalized Liouville Theorem to conclude that  $w = 0$ .  $\square$

Finally, we prove:

**Proposition 3.15.** *Suppose that  $\mathbf{t}^\sharp \in \mathcal{S}(\mathbb{R}^2)$ . Then, the formula*

$$q(z, \tau) = \frac{4i}{\pi} \bar{\partial}_z \left( \int e^{itS(z,k,\tau)} \mathbf{t}^\sharp(k) \overline{\mu(z,k,\tau)} dm(k) \right)$$

*yields a classical solution of the NV equation.*

*Proof.* In what follows, we will freely use the commutation relations

$$(3.31) \quad \partial e^{i\tau S} = e^{i\tau S} (\partial - ik),$$

$$(3.32) \quad \bar{\partial} e^{i\tau S} = e^{i\tau S} (\bar{\partial} - i\bar{k})$$

and the equation

$$(3.33) \quad \bar{\partial} (\partial + ik) \mu = \frac{1}{4} q \mu.$$

For notational brevity we'll write  $c = 4i/\pi$ . We compute

$$\begin{aligned} \dot{q} &= c \bar{\partial} \left( \int e^{i\tau S} \mathbf{t}^\sharp \left\{ ik^3 + i\bar{k}^3 \right\} \mu \right) \\ &\quad + c \bar{\partial} \left( \int e^{i\tau S} \mathbf{t}^\sharp \left\{ -i\bar{k}^3 + (\bar{\partial} - i\bar{k})^3 + \partial^3 - \frac{3}{4} \bar{u} (\bar{\partial} - i\bar{k}) - \frac{3}{4} u \partial \right\} \bar{\mu} \right) \end{aligned}$$

where in the second term we used Lemma 3.14. Using the commutation relations above to move differential operators to the left of  $\exp(itS)$ , we conclude that

$$\dot{q} = \partial^3 q + \bar{\partial}^3 q - \frac{3}{4} \bar{\partial} (u \partial \bar{\partial}^{-1} q) - \frac{3}{4} \bar{\partial} (\bar{u} q) + I$$

where

$$I = c \bar{\partial} \left( \int \left\{ 3ik\partial^2 - 3k^2\partial - \frac{3}{4}iku \right\} e^{i\tau S} \mathbf{t}^\sharp \bar{\mu} \right).$$

We claim that

$$(3.34) \quad I = \frac{3}{4} \left\{ \bar{\partial} (u \partial \bar{\partial}^{-1} q) - \partial (uq) \right\}.$$

If so, then  $q$  solves the NV equation as claimed. To compute  $I$ , write  $I = I_1 - I_2$  where

$$\begin{aligned} I_1 &= c \bar{\partial} \left( \int \{ 3ik\partial^2 - 3k^2\partial \} e^{i\tau S} \mathbf{t}^\sharp \bar{\mu} \right), \\ I_2 &= c \bar{\partial} \left( \int e^{i\tau S} \mathbf{t}^\sharp \left\{ \frac{3}{4}iku \right\} \bar{\mu} \right). \end{aligned}$$

Using (3.33) and (3.32) we may write

$$\begin{aligned} I_1 &= \frac{3}{4} c \partial \left( \int e^{i\tau S} (ik) \mathbf{t}^\sharp q \bar{\mu} \right) \\ &= \frac{3}{4} c \partial \left( q \int (-\partial e^{i\tau S}) \mathbf{t}^\sharp \bar{\mu} \right) \\ &= -\frac{3}{4} c \partial \left( q \partial \left( \int e^{i\tau S} \mathbf{t}^\sharp \bar{\mu} \right) - q \int e^{i\tau S} \mathbf{t}^\sharp \partial \bar{\mu} \right) \\ &= -\frac{3}{4} \partial (q \partial \bar{\partial}^{-1} q) + \frac{3}{4} c \partial \left( q \bar{\partial}^{-1} \bar{\partial} \left( \int e^{i\tau S} \mathbf{t}^\sharp \partial \bar{\mu} \right) \right) \end{aligned}$$

where in the third line we used  $u\partial v = \partial(uv) - v\partial u$ . In the second term on the fourth line, we may use

$$(3.35) \quad \bar{\partial} e^{i\tau S} \partial \bar{\mu} = e^{i\tau S} \partial (\bar{\partial} - ik) \bar{\mu}$$

and (3.33) to conclude that

$$\begin{aligned} \frac{3}{4} c \partial \left( q \bar{\partial}^{-1} \bar{\partial} \left( \int e^{i\tau S} \mathbf{t}^\# \partial \bar{\mu} \right) \right) &= \frac{3}{16} c \partial \left( q \bar{\partial}^{-1} q \left( \int e^{i\tau S} \mathbf{t}^\# \bar{\mu} \right) \right) \\ &= \frac{3}{16} \partial \left( q \bar{\partial}^{-1} \left( q \bar{\partial}^{-1} q \right) \right) \end{aligned}$$

so that

$$\begin{aligned} I_1 &= -\frac{3}{4} \partial \left( q \bar{\partial}^{-1} q \right) + \frac{3}{16} \partial \left( q \bar{\partial}^{-1} \left( q \bar{\partial}^{-1} q \right) \right) \\ &= -\frac{3}{4} \partial (qu) + \frac{3}{16} \partial \left( q \bar{\partial}^{-1} \left( q \bar{\partial}^{-1} q \right) \right). \end{aligned}$$

Similarly, we may compute

$$\begin{aligned} I_2 &= \frac{3}{4} c \bar{\partial} \left( u \int ik e^{i\tau S} \mathbf{t}^\# \bar{\mu} \right) \\ &= \frac{3}{4} c \bar{\partial} \left( u \int (-\partial e^{i\tau S}) \mathbf{t}^\# \bar{\mu} \right) \\ &= -\frac{3}{4} c \bar{\partial} \left( u \partial \left( \int e^{i\tau S} \mathbf{t}^\# \bar{\mu} \right) - u \int e^{i\tau S} \mathbf{t}^\# \partial \bar{\mu} \right) \\ &= -\frac{3}{4} \bar{\partial} \left( u \bar{\partial}^{-1} \partial q \right) + \frac{3}{4} c \bar{\partial} \left( u \bar{\partial}^{-1} \left( \int \mathbf{t}^\# \bar{\partial} (e^{i\tau S} \partial \bar{\mu}) \right) \right). \end{aligned}$$

Using (3.35) again we find

$$\begin{aligned} I_2 &= -\frac{3}{4} \bar{\partial} \left( u \bar{\partial}^{-1} \partial q \right) + \frac{3}{16} \bar{\partial} \left( u \bar{\partial}^{-1} \left( q \bar{\partial}^{-1} q \right) \right) \\ &= -\frac{3}{4} \bar{\partial} (u^2) + \frac{3}{16} \bar{\partial} \left( u \bar{\partial}^{-1} \left( q \bar{\partial}^{-1} q \right) \right) \end{aligned}$$

where we used (3.33) in the first line, and in the second line we used  $u = \bar{\partial}^{-1} \partial q$ . Hence

$$\begin{aligned} I_1 - I_2 &= -\frac{3}{4} \partial (qu) + \frac{3}{4} \bar{\partial} (u^2) \\ &\quad + \frac{3}{16} \partial \left( q \bar{\partial}^{-1} \left( q \bar{\partial}^{-1} q \right) \right) - \frac{3}{16} \bar{\partial} \left( u \bar{\partial}^{-1} \left( q \bar{\partial}^{-1} q \right) \right). \end{aligned}$$

Since  $\partial q = \bar{\partial} u$  and  $\bar{\partial}^{-1} \left( q \bar{\partial}^{-1} q \right) = \frac{1}{2} \left( \bar{\partial}^{-1} q \right)^2$  we can conclude that the second line is zero and (3.34) holds. The conclusion now follows.  $\square$

#### 4. SPECIAL SOLUTIONS

There are various powerful methods to find solutions of nonlinear evolution equations, most notably the inverse scattering method. However, the inverse scattering method is not readily useful for finding closed-form solutions to the NV equation, and so techniques including Hirota's method and the extended mapping approach (EMA) are presented here to construct closed-form solutions of several types of solitons. We begin by explaining the close connection between plane-wave solutions

to NV and solutions to the KdV equation and present evolutions of KdV ring-type solutions. Although the KdV ring-type solution is not of conductivity type, the scattering transform is computed in Section 4.3, and the numerical results provide evidence of the presence of an exceptional circle.

**4.1. KdV-type Solutions.** Consider the NV equation (3.1) in the form

$$(4.1) \quad \dot{q} = -\frac{1}{4}q_{xxx} + \frac{3}{4}q_{xyy} + \frac{3}{4}\operatorname{div}((q - E)\mathbf{u}),$$

where  $u = u_1 + iu_2$  and  $\mathbf{u} = (u_1, u_2)$ , and the auxiliary equation  $\bar{\partial}u = \partial q$  as

$$(4.2) \quad \begin{cases} (u_1)_x - (u_2)_y &= +q_x \\ (u_2)_x + (u_1)_y &= -q_y \end{cases}$$

As in [16] we use a FFT-based method to solve the equations on the square  $-L \leq x, y \leq +L$  with periodic boundary conditions.

To examine the linear contributions we introduce a function

$$q(t, x, y) = \exp(i(\xi x + \eta y)).$$

Then the  $\bar{\partial}$  equation (4.2) is solved by

$$\begin{aligned} u_1(t, x, y) &= \frac{\xi^2 - \eta^2}{\xi^2 + \eta^2} \exp(i(\xi x + \eta y)) \\ u_2(t, x, y) &= \frac{-2\xi\eta}{\xi^2 + \eta^2} \exp(i(\xi x + \eta y)), \end{aligned}$$

and thus the linear part of the NV equation (4.1)

$$\dot{q} = -\frac{1}{4}\frac{\partial^3}{\partial x^3}q + \frac{3}{4}\frac{\partial^3}{\partial x\partial y^2}q + E\frac{3}{4}\nabla \cdot \mathbf{u}$$

is transformed into a elementary linear ODE for the Fourier coefficient  $c(t)$

$$4\frac{d}{dt}c(t) = i(\xi^3 - 3\xi\eta^2) \left(1 - \frac{3E}{\xi^2 + \eta^2}\right) c(t).$$

Assuming a Fourier approximation of the solutions

$$q(t, x, y) = \sum_{j,k=0}^{N-1} c_{j,k}(t) \exp(i\pi(kx + jy)/L)$$

this leads to a coupled system of ODEs for the Fourier coefficients  $c_{j,k}(t)$ . We use a Crank–Nicolson scheme for the linear part of NV and an explicit method for the nonlinear contribution  $\operatorname{div}(q\mathbf{u})$ . For details see [16, 17].

There is a close connection between plane wave solutions to NV and solutions to KdV (see [16]):

*Remark 4.1.* Assume the solutions to NV are planar waves

$$\begin{aligned} q(t, s) &= q(t, x, y) = q(t, n_1s, n_2s) \\ u_i(t, s) &= u_i(t, x, y) = u_i(t, n_1s, n_2s) \end{aligned}$$

for some direction vector  $\vec{n} = (n_1, n_2) = (\cos(\alpha), \sin(\alpha))$ . Then the bounded solutions to the  $\bar{\partial}$  equation (4.2) are given by

$$\begin{aligned} u_1(t, s) &= +(n_1^2 - n_2^2) q(t, s) + c_1 \\ u_2(t, s) &= -(2 n_1 n_2) q(t, s) + c_2 \end{aligned}$$

for arbitrary constants  $c_1, c_2$ , and the NV equation (4.1) reduces to an equation similar to the KdV equation,

$$(4.3) \quad \frac{4}{\kappa} q_t = -q''' + 6 q q' + \frac{3\beta}{\kappa} q'$$

with  $\kappa = \cos(3\alpha)$  and  $\beta = -\kappa E + c_1 n_1 + c_2 n_2$ . If  $v(t, s)$  denotes a solution to the standard KdV equation

$$(4.4) \quad \dot{v}(t, x) = -v'''(t, x) + 6 v(t, x) v'(t, x),$$

we obtain explicit solutions to NV by

$$q(t, s) = v\left(\frac{\kappa}{4}t, s + k_1 t\right) - k_2 = v\left(\frac{\kappa}{4}t, s + \frac{3}{4}(c_1 n_1 + c_2 n_2)t\right) + \frac{E}{2}.$$

For the special case  $c_1 = c_2 = 0$  we find

$$q(t, n_1 s, n_2 s) = q(t, s) = v\left(\frac{\kappa}{4}t, s\right) + \frac{E}{2}$$

Thus we can relate all solutions to KdV as planar solutions to NV, with different speeds of propagation depending on the direction of the plane wave. An example of this are the solutions generated by Hirota's method, see section 4.2.1.

*Example 4.2.* Based on the above remark we have an exact solution of the NV equation at zero energy given by

$$q(t, x, y) = -2c \cosh^{-2}(\sqrt{c}(x - ct)).$$

This solution is unstable with respect to perturbations periodic in  $y$  direction with period  $\frac{2\pi}{k\sqrt{c}}$  for  $0.363 < k < 1$ , see [16]. This is confirmed by numerical evolution of the NV equation using the above spectral method.

*Example 4.3.* A KdV ring initial condition.

Using  $r = \sqrt{x^2 + y^2}$  we choose a radially symmetric initial value

$$q_0(x, y) = q(0, x, y) = f(r) = -\frac{1}{2} \cosh^{-2}\left(\frac{1}{2}(r - 20)\right) < 0.$$

This corresponds to a solution of equation (4.3) in the radial variable  $r$ , a KdV ring with radius 20.

Observing that 0 is a potential of conductivity type, we may use the argument in [57, Appendix B] (based on [54]) to conclude that  $q_0$ , as a non-positive deviation from 0, is subcritical and consequently not of conductivity type. In [54] Murata classifies general solutions of the Schrödinger equation  $\Delta u = q u$ . For our special case we have an elementary proof for the required result. For  $q(0, x, y)$  to be of conductivity type we would need a positive, radially symmetric function  $u$  such that  $\Delta u = q u$  or in radial coordinates  $(r u'(r))' = r f(r) u(r)$ . Since the function is radially symmetric we use  $u'(0) = 0$  and an integration leads to

$$r u'(r) = 0 + \int_0^r s f(s) u(s) ds < 0$$



Thus  $u'(r)$  is negative and  $r u'(r)$  is decreasing. Consequently we have a constant  $C = -r_0 u'(r_0) > 0$  and for all  $r \geq r_0$  we conclude  $u'(r) \leq -C/r$ . This implies

$$u(r) = u(r_0) + \int_{r_0}^r u'(s) ds \leq u(r_0) - \int_{r_0}^r \frac{C}{s} ds = u(r_0) - C(\ln(r) - \ln(r_0))$$

and for  $r$  large enough this is in contradiction to  $u(r) > 0$  and thus  $q_0(x, y)$  is not of conductivity type.

We solve the NV equation at zero energy  $E = 0$  with the above initial condition. Based on the speed profile with the angularly dependent speed factor  $\kappa = \cos(3\alpha)$  from Remark 4.1, one expects that the initially circular shape will be deformed and its shape will be more triangular at later times. This is confirmed by Figure 2, which shows graphs of  $-q(t, x, y)$  at different times  $t$ .

To examine the possible blowup of the solution at a finite time we ran the algorithm based on the spectral method on a domain  $-50 \leq x, y \leq +50$  with Fourier grids of sizes  $1024 \times 1024$ ,  $2048 \times 2048$  and  $4096 \times 4096$ . With time steps  $dt = 0.01$  and  $dt = 0.001$  we examined the solution and its  $L_2$  norm. In all cases the solution either blew up at times just beyond  $t = 38$  or displayed a sudden occurrence of sizable noise. For a final decision of a blow up time the exact shape and size of the spikes in Figure 2 have to be examined carefully.

Letting the KdV ring initial condition evolve for negative times, we observed the same solutions as for positive times, but rotated by in the spatial plane by  $60^\circ$ . We observed blowup at times smaller than  $t = -38$ .

*Example 4.4.* With the initial value of the KdV ring in Example 4.3, we evolve the solution by the NV equation (4.1) and (4.2) with a positive energy  $E = 1/8$ . Time snapshots of the evolution are plotted in Figure 3. The initial dynamics are comparable to the previous example at zero energy: three spikes appear and grow rapidly in size, but as time progresses, these spikes decay in amplitude, and separate from the previous KdV ring, and a new triple of spikes appears. The process is repeated. Observe that the solution exists at least until time  $t = 100$ , also confirmed by the graph of the  $L_2$  norm of the solution as function of time in Figure 4.

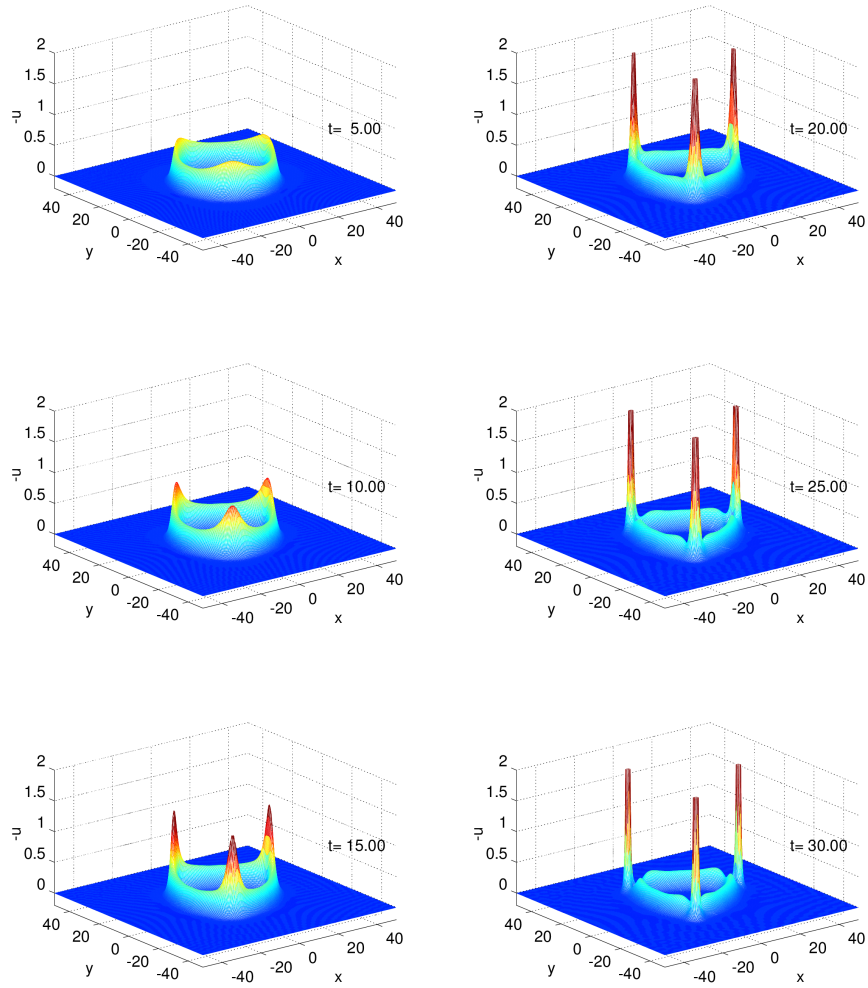

FIGURE 2. Evolution of a KdV ring by NV at zero energy

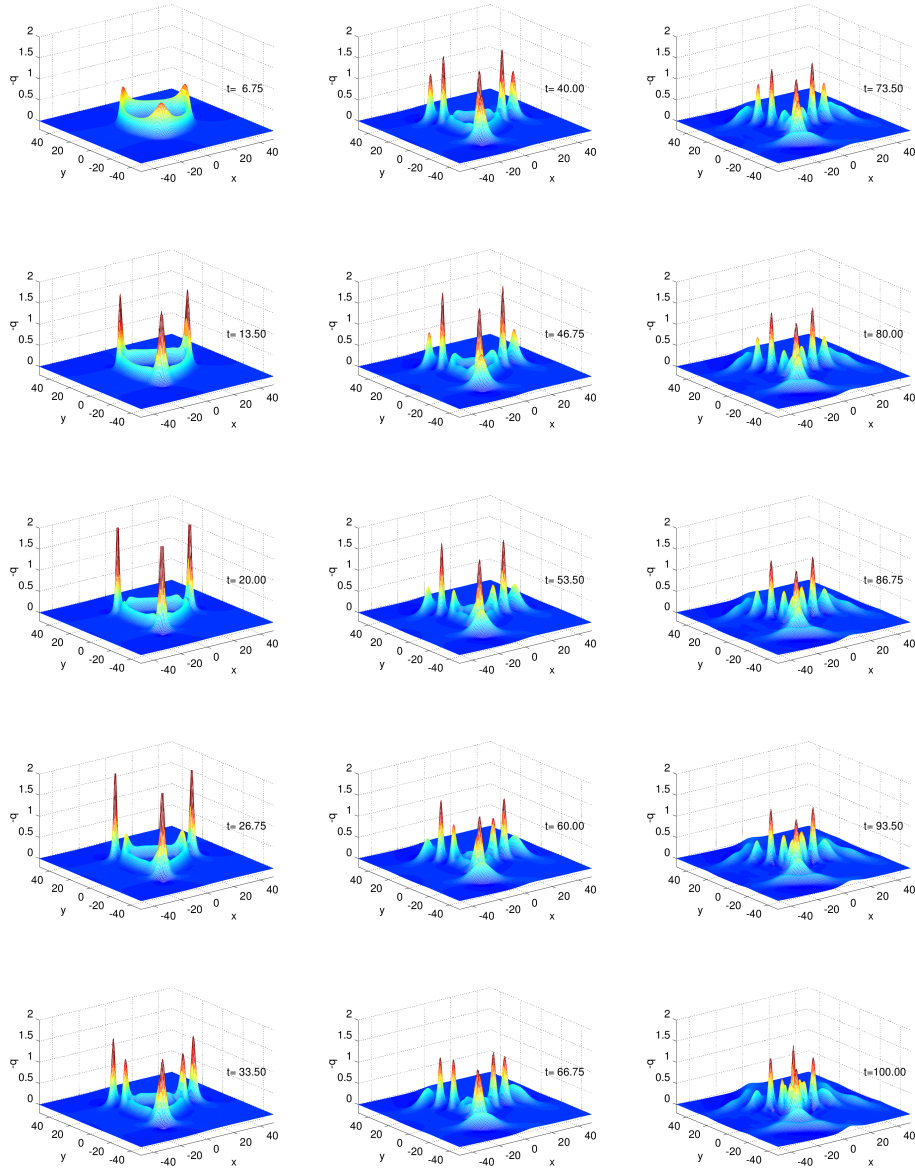

FIGURE 3. Evolution of a KdV ring by NV at positive energy

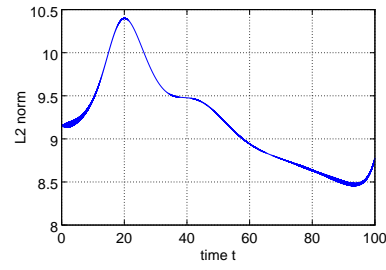

FIGURE 4.  $L_2$  norm of the positive-energy NV solution of Figure 3.

**4.2. Closed-form Solutions.** Most, if not all, soliton equations admit traveling wave solutions that involve the hyperbolic secant function, which can be written in terms of the hyperbolic tangent function. Moreover, the hyperbolic tangent function is a solution to the Riccati equation,  $\phi' = l_0 + \phi^2$ , for  $l_0 < 0$  for certain initial conditions. The ubiquity of the hyperbolic functions as traveling wave solutions naturally leads to the idea of expansion methods for solving soliton equations.

Solutions in the literature to the NV equation include the solutions from the inverse scattering transform [45, 46, 47, 92], the classic hyperbolic secant and cnoidal solutions [60], and rational solutions derived using Darboux transformations that lead to finite time blow-up (see [86] and references therein). In this section we present new solutions to the NV equation using Hirota's bilinear method and the Extended Mapping Approach (EMA). New multiple traveling wave solutions using the Modified Extended Tanh-Function Method can be found in [17]. This approach results in closed-form solutions, most of which contain singularities. We note that the solutions found by Hirota's method are plane-wave solutions, that is, KdV-type solutions, while the EMA-derived solutions are not.

**4.2.1. Hirota's Method.** Following the pioneering work of Hirota [33], multisoliton solutions can be derived using *Hirota's bilinear method*. This method yields soliton solutions as a sum of polynomials of exponentials and was used in [93] to find multisoliton solutions to the Nizhnik-Novikov-Veselov equation

$$\begin{aligned}\dot{q} &= -aq_{xxx} + bq_{yyy} - 3a(qu_1)_x - 3b(qu_2)_y \\ q_x &= (u_1)_y \\ q_y &= (u_2)_x\end{aligned}$$

The main idea is to reduce the nonlinear equation to a bilinear form through a transformation involving the logarithmic function. To express the wave velocity  $c$  in terms of the dispersive coefficients, assume  $u$  is a plane wave solution with  $k_1 = k_2 = k$ ,  $u = e^{kx+ky-ct}$ , and substitute  $u$  into (2.1). This results in  $c = -k^3/2$ . Under the transformations  $q = R(\ln(f))_{xx}$ ,  $v = R(\ln(f))_{xy}$ , and  $w = R(\ln(f))_{yy}$  where  $f(x, y, t) = 1 + Ce^{kx+ky+\frac{k^3}{2}t}$  and  $C$  is an arbitrary constant, one can algebraically solve for  $R$  to find a bilinear form (one finds  $R = 2$ ). This method results in the soliton solution

$$(4.5) \quad q(x, y, t) = u_1(x, y, t) = u_2(x, y, t) = \frac{2Ck^2e^{k(2x+2y+k^2t)/2}}{(1 + e^{k(2x+2y+k^2t)/2})^2}.$$

Choosing

$$f(x, y, t) = 1 + e^{\theta_1} + e^{\theta_2} + a_{12}e^{\theta_1+\theta_2},$$

where  $\theta_i = k_i x + k_i y + \frac{1}{2}k_i^3 t$ ,  $i = 1, 2$ , in the logarithmic transformations above results in the two-soliton solution with  $a_{12}$  given in terms of  $k_1$  and  $k_2$  by  $a_{12} = (k_1 - k_2)^2 / (k_1 + k_2)^2$

$$(4.6) \quad q(x, y, t) = \frac{2(k_1^2 e^{\theta_1} + k_2^2 e^{\theta_2} + (k_1 - k_2)^2 e^{\theta_1 + \theta_2})}{1 + e^{\theta_1} + e^{\theta_2} + \frac{(k_1 - k_2)^2}{(k_1 + k_2)^2} e^{\theta_1 + \theta_2}} - \frac{2\left(k_1 e^{\theta_1} + k_2 e^{\theta_2} + \frac{(k_1 - k_2)^2}{k_1 + k_2} e^{\theta_1 + \theta_2}\right)^2}{\left(1 + e^{\theta_1} + e^{\theta_2} + \frac{(k_1 - k_2)^2}{(k_1 + k_2)^2} e^{\theta_1 + \theta_2}\right)^2}.$$

The evolution of the two-soliton solution is plotted in Figure 5. Further details and a three-soliton solution are found in [17].

The above Hirota solutions are planar solutions to the NV equations and thus are connected to solutions of KdV, see Remark 4.1.

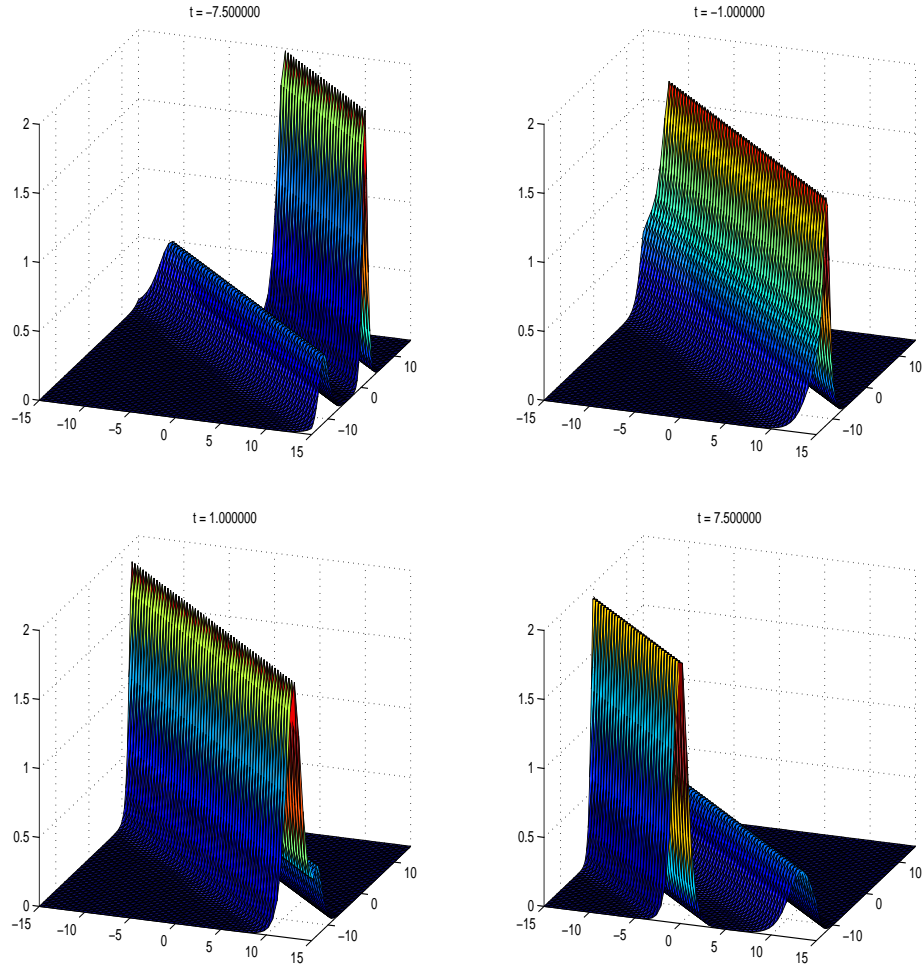

FIGURE 5. Time snapshots of the evolution of a 2-soliton solution derived Hirota's bilinear method.

4.2.2. *Extended Mapping Approach.* The extended mapping approach (EMA) was presented formally by Zheng [97] and extends results by Lou and Ni [48]. The method is designed to find mappings between nonlinear PDE's. In this approach,  $q, v, w$  are expanded in terms of a function  $\phi_i$  that satisfies the Riccati equation

$$\frac{d\phi}{dR} = \ell_0 + \phi^2,$$

where  $R = R(x, y, t)$ . Thus,  $q(x, y, t) = \sum_{i=0}^n a_i \phi^i$ ,  $v(x, y, t) = \sum_{i=0}^m b_i \phi^i$ , and  $w(x, y, t) = \sum_{i=0}^k c_i \phi^i$ , where the values of  $n, m$  and  $k$  are determined by balancing the highest order derivative terms with the nonlinear terms of the PDE. The method is described nicely in [73]. The balancing method results in  $n = m = k = 2$ . Substituting these expansions into the NV equation and equating coefficients of the resulting polynomial in  $\phi$  results in a system of thirteen PDE's from which we need to solve for the coefficients  $a_i(x, y, t), b_i(x, y, t)$ , and  $c_i(x, y, t)$ ,  $i = 1, 2$ . Using a separation technique for  $R$ , namely,  $R(x, y, t) = p(x, t) + q(y, t)$  results in *sech*<sup>2</sup> solutions, static (time-independent) solutions, and breather-type solutions of the NV equation. Further details, including the choices of  $\phi$  are found in [17]. A time-independent solution is given by

$$\begin{aligned} q(x, y, t) &= \frac{-1728 y^6 + (-96 + 1728 C) y^4 + (-40 + 288 C) y^2 - 36 C + 5}{432 y^4 - 36 y^2} - \\ &\quad -4 \tanh(x + y^2) + (2 + 8 y) \tanh^2(x + y^2) \\ v(x, y, t) &= \frac{144 y^4 + (-12 + 432 C) y^2 - 36 C + 5}{36 y^2} \\ &\quad +4 \tanh(x + y^2) + (2 - 8 y) \tanh^2(x + y^2) \\ w(x, y, t) &= 8 y - 8 y \tanh^2(x + y^2), \end{aligned}$$

where  $C$  is an arbitrary constant. See Figure 6 for a plot of the solution  $q$  with  $C = 1$ .

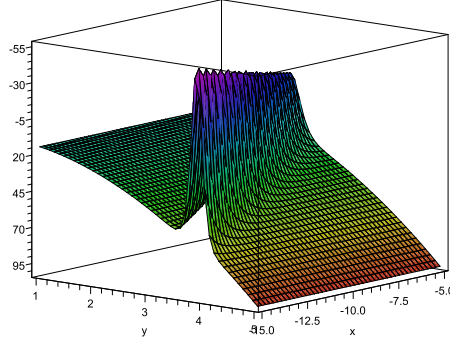

FIGURE 6. A static solution to the NV equation

Breather solutions are solutions with a type of periodic back-and-forth motion in time. One particular breather solution from [17] is

$$\begin{aligned} q(x, y, t) &= \frac{-1728 y^6 + (-96 + 1728 C) y^4 + (-40 + 288 C) y^2 - 36 C + 5}{432 y^4 - 36 y^2} - \\ &\quad -4 \tanh(1 + x + y^2 + 4 \cos t) + (2 + 8 y^2) \tanh^2(1 + x + y^2 + 4 \cos t) \\ v(x, y, t) &= \frac{-192 \sin(t) y^2 + 144 y^4 + (-12 + 432 C) y^2 - 36 C + 5}{36 y^2} + \\ &\quad +4 \tanh(1 + x + y^2 + 4 \cos t) + (2 - 8 y^2) \tanh^2(1 + x + y^2 + 4 \cos t) \\ w(x, y, t) &= 8 y - 8 y \tanh^2(1 + x + y^2 + 4 \cos t). \end{aligned}$$

Several time snapshots are shown in Figure (7). For multisoliton solutions the reader is referred to [17].

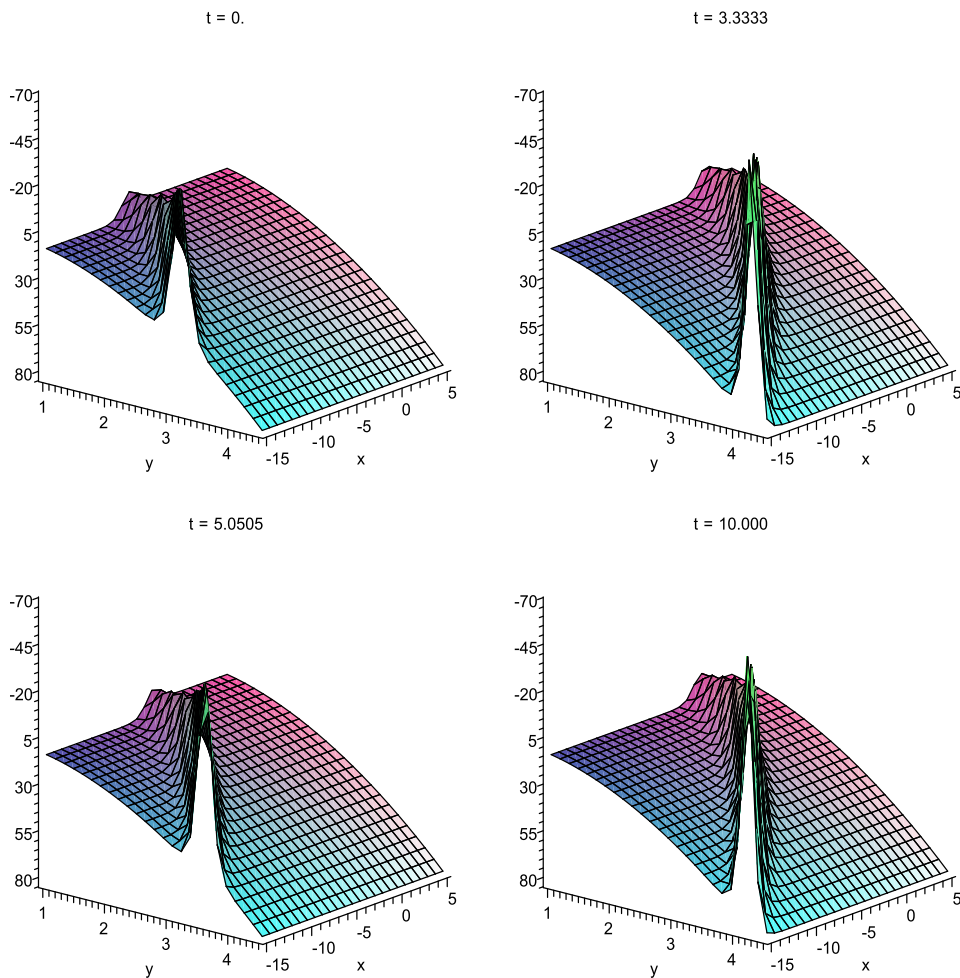

FIGURE 7. Time snapshots of a breather solution derived using the EMA.

For multisoliton solutions the reader is referred to [17]



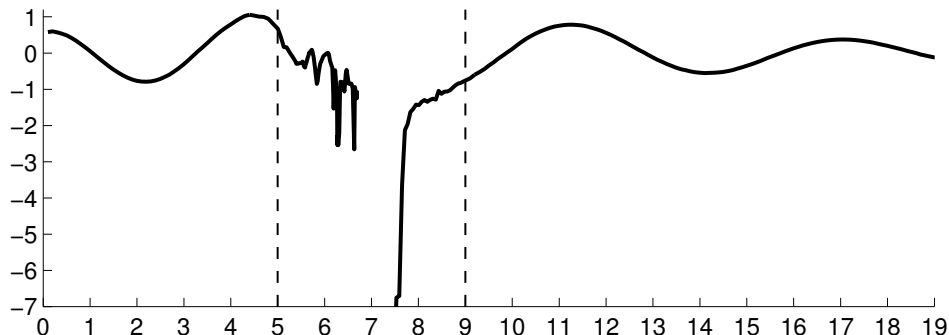

FIGURE 8. Profile of the scattering transform  $\mathbf{t}(k)$  of the KdV ring soliton for  $k$  ranging in the positive real axis. The computation was unstable in the region  $5 < |k| < 9$ , suggesting the presence of an exceptional circle.

**4.3. Scattering transform of the ring soliton at time zero.** In this section we compute numerically the scattering transform of the KdV ring soliton discussed in example 4.3 and illustrated in Figure 2. Since the initial potential is supercritical, we expect the scattering transform to have a singularity. Since the initial potential is real-valued and rotationally symmetric in the  $z$ -plane, also the scattering transform is real-valued and rotationally symmetric in the  $k$ -plane. See [57, Appendix A] for a proof. Therefore it is enough to compute  $\mathbf{t}(k)$  only for real and positive  $k$ .

We use both the LS and the DN methods described in Section 3.2 and compare the results to verify accuracy. The values in the range  $0.1 \leq |k| \leq 4$  are reliable as the results of both NV and LS methods closely agree there. However, the DN method does not give reliable results for  $|k| > 4$ .

To assure accuracy for  $|k| > 4$ , we compare the results of the LS method with two different grids in the  $z$ -domain. The coarser grid has  $4096 \times 4096$  points, and the finer grid has  $8192 \times 8192$  points. The coarser grid is not a subset of the finer grid. We remark that both of these grids are significantly finer than those we typically use for computing scattering transforms for conductivity-type potentials. Due to high memory requirements, we used a liquid-cooled HP Z800 Workstation with 192 GB of memory. Even with that powerful machine, the evaluation of one point value using the finer grid takes more than 11 hours. The LS method gives closely matching results in the regions  $3 \leq |k| \leq 5$  and  $|k| > 9$ .

Figure 8 shows the profile of the scattering transform. In the interval  $5 < |k| < 9$  the numerical computation does not converge, resulting either in inaccurate evaluation of the point values of the scattering transform or in complete failure of the algorithm due to using up all the memory. We suspect that the observed numerical divergence arises from the existence of at least one exceptional circle in the interval  $5 < |k| < 9$ .

## 5. ZERO-ENERGY EXCEPTIONAL POINTS

The inverse scattering method for the solution of the Novikov-Veselov equation is based on the complex geometrical optics (CGO) solutions  $\psi$  of the Schrödinger equation (2.8). The function  $\psi(z, k)$  is asymptotically close to the exponential function  $e^{ikz}$  in the sense of formula (2.9); the point is that  $\psi$  can be used to define a nonlinear Fourier transform  $\mathbf{t}(k)$  specially designed for linearizing the NV equation. See diagram (1.5) above.

However, there is a possible difficulty in using  $\psi$  and  $\mathbf{t}$ . Even in the case of a smooth and compactly supported potential  $q \in C_0^\infty$ , there may exist complex numbers  $k \neq 0$  for which equation (2.8) does not have a unique solution satisfying the asymptotic condition (2.9). Such  $k$  are called *exceptional points* of  $q$ . It is shown in [57] that that exceptional points of rotationally symmetric potentials come in circles centered at the origin and that the scattering transform has a strong singularity at the circles. The singularity prevents any currently understood use of the inverse nonlinear Fourier transform in the diagram (1.5). It seems safe to assume that the situation becomes only worse for more general potentials.

What is the connection between exceptional points and dynamics of solutions of the Novikov-Veselov equation? For example, does the absence of exceptional points in the initial data ensure smooth NV evolution? Do exceptional points perhaps correspond to lumps or solitons or finite-time blow-ups? Such a conjecture was presented already in [9, page 27], but the question is still open.

This section is devoted to a computational experiment illustrating exceptional points of a parametric family of rotationally symmetric potentials. The example clarifies the relationship between exceptional points and the trichotomy supercritical/critical/subcritical presented in Definition 1.1.

Take a radial  $C_0^2$  function  $w(z) = w(|z|)$  as shown in Figure 9. A detailed definition of  $w$  is given in [56, Section 5.1]. Define a family of potentials by  $q_\lambda = \lambda w$ , parameterized by  $\lambda \in \mathbb{R}$ . Now the case  $\lambda = 0$  gives  $q_0 \equiv 0$ , which is a critical potential since it arises as  $q_0 = \sigma^{-1} \Delta \sigma$  with the positive function  $\sigma \equiv 1$ . From Murata [53] we see that  $\lambda < 0$  gives a supercritical potential and  $\lambda > 0$  gives a subcritical potential. See [57, Appendix B] for details.

We use the DN method described in Section 3.2 to compute the scattering transforms of the potentials  $q_\lambda$  for the parameter  $\lambda$  ranging in the interval  $[-25, 5]$ . Since each potential  $q_\lambda(z)$  is real-valued and rotationally symmetric in the  $z$ -plane, also the scattering transform is real-valued and rotationally symmetric in the  $k$ -plane. See [57, Appendix A] for details. Therefore it is enough to compute  $\mathbf{t}(k)$  only for  $k$  ranging along the positive real axis. We show a selection of the results of the computation as function plots in Figure 10, and all the results in Figure 11 as a two-dimensional grayscale image.

It is known that critical potentials do not have nonzero exceptional points; see [57, 59]. Thus there are no singularities in Figure 11 for  $\lambda = 0$  (actually in this simple example we have  $\mathcal{T}q_0 \equiv 0$ ). Furthermore, a Neumann series argument shows that for a fixed  $\lambda$  there exists such a positive constant  $K = K(\lambda)$  that there are no exceptional points for  $q_\lambda$  satisfying  $|k| > K$ . See the analysis in [59, above formula (1.12)].

According to [55], subcritical potentials do not have nonzero exceptional points. Thus there are no singularities in Figure 11 for parameter values  $\lambda \geq 0$ . (We remark that the seemingly exceptional curves in the upper right corner of Figures 3 and 9

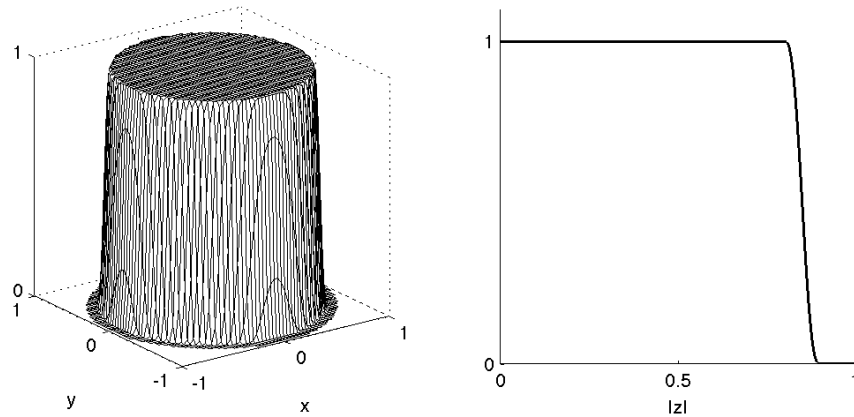

FIGURE 9. Left: rotationally symmetric test function  $w(z)$ . Right: the profile  $w(|z|)$ .

in [57] are due to deteriorating numerical accuracy for large positive values of  $\lambda$ . Those figures are trustworthy only for  $\lambda$  close to zero.)

For negative  $\lambda$  close to zero it is known from [57] that there is exactly one circle of exceptional points. The asymptotic form of that radius as a function of  $\lambda$  is calculated explicitly in [57].

For  $\lambda \ll 0$  there is no precise understanding of exceptional points as of now; numerical evidence such as Figure 11 suggests that there may be several exceptional circles. Also, something curious seem to happen around  $\lambda \approx -8$  and  $\lambda \approx -20.5$ ; at present there is no explanation available.

See [57] for more zero-energy examples and [76] for analogous evidence of exceptional points at positive energies.

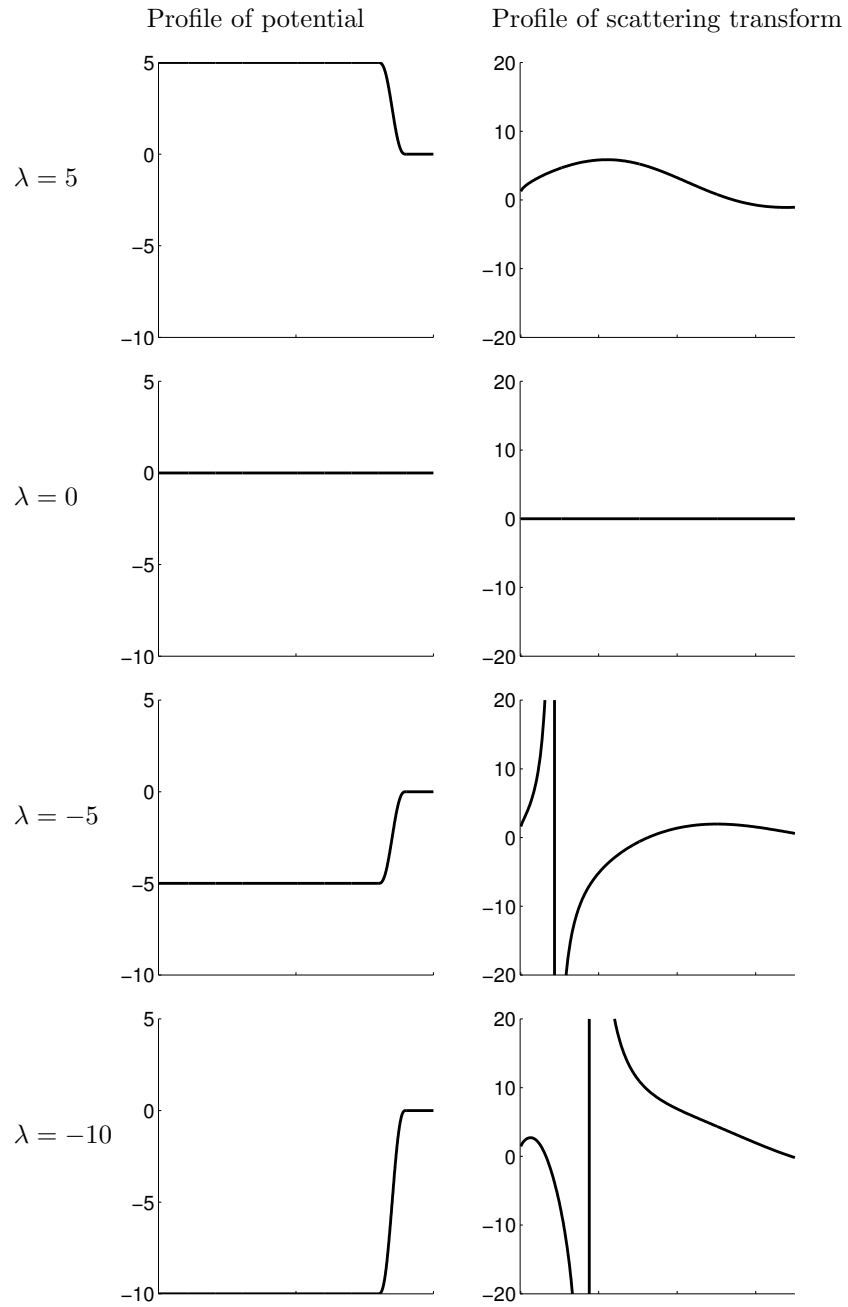

FIGURE 10. Left column: profiles of rotationally symmetric potentials  $q_\lambda(|z|)$  resulting from different values of  $\lambda$ . Right column: profiles of corresponding scattering transforms  $t_\lambda(|k|)$ . Note that negative values of  $\lambda$  lead to exceptional circles where the scattering transform is singular. See also Figure 11 which shows scattering transform profiles corresponding to more values of  $\lambda$ .

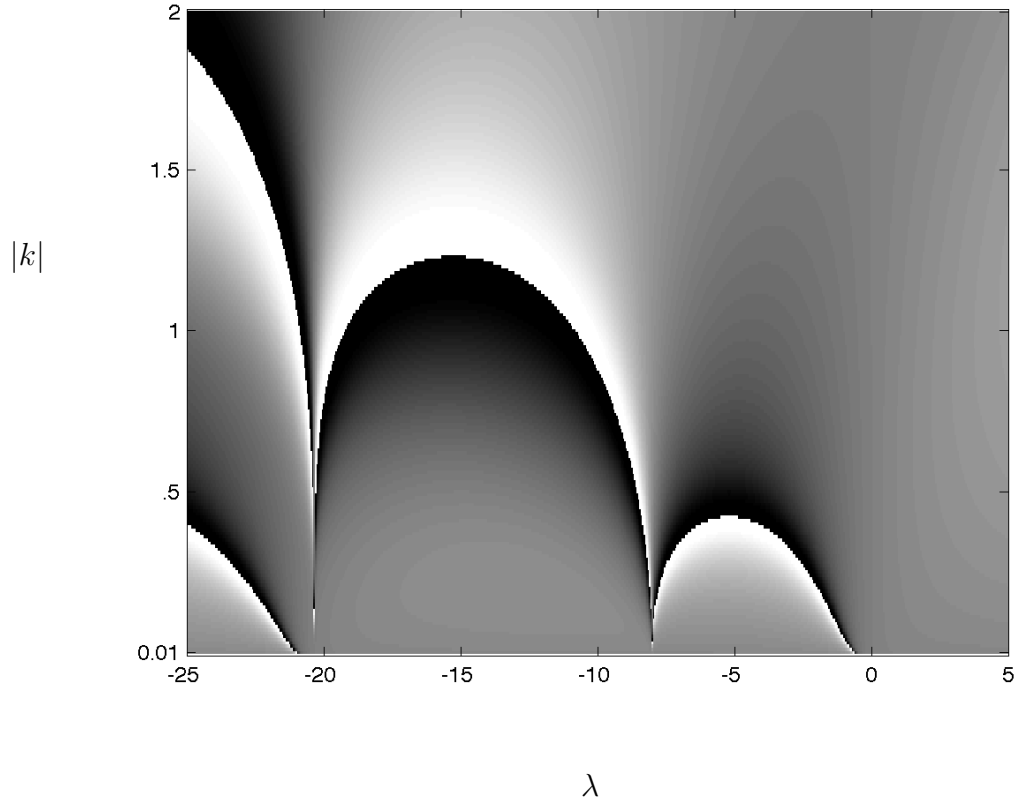

FIGURE 11. Profiles of rotationally symmetric scattering transforms. Lighter shade indicates larger values and darker shade smaller values. The horizontal axis is the parameter  $\lambda$  in the definition  $q_\lambda(z) = \lambda w(z)$  of the potential. The vertical axis is  $|k|$ . There are curves along which a singular jump “from  $-\infty$  to  $+\infty$ ” appears, indicated by an abrupt change from black to white. The  $k$  values at those curves are exceptional points. Note that the profiles corresponding to  $\lambda = -10, -5, 0, 5$  are shown also in Figure 10.

## 6. OPEN PROBLEMS

**6.1. Applications of the NV Equation.** The stationary NV equation [21] and the modified NV equation [81] have applications in differential geometry. Although the NV equation (1.1) is not known to be a mathematical model for any physical dynamical system, there has been some research in this direction for the dispersionless Novikov-Veselov (dNV) equation

$$(6.1) \quad \begin{aligned} q_\xi &= (uq)_z + (\bar{u}q)_{\bar{z}} \\ u_{\bar{z}} &= -3q_z. \end{aligned}$$

Equation (6.1) was derived in [44] as the geometrical optics limit of Maxwell's equations in an anisotropic medium. The model governs the propagation of monochromatic electromagnetic (EM) waves of high frequency  $\omega$ . In particular, they consider nonlinear media with Cole-Cole dependence [15] of the dielectric function and magnetic permeability on the frequency. Assuming slow variation of all quantities along the  $z$  axis, it is shown that Maxwell's equations reduce to (6.1) where  $q = n^2$ , the refractive index, and  $\xi$  is a "slow" variable defined by  $z = \omega^\nu \xi$ . The phase of the electric field is governed by [44]

$$(6.2) \quad \begin{aligned} S_x^2 + S_y^2 &= n^2(x, y, \xi) \\ S_\xi &= \phi(x, y, \xi; S_x, S_y) \end{aligned}$$

for a real-valued function  $\phi$ , and the dNV hierarchy characterizes both the phase and refractive index.

In [8] hydrodynamic-type reductions of the dNV equation are presented, but the physical interpretation of these reductions are left for future work. Interesting open problems are whether the inclusion of the dispersion terms in the NV equation models EM waves in a manner related to those derived for the dNV equation, and whether either NV or dNV serves as a physical model for any kind of hydrodynamic phenomenon.

**6.2. Exceptional Sets and Large-Time Behavior for the NV Equation.**

Recall that the *exceptional set* of a potential  $q_0$  is the set of all those  $k \in \mathbb{C}$  for which there is not a unique NCGO solution  $\mu(z, k)$ . Here we discuss the relationship between: (1) the "size" of the exceptional set," (2) whether the potential  $q_0$  is subcritical, critical, or supercritical (recall this trichotomy, Definition 1.1 from the introduction) and (3) whether the NV equation with initial data  $q_0$  has a global solution. In these remarks, we will usually restriction attention to real-valued potentials  $q_0$  belonging to the space  $L_\rho^p(\mathbb{R}^2)$  for  $\rho > 1$  and  $p \in (1, 2)$  (see the remarks preceding Definition 1.3); one may think of potentials of order  $\mathcal{O}(|z|^{-2-\varepsilon})$  as  $|z| \rightarrow \infty$ . Recall that, in the inverse scattering literature, critical potentials are usually referred to as "potentials of conductivity type."

To date, the only rigorous results on the size of exceptional sets for the zero-energy NV equation are due to Nachman [59] and Music [55]. As explained above, Nachman showed that a potential is of conductivity type (or, equivalently, a critical potential as defined in the introduction, Definition 1.1) if and only if the exceptional set is empty and the scattering transform  $\mathbf{t}(k)$  is  $\mathcal{O}(|k|^\varepsilon)$  as  $|k| \rightarrow 0$  for some  $\varepsilon > 0$ . Music, extending Nachman's ideas and techniques, showed that a subcritical potential with sufficient decay at infinity has an empty exceptional set and characterized the singularity of the potential as  $|k| \rightarrow 0$ . Perry [66] showed that, if  $q_0$  is a

sufficiently smooth critical potential, the NV equation with initial data  $q_0$  has a solution global in time. There is strong evidence to suggest that a similar result can be proved for the NV equation with subcritical initial data, based on the work of Music [55].

Thus, it remains to understand the singularities of the scattering transform for supercritical potentials. Examples due to Grinevich and Novikov [32] and Music, Perry and Siltanen [57] show that supercritical potentials may have circles of exceptional points. It is not known whether supercritical potentials *must* or *may* have exceptional points, nor is it known how to extend the inverse scattering formalism to potentials with nonempty exceptional sets. The following result due to Brown, Music, and Perry [12] gives an initial constraint on the size of exceptional sets for particularly nice potentials.

**Theorem 6.1.** [12] *Suppose that  $q$  is a real-valued measurable valued function with the property that  $|q(z)| \leq C_1 \exp(-C_2|z|)$  for some constants  $C_1$  and  $C_2$ . Then the exceptional set of  $q$  consists at most of isolated points together with at most finitely many smooth curves with at most finitely many intersections.*

To analyze the exceptional set, the authors define a renormalized determinant whose zero set is exactly the exceptional set. To describe it, let  $T_k$  is the integral operator

$$T_k \psi = \frac{1}{4} g_k * (q\psi).$$

The differential equation for  $\mu(z, k)$ , the NCGO solution, may be rewritten  $\mu = 1 + T_k \mu$ . Hence, uniqueness of solutions is equivalent to invertibility of  $(I - T_k)$ , and the exceptional set is exactly the set of points  $k$  for which  $(I - T_k)$  fails to be invertible. It can be shown that  $T_k$  is a compact linear operator from  $L^p$  to itself for any  $p > 2$ , and that  $T_k$  belongs to the so-called Mikhlín-Itskovich algebra of integral operators on  $L^p$ . For this reason we can apply the theory renormalized determinants due to Gohberg, Goldberg, and Krupnik [23] and define

$$\Delta(k) = \det_2(I - T_k)$$

where the determinant  $\det_2$  is the renormalized determinant. Brown, Music, and Perry show that this determinant is a real-analytic function of  $k$  for exponentially decaying potentials. It now follows from the Weierstrass preparation theorem that the zero set of  $\Delta(k)$  is locally the zero set of a polynomial. Since the exceptional set is known to be closed and bounded, one can completely analyze the behavior of  $\Delta(k)$  near the exceptional set using finitely many such local representations. It can be shown that  $\Delta(k)$  is also real-valued, from which it follows that the zero set has the claimed form.

Theorem 6.1 opens up several areas for further investigation.

First, it would be of considerable interest to determine what additional data is needed to reconstruct a potential from  $\mathbf{t}(k)$  when  $\mathbf{t}(k)$  has point or line singularities.

Second, it would be very interesting to know whether singularities are always present for supercritical potentials, or whether, on the other hand, singularities are generically absent.

Third, our understanding of the NV equation and its dynamics would be greatly improved by connecting ‘spectral’ properties of the scattering transform (i.e., the nature of its singularities) to long-term behavior of solutions. The form of the time evolution for  $\mathbf{t}(k)$  suggests that the ‘trichotomy’ of subcritical, critical, and

supercritical potentials is invariant under the NV flow. It is known that critical initial data give rise to global solutions (see [67]), and there is strong evidence that the same is true of subcritical initial data. On the other hand, numerical experiments such as the ring soliton, Example 4.3, and analytical solutions such as those produced by Taimanov and Tsarev [83, 84, 85, 86] strongly suggest that supercritical initial data lead to solutions of NV that blow up in finite time. It would be very interesting to obtain a rigorous proof that this is the case, and to analyze the nature of the blow-ups by inverse scattering methods.

#### APPENDIX A. SOME USEFUL ANALYSIS

In the direct scattering problem at zero energy, Faddeev's Green's function plays a critical role in elucidating properties of the CGO solutions that define the scattering transform. Recall that the normalized CGO solutions solve the equation

$$\bar{\partial}(\partial + ik)\mu = (1/4)q\mu$$

and that Faddeev's Green's function is Green's function for the operator  $-4\bar{\partial}(\partial + ik)$ . On the other hand, the solid Cauchy transform is an inverse for the  $\bar{\partial}$  operator with range in  $L^p$  functions for  $p > 2$ , and hence is a fundamental tool for solving the  $\bar{\partial}$  problem that defines the inverse scattering transform. Finally, the Beurling transform is an integral operator which gives a meaning to the operator  $\bar{\partial}^{-1}\partial$  that occurs in the definition of the nonlinearity in the NV equation. Here we collect some useful properties of Faddeev's Green's function and the Cauchy and Beurling transforms, and recall some essential estimates.

**A.1. Faddeev's Green's Function at Zero Energy.** We recall some key facts about Faddeev's Green's function  $g_k$ . We refer the reader to Siltanen's thesis [74] for details and references to the literature.

Recall that  $g_k$  is defined by the formula

$$g_k(z) = \frac{1}{(2\pi)^2} \int e^{i\xi \cdot x} \frac{1}{\bar{\xi}(\xi + k)} dm(\xi)$$

where  $z = x_1 + ix_2$ ,  $\xi \cdot x = \xi_1 x_1 + \xi_2 x_2$ ,  $\xi = \xi_1 + i\xi_2$ , and  $\bar{\xi} = \xi_1 - i\xi_2$ . By the Hausdorff-Young inequality,  $g_k \in L^p$  for any  $p > 2$ . In fact, the estimate

$$\|g_k\|_p \leq C_p |k|^{-2/p}$$

(see Siltanen [74], Theorem 3.10) holds for any  $k \neq 0$ . It is important to note that

$$g_k(z) = g_1(kz).$$

The following large- $x$  asymptotic expansion of  $g_1(x)$  is proved in [74], Theorem 3.11.

**Lemma A.1.** *Let  $z = x_1 + ix_2$  with  $z \neq 0$  and  $x_1 > 0$ . For any integer  $N \geq 0$ ,*

$$(A.1) \quad g_1(z) = -\frac{1}{4\pi} \sum_{j=0}^N \left[ \frac{j!}{(iz)^{j+1}} - e^{-2ix_1} \frac{j!}{(-i\bar{z})^{j+1}} \right] + E_N(z)$$

where

$$(A.2) \quad |E_N(z)| \leq \frac{(N+1)! 2^{(N+1)/2}}{\pi |z|^{N+2}}.$$



Since  $g(-x_1 + ix_2) = \overline{g_1(x_1 + ix_2)}$ , similar formulas hold for  $x_1 < 0$ .

*Remark A.2.* Since the error estimate (A.2) does not depend on the condition  $x_1 > 0$ , and since  $g_1(z)$  is continuous, we can conclude that the expansion (A.1) remains valid for  $z \neq 0$  and  $\operatorname{Re}(z) = 0$ .

Now consider  $g_k(z) = g_1(kz)$ . Since  $\operatorname{Re}(kz) = \frac{1}{2}(kz + \bar{k}\bar{z})$ , we immediately obtain:

**Lemma A.3.** *Let  $z = x_1 + ix_2$  and  $k \in \mathbb{C}$ . For any integer  $N \geq 0$ , the expansion*

$$(A.3) \quad g_k(z) = -\frac{1}{4\pi} \sum_{j=0}^N \left[ \frac{j!}{(ikz)^{j+1}} - e^{-i(kz + \bar{k}\bar{z})} \frac{j!}{(-i\bar{k}\bar{z})^{j+1}} \right] + E_N(kz)$$

holds, where

$$|E_N(kz)| \leq C_N |kz|^{-(N+2)}.$$

The small- $k$  behavior of Fadeev's Green's function also plays an important role in the analysis of NCGO solutions. Let

$$G_0(z) = -\frac{1}{2\pi} \log |z|$$

be the logarithmic potential, and let

$$\ell(k) = \frac{1}{2\pi} (\log |k| + \gamma)$$

where  $\gamma$  is the Euler constant. Finally let

$$\tilde{g}_k(z) = g_k(z) + \ell(z).$$

Nachman [59, Lemma 3.4] proves:

**Lemma A.4.** *For any  $\varepsilon \in (0, 1)$ , all  $k \in \mathbb{C}$  with  $0 < |k| < 1/2$ , and a positive constant  $C_\varepsilon$ , the estimate*

$$|\tilde{g}_k(z) - G_0(z)| \leq C_\varepsilon |k|^\varepsilon \langle z \rangle^\varepsilon$$

holds.

**A.2. The Cauchy Transform and the Beurling Operator.** Following [2], chapter 4, we study the Cauchy transform and the Beurling operator through the logarithmic potential associated with Poisson's equation in two dimensions. For  $\varphi \in \mathcal{C}_0^\infty(\mathbb{R}^2)$ , we may define the logarithmic potential

$$(L\varphi)(z) = \frac{2}{\pi} \int \log |z - z'| \varphi(z') dm(z')$$

which has the property

$$\partial\bar{\partial}(L\varphi) = \varphi.$$

Associated to  $L$  are the *Cauchy transform*,

$$(P\varphi)(z) = \frac{\partial}{\partial z}(L\varphi)(z),$$

the transform

$$(\bar{P}\varphi)(z) = \frac{\partial}{\partial \bar{z}}(L\varphi)(z),$$

and the *Beurling transform*

$$(\mathcal{S}\varphi)(z) = \frac{\partial^2}{\partial z^2}(L\varphi)(z).$$

From these definitions and (3.2), it is easy to see that

$$(A.4) \quad P \circ \frac{\partial}{\partial \bar{z}} = \frac{\partial}{\partial \bar{z}} \circ P = I$$

where  $I$  is the identity on  $C_0^\infty(\mathbb{R}^2)$ , and

$$(A.5) \quad \mathcal{S} \left( \frac{\partial \varphi}{\partial \bar{z}} \right) = \frac{\partial \varphi}{\partial z}.$$

We have

$$(P\varphi)(z) = \frac{1}{\pi} \int \frac{1}{z-z'} \varphi(z') \, dm(z'),$$

$$(\bar{P}\varphi)(z) = \frac{1}{\pi} \int \frac{1}{\overline{z-z'}} \varphi(z) \, dm(z'),$$

and

$$(A.6) \quad (\mathcal{S}\varphi)(z) = -\frac{1}{\pi} \lim_{\varepsilon \downarrow 0} \left( \int_{|z-z'| > \varepsilon} \frac{1}{(z-z')^2} \varphi(z') \, dm(z') \right).$$

**A.2.1. Estimates on the Cauchy Transform.** . The following estimates on  $P$  extend the Cauchy transform to  $L^p$  spaces and are standard consequences of the Hardy-Littlewood-Sobolev and Hölder inequalities (see Vekua [91] or [2], §4.3). They are used to prove existence and uniqueness of solutions to the  $\bar{\partial}$  problem that defines the inverse problem.

**Lemma A.5.** (i) For any  $p \in (2, \infty)$  and  $f \in L^{2p/(p+2)}(\mathbb{R}^2)$ ,

$$(A.7) \quad \|Pf\|_p \leq C_p \|f\|_{2p/(p+2)}.$$

(ii) For any  $p, q$  with  $1 < q < 2 < p < \infty$  and any  $f \in L^p(\mathbb{R}^2) \cap L^q(\mathbb{R}^2)$ , the estimate

$$(A.8) \quad \|Pf\|_\infty \leq C_{p,q} \|f\|_{L^p \cap L^q}$$

holds. Moreover,  $P$  is Hölder continuous of order  $(p-2)/p$  with

$$(A.9) \quad |(Pf)(z) - (Pf)(w)| \leq C_p |z-w|^{(p-2)/p} \|f\|_p.$$

(iii) If  $v \in L^s(\mathbb{R}^2)$  and  $q > 2$  with  $q^{-1} + 1/2 = p^{-1} + s^{-1}$ , then for any  $f \in L^p(\mathbb{R}^2)$ ,

$$(A.10) \quad \|P(vf)\|_q \leq C_{p,q} \|v\|_s \|f\|_p.$$

*Remark A.6.* Since  $C_0^\infty(\mathbb{R}^2)$  is dense in  $L^p \cap L^q$  and  $(Pf)(z) = \mathcal{O}(z^{-1})$  as  $|z| \rightarrow \infty$  for any  $f \in C_0^\infty(\mathbb{R}^2)$ , it follows from (ii) that if  $f \in L^p \cap L^q$  for  $1 < p < 2 < q < \infty$ , then  $Pf \in C_0(\mathbb{R}^2)$ , the continuous functions that vanish at infinity.

*Remark A.7.* Note that with  $s = q$  in (A.10) we have

$$\|P(vf)\|_p \leq C_p \|v\|_2 \|f\|_p.$$

For any  $f \in L^{2p/(p+2)}(\mathbb{R}^2)$ , Lemma A.5 together with (A.4) imply that  $u = Pf$  solves  $\bar{\partial}u = f$  in distribution sense. Suppose, on the other hand, that  $u \in L^p(\mathbb{R}^2)$  for some  $p \in [1, \infty)$  and  $\bar{\partial}u = 0$  in distribution sense. It follows that  $\partial\bar{\partial}u = 0$  in distribution sense, so that  $u \in C^\infty$  by Weyl's lemma. Thus,  $u$  is actually holomorphic, so  $u$  vanishes identically by Liouville's Theorem. From this fact and (A.4), we deduce:

**Lemma A.8.** *Suppose that  $p \in (2, \infty)$ , that  $u \in L^p(\mathbb{R}^2)$ , that  $f \in L^{2p/(p+2)}(\mathbb{R}^2)$ , and that  $\bar{\partial}u = f$  in distribution sense. Then  $u = Pf$ . Conversely, if  $f \in L^{2p/(p+2)}(\mathbb{R}^2)$  and  $u = Pf$ , then  $\bar{\partial}u = f$  in distribution sense.*

The following expansion for solutions of  $\bar{\partial}u = f$  when  $f$  is rapidly decaying gives rise to the large- $k$  asymptotic expansion for  $\mu(z, k)$ .

**Lemma A.9.** *Suppose that  $p \in (2, \infty)$ , that  $u \in L^p(\mathbb{R}^2)$ , that  $f \in L^{2p/(p+2), N}(\mathbb{R}^2)$ , and that  $\bar{\partial}u = f$ . Then*

$$z^N \left[ u(z) - \sum_{j=0}^{N-1} \frac{1}{z^{j+1}} \int \zeta^j f(\zeta) dm(\zeta) \right] \in L^p(\mathbb{R}^2).$$

*Proof.* An immediate consequence of the estimate (A.7), Lemma A.8 and the formula

$$\frac{1}{z - \zeta} = \frac{1}{z} \sum_{j=0}^{N-1} \left( \frac{\zeta}{z} \right)^j + \frac{1}{z^N} \frac{\zeta^N}{z - \zeta}.$$

□

**A.2.2. A Generalized Liouville's Theorem.** The following analogue of Liouville's Theorem plays a fundamental role in the theory of  $\bar{\partial}$ -problems such as those used to define the inverse scattering map for the NV equation. The version cited here is due to Brown and Uhlmann [13]. A slightly more general result that plays an important role in the study of the NV equation with subcritical initial data may be found in [55].

**Theorem A.10.** [13, Corollary 3.11] *Suppose that  $p \in [1, \infty)$  and that  $u \in L^p(\mathbb{R}^2) \cap L^2_{loc}(\mathbb{R}^2)$  is a weak solution of*

$$\bar{\partial}u = au + b\bar{u}$$

*with coefficients  $a, b \in L^2(\mathbb{R}^2)$ . Then  $u = 0$ .*

*Remark A.11.* If  $f \in \mathcal{S}(\mathbb{R}^2)$  and depends smoothly on parameters, then the asymptotic expansion holds pointwise and is differentiable in the parameters.

**A.2.3. The Beurling Transform.** The principal value integral (A.6) identifies  $\mathcal{S}$  as a Calderón-Zygmund type integral operator. We have (see, for example, [2], §4.5.2):

**Lemma A.12.** *Suppose that  $p \in (1, \infty)$ . The operator  $\mathcal{S}$  extends to a bounded operator from  $L^p(\mathbb{R}^2)$  to itself, unitary if  $p = 2$ . Moreover, if  $\nabla\varphi$  belongs to  $L^p(\mathbb{R}^2)$  for  $p \in (1, \infty)$ , then  $\mathcal{S}(\partial\varphi) = \bar{\partial}\varphi$ .*

## REFERENCES

- [1] Angelopoulos, Y. Well-posedness and ill-posedness results for the Novikov-Veselov equation. Preprint, [arXiv:1307.4110](https://arxiv.org/abs/1307.4110) [Math.AP].
- [2] Astala, K., Iwaniec, T., Martin, G. *Elliptic partial differential equations and quasiconformal mappings in the plane*. Princeton Mathematical Series, **48**. Princeton University Press, Princeton, NJ, 2009.
- [3] Astala, K., Päivärinta, L. Calderón's inverse conductivity problem in the plane. *Ann. of Math. (2)* **163** (2006), no. 1, 265–299.
- [4] Athorne, C, Nimmo, J. J. C. On the Moutard transformation for integrable partial differential equations *Inverse Problems* **7** (1991), no. 6, 809.
- [5] Beals, R.; Coifman, R. R. Linear spectral problems, nonlinear equations and the  $\bar{\partial}$ -method. *Inverse Problems* **5** (1989), no. 2, 87–130.
- [6] Bogdanov, L. V. The Veselov-Novikov equation as a natural generalization of the Korteweg-de Vries equation. *Teoret. Mat. Fiz.* **70** (1987), no. 2, 309–314. English translation: *Theoret. and Math. Phys.* **70** (1987), no. 2, 219–223.
- [7] Bogdanov, L. V. On the two-dimensional Zakharov-Shabat problem. *Teoret. Mat. Fiz.* **72** (1987), no. 1, 155–159. English translation: *Theoret. and Math. Phys.* **72**(1987), no. 1, 790–793.
- [8] Bogdanov, L. V., Konopelchenko, B. G., Moro, A. Symmetry constraints for real dispersionless Veselov-Novikov equation. *Journal of Mathematical Sciences* **136** (2006) no. 6, 4411–4418.
- [9] Boiti, M., Leon, J. P., Manna, M., Pempinelli, F. On a spectral transform of a KdV-like equation related to the Schrödinger operator in the plane. *Inverse Problems* **3** (1987), 25–36.
- [10] Bourgain, J. Fourier transform restriction phenomena for certain lattice subsets and applications to nonlinear evolution equations. II. The KdV-equation. *Geom. Funct. Anal.* **3** (1993), no. 3, 209262.
- [11] Bourgain, J. On the Cauchy problem for the Kadomtsev-Petviashvili equation. *Geom. Funct. Anal.* **3** (1993), no. 4, 315341.
- [12] Brown, R. M.; Music, M. E.; Perry, P. Determinants and Inverse Scattering in Two Dimensions, I: Linear Systems for the Davey-Stewartson and Novikov-Veselov Equations. In preparation.
- [13] Brown, R. M., Uhlmann, G. A. Uniqueness in the inverse conductivity problem for nonsmooth conductivities in two dimensions. *Comm. Partial Differential Equations* **22** (1997), no. 5-6, 1009–1027.
- [14] Calderón, A. P. On an inverse boundary value problem. Seminar on Numerical Analysis and Its Applications to Continuum Physics. Soc. Brasileira de Matemática (1980), 65–73.
- [15] Cole, K. S., Cole, R. H. Dispersion and absorption in dielectrics. *J. Chem. Phys.*, **9** (1941), 341–351.
- [16] Croke, R. P., Mueller, J. L., Stahel, A. Transverse instability of plane wave soliton solutions of the Novikov-Veselov equation, Preprint (2013).
- [17] Croke, R.P. An investigation of the Novikov-Veselov equation: new solutions, stability and implications for the inverse scattering transform, PhD thesis, Colorado State University, 2012.
- [18] Dubrovsky, V. G, Formusatik, I. B. New lumps of Veselov-Novikov integrable nonlinear equation and new exact rational potentials of two-dimensional stationary Schrödinger equation via  $\bar{\partial}$ -dressing method *Physics Letters A* **313** (2003), 68–76.
- [19] El-Wakil, S. A., Abdou, M. A. Modified extended tanh-function method for solving nonlinear partial differential equations. *Chaos, Solitons & Fractals*, **31** (2007) no. 5, 1256–1264
- [20] Faddeev, L. D. Increasing solutions of the Schrödinger equation, *Dokl. Akad. Nauk SSSR*, **165** (1965), 514–517 (English translation: *Sov. Phys. Dokl.* **10** (1966), 1033–1035).
- [21] Ferapontov, E. V. Stationary Veselov-Novikov equation and isothermally asymptotic surfaces in projective differential geometry, *Differential geometry and its applications*, **11** (1999), 117–128.
- [22] Gesztesy, F., Zhao, Z. On positive solutions of critical Schrödinger operators in two dimensions. *J. Funct. Anal.* **127** (1995), no. 1, 235–256.
- [23] Gohberg, I., Goldberg, S., Krupnik, N. *Traces and determinants of linear operators. Operator Theory: Advances and Applications*, **116**. Birkhäuser Verlag, Basel, 2000.

- [24] Grinevich, P. G. Rational solitons of the Veselov-Novikov equations are reflectionless two-dimensional potentials at fixed energy. *Teoret. Mat. Fiz.* **69** (1986), no. 2, 307–310.
- [25] Grinevich, P. G. The scattering transform for the two-dimensional Schrödinger operator with a potential that decreases at infinity at fixed nonzero energy. *Uspekhi Mat. Nauk* **55** (2000), no. 6(336), 3–70; translation in *Russian Math. Surveys* **55** (2000), no. 6, 1015–1083.
- [26] Grinevich, P. G., Manakov, S. V. Inverse problem of scattering theory for the two-dimensional Schrödinger operator, the  $\bar{\partial}$ -method and nonlinear equations. *Funktsional. Anal. i Prilozhen.* **20** (1986), no. 2, 14–24, 96. English translation: *Functional Anal. Appl.* **20** (1986), no. 2, 94–103.
- [27] Grinevich, P. G., Novikov, R. G. Analogues of multisoliton potentials for the two-dimensional Schrödinger operator. *Funktsional. Anal. i Prilozhen.* **19** (1985), no. 4, 32–42, 95. English translation: *Functional Anal. Appl.* **19** (1985), no. 4, 276–285.
- [28] Grinevich, P. G., Novikov, R. G. Analogues of multisoliton potentials for the two-dimensional Schrödinger operator, and a nonlocal Riemann problem. *Dokl. Akad. Nauk SSSR* **286** (1986), no. 1, 19–22. English translation: *Soviet Math. Dokl.* **33** (1986), no. 1, 9–12.
- [29] Grinevich, P. G., Novikov, S. P. Inverse scattering problem for the two-dimensional Schrödinger operator at a fixed negative energy and generalized analytic functions. *Plasma theory and nonlinear and turbulent processes in physics, Vol. 1, 2* (Kiev, 1987), 58–85, World Sci. Publishing, Singapore, 1988.
- [30] Grinevich, P. G., Novikov, S. P. A two-dimensional “inverse scattering problem” for negative energies, and generalized-analytic functions. I. Energies lower than the ground state. *Funktsional. Anal. i Prilozhen.* **22** (1988), no. 1, 23–33, 96; translation in *Funct. Anal. Appl.* **22** (1988), no. 1, 19–27.
- [31] Grinevich, P. G., Novikov, R. G. Transparent potentials at fixed energy in dimension two. Fixed-energy dispersion relations for the fast decaying potentials. *Comm. Math. Phys.* **174** (1995), no. 2, 409–446.
- [32] Grinevich, P. G., Novikov, R. G. Faddeev eigenfunctions for point potentials in two dimensions. *Physics Letters A* **376**(2012),11021106.
- [33] Hirota, R. Exact  $N$ -soliton solutions of the wave equation of long waves in shallow-water and in nonlinear lattices. *J. Math. Phys.* **14** (1973) 810–814.
- [34] Hu, H.-C., Lou, S.-Y., Liu, Q.-P. Darboux transformation and variable separation approach: the Nizhnik-Novikov-Veselov equation *Chinese Physics Letters* **20** (2003) no. 9, 1413–1415.
- [35] Hu, X.-B., Willox, R. Some new exact solutions of the Novikov–Veselov equation. *Journal of Physics A: Mathematical and General* **29** (1996), no. 15, 4589.
- [36] Kazeykina, A. V. Examples of the nonexistence of a traveling wave for the generalized Korteweg-de Vries-Burgers equation. (Russian) *Vestnik Moskov. Univ. Ser. XV Vychisl. Mat. Kibernet.* 2011, no. 1, 17–24, 56; translation in *Moscow Univ. Comput. Math. Cybernet.* **35** (2011), no. 1, 14–21.
- [37] Kazeykina, A. V. A large-time asymptotics for the solution of the Cauchy problem for the Novikov-Veselov equation at negative energy with non-singular scattering data. *Inverse Problems* **28** (2012), no. 5, 055017.
- [38] Kazeykina, A. V. Solitons and large time asymptotics for solutions of the Novikov-Veselov equation. Thèse, École Polytechnique, 2012. Thesis available online at <http://hal.archives-ouvertes.fr/docs/00/76/26/62/PDF/these.pdf>
- [39] Kazeykina, A. V., Novikov, R. G. Large time asymptotics for the Grinevich-Zakharov potentials. *Bull. Sci. Math.* **135** (2011), no. 4, 374–382.
- [40] Kazeykina, A. V., Novikov, R. G. Absence of exponentially localized solitons for the Novikov-Veselov equation at negative energy. *Nonlinearity* **24** (2011), no. 6, 1821–1830.
- [41] Kazeykina, A. V., Novikov, R. G. A large time asymptotics for transparent potentials for the Novikov-Veselov equation at positive energy. *J. Nonlinear Math. Phys.* **18** (2011), no. 3, 377–400.
- [42] Knudsen, K., Lassas, M., Mueller, J. L., Siltanen, S. Regularized D-bar method for the inverse conductivity problem. *Inverse Probl. Imaging* **3** (2009), no. 4, 599624.
- [43] Knudsen, K. Mueller, J., Siltanen, S., Numerical solution method for the dbar-equation in the plane, *Journal of Computational Physics*, **198** (2004), pp. 500–517.
- [44] Konopelchenko, B. G., Moro, A. Geometrical optics in nonlinear media and integrable equations *J. Phys. A: Math. Gen.*, **37** (2004), L105–L111.

- [45] Lassas, M., Mueller, J. L., Siltanen, S. Mapping properties of the nonlinear Fourier transform in dimension two. *Comm. Partial Differential Equations* **32** (2007), no. 4-6, 591–610.
- [46] Lassas, M., Mueller, J. L., Siltanen, S., Stahel, A. The Novikov-Veselov equation and the inverse scattering method, Part I: Analysis. *Phys. D* **241** (2012), no. 16, 1322–1335.
- [47] Lassas, M., Mueller, J. L., Siltanen, S., Stahel, A. The Novikov-Veselov equation and the inverse scattering method: II. Computation. *Nonlinearity* **25** (2012), no. 6, 1799–1818.
- [48] Lou, S.-Y., Ni, G.-J. The relations among a special type of solutions in some  $(D + 1)$ -dimensional nonlinear equations. *J. Math. Phys.* **30** (1989), no. 7 1614–1620.
- [49] Manakov, S. V. The inverse scattering method and two-dimensional evolution equations. *Uspekhi Mat. Nauk* **31** no. 5 (191), 245246.
- [50] Miura, R. M. Korteweg-de Vries equation and generalizations. I. A remarkable explicit nonlinear transformation. *J. Mathematical Phys.* **9** (1968) 1202–1204.
- [51] Mueller, J. M., Siltanen, S. Direct reconstructions of conductivities from boundary measurements, *SIAM Journal on Scientific Computing*, **24** (2003), 1232–1266.
- [52] Mueller, J. L., Siltanen, S. *Linear and nonlinear inverse problems with practical applications*, SIAM, 2012. <http://www.ec-securehost.com/SIAM/CS10.html>
- [53] Murata, M. Positive solutions and large-time behaviors of Schrödinger semigroups, Simon’s problem. *J. Funct. Anal.* **56** (1984), no. 3, 300–310.
- [54] Murata, M. Structure of positive solutions to  $(-\Delta + V)\psi = 0$  in  $\mathbb{R}^n$ . *Duke Math. J.* **53** (1986), no. 4, 869–943.
- [55] Music, M. The nonlinear Fourier transform for two-dimensional subcritical potentials. [arXiv:1312.0567](https://arxiv.org/abs/1312.0567) [Math.AP], submitted to *Inverse Problems and Imaging*, Special Issue on Inverse Problems and Complex Geometrical Optics Solutions.
- [56] Music, M., Perry, P. The Novikov-Veselov Equation with subcritical initial data. *In preparation*.
- [57] Music, M., Perry, P., Siltanen, S. Exceptional Circles of Radial Potentials. *Inverse Problems* **29** (2013), no. 4, 045004.
- [58] Nachman, A. I. Global uniqueness for a two-dimensional inverse boundary value problem, University of Rochester, Dept. of Mathematics Preprint Series, (1993).
- [59] Nachman, A. I. Global uniqueness for a two-dimensional inverse boundary value problem. *Ann. of Math. (2)* **143** (1996), no. 1, 71–96.
- [60] Nickel, J., Serov, V. S., Schurmann, H. W. Some elliptic traveling wave solutions to the Novikov–Veselov equation *Progress In Electromagnetics Research* (2006) **61**, 323–331.
- [61] Nizhnik, L. P. Integration of multidimensional nonlinear equations by the inverse problem method. *Dokl. Akad. Nauk SSSR* **254** (1980), no. 2, 332–335. English translation: *Soviet Phys. Dokl.* **25** (1980), no. 9, 706–708 (1981).
- [62] Novikov, R. G. The inverse scattering problem on a fixed energy level for the two-dimensional Schrödinger operator *J. Funct. Anal.* **103** (1992) (2) 409–63.
- [63] Novikov, R. G. Absence of exponentially localized solitons for the Novikov–Veselov equation at positive energy. *Phys. Lett. A* **375** (2011), 1233–5.
- [64] Novikov, S. P., Veselov, A. P. Two-dimensional Schrödinger operator: inverse scattering transform and evolutional equations. Solitons and coherent structures (Santa Barbara, Calif., 1985). *Phys. D* **18** (1986), no. 1-3, 267–273.
- [65] Ohta, Y. Pfaffian solutions for the Veselov-Novikov equation *J. Phys. Soc. Japan* **61** (1992), no. 11, 3928–3933.
- [66] Perry, P. Global well-posedness and large-time asymptotics for the defocussing Davey-Stewartson II equation in  $H^{1,1}(\mathbb{R}^2)$ . Preprint, [arXiv.math/1110.5589](https://arxiv.org/abs/math/1110.5589) [math.AP], 2011. Submitted to *Journal of Spectral Theory*.
- [67] Perry, P. Miura maps and inverse scattering for the Novikov-Veselov equation. Preprint, [arXiv.math/1201.2385](https://arxiv.org/abs/math/1201.2385) [math.AP]. Submitted to *Analysis and Partial Differential Equations*.
- [68] Rogers, C., Konopelchenko, B. G., Stallybrass, M. P., Schief, W. K. The Nizhnik-Novikov-Veselov equation: associated boundary value problems *Int. J. Non-Linear Mechanics* **31** (1996), no. 4, 441–450.
- [69] Ruan, H.-Y., Chen, Y.-X. Localized coherent structures in  $(2 + 1)$ -dimensional generalized Nizhnik-Novikov-Veselov equations. *J. Phys. Soc. Japan* **70** (2001), no. 6, 1499–1504.
- [70] Ruan, H.-Y., Chen, Y.-X. Interaction between a Line Soliton and a Y-Periodic Soliton in the  $(2 + 1)$ -dimensional Nizhnik-Novikov-Veselov Equation. *Z. Naturforsch* **57a** (2002), 948–954.

- [71] Ruan, H.-Y., Chen, Y.-X. Dromion Interactions of  $(2+1)$ -Dimensional KdV-type Equations. *J. Phys. Soc. Japan* **72** (2003), no. 3, 491–495.
- [72] Saranen, J., Vainikko, G. *Periodic Integral and Pseudodifferential Equations with Numerical Approximation*, Springer, 2002.
- [73] Shingareva, I., Lizarraga-celaya, C. Solving Nonlinear Partial Differential Equations with Maple and Mathematica. *Springer*, (2011).
- [74] Siltanen, S. Electrical impedance tomography and Faddeev Green's functions. *Annales Academiae Scientiarum Fennicae Mathematica Dissertationes*, **121** (1999), p. 56. Dissertation, Helsinki University of Technology, Espoo, 1999.
- [75] Siltanen, S., Mueller, J. M., Isaacson, D. An implementation of the reconstruction algorithm of A. Nachman for the 2D inverse conductivity problem. *Inverse Problems* **16** (2000), no. 3, 681–699. Erratum, *Inverse Problems* **17** (2001), no. 5, 1561–1563.
- [76] Siltanen, S., Tamminen, J. P. Exceptional points of radial potentials at positive energies. [arXiv:1307.2037](https://arxiv.org/abs/1307.2037) [Math.NA].
- [77] Simon, B. Brownian motion,  $L^p$  properties of Schrödinger operators and the localization of binding. *J. Funct. Anal.* **35** (1980), no. 2, 215–229.
- [78] Simon, B. Large time behavior of the  $L^p$  norm of Schrödinger semigroups. *J. Funct. Anal.* **40** (1981), no. 1, 66–83.
- [79] Simon, B. Schrödinger semigroups. *Bull. Amer. Math. Soc. (N.S.)* **7** (1982), no. 3, 447–526. Erratum, *Bull. Amer. Math. Soc. (N.S.)* **11** (1984), no. 2, 426.
- [80] Tagami, Y. Soliton-like solutions to a  $(2+1)$ -dimensional generalization of the KdV equation *Phys. Lett. A* **141** (1989), no. 3–4, 116–120.
- [81] Taïmanov, I. A. Modified Novikov-Veselov equation and differential geometry of surfaces. *Amer. Math. Soc. Transl.*, **179** (1997), no. 2, 133–151.
- [82] Taïmanov, I. A., Tsarëv, S. P. Two-dimensional Schrödinger operators with rapidly decaying rational potential and multidimensional  $L^2$ -kernel. (Russian) *Uspekhi Mat. Nauk* **62** (2007), no. 3 (375), 217–218; translation in *Russian Math. Surveys* **62** (2007), no. 3, 631–633.
- [83] Taïmanov, I. A., Tsarëv, S. P. Blowing up solutions of the Veselov-Novikov equation. (Russian) *Dokl. Akad. Nauk.* **420** (2008), no. 6, 744–745; translation in *Dokl. Math.* **77** (2008), no. 3, 467–468.
- [84] Taïmanov, I. A., Tsarëv, S. P. Two-dimensional rational solitons constructed by means of the Moutard transformations, and their decay. (Russian) *Teoret. Mat. Fiz.* **157** (2008), no. 2, 188–207; translation in *Theoret. and Math. Phys.* **157** (2008), no. 2, 1525–1541.
- [85] Taïmanov, I. A., Tsarëv, S. P. The Moutard transformation: an algebraic formalism via pseudodifferential operators and applications. *Riemann surfaces, harmonic maps, and visualization*, 169–183, *OCAMI Stud.* **3** (2011). Osaka Munic. Univ. Press, 2010.
- [86] Taïmanov, I. A., Tsarëv, S. P. On the Moutard transformation and its applications to spectral theory and soliton equations. *Sovrem. Mat. Fundam. Napravl.* **35** (2010), 101–117. English translation: *J. Math. Sci. (N. Y.)* **170** (2010), no. 3, 371–387.
- [87] Tao, T. Nonlinear dispersive equations. Local and global analysis. *CBMS Regional Conference Series in Mathematics*, **106**. Published for the Conference Board of the Mathematical Sciences, Washington, D.C., by the American Mathematical Society, Providence, RI, 2006.
- [88] Tsai, T.-Y. The Schrödinger operator in the plane. *Inverse Problems* **9** (1993), no. 6, 763–787.
- [89] Üna, I. M. *Applications of Pfaffians to soliton theory*, Ph.D. thesis, University of Glasgow, 1998.
- [90] Vainikko, G. Fast solvers of the Lippmann-Schwinger equation, in Direct and inverse problems of mathematical physics (Newark, DE, 1997), vol. 5 of *Int. Soc. Anal. Appl. Comput.*, Kluwer Acad. Publ., Dordrecht, 2000, pp. 423–440.
- [91] Vekua, I. N. *Generalized analytic functions*. Pergamon Press, London-Paris-Frankfurt; Addison-Wesley Publishing Co., Inc., Reading, Mass. 1962.
- [92] Veselov, A. P., Novikov, S. P. Finite-zone, two-dimensional, potential Schrödinger operators, explicit formulas and evolution equations, *Sov. Math. Dokl.* **30** (1984) 558–591.
- [93] Wazwaz, A. M. Multiple soliton solutions for the  $(2+1)$ -dimensional asymmetric Nizhnik-Novikov-Veselov equation. *Nonlinear Analysis: Theory, Methods & Applications* **72** (2010) no. 3–4, 1314–1318.
- [94] Xia, T. C., Li, B., Zhang, H. Q. New explicit and exact solutions for the Nizhnik-Novikov-Veselov equation *Appl. Math. E-Notes* **1** (2001) 139–142.

- [95] Zhang, J.-F. Homogeneous balance method and chaotic and fractal solutions for the Nizhnik-Novikov–Veselov equation *Physics Letters A* **313**, (2003), 401–407.
- [96] Zheng, C.-L., Fang, J.-P., Chen, L.-Q. New variable separation excitations of  $(2 + 1)$ -dimensional dispersive long-water wave system obtained by an extended mapping approach. *Chaos, Solitons & Fractals* **23** (2005) no. 5, 1741–1748.
- [97] Zheng, C.-L., Zhu, H.-P., Chen, L.-Q. Exact solution and semifolded structures of generalized Broer-Kaup system in  $(2+1)$ -dimensions. *Chaos, Solitons & Fractals* **26** (2005) no. 1, 187–194.

DEPARTMENT OF APPLIED MATHEMATICS, UNIVERSITY OF COLORADO, BOULDER, COLORADO, 80309-0526

*E-mail address:* ryan.croke@colorado.edu

DEPARTMENT OF MATHEMATICS, COLORADO STATE UNIVERSITY, FORT COLLINS, COLORADO, 80523-1874, U. S. A.

*E-mail address:* mueller@math.colostate.edu

DEPARTMENT OF MATHEMATICS, UNIVERSITY OF KENTUCKY, LEXINGTON, KENTUCKY 40506-0027, U. S. A.

*E-mail address:* Michael.Music@uky.edu

DEPARTMENT OF MATHEMATICS, UNIVERSITY OF KENTUCKY, LEXINGTON, KENTUCKY 40506-0027, U. S. A.

*E-mail address:* Peter.Perry@uky.edu

DEPARTMENT OF MATHEMATICS AND STATISTICS, P.O. Box 68, FI-00014 UNIVERSITY OF HELSINKI

*E-mail address:* samuli.siltanen@helsinki.fi

BERN UNIVERSITY OF APPLIED SCIENCES, ENGINEERING AND INFORMATION TECHNOLOGY, MATHEMATICS, BFH-TI BIEL, POSTFACH CH-2501 BIEL, SWITZERLAND

*E-mail address:* Andreas.Stahel@bfh.ch