

GARSIDE-THEORETIC ANALYSIS OF BURAU REPRESENTATIONS

MATTHIEU CALVEZ AND TETSUYA ITO

ABSTRACT. We establish relations between both the classical and the dual Garside structures of the braid group and the Burau representation. Using the classical structure, we formulate a non-vanishing criterion for the Burau representation of the 4-strand braid group. In the dual context, it is shown that the Burau representation for arbitrary braid index is injective when restricted to the set of *simply-nested braids*.

1. INTRODUCTION

The (reduced) *Burau representation*

$$\rho_n : B_n \longrightarrow \mathrm{GL}(n-1, \mathbb{Z}[q^{\pm 1}])$$

was the first possible candidate for a faithful linear representation of the braid group on n strands B_n and it has been known for long to be faithful in the case of the 3-strand braid group [MP]. However, Moody [Mo] showed that the Burau representation is not faithful for any braid index $n \geq 9$. This was brought down to $n \geq 6$ by Long and Paton [LP] and finally Bigelow showed the non-faithfulness of ρ_5 [Bi]. Despite these negative results, the linearity question of the braid groups was settled in the positive independently by Krammer [Kra] and Bigelow [Bi2]. They showed that another linear representation

$$\mathcal{L}_n : B_n \longrightarrow \mathrm{GL}\left(\frac{n(n-1)}{2}, \mathbb{Z}[q^{\pm 1}, t^{\pm 1}]\right)$$

constructed by Lawrence [Law] is faithful for all n . The representation \mathcal{L}_n is now known as the *Lawrence-Krammer-Bigelow representation*, or LKB representation for short.

At present, the question of the faithfulness of the Burau representation in the case $n = 4$ remains open. The linearity question itself was solved, nevertheless the problem to determine whether ρ_4 is faithful or not remains of considerable importance: a negative answer would be of great interest in quantum topology, since it is equivalent to the non-faithfulness of Jones and Temperley-Lieb representations of B_4 , and would provide a non-trivial knot with trivial Jones polynomial [Bi3]. Another interesting related problem is to study the image of the Burau representation – an old question asks which $(n-1) \times (n-1)$ matrices over $\mathbb{Z}[q^{\pm 1}]$ can appear as the image under the (reduced) Burau representation of some braid [Bir]; it is widely open.

The present paper aims to establish relations between the Garside structures of the braid group and the Burau representation. Our motivation was to understand to what extent the Burau representation is close to be faithful, and when faithfulness property breaks down. This not only helps to attack the faithfulness problem of the 4-strand Burau representation, but also provides new insights for the image and the kernel of the Burau representation for arbitrary braid index, even for the simplest case $n = 3$ (see Corollary 6.11 below).

The *classical Garside structure* consists in a lattice structure together with a special element Δ satisfying some properties initially discovered by Garside in [Gar]. A crucial output of this

2010 *Mathematics Subject Classification*. Primary 20F36 , Secondary 20F10,57M07,20G42.

Key words and phrases. Burau representation, Braid group, Garside structure, curve diagram.

structure is the *classical (left) normal form* of a braid x , which is a unique decomposition of the form

$$N_c(x) = \Delta^p s_1 \cdots s_r$$

in which the factors belong to the set of the so-called *simple elements*. The *classical supremum* and *infimum* of x are defined by $\sup_c(x) = p + r$, $\inf_c(x) = p$, respectively. The *classical canonical length* of x is defined by $\ell_c(x) = r$; the *classical Garside length* $l_c(x)$ is the length of x with respect to the simple elements. The latter satisfies $l_c(x) = \max(\sup_c(x), 0) - \min(\inf_c(x), 0)$.

Slightly different but very close in spirit is the *dual Garside structure* (or BKL structure) discovered by Birman, Ko and Lee [BKL] which leads to the *dual (left) normal form* of a braid x :

$$N_d(x) = \delta^p d_1 \cdots d_r$$

where the factors belong to the set of the so-called *dual simple elements*. The *dual supremum*, *infimum* and *canonical length* of a braid x are defined similarly and denoted by $\sup_d(x)$, $\inf_d(x)$ and $l_d(x)$ respectively. The *dual Garside length* $l_d(x)$ is the length of x with respect to the dual simple elements; it satisfies $l_d(x) = \max(\sup_d(x), 0) - \min(\inf_d(x), 0)$. See Section 2 for more details on both classical and dual Garside structures of the braid group.

Our first main result provides a non-vanishing criterion for the Burau representation ρ_4 using the classical Garside structure.

Theorem 3.4. *If the classical left normal form of a 4-braid x does not contain a factor $(\sigma_2\sigma_1\sigma_3)$ then $\rho_4(\beta) \neq 1$.*

In the dual framework, we obtain more general and strong connections. For a non-zero Laurent polynomial Λ in the variable q , let us denote by $m(\Lambda)$ and $M(\Lambda)$ the minimal and maximal degrees of the variable, respectively. As a convention, we define $m(0) = +\infty$ and $M(0) = -\infty$.

For a matrix $\Lambda = (\Lambda_{ij}) \in GL(n-1, \mathbb{Z}[q^{\pm 1}])$, we set

$$m(\Lambda) = \min\{m(\Lambda_{ij}), 1 \leq i, j \leq n-1\}, \text{ and } M(\Lambda) = \max\{M(\Lambda_{ij}), 1 \leq i, j \leq n-1\}.$$

In Section 6 we will introduce a notion of *simply-nested* braid; roughly speaking, simply-nestedness is a local condition on the factors of the dual left normal form of a braid. We will show that the Burau representation completely determines the normal form of simply-nested braids.

Theorem 6.1. *Let $x \in B_n$ be a simply-nested braid.*

- (i) $\sup_d(x) = M(\rho_n(x))$.
- (ii) *One can compute the dual normal form from the matrix $\rho_n(x)$, so the restriction of the Burau representation on the set of simply-nested braid B_n^{sn} is injective.*

This provides several consequences for faithfulness questions in general. First of all, it follows that the Burau matrix of a 3-strand braid completely determines its dual normal form.

Corollary 6.11. *Let $x \in B_3$. Then*

- (i) $\sup_d(x) = M(\rho_3(x))$,
- (ii) $\inf_d(x) = m(\rho_3(x))$.
- (iii) *One can compute the dual normal form of x from the matrix $\rho_3(x)$.*

For the 4-strand braid group, we will see:

Corollary 6.12. *Let $x \in B_4$ and $N_d(x) = \delta^p d_1 \cdots d_r$. Assume that for all $i = 1, \dots, r-1$, (d_i, d_{i+1}) is not in the following list:*

$$\left\{ \begin{array}{l} (a_{1,2}a_{3,4}, a_{2,4}), (a_{1,2}a_{3,4}, a_{3,4}a_{2,3}), (a_{1,2}a_{3,4}, a_{1,2}a_{1,4}), \\ (a_{2,3}a_{1,4}, a_{1,3}), (a_{2,3}a_{1,4}, a_{1,3}a_{2,3}), (a_{2,3}a_{1,4}, a_{1,3}a_{1,4}) \end{array} \right\}$$

Then

- (i) $\sup_{\mathfrak{d}}(x) = M_q(\rho_4(x))$,
- (ii) one can compute the dual normal form of x from the matrix $\rho_4(x)$.

In particular, if the dual left normal form of a 4-braid x does not contain a factor $(a_{1,2}a_{3,4})$ or $(a_{2,3}a_{1,4})$ then $\rho_4(\beta) \neq 1$.

Finally we give Garside-theoretical constraints for braids of arbitrary braid index to belong to the kernel of the Burau representation. Let $e : B_n \rightarrow \mathbb{Z}$ be the abelianization map.

Corollary 6.13. *Let $x \in B_n$ be a non-trivial braid and $N_{\mathfrak{d}}(x) = \delta^p d_1 \cdots d_r$. If there exists $r' \leq r$ such that*

- (i) *The subword $x_{r'} = \delta^p d_1 \cdots d_{r'}$ is simply-nested,*
- (ii) *$r' > e(d_{r'+1} \cdots d_r)$,*

then $\rho_n(x) \neq 1$.

Thus, we conclude that if a braid x is sufficiently close to simply nested braids, then its Burau matrix is never trivial.

Now we explain the organization of the paper. In section 2 we recall Garside theoretical notions to be used later. Section 3 shows Theorem 3.4. Sections 4-6 are devoted to the proof of Theorem 6.1. This can be sketched as follows. First we recall from [IW] the wall-crossing labeling of the curve diagram of a braid and how it is related to the dual Garside normal form (Section 4). Section 5 reviews a homological interpretation of the reduced Burau representation; in this context we show how the Burau matrix is related to the wall-crossing labeling. Wall-crossing labeling therefore serves as a bridge between Burau representation and the dual Garside structure. Finally, Section 6 introduces the notion of simply-nestedness and proves Theorem 6.1 and its above mentioned corollaries.

2. REMINDERS ON THE GARSIDE STRUCTURES OF BRAID GROUPS

Let \mathbb{D}^2 be the closed disk in \mathbb{C} with diameter the real segment $[0, n+1]$ and \mathbb{D}_n be the n -times punctured disk: $\mathbb{D}_n = \mathbb{D}^2 - \{1, \dots, n\}$. We denote the i -th puncture point $i \in \mathbb{C}$ by p_i and put $p_0 = 0 \in \mathbb{C}$. As is well-known, the braid group B_n is identified with the mapping class group of \mathbb{D}_n (with boundary fixed pointwise). We identify the standard Artin generator σ_i ($i = 1, \dots, n-1$) with the *left-handed* (that is, *clockwise*) half Dehn twist along the real segment $[i, i+1]$. Throughout the paper we will consider braids acting on the *right*.

For $1 \leq i \neq j \leq n$, we denote by $a_{i,j}$ (or $a_{j,i}$ indifferently) the isotopy class of the left-handed half Dehn twist along an arc connecting the punctures p_i and p_j through the lower part of the disk $\{z \in \mathbb{D}^2 \mid \text{Im } z < 0\}$. Using the Artin generators, $a_{i,j}$ ($i < j$) can be written as

$$a_{i,j} = (\sigma_{j-2} \cdots \sigma_{i+1} \sigma_i)^{-1} \sigma_{j-1} (\sigma_{j-2} \cdots \sigma_{i+1} \sigma_i).$$

2.1. The classical Garside structure. Let B_n^+ be the monoid of *positive braids*, i.e. those braids which can be expressed as words on the letters σ_i with only positive exponents. Since the works of Garside [Gar], Thurston [ECHLPT], and ElRifai and Morton [EM], it is well-known that the monoid B_n^+ induces a lattice order \leq_c on B_n called the *prefix order*, through the relation $x \leq_c y$ if and only if $x^{-1}y \in B_n^+$.

The positive left-divisors (with respect to \leq_c) of the half-twist of all strands

$$\Delta = (\sigma_1 \sigma_2 \cdots \sigma_{n-1}) \cdots (\sigma_1 \sigma_2) (\sigma_1)$$

are finitely many and generate the group B_n . These are called *simple elements* (or *positive permutation braids*, because they are in one-to-one correspondence with the symmetric group on n objects). Simple elements have been extensively studied in [EM], where a nice geometric description of them is given: a positive braid x is a simple element if and only if each pair of

strands in x has at most one crossing. The pair (B_n^+, Δ) is generally called *classical (usual) Garside structure* of the braid group.

An ordered pair of two simple elements (s, s') is said to be *left-weighted* if $\Delta \wedge_c (ss') = s$, where \wedge_c denotes the greatest common divisor with respect to the lattice ordering \leq_c .

Proposition-Definition 2.1. [EM] *Let $x \in B_n$. There exists a unique decomposition of x of the form*

$$N_c(x) = \Delta^p s_1 \cdots s_r,$$

where $p \in \mathbb{Z}$ and s_1, \dots, s_r are simple elements with $s_1 \neq \Delta, s_r \neq 1$ such that (provided $r \geq 2$) for each $i = 1, \dots, r-1$, the pair (s_i, s_{i+1}) is left-weighted. We call $N_c(x)$ the *classical (left) normal form* of x .

The notion of left-weightedness for the usual Garside structure is understood as follows. The *starting set* and the *finishing set* of a simple element s are defined by

$$S(s) = \{i \in \{1, \dots, n-1\} \mid \sigma_i^{-1} s \in B_n^+\},$$

$$F(s) = \{i \in \{1, \dots, n-1\} \mid s \sigma_i^{-1} \in B_n^+\},$$

respectively. In terms of crossings of braid diagrams, $i \in S(x)$ ($i \in F(x)$, respectively) if and only if the strands numbered i and $i+1$ at the beginning of x (at the end of x , respectively) do cross in x .

Proposition 2.2. [EM] *An ordered pair of two simple elements (s, s') is left-weighted if and only if $S(s') \subset F(s)$.*

Thus, in terms of crossings the left-weightedness condition says that no crossing σ from s' can be moved to s in such a way that $s\sigma$ is still simple.

2.2. The dual Garside structure. Let B_n^{+*} be the *monoid of dual positive braids*, generated by positive powers of all elements in the family $\{a_{i,j}\}_{1 \leq i < j \leq n}$ and $\delta = \sigma_{n-1} \cdots \sigma_2 \sigma_1$ be the braid corresponding to the clockwise rotation of all strands by one notch.

Birman, Ko and Lee [BKL] showed that (B_n^{+*}, δ) is another Garside structure for the braid group. In particular the monoid B_n^{+*} induces a lattice order on B_n , which we denote by \leq_d ($x \leq_d y \Leftrightarrow x^{-1}y \in B_n^{+*}$) and the dual positive divisors of δ (with respect to \leq_d) form a finite generating set called the set of *dual simple elements*. The pair (B_n^{+*}, δ) is called the *dual Garside structure* of the braid group.

The notion of left-weightedness is defined in the same way as in the classical case: an ordered pair of dual simple elements (d, d') is left-weighted if $\delta \wedge_d (dd') = d$, here \wedge_d is the greatest common divisor with respect to \leq_d . Then we have, analogous to the classical left normal form, the *dual left normal form*.

Proposition-Definition 2.3. [BKL] *Let $x \in B_n$. There exists a unique decomposition of x of the form*

$$N_d(x) = \delta^p d_1 \cdots d_r,$$

where $p \in \mathbb{Z}$ and d_1, \dots, d_r are dual simple elements with $d_1 \neq \delta, d_r \neq 1$ such that (provided $r \geq 2$) for each $i = 1, \dots, r-1$, the pair (d_i, d_{i+1}) is left-weighted. We call $N_d(x)$ the *dual (left) normal form* of x .

The dual simple elements can be more easily described and studied viewing them as mapping classes of the punctured disk \mathbb{D}_n . To this end we isotope the latter to the following model:

$$\{z \in \mathbb{C}, |z| \leq 2\} - \{p_i = e^{\sqrt{-1} \frac{\pi}{n}(n+1-2i)}, i = 1, \dots, n\};$$

we denote by Γ the circle $|z| = 1$ along which the punctures are placed. For simplicity the i th puncture will be denoted by i instead of p_i and for $i, j \in \{1, \dots, n\}$, we also denote by (i, j) the arc of Γ described by the move of the puncture i clockwise along Γ until the position j . The generator

$a_{i,j}$ is then a clockwise (left-handed) half Dehn twist along the chord segment connecting the punctures i and j .

Let us now describe the set of dual simple elements. For $r = 2, \dots, n$, take r punctures i_1, \dots, i_r in this order when running along Γ clockwise from i_1 to i_r . All braid words obtained as a concatenation of $r - 1$ consecutive letters taken from the sequence $(a_{i_r, i_1}, a_{i_{r-1}, i_r}, \dots, a_{i_1, i_2})$ in this order, up to cyclic permutation, represent the same braid P .

Geometrically, as a mapping class of \mathbb{D}_n , the braid P corresponds to a clockwise rotation by one notch of a neighborhood of the convex polygon in \mathbb{D}_n whose vertices are the punctures i_1, \dots, i_r . Due to this correspondence, we call such a braid P a (*convex*) *polygon* and we will often confuse P with the corresponding convex polygon in \mathbb{D}_n . For example, the dual Garside element δ corresponds to the polygon which is the convex hull of all punctures. Notice that when $r = 2$, the polygon is degenerated and corresponds to a single letter a_{i_1, i_2} (a single half Dehn twist about the chord segment joining the two punctures). Two polygons which are disjoint commute; their respective actions on the disk are totally independent from each other. Any dual simple element can be written in a unique manner as a product of disjoint polygons (up to permutation of the factors) [BKL].

The notion of left-weightedness in the dual context can be described as follows. Let $a_{i,j}$ and $a_{k,l}$ be two generators. We say that $a_{k,l}$ *obstructs* $a_{i,j}$ and we write $a_{k,l} \vdash a_{i,j}$ if $k \in (j, i - 1)$ and $l \in (i, j - 1)$. The relation \vdash is not symmetric: $a_{k,l} \vdash a_{i,j}$ does not imply $a_{i,j} \vdash a_{k,l}$.

Proposition 2.4. [BKL] *Let $d = P_1 \cdots P_r$ and $d' = Q_1 \cdots Q_{r'}$ be dual simple elements expressed as products of disjoint polygons. Then the pair (d, d') is left-weighted if and only if for any two vertices i and j of a polygon among $Q_1, \dots, Q_{r'}$, there exists a polygon among P_1, \dots, P_r having two vertices k and l such that $a_{k,l} \vdash a_{i,j}$.*

3. BURAU REPRESENTATION AND THE CLASSICAL GARSIDE STRUCTURE OF B_4

This section originated in trying to exploit a result by Lee and Song which can be stated as follows:

Theorem 3.1. [LS] *If non-trivial, the kernel of the Burau representation ρ_4 is a pseudo-Anosov subgroup of B_4 .*

Pseudo-Anosov braids are mapping classes of the punctured disk \mathbb{D}_n represented by pseudo-Anosov homeomorphisms, those which are neither a root of the full twist Δ^2 , nor permute a family of disjoint isotopy classes of simple closed curves in \mathbb{D}_n [FM].

An important result relating pseudo-Anosov braids and Garside theory asserts that any pseudo-Anosov braid admits a power which is conjugate to a rigid braid [BGGM1], meaning that it is cyclically left-weighted: the ordered pair formed by the last and the first factor is left-weighted. Moreover, up to taking further power we may assume this rigid braid to have even infimum.

Observe now that the Burau matrix $\rho_4(\Delta^2)$ is the homothety of ratio q^4 : $\rho_4(\Delta^2) = q^4 I_3$. It follows that the Burau representation ρ_4 is not faithful if and only if there exists a rigid pseudo-Anosov positive braid with infimum 0 whose Burau matrix is an homothety of ratio q^{4p} for some positive integer p . This motivates to explore some conditions under which the Burau matrix is not an homothety.

Let $x \in B_4$. For $i = 1, 2, 3$ we define $M_i(x) = \max\{M(\rho_4(x)_{ij}), 1 \leq j \leq 3\}$, in words the maximal degree of the variable q among the Laurent polynomials appearing in the i th row of the reduced Burau matrix of x .

We recall the following computations (see Section 5):

$$\rho_4(\sigma_1) = \begin{pmatrix} -q & 0 & 0 \\ 1 & 1 & 0 \\ 0 & 0 & 1 \end{pmatrix}; \rho_4(\sigma_2) = \begin{pmatrix} 1 & q & 0 \\ 0 & -q & 0 \\ 0 & 1 & 1 \end{pmatrix}; \rho_4(\sigma_3) = \begin{pmatrix} 1 & 0 & 0 \\ 0 & 1 & q \\ 0 & 0 & -q \end{pmatrix}.$$

Lemma 3.2. *Let $x \in B_4$. Suppose x has infimum 0 and $s_1 \cdots s_r$ ($r \geq 2$) is the classical normal form of x . Suppose that for all $i = 1, \dots, r$, $s_i \neq \sigma_2 \sigma_1 \sigma_3$. Denote simply by M_i the integer $M_i(x)$. Then we have the following:*

- If $S(s_1) = \{1\}$ then $M_1 > M_2$ and $M_1 > M_3 + 1$,
- if $S(s_1) = \{2\}$ then $M_2 \geq M_1$ and $M_2 > M_3$,
- if $S(s_1) = \{3\}$ then $M_3 \geq M_1$ and $M_3 \geq M_2$,
- if $S(s_1) = \{1, 2\}$ then either $M_1 > M_2$ and $M_1 > M_3 + 1$, or $M_2 \geq M_1$ and $M_2 > M_3$,
- if $S(s_1) = \{2, 3\}$ then either $M_2 \geq M_1$ and $M_2 > M_3$, or $M_3 \geq M_1$ and $M_3 \geq M_2$,
- if $S(s_1) = \{1, 3\}$ then either $M_1 > M_2$ and $M_1 > M_3$, or $M_3 \geq M_1$ and $M_3 \geq M_2$.

Moreover, the following inequality holds: $\sup_c(x) \leq M(\rho_4(x)) \leq 3 \sup_c(x)$.

Proof of Lemma 3.2. The proof is by induction on r . A direct calculation shows that all conclusions are correct for the case $r = 2$. Here we remark that in the case $r = 1$ and $s_1 = \sigma_1$ ($S(s_1) = \{1\}$), the conclusion does not hold since $M_1(\sigma_1) = M_3(\sigma_1) + 1$.

Suppose now $r > 2$. Write $x = s_1 x'$; by induction x' satisfies the conclusions of the lemma. We now distinguish 6 cases, according to the possible values of $S(s_1)$. In each case, there are several possibilities for s_1 . Each of them leads to conditions on the starting set of s_2 , the first factor of x' , because of the left-weightedness condition on the pair (s_1, s_2) . By induction hypothesis this gives relations between the integers $M'_i := M_i(x')$. In each case, using the explicit computation of $\rho_4(s_1)$, we express the integers $M_i = M_i(s_1 x')$ in terms of the M'_i and show that they satisfy the expected relations. In each case, the computations to be performed show that $M(\rho_4(x')) + 1 \leq M(\rho_4(s_1 x')) \leq M(\rho_4(x')) + 3$; this shows the last claim in the lemma.

We present the cases $S(s_1) = \{2\}$ and $S(s_1) = \{1, 3\}$; this will have the advantage to show the failure in the argument when a factor $\sigma_2 \sigma_1 \sigma_3$ appears. Other cases are proven similarly.

Case $S(s_1) = \{2\}$. The simple element s_1 is one of the following: $\sigma_2, \sigma_2 \sigma_1, \sigma_2 \sigma_3, \sigma_2 \sigma_1 \sigma_3 \sigma_2$ or $\sigma_2 \sigma_1 \sigma_3$. We treat two examples; again the three others are dealt with similarly.

Suppose $s_1 = \sigma_2$. Then $F(s_1) = \{2\}$ and by left-weightedness $S(s_2) = \{2\}$. By induction, we have

$M'_2 \geq M'_1$ and $M'_2 > M'_3$. Multiplying $\rho_4(x')$ on the left by $\rho_4(\sigma_2) = \begin{pmatrix} 1 & q & 0 \\ 0 & -q & 0 \\ 0 & 1 & 1 \end{pmatrix}$, the new

degrees M_i in the product satisfy $M_1 = M'_2 + 1$, $M_2 = M'_2 + 1$ and $M_3 \leq M'_2$ (possibly the terms of highest degrees in the second and third row of $\rho_4(x')$ cancel with each other). Therefore we have $M_2 = M_1$ and $M_2 > M_3$, thus satisfying the expected conditions when $S(s_1) = \{2\}$.

Suppose $s_1 = \sigma_2 \sigma_1 \sigma_3$. Then $F(s_1) = \{1, 3\}$ and by left-weightedness, $S(s_2) = \{1\}, \{3\}$ or $\{1, 3\}$. By induction $M'_3 \geq M'_1, M'_2$ or $M_1 > M_2, M_3$ (with possibly $M_1 > M_3 + 1$). Computing $\rho_4(\sigma_2 \sigma_1 \sigma_3) =$

$\begin{pmatrix} 0 & q & q^2 \\ -q & -q & -q^2 \\ 1 & 1 & 0 \end{pmatrix}$ we get in the first case $M_1 = M'_3 + 2$, $M_2 = M'_3 + 2$ and $M_3 \leq \max(M'_1, M'_2) \leq$

M'_3 ; whence $M_2 \geq M_1$ and $M_2 > M_3$. In the second case, unless the strongest inequality $M'_1 > M'_3 + 1$ holds, there is no reason why a cancellation could not yield $M_3 \geq M_2$. Therefore the desired conclusion ($M_2 > M_3$) possibly does not hold and we see that the argument fails when $\sigma_2 \sigma_1 \sigma_3$ is a factor of x .

Case $S(s_1) = \{1, 3\}$. Then s_1 is $\sigma_1 \sigma_3, \sigma_1 \sigma_3 \sigma_2, \sigma_1 \sigma_3 \sigma_2 \sigma_1, \sigma_1 \sigma_3 \sigma_2 \sigma_3$ or $\sigma_1 \sigma_3 \sigma_2 \sigma_3 \sigma_2$.

Suppose $s_1 = \sigma_1 \sigma_3$. We compute $\rho_4(\sigma_1 \sigma_3) = \begin{pmatrix} -q & 0 & 0 \\ 1 & 1 & q \\ 0 & 0 & -q \end{pmatrix}$. By left-weightedness, we have $S(s_2) \subset$

$\{1, 3\}$ and therefore by induction the M'_i satisfy $M'_1 > M'_2, M'_3$ or $M'_3 \geq M'_1, M'_2$. In the first case $x = \sigma_1 \sigma_3 x'$ satisfies $M_1 = M'_1 + 1$, $M_2 \leq M'_1$ and $M_3 = M'_3 + 1$: we have, as expected,

$M_1 > M_2, M_3$. In the second case, we have $M_1 = M'_1 + 1, M_2 = M'_3 + 1, M_3 = M'_3 + 1$ whence $M_3 \geq M_1, M_2$.

Suppose $s_1 = \sigma_1\sigma_3\sigma_2$. Then we have to check the product of the matrix $\rho_4(\sigma_1\sigma_3\sigma_2) = \begin{pmatrix} -q & -q^2 & 0 \\ 1 & q & q \\ 0 & -q & -q \end{pmatrix}$ by $\rho_4(x')$, where the M'_i satisfy by induction $M'_2 \geq M'_1$ and $M'_2 > M'_3$. This gives $M_1 = M'_2 + 2, M_2 = M'_2 + 1$ and $M_3 = M'_2 + 1$ whence $M_1 > M_2, M_3$.

Suppose $s_1 = \sigma_1\sigma_3\sigma_2\sigma_1$. Compute $\rho_4(\sigma_1\sigma_3\sigma_2\sigma_1) = \begin{pmatrix} 0 & -q^2 & 0 \\ 0 & q & q \\ -q & -q & -q \end{pmatrix}$. On the other hand we have by induction one of the following set of conditions on x' : $M'_1 > M'_2$ and $M'_1 > M'_3 + 1$; or $M'_2 \geq M'_1$ and $M'_2 > M'_3$. In the first case we obtain $M_1 = M'_2 + 2, M_2 \leq \max(M'_2 + 1, M'_3 + 1)$ and $M_3 = M'_1 + 1$ whence $M_3 > M_1, M_2$. In the second case we get $M_1 = M'_2 + 2, M_2 = M'_2 + 1$ and $M_3 \leq M'_2 + 1$ whence $M_1 > M_2, M_3$.

Suppose $s_1 = \sigma_1\sigma_3\sigma_2\sigma_3$. Compute $\rho_4(\sigma_1\sigma_3\sigma_2\sigma_3) = \begin{pmatrix} -q & -q^2 & -q^3 \\ 1 & q & 0 \\ 0 & -q & 0 \end{pmatrix}$. By induction hypothesis, as $S(S_2) \subset F(s_1) = \{2, 3\}$, we have $M'_2 \geq M'_1$ and $M'_2 > M'_3$ or $M'_3 \geq M'_1, M'_2$. In the first case:

- if $M'_2 > M'_3 + 1$ then $M_1 = M'_2 + 2, M_2 = M'_2 + 1 = M_3$ whence $M_1 > M_2, M_3$,
- if $M'_2 = M'_3 + 1$ then $M_1 \leq M'_2 + 2$ and $M_2 = M'_2 + 1 = M_3$ whence we get $M_1 > M_2, M_3$ if $M_1 = M'_2 + 2$ and $M_3 \geq M_1, M_2$ if $M_1 < M'_2 + 2$.

In the second case we obtain $M_1 = M'_3 + 3, M_2 \leq M'_2 + 1$ and $M_3 = M'_2 + 1$ whence $M_1 > M_2, M_3$.

Suppose $s_1 = \sigma_1\sigma_3\sigma_2\sigma_1\sigma_3$. The reduced Burau matrix of s_1 is $\begin{pmatrix} 0 & -q^2 & -q^3 \\ 0 & q & 0 \\ -q & -q & 0 \end{pmatrix}$. On the other hand $F(s_1) = \{1, 3\}$ whence by induction x' satisfies: $M'_1 > M'_2, M'_3$ or $M'_3 \geq M'_1, M'_2$. In the first case we get $M_1 \leq \max(M'_2 + 2, M'_3 + 3), M_2 = M'_2 + 1, M_3 = M'_1 + 1$. This implies $M_3 \geq M_1, M_2$ provided $M'_1 > M'_3 + 1$ holds. If on the contrary $M'_1 = M'_3 + 1$ we can say more about M_1 (actually there will be no cancellation there) because the inequality $M'_1 > M'_2$ then implies $M'_3 + 1 > M'_2$ whence $M_1 = M'_3 + 3$. This finally shows $M_1 > M_2, M_3$. In the second case we obtain $M_1 = M'_3 + 3, M_2 = M'_2 + 1$ and $M_3 \leq \max(M'_1 + 1, M'_2 + 1)$ whence $M_1 > M_2, M_3$. □

Example 3.3. We show that the conclusion for $S(s_1) = \{2\}$ in Lemma 3.2 does not necessarily hold if $s_1 = \sigma_2\sigma_1\sigma_3$. Indeed, let $x = \sigma_2\sigma_1\sigma_3 \cdot \sigma_1\sigma_3\sigma_2\sigma_1 \cdot \sigma_1\sigma_2\sigma_1\sigma_3 \cdot \sigma_1\sigma_3 \cdot \sigma_1\sigma_2 \cdot \sigma_2$. This braid has infimum 0 and is in normal form as written; the degrees of the entries of its Burau matrix are

indicated in the following matrix: $\begin{pmatrix} 5 & 8 & 7 \\ 6 & 7 & 7 \\ 5 & 7 & 2 \end{pmatrix}$.

Lemma 3.2 leads to the following non-vanishing criterion for the reduced Burau representation of 4-braids.

Theorem 3.4. *If the classical left normal form of a 4-braid x does not contain a factor $(\sigma_2\sigma_1\sigma_3)$ then $\rho_4(x) \neq 1$.*

Proof. Let $N_c(x) = \Delta^p s_1 \cdots s_r$. It is easy to check that if $r \leq 2$, then $\rho_4(x) \neq 1$ so we may assume $r > 2$.

First we observe that

$$\rho_4(\Delta) = \begin{pmatrix} 0 & 0 & -q^3 \\ 0 & -q^2 & 0 \\ -q & 0 & 0 \end{pmatrix}$$

hence $M_1(\Delta x) = M_3(x) + 3$, $M_2(\Delta x) = M_2(x) + 2$ and $M_3(\Delta x) = M_1(x) + 1$.

Assume that $S(s_1) \neq \{1, 3\}$. If p is even, then by conjugating by Δ if necessary, we may assume that $S(s_1) = \{1\}, \{2\}$, or $\{1, 2\}$. By Lemma 3.2, $\rho_4(s_1 \cdots s_r)$ is not an homothety hence $\rho_4(\Delta^p s_1 \cdots s_r) \neq 1$. If p is odd, we may assume similarly that $S(s_1) = \{2\}, \{3\}$, or $\{2, 3\}$ hence by Lemma 3.2, $M_2(s_1 \cdots s_r) \geq M_1(s_1 \cdots s_r)$ or $M_3(s_1 \cdots s_r) \geq M_1(s_1 \cdots s_r)$. On the other hand, $\rho_4(x) = 1$ implies

$$M_3(s_1 \cdots s_r) + 2 = M_2(s_1 \cdots s_r) + 1 = M_1(s_1 \cdots s_r),$$

which is a contradiction.

Now we consider the case $S(s_1) = \{1, 3\}$. Assume for a contradiction that $\rho_4(x) = 1$. This implies in particular $M_i(yxy') = M_i(yy')$ for any 4-braids y and y' . We deduce a contradiction by finding appropriate braids y and y' .

Case 1: $s_1 = \sigma_1\sigma_3$. If p is even, put $y = \Delta\sigma_2\sigma_1\sigma_3\sigma_2$: $N_c((\Delta\sigma_2\sigma_1\sigma_3\sigma_2)x) = \Delta^{p+2}s_2 \cdots s_r$. By direct calculation and under our hypothesis that $\rho_4(x) = Id$,

$$\rho_4(\Delta^{p+2}s_2 \cdots s_r) = \rho_4(\Delta\sigma_2\sigma_1\sigma_3\sigma_2) = \begin{pmatrix} -q^3 & 0 & 0 \\ q^3 & q^4 & q^4 \\ 0 & 0 & -q^3 \end{pmatrix}.$$

It follows that $M_2(s_2 \cdots s_r) = M_1(s_2 \cdots s_r) + 1 = M_3(s_2 \cdots s_r) + 1$; contradicting Lemma 3.2 applied with $S(s_2) \subset \{1, 3\}$ (which implies in particular $M_2 < M_1$ or $M_2 \leq M_3$).

If p is even, choose $y = \sigma_2\sigma_1\sigma_3\sigma_2$: $N_c((\sigma_2\sigma_1\sigma_3\sigma_2)x) = \Delta^{p+1}s_2 \cdots s_r$. By direct calculation

$$\rho_4(\Delta^{p+1}s_2 \cdots s_r) = \rho_4(\sigma_2\sigma_1\sigma_3\sigma_2) = \begin{pmatrix} 0 & 0 & q^2 \\ -q & -q^2 & -q^2 \\ 1 & 0 & 0 \end{pmatrix}.$$

Hence, $M_1(s_2 \cdots s_r) = M_2(s_1 \cdots s_r) = M_3(s_2 \cdots s_r) + 2$, contradicting Lemma 3.2 applied with $S(s_2) \subset \{1, 3\}$.

Case 2: $s_1 = \sigma_1\sigma_3\sigma_2$, or $\sigma_1\sigma_3\sigma_2\sigma_3\sigma_1$.

Suppose first that $2 \in F(s_r)$; then put $y' = \sigma_2$ if p is even and $y' = \Delta\sigma_2$ if p is odd. Then

$$N_c(xy') = \begin{cases} \Delta^p s_1 \cdots s_r(\sigma_2) & \text{if } p \text{ is even} \\ \Delta^{p+1}(\Delta^{-1}s_1\Delta) \cdots (\Delta^{-1}s_r\Delta)\sigma_2 & \text{if } p \text{ is odd} \end{cases}$$

Observe that $S(\Delta^{-1}s_1\Delta) = \{1, 3\}$. Now because of Lemma 3.2 we must have in either case $M_2(xy') < M_1(xy')$ or $M_2(xy') \leq M_3(xy')$. But on the other hand the calculations of $\rho_4(\sigma_2)$ already given as well as

$$\rho_4(\Delta\sigma_2) = \begin{pmatrix} 0 & -q^3 & -q^3 \\ 0 & q^3 & 0 \\ -q & -q^2 & 0 \end{pmatrix}$$

yield the expected contradiction.

Assume then that $2 \notin F(s_r)$. Conjugating by Δ if necessary, we may assume $1 \in F(s_r)$ (and s_1 is unchanged). Then $N_c(\sigma_1^{-1}x\sigma_1) = \Delta^p s'_1 \cdots s_r\sigma_1$, where $s'_1 = (\Delta^{-p}\sigma_1\Delta^p)^{-1}s_1$ satisfies $F(s'_1) = F(s_1)$. But as we have already seen $\sigma_1^{-1}x\sigma_1$ cannot be sent by ρ_4 to the identity matrix because $S(s'_1)$ is not $\{1, 3\}$.

Case 3: $s_1 = \sigma_1\sigma_3\sigma_2\sigma_1$, or $\sigma_1\sigma_3\sigma_2\sigma_3$

If $2 \in F(s_r)$ then the same argument as Case 2 applies. Conjugating by Δ if necessary, we may assume $1 \in F(s_r)$.

- If p is odd and $s_1 = \sigma_1\sigma_3\sigma_2\sigma_1$, then consider $\sigma_1^{-1}x\sigma_1$.
- If p is even and $s_1 = \sigma_1\sigma_3\sigma_2\sigma_1$, then consider $\sigma_2x\sigma_1\sigma_2$.
- If p is odd and $s_1 = \sigma_1\sigma_3\sigma_2\sigma_3$, then consider $\sigma_3^{-1}x\sigma_3$.
- If p is even and $s_1 = \sigma_1\sigma_3\sigma_2\sigma_3$, then consider $\sigma_1^{-1}x\sigma_1$.

In any case, from Lemma 3.2 we obtain a contradiction. □

4. CURVE DIAGRAMS, THE WALL-CROSSING LABELING AND DUAL GARSIDE LENGTH

In this section we review a connection between curve diagrams of braids and the dual Garside structure, which was developed in [IW]. Here we will prove a slightly stronger result which explains how to read the dual normal form of a braid x from its curve diagram.

4.1. Curve diagrams. Let E (resp. \overline{E}) be the oriented arc in \mathbb{D}_n consisting of the real line segment between p_1 and p_n (resp. p_0 and p_n). Both line segments \overline{E} and E are oriented from left to right. For $i = 0, \dots, n - 1$, we denote by E_i the line segment of \overline{E} connecting p_i and p_{i+1} . See Figure 1 (a); as a convention, the initial segment E_0 is depicted as dashed line.

For $i = 1, \dots, n$, let W_i be the vertical line segment in \mathbb{D}_n , oriented upwards, which connects the puncture p_i and the boundary of \mathbb{D}_n in the upper half-disk $\{z \in \mathbb{D}^2 \mid \text{Im } z > 0\}$. The lines W_i are called the *walls*, and their union $\bigcup_i W_i$ is denoted W . Let U_i be a disk-neighborhood of the puncture p_i and set $U = \bigcup_i U_i$. See Figure 1 (b), (c).

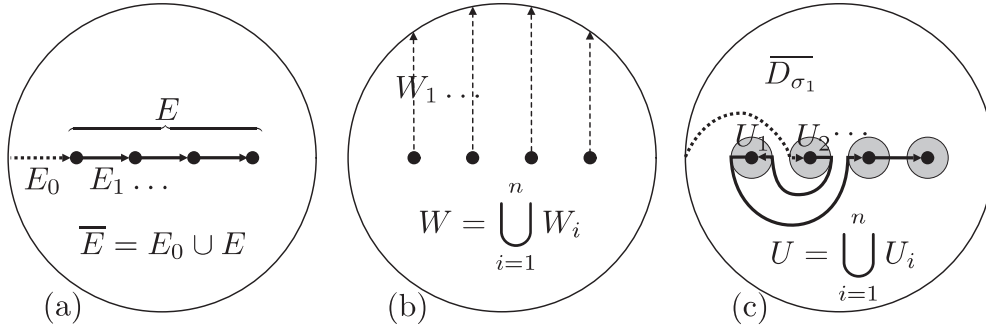

FIGURE 1. Curve diagram and walls

The (total) curve diagram of a braid x is the respective image of E (or \overline{E}) under a diffeomorphism ϕ representing x which satisfies:

- (1) $(\overline{E})\phi$ coincides with the real line on U ,
- (2) $(\overline{E})\phi$ is transverse to W and the number of intersections of $(\overline{E})\phi$ with W is as small as possible (which is equivalent to saying that $(\overline{E})\phi$ and W do not bound together any bigon [FGRRW]).

The (total) curve diagram is uniquely defined up to isotopy of \mathbb{D}_n that fixes $\partial\mathbb{D}_n$. We denote by D_x (\overline{D}_x respectively) the (total) curve diagram of a braid x . Figure 1 (c) shows the (total) curve diagram of the braid $\sigma_1 \in B_4$; according to our previous convention, dashed line represents the image of the initial segment E_0 .

An *arc segment* (or simply an arc) of the (total) curve diagram D_x (or \overline{D}_x) is a connected component of $D_x - (W \cup U)$ (or $\overline{D}_x - (W \cup U)$). Notice that an arc segment of \overline{D}_x is in one of the three following cases:

- it connects two walls W_i and W_j ,
- it connects a wall W_i and a puncture p_j (more precisely the neighborhood U_j),

- it connects two punctures p_i and p_j (more precisely the neighborhoods U_i and U_j).

In all cases, $i \neq j$ by construction of the curve diagram. We denote such an arc segment, in either case, by (ij) . Unless explicitly specified, we will not care about the orientation of an arc segment; this is reflected in our notation.

4.2. Wall-crossing labeling and dual normal form. We now describe the wall-crossing labeling. To that purpose, we need to introduce a modified version of the curve diagrams.

Let $x \in B_n$. Around each puncture p_i distinct from the image of p_n under x , we modify the total curve diagram \overline{D}_x inside the neighborhood U_i as shown in Figure 2 (a). We denote the resulting (total) curve diagram by MD_x (\overline{MD}_x), and call it the (total) modified curve diagram of x . Figure 2 (b) shows the (total) modified curve diagram of $\sigma_1 \in B_4$.

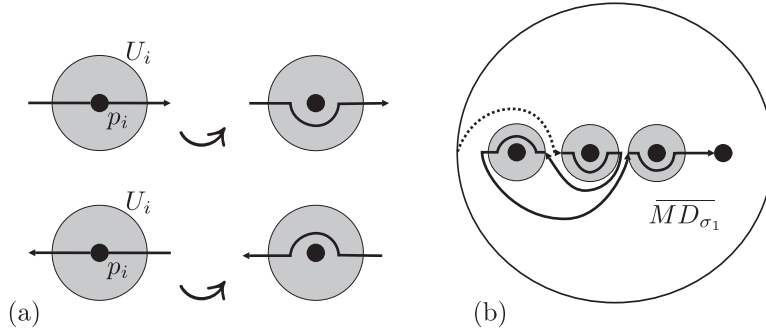

FIGURE 2. Modified curve diagrams

Take a smooth parametrization of \overline{MD}_x , viewed as the image of a function $\gamma: [0, 1] \rightarrow \mathbb{D}^2$. For each connected component α of $\overline{MD}_x - (W \cup U)$, we assign the algebraic intersection number of W and the arc $\gamma([0, v])$, where $v \in [0, 1]$ is taken so that $\gamma(v) \in \alpha$. Notice that a connected component of $\overline{MD}_x - (W \cup U)$ naturally corresponds to an arc segment of \overline{D}_x , since \overline{MD}_x and \overline{D}_x are identical except on U . This allows to attribute a label to each arc segment of \overline{D}_x ; this integer-valued labeling is called the *wall-crossing labeling* of x . We define $\text{LWcr}(x)$ and $\text{SWcr}(x)$ as the largest and smallest possible labels occurring in the wall-crossing labeling for arc segments in the curve diagram D_x , respectively.

Notice that to define LWcr and SWcr , we used the largest and smallest labels only of the curve diagram D_x , not the total curve diagram \overline{D}_x . However, in order to determine the wall crossing labelings we need to consider the total curve diagram.

The following relates the wall-crossing labeling with the dual length of a braid:

Theorem 4.1. [IW, Theorem 3.3] *For a braid $x \in B_n$, we have the following equalities:*

- (1) $\sup_d(x) = \text{LWcr}(x)$.
- (2) $\inf_d(x) = \text{SWcr}(x)$.

Here we show a stronger result than Theorem 4.1, which is suggested by and is implicit in the proof of [IW, Theorem 3.3]: one can read not only supremum, infimum, but also dual Garside normal form from the curve diagram. Recall from Section 2.2 the lattice ordering \leq_d on B_n .

Theorem 4.2. *Let $x \in B_n$ be a braid and put $\ell = \text{LWcr}(x) - \text{SWcr}(x)$. For $k = \ell, \dots, 1$, we define d_k inductively as follows:*

- (1) d_ℓ is the least common multiple (with respect to \leq_d) of all letters $a_{i,j}$ such that the curve diagram D_x contains an arc segment (ij) with wall-crossing labeling $\text{LWcr}(x)$.

- (2) d_k is the least common multiple (with respect to \leq_d) of all letters $a_{i,j}$ such that the curve diagram $D_{x d_\ell^{-1} \dots d_{k+1}^{-1}}$ contains an arc segment $\widehat{(i,j)}$ with wall-crossing labeling $(k + \text{SWcr}(x))$.

Then the dual normal form of x is given by

$$N_d(x) = \delta^{\text{SWcr}(x)} d_1 \dots d_\ell.$$

Before proving Theorem 4.2, we review from [IW] the description of how the action of a dual simple element affects the curve diagram of a braid and its wall-crossing labeling. This was the key of the proof of Theorem 4.1.

Dealing with the dual Garside structure, it will be convenient to work with the model of the punctured disk described in Section 2.2; in that context the wall W_i is the shortest straight segment connecting the puncture p_i to the boundary, oriented outwards. Notice that the isotopy involved in the change of model for the punctured disk does not affect the wall-crossing labeling since the latter is defined in terms of algebraic intersection of arcs and walls.

Let $x \in B_n$; let d be a dual simple element. Write $d = P_1 \cdots P_r$ the decomposition of d into a product of disjoint polygons. For $i = 1, \dots, r$, let N_i be a regular neighborhood of the polygon P_i in \mathbb{D}_n . Let A_i be an annulus which is a regular neighborhood of the boundary of N_i . Suppose moreover that A_i is chosen so that none of its two boundary components forms a bigon together with the walls W or the diagram D_x and so that as many intersection points of D_x and W as possible lie in A_i .

Now $D_{x d}$ and its wall-crossing labeling are obtained as follows. The respective actions of each of the polygons P_i are independent; each of them acts non-trivially only on the inner complementary component of the corresponding annulus and on the annulus itself (where the diagram just describes a spiral). For each $i = 1, \dots, r$, N_i is turned by one notch in the clockwise direction and all labels are increased by one; on the annulus A_i , $D_{x d}$ and the corresponding labels are interpolated linearly; see Figure 3. The action of the inverse of a dual simple element can be described in a very similar way, the twisting on N_i being in the opposite direction, and all labels being decreased by one.

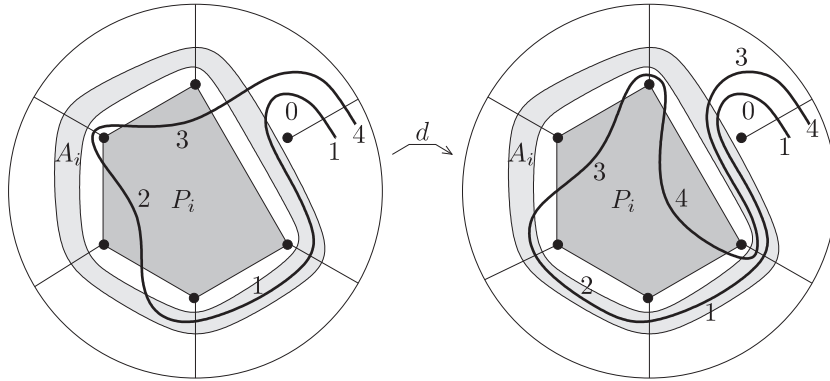

FIGURE 3. How to draw curve diagram of $x d$ from D_x

Proof of Theorem 4.2. We prove the theorem by induction on $\ell = \text{LWcr}(x) - \text{SWcr}(x)$. When $\ell \leq 1$, the result is explicitly contained in the proof of Lemma 3.5 in [IW]. Suppose that $\ell \geq 2$. By induction, it is sufficient to show that $(d_{\ell-1}, d_\ell)$ is left-weighted.

We check the left-weightedness using Proposition 2.4. Write the dual simple elements d_ℓ and $d_{\ell-1}$ as products of disjoint polygons: $d_{\ell-1} = P_1 \cdots P_{r_{\ell-1}}$ and $d_\ell = Q_1 \cdots Q_{r_\ell}$, respectively. Let i, j

be two vertices of some polygon $Q \in \{Q_1, \dots, Q_{r_\ell}\}$. We must show that there exists a polygon $P \in \{P_1, \dots, P_{r_\ell}\}$ having vertices k, l such that $a_{k,l} \vdash a_{i,j}$. By definition of $d_{\ell-1}$, it is sufficient to show that $D_{x d_\ell^{-1}}$ admits an arc segment $\widehat{(kl)}$ with label $\text{LWcr}(x) - 1$ and such that $a_{k,l} \vdash a_{i,j}$.

Assume first that the diagram D_x admits an arc segment $\widehat{(ij)}$ with label $\text{LWcr}(x)$. Then according to the description above of the action of the inverse of a polygon, the diagram $D_{x d_\ell^{-1}}$ admits an arc segment $\widehat{(kl)}$ with label $\text{LWcr}(x) - 1$ such that $k \in (j, i - 1)$ and $l \in (i, j - 1)$, as desired. Moreover, we notice that if $g_{i,j}$ and $h_{i,j}$ are the rightmost vertex of Q in $(j, i - 1)$ and $(i, j - 1)$ respectively, then $k \in (g_{i,j}, i - 1)$ and $l \in (h_{i,j}, j - 1)$. See Figure 4 (a).

Assume now that D_x does not have an arc segment $\widehat{(ij)}$ with label $\text{LWcr}(x)$. Since both i and j are vertices of Q , by definition of Q there must exist arc segments $\widehat{(ib)}, \widehat{(jc)}$ of D_x with label $\text{LWcr}(x)$, for some punctures $b, c \notin \{i, j\}$, possibly $b = c$.

Suppose that such a puncture b can be chosen so that $a_{b,i} a_{i,j}$ is a dual simple braid. This means that $b \in (i + 1, j - 1)$. But we have just seen that the action of Q^{-1} produces an arc segment $\widehat{(kl)}$ labeled by $\text{LWcr}(x) - 1$ in the diagram $D_{x d_\ell^{-1}}$, such that $k \in (j, i - 1)$ (because the rightmost vertex of Q in the arc $(b + 1, i - 1)$ certainly lies in the subarc $(j, i - 1)$ and $l \in (i, b - 1) \subset (i, j - 1)$). Similarly, if c can be chosen so that $a_{c,j} a_{i,j}$ is a dual simple braid, we get a pair of punctures k, l with the expected property. See Figure 4 (b).

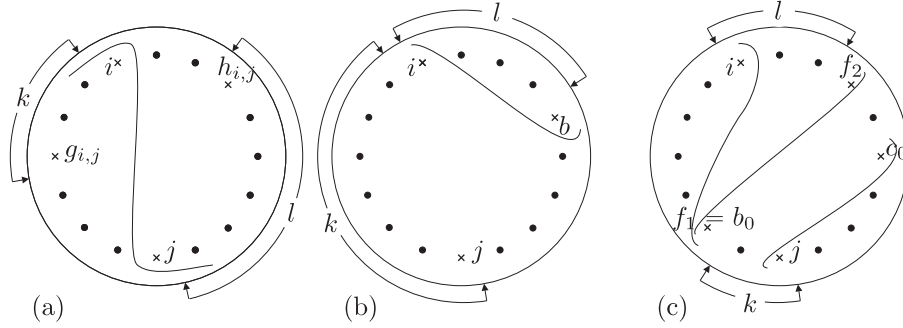

FIGURE 4. Proof of Theorem 4.2; all arc segments represented are labeled $\text{LWcr}(x)$, crosses indicate vertices of the polygon Q .

Finally, suppose that no arc segment $\widehat{(bi)}$ nor $\widehat{(jc)}$ with labeling $\text{LWcr}(x)$ of D_x has the above property. Then $b \in (j + 1, i - 1)$, $c \in (i + 1, j - 1)$ and $b \neq c$. Among all b so that D_x admits an arc $\widehat{(bi)}$ labeled $\text{LWcr}(x)$, let b_0 be the leftmost one. Similarly, among all c so that D_x admits an arc $\widehat{(jc)}$ labeled $\text{LWcr}(x)$, let c_0 be the leftmost one. The punctures i, j, b_0 and c_0 are all distinct and vertices of the polygon Q . By definition of d_ℓ , there must exist an arc segment $\widehat{(f_1 f_2)}$ in D_x with labeling $\text{LWcr}(x)$ such that $f_1 \in (j + 1, b_0)$, $f_2 \in (i + 1, c_0)$; the punctures f_1, f_2 are also vertices of Q . But then $D_{x d_\ell^{-1}}$ admits an arc $\widehat{(kl)}$ labeled $\text{LWcr}(x) - 1$ with $k \in (j, f_1 - 1)$ and $l \in (i, f_2 - 1)$, thus with the required property. See Figure 4 (c) (an example where $f_1 = b_0$). This completes the proof of Theorem 4.2. \square

5. BURAU REPRESENTATION

In this section we review a homological construction of the Burau representation; this interpretation is used to relate the latter with the wall-crossing labeling.

5.1. The Burau representation. Fix the base point $* = -(n + 1) \in \partial \mathbb{D}_n$ on the boundary of \mathbb{D}_n . The fundamental group $\pi_1(\mathbb{D}_n)$ is a free group of rank n where the free generator x_i is

represented by a loop which rounds the i th puncture p_i once clockwise. Let $\epsilon : \pi_1(\mathbb{D}_n) \rightarrow \mathbb{Z} = \langle q \rangle$ be the homomorphism which sends all x_i to the generator q . Geometrically, for a loop γ , $\epsilon([\gamma])$ is the sum of the algebraic winding number of γ about the puncture points $\{p_i\}$ (in the clockwise direction).

Let $\pi : \widetilde{\mathbb{D}}_n \rightarrow \mathbb{D}_n$ be the infinite cyclic covering corresponding to $\text{Ker}(\epsilon)$, and fix a lift $\tilde{*}$ of the base point. The group of covering transformations of $\widetilde{\mathbb{D}}_n$ is identified with the cyclic group $\langle q \rangle$. Then $H_1(\widetilde{\mathbb{D}}_n; \mathbb{Z})$ can be endowed with a structure of $\mathbb{Z}[q, q^{-1}]$ -module, where multiplication by q corresponds to the deck transformation. Moreover it turns out that $H_1(\widetilde{\mathbb{D}}_n; \mathbb{Z})$ is free of rank $(n-1)$ as a $\mathbb{Z}[q, q^{-1}]$ -module. Since ϵ is B_n -invariant, we have a linear representation

$$\rho : B_n \rightarrow \text{GL}(H_1(\widetilde{\mathbb{D}}_n; \mathbb{Z})).$$

This is called the (*reduced*) *Burau representation*. In the rest of this section, we keep the same notation ϵ , $\widetilde{\mathbb{D}}_n$ and $\tilde{*}$ for the above defined winding number evaluation morphism, covering space of \mathbb{D}_n and base point.

5.2. Forks. Let Y be the Y -shaped graph consisting of three external vertices: a distinguished one r , two others v_1 and v_2 and one internal vertex c and three edges relating each external vertex to the internal one (see Figure 5 (a)). We orient the edges of Y as shown in Figure 5 (a).

A *fork* is an embedded image of Y into \mathbb{D}_n such that:

- All points of $Y - \{r, v_1, v_2\}$ are mapped to the interior of \mathbb{D}_n .
- The distinguished vertex r is mapped to the base point $*$.
- The other two external vertices v_1 and v_2 are mapped to two different puncture points.

Given a fork F , the image of the edge $[r, c]$ is called the *handle* of F and the image of $[v_1, v_2] = [v_1, c] \cup [c, v_2]$, regarded as a single oriented arc, is called the *tine* of F and denoted by $T(F)$. The image of c is called the *branch point* of F . Figure 5 (b) shows a fork F (with the handle depicted in grey line and the tine in black line).

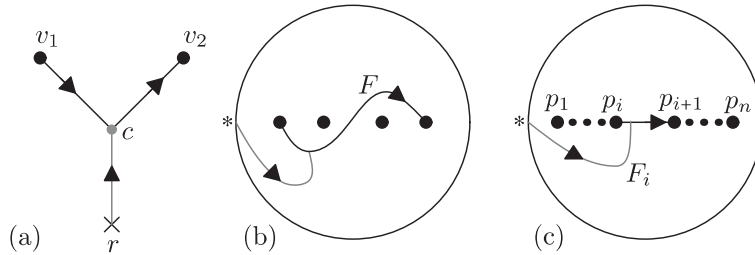

FIGURE 5. Fork and standard fork F_i

For a fork F , let $\gamma : [0, 1] \rightarrow \mathbb{D}_n$ be the handle of F , viewed as a path in \mathbb{D}_n and take a lift

$$\tilde{\gamma} : [0, 1] \rightarrow \widetilde{\mathbb{D}}_n$$

of γ so that $\tilde{\gamma}(0) = \tilde{*}$. Let $\Sigma(F)$ be the connected component of $\pi^{-1}(T(F))$ that contains the point $\tilde{\gamma}(1)$. The *homology class of $H_1(\widetilde{\mathbb{D}}_n; \mathbb{Z})$ represented by F* is then defined as the homology class represented by $\Sigma(F)$. By abuse of notation, we still denote this homology class by F . Strictly speaking, since $\Sigma(F)$ is not compact we need to work with the homology of locally finite chains $H_1^{lf}(\widetilde{\mathbb{D}}_n; \mathbb{Z})$ or $H_1(\widetilde{\mathbb{D}}_n, \tilde{P}; \mathbb{Z})$, where \tilde{P} is the preimage of a small neighborhood of the punctures in \mathbb{D}_n . Rigorous treatments are well-known and give rise to the same conclusions (see [Bi3], for example), so we do not take care of these subtle points.

Of special importance is the following family of particularly simple forks: for $i = 1, \dots, n-1$, let F_i be the fork whose tine is a straight arc connecting the i th and the $(i+1)$ st punctures and

whose handle is contained in the lower half of the disk \mathbb{D}_n (see Figure 5 (c)). These are called *standard forks*. Standard forks F_1, \dots, F_{n-1} form a basis of $H_1(\widetilde{\mathbb{D}}_n; \mathbb{Z})$. The group $\text{GL}(H_1(\widetilde{\mathbb{D}}_n; \mathbb{Z}))$ can be identified with $\text{GL}(n-1; \mathbb{Z}[q, q^{-1}])$ using the basis of standard forks. This allows to get the familiar matrix description of the reduced Burau representation:

$$\begin{aligned} \rho_n(\sigma_1) &= \begin{pmatrix} -q & 0 \\ 1 & 1 \end{pmatrix} \oplus I_{n-3}, & \rho_n(\sigma_{n-1}) &= I_{n-3} \oplus \begin{pmatrix} 1 & q \\ 0 & -q \end{pmatrix}, \\ \rho_n(\sigma_i) &= I_{i-2} \oplus \begin{pmatrix} 1 & q & 0 \\ 0 & -q & 0 \\ 0 & 1 & 1 \end{pmatrix} \oplus I_{n-i-2}, & (i &= 2, \dots, n-2) \end{aligned}$$

5.3. The noodle-fork pairing. A *noodle* is an embedded oriented arc in \mathbb{D}_n which begins at the base point $*$ and ends at some point of the boundary $\partial\mathbb{D}_n$. Noodles represent relative homology classes in $H_1(\widetilde{\mathbb{D}}_n, \partial\widetilde{\mathbb{D}}_n; \mathbb{Z})$.

The *noodle-fork pairing* (in our notation, it should say fork-noodle pairing) is a homology intersection (algebraic intersection) pairing

$$\langle \cdot, \cdot \rangle : H_1(\widetilde{\mathbb{D}}_n; \mathbb{Z}) \times H_1(\widetilde{\mathbb{D}}_n, \partial\widetilde{\mathbb{D}}_n; \mathbb{Z}) \rightarrow \mathbb{Z}[q, q^{-1}].$$

Geometrically, it is computed in the following way (see [Bi3] Section 4).

Given a fork F and a noodle N , put $T(F)$ and N transverse with minimal intersections. Let z_1, \dots, z_r be the intersection points. Each intersection point z_i then contributes a monomial $\varepsilon_i q^{e_i}$ to $\langle N, F \rangle$, where ε_i is the sign of the intersection between $T(F)$ and N at z_i and e_i is an integer. The noodle-fork pairing is then given by

$$\langle F, N \rangle = \sum_{1 \leq i \leq r} \varepsilon_i q^{e_i} \in \mathbb{Z}[q, q^{-1}].$$

The integer e_i is computed as follows. Let γ_i be the loop which is the composition of three paths A , B and C in \mathbb{D}_n :

- A is a path from $*$ to the branch point of F along the handle of F .
- B is a path from the branch point of F to z_i along the tine $T(F)$.
- C is a path from z_i to $*$ along the noodle N .

Then $e_i = \epsilon([\gamma_i])$: that is, e_i is the sum of the winding numbers of the loop γ_i about the puncture points p_1, \dots, p_n .

As for forks, we define a distinguished family of noodles: for $i = 1, \dots, n-1$, the *standard noodle* N_i is the noodle which has empty intersection with the walls and ends at some boundary point between W_i and W_{i+1} . Given a braid x , the entries of its Burau matrix can be computed using the noodle-fork pairing in a fairly direct manner.

Lemma 5.1 (Burau Matrix formula). *Let $x \in B_n$. Then for $1 \leq i, j \leq n$, the entry $\rho_n(x)_{ij}$ of its Burau matrix is given by $\rho_n(x)_{ij} = \langle (F_i)x, N_j \rangle$.*

Proof. By definition, $(F_i)x = \sum_{k=1}^{n-1} F_k \rho_n(x)_{ik} \in H_1(\widetilde{\mathbb{D}}_n; \mathbb{Z})$, hence for $i, j \in 1, \dots, n-1$ we have

$$\langle (F_i)x, N_j \rangle = \sum_{k=1}^{n-1} \langle F_k, N_j \rangle \rho_n(x)_{ik}$$

It is directly checked that $\langle F_k, N_j \rangle = \delta_{kj}$ (Kronecker's delta) hence

$$\langle (F_i)x, N_j \rangle = \rho_n(x)_{ij}.$$

□

Example 5.2. As an example of application of Lemma 5.1, we can retrieve the Burau matrices associated to Artin generators σ_i . First, we notice that for $k = 1, \dots, n-1$, $i \neq k-1, k, k+1$, $(F_i)\sigma_k = F_i$, so that $\langle (F_i)\sigma_k, N_j \rangle = \delta_{i,j}$. For the remaining values of i , Figure 6 shows the images $(F_i)\sigma_k$.

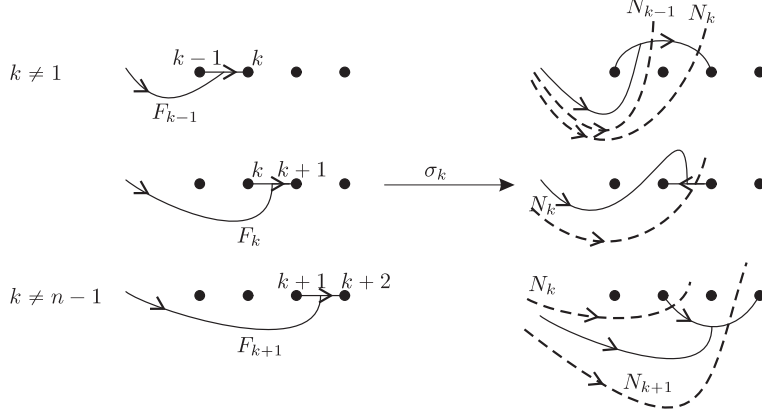

FIGURE 6. On the left part, forks F_{k-1} , F_k and F_{k+1} and on the right part, their images under the action of the braid σ_k ; relevant noodles are depicted in dashed lines.

With the help of Figure 6 we can conclude:

$$\langle (F_{k-1})\sigma_k, N_j \rangle = \begin{cases} 0 & \text{if } j < k-1 \text{ or } j > i, \\ 1 & \text{if } j = k-1, \\ q & \text{if } j = k. \end{cases} \quad \langle (F_{k+1})\sigma_k, N_j \rangle = \begin{cases} 0 & \text{if } j < k \text{ or } j > k+1, \\ 1 & \text{if } j = k, \\ 1 & \text{if } j = k+1. \end{cases}$$

$$\langle (F_k)\sigma_k, N_j \rangle = \begin{cases} 0 & \text{if } j \neq k, \\ -q & \text{if } j = k. \end{cases}$$

Lemma 5.1 then allows to retrieve the matrices given at the end of Section 5.2.

5.4. Noodle-fork pairing and wall-crossing labeling. We finally review a connection between the integers e_i in the computation of the noodle-fork pairing and the wall-crossing labeling. This will yield the expected relation between the Burau representation and the wall-crossing labeling.

Let $x \in B_n$. First we recall how to assign wall-crossing labelings for points belonging to the image $(F_i)x$ of the standard fork F_i under x . Let us consider the part of the curve diagram D_x that is the image of E_i (the line segment between the i -th and $(i+1)$ -st punctures). We identify this part $(E_i)x$ of the curve diagram with $(T(F_i))x$. Moreover, a part of the modified curve diagram can naturally be regarded as the handle of $(F_i)x$, as shown in Figure 7. This identification induces the wall crossing labeling on each connected component of $(F_i)x - (W \cup U)$. For a point $z \in (F_i)x - (W \cup U)$ we denote by $Wcr_x(z)$ the corresponding label.

Let N be a noodle; we may assume that no intersection point in $(T(F_i))x \cap N$ belongs to $W \cup U$.

Lemma 5.3. *Fix an intersection point $z \in (T(F_i))x \cap N$. Let $c(z)$ be the algebraic intersection number of W and the path C in the definition of the pairing $\langle (F_i)x, N \rangle$ (i.e. C is a path from z to $*$ along N). Let $e(z)$ be the degree of q in the z -contribution to $\langle (F_i)x, N \rangle$. Then*

$$e(z) = Wcr_x(z) + c(z)$$

Proof. Let A and B be the paths in the definition of the pairing $\langle (F_i)x, N \rangle$. Then $Wcr(z)$ is nothing but the algebraic intersection number of W and the composite path BA . Hence the

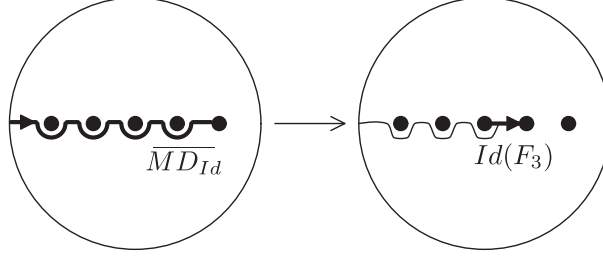

FIGURE 7. Viewing a curve diagram as a union of tines of forks, and viewing initial segments of modified curve diagrams as handles.

algebraic intersection number of W and the loop $\gamma = CBA$ is $Wcr_x(z) + c(z)$, which is, by definition, equal to $e(z) = \epsilon(\gamma)$. \square

Corollary 5.4. *For any braid $x \in B_n$, the following inequality holds:*

$$M(\rho_n(x)) \leq \sup_d(x).$$

Proof. For we have, by definition and thanks to Lemma 5.1,

$$M(\rho_n(x)) = \max_{i,j} \{M(\langle (F_i)x, N_j \rangle)\}.$$

For a standard noodle N_j and a point $z \in (T(F_i))x \cap N_j$ the integer $c(z)$ in Lemma 5.3 is always 0 because standard noodles do not intersect with walls. Therefore we have

$$\max_{i,j} \{M(\langle (F_i)x, N_j \rangle)\} \leq \text{LWcr}(x)$$

and finally, as $\text{LWcr}(x) = \sup_d(x)$ (Theorem 4.1) we are done. \square

6. BRAIDS WHOSE BURAU MATRIX DETECTS THE DUAL GARSIDE NORMAL FORMS

In view of Corollary 5.4, a natural question is to ask when the converse inequality holds. Theorem 6.1 will give a sufficient condition for the maximal degree appearing in the Burau matrix of a braid to be equal to its dual supremum. Actually we will prove more: under the same condition, it is possible to determine the dual normal form from the Burau matrix.

To state Theorem 6.1 we first introduce the notion of simply-nestedness as a refinement of the left-weightedness condition (Proposition 2.4), which will allow us to get a better control on the action of a braid in dual normal form.

Let d, d' be two dual simple elements, expressed as products of disjoint polygons $d = P_1 \dots P_r$ and $d' = Q_1 \dots Q_{r'}$ respectively. We say that the ordered pair (d, d') is *simply-nested* if for any polygon Q among $Q_1, \dots, Q_{r'}$, there exists a *unique* polygon P among P_1, \dots, P_r such that for any two vertices i, j of Q , the polygon P has two vertices k, l such that $a_{k,l} \vdash a_{i,j}$. A braid x will be said to be *simply-nested* if each pair of consecutive factors in its dual normal form is simply-nested.

Let B_n^{sn} be the set of simply nested n -braids. Although B_n^{sn} does not form a group, B_n^{sn} is a regular language over the alphabet $[1, \delta]$. We also remark that B_n^{sn} is not symmetric: $x \in B_n^{\text{sn}}$ does not imply $x^{-1} \in B_n^{\text{sn}}$. A simple example is the 4-braid $x = (a_{3,4})(a_{2,4})$. Although x is simply-nested, $N_d(x^{-1}) = \delta^{-2}(a_{1,2}a_{3,4})(a_{1,2}a_{1,4})$ which is not simply nested.

We now can state our second main result:

Theorem 6.1. *Let $x \in B_n$ be a simply-nested braid.*

- (i) $\sup_d(x) = M(\rho_n(x))$.
- (ii) *One can compute the dual normal form from the matrix $\rho_n(x)$, so the restriction of the Burau representation on the set of simply-nested braid B_n^{sn} is injective.*

For a braid x and $i = 1, \dots, n-1$ let $\mathcal{M}_x(E_i)$ be the set of the arc segments of $(E_i)x$ whose wall-crossing labeling attains the maximal value $\text{LWcr}(x)$ (possibly empty). We say that two arc segments in the curve diagram are *parallel* if both are described by (ij) for some i, j . We consider the following property **(C)** (*Coherence property*) for a braid x :

Definition 6.2. Let $x \in B_n$ and $N_d(x) = \delta^p d_1 \cdots d_r$. Express d_r as a product of disjoint polygons: $d_r = Q_1 \cdots Q_b$. We say that x has the property **(C)** if for each $i = 1, \dots, n-1$, any two arc segments α and α' in $\mathcal{M}_x(E_i)$ intersecting a common polygon $Q \in \{Q_1, \dots, Q_b\}$ are parallel and have the same orientation.

Lemma 6.3. *If x has the property (C), then $\text{sup}_d(x) = M(\rho_n(x))$ holds.*

Proof. Let $N_d(x) = \delta^p d_1 \cdots d_r$. Take i so that $\mathcal{M}_x(E_i)$ is non-empty. Take the minimal number k so that there exists an arc segment $\alpha = (kp) \in \mathcal{M}_x(E_i)$ for some $p > k$. We look at the entry $\rho_n(x)_{ik}$ in the Burau matrix of x , which is equal to $\langle (F_i)x, N_k \rangle$ by Lemma 5.1. In view of Corollary 5.4 and Theorem 4.1, the desired equality will be shown provided $M_q(\langle (F_i)x, N_k \rangle) = \text{LWcr}(x)$.

Let α' be another arc segment in $\mathcal{M}_x(E_i)$ which intersects the noodle N_k . By minimality of k , $\alpha' = (ku)$ for some $u \in (k+1, n)$. By Theorem 4.2, some polygon Q in the decomposition of d_r has vertices k, p, u ; both arcs α and α' intersect Q . Hence by property **(C)**, α and α' are parallel with the same orientation (notice that, in particular, $u = p$ holds). This shows that all arcs in $\mathcal{M}_x(E_i)$ intersecting the noodle N_k have the same sign of intersection so $M_q(\langle (F_i)x, N_k \rangle) = \text{LWcr}(x)$. \square

Lemma 6.4. *Let $x \in B_n^{\text{sn}}$. Then x has Property (C).*

Proof. The proof is by induction on the number r of non- δ factors in the dual normal form of x . The case $r = 1$ is checked by direct calculation. Actually, in this case $(E_j)x$ has at most one maximal labeled arc for any j .

Suppose $N_d(x) = \delta^p d_1 \cdots d_r$ with $r > 1$. Then $x' = \delta^p d_1 \cdots d_{r-1}$ is also simply-nested and has the Property **(C)** by induction hypothesis. Let us express d_{r-1} and d_r as products of disjoint polygons: $d_{r-1} = P_1 \cdots P_{b'}$ and $d_r = Q_1 \cdots Q_b$.

For $f = 1, \dots, n-1$, suppose that $\alpha = (ij)$ and $\alpha' = (i'j')$ are two arcs in $\mathcal{M}_x(E_f)$ that intersect a common polygon $Q \in \{Q_1, \dots, Q_b\}$. By Theorem 4.2, all of i, i', j, j' are vertices of Q . Following the proof of Theorem 4.2 we can find arcs $\beta = (kl), \beta' = (k'l')$ in the diagram $D_{x'}$ with label $\text{Wcr}(x) - 1$ ($\beta, \beta' \in \mathcal{M}_{x'}(E_f)$) and $a_{k,l} \vdash a_{i,j}$ and $a_{k',l'} \vdash a_{i',j'}$. Moreover we can choose β, β' so that α and α' come from β and β' respectively under the action of Q (see Figure 4 (a)).

By simply-nestedness assumption, k, l, k', l' must be vertices of a common polygon $P \in \{P_1, \dots, P_{b'}\}$. This implies that both β and β' intersect with the same polygon P , hence by Property **(C)** for x' , the arc segments β and β' are parallel with the same direction. Therefore the same property holds true for α and α' , as we wanted to show. \square

Remark 6.5. We observe that, although it is a stronger property, simply-nestedness is fairly easy to check whereas checking Property **(C)** directly is often a hard task since we need to know both dual normal form and the curve diagram of braids.

Proof of Theorem 6.1. Lemmas 6.3 and 6.4 show part (i).

We explain how to compute the final factor d_r of the dual normal form of x , which gives an algorithm to compute the whole dual normal form of x from its Burau matrix. Let $N_d(x) = \delta^p d_1 \cdots d_r$ and write d_r as a product of disjoint polygons: $d_r = Q_1 \cdots Q_b$.

Our strategy to determine d_r is as follows. We show how to find some $a_{i,j}$ satisfying $a_{i,j} \leq_d d_r$ from $\rho_n(x)$. Since d_r is written as a product of at most $(n-2)$ letters $a_{i,j}$, by iterating this procedure at most $(n-2)$ times, we eventually determine d_r .

For $i = 1, \dots, n-1$, let $M_i^c(x) = \max\{\rho_n(x)_{ji} \mid j = 1, \dots, n-1\}$, namely, the maximal degrees of the variable q in the i -th column of the Burau matrix of x (do not confuse $M_i(x)$ in Section 3, where we used the maximal degrees of the i -th row). First we show that $M_i^c(x)$ gives candidates of $a_{i,j}$ satisfying $a_{i,j} \leq_d d_r$.

Claim 6.6. *We have*

$$\min\{i \in \{1, \dots, n\} \mid \exists j, a_{i,j} \leq_d d_r\} = \min\{i \in \{1, \dots, n-1\} \mid M_i^c(x) = M(\rho_n(x))\}.$$

Proof. Let $i_0 = \min\{i \in \{1, \dots, n\} \mid \exists j, a_{i,j} \leq_d d_r\}$. Let $k > i_0$ be such that $a_{i_0,k} \leq d_r$.

First, we show that $M_{i_0}^c(x) = M(\rho_n(x))$. Since $a_{i_0,k} \leq d_r$ and by Theorem 4.2 there must exist some $p \in \{1, \dots, n\}$, $p > i_0$, such that D_x admits an arc $\alpha = \overline{(i_0 p)}$ labeled $\text{LWcr}(x) = M(\rho_n(x))$. Let also $Q \in \{Q_1, \dots, Q_b\}$ having vertices i_0, p, k and let j be such that $\alpha \in \mathcal{M}_x(E_j)$. We observe that α intersects the noodle N_{i_0} . We will show that $M(\rho_n(x)_{j,i_0}) = M(\rho_n(x))$. Indeed, let $\alpha' \in \mathcal{M}_x(E_j)$ and suppose that α' intersects N_{i_0} . By minimality of i_0 , α' must intersect with the polygon Q and by Property (C), α' is parallel to α with the same orientation. Hence the α and α' intersect with N_{i_0} with the same sign. Therefore $M(\langle (E_j)x, N_{i_0} \rangle) = M(\rho_n(x))$ as we wanted to show.

Second, we show that for $i < i_0$, $M_i^c(x) \neq M(\rho_n(x))$. Otherwise, there would exist some j such that $\mathcal{M}_x(E_j)$ is non-empty and we could find some $\beta \in \mathcal{M}_x(E_j)$ intersecting the noodle N_i . But then because of Theorem 4.2, β yields a letter prefix of d_r which contradicts the minimality of i_0 . \square

It follows that we can find i_0 as above looking at the columns of $\rho_n(x)$. We then proceed to find k such that $a_{i_0,k} \leq_d d_r$. Let j be such that $M(\rho_n(x)_{j,i_0}) = M_{i_0}^c(x)$. There might be several ones, we just choose any of them. Then there is a maximally labeled arc segment $\alpha = \overline{(i_0 p)} \in \mathcal{M}_x(E_j)$ which intersects the noodle N_{i_0} . It is enough to determine p because Theorem 4.2 implies that $a_{i_0,p} \leq_d d_r$. Notice that, by Property (C), p is unique with the property that $(E_j)x$ contains a maximally labeled arc segment of the form $\overline{(i_0 p)}$. In the remaining part of the proof, p and $\alpha = \overline{(i_0 p)}$ are fixed and we explain how to determine p from the Burau matrix.

Claim 6.7. *The integer p above satisfies*

- (i) $M(\langle (E_j)x, N_{p-1} \rangle) = M(\rho_n(x)_{j(p-1)}) = \text{LWcr}(x)$,
- (ii) $M(\langle (E_j)x, N_p \rangle) = M(\rho_n(x)_{jp}) \neq \text{LWcr}(x)$.

Proof. (i) First let α' be any arc segment in $\mathcal{M}_x(E_j)$ intersecting the noodle N_{p-1} . By minimality of i_0 it must also intersect the chord segment joining punctures i_0 and p , hence the polygon P . By Property (C), α' is parallel to α with the same direction. This shows (i).

(ii) Consider now an arc $\alpha' \in (E_j)x$ which intersects the noodle N_p . We show that its label is strictly less than $\text{LWcr}(x)$. Otherwise, by minimality of i_0 , α' would also intersect the polygon P ; by Property (C) it would be parallel to α , contradicting the fact that it intersects N_p . \square

Now we notice that simply looking at the matrix $\rho_n(x)$ is not sufficient to find p : there might be several integers sharing with p the properties of Claim 6.7. However let $\{p_1, \dots, p_c\}$ be the set of those punctures satisfying conditions of Claim 6.7 and suppose $p_1 < \dots < p_c$. To find p , we compute matrices $\rho_n(xa_{i_0,p_\iota}^{-1})$ for $\iota = 1, \dots, c$, until we find $M(\langle (E_j)xa_{i_0,p_\iota}^{-1}, N_{p_\iota} \rangle) < \text{LWcr}(x)$. This determines p thanks to the following observation:

Claim 6.8. *For $\iota = 1, \dots, c$ the integer p_ι satisfies:*

$$\begin{cases} M(\langle (E_j)xa_{i_0,p_\iota}^{-1}, N_{p_\iota} \rangle) = \text{LWcr}(x) & \text{if } p_\iota < p, \\ M(\langle (E_j)xa_{i_0,p_\iota}^{-1}, N_{p_\iota} \rangle) < \text{LWcr}(x) & \text{if } p_\iota = p. \end{cases}$$

Proof. Let $\iota \in \{1, \dots, c\}$ be such that $p_\iota < p$. We observe that each maximally labeled arc segment in $(E_j)xa_{i_0, p_\iota}^{-1}$ which intersects the noodle N_{p_ι} corresponds to a maximally labeled arc segment in $(E_j)x$ which intersects N_{p_ι} (in the same sign); see Figure 8. This shows:

$$M(\langle (E_j)xa_{i_0, p_\iota}^{-1}, N_{p_\iota} \rangle) = M(\langle (E_j)x, N_{p_\iota} \rangle) = \text{LWcr}(x).$$

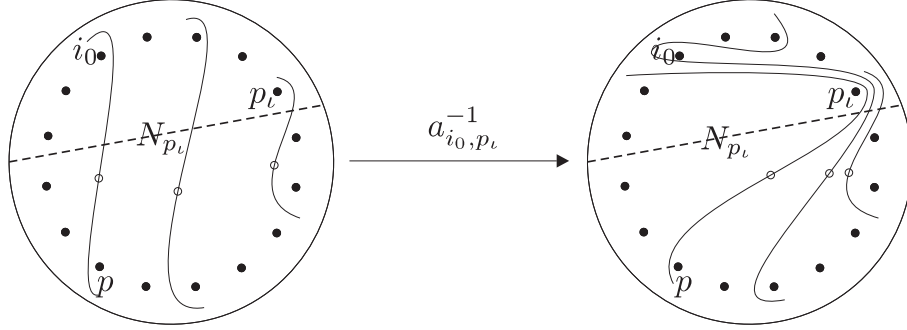

FIGURE 8. Indicated by a small circle, maximally labeled arcs in $(E_j)x$ (in $(E_j)xa_{i_0, p_\iota}^{-1}$ respectively) having intersection with the noodle N_{p_ι} (depicted as dashed line).

On the other hand, no arc segment with maximal label in $(E_j)xa_{i_0, p}^{-1}$ intersects the noodle N_p , so we get the desired equality $M(\langle (E_j)xa_{i_0, p}^{-1}, N_p \rangle) < \text{LWcr}(x)$. \square

This achieves the proof of part (ii) of Theorem 6.1. \square

Before proving the corollaries of Theorem 6.1, we make some remarks on the proof.

Remark 6.9. We notice that only Property (C) is needed in the proof of the first part of Theorem 6.1, as well as in the procedure aiming to determine the last factor of the dual normal form from the matrix. However in order to use this procedure in an inductive way and hence determine the whole of the dual normal form, the simply-nestedness assumption is crucial because Property (C) just concerns the last factor d_r so it does not guarantee that $\delta^p d_1 \cdots d_{r-1}$ also has Property (C). Moreover as we saw, simply-nestedness is often much easier to recognize as Property (C).

Remark 6.10. A statement similar to the first part of Theorem 6.1 concerning the dual infimum and the minimal degree of the entries of the Burau matrix, although it sounds quite reasonable, cannot be deduced from our proof. Indeed, the simply-nestedness assumption as well as the Property (C) do not control intersections of noodles and arc segments will smallest wall-crossing labeling at all. For the same argument to work, we need the following analogue of Property (C):

(C'): Let $N_d(x) = \delta^p d_1 \cdots d_r$. Express d_r as a product of disjoint polygons: $d_r = Q_1 \cdots Q_b$. For each $i = 1, \dots, n-1$, any two arc segments α and α' in $x(E_i)$ labeled $\text{SWcr}(x)$ and intersecting a common polygon $Q \in \{Q_1, \dots, Q_b\}$ are parallel and have the same orientation.

This makes a good contrast with the case of the LKB representations [IW]; in that context one can apply key techniques of treating arc segments with the largest crossing labeling (Bigelow's key Lemma [Bi2, Lemma 5.1]) to arc segments with the smallest crossing labeling as well.

We now proceed to show the corollaries to Theorem 6.1.

For the 3-braid group, we have the following.

Corollary 6.11. *Let $x \in B_3$. Then*

- (i) $\sup_{\mathfrak{d}}(x) = M(\rho_3(x))$,
- (ii) $\inf_{\mathfrak{d}}(x) = m(\rho_3(x))$.
- (iii) *One can compute the dual normal form of x from the matrix $\rho_3(x)$.*

Proof. We just need to be careful about the assertion (ii) (see Remark 6.10). To prove (ii), we notice that all dual simple elements are represented as a connected polygon. This observation and an argument similar to Lemma 6.4 shows any 3-braid has property **(C')**. \square

Corollary 6.12. *Let $x \in B_4$ and $N_{\mathfrak{d}}(x) = \delta^p d_1 \cdots d_r$. Assume that for all $i = 1, \dots, r-1$, (d_i, d_{i+1}) is not in the following list:*

$$\left\{ \begin{array}{l} (a_{1,2}a_{3,4}, a_{2,4}), (a_{1,2}a_{3,4}, a_{3,4}a_{2,3}), (a_{1,2}a_{3,4}, a_{1,2}a_{1,4}), \\ (a_{2,3}a_{1,4}, a_{1,3}), (a_{2,3}a_{1,4}, a_{1,3}a_{2,3}), (a_{2,3}a_{1,4}, a_{1,3}a_{1,4}) \end{array} \right\}$$

Then

- (i) $\sup_{\mathfrak{d}}(x) = M_q(\rho_4(x))$,
- (ii) *one can compute the dual normal form of x from the matrix $\rho_4(x)$.*

In particular, if the dual left normal form of a 4-braid x does not contain a factor $(a_{1,2}a_{3,4})$ or $(a_{2,3}a_{1,4})$ then $\rho_4(\beta) \neq 1$.

Proof. It follows from Theorem 6.1 observing that the mentioned pairs are the only six ones which are left-weighted and not simply-nested. \square

Let $e : B_n \rightarrow \mathbb{Z}$ be the abelianization map, given by $e(\sigma_i) = 1$. Since $\det(\rho_n(x)) = q^{e(x)}$, if $\rho_n(x) = Id$ then $e(x) = 0$. By combining this simple constraints, we get a useful criteria for braids not to lie in the kernel of Burau representation.

Corollary 6.13. *Let $x \in B_n$ be a non-trivial braid and $N_{\mathfrak{d}}(x) = \delta^p d_1 \cdots d_r$. If there exists $r' \leq r$ such that*

- (i) *The subword $x_{r'} = \delta^p d_1 \cdots d_{r'}$ is simply-nested,*
- (ii) *$r' > e(d_{r'+1} \cdots d_r)$,*

then $\rho_n(x) \neq 1$. Moreover the condition (ii) is always satisfied if $r' > \frac{n-2}{n-1}r$.

Proof. Put $E = e(d_{r'+1} \cdots d_r)$. Assume contrary, $\rho_n(x) = 1$. Since $e(d_i) \leq (n-2)$, we have $0 = e(x) \leq (n-1)p + (n-2)r' + E$ so $-p \leq \frac{1}{n-1}((n-2)r' + E)$. On the other hand, by (i)

$$0 = M(\rho_n(x)) = M(\rho_n(\delta^p d_1 \cdots d_{r'})) \rho_n(d_{r'+1} \cdots d_r) \geq M(\rho_n(\delta^p d_1 \cdots d_{r'})) = p + r'$$

hence $r' \leq -p$. Therefore $r' \leq \frac{1}{n-1}((n-2)r' + E)$, which is equivalent to $r' \leq E$. This contradicts to (ii). The last assertion follows from the inequality $E \leq (n-2)(r-r')$. \square

We close this section by looking at some known examples of elements in the kernel of the Burau representations ρ_5 and ρ_6 .

Consider the braids

$$x = [v_2^{-1}v_1\sigma_3v_1^{-1}v_2, \sigma_3] \in B_6,$$

where $v_1 = \sigma_1\sigma_2^{-1}\sigma_5^{-1}\sigma_4$ and $v_2 = \sigma_1^{-2}\sigma_2\sigma_5^2\sigma_4^{-1}$ and

$$y = [w_1^{-1}\sigma_4w_1, w_2^{-1}\sigma_4\sigma_3\sigma_2\sigma_1\sigma_1\sigma_2\sigma_3\sigma_4w_2] \in B_5,$$

where $w_1 = \sigma_3^{-1}\sigma_2\sigma_1^2\sigma_2\sigma_4^3\sigma_3\sigma_2$ and $w_2 = \sigma_4^{-1}\sigma_3\sigma_2\sigma_1^{-2}\sigma_2\sigma_1^2\sigma_2^2\sigma_1\sigma_4^5$.

It is known that $\rho_5(y) = Id$ and $\rho_6(x) = Id$. The following are dual normal forms of a conjugate x' and y' of x and y , respectively:

$$N_{\mathfrak{d}}(x') = \delta_6^{-6}(a_{1,6}a_{4,5})(a_{1,6}a_{2,5})(a_{1,6}a_{4,6}a_{2,3})(a_{1,5}a_{4,5}a_{2,3})(a_{3,6}a_{4,5})(a_{1,6}a_{2,5}a_{4,5})(a_{1,6}a_{3,5})(a_{1,6}a_{5,6}a_{2,4})$$

$$(a_{1,3}a_{5,6})(a_{2,4}a_{5,6})(a_{1,3}a_{5,6}a_{4,5})(a_{2,6}a_{4,5})(a_{1,3}),$$

$$\begin{aligned} N_d(y') = & \delta_5^{-23}(a_{2,5}a_{4,5})(a_{1,5}a_{3,5})(a_{1,4}a_{3,4})(a_{2,5})(a_{1,5}a_{2,3})(a_{1,5}a_{3,4})^2(a_{1,3})(a_{2,5}a_{3,4}) \\ & (a_{1,4}a_{3,4})(a_{1,2}a_{1,4})(a_{1,2}a_{3,5})(a_{1,2}a_{1,5}a_{3,4})(a_{1,5})(a_{1,2})(a_{2,3})(a_{3,4}) \\ & (a_{2,4})(a_{1,3}a_{4,5})(a_{1,2}a_{4,5})(a_{2,3}a_{4,5})(a_{1,3}a_{4,5})(a_{1,2}a_{3,5}a_{4,5})(a_{2,5}a_{3,5}) \\ & (a_{1,3}a_{1,4})(a_{1,2}a_{1,4})(a_{1,2}a_{1,3}a_{4,5})(a_{1,2}a_{4,5})(a_{2,3}a_{4,5})^2(a_{2,5})(a_{1,4}a_{2,3}) \\ & (a_{2,5}a_{3,5})(a_{1,5}a_{3,5})(a_{1,5}a_{2,4})(a_{1,5}a_{4,5}a_{2,3})(a_{1,5}a_{3,5}a_{2,3})^4(a_{2,4})(a_{1,3}a_{4,5}) \\ & (a_{1,2}a_{4,5})(a_{2,3}a_{4,5})(a_{1,3}a_{4,5})(a_{1,2}a_{4,5}a_{3,4}). \end{aligned}$$

See Figure 9 for pictorial (polygon) expression of $N_d(x')$. One notices that $N_d(x')$ contains many non-simply-nested pairs. Similarly, one observes that $N_d(y')$ also contains a lot of non-simply-nested pairs. These examples and our results on simply-nested braid suggest the Burau matrix of a braid x is close to be the identity matrix only when its dual normal form contains many non-simply nested pairs.

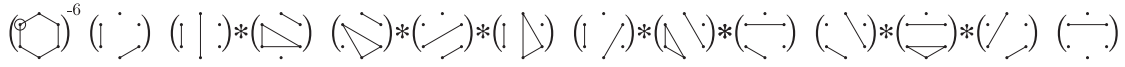

FIGURE 9. A pictorial way to represent the dual normal form of the braid $x' \in B_6$ (the puncture rounded by a circle is the first); the symbol * represents non simply-nested pairs.

REFERENCES

[Bi] S. Bigelow, *The Burau representation of the braid group B_n is not faithful for $n = 5$* , Geometry and Topology 3 (1999), 397-404.
 [Bi2] S. Bigelow, *Braid groups are linear*, J. Amer. Math. Soc. (2) 14 (2001), 471-486.
 [Bi3] S. Bigelow, *Does the Jones polynomial detect the unknot?*, J. Knot Theory Ramifications (4) 11 (2002), 493-505.
 [Bir] J. Birman, *Braids, Links, and Mapping Class Groups*, Annals of Math. Studies 82, Princeton Univ. Press (1974).
 [BGGM1] J. Birman, V. Gebhardt and J. González-Meneses, *Conjugacy in Garside Groups I: Cycling, Powers and Rigidity*, Groups Geom. Dyn. (3) 1 (2007), 221-279.
 [BKL] J. Birman, K.-H. Ko and S.-J. Lee, *A new approach to the word and conjugacy problems in the braid groups*, Adv. Math. 139 (2) (1998), 322-353.
 [EM] E. ElRifai and H. Morton, *Algorithms for positive braids*, Quart. J. Math. Oxford. Ser. (2) 45 (1994), no. 180, 479-497.
 [EHLPT] D.B.A. Epstein, J. Cannon, D. Holt, S. Levy, M. Paterson and W. Thurston, *Word processing in groups*, Jones and Bartlett Publishers, Boston, MA, 1992.
 [FM] B. Farb and D. Margalit, *A primer on Mapping Class Groups*, Princeton Mathematical Series, 2011.
 [FGRRW] R. Fenn, M. Greene, D. Rolfsen, C. Rourke and B. Wiest, *Ordering the braid groups*, Pacific J. Math. 191 (1999), 41-74
 [Gar] F. Garside, *The braid groups and other groups*, Quart. J. Math. Oxford Ser. (2) 20 (1969), 235-254.
 [IW] T. Ito and B. Wiest, *Lawrence-Krammer-Bigelow representation and dual Garside length of braids*, arXiv:1201.0957v1
 [Kra] D. Krammer, *Braid groups are linear*, Ann. Math. 155 (2002), 131-156.
 [Law] R. Lawrence, *Homological representations of the Hecke algebra*, Comm. Math. Phys. 135 (1990), 141-191.
 [LS] S.-J. Lee and W.-T. Song, *The kernel of $Burau(4) \otimes \mathbb{Z}_p$ is all pseudo-Anosov*, Pacific J. Math. (2) 219 (2005), 303-310.
 [LP] D. Long and M. Paton, *The Burau representation of the braid group B_n is not faithful for $n \geq 6$* , Topology 32 (1993), 439-447.
 [MP] W. Magnus and A. Peluso, *On a theorem of V.I. Arnold*, Com. on Pure and App. Math 23 (1969), 683-692.
 [Mo] J. Moody, *The Burau representation of the braid group B_n is not faithful for large n* , Bull. Amer. Math. Soc.25 (1991), 379-384.

MATTHIEU CALVEZ, DEPARTAMENTO DE MATEMÁTICA Y CIENCIA DE LA COMPUTACIÓN, FACULTAD DE CIENCIAS,
UNIVERSIDAD DE SANTIAGO DE CHILE, AVENIDA LIBERTADOR BERNARDO O'HIGGINS 3363, SANTIAGO, CHILE

E-mail address: calvez.matthieu@gmail.com

RESEARCH INSTITUTE FOR MATHEMATICAL SCIENCES, KYOTO UNIVERSITY KYOTO, 606-8502, JAPAN

E-mail address: tetitoh@kurims.u-kyoto.ac.jp

URL: <http://kurims.kyoto-u.ac.jp/~tetitoh/>