

CONSTRUCTING LARGE k -SYSTEMS ON SURFACES

TARIK AOUGAB

ABSTRACT. Let S_g denote the genus g closed orientable surface. For $k \in \mathbb{N}$, a k -system is a collection of pairwise non-homotopic simple closed curves such that no two intersect more than k times. Juvan-Malnič-Mohar [3] showed that there exists a k -system on S_g whose size is on the order of $g^{k/4}$. For each $k \geq 2$, We construct a k -system on S_g with on the order of $g^{\lfloor (k+1)/2 \rfloor + 1}$ elements. The k -systems we construct behave well with respect to subsurface inclusion, analogously to how a pants decomposition contains pants decompositions of lower complexity subsurfaces.

1. INTRODUCTION

Let $S_{g,p}$ denote the compact orientable surface of genus g with p boundary components. A k -system is a collection of essential, pairwise non-homotopic simple closed curves $\{\gamma_1, \dots, \gamma_n\}$ on $S_{g,p}$ such that no two curves in the collection intersect more than k times.

Let $N(k, g, p)$ denote the maximum cardinality of a k -system on $S_{g,p}$, and let $N(k, g) := N(k, g, 0)$. Juvan-Malnič-Mohar [3] first showed that for any pair (k, g) , $N(k, g) < \infty$. Furthermore, they produce lower bounds which grow asymptotically like $g^{k/4}$. Concretely, they show:

Theorem 1.1. [3] *Given $k \in \mathbb{N}$, for sufficiently large genus g , there exists a k -system on S_g of size at least $\binom{n}{\lfloor k/2 \rfloor}$, where*

$$n = \sqrt{25 + 48(g - 1)} - 5/2.$$

The main focus of this article is to improve these lower bounds for all $k \geq 2$ by constructing large k -systems. Specifically, we show:

Theorem 1.2. *Given $k \in \mathbb{N}$, $k \geq 2$, there exists a k -system $\Omega(k, g)$ on S_g such that*

$$|\Omega(k, g)| \geq \binom{g}{1 + \lfloor \frac{k}{2} \rfloor},$$

Date: June 21, 2018.

Key words and phrases. Curves on surfaces, Curve systems.

and

$$\Omega(k, g) = \Theta(g^{\lfloor (k+1)/2 \rfloor + 1}).$$

In the statement of Theorem 1.2, $\Theta()$ denotes asymptotic growth rate:

$$f = \Theta(h) \Leftrightarrow 0 < \lim_{n \rightarrow \infty} \frac{f(n)}{h(n)} < \infty.$$

Note that our lower bound is not asymptotic, in the sense that it does not require g to be sufficiently large with respect to k .

Remark 1.3. We do not expect that these lower bounds are sharp. Indeed, the lower bound for $k = 2$ grows like g^2 , and Malestein-Rivin-Theran [4], and independently Constantin [2] have constructed 1-systems on S_g with quadratically many elements.

Remark 1.4. Przytycki [6] has recently shown an upper bound for the maximum size of a 1-system which grows cubically in $|\chi(S)|$, for χ the Euler characteristic. In the same paper, for each $k > 1$, he obtains an upper bound for the maximum size of a k -system which grows like $|\chi|^{k^2+k+1}$. Alternatively, Juvan-Malnič-Mohar [3] provide an upper bound for the size of a k -system on S_g which grows like

$$2^\chi \cdot [\chi^2 k]^{\chi^k}.$$

For fixed k , as $\chi \rightarrow \infty$, Przytycki's upper bound grows slower than Juvan-Malnič-Mohar's; however for fixed χ , as $k \rightarrow \infty$, the upper bound of Juvan-Malnič-Mohar grows slower than Przytycki's. In either case, there is still a very large gap between the size of the k -systems constructed here and the best known upper bounds.

A maximal 0-system is simply a pants decomposition of $S_{g,p}$. Moreover, if c is a non-separating simple closed curve in a pants decomposition \mathcal{P} , then cutting along c , gluing in disks along the resulting two boundary components, and deleting any of the remaining curves in \mathcal{P} which have become homotopically trivial, or homotopically redundant (i.e., there may exist distinct elements of \mathcal{P} which become homotopic during this process), one obtains a subcollection \mathcal{P}' which is a pants decomposition on a lower genus surface.

The k -system $\Omega(k, g)$ on S_g that we construct satisfies an analogous property in the sense that it "contains" k -systems on lower complexity subsurfaces; moreover, it also contains large j -systems for any $j < k$:

Theorem 1.5. *The k -systems $\Omega(k, g)$ satisfy the following properties:*

- (1) $\Omega(k, g)$ contains a non-separating simple closed curve c_g such that cutting along c_g , gluing in disks along the resulting boundary components, and deleting any element of $\Omega(k, g)$ which intersects c_g essentially yields the collection $\Omega(k, g - 1)$ on S_{g-1} ;
- (2) $\Omega(k, g)$ contains a copy of $\Omega(k - 1, g)$ as a subcollection.

Let $\mathcal{F} := \{\Lambda(k, g)\}_{k,g}$ be a family of curve systems such that $\Lambda(k, g)$ is a k -system on S_g . We say that \mathcal{F} satisfies property \mathcal{I} (for “inclusion”) if it satisfies the conclusions of Theorem 1.5. As mentioned in Remark 1.3, we do not expect our lower bounds to be best possible, but it is another interesting question to restrict attention to those families of curve systems satisfying property \mathcal{I} :

Question 1. What is the maximum growth rate (in both k and g) of a family $\mathcal{F} = \{\Lambda(k, g)\}$ satisfying property \mathcal{I} ?

Furthermore, our k -systems have the property that for each g , there exists a simple closed curve η on S_g disjoint from $\Omega(k, g)$. As a corollary, we obtain the same lower bounds for $S_{g-1,2}$:

Corollary 1.6.

$$N(k, g - 1, 2) \geq \binom{g - 1}{1 + \lfloor \frac{k}{2} \rfloor}.$$

Recall that the *curve graph* of $S_{g,p}$, denoted $\mathcal{C}(S_{g,p})$, is a locally infinite, infinite diameter δ -hyperbolic graph [5] whose vertex set corresponds to the set of all isotopy classes of essential simple closed curves on $S_{g,p}$, and whose edges correspond to pairs of curves that can be realized disjointly on $S_{g,p}$.

The fact that for each k, g , there exists an essential simple closed curve in the complement of $\Omega(k, g)$ implies that our k -systems project to diameter 2-subsets of the corresponding curve graph.

This motivates the following question:

Question 2. Fix $k \in \mathbb{N}$, and let $f_k(g) : \mathbb{N} \rightarrow \mathbb{N}$ be a function such that $\lim_{g \rightarrow \infty} f_k(g) = \infty$. What is the maximum growth rate (as a function of g) of a family of k -systems $\{\Sigma(k, g)\}_{g=1}^\infty$, such that for each g , $\Sigma(k, g)$ projects to a subset of $\mathcal{C}(S_g)$ of diameter at least $f_k(g)$?

Remark 1.7. Given $\lambda \in (0, 1)$, for all g sufficiently large, if a pair of curves α, β are distance at least n apart in $\mathcal{C}(S_g)$, they must intersect at least $\lceil g^{\lambda(n-2)} \rceil$ times (see [1]). Therefore, $f_k(g)$ should be chosen to have growth at most logarithmic with base g .

Organization of paper. In section 2, we introduce some basic terminology for curves on surfaces. In section 3, we present a new method

for constructing 1-systems with quadratically many elements; these 1-systems will serve as a sort of backbone for the k -systems constructed in later sections. In section 4, we complete the general construction.

Acknowledgements The author would like to thank Yair Minsky and Igor Rivin for their time and for helpful conversations during this project. He also thanks Kyle Luh and Daniel Montealegre for suggesting the use of Pascal’s identity at the end of Section 4. The author was partially supported by NSF grants DMS 1005973 and 1311844.

2. TERMINOLOGY

2.1. curves on surfaces. A curve γ on S_g is *essential* if it is homotopically non-trivial. A *multi-curve* is a collection of pairwise non-homotopic and pairwise disjoint simple closed curves. Given two homotopic curves γ, γ' , we write $\gamma \sim \gamma'$ for the homotopy relation. Given two homotopy classes of curves $[\alpha], [\beta]$, the *geometric intersection number*, denoted $i([\alpha], [\beta])$ is simply the minimum set theoretic intersection, taken over all representatives in the homotopy classes of α and β :

$$i([\alpha], [\beta]) = \min_{x \sim \alpha} |x \cap \beta|.$$

As is customary, we write $i(\alpha, \beta)$ to mean $i([\alpha], [\beta])$. If α is a simple closed curve on S_g , a *regular neighborhood* of α is an embedded annulus A containing α and which deformation retracts to α . If γ is an embedded arc on S_g , by a regular neighborhood of γ , we mean the image of a homeomorphic embedding $\phi : [0, 1] \times [0, 1] \hookrightarrow S_g$ such that $\phi(\{1/2\} \times [0, 1]) = \gamma$.

3. CONSTRUCTING 1-SYSTEMS

A quadratic lower bound for the maximum size of a 1-system has been found by Malestein-Rivin-Theran [4] and also by Constantin [2]. In this section, we construct a quadratically growing sequence of 1-systems using a different method. These 1-systems will serve as a “scaffold” for the k -systems $\Omega(k, g)$ in the next section.

We begin by constructing a certain realization of S_g that will be convenient for displaying the desired 1-system, $\Omega(1, g)$. Beginning with S_1 , recall that free homotopy classes of essential simple closed curves on S_1 are in correspondence with pairs of coprime integers. Let α_1 be an arc on S_1 which runs parallel to a portion of the $(1, 0)$ curve. We obtain our desired realization of S_2 by first excising a pair of small open disks $D_1^{(1)}, D_2^{(1)}$ from S_1 , located within a small regular neighborhood N_1 of α_1 near the endpoints of α_1 , and not separated by α_1 within N_1 .

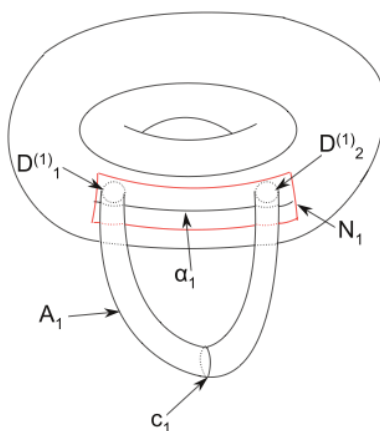

FIGURE 1. α_1 is an arc which runs parallel to the $(1, 0)$ curve on S_1 , and N_1 is enclosed in a rectangle. We excise a pair of disks on the same side of α_1 within N_1 , and glue on an annulus A_1 with core curve c_1 .

We then glue on an annulus A_1 along the resulting two boundary components, yielding S_2 ; let c_1 denote the core curve of A_1 . There is a simple closed curve d_1 containing α_1 as a sub-arc and which intersects c_1 once, as in the figure.

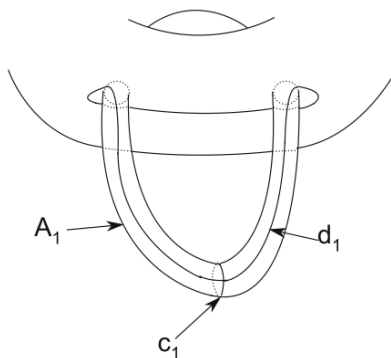

FIGURE 2. d_1 contains α_1 as a sub-arc, and intersects c_1 once.

d_1 contains a sub-arc, α_2 which is an extension of α_1 and which intersects c_1 once. Consider a small regular neighborhood N_2 of α_2 , satisfying the following property:

Let $N'_2 \subset N_2$ denote the subset of N_2 which is a regular neighborhood of α_1 . Then $\partial D_i^{(1)}, i = 1, 2$ are contained in $N_1 \setminus N'_2$.

Then we obtain S_3 by excising small disks $D_2^{(1)}, D_2^{(2)}$ within N_2 , not separated within N_2 by α_2 , and on the same side of α_1 within N_1 as $\partial D_i^{(1)}, i = 1, 2$, and gluing on an annulus A_2 along the resulting boundary components.

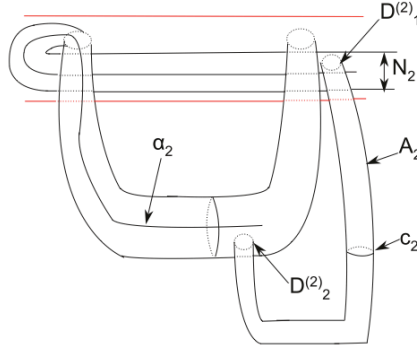

FIGURE 3. N_2 is closer to α_1 than N_1

Note that there is a simple closed curve d_2 containing α_2 as a sub-arc, and such that $i(d_2, c_2) = i(d_2, c_1) = 1$ and $i(d_2, d_1) = 0$.

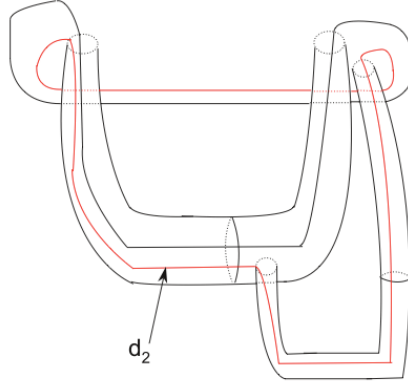

FIGURE 4. d_1 and d_2

We continue inductively; on S_{g-1} , there is a sequence of nested arcs $\{\alpha_1, \dots, \alpha_{g-1}\}$, and a collection $\{c_1, \dots, c_{g-2}\}$ of pairwise disjoint simple

closed curves such that α_k intersects c_j if and only if $k \geq j - 1$. There is furthermore a sequence of annuli $\{A_1, \dots, A_{g-2}\}$ such that c_k is the core curve of A_k , as well as a sequence of simply connected regions N_1, \dots, N_{g-1} such that N_k is a regular neighborhood of α_k . For each k , let $N'_k \subset N_k$ denote the subset of N_k which is a regular neighborhood of α_{k-1} ; then for each k ,

$$N'_k \subset N_{k-1}.$$

For each $k \leq g - 2$, the boundary components of A_k are contained in $N_k \setminus N'_{k+1}$, and not separated by α_k within N_k .

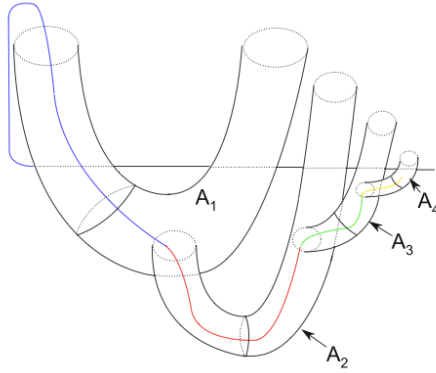

FIGURE 5. A picture of the first four iterations of the construction. The arc α_i terminates in the interior of the annulus A_i .

Finally, there is a second collection of pairwise disjoint curves $\{d_1, \dots, d_{g-2}\}$ such that d_k intersects c_j if and only if $j \leq k$.

We obtain S_g from S_{g-1} by excising a pair of open disks $D_1^{(g)}, D_2^{(g)}$ located close to the endpoints of α_g , and within N_{g-1} , not separated by α_{g-1} within N_{g-1} , and gluing on an annulus A_{g-1} along the resulting two boundary components. c_{g-1} is the core curve of A_{g-1} , and there is a curve d_{g-1} containing α_{g-1} as a sub-arc, which is disjoint from d_k for all $k < g - 1$, and which intersects c_k for all $k \leq g - 1$.

We then define α_g on S_g to be an extension of α_{g-1} which enters into the interior of A_{g-1} and intersects c_{g-1} once, and d_{g-1} is a simple closed curve disjoint from d_k for all $k \leq g - 2$, and d_{g-1} intersects c_{g-1} once.

Note that this realization of S_g comes equipped with a sequence of inclusions

$$S_{1,2} \hookrightarrow S_{2,2} \hookrightarrow \dots \hookrightarrow S_{g-1,2} \hookrightarrow S_g,$$

in accordance with how A_k glues to $S_{k,2}$ to obtain S_{k+1} .

We are now ready to construct $\Omega(1, g)$. Define $\Omega(1, 1)$ to be the single curve γ_1 whose isotopy class is represented by the pair of integers $(0, 1)$ on S_1 , and such that γ_1 intersects α_1 . $\Omega(1, g)$ is then defined by

$$\Omega(1, g) := \Omega(1, g-1) \cup \bigcup_{k=1}^{g-1} T_{d_{g-1}}(c_k),$$

where $T_{d_{g-1}}$ denotes the left Dehn-twist about d_{g-1} , and we think of $\Omega(1, g-1)$ as living on S_g via the aforementioned inclusion.

By definition, $\Omega(1, g)$ contains $g-1$ more elements than $\Omega(1, g-1)$, and therefore the sequence

$$\{|\Omega(1, g)|\}_{g=1}^{\infty}$$

grows quadratically as required. It remains to show that $\Omega(1, g)$ is in fact a 1-system. For this, we must check the following four criteria:

- (1) No two elements of $\bigcup_{k=1}^{g-1} T_{d_{g-1}}(c_k)$ are homotopic;
- (2) No two elements of $\bigcup_{k=1}^{g-1} T_{d_{g-1}}(c_k)$ intersect more than once;
- (3) No element of $\Omega(1, g-1)$ is homotopic to any element of $\bigcup_{k=1}^{g-1} T_{d_{g-1}}(c_k)$;
- (4) No element of $\Omega(1, g-1)$ intersects an element of $\bigcup_{k=1}^{g-1} T_{d_{g-1}}(c_k)$ more than once.

(1) and (2) follow from the fact that $\bigcup_{k=1}^{g-1} T_{d_{g-1}}(c_k)$ is a homeomorphic image of a collection of pairwise disjoint, pairwise non-homotopic simple closed curves. For (3), note that every element of $\bigcup_{k=1}^{g-1} T_{d_{g-1}}(c_k)$ intersects c_{g-1} essentially, but no element of $\Omega(1, g-1)$ does.

For (4), we first define a many-to-one map $\Psi : \Omega(1, g) \rightarrow \{0, 1, \dots, g-1\}$ as follows:

Orient α_g such that the endpoint it shares with α_1 is the initial point of α_g ; this induces a compatible orientation on each sub-arc α_h . Let $C_g := \{c_1, \dots, c_{g-1}\}$, and orient each curve in C_g such that all intersections with α_g occur with the same orientation. Note that the index r of $c_r \in C_g$ agrees with the orientation of α_g , in the sense that c_r is the r^{th} element of C_g that α_g intersects.

Recall that $\gamma \in \Omega(1, g) \setminus \{\gamma_1\}$ is a Dehn twist of some curve c_r in C_g about d_k for some k ; we define $\Psi(\gamma) = r$; that is, $\Psi(\gamma)$ is the index of the curve in C_g of which γ is a Dehn twist. Define $\Psi(\gamma_1) := 0$.

To show (4) for a given pair of curves $\beta_1 \in \bigcup_{k=1}^{g-1} T_{d_{g-1}}(c_k)$ and $\beta_2 \in \Omega(1, g-1)$, we note that up to combinatorial equivalence, there are

three possible cases: either $\Psi(\beta_1) > \Psi(\beta_2)$, $\Psi(\beta_1) \leq \Psi(\beta_2)$, or $\Psi(\beta_1) = \Psi(\beta_2)$.

Then if $\Psi(\beta_1) > \Psi(\beta_2)$, β_1 intersects β_2 before arriving at α_g .

Once β_2 is within a small neighborhood of α_g , it will enter an annulus that β_1 does not enter, without having to cross over β_1 . Upon returning to the corresponding element of C_g of which β_1 is a Dehn-twisted image, no further intersections with β_2 are required because β_2 has already left along some earlier element of C_g (see Figure).

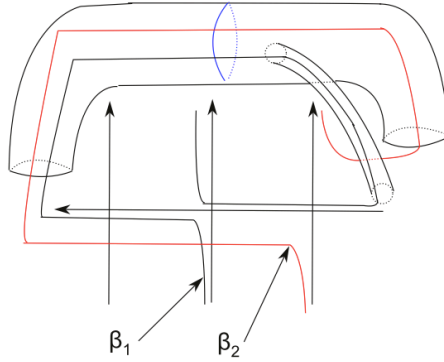

FIGURE 6. If $\Psi(\beta_1) > \Psi(\beta_2)$, we can choose representatives such that β_1 intersects β_2 before arriving at α_g , and never again.

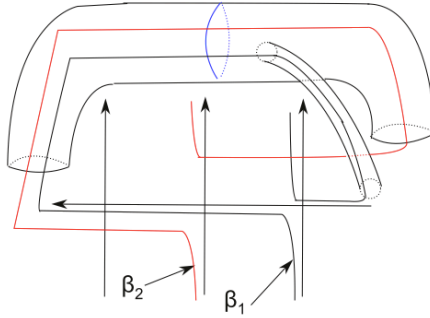

FIGURE 7. If $\Psi(\beta_1) < \Psi(\beta_2)$, we can choose representatives such that β_1 intersects β_2 right before leaving α_g , and never again.

If $\Psi(\beta_1) < \Psi(\beta_2)$, there exists representatives of β_1 and β_2 such that β_1 does not intersect β_2 before arrival at α_g ; however, since β_2 departs

from α_g later than β_1 , β_1 must intersect β_2 once when leaving α_g (see Figure 4).

Finally, if $\Psi(\beta_1) = \Psi(\beta_2)$, there exist representatives such that β_1 and β_2 don't intersect at all within a small neighborhood of α_g , but they must intersect in order to close back up.

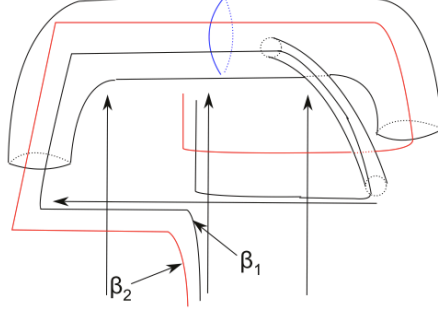

FIGURE 8. If $\Psi(\beta_1) = \Psi(\beta_2)$, there exist representatives such that β_1 does not intersect β_2 near α_g , but the curves must intersect in order to close up properly.

4. CONSTRUCTION OF $\Omega(k, g)$ FOR $k > 1$

In this section, we construct $\Omega(k, g)$ for $k > 1$. We will observe that our k -systems “nest” in the following sense: $\Omega(k, g)$ on S_g is obtained from $\Omega(k, g - 1)$ on S_{g-1} by excising two disks, gluing an annulus on along the resulting boundary components, and adding a copy of $\Omega(k - 1, g)$, “twisted” through the new annulus. In this way, $|\Omega(k, g)|$ will satisfy the recurrence relation

$$|\Omega(k, g)| = |\Omega(k, g - 1)| + |\Omega(k - 1, g)|;$$

By induction, $|\Omega(k - 1, g)|$ will be on the order of g^k , and therefore

$$|\Omega(k, g)| = \Theta(g^{k+1}).$$

However, a given pair of curves in $\Omega(k, g)$ can intersect up to $2k - 1$ times, and therefore $\Omega(k, g)$ will be a $(2k - 1)$ -system. We therefore prove the second theorem by redefining

$$\Omega(k, g) := \Omega\left(\lfloor \frac{k+1}{2} \rfloor, g\right).$$

Concretely, we define $\Omega(k, g)$ recursively by

$$\Omega(k, 1) := \Omega(1, 1),$$

and

$$\Omega(k, g) := \Omega(k, g-1) \cup \bigcup_{\gamma \in \Omega(k-1, g)} T_{d_{g-1}}(\gamma),$$

where as in the previous section, we think of $\Omega(k, g-1)$ as living on S_g via the sequence of inclusions described earlier.

As in the construction of $\Omega(1, g)$, there are 4 requirements to verify:

- (1) No two elements of $\bigcup_{\gamma \in \Omega(k-1, g)} T_{d_{g-1}}(\gamma)$ are homotopic;
- (2) No two elements of $\bigcup_{\gamma \in \Omega(k-1, g)} T_{d_{g-1}}(\gamma)$ intersect more than $2k-1$ times;
- (3) No element of $\Omega(k, g-1)$ is homotopic to an element of $\bigcup_{\gamma \in \Omega(k-1, g)} T_{d_{g-1}}(\gamma)$;
- (4) No element of $\Omega(k, g-1)$ intersects an element of $\bigcup_{\gamma \in \Omega(k-1, g)} T_{d_{g-1}}(\gamma)$ more than $2k-1$ times.

(1) and (2) both follow from the fact that $\bigcup_{\gamma \in \Omega(k-1, g)} T_{d_{g-1}}(\gamma)$ is a homeomorphic image of a $[2(k-1)-1]$ -system, and (3) follows from the fact that every element of $\bigcup_{\gamma \in \Omega(k-1, g)} T_{d_{g-1}}(\gamma)$ intersects c_{g-1} essentially, but no element of $\Omega(k, g-1)$ does.

For (4), let $\beta_1 \in \Omega(k, g-1)$, and let $\beta_2 \in \bigcup_{\gamma \in \Omega(k-1, g)} T_{d_{g-1}}(\gamma)$; note that both β_1 and β_2 are Dehn twists of curves $\tilde{\beta}_1, \tilde{\beta}_2$, respectively, which are elements of the $[2(k-1)-1]$ -system $\Omega(k-1, g)$. Concretely, $\tilde{\beta}_1$ is the pre-image of β_1 under the Dehn twist about d_{g-1} , and $\tilde{\beta}_2$ is the pre-image of β_2 under the Dehn twist about some d_k for $k < g-1$.

$$i(d_k, d_{g-1}) = 0, \text{ and}$$

$$i(d_k, \tilde{\beta}_1) \leq 1; i(d_{g-1}, \tilde{\beta}_2) = 1.$$

It therefore follows that

$$i(\beta_1, \beta_2) \leq i(\tilde{\beta}_1, \tilde{\beta}_2) + 2 \leq 2k-1.$$

This completes the proof of (4), and the construction of $\Omega(k, g)$.

It remains to show that

$$|\Omega(k, g)| \geq \binom{g}{1 + \lfloor \frac{k}{2} \rfloor}.$$

For this, we use the following inductive argument suggested by Kyle Luh and Daniel Montealegre:

For $k=1$, note that $\Omega(1, g)$ is obtained from $\Omega(1, g-1)$ by adding an additional $g-1$ curves, and $|\Omega(1, 1)| = 1$. Thus

$$|\Omega(1, g)| = \frac{g(g-1)}{2} > g.$$

For $k = 2$, $\Omega(2, g) = \Omega(1, g)$, and $\frac{g(g-1)}{2} = \binom{g}{2}$.
Note for any $k > 1$,

$$|\Omega(k, g)| = \sum_{i=1}^g |\Omega(k-1, i)|.$$

For k odd, $\lfloor \frac{k}{2} \rfloor + 1 = \frac{k-1}{2} + 1$; by Pascal's identity,

$$\begin{aligned} \binom{g}{\frac{k-1}{2}} &= \binom{g-1}{\frac{k-1}{2}} + \binom{g-1}{\frac{k-3}{2}} \\ &\leq |\Omega(k, g-1)| + |\Omega(k-2, g-1)|, \end{aligned}$$

by induction on g and k .

This in turn is equal to

$$\begin{aligned} &\sum_{i=1}^{g-1} |\Omega(k-1, i)| + |\Omega(k-2, g-1)| \\ &\leq \sum_{i=1}^g |\Omega(k-1, i)| = |\Omega(k, g)|. \end{aligned}$$

A similar argument holds for k even; this completes the proof of Theorem 1.2.

REFERENCES

- [1] T. Aougab. *Uniform Hyperbolicity of the Graphs of Curves. Geometry and Topology*, Vol. 17 (2013).
- [2] S. Constantin. *Sets of simple closed curves intersecting at most once* (2006). <http://www.math.uchicago.edu/~may/VIGRE/VIGRE2007/REUPapers/FINALFULL/Constantin.pdf>
- [3] M. Juvan, A. Malnič, B. Mohar. *Systems of curves on surfaces*. J. Combin. Theory Ser. B 68(1), (1996), (7-22).
- [4] J. Malestein, I. Rivin, L. Theran. *Topological designs*, Geometriae Dedicata 168 (2014), (221-233)
- [5] H. Masur, Y. Minsky. *Geometry of the Complex of Curves I: Hyperbolicity*. *Invent. Math.* **138** (1999), 103-149
- [6] P. Przytycki. *Arcs intersecting at most once*, preprint. <http://arxiv.org/abs/1402.1570>

DEPARTMENT OF MATHEMATICS, YALE UNIVERSITY, 10 HILLHOUSE AVENUE,
NEW HAVEN, CT 06510, USA

E-mail address: tarik.aougab@yale.edu