

# TOPOLOGICAL DETECTION OF LYAPUNOV INSTABILITY

PEDRO TEIXEIRA

ABSTRACT. Given an arbitrary  $C^0$  flow on a manifold  $M$ , let  $\text{CMin}$  be the set of its compact minimal sets, endowed with the Hausdorff metric, and  $\mathcal{S}$  the subset of those that are Lyapunov stable. A topological characterization of the interior of  $\mathcal{S}$ , the set of Lyapunov stable compact minimal sets that are away from Lyapunov unstable ones is given, together with a description of the dynamics around it. In particular,  $\text{int}_H \mathcal{S}$  is locally a Peano continuum (Peano curve) and each of its countably many connected components admits a complete geodesic metric.

This result establishes unexpected connections between the local topology of  $\text{CMin}$  and the dynamics of the flow, providing criteria for the local detection of Lyapunov instability by merely looking at the topology of  $\text{CMin}$ . For instance, if  $\text{CMin}$  is not locally connected at  $\Lambda \in \text{CMin}$ , then every neighbourhood of  $\Lambda$  in  $M$  contains Lyapunov unstable compact minimal sets (hence, if  $\text{CMin}$  is nowhere locally connected, then every neighbourhood of each compact minimal set contains infinitely many Lyapunov unstable compact minimal sets).

## 1. INTRODUCTION

The comprehension of the dynamics around compact minimal sets plays an important role in the study of flows on manifolds. Among the concepts that are pertinent in this context, those of Lyapunov stability/instability are fundamental both in the conservative and in the dissipative settings [LY, BI, M1, M2]. Detecting the occurrence of Lyapunov unstable compact minimal sets in the neighbourhood of Lyapunov stable ones is a relevant dynamical problem, first of all because in the presence of the former, by an arbitrarily small perturbation of the phase space coordinates of a point, one may pass from stable to unstable almost periodic solutions.

The set  $\text{CMin}$  of all compact minimal sets of a flow is naturally endowed with the Hausdorff metric, thus becoming a metric space whose “points” are the compact minimal sets  $\Lambda \in \text{CMin}$ . This is a topological invariant (topologically equivalent flows have homeomorphic  $\text{CMin}$ 's). On the other hand, examples show abundantly that completely distinct flows may also have homeomorphic  $\text{CMin}$ 's. Nevertheless, it turns out that the mere inspection of the local topology of  $\text{CMin}$  at  $\Lambda$  may reveal unexpected information about the flow dynamics around  $\Lambda$ . For instance, if  $\text{CMin}$  is *not* locally connected at  $\Lambda$ , then every neighbourhood of  $\Lambda$  in  $M$  contains Lyapunov

---

2000 *Mathematics Subject Classification*. Primary 37C75, 37B45; Secondary 37B25, 37C10, 37C55, 54H20.

*Key words and phrases*. Lyapunov stable, unstable, hyper-stable, minimal sets, (generalized) Peano continuum, non-wandering flows, volume-preserving, flows with all orbits periodic, continuous decompositions of manifolds.

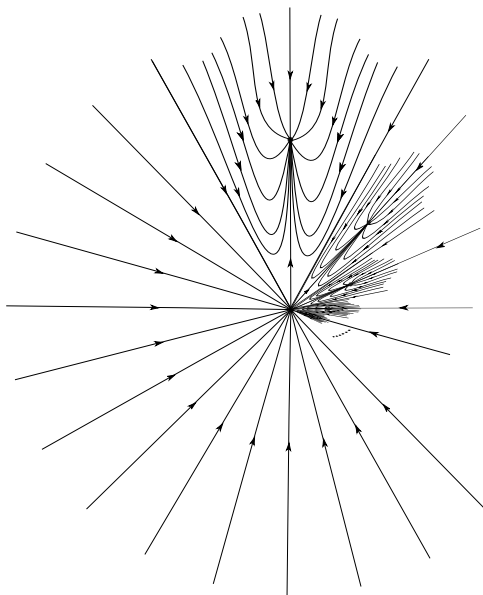

FIGURE 1.1. All equilibria, except the origin, are attractors. The CMin of this planar flow is homeomorphic to that of (1) in Fig. 1.3.

unstable compact minimal sets. The same holds if  $\Lambda$  has no compact neighbourhood in CMin. This follows immediately from the fact that, on any flow, the interior of the set  $\mathcal{S}$  of all Lyapunov stable compact minimal sets is an open subset of CMin that is both locally compact and locally connected. It is this quite exceptional topological structure that furnishes criteria permitting to detect that a given  $\Lambda \in \text{CMin}$  does *not* belong to  $\text{int}_H \mathcal{S}$  or equivalently, that  $\Lambda \in \text{cl}_H \mathcal{U} = (\text{int}_H \mathcal{S})^c$ ,<sup>1</sup> and it is readily seen that  $\Lambda \in \text{cl}_H \mathcal{U}$  iff every neighbourhood of  $\Lambda$  in  $M$  contains Lyapunov unstable compact minimal sets. Actually,  $\text{int}_H \mathcal{S}$  is locally a Peano continuum, having the nice “pre-geometric” property of existence of a complete geodesic metric on each of its countably many connected components (Corollary 3, Remark 1.c).

As a practical application, imagine that without knowing a certain flow, we are provided with a homeomorphic copy  $K$  of its CMin. If, for instance,  $K$  is the Cantor star,<sup>2</sup> then we know immediately that every neighbourhood of each compact minimal set of the flow contains infinitely many Lyapunov unstable compact minimal sets, and this by simply observing that  $K$  is not locally connected at a dense subset of its points. However, it is in general impossible, by the mere inspection of  $K$ , to determine *which* points of  $K$  correspond (under that homeomorphism) to the Lyapunov unstable compact minimal sets we know to exist. Instead of being a limitation, this fact is actually one of the reasons that make these criteria interesting, for they are among the results that somehow escape the intrinsic bounds confining the dynamical information concerning Lyapunov stability/instability extractable from the topology of CMin, as we now explain. To give a simpler example, consider the

<sup>1</sup> $\mathcal{U}$  is the set of Lyapunov unstable compact minimal sets of the flow.

<sup>2</sup>Cantor star: union of the closed radii of  $\mathbb{D}^2$  connecting the origin to a Cantor subset of  $\mathbb{S}^1 = \partial \mathbb{D}^2$ .

$C^\infty$  flow on  $\mathbb{R}^2$  pictured as (1) in Fig. 1.3 (we suppose that all orbits outside the outer periodic orbit have that orbit as  $\omega$ -limit and have empty  $\alpha$ -limit set; the denumerably many periodic orbits are ordered by decreasing length as  $\gamma_n, n \in \mathbb{N}$ ). Its CMin is homeomorphic to  $K = \{0\} \cup \{1/n : n \in \mathbb{N}\}$ , the Lyapunov stable equilibrium  $O$  (origin) is taken to 0 and each Lyapunov unstable periodic orbit  $\gamma_n$  to  $1/n$ . Since  $K$  is not locally connected at 0, we know that on *any* flow having its CMin homeomorphic to  $K$ , every neighbourhood of the compact minimal set corresponding to 0 (under that homeomorphism) contains Lyapunov unstable compact minimal sets. Now, it is easily seen that there is another  $C^\infty$  flow on  $\mathbb{R}^2$  without periodic orbits (Fig. 1.1), whose CMin is also homeomorphic to  $K$  in such a way that 0 is taken to the Lyapunov *unstable* equilibrium  $O$  and each  $1/n$  is taken to a Lyapunov *stable* equilibrium (these later equilibria are attractors i.e. asymptotically stable, see Definition 7). Hence, these two flows have homeomorphic CMin's, but under that homeomorphism, the Lyapunov unstable compact minimal sets of the first flow correspond to the Lyapunov stable ones of the second and vice versa (similar examples could be given on  $\mathbb{S}^2$ ). Therefore, by the mere inspection of  $K \simeq \text{CMin}$ , it is impossible to determine which points of  $K$  correspond to the Lyapunov unstable compact minimal sets that we know to occur in every neighbourhood of  $O$ . Observe, however, that our conclusion remains intact: in both flows every neighbourhood of the equilibrium  $O$  (corresponding to 0 under both homeomorphisms) contains Lyapunov unstable compact minimal sets  $\Gamma$  (in the second flow, the only such  $\Gamma$  is the equilibrium orbit  $\{O\}$  itself).

It should be also mentioned that contrariwise, it is obviously impossible to detect the occurrence of Lyapunov stable compact minimal sets in a flow by merely looking at its CMin, for given any  $C^{0 \leq r \leq \infty, \omega}$  flow on a manifold  $M$ , there is a  $C^r$  flow on  $M \times \mathbb{S}^1$  with all compact minimal sets Lyapunov unstable, whose CMin is isometric to that of the original flow on  $M$ . Actually, the above mentioned topological characterization of  $\text{int}_H \mathcal{S}$  is quite exceptional, for among the subsets of CMin directly related to its partition into Lyapunov stable and Lyapunov unstable compact minimal sets ( $\text{CMin} = \mathcal{S} \sqcup \mathcal{U}$ ), only  $\text{int}_H \mathcal{S}$  has a nice local topology (even inducing a pre-geometric structure).<sup>3</sup>

This work continues the line of research initiated in [TE] aiming to illuminate the connections between the local topology of CMin and the dynamics of the flow, here focused in Lyapunov stability/instability phenomena. In the conservative setting it gives, for instance, a somewhat purely topological counterpart to certain well known dynamical facts, usually detected by analytic methods in higher regularity

<sup>3</sup>For instance, every  $\mathbb{S}^{n \geq 1}$  carries a  $C^\infty$  flow with  $\mathcal{S}$  and  $\mathcal{U}$  both nowhere locally compact and nowhere locally connected (always in relation to the Hausdorff metric). It is also easily seen that every  $n$ -dimensional compact metric space  $K$  (even if nowhere locally connected) is homeomorphic to the set  $\mathcal{S}$  of all Lyapunov stable compact minimals of some  $C^\infty$  flow on  $\mathbb{R}^{2n+2}$ . The same is true for  $\text{bd}_H \mathcal{S}, \mathcal{S} \cap \text{bd}_H \mathcal{S}, \text{cl}_H \mathcal{S}, (\text{cl}_H \mathcal{S}) \setminus \mathcal{U}, \mathcal{U}, \text{int}_H \mathcal{U}, \mathcal{U} \cap \text{bd}_H \mathcal{U}, \text{cl}_H \mathcal{U}, (\text{cl}_H \mathcal{U}) \setminus \mathcal{S}$  (obviously,  $\text{int}_H, \text{bd}_H, \text{cl}_H$  stand for interior boundary and closure of subsets of CMin in relation to the Hausdorff metric and  $\mathcal{U} = \mathcal{S}^c := \text{CMin} \setminus \mathcal{S}$ ). These examples already give an idea of how topologically arbitrary these sets may be in comparison with  $\text{int}_H \mathcal{S}$ .

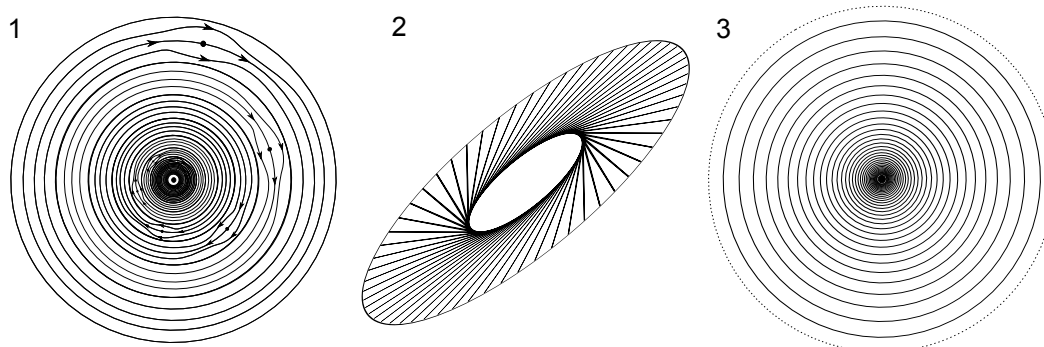

FIGURE 1.2. Theorem A, cases 1, 2 and 3.

(for instance, the occurrence of Lyapunov unstable periodic orbits arbitrarily close to a generic elliptic periodic orbit in dimension 3 (“...de sorte qu’il est par essence impossible de séparer les processus stables et instables” in Zehnder [Z2], see also [Z1, NE, M1] and Fig. 8.3-3 “VAK” in [AB, p.585]). Based on the local topological characterization of  $\text{int}_H \mathcal{S}$  mentioned above, the following result establishes a conservative setting picture of the possible interplay between Lyapunov stability and instability in the neighbourhood of an arbitrary compact minimal set:

**Theorem. (A)** *Let  $\Lambda$  be a compact minimal set of a  $C^0$  non-wandering flow on a connected manifold  $M$ . Then, either*

- (1) *there is a sequence of Lyapunov unstable compact minimal sets  $\Lambda_n$  converging to  $\Lambda$  in the Hausdorff metric, or*
- (2)  *$\Lambda = M$  i.e.  $M$  is compact and the flow is minimal, or*
- (3) *there are arbitrarily small compact, connected, invariant neighbourhoods  $U$  of  $\Lambda$  in  $M$  such that:*
  - (a)  *$U$  is the union of  $c = |\mathbb{R}|$  Lyapunov stable (compact) minimal sets  $\Lambda_{i \in \mathbb{R}}$ ;*
  - (b) *endowed with the Hausdorff metric, the set  $\{\Lambda_{i \in \mathbb{R}}\}$  is a Peano continuum (Peano curve).*

For general  $C^0$  flows (not necessarily non-wandering), proper attractors may show up and we have the following analogue local characterization (Section 4.1.2, Theorem 2 and Fig. 1.3):

**Theorem. (B)** *Let  $\Lambda$  be a compact minimal set of a  $C^0$  flow on a connected manifold  $M$ . Then, either*

- (1) *there is a sequence of Lyapunov unstable compact minimal sets  $\Lambda_n$  converging to  $\Lambda$  in the Hausdorff metric, or*
- (2)  *$\Lambda$  is an attractor i.e. asymptotically stable, or*
- (3) *there are arbitrarily small compact, connected, (+)invariant neighbourhoods  $U$  of  $\Lambda$  in  $M$  such that:*
  - (a) *the (compact) minimal sets contained in  $U$  are all Lyapunov stable and, endowed with the Hausdorff metric, their set is a Peano continuum with  $c$  elements;*

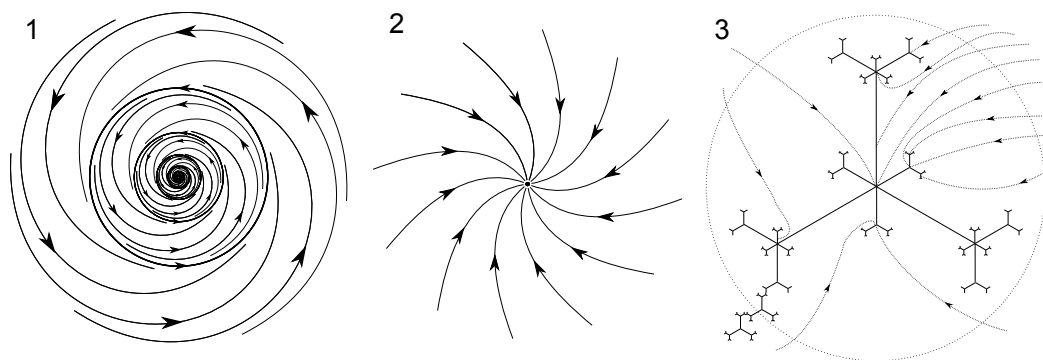

FIGURE 1.3. Theorem B, cases 1, 2 and 3.

- (b) for each  $x \in U$ ,  $\omega(x)$  is a (Lyapunov stable compact) minimal set contained in  $U$  and if  $x \notin \omega(x)$ , then its negative orbit leaves  $U$  (and thus never returns again).

This result shows that, if a compact minimal set  $\Lambda$  is away from Lyapunov unstable ones, then the dynamics around it is reasonably well understood and the set of Lyapunov stable compact minimals near  $\Lambda$  has a remarkable topological structure (in relation to the Hausdorff metric  $d_H$ ), exactly as in the non-wandering case (Theorem A).

Although we have assumed the phase space  $M$  to be a connected manifold, these results still hold under much weaker hypothesis: it is enough to suppose that  $M$  is a generalized Peano continuum i.e. a locally compact, connected and locally connected metric space (see Remark 1.c). What seems remarkable is that *this topological structure of the phase space is actually completely inherited by each component of  $H\mathcal{S} := \text{int}_H \mathcal{S}$* , the set of Lyapunov stable compact minimal sets that are away (in the Hausdorff metric) from Lyapunov unstable ones (see Definitions 3 and 4). Globally, what happens, for arbitrarily flows, is roughly the following (Theorem 1):

- (1)  $H\mathcal{S}$  has countably many components  $X_i$  (possibly none), each  $X_i$  being a clopen generalized Peano continuum ( $H\mathcal{S}$  is endowed with the Hausdorff metric);
- (2) the union  $X_i^* \subset M$  of the (Lyapunov stable) compact minimal sets  $\Lambda \in X_i$  is contained in the “basin”  $A_i$ , a connected, open invariant subset of  $M$ , consisting of all points that have some  $\Lambda \in X_i$  as  $\omega$ -limit set. Although  $X_i^*$  may be noncompact, it roughly acts as an attractor with basin  $A_i$  in the flow (see Fig. 1.4);
- (3) if  $x \in A_i$  but  $x \notin \omega(x)$ , then  $\alpha(x) \subset \text{bd} A_i$ .

This gives a fairly complete description of the dynamics within and around each  $X_i^*$ . If the flow is non-wandering but not minimal, then  $X_i^* = A_i$  (Theorem 3), i.e. the union of the compact minimal sets belonging to a component  $X_i$  of  $H\mathcal{S}$  is a (nonvoid) connected, open invariant set  $A_i \subset M$  and the local density of these minimal sets is actually  $\mathfrak{c}$  all over  $A_i$ : every open set  $B \subset A_i$  intersects  $\mathfrak{c}$  (Lyapunov stable) compact minimal sets  $\Lambda \in X_i$ .

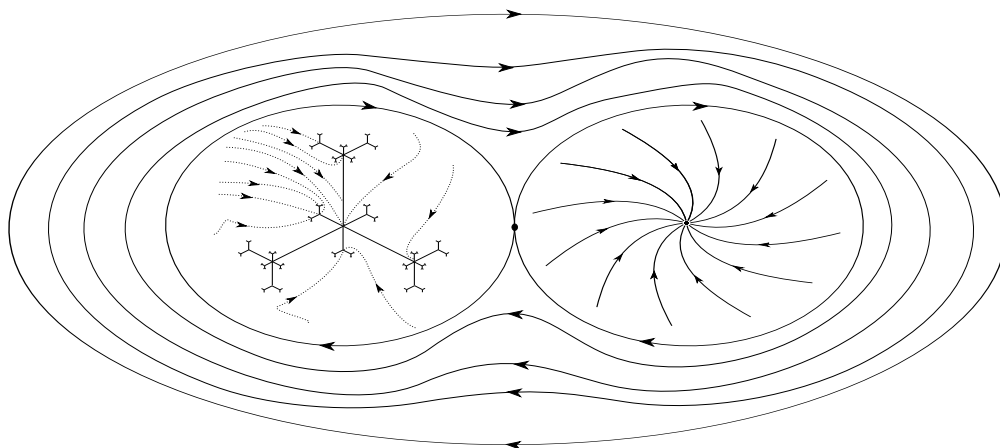

FIGURE 1.4. Flow on  $\mathbb{S}^2$ .  $H\mathcal{S}$  has three components.

The proofs explore the local topology of the phase space  $M$ , together with the specific dynamical constraints of the flow near  $\Lambda \in H\mathcal{S}$  and the fact that these minimal sets  $\Lambda$  are continua (see Remark 1.a), to “move” the local topological structure of  $M$  to the components of  $H\mathcal{S}$ . A kind of duality builds up between these two topologies, Lemma 3 being a simple “show-case” of the techniques that enable this “crossing of the bridge”. Showing that  $H\mathcal{S}$  is locally a Peano continuum (Corollary 3) requires a fundamental result from Peano continuum theory (see the proof of Lemma 5), and seems hard to establish otherwise.

This paper is organized as follows: Section 2 introduces the general setting of the whole work and the main concepts, Lyapunov stability and hyper-stability (2.1, 2.2 and 2.3). Examples illustrating the dynamical significance of both notions are given in 2.4 and 2.5, the later section being entirely devoted to flows with all orbits periodic. Section 3 introduces the main tools and the first dynamical consequences of the topological characterization of  $H\mathcal{S}$  there obtained, criteria for the local detection of Lyapunov unstable compact minimal sets being given in 3.1. Section 4 contains the main results, giving a reasonable global and local characterization of  $H\mathcal{S}$  and of the dynamics around it. The analogue characterizations, specific to the non-wandering context, are obtained in 4.2. Section 5 shows how global absence of Lyapunov unstable compact minimals imposes strong dynamical constraints on the flow, if the phase space is compact (these constraints vanish in the noncompact setting). Directly related to this phenomenon are the continuous decompositions of closed manifolds into closed submanifolds. The natural question of the existence of a manifold structure in the associated quotient space (endowed with the Hausdorff metric) is briefly discussed in 5.2. Finally, Section 6 shows that the topological characterization of  $H\mathcal{S}$  obtained in Corollary 3 (Section 3) is optimal in the context under consideration and ends pointing to evidence showing that intricate (generalized) Peano continua indeed appear as the  $H\mathcal{S}$  sets of smooth flows on manifolds. Sections 2.4, 2.5, 4.1.3, 5 and 6 are unessential and may be skipped by any reader seeking a “straight to the core” approach. However, the first paragraph

of Section 6 and Problem 2 in the same section are important to gain perspective of the significance of the main result (Theorem 1).

## 2. LYAPUNOV STABILITY VERSUS INSTABILITY

**2.1. General setting.** Throughout this paper, deductions are purely topological, all results being valid for flows on much larger classes of phase spaces than those of manifolds. We now establish the general context of this work. This amounts to a minimum of hypothesis needed to deduce all the results in the paper.

**CONVENTION:** Except if otherwise mentioned, we will be considering an *arbitrary continuous* ( $C^0$ ) *flow*  $\theta$  on a *locally compact, connected and locally connected metric space*  $M$ . Such an  $M$  is called a *generalized Peano continuum* (a *Peano continuum*, if compact).  $M$  is *non-degenerate* if  $|M| > 1$ , thus implying  $|M| = \mathfrak{c} = |\mathbb{R}|$ .

( $M$  is connected ( $\implies |M| \geq \mathfrak{c}$ ) and locally compact, hence [KO, p.269] separable ( $\implies |M| \leq \mathfrak{c}$ ), therefore  $|M| = \mathfrak{c}$ ).

Assuming the phase space of the flow to be a generalized Peano continuum instead of a manifold has obvious advantages, even in the differentiable setting: the results may be applied to subflows on arbitrary (e.g. non-manifold) connected, closed invariant subsets, provided these are locally connected. Obviously, if, instead, these invariant subsets are open, then only connectedness is required. On the other hand, this more general setting helps to get rid of the additional manifold structure that is irrelevant for the comprehension of the phenomena under consideration, attention becoming exclusively focused on the topological factors that are determinant to the process.

*Remark 1.* (a) a *continuum* is a compact and connected metric space. Compact minimal sets are continua.

(b) Peano continua (or *Peano curves*) are the continuous images of  $\mathbb{D}^1 = [-1, 1]$  into Hausdorff spaces (Hahn-Mazurkiewicz Theorem).

(c) connected manifolds<sup>4</sup> (not necessarily compact or boundaryless) are generalized Peano continua and the later share important topological properties with the former: they are locally compact, *separable*, *arcwise connected*, *locally arcwise connected* [NA, p.131-132] and *admit a complete geodesic metric* (Tominaga and Tanaka [TO], following Bing [B1, B2]). This implies the existence of an equivalent metric  $d$  for which: (1) every two points are joined through a geodesic arc (given any  $x, y \in M$ , there is an isometric embedding  $\varphi : [0, d(x, y)] \hookrightarrow M$  with  $\varphi(0) = x$  and  $\varphi(d(x, y)) = y$ ); (2) closed balls are compact (Hopf-Rinow-Cohn-Vossen Theorem [BU, p.51]). Generalized Peano continua are at the threshold of metric geometry.

<sup>4</sup>An *n-manifold* (briefly, a *manifold*) is a separable metric space, locally homeomorphic to the  $n$ -cell  $\mathbb{D}^n = \{x \in \mathbb{R}^n : |x| \leq 1\}$ . Thus, manifolds are 2nd countable and Hausdorff (but possibly disconnected, noncompact, with boundary). As usual, *closed manifold* means compact and boundaryless. Except if otherwise mentioned, *all manifolds considered are assumed to be connected*.

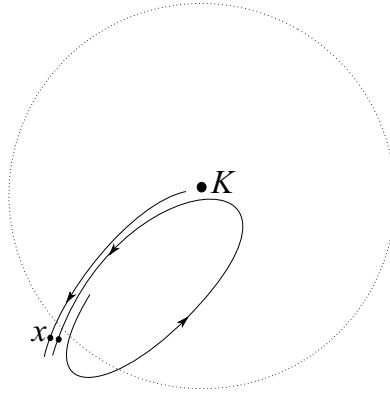

FIGURE 2.1. For non-wandering flows,  $K$  unstable  $\iff K$  (-)unstable.

It is conjectured (Busemann [BN]), that if every geodesic in an  $n$ -dimensional generalized Peano continuum  $M$  is locally prolongable and prolongations are unique, then  $M$  is a (boundaryless)  $n$ -manifold. This is confirmed in dimension  $n \leq 4$  and (apparently) open in higher dimensions (see [HR, BR]). However, even  $\mathbb{R}^2$  embeddable (generalized) Peano continua may display intricate fractal-like geometry and topology (as geodesics can have multiple prolongations, see e.g. [CH, Chap.1],[SA, Chap.9] for examples).

**Definition 1.** (*neighbourhoods and distance in  $M$* )  $[M, d]$  denotes the space  $M$  with metric  $d$ . Given  $x \in M$  (resp.  $Y \subset M$ ),  $\mathcal{N}_x$  (resp.  $\mathcal{N}_Y$ ) is the set of neighbourhoods of  $x$  (resp. of  $Y$ ) in  $M$ . For  $X, Y \subset M$ ,  $d(X, Y) := \inf\{d(x, y) : x \in X, y \in Y\}$ .

The classical concept of Lyapunov stability of compact invariant sets is now introduced. It is crucial to understand the much stronger dynamical constraints this notion imposes in the non-wandering setting. Given the relevance of non-wandering flows commanded by conservative dynamics, we shall deduce, throughout this paper, from the general results, the corresponding characterizations that are specific to this particularly important context.

Consider a  $C^0$  flow on  $M$  and a nonvoid, compact invariant set  $K \subset M$ .

**Definition 2.** (*stable / unstable*)  $K$  is (Lyapunov) *stable* if every  $U \in \mathcal{N}_K$  contains a positively invariant  $V \in \mathcal{N}_K$  ( $V = \mathcal{O}^+(V) \subset U$ , where  $\mathcal{O}^+(V) = \cup_{x \in V} \mathcal{O}^+(x)$  and  $\mathcal{O}^+(x) = \{x^t : t \geq 0\}$ ). Otherwise it is *unstable*. If every  $U \in \mathcal{N}_K$  contains a negatively invariant  $V \in \mathcal{N}_K$ , we say that  $K$  is (-)stable.  $K$  is *bi-stable* if it is both stable and (-)stable.

*Remark 2.* Throughout this paper, every mention to stability/instability is always in Lyapunov's sense.

## 2.2. Non-wandering setting.

*Remark 3.* The following elementary facts will be implicitly used throughout this paper: (a) a nonvoid proper subset of a connected metric space has nonvoid boundary; (b) in a locally compact metric space, compact subsets have arbitrarily small



compact neighbourhoods and both closed and open sets are locally compact; (c) a (+)invariant set has (+)invariant closure and interior.

It is easily seen that in a non-wandering flow, a stable (or (-)stable)  $K$  is always bi-stable: together, the density of recurrent points (Poincaré Recurrence Theorem)<sup>5</sup> and the continuity of the flow immediately imply that

$$K \text{ is unstable} \iff K \text{ is (-)unstable} \quad (\text{Fig. 2.1})$$

Therefore, in the context of *non-wandering flows*, a compact invariant set  $\emptyset \neq K \subsetneq M$  is either

- (1) *stable*  $\iff$  *(-)stable*  $\iff$  *bi-stable*,

in which case  $K$  has arbitrarily small compact invariant neighbourhoods; due to the connectedness of  $M$ , this implies that for any  $U \in \mathcal{N}_K$ ,  $U \setminus K$  contains infinitely many compact minimal sets (Proof. if  $K$  is bi-stable and  $U_0 \in \mathcal{N}_K$ , then  $U_0 \setminus K$  contains a compact minimal set: take a compact  $U \in \mathcal{N}_K$ ,  $M \neq U \subset U_0$ . As  $K$  is bi-stable, there are  $V_0, V_1 \in \mathcal{N}_K$  such that  $\mathcal{O}^-(V_0), \mathcal{O}^+(V_1) \subset U$ , hence  $V := \overline{\mathcal{O}(V_0 \cap V_1)} \subset U$ . Now  $V \neq M$  is a compact invariant neighbourhood of  $K$  and  $M$  is connected, thus  $\text{bd} V \subset U_0$  is a nonvoid compact invariant set disjoint from  $K$  and it contains at least one compact minimal set. Therefore, since there are arbitrarily small compact invariant neighbourhoods of  $K$ ,  $U_0 \setminus K$  contains infinitely many compact minimal sets), or

- (2) *unstable*  $\iff$  *(-)unstable*,

in which case there is an  $U \in \mathcal{N}_K$  and points  $z$  arbitrarily near  $K$  such that

$$\mathcal{O}^-(z) \not\subset U \text{ and } \mathcal{O}^+(z) \not\subset U$$

i.e. points arbitrarily near  $K$  escape from  $U$  both in the past and future. It should be mentioned that, in case (2), Ura-Kimura-Bhatia Theorem [BH, p.114] implies that, in the absence of a pair of points  $x, y \in K^c$  such that  $\emptyset \neq \alpha(x), \omega(y) \subset K$ , a kind of partial stability still takes place near  $K$ : there are points  $z \in K^c$  whose orbits remain forever (past and future) arbitrarily near  $K$  (i.e., for all  $U \in \mathcal{N}_K$ , there are orbits  $\mathcal{O}(z) \subset U \setminus K$ ). Obviously, both phenomena may coexist in dimension  $n \geq 2$ .

**2.3. (Lyapunov) hyper-stability.** We now introduce the central concept of this paper, Lyapunov hyper-stability. Briefly, the compact minimal sets are partitioned into Lyapunov stable and unstable ones, the hyper-stable being those that are *not* in the (Hausdorff metric) closure of the unstable. This actually amounts to having a neighbourhood in  $M$  intersecting no (Lyapunov) unstable compact minimal set (see below).

<sup>5</sup>Here we are invoking the following topological version of this celebrated result: *the set of recurrent points of a non-wandering  $C^0$  flow, on a locally compact metric space  $M$ , is Baire residual and thus dense in  $M$*  (Proof. for each  $0 \neq n \in \mathbb{Z}$ , let  $R_n = \{x \in M : \exists t \in [1, +\infty)n : d(x^t, x) < 1/|n|\}$ . Then  $R_n$  is open by continuity of the flow and dense in  $M$  since the flow is non-wandering. Therefore, the set of recurrent points,  $R = \bigcap_{0 \neq n \in \mathbb{Z}} R_n$ , is Baire residual in  $M$ ).

**Definition 3.**  $(\text{CMin}, \mathcal{S}, \mathcal{U})$   $\text{CMin}$  is the set of compact minimals of the flow and  $\mathcal{S}, \mathcal{U} \subset \text{CMin}$  the subsets of those that are, respectively, (Lyapunov) stable and unstable. For  $U \subset M$ ,

$$\text{CMin}(U) = \text{set of compact minimals contained in } U$$

$\mathcal{S}(U), \mathcal{U}(U)$  are defined in an analogue way.

*Remark 4.*  $\text{CMin}(U)$  and more generally  $\text{Ci}(U)$ , the set of nonvoid, compact invariant subsets of  $U$  are naturally endowed with the Hausdorff metric  $d_H$ ,  $\text{Ci}(U)$  being compact, if  $U$  is compact (see e.g. [TE, p.233]). The subscript  $H$  stands for Hausdorff metric concepts, e.g.  $\text{int}_H X$ ,  $\text{cl}_H X$  and  $\text{bd}_H X$  are, respectively, the interior, closure and boundary of  $X \subset [\text{CMin}, d_H]$ .

Let  $\Lambda \in \text{CMin}$ . The following three statements seem ordered by increasing strength:

- (1) every neighbourhood of  $\Lambda$  in  $M$  intersects some  $\Gamma \in \mathcal{U}$
- (2) every neighbourhood of  $\Lambda$  in  $M$  contains some  $\Gamma \in \mathcal{U}$
- (3) there is a sequence  $\Gamma_n \in \mathcal{U}$  such that  $\Gamma_n \xrightarrow{d_H} \Lambda$

However, they are actually equivalent. (1)  $\Rightarrow$  (2) : this is obvious if  $\Lambda \in \mathcal{U}$ , otherwise, given  $U \in \mathcal{N}_\Lambda$ , there is a compact, (+)invariant  $U \supset V \in \mathcal{N}_\Lambda$  (Lemma 1, Remark 5, below). By (1),  $V$  intersects some  $\Gamma \in \mathcal{U}$ , hence  $\Gamma \subset V \subset U$  (as  $\Gamma = \overline{\mathcal{O}^+(x)}$ , for each  $x \in \Gamma$ ); (2)  $\Rightarrow$  (3) : for each  $n \geq 1$ , take a  $\Gamma_n \in \mathcal{U}$  contained in  $B(\Lambda, 1/n)$ . Then (Lemma 6, below),  $\Gamma_n \xrightarrow{d_H} \Lambda$ ; (3)  $\Rightarrow$  (1) : this is obvious since  $d_H(\Gamma_n, \Lambda) < \varepsilon \implies \Gamma_n \subset B(\Lambda, \varepsilon)$ .

**Definition 4.** (*hyper-stable,  $H\mathcal{S}$* ) a compact minimal set  $\Lambda$  is (Lyapunov) *hyper-stable* if some neighbourhood of  $\Lambda$  in  $M$  intersects *no*  $\Gamma \in \mathcal{U}$ . For any  $U \subset M$ ,  $H\mathcal{S}(U)$  is the set of hyper-stable  $\Lambda \subset U$  and  $H\mathcal{S} := H\mathcal{S}(M) = \text{int}_H \mathcal{S}$ . Therefore,  $H\mathcal{S}^c$  is the set of compact minimals satisfying the three equivalent conditions (1) to (3), i.e.  $H\mathcal{S}^c = \text{cl}_H \mathcal{U}$  or, equivalently,  $H\mathcal{S} = \text{int}_H \mathcal{S}$ .

#### 2.4. Examples.

**Example 1.** The (frictionless) mathematical pendulum, described by  $\dot{x} = y$ ,  $\dot{y} = -\sin 2\pi x$ , whose phase space is the cylinder  $M = \mathbb{S}^1 \times \mathbb{R}$ . Every orbit, except three (one equilibrium with two homoclinic loops) is a hyper-stable compact minimal, and they are all periodic, with the exception of the lower equilibrium point, which is a centre.  $[H\mathcal{S}, d_H]$  is homeomorphic to the (separated) union of  $[0, 1)$  and two copies of  $\mathbb{R}$ .

**Example 2.** Simple (but instructive) models of 3-dimensional volume-preserving dynamics near a periodic orbit are given by the  $C^\infty$  vector fields

$$\begin{aligned} v_\lambda : M = \mathbb{S}^1 \times \mathbb{D}^2 &\longrightarrow \mathbb{R}^4 = \mathbb{C}^2 \\ (z_1, z_2) &\longmapsto (iz_1, i\lambda(|z_2|^2)z_2) \end{aligned}$$

where  $\lambda \in C^\infty([0, 1], \mathbb{R})$  and  $|\cdot|$  is the euclidean norm (see Fig. 2.2). Each torus  $\mathbb{S}^1 \times \mu\mathbb{S}^1$ ,  $0 < \mu \leq 1$ , is invariant and carries either a minimal subflow ( $\lambda(\mu^2) \in \mathbb{Q}^c$ )

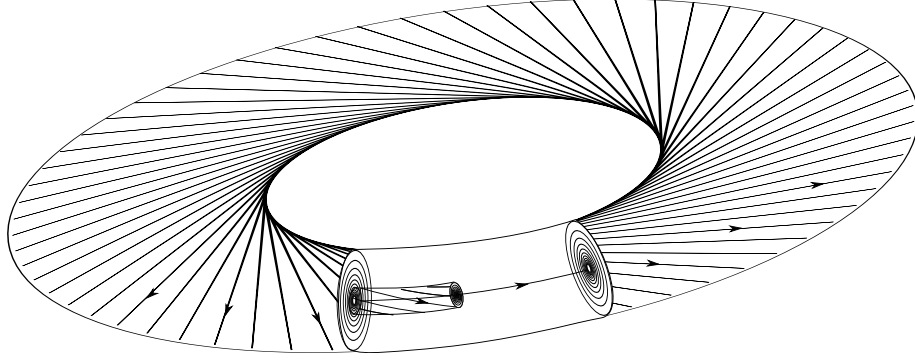

FIGURE 2.2. Example 2.

or foliates into periodic orbits ( $\lambda(\mu^2) \in \mathbb{Q}$ ). Thus, every point  $z \in M$  belongs to some  $\Lambda \in \text{CMin}$ . To understand the Lyapunov's nature of these minimal sets, three cases are particularly relevant ( $\simeq$  means homeomorphic):

- (1)  $\lambda = \text{const.} \in \mathbb{Q}$ , in which case  $[H\mathcal{S}, d_H] \simeq \mathbb{D}^2$ . This case defines the local fibre structure of Seifert fibrations [E1, p.67];
- (2)  $\lambda = \text{const.} \in \mathbb{Q}^c$ , in which case  $[H\mathcal{S}, d_H] \simeq \mathbb{D}^1$ ;
- (3)  $\lambda$  is constant in no nontrivial interval  $I \subset [0, 1]$ , in which case  $H\mathcal{S} = \emptyset$  (see below).

In general,  $\lambda$  is constant on each component of a (possibly empty) open set  $A \subset [0, 1]$ , and constant in no neighbourhood of each point  $x \in A^c$ . It follows that if  $\mu^2 \in A$ ,  $0 < \mu \leq 1$ , then every  $\Lambda \in \text{CMin}$  contained in the invariant torus  $\mathbb{S}^1 \times \mu\mathbb{S}^1$  is hyper-stable, otherwise

- it is an unstable periodic orbit, if  $\lambda(\mu^2) \in \mathbb{Q}$  (due to the existence of a sequence of minimal tori  $\mathbb{S}^1 \times \mu_n\mathbb{S}^1$ ,  $\mu_n \rightarrow \mu$ ,  $\lambda(\mu_n^2) \in \mathbb{Q}^c$ ,  $d_H$  converging to the torus  $\mathbb{S}^1 \times \mu\mathbb{S}^1$  containing the periodic orbit  $\Lambda$ );
- $\Lambda = \mathbb{S}^1 \times \mu\mathbb{S}^1$  is a stable, but not hyper-stable minimal torus, if  $\lambda(\mu^2) \in \mathbb{Q}^c$  (the stability of  $\Lambda$  is forced by the existence of sequences of minimal tori  $\mathbb{S}^1 \times \xi_n\mathbb{S}^1$ ,  $\xi_n \rightarrow \mu$ ,  $\lambda(\xi_n^2) \in \mathbb{Q}^c$ ,  $d_H$  converging to  $\Lambda$  from both sides, thus entailing the existence of arbitrarily small invariant neighbourhoods;  $\Lambda$  is not hyper-stable due to the existence of unstable periodic orbits in tori  $\mathbb{S}^1 \times \zeta_n\mathbb{S}^1$ ,  $\zeta_n \rightarrow \mu$ ,  $\lambda(\zeta_n^2) \in \mathbb{Q}$ , and thus in every neighbourhood of  $\Lambda = \mathbb{S}^1 \times \mu\mathbb{S}^1$ ).

The core periodic orbit  $\gamma = \mathbb{S}^1 \times \{0\}$  is always stable, being hyper-stable iff  $0 \in A$ .

## 2.5. Hyper-stability in flows with all orbits periodic.

**Definition 5.**  $\text{Per} :=$  the set of periodic orbits of the flow.

If a flows with all orbits periodic induces a circle bundle on  $M$ , then  $H\mathcal{S} = \text{Per}$  and  $[H\mathcal{S}, d_H]$  is homeomorphic to the base space of the bundle, which, however, may be a non-manifold (see Section 5.2).

**Example 3.** A classical example of a volume-preserving  $C^\omega$  periodic flow<sup>6</sup> inducing a nontrivial circle bundle is given by the Hopf flow on  $\mathbb{S}^{2n+1}$  ( $\mathbb{R}^{2n+2}$  identified with  $\mathbb{C}^{n+1}$ ),

$$(t, z) \mapsto e^{it} z$$

The base space of the induced bundle is  $\mathbb{C}P^n \simeq H\mathcal{S}$ , the case  $n = 1$ ,  $\mathbb{S}^1 \hookrightarrow \mathbb{S}^3 \rightarrow \mathbb{S}^2 \simeq \mathbb{C}P^1$  being the original Hopf fibration [DU, p.230].

It is possible that  $H\mathcal{S} = \text{Per}$ , even if a flows with all orbits periodic does not induce a circle bundle.  $C^1$  flows with all orbits periodic on orientable, closed 3-manifolds induce Seifert fibrations (Epstein, [E1]), which in general are not circle bundles. This guarantees that  $H\mathcal{S} = \text{Per}$  and also, that  $[H\mathcal{S}, d_H]$  is always a closed 2-manifold, a remarkable phenomenon unparalleled in the higher dimensions (see also Section 5.2, Example 4).

However, there are  $C^\infty$  flows with all orbits periodic on closed manifolds, for which  $H\mathcal{S} \subsetneq \text{Per}$  i.e.  $\mathcal{U} \neq \emptyset$ . Sullivan [SU] constructed a beautiful example of a such a flow (which can be made  $C^\omega$ ), on a closed 5-manifold, for which there is no bound to the lengths of the orbits. This implies (Epstein [E2, Theorem 4.3]) the existence of Lyapunov unstable orbits in the flow (take a convergent sequence  $x_n \in \gamma_n$ , where  $\gamma_n$  is a sequence orbits with no bound on their lengths. Then, the orbit  $\mathcal{O}(\lim x_n)$  is necessarily unstable).

### 3. MAIN LEMMAS. FIRST CONSEQUENCES

Lemmas 1 and 3 constitute the core tools for the comprehension of the dynamics near hyper-stable compact minimals. Lemma 3, in particular, essentially shows how each component of  $H\mathcal{S}$  inherits the local topological structure of the phase space (i.e. its local compactness and local connectedness).

**Lemma 1.** *Every  $\Lambda \in H\mathcal{S}$  has arbitrarily small compact, connected, (+)invariant neighbourhoods  $U$  in  $M$  such that  $\text{CMin}(U) \subset H\mathcal{S}$ .*

*Remark 5.* Except for the the conclusion  $\text{CMin}(U) \subset H\mathcal{S}$ , the same holds if  $\Lambda \in \mathcal{S}$ .

*Proof.*  $M$  is locally compact and  $\Lambda \in H\mathcal{S}$ , hence  $\Lambda$  has arbitrarily small compact neighbourhoods containing no  $\Gamma \in \text{cl}_H \mathcal{U}$  (Section 2.3). Let  $W$  be one of them. As  $\Lambda$  is stable and  $W$  is compact, there is a  $V \in \mathcal{N}_\Lambda$  such that  $\overline{\mathcal{O}^+(V)} \subset W$ . Take a minimal finite cover of  $\Lambda$  by sufficiently small connected open sets  $B_i \subset V$  ( $M$  is locally connected). Then  $U := \overline{\mathcal{O}^+(\cup B_i)} \subset W$  is a compact, connected (Remark 1.a), (+)invariant neighbourhood of  $\Lambda$  and  $\text{CMin}(U) \subset H\mathcal{S} = (\text{cl}_H \mathcal{U})^c$ .  $\square$

**Lemma 2.** *Suppose that*

- (a)  $K, K'$  are nonvoid, compact invariant sets;
- (b)  $\Lambda_n \in \text{CMin}$ ;
- (c)  $\alpha(x), \omega(x)$  are nonvoid, compact limit sets. Then,

<sup>6</sup>A flow  $\theta$  without equilibria is *periodic* if there is a  $t > 0$  such that  $\theta^t = \text{Id}$ .

- (1)  $\Lambda_n \xrightarrow{d_H} K$  and  $K' \subsetneq K \implies K'$  is unstable;
- (2)  $K' \subsetneq \omega(x) \implies K'$  is unstable;
- (3)  $K \subset \alpha(x)$  is stable  $\implies x \in K = \alpha(x)$ ;
- (4) if the flow is non-wandering and  $\omega(x)$  is stable, then  $x \in \omega(x)$ .

*Proof.* In each case, assume that the hypothesis hold.

(1) take  $y \in K \setminus K'$  and let  $d = d(y, K')$ . Given  $\varepsilon > 0$ , take  $n \in \mathbb{N}$  such that  $d' := d_H(\Lambda_n, K) < \min(\varepsilon, d/2)$ . Take  $a, b \in \Lambda_n$  such that

$$d(a, K') \leq d' < \varepsilon \quad \text{and} \quad d(b, y) \leq d' < d/2$$

As  $\Lambda_n$  is minimal, for some  $t > 0$ ,

$$d(a^t, b) < d/2 - d(b, y)$$

thus implying that

$$d(a^t, y) \leq d(a^t, b) + d(b, y) < d/2$$

which by its turn implies  $d(a^t, K') > d/2$ . Therefore,  $K'$  is unstable, as points arbitrarily near  $K'$  escape  $B(K', d/2)$  in positive time.

(2) let  $y \in \omega(x) \setminus K'$ . Given  $\varepsilon_0 > 0$ , take

$$0 < \varepsilon < \min(\varepsilon_0, d(y, K')/2)$$

Then, there are  $0 < t < T$  such that  $d(x^t, K') < \varepsilon < \varepsilon_0$  and  $d(x^t, y) < \varepsilon < d(y, K')/2$ , the last inequality implying  $d(x^t, K') > d(y, K')/2$ , hence  $K'$  is unstable as in (1).

(3)  $\emptyset \neq K \subset \alpha(x)$  and  $x \notin K$  obviously implies that  $K$  is unstable, therefore  $x \in K$  and  $K = \alpha(x)$  (as  $K$  is a closed invariant set).

(4)  $\omega(x)$  has arbitrarily small invariant neighbourhoods (Section 2.2), hence no point outside  $\omega(x)$  may have  $\omega(x)$  as  $\omega$ -limit.  $\square$

**Lemma 3.** *Let  $U$  be a nonvoid, compact, connected, (+)invariant set such that  $\text{CMin}(U) \subset H\mathcal{S}$ . Then:*

- (1) ( $\omega$ -limits are in  $H\mathcal{S}(U)$ )  $x \in U \implies \emptyset \neq \omega(x) \in H\mathcal{S}(U)$ ;
- (2) ( $\omega$ -limits convergence)  $U \ni x_n \rightarrow x \implies \omega(x_n) \xrightarrow{d_H} \omega(x)$ ;
- (3) (escaping orbits)  $x \in U$  and  $x \notin \omega(x) \implies \mathcal{O}^-(x) \not\subset U$ ;
- (4) ( $H\mathcal{S}(U)$  is a continuum)  $H\mathcal{S}(U)$  is  $d_H$  compact and connected.

**Definition 6.** if  $C \subset \text{CMin}$ , then  $C^* := \bigcup_{\Lambda \in C} \Lambda \subset M$ .

*Proof.* (1) since  $U$  is compact and (+)invariant,  $\emptyset \neq \omega(x) \subset U$  is compact, for every  $x \in U$  and it must be a minimal set (stable by hypothesis), otherwise there is an unstable compact minimal set  $\Lambda \subsetneq \omega(x)$  (Lemma 2.2), contradicting  $\text{CMin}(U) \subset H\mathcal{S}$ .

(2) let  $U \ni x_n \rightarrow x$ . Since  $U$  is compact and the  $\omega(x_n)$ 's are nonvoid compact invariants, by Blaschke Principle ([TE, p.233]), there is a subsequence  $\omega(x_{n'}) \xrightarrow{d_H} \Gamma$ , for some  $\Gamma \in \text{Ci}(U)$  (see Remark 4 above). Reasoning by contradiction, suppose

that  $\Gamma \neq \omega(x)$ . Take  $z \in \Gamma \setminus \omega(x) \neq \emptyset$  ( $\omega(x)$  is minimal by (1)). Then, by continuity of the flow, there are sequences  $0 < t_n < T_n$  such that

$$d(x_n^{t_n}, \omega(x)) \rightarrow 0 \quad \text{and} \quad d(x_n^{T_n}, z) \rightarrow 0$$

which implies that  $\omega(x)$  is unstable, contradicting (1). Hence, every subsequence  $\omega(x_{n'})$  of  $\omega(x_n)$  contains a subsequence  $\omega(x_{n''}) \xrightarrow{d_H} \omega(x)$ , trivially implying that  $\omega(x_n) \xrightarrow{d_H} \omega(x)$ .

(3) suppose that  $x \in U$  and  $x \notin \omega(x)$ . Then,  $\mathcal{O}^-(x) \not\subset U$ , otherwise  $\emptyset \neq \alpha(x) \subset U$  is compact, implying that  $\alpha(x)$  contains a compact minimal set  $\Gamma$  and  $x \notin \Gamma$  (since  $x \notin \omega(x)$ ), thus implying (Lemma 2.3) that  $\Gamma \in \text{CMin}(U)$  is unstable, contradiction. Actually,

$$\exists T \leq 0 : x^{(-\infty, T)} \subset U^c \quad \text{and} \quad x^{[T, +\infty)} \subset U$$

since  $U$  being compact and (+)invariant,

$$-\infty < T := \min\{t \leq 0 : x^{[t, 0]} \subset U\} \leq 0$$

is well defined and has the required properties.

(4.1)  $H\mathcal{S}(U)$  is  $d_H$  compact: given a sequence  $\Lambda_n \in H\mathcal{S}(U) = \text{CMin}(U)$ , take a convergent subsequence  $x_{n'} \in \Lambda_{n'}$  ( $U$  is compact). Then,  $\Lambda_{n'} = \omega(x_{n'})$  and by (2) and (1)

$$\omega(x_{n'}) \xrightarrow{d_H} \omega(\lim x_{n'}) \in H\mathcal{S}(U).$$

(4.2)  $H\mathcal{S}(U)$  is  $d_H$  connected: reasoning by contradiction assume it is not. Then, by (4.1),  $H\mathcal{S}(U)$  is the union of two nonvoid, disjoint compacts  $C_0, C_1 \subset H\mathcal{S}(U)$ .

*Claim.*  $C_0^*, C_1^* \subset U$  are nonvoid, disjoint compacts: they are obviously nonvoid. Fix  $j \in \{0, 1\}$ . Let  $x_n \in C_j^*$ . Each  $x_n$  belongs to some  $\Lambda_n \in C_j$ . Take a convergent subsequence  $\Lambda_{n'} \xrightarrow{d_H} \Lambda \in C_j$ .  $U$  being compact,  $x_{n'}$  has a convergent subsequence  $x_{n''} \rightarrow x \in U$ . But  $\Lambda_{n''} \xrightarrow{d_H} \Lambda$  implies that  $x \in \Lambda$ , thus  $x \in C_j^*$  and  $C_j^*$  is compact.  $C_0^*, C_1^*$  are disjoint since  $C_0 \cap C_1 = \emptyset$  and distinct minimal sets are disjoint.

Now let

$$\Omega_j := \{x \in U : \omega(x) \in C_j\}, \quad \text{for } j = 0, 1$$

We show that these two sets form a nontrivial partition of  $U$  into closed subsets, thus getting a contradiction. Since  $C_0 \cap C_1 = \emptyset$ ,  $\Omega_0 \cap \Omega_1 = \emptyset$ ;  $\Omega_0 \neq \emptyset \neq \Omega_1$  since  $C_j^* \subset \Omega_j$ . Also, since  $C_0, C_1 \subset H\mathcal{S}(U)$  are closed, by (2), both  $\Omega_0$  and  $\Omega_1$  are closed in  $U$ . Finally, by (1),  $U = \Omega_0 \sqcup \Omega_1$ , hence  $U$  is disconnected.  $\square$

**Lemma 4.**  $H\mathcal{S}$  is  $d_H$  locally compact and locally connected.

*Proof.* Let  $\mathfrak{N}$  be a neighbourhood of  $\Lambda$  in  $H\mathcal{S}$ . By Lemmas 1 and 7 (below), there is a compact, connected, (+)invariant neighbourhood  $U$  of  $\Lambda$  in  $M$  such that  $H\mathcal{S}(U)$  is a neighbourhood of  $\Lambda$  in  $H\mathcal{S}$ , contained in  $\mathfrak{N}$ . By Lemma 3.4,  $H\mathcal{S}(U)$  is  $d_H$  compact and connected i.e. a continuum in the  $d_H$  metric.  $\square$

**3.1. Topological detection of Lyapunov instability.** We can now establish criteria permitting to detect the presence of Lyapunov unstable compact minimal sets in arbitrarily small neighbourhoods of a given compact minimal set  $\Lambda$  i.e. criteria detecting that  $\Lambda \in \text{cl}_H \mathcal{U}$ . The following result is an immediate consequence of Lemma 4 (as  $H\mathcal{S}^c = \text{cl}_H \mathcal{U}$  is a closed subset of CMin). Although trivially  $1 \implies 2$ , we list both conditions as it is often useful to have the simplest possible sufficient conditions in mind.

**Corollary 1.** *Let  $\Lambda \in \text{CMin}$ . If any of the following three conditions holds, then  $\Lambda \in \text{cl}_H \mathcal{U}$  i.e. every neighbourhood of  $\Lambda$  in  $M$  contains Lyapunov unstable compact minimal sets:*

- (1) CMin is not locally connected at  $\Lambda$ ;
- (2)  $\Lambda$  has no locally connected neighbourhood in CMin;
- (3)  $\Lambda$  has no compact neighbourhood in CMin.

From Corollary 1 we can draw some interesting conclusions: for instance, if CMin is nowhere locally connected, then every neighbourhood of each compact minimal set contains infinitely many Lyapunov unstable compact minimals. This follows observing that nowhere locally connected sets have no isolated elements. Actually, we have the following stronger

**Criterion:** *If any of the following two conditions holds, then every neighbourhood of each compact minimal set of the flow contains infinitely many Lyapunov unstable compact minimals:*

- (1) CMin is not locally connected at a dense subset of its points;<sup>7</sup>
- (2) no point of CMin has both a compact neighbourhood and a locally connected neighbourhood.

**Definition 7.** (*attractor / repeller*) a nonvoid, compact invariant set  $\Delta$  is an *attractor* if it is (Lyapunov) stable and

$$B^+(\Delta) := \{x \in M : \emptyset \neq \omega(x) \subset \Delta\} \in \mathcal{N}_\Delta$$

i.e. if it is asymptotically stable.  $B^+(\Delta)$  is the *attraction basin* of  $\Delta$ .  $\mathcal{A} \subset H\mathcal{S}$  is the set of (compact) minimal attractors.  $\Delta$  is a *repeller* if it is an attractor in the time-reversed flow. Its *repulsion basin* is defined in the obvious way. Note that, when the phase space  $M$  is compact,  $M$  is always both an attractor and a repeller in any flow. This is the only possible attractor (resp. repeller) if the flow is non-wandering (as attractors are simultaneously stable and isolated, see (1) in Section 2.2 and Definition 8 below).

Local connectedness of  $H\mathcal{S}$  (Lemma 4), permits a straightforward deduction of topological-dynamical results that otherwise seem somewhat surprising. For instance, while  $\mathcal{A} \subset H\mathcal{S}$ , hyper-stable compact minimals cannot be surrounded by attractors:

**Corollary 2.** *Let  $\Lambda$  be a compact minimal set. If every neighbourhood of  $\Lambda$  in  $M$  contains an attractor (not necessarily a minimal set), then either*

<sup>7</sup>See the Cantor star example in the introduction to this paper.

- (1)  $\Lambda$  is an attractor (the unique one inside its basin), or
- (2)  $\Lambda \in \text{cl}_H \mathcal{U}$  i.e. every neighbourhood of  $\Lambda$  in  $M$  also contains Lyapunov unstable compact minimal sets.

Therefore, if  $\Lambda \in H\mathcal{S}$  then attractors  $\Gamma \neq \Lambda$  cannot occur arbitrarily near  $\Lambda$ .

*Remark 6.* The existence of a sequence of attractors  $\Delta_n \neq \Lambda \in \text{CMin}$  such that  $\Delta_n \subset B(\Lambda, 1/n) \subset M$  thus implies the existence of another sequence  $\mathcal{U} \ni \Gamma_n \xrightarrow{d_H} \Lambda$ .

*Proof.* Assume that  $\Lambda \notin \text{cl}_H \mathcal{U}$ . By Lemma 4  $\Lambda$  has connected neighbourhoods in  $\text{CMin}$ . We show that the only possible such neighbourhood is  $\{\Lambda\}$  i.e.  $\Lambda$  is  $d_H$  isolated in  $\text{CMin}$ , hence  $\Lambda$  is an attractor (see Corollary 5 ahead). Let  $\mathfrak{N}$  be a connected neighbourhood of  $\Lambda$  in  $\text{CMin}$ . We claim that given  $\varepsilon > 0$ , there is a compact minimal set  $\Gamma$  such that  $d_H(\Gamma, \Lambda) < \varepsilon$  and the connected component of  $\Gamma$  in  $\text{CMin}$  has  $d_H$  diameter less than  $\varepsilon$ . Since for  $\varepsilon$  sufficiently small  $\Gamma$  belongs to  $\mathfrak{N}$ , the  $d_H$  diameter of  $\mathfrak{N}$  must be zero i.e.  $\mathfrak{N} = \{\Lambda\}$ . To prove the claim: given  $\varepsilon > 0$ , by Lemma 6 there is an open neighbourhood  $U$  of  $\Lambda$  in  $M$  such that  $d_H(\Gamma, \Lambda) < \varepsilon/2$  for every compact minimal set  $\Gamma \subset U$ . By hypothesis, there is an attractor  $Q \subset U$  and  $Q$  contains at least one  $\Gamma \in \text{CMin}$ . Clearly the attraction basin  $B(Q)$  is an open invariant set containing  $Q$  such that  $B(Q) \setminus Q$  intersects no compact minimal. Therefore, all compact minimals belonging to the connected component  $\Theta$  of  $\Gamma$  in  $\text{CMin}$  must be contained in  $Q$ , hence  $\text{diam}_H \Theta < \varepsilon$ .  $\square$

**3.2.  $H\mathcal{S}$  is locally a Peano continuum.** One of our main goals is to prove that  $H\mathcal{S}$  is locally a Peano continuum. Observe that Lemma 4 does not prove this i.e. it does not show that each  $\Lambda \in H\mathcal{S}$  has arbitrarily small compact, connected and locally connected neighbourhoods in  $H\mathcal{S}$  (in relation to the Hausdorff metric  $d_H$ ). While, by Lemma 1,  $\Lambda$  has arbitrarily small compact, connected, (+)invariant neighbourhoods  $U$  in  $M$  such that  $\text{CMin}(U) \subset H\mathcal{S}$ , implying, by Lemma 3.4, that  $H\mathcal{S}(U)$  is a continuum and thus (Lemma 4) that  $H\mathcal{S}$  is locally a continuum, the difficulty of following this approach lies in guarantying that  $U$  is locally connected at every  $x \in \text{bd} U$ . We overcome this difficulty taking a more direct path: we show, through Peano Continuum Theory, that  $H\mathcal{S}$  is locally a Peano continuum.

**Lemma 5.** *Generalized Peano continua are locally Peano continua.*

*Proof.* We first show that

(1) *Peano continua are locally Peano continua:* let  $X$  be a Peano continuum. Given  $x \in X$  and  $U \in \mathcal{N}_x$ , take  $\varepsilon > 0$  such that  $B(x, \varepsilon) \subset U$ .  $X$  is the union of finitely many Peano continua  $X_i$  with  $\text{diam} X_i < \varepsilon$  [NA, p.124, 8.10]. Let  $V$  be the union of the  $X_i$ 's that contain  $x$ , say  $V = \cup_{i=1}^n X_i$ .  $V$  is compact and connected (i.e. a continuum) and  $U \supset V \in \mathcal{N}_x$ , since  $V^c$  is contained in a compact not containing  $x$ .

*Claim.  $V$  is locally connected:* given  $z \in V$  and a neighbourhood  $W$  of  $z$  in  $V$ , let  $\beta$  be the set of the  $1 \leq i \leq n$  such that  $z \in X_i$ . For each  $i \in \beta$  take a connected neighbourhood  $C_i$  of  $z$  in  $X_i$  contained in  $W$ . Since the  $X_i$ 's are compact and finite



in number, it is easily seen that  $C := \cup_{i \in \beta} C_i \subset W$  is a connected neighbourhood of  $z$  in  $V$ . Therefore, besides compact and connected,  $V$  is locally connected and thus a Peano continuum, hence (1) is proved.

(2) *Generalized Peano continua are locally Peano continua*: let  $X$  be a generalized Peano continuum. Since (2) coincides with (1) if  $X$  is compact assume it is not. Let  $X^\infty = X \sqcup \{\infty\}$  be a 1-point compactification of  $X$  (on  $X$ , the metric  $d'$  of  $X^\infty$  is equivalent to the original metric  $d$  of  $X$ ). Then  $X^\infty$  is compact, connected and locally connected at every point  $x \in X = X^\infty \setminus \{\infty\}$  and thus also at  $\infty$  [NA, p.78, 5.13]. Hence  $X^\infty$  is a Peano continuum, therefore, by (1),  $X^\infty$  is locally a Peano continuum and so is its open subset  $X$ .  $\square$

**Corollary 3.**  $H\mathcal{S}$  is

- (1) *locally a Peano continuum,*
- (2) *the union of countably many disjoint, clopen, generalized Peano continua.*

*Proof.* By Lemma 4,  $H\mathcal{S}$  is  $d_H$  locally connected, thus each component is open. As  $H\mathcal{S}$  is also  $d_H$  locally compact, each component is actually a generalized Peano continuum. Hence, (1) follows from Lemma 5. It remains to show that  $H\mathcal{S}$  has countably many components.  $H\mathcal{S}$  is  $d_H$  separable, since  $\text{CMin} \supset H\mathcal{S}$  is (see [TE, p.258, Lemma 10]). The conclusion follows, since the components of  $H\mathcal{S}$  are open.  $\square$

The next result is valid for  $C^0$  flows on locally compact metric spaces.

**Lemma 6.** *Let  $\Lambda_{n \geq 0} \in \text{CMin}$ . Suppose that for any  $\varepsilon > 0$ , there is an  $m \geq 1$  such that  $n > m \implies \Lambda_n \subset B(\Lambda_0, \varepsilon)$ . Then,  $\Lambda_n \xrightarrow{d_H} \Lambda_0$ .*

*Proof.* see [TE, p.255, Lemma 4].  $\square$

From Lemma 6 we easily deduce

**Lemma 7.** *Given any neighbourhood  $\mathfrak{N}$  of  $\Lambda \in H\mathcal{S}$  in  $[H\mathcal{S}, d_H]$ , for every sufficiently small neighbourhood  $U$  of  $\Lambda$  in  $M$ ,  $H\mathcal{S}(U)$  is a neighbourhood of  $\Lambda$  in  $H\mathcal{S}$ , contained in  $\mathfrak{N}$ . If  $U$  is open in  $M$ , then  $H\mathcal{S}(U)$  is  $d_H$  open in  $H\mathcal{S}$ .*

*Proof.* see [TE, p.255, Lemma 6 and its proof].  $\square$

#### 4. GLOBAL AND LOCAL STRUCTURE OF $H\mathcal{S}$ AND THE DYNAMICS AROUND IT

We are now in possession of all the tools needed to prove the main results of this paper, both in the global and local settings (Sections 4.1.1 and 4.1.2). If the flow is non-wandering, the inherent dynamical constraints make these characterizations assume a particularly elegant form (Section 4.2). Section 4.1.3 calls attention to a crucial difference between the local topologies of  $H\mathcal{S} \subset \text{CMin}$  and  $H\mathcal{S}^* \subset M$  (this disparity vanishes in dimensions 1 and 2).

*Remark 7.* All results in this section hold for arbitrary continuous flows on connected manifolds (possibly noncompact or with boundary, see Remark 1.c).

#### 4.1. Arbitrary flows.

##### 4.1.1. $H\mathcal{S}$ globally.

**Theorem 1.** (*Global Structure of  $H\mathcal{S}$* ) Let  $\theta$  be a  $C^0$  flow on a generalized Peano continuum  $M$ . Endowed with the Hausdorff metric,  $H\mathcal{S}$  is the union of countably many disjoint, clopen, generalized Peano continua  $X_i$  (each admitting a complete geodesic metric). Moreover, there are disjoint, connected, open invariant sets  $A_i \subset M$  such that:

- (1)  $X_i^* \subset A_i$
- (2)  $A_i = \{x \in M : \emptyset \neq \omega(x) \in X_i \subset H\mathcal{S}\}$
- (3) for any  $x \in A_i$ ,  $x \notin \omega(x)$  implies  $\alpha(x) \subset \text{bd}A_i$  (possibly  $\alpha(x) = \emptyset$ ).

(see Fig. 1.4)

*Remark 8.* (a) if  $M$  is compact and the flow is minimal, then the unique  $X_i$  is  $\{M\}$  and  $A_i = M$ ;

(b) if  $H\mathcal{S} = \emptyset$ , then the collection  $\{X_i\}$  is empty;

(c) if  $X_i$  contains a unique  $\Lambda \neq M$ , then  $\Lambda$  is a proper attractor and  $A_i$  its basin;

(d) otherwise,  $X_i$  is a non-degenerate generalized Peano continuum and thus contains  $\mathfrak{c}$  hyper-stable compact minimals ( $X_i$  contains nontrivial arcs of  $H\mathcal{S}$ );

(e) although  $X_i^*$  may be noncompact, it roughly acts as an attracting set in the flow, with basin  $A_i$  (see Fig. 1.4);

(f) if  $A_i = M$  then, for every  $x \in M$ , either  $x \in \omega(x) \in H\mathcal{S}$  or  $\alpha(x) = \emptyset$  (and in the later case,  $M$  is noncompact).

**Corollary 4.**  $H\mathcal{S}$  is countable iff it is  $d_H$  discrete iff every  $\Lambda \in H\mathcal{S}$  is an attractor.

*Proof.* (of Theorem 1) Let  $\{X_i\}$  be the components of  $H\mathcal{S}$ . The first conclusion of Theorem 1 is (2) of Corollary 3, together with Remark 1.c.

Let  $A_i$  be defined as in (2). Then  $\Lambda \in X_i \implies \omega(x) = \Lambda$ , for every  $x \in \Lambda$ , thus  $\Lambda^* \subset A_i$ , hence (1)  $X_i^* \subset A_i$ . As the  $X_i$ 's are disjoint, so are the  $A_i$ 's. Since points in the same orbit have the same  $\omega$ -limit, each  $A_i$  is invariant. It is also open: suppose that  $x \in A_i$  i.e.  $\omega(x) \in X_i$ . Take a neighbourhood  $U$  of  $\omega(x) \in H\mathcal{S}$  in  $M$  as in Lemma 1, sufficiently small so that  $H\mathcal{S}(U) \subset X_i$  (Lemma 7, using the fact that  $X_i$  is open in  $H\mathcal{S}$ ). By continuity of the flow, taking a sufficiently small  $B \in \mathcal{N}_x$ ,  $\mathcal{O}^+(y) \cap \text{int} U \neq \emptyset$ , for every  $y \in B$ , thus implying (Lemma 3.1)  $\omega(y) \in H\mathcal{S}(U) \subset X_i$  and thus  $y \in A_i$ . Therefore  $A_i$  is open in  $M$ .  $A_i$  is connected since  $X_i^*$  is connected and for every  $x \in A_i$ ,  $\mathcal{O}(x) \cup \omega(x) \subset A_i$  is connected and  $\omega(x) \subset X_i^*$  ( $X_i^*$  is connected: this is trivial noting that any nontrivial partition of  $X_i^*$  into closed sets entails a nontrivial partition of  $X_i$  into closed sets, as each  $\Lambda \in X_i$  is a minimal, thus connected).

It remains to prove (3). Suppose  $x \in A_i$  and  $x \notin \omega(x)$ . As  $A_i$  is open and invariant,  $\alpha(x) \subset \overline{A_i} = A_i \sqcup \text{bd}A_i$ . Reasoning by contradiction, suppose that  $y \in \alpha(x) \cap A_i \neq \emptyset$ . Then,  $\omega(y) \subset \alpha(x)$  and  $\omega(y) \in X_i \subset H\mathcal{S}$ . Since  $x \notin \omega(y)$  (otherwise  $x \in \omega(x)$ ), as  $\omega(y)$  is minimal,  $\omega(y)$  is unstable (Lemma 2.3), contradiction. Therefore  $\alpha(x) \subset \text{bd}A_i$ . If  $M$  is noncompact it is obviously possible that  $\alpha(x) = \emptyset$ .  $\square$

4.1.2.  $H\mathcal{S}$  locally.

**Theorem 2.** (Local behaviour) *Let  $\Lambda$  be a compact minimal set of a  $C^0$  flow on a generalized Peano continuum  $M$ . Then, either*

- (1)  $\Lambda \in \text{cl}_H \mathcal{U}$ , or
- (2)  $\Lambda$  is an attractor, or
- (3) there are arbitrarily small compact, connected, (+)invariant neighbourhoods  $U$  of  $\Lambda$  in  $M$  such that:
  - (a) the (compact) minimal sets contained in  $U$  are all Lyapunov hyperstable and their set  $H\mathcal{S}(U)$  is a non-degenerate Peano continuum;
  - (b) for each  $x \in U$ ,  $\omega(x) \in H\mathcal{S}(U)$  and if  $x \notin \omega(x)$ , then its negative orbit leaves  $U$  (and thus never returns again).

(see Fig. 1.3)

**Remark 9.** • (1) holds iff  $\Lambda \notin H\mathcal{S}$  i.e. if there is a sequence  $\mathcal{U} \ni \Lambda_n \xrightarrow{d_H} \Lambda$  (Section 2.3). If  $\Lambda$  is unstable, then this trivially holds since  $\Lambda_n := \Lambda$  is such a sequence;

- if  $\Lambda = M$  (i.e.  $M$  is compact and the flow is minimal), then (2) trivially holds;
- (3.a) implies that, endowed with the Hausdorff metric,  $H\mathcal{S}(U)$  is compact, nontrivially arcwise connected ( $\implies |H\mathcal{S}(U)| = \mathfrak{c}$ ), locally arcwise connected and admits a complete geodesic metric (see Remark 1.c);
- the final conclusion in (3.b) can be written as:

$$\exists T \leq 0 : x^{(-\infty, T)} \subset U^c \text{ and } x^{[T, +\infty)} \subset U$$

(see the proof of Lemma 3).

**Definition 8.**  $\Lambda \in \text{CMin}$  is *isolated (from minimals)* if there is an  $U \in \mathcal{N}_\Lambda$  containing no compact minimal set other than  $\Lambda$ . This is equivalent to  $\Lambda$  being  $d_H$  isolated in  $\text{CMin}$  (by the  $d_H$  metric definition and Lemma 6).

**Corollary 5.** *If  $\Lambda \in \mathcal{S}$  is isolated, then it is an attractor.*

*Proof.* If  $\Lambda \in \mathcal{S}$  is isolated, then neither (1) nor (3) of Theorem 2 can hold, since both imply the existence of compact minimals  $\Gamma \neq \Lambda$  contained in every neighbourhood of  $\Lambda$ .  $\square$

*Proof. (of Theorem 2)* The three conditions are mutually exclusive.

(A) if  $\Lambda \notin H\mathcal{S}$ , then (1) holds (Section 2.3).

(B) suppose  $\Lambda \in H\mathcal{S}$ . Let  $X_i$  be the component of  $H\mathcal{S}$  to which  $\Lambda$  belongs (see the proof of Theorem 2). We distinguish two cases:

(B.1) if  $X_i = \{\Lambda\}$ , then  $\Lambda$  is stable and  $A_i \in \mathcal{N}_\Lambda$  (Theorem 1) is its region of attraction, thus  $\Lambda$  is an attractor and  $A_i$  its basin. Hence (2) holds.

(B.2) otherwise, let  $\mathfrak{N}$  be a Peano continuum neighbourhood of  $\Lambda$  in  $H\mathcal{S}$ , contained in  $X_i$  ( $X_i$  is open in  $H\mathcal{S}$  (Theorem 1) and  $H\mathcal{S}$  is locally a Peano continuum (Corollary 3)). As  $X_i$  is non-degenerate (i.e.  $|X_i| > 1$ ), so is  $\mathfrak{N}$ . Take a sufficiently small compact, connected, (+)invariant neighbourhood  $V$  of  $\Lambda$  in  $M$  such that  $\text{CMin}(V) \subset \mathfrak{N}$  (Lemmas 1 and 7). Observe that  $\mathfrak{N}^* \subset M$  is (a) compact:  $\mathfrak{N}$  is  $d_H$  compact, hence given sequences  $x_n \in \Lambda_n \in \mathfrak{N}$ , there is a convergent subsequence

$\Lambda_{n'} \xrightarrow{d_H} \Lambda \in \mathfrak{N}$ . We may assume that all  $\Lambda_{n'}$ 's are contained in some compact neighbourhood  $W$  of  $\Lambda$  in  $M$  ( $\Lambda$  is compact and  $M$  is locally compact). The conclusion follows since  $x_{n'}$  has a convergent subsequence  $x_{n''} \rightarrow x \in W$  and necessarily  $x \in \Lambda$ , as  $x_{n''} \in \Lambda_{n''} \xrightarrow{d_H} \Lambda$ ; (b) connected (as  $X_i^*$  in the proof of Theorem 1) and (c) invariant (union of minimal sets). Then  $U := V \cup \mathfrak{N}^*$  is a compact, connected, (+)invariant neighbourhood of  $\Lambda$  in  $M$  and  $\text{CMin}(U) = \mathfrak{N} \subset H\mathcal{S}$ . Thus (3.a) is proved; (3.b) follows from Lemma 3.1 and 3.3, since  $\text{CMin}(U) \subset H\mathcal{S}$ .  $\square$

**4.1.3. Topology of  $H\mathcal{S}^* \subset M$ .** It is easily seen that, as  $H\mathcal{S}, H\mathcal{S}^* \subset M$  is locally compact and that  $\{X_i^*\}$  are its (clopen) components ( $\{X_i\}$  being the components of  $H\mathcal{S}$ ). But while  $H\mathcal{S}$  is locally connected (in relation to the  $d_H$  metric), the corresponding set of points  $H\mathcal{S}^*$  needs not to be a locally connected subset of  $M$ . The local topology of the minimal sets  $\Lambda \in H\mathcal{S}$  plays a determinant role here. Actually,  $H\mathcal{S}^*$  may be nowhere locally connected, even if the flow is smooth. Handel's by product example [HA, p.166] can be transferred to  $\mathbb{S}^2$ , to yield an orientation preserving  $C^\infty$  diffeomorphism  $f : \mathbb{S}^2 \circlearrowleft$  with only three minimal sets, two repelling fixed points (the north and south poles  $\pm p$ ) and an attracting pseudo-circle  $P$ , with basin  $\mathbb{S}^2 \setminus \{\pm p\}$ . The pseudo-circle is nowhere locally connected. Taking the suspension of  $f$ , we get a  $C^\infty$  flow  $v^t$  on  $\mathbb{S}_f^2 \simeq \mathbb{S}^2 \times \mathbb{S}^1$ ,<sup>8</sup> with a nowhere locally connected attracting minimal set  $\Lambda = P_f$  (locally,  $\Lambda$  is homeomorphic to the Cartesian product of  $\mathbb{D}^1$  and some open subset of  $P$ , hence it is nowhere locally connected). In this flow,  $H\mathcal{S} = \{\Lambda\} \simeq \{0\}$  and  $H\mathcal{S}^* = \Lambda$ , therefore  $H\mathcal{S}^*$  is nowhere locally connected. Examples of  $C^\infty$  flows in higher dimensions, with  $H\mathcal{S}^*$  nowhere locally connected, are generated by the vector fields

$$(x, y) \mapsto (v(x), 0) \quad \text{on} \quad (\mathbb{S}^2 \times \mathbb{S}^1) \times \mathbb{S}^k, \quad k \geq 1$$

where  $v$  is the original vector field on  $\mathbb{S}^2 \times \mathbb{S}^1$ . Then,

$$H\mathcal{S} = \{P_f \times \{y\} : y \in \mathbb{S}^k\} \simeq \mathbb{S}^k \quad \text{and} \quad H\mathcal{S}^* = P_f \times \mathbb{S}^k$$

is locally homeomorphic to the Cartesian product of  $\mathbb{D}^{k+1}$  and an open subset of  $P$ , hence nowhere locally connected.

However, for  $C^0$  flows on arbitrary 2-manifolds (possibly nonorientable, noncompact, with boundary),  $H\mathcal{S}^*$  is *always* a locally connected subset of  $M$ . Actually, each (clopen) component  $X_i^*$  of  $H\mathcal{S}^*$  either

- (1) contains more than 2 equilibria, in which case it consists entirely of equilibria, hence  $X_i^* \simeq X_i$ , implying that  $X_i^*$  is locally connected (see Theorem 1), or
- (2) contains no more than 2 equilibria, in which case  $X_i^*$  is a (connected)  $k$ -manifold ( $0 \leq k \leq 2$ ).

The key fact to establish (2) is the following result of Athanassopoulos and Strantzalos [AT]:

<sup>8</sup>We may actually identify these two manifolds and suppose  $v^t$  defined on  $\mathbb{S}^2 \times \mathbb{S}^1$ , as homeomorphic 3-manifolds are  $C^\infty$  diffeomorphic.

**Theorem.** *A Lyapunov stable compact minimal set of a  $C^0$  flow on an arbitrary 2-manifold is either an equilibrium orbit, or a periodic orbit, or a torus.*

The reader is invited to look up for the 13 possible manifolds (up to homeomorphism) that might occur as  $X_i^*$  in case (2).

**4.2. Non-wandering flows.** Note that, in virtue of Poincaré Recurrence Theorem, all results below are valid, not only, for conservative flows on finite volume manifolds, but also for any flows topologically equivalent to these ones (being non-wandering is a topological equivalence invariant). This includes conjugations via homeomorphisms and time reparametrizations.

*Remark 10.* The results in this section are, in general, false if the flow is *not* non-wandering (even when  $M$  is compact), the north-south flow on  $\mathbb{S}^n$  being a trivial counter-example to all of them.

**Theorem 3.** *(Global structure of  $H\mathcal{S}$ ) Given a  $C^0$  non-wandering flow on a generalized Peano continuum  $M$ , either*

- (1)  $H\mathcal{S} = \emptyset$  i.e. the Lyapunov unstable compact minimal sets are  $d_H$  dense in  $\text{CMin}$ , or
- (2)  $H\mathcal{S} = \{M\}$  i.e.  $M$  is compact and the flow is minimal, or
- (3)  $H\mathcal{S}$  is the union of  $1 \leq \beta \leq \aleph_0 = |\mathbb{N}|$  disjoint, clopen, non-degenerate generalized Peano continua  $X_{i \in \beta}$ , each  $X_i^* \subset M$  being a (nonvoid) connected, open invariant set.

*Proof.* The three conditions are mutually exclusive. Assume (1) and (2) fail. Then, by Theorem 1,  $H\mathcal{S}$  is the union of  $1 \leq \beta \leq \aleph_0$  clopen generalized Peano continua  $X_{i \in \beta}$  and these are non-degenerate since  $|X_i| = 1$  implies the unique  $\Lambda \in X_i$  is a proper attractor (as (2) fails,  $\Lambda \subsetneq M$ ), which is impossible in the non-wandering context (as minimal attractors are both stable and isolated, see (1) in Section 2.2). Let  $A_i$  be as in Theorem 1. Then,  $x \in A_i$  implies  $\emptyset \neq \omega(x) \in X_i \subset H\mathcal{S}$  and  $x \in \omega(x)$ , as  $\omega(x)$  is stable and the flow is non-wandering (Lemma 2.4). Therefore,  $X_i^* = A_i$  and  $X_i^*$  is as claimed.  $\square$

The following result shows that any cardinal limitation on the number of compact minimal sets implies either the minimality of the flow or the  $d_H$  denseness in  $\text{CMin}$  of the unstable compact minimal sets.

**Corollary 6.** *If the flow is non-wandering and  $|\text{CMin}| < \mathfrak{c}$ , then either*

- (1)  $H\mathcal{S} = \emptyset$  i.e.  $\text{cl}_H \mathcal{U} = \text{CMin}$ , or
- (2)  $M$  is compact and the flow is minimal.

*Actually, in case (1), the isolated (and thus Lyapunov unstable) compact minimal sets are  $d_H$  dense in  $\text{CMin}$ .*

*Proof.* Case (3) of Theorem 3 implies that  $|\text{CMin}| = \mathfrak{c}$ , thus  $|\text{CMin}| < \mathfrak{c}$ , implies that either (1) or (2) holds. The last sentence is an immediate consequence of Theorem 2 in [TE, p.248]:  $|\text{CMin}| < \mathfrak{c}$  implies  $\mathfrak{M}_{10} = \emptyset$ , thus  $\mathfrak{M}_{1-6}$ , the set of isolated compact minimals, is  $d_H$  dense in  $\text{CMin}$ .  $\square$

*Remark 11.* Note that, in general, despite the abundance of recurrent points, compact minimal sets may be extremely scarce in non-wandering flows (e.g. the only  $\Lambda \in \text{CMin}$  may be an equilibrium orbit). Corollary 6 shows that this phenomenon may only occur if isolated (unstable) compact minimal sets are  $d_H$  dense in  $\text{CMin}$ .

**Theorem 4.** (*Local behaviour*) *Let  $\Lambda$  be a compact minimal set of a  $C^0$  non-wandering flow on a generalized Peano continuum  $M$ . Then, either*

- (1)  $\Lambda \in \text{cl}_H \mathcal{U}$ , or
- (2)  $\Lambda = M$  i.e.  $M$  is compact and the flow is minimal, or
- (3) there are arbitrarily small compact, connected, invariant neighbourhoods  $U$  of  $\Lambda$  such that:
  - (a)  $U$  is the union of  $\mathfrak{c}$  hyper-stable compact minimal sets i.e.  $U = H\mathcal{S}(U)^*$ ;
  - (b)  $H\mathcal{S}(U)$  is a (non-degenerate) Peano continuum.

(see Fig. 1.2).

*Proof.* Theorem 4 is just Theorem 2 in the non-wandering setting: (1) coincides in both theorems. If the flow is non-wandering, then (2) of Theorem 2 can hold iff  $\Lambda = M$  since there are no proper attractors. This is (2) of Theorem 4. Finally, let  $U \in \mathcal{N}_\Lambda$  be as in (3) of Theorem 2. By (3.b) of Theorem 2,

$$x \in U \implies \omega(x) \in H\mathcal{S}(U)$$

As the flow is non-wandering, this implies  $x \in \omega(x) \subset U$  (Lemma 2.4). Therefore,  $U = H\mathcal{S}(U)^*$  is invariant and (3) holds.  $\square$

## 5. GLOBAL ABSENCE OF LYAPUNOV INSTABILITY

**5.1. Dichotomy.** It is well known that transitive dynamical behaviour precludes the existence of Lyapunov stable compact minimal sets  $\Lambda \subsetneq M$ . At the other extreme of the spectrum are flows without Lyapunov unstable compact minimals. *If the phase space  $M$  is compact*, this imposes extremely strong dynamical constraints on the flow, the following dichotomy holding:

**Theorem 5.** (*minimality or fragmentation into  $\mathfrak{c}$  stable minimals*) *A  $C^0$  flow  $\theta$  without Lyapunov unstable compact minimals on a Peano continuum  $M$  is non-wandering. Actually, every point is recurrent and the flow is either*

- (1) minimal, or
- (2) partitions  $M$  into  $\mathfrak{c}$  Lyapunov hyper-stable compact minimal sets, forming a non-degenerate Peano continuum (in the Hausdorff metric). Every nonvoid open set  $A \subset M$  intersects  $\mathfrak{c}$  minimal sets.

Thus, in a certain sense, Lyapunov unstable compact minimal sets are a vital ingredient of dynamical complexity and diversity of flows on compact phase spaces.

*Proof.* As  $\mathcal{U} = \emptyset$ ,  $\text{CMin} = H\mathcal{S}$ . Since  $M$  is compact, for each  $x \in M$ ,  $\alpha(x) \neq \emptyset$  is compact and thus contains a compact minimal set  $\Gamma$ . Necessarily,  $x \in \Gamma = \alpha(x)$ , otherwise  $\Gamma$  is unstable (Lemma 2.3). Thus, every  $x$  belongs to some  $\Gamma \in H\mathcal{S}$  and the flow is non-wandering, with all points recurrent. Since  $H\mathcal{S}^* = M$ , if the flow

is not minimal, then  $|H\mathcal{S}| > 1$ , and by Lemma 3.4 applied to  $U := M$ ,  $H\mathcal{S}$  is  $d_H$  compact and connected, hence by Theorem 3.3, a non-degenerate Peano continuum (thus  $|H\mathcal{S}| = \mathfrak{c}$ ). It remains to prove the last sentence in (2). Let  $x \in M$  and  $\varepsilon > 0$ . We show that  $B(x, \varepsilon)$  intersects  $\mathfrak{c}$  minimals:  $x$  belongs to some  $\Lambda \in H\mathcal{S}$ ; as  $H\mathcal{S}$  is a non-degenerate Peano continuum, there are  $\mathfrak{c}$  distinct minimals  $\Gamma_i \in H\mathcal{S}$  such that  $d_H(\Gamma_i, \Lambda) < \varepsilon$ , thus implying  $\Gamma_i \cap B(x, \varepsilon) \neq \emptyset$ .  $\square$

*Remark 12.* The last conclusion in (2) means that the “local density” of the hyper-stable compact minimal sets is actually  $\mathfrak{c}$  all over  $M$ .

*Remark 13.* The same conclusion holds if the flow has no (-)unstable compact minimal sets, as the time reversed flow  $\phi(t, x) = \theta(-t, x)$  contains no unstable compact minimal set and thus Theorem 5 is valid for  $\phi$ , hence also for  $\theta$ , as its conclusions are preserved under time-reversal.

*Remark 14.* This result, valid for arbitrary flows on compact (connected) manifolds, is, in general, false when  $M$  is noncompact (trivial counter-examples include the flow on  $\mathbb{R}^n$  generated by the vector field  $v(z) = -z$  and the parallel flows  $\partial/\partial x_i$ . If  $M$  is noncompact, the flow may contain no minimal sets, compact or not, see Inaba [IN], Beniere, Meigniez [BE]). Actually, compactness of  $M$  plays the key role in the above proof. If  $M$  is noncompact (i.e. a noncompact generalized Peano continuum, e.g. a noncompact manifold), then limit sets may be empty or noncompact and thus need not contain compact minimal sets. This actually implies that, in the noncompact setting, absence of Lyapunov unstable compact minimals has no analogue constraining effect on the dynamical diversity and complexity of the flow. In particular,  $H\mathcal{S}$  may be empty or discrete (i.e. every  $\Lambda \in H\mathcal{S}$  may be an attractor). Without entering into details, these flows may exhibit “quite freely” (on  $M$  or on invariant noncompact submanifolds), an abundance of dynamical phenomena e.g. non-minimal ergodic behaviour, absence of minimal sets (compact and noncompact) etc.

**5.2. Fragmentation into  $\mathfrak{c}$  hyper-stable minimal submanifolds.** In virtue of Theorem 5, a non-minimal  $C^0$  flow on a (connected) closed manifold  $M$ , displaying no unstable minimal sets, partitions  $M$  into  $\mathfrak{c}$  hyper-stable minimal sets  $\{\Lambda_i \in \mathbb{R}\}$ . If all these  $\Lambda_i$  are submanifolds (necessarily closed and connected, of possibly non-fixed codimension  $\geq 1$ ), then given the nature of the examples that usually come to one’s mind, it is tempting to ask if  $[\text{CMin}, d_H] = [\{\Lambda_i \in \mathbb{R}\}, d_H]$  is itself a manifold (compact, connected, possibly with boundary). For simplicity reasons, we will assume that the flows has all orbits periodic and Lyapunov stable, hence  $[\text{CMin}, d_H] = [\text{Per}, d_H] = H\mathcal{S}$ . In this particular case, the answer is positive in dimension 2 and 3 (Davermann [D2, D4], Davermann, Walsh [D3]).<sup>9</sup> In dimension 2 this is actually straightforward, using Gutierrez Smoothing Theorem

<sup>9</sup>Observe that the partitions (decompositions) of  $M$  into closed submanifolds we are considering are upper semicontinuous (usc) in the standard sense [B3, D1], as required in [D2, D3, D4]. This follows immediately from Lemma 1. They are in fact *continuous* in the standard sense [B3]:  $d(\Lambda_n, \Lambda_0) \rightarrow 0$  implies  $\Lambda_n \xrightarrow{d_H} \Lambda_0$  (Lemmas 1 and 6).

[GU] and Poincaré Index Theorem: only the torus and the Klein bottle carry flows without equilibria. For flows with all orbits periodic on  $\mathbb{T}^2$ ,  $[\text{Per}, d_H] \simeq \mathbb{S}^1$  and on  $\mathbb{K}^2$ ,  $[\text{Per}, d_H] \simeq \mathbb{D}^1 = [-1, 1]$  (two  $\mathbb{S}^1$ -foliated Möbius bands glued along their boundaries  $\implies$  exactly two 1-sided orbits). The 3-dimensional case was established earlier by Epstein [E1], assuming that the flows with all orbits periodic is  $C^1$  and  $M$  orientable, with no a priori restrictions on the Lyapunov's nature of the orbits (see Section 2.5). However, in the higher dimensions, the landscape changes radically: there are  $C^\infty$  periodic flows on closed  $n$ -manifolds (for every  $n \geq 4$ ), for which  $[\text{CMin}, d_H] = [\text{Per}, d_H] = H\mathcal{S}$  is a *non-manifold* (see Example 4 below).

Cannon and Daverman [CA] constructed remarkable examples of periodic  $C^0$  flows on  $M = N \times \mathbb{S}^1$ ,  $N$  any  $C^\infty$  boundaryless ( $n \geq 3$ )-manifold, on which every orbit is a wildly embedded  $\mathbb{S}^1$ ! By construction, these periodic flows induce trivial circle bundles. As the fibres are wild in  $M$ , no point of the bundle's base space  $\Theta$  has a neighbourhood homeomorphic to  $\mathbb{B}^n$ , hence  $H\mathcal{S} \simeq \Theta$  is nowhere a manifold. These flows have nowhere an  $n$ -cell cross section, and thus are nowhere topologically equivalent to  $C^1$  flows, all this showing that  $C^0$  dynamics harbours topological phenomena unparalleled in the differentiable setting (even locally).

**Example 4.** The following construction provides examples of  $C^\infty$  periodic flows with all orbits Lyapunov stable, on closed manifolds in all dimensions  $n \geq 4$ , for which the space of orbits  $\text{Per} \simeq \Theta$  is a *non-manifold*. The construction of the underlying tangentially orientable foliations, which could hardly be simpler, was, essentially, kindly communicated to us by Professor Robert Daverman [D5].

For  $n \geq 4$ , let  $f : \mathbb{S}^{n-1} \circlearrowleft$  act as the orthogonal reflection on the north-south axis  $[-p, p]$ ,  $p = (0, 0, \dots, 0, 1)$  (this is the compactification of  $\mathbb{R}^{n-1} \circlearrowleft : x \mapsto -x$ ). The (semifree)  $\mathbb{Z}/2\mathbb{Z}$  action determined by  $f$  fixes  $\pm p$  and the orbit space  $\Theta := \mathbb{S}^{n-1}/f$  is homeomorphic to the topological suspension of  $\mathbb{R}P^{n-2}$ . As  $n \geq 4$ ,  $\mathbb{R}P^{n-2} \not\hookrightarrow \mathbb{R}^{n-1}$  [MA], hence  $\Theta$  is a non-manifold (with singular points  $\pm p$ ).

Let  $F$  be the free  $\mathbb{Z}/2\mathbb{Z}$  action on  $\mathbb{S}^1 \times \mathbb{S}^{n-1}$  which acts as the antipodal map on the 1st factor and as  $f$  on the 2nd. Since the action is  $C^\infty$ , finite and free, the corresponding orbit space  $M = (\mathbb{S}^1 \times \mathbb{S}^{n-1})/F$  is a connected,  $C^\infty$  closed  $n$ -manifold. The image of the circles  $\mathbb{S}^1 \times \{y\}$ , under the quotient map  $h : \mathbb{S}^1 \times \mathbb{S}^{n-1} \rightarrow M$ , are circles defining a tangentially orientable  $C^\infty$  1-foliation of  $M$ , with all leaves Lyapunov stable. Now, starting with the periodic vector field  $(z_1, z_2) \mapsto (iz_1, 0)$  on  $\mathbb{S}^1 \times \mathbb{S}^{n-1}$ , we get, via the quotient map, a  $C^\infty$  vector field on  $M$ , tangent to the resulting foliation. Thus  $H\mathcal{S} = \text{Per}$  is the space of leaves, which, by construction, is homeomorphic to  $\Theta$ , a non-manifold (see above). Also, trivially, the flow is periodic with period  $2\pi$  (identifying  $\mathbb{S}^1$  with  $\mathbb{R}/2\pi\mathbb{Z}$ ), the two orbits corresponding to the image (under the quotient) of each circle  $\mathbb{S}^1 \times \{\pm p\}$  have minimal period  $\pi$ . All other orbits have minimal period  $2\pi$ .

## 6. FINAL REMARKS. OPEN QUESTIONS

Assuming the phase space  $M$  of the flow to be a (generalized) Peano continuum, the topological characterization of  $H\mathcal{S}$  given by Theorem 1 is optimal: it is easily



seen that if a metric space  $\mathfrak{M}$  is the union of countably many disjoint, clopen, generalized Peano continua, then there is a  $C^0$  flow on a Peano continuum for which  $H\mathcal{S} \simeq \mathfrak{M}$ . We sketch the proof in the case  $\mathfrak{M}$  is noncompact and has denumerably many components (the other cases are easier).

Let  $\mathfrak{M} = \sqcup_{i \in \mathbb{N}} X_i$ , where each  $X_i$  is a nonvoid, clopen, generalized Peano continuum. For each  $i \in \mathbb{N}$ , take a  $C^0$  flow  $\theta_i$  on  $\mathbb{D}_i^1 = [-1_i, 1_i] \simeq \mathbb{D}^1$ , with (exactly) three equilibria  $-1_i, 0_i, 1_i$ ,  $\{0_i\}$  a repeller. From each  $X_i$  select a point  $z_i$ . Connect  $z_i$  to  $z_{i+1}$  pasting  $-1_i$  to  $z_i$  and  $1_i$  to  $z_{i+1}$  (the  $\mathbb{D}_i^1$ 's are disjoint, except that the pasting induces the identification  $1_i \equiv -1_{i+1}$ ). Define the  $C^0$  flow  $\theta$  on  $\mathfrak{N} = \mathfrak{M} \cup \cup_{i \in \mathbb{N}} \mathbb{D}_i^1$ , which coincides with  $\theta_i$  on  $\mathbb{D}_i^1$  and has each  $x \in \mathfrak{M}$  has an equilibrium.  $\mathfrak{N}$  is a noncompact generalized Peano continuum and thus has an 1-point compactification  $\mathfrak{N}^\infty = \mathfrak{N} \sqcup \{0_\infty\}$ , which is a Peano continuum (see (2) in the proof of Lemma 5). The flow  $\theta$  automatically extends to a  $C^0$  flow on  $\mathfrak{N}^\infty$ , with  $0_\infty$  becoming an equilibrium. Now, let  $\phi$  be a  $C^0$  flow on  $\mathbb{D}^1$  with (exactly) two equilibria,  $-1$  and  $1$ ,  $\{-1\}$  an attractor. Paste  $-1$  to  $z_1$  and  $1$  to  $0_\infty$ . This defines a  $C^0$  flow on the Peano continuum

$$M := \mathfrak{N}^\infty \cup \mathbb{D}^1$$

with  $\mathcal{S} = H\mathcal{S} = \{\{x\} : x \in \mathfrak{M}\} \simeq \mathfrak{M}$  and  $\mathcal{U} = \{\{0_i\} : i \in \mathbb{N} \sqcup \{\infty\}\}$ .

A more difficult question is the following:

**Problem 1.** Assuming that  $\mathfrak{M}$  (see above) is finite dimensional,<sup>10</sup> when is  $\mathfrak{M}$  homeomorphic to the  $H\mathcal{S}$  set of some flow on a manifold?

We restrict our attention to the simpler problem:

**Problem 2.** If  $K \subset \mathbb{S}^n$  is a Peano continuum, under which conditions is there a flow on  $\mathbb{S}^n$  such that:

- (a) each point  $x \in K$  is an equilibrium and
- (b)  $H\mathcal{S} = \{\{x\} : x \in K\} \simeq K$ ?

For  $n = 2$ , such a flow exists iff  $K^c$  has finitely many components, and it can be made of class  $C^\infty$  (if  $\mathbb{S}^2$  is replaced by any compact manifold, it is easily seen that this condition remains necessary for the existence of such a flow, even of class  $C^0$ , see (B) below). Hence the answer is positive, for example, if  $K$  is homeomorphic to Wazewski's universal dendrite ([NA, p.181],[CH, p.12]), but negative if it is homeomorphic to Sierpinski's universal plane curve ("Sierpinski's carpet", [NA, p.9],[CH, p.31],[SA, p.160]). Our existence proof relies heavily on Riemann Mapping Theorem.

**Synopsis.** (*Existence*) excluding trivialities, suppose  $K \subsetneq \mathbb{S}^2$  is a non-degenerate Peano continuum. Through topology, each component  $A_i$  of  $K^c$  is simply connected, hence there is a biholomorphism  $\zeta_i : \mathbb{B}^2 \rightarrow A_i$  (Riemann Mapping Theorem). We use this to put a  $C^\infty$  vector field  $v_i$  on each  $A_i$ , with a repelling equilibrium  $O_i$ , such that  $A_i$  is its repulsion basin and  $v_i$  extends to the whole  $\mathbb{S}^2$ , letting  $v_i = 0$  on  $A_i^c$ . Define

<sup>10</sup>Every  $n$ -dimensional, separable metric space embeds in  $\mathbb{R}^{2n+1}$ , hence in any  $(2n+1)$ -manifold (Menger-Nöbeling-Hurewicz Theorem, see e.g. [HU, p.60]).

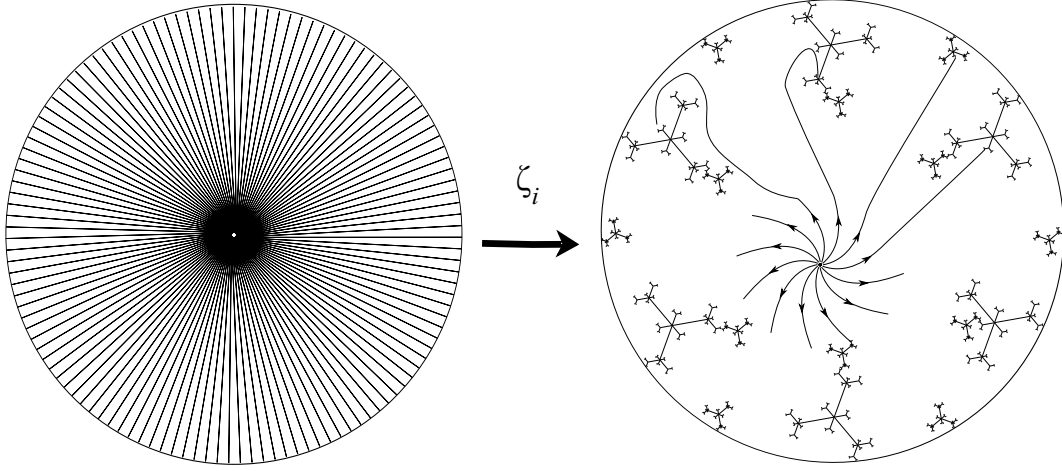

FIGURE 6.1. Riemann Mapping Theorem operating the miracle.

$v = \sum v_i$  on  $\mathbb{S}^2$ . Clearly  $v|_{A_i} = v_i$  and  $\text{CMin} = \{\{x\} : x \in K\} \sqcup \{\{O_i\}\}_i$ . By topology again,  $\text{bd}A_i$  is locally connected, hence  $\zeta_i$  extends continuously to  $\zeta_i : \mathbb{D}^2 \rightarrow \overline{A_i}$ . This ensures that, for each  $p \in \text{bd}A_i \subset K$ ,  $\{p\}$  is a stable equilibrium orbit, actually hyper-stable, since the unstable minimals are the finitely many repellers  $\{O_i\}$ .

*Proof. (A) Existence.* The cases  $K = \emptyset$ ,  $|K| = 1$  and  $K = \mathbb{S}^2$  are trivial. Assume that  $K \subsetneq \mathbb{S}^2$  is non-degenerate Peano continuum such that  $K^c$  has finitely many components  $\{A_i\}$ . Identify  $\mathbb{R}^2$  with  $\mathbb{C}$  and  $\mathbb{S}^2$  with the Riemann sphere  $\mathbb{C} \cup \{\infty\}$ .

(1) *Claim. Each  $A_i$  is biholomorphic to  $\mathbb{B}^2 = \text{int } \mathbb{D}^2$ :* let  $\gamma$  be an  $\mathbb{S}^1$  embedded in  $A_i$ . By Schoenflies Theorem, we may reason as if  $\gamma$  is the standard equator  $\mathbb{S}^1 \times \{0\}$ . Being connected and disjoint from  $\gamma$ ,  $K$  is contained in one open hemisphere, say the north one. Then, the closed south hemisphere is contained in  $A_i$  (being a connected subset of  $K^c$  containing  $\gamma \subset A_i$ ), hence  $\gamma$  is contractible to a point inside  $A_i$ . Therefore, as  $A_i \neq \emptyset$  is open, simply connected and  $|A_i^c| > 1$ , there is a biholomorphic map  $\zeta_i : \mathbb{B}^2 \rightarrow A_i \subset \mathbb{S}^2$  (Riemann Mapping Theorem).

(2) as  $K$  is Peano continuum, so is  $\text{bd}A_i \subset K$  ([KU]). This implies ([PO, p.18]) that  $\zeta_i$  (uniquely) extends to a  $C^0$  map  $\zeta_i : \mathbb{D}^2 \rightarrow \overline{A_i}$ . It is easily seen that  $\zeta_i$  maps  $\mathbb{S}^1 = \text{bd } \mathbb{D}^2$  onto  $\text{bd}A_i = \overline{A_i} \setminus A_i$  (in general not injectively).

(3) Take  $\lambda \in C^\infty(\mathbb{R}^2, [0, 1])$  such that  $\lambda^{-1}(0) = (\mathbb{B}^2)^c$ . Let  $v$  be the vector field  $\mathbb{R}^2 \ni z \mapsto \lambda(z)z$ . Transfer  $v|_{\mathbb{B}^2}$  to  $A_i$  via  $\zeta_i$ , getting  $v_i = \zeta_{i*} v|_{\mathbb{B}^2} \in \mathfrak{X}^\infty(A_i)$ . By Kaplan Smoothing Theorem [KA, p.157], there is  $\mu_i \in C^\infty(\mathbb{S}^2, [0, 1])$  such that  $\mu_i^{-1}(0) = A_i^c$  and

$$\begin{aligned}
 v_i : \mathbb{S}^2 &\longrightarrow \mathbb{R}^3 \\
 z &\longmapsto \mu_i v_i(z) && \text{on } A_i \\
 z &\longmapsto 0 && \text{on } A_i^c
 \end{aligned}$$

defines a  $C^\infty$  vector field on  $\mathbb{S}^2$ , whose restriction to  $A_i$  is topologically equivalent to  $v|_{\mathbb{B}^2}$  via  $\zeta_i$ . Let  $v = \sum v_i \in \mathfrak{X}^\infty(\mathbb{S}^2)$ . Note that  $v|_{A_i} = v_i$ . Its set of equilibria is  $K \sqcup \{O_i\}_i$ , where  $O_i = \zeta_i(0)$ . The corresponding equilibrium orbits are the only

minimal sets of the flow  $v^t$ . Each  $\{O_i\}$  is a repeller and  $A_i$  its repulsion basin. For each  $O_i \neq z \in A_i$ ,  $\alpha(z) = \{O_i\}$  and  $\omega(z) = \{p\}$ , for some  $p \in \text{bd}A_i$ . Since  $\zeta_i : \mathbb{S}^1 \rightarrow \text{bd}A_i$  is onto, every equilibrium  $p \in \text{bd}A_i$  is the  $\omega$ -limit of at least one  $z \in A_i$  (Fig. 6.1).

(4) *Claim.*  $H\mathcal{S} = \{\{x\} : x \in K\}$ .

We show that each  $y \in K$  has arbitrarily small (+)invariant neighbourhoods. If  $y \in \text{int}K$ , this is obvious since  $y$  has a neighbourhood consisting of equilibria (see 3). Otherwise, given  $\varepsilon > 0$ , we get a (+)invariant neighbourhood  $D_i \subset B(y, \varepsilon)$  of  $y$  in  $\overline{A_i}$ , for each component  $A_i$  of  $K^c$  such that  $y \in \text{bd}A_i$ . Then, as the number of components is finite,  $(B(y, \varepsilon) \cap K) \cup (\cup D_i) \subset B(y, \varepsilon)$  is a (+)invariant neighbourhood of  $y$  in  $\mathbb{S}^2$ .

Suppose  $y \in \text{bd}A_i$ . As  $\zeta_i : \mathbb{D}^2 \rightarrow \overline{A_i}$  is  $C^0$ ,  $\beta_i = \zeta_i^{-1}(y) \subset \mathbb{S}^1$  is compact and  $B_i = \zeta_i^{-1}(B(y, \varepsilon) \cap \overline{A_i})$  is an open neighbourhood of  $\beta_i$  in  $\mathbb{D}^2$ . For each  $x \in \beta_i$ , take a ‘‘conic’’ open, (+)invariant neighbourhood  $C_x$  of  $x$  in  $\mathbb{D}^2$ , contained in  $B_i$  ( $\mathbb{D}^2$  is invariant under the flow  $v^t$ ). Let  $C_i$  be a finite union of  $C_x$ ’s covering  $\beta_i$ . Then,  $(B(y, \varepsilon) \cap K) \cup (\cup_{y \in \text{bd}A_i} \zeta_i(C_i))$  is a (+)invariant neighbourhood of  $y$  in  $\mathbb{S}^2$ , contained in  $B(y, \varepsilon)$ . Therefore  $\{y\} \in \mathcal{S}$ . The only other minimals are the finitely many repellers  $\{O_i\}$ , which are necessarily away from  $\mathcal{S}$ , hence  $H\mathcal{S} = \mathcal{S} = \{\{x\} : x \in K\}$ .

(B) Finally, we prove that if  $K^c$  has infinitely many components, then there is no such flow (even of class  $C^0$ ). Reasoning by contradiction, suppose there is such a flow. Let  $\{A_n\}_{n \in \mathbb{N}}$  be the distinct components of  $K^c$ .

*Claim.* Each open invariant set  $A_n$  contains an unstable minimal set: let  $z \in A_n$ . As  $\mathbb{S}^2$  is compact,  $\alpha(z) \neq \emptyset$  is compact and thus contains a minimal set  $\Lambda_n$ . Clearly,  $\Lambda_n \subset A_n$ , otherwise  $\Lambda_n \subset \text{bd}A_n \subset K$  which implies  $\Lambda_n = \{x\}$ , for some  $x \in K$  (by hypothesis (a), each  $x \in K$  is an equilibrium) and  $\{x\}$  is unstable (Lemma 2.3), contradicting hypothesis (b). By hypothesis (b),  $\Lambda_n \notin H\mathcal{S}$  i.e.  $\Lambda_n \in \text{cl}_H \mathcal{U}$ . Take  $\Gamma_n \in \mathcal{U}$  sufficiently  $d_H$  near  $\Lambda_n$  so that it is contained in  $A_n$ .

Now, by Blaschke Principle ([TE, p.223]),  $\Gamma_n$  has a subsequence  $\Gamma_{n'}$   $d_H$  converging to some nonvoid, compact invariant set  $\Gamma \subset \mathbb{S}^2$ . As the  $A_n$ ’s are disjoint, open and invariant,  $\Gamma \subset K$ . But then, for each  $x \in \Gamma \subset K$ ,  $\{x\} \in \text{cl}_H \mathcal{U} = H\mathcal{S}^c$ , contradicting  $\{x\} \in H\mathcal{S}$  (hypothesis (b)): this is obvious if  $\Gamma = \{x\}$ , as  $\mathcal{U} \ni \Gamma_{n'} \xrightarrow{d_H} \Gamma$ . Otherwise  $\{x\} \subsetneq \Gamma$ , thus  $\{x\} \in \mathcal{U}$  (Lemma 2.1).  $\square$

## REFERENCES

- [AB] R. Abraham, J. Marsden, *Foundations of Mechanics*, Addison-Wesley, 2nd edition, 1987.
- [AT] K. Athanassopoulos, P. Strantzalos, *On minimal sets in 2-manifolds*, J. Reine Angew. Math. 388 (1988), 206-211.
- [BE] J.-C. Beniere, G. Meigniez, *Flows without minimal set*, Ergodic Th. & Dynam. Sys. 19 (1999), 21-30.
- [BR] V. Berestovskii, D. Halverson, D. Repovs, *Locally G-homogeneous Busemann G-spaces*, Diff. Geom. Appl. 29 (2011), 299-318.
- [BH] N. Bhatia, G. Szegö, *Stability theory of dynamical systems*, Springer-Verlag, Berlin, 1970.

- [B1] R. H. Bing, *A convex metric for a locally connected continuum*, Bull. Amer. Math. Soc. 55 (1949), 812-819.
- [B2] R. H. Bing, *Partitioning a set*, Bull. Amer. Math. Soc. 55 (1949), 1101-1110.
- [B3] R. H. Bing, *Partially continuous decompositions*, Proc. Amer. Math. Soc. 6 (1955), 124-133.
- [BI] G. Birkhoff, *Dynamical systems*, American Mathematical Society Colloquium Pub. vol.IX, 1927.
- [BU] D. Burago, Y. Burago, S. Ivanov, *A course in metric geometry*, Graduate studies in mathematics vol. 33, AMS, Providence, Rhode Island, 2001.
- [BN] H. Busemann, *The Geometry of geodesics*, Academic Press, 1955.
- [CA] J. Cannon, R. Daverman, *A totally wild flow*, Indiana J. of Math. 20(3) (1981), 371-387.
- [CH] J. Charatonik, P. Krupski, P. Pyrih, *Examples in Continuum Theory*, May 2003 (unfinished electronic version available online).
- [D1] R. Daverman, *Decompositions of manifolds*, Academic Press, 1986.
- [D2] R. Daverman, *Decompositions into codimension one submanifolds*, Comp. Math. 55(2) (1985), 185-207.
- [D3] R. Daverman, J. Walsh, *Decompositions into codimension-two submanifolds*, Trans. Amer. Math. Soc. 288(1) (1985), 273-291.
- [D4] R. Daverman, *Decompositions into codimension two submanifolds: the nonorientable case*, Topol. and its Appl. 24 (1986), 71-81.
- [D5] R. Daverman, private communication, 24-01-2014.
- [DU] B. Dubrovin, A. Fomenko, S. Novikov, *Modern geometry - methods and applications, Part II. The geometry and topology of manifolds*, Springer Verlag, 1985.
- [E1] D. Epstein, *Periodic flows on three-manifolds*, Annals of Math. 95 (1972), 68-82.
- [E2] D. Epstein, *Foliations with all leaves compact*, Ann. Inst. Fourier, Grenoble 26(1) (1976), 265-282.
- [GU] C. Gutierrez, *Smoothing continuous flows on two-manifolds and recurrences*, Ergod. Th. & Dynam. Sys. 6(1) (1986), 17-44.
- [HA] M. Handel, *A pathological area preserving  $C^\infty$  diffeomorphism of the plane*, Proc. Amer. Math. Soc. 86(1) (1982), 163-168.
- [HR] D. Halverson, D. Repovs, *The Bing-Borsuk and the Busemann conjectures*, Math. Commun. 13 (2008), no.2, 163-184.
- [HU] W. Hurewicz, H. Wallman, *Dimension Theory*, Princeton Univ. Press, 1948.
- [IN] T. Inaba, *An example of a flow on a non-compact surface without minimal set*, Ergod. Th. & Dynam. Sys. 19 (1999), 31-33.
- [KA] W. Kaplan, *The singularities of continuous functions and vector fields*, Michigan Math. J. 9(2) (1962), 151-159.
- [KO] S. Kobayashi and K. Nomizu, *Foundations of differential geometry vol. I*, Interscience Publishers, 1963.
- [KU] K. Kuratowski, *Sur une propriété des continues Péaniens*, Fund. Math. 15 (1930), 180-184.
- [LY] A. Lyapunov, *Problème générale de la stabilité du mouvement*, Ann. Fac. Sci. Toulouse 9 (1907), 203-474; (reprinted) Ann. Math. Studies 17, Princeton Univ. Press, 1947.
- [MA] W. Massey, *On the imbeddability of the real projective spaces in euclidean space*, Pacific J. of Math. 9 (1959), 783-785.
- [M1] J. Moser, *Stable and random motions in dynamical systems*, Annals Math. Studies 77, Princeton Univ. Press, 1973.
- [M2] J. Moser, C. Siegel, *Lectures on Celestial Mechanics*, Springer, Grundlehren Bd. 187, 1971.

- [NA] S. Nadler, *Continuum Theory*, Marcel Decker, 1992.
- [NE] S. Newhouse, *Quasi-elliptic periodic points in conservative dynamical systems*, Amer. J. Math. 99(5) (1977), 1061–1087.
- [PO] Ch. Pommerenke, *Boundary Behaviour of Conformal Maps*, Springer-Verlag, 1992.
- [SA] H. Sagan, *Space-filling curves*, Springer-Verlag, 1994.
- [SU] D. Sullivan, *A counterexample to the periodic orbit conjecture*, Publications I.H.E.S. 46(1) (1976), 5-14.
- [TE] P. Teixeira, *Flows near compact invariant sets. Part I*, Fundamenta Mathematicae 223(3) (2013), 225-272.
- [TO] A. Tominaga, T. Tanaka, *Convexification of locally connected generalized continua*, J. Sei. Hiroshima Univ. Ser A 19 (1955), 301-306.
- [Z1] E. Zehnder, *Homoclinic points near elliptic fixed points*, Comm. Pure Appl. Math. 26 (1973), 131-182.
- [Z2] E. Zehnder, *Hommage à Jürgen Moser*, Gaz. Math. No. 59 (1994), 57-66.

Centro de Matemática da Universidade do Porto  
Rua do Campo Alegre, 687, 4169-007 Porto, Portugal  
E-mail: [pedro.teixeira@fc.up.pt](mailto:pedro.teixeira@fc.up.pt)