

TORIC GEOMETRY OF $SL_2(\mathbb{C})$ FREE GROUP CHARACTER VARIETIES FROM OUTER SPACE

CHRISTOPHER MANON

ABSTRACT. Culler and Vogtmann introduced a simplicial space $O(g)$ called outer space in order to study the outer automorphism group of the free group F_g . Using representation theoretic methods, we give an embedding of $O(g)$ into the analytification of $\mathcal{X}(F_g, SL_2(\mathbb{C}))$, the $SL_2(\mathbb{C})$ character variety of F_g , reproving a result of Morgan and Shalen. Then we show that every point v contained in a maximal cell of $O(g)$ defines a flat degeneration of $\mathcal{X}(F_g, SL_2(\mathbb{C}))$ to a toric variety $X(v)$. We relate $\mathcal{X}(F_g, SL_2(\mathbb{C}))$ and $X(v)$ topologically by showing that there is a surjective, continuous, proper map $\Xi_v : \mathcal{X}(F_g, SL_2(\mathbb{C})) \rightarrow X(v)$, which is a symplectomorphism on a dense, open subset of $\mathcal{X}(F_g, SL_2(\mathbb{C}))$ with respect to natural symplectic structures on $\mathcal{X}(F_g, SL_2(\mathbb{C}))$ and $X(v)$. In this way, we construct an integrable Hamiltonian system in $\mathcal{X}(F_g, SL_2(\mathbb{C}))$ for each point in a maximal cell of $O(g)$, and we show that each v defines a combinatorial topological decomposition of $\mathcal{X}(F_g, SL_2(\mathbb{C}))$ reminiscent of the decomposition of a toric manifold by its torus orbits. Finally, we show that the valuations coming from the closure of a maximal cell in $O(g)$ all arise from divisorial valuations built from an associated projective compactification of $\mathcal{X}(F_g, SL_2(\mathbb{C}))$.

1. INTRODUCTION

In their seminal paper [MS], Morgan and Shalen introduce a topological compactification construction for any complex affine variety V where a piecewise linear complex is added at infinity, the points of which correspond to valuations v on the coordinate ring of V . By applying these techniques to the $SL_2(\mathbb{C})$ character varieties of surface fundamental groups, Morgan and Shalen are able to recreate Thurston's piecewise linear compactification of Teichmüller space [T]. As part of their program, they show that isometric actions of the free group F_g on metric trees are limit points of the character variety $\mathcal{X}(F_g, SL_2(\mathbb{C}))$, and consequently can be understood as equivalence classes of valuations on the coordinate ring $\mathbb{C}[\mathcal{X}(F_g, SL_2(\mathbb{C}))]$ (Allesandrini [A] also has an account of this construction). In this paper we relate these valuations to other combinatorial structures from the theory of character varieties, compute their associated graded rings, and use the associated graded schemes to study topological decompositions and integrable systems in $\mathcal{X}(F_g, SL_2(\mathbb{C}))$.

Our first main result is a reformulation of Morgan and Shalen's construction of a valuation on $\mathbb{C}[\mathcal{X}(F_g, SL_2(\mathbb{C}))]$ from an isometric F_g action on a metric tree, in order to state it we recall spaces from geometric group theory and the theory of Berkovich analytification. In [CV], Culler and Vogtmann introduce a space $\tilde{O}(g)$ with an action of the outer automorphism group $Out(F_g)$ called outer space. Points of $O(g)$ are graphs Γ with no leaves and first Betti number equal to g , along with choice of metric ℓ and an isomorphism $\phi : \pi_1(\Gamma) \cong F_g$ (see [CV], [V], Section 2). The metric is subject to a normalization condition, stipulating that the sum of the lengths of the edges of Γ must be 1. Culler and Vogtmann show that $\tilde{O}(g)$ has a simplicial structure, with a simplicial action by $Out(F_g)$ and use this to prove that $Out(F_g)$ has a number of group theoretic properties, see [V] for a survey of these results. Points in $O(g)$ can be viewed as isometric actions of F_g on trees by replacing (Γ, ℓ) with its universal cover, a metric tree with an isometric action of F_g defined by the isomorphism ϕ . We drop the normalization condition on the metric and consider the resulting complex of simplicial cones, $O(g)$, which by an abuse of terminology we also call outer space.

Each reduced word $\omega \in F_g$ defines a continuous function $d_\omega : O(g) \rightarrow \mathbb{R}$, where $d_\omega(\Gamma, \ell, \phi)$ is the length of the minimal length path in (Γ, ℓ) which represents ω in $\pi_1(\Gamma)$. Reduced words $\omega \in F_g$ also define regular functions $tr_\omega \in \mathbb{C}[\mathcal{X}(F_g, SL_2(\mathbb{C}))]$ called traceword functions. A point in $\mathcal{X}(F_g, SL_2(\mathbb{C}))$ is an $SL_2(\mathbb{C})$ representation of F_g , this is a choice of g matrices $A_1, \dots, A_g \in SL_2(\mathbb{C})$. Two choices of matrices define the same representation if and only if they are related by simultaneous conjugation by

an element of $SL_2(\mathbb{C})$. Putting this all together, $\mathcal{X}(F_g, SL_2(\mathbb{C}))$ is defined as a Geometric Invariant Theory (GIT) quotient.

$$(1) \quad \mathcal{X}(F_g, SL_2(\mathbb{C})) = [SL_2(\mathbb{C}) \times \dots \times SL_2(\mathbb{C})]/SL_2(\mathbb{C})$$

The function tr_ω is computed on $[A_1, \dots, A_g] \in \mathcal{X}(F_g, SL_2(\mathbb{C}))$ by evaluating $\omega(A_1, \dots, A_g)$ and taking the trace of the resulting matrix.

The Berkovich analytification V^{an} of an affine variety V (see [Ber], [P], Section 3) is a Hausdorff topological space composed of all the rank 1 valuations on the coordinate ring of V . The topology on V^{an} is the weakest one which makes the evaluation functions $f \in \mathbb{C}[V]$, $[f] : V^{an} \rightarrow \mathbb{R} \cup \{-\infty\}$, $[f](v) = v(f)$ continuous.

Theorem 1.1. [Morgan, Shalen, 1984] *There is an embedding $\Sigma : O(g) \rightarrow \mathcal{X}(F_g, SL_2(\mathbb{C}))^{an}$, furthermore, for any reduced word $\omega \in F_g$, $[tr_\omega] \circ \Sigma = d_\omega$.*

For a point $(\Gamma, \ell, \phi) \in O(g)$, let $v_{\Gamma, \ell, \phi} = \Sigma(\Gamma, \ell, \phi)$. We construct the embedding Σ using different methods from those used in [MS]. Theorem 1.1 is analogous to Speyer and Sturmfels's Theorem 3.4 in [SpSt], which identifies the tropical variety of the Grassmannian variety $Gr_2(\mathbb{C}^n)$ with the space of metric trees with n ordered leaves. In [M4], the author uses combinatorial and representation theoretic methods to construct an embedding of the space of metric trees into the analytification $Gr_2(\mathbb{C}^n)^{an}$ (Proposition 3.1). We use similar methods to give a new proof of Theorem 1.1, employing the spin diagram basis of the coordinate ring $\mathbb{C}[\mathcal{X}(F_g, SL_2(\mathbb{C}))]$, and a noncommutative quiver variety construction.

In [FL] Florentino and Lawton study varieties $M_\Gamma(G)$ for G a reductive group, built as noncommutative analogues of quiver varieties. They show that each $M_\Gamma(G)$ for Γ a directed graph with first Betti number equal to g is isomorphic to $\mathcal{X}(F_g, G)$ (see also [M1]). We extend this construction to a functor $M_-(SL_2(\mathbb{C}))$ from the category of graphs with cellular topological maps to the category of complex schemes. We show that each $\phi : \pi_1(\Gamma) \rightarrow F_g$ defines a distinguished isomorphism $M_\Gamma(SL_2(\mathbb{C})) \cong \mathcal{X}(F_g, SL_2(\mathbb{C}))$, and that the variety $M_\Gamma(SL_2(\mathbb{C}))$ comes with a naturally defined simplicial cone C_Γ of valuations on its coordinate ring. The pullbacks $C_{\Gamma, \phi}$ of these cones in $\mathcal{X}(F_g, SL_2(\mathbb{C}))^{an}$ paste together to give the embedding Σ .

The graph Γ also plays a fundamental role in our analysis of the coordinate ring of $\mathcal{X}(F_g, SL_2(\mathbb{C}))$. For a trivalent graph Γ , a spin diagram of topology Γ is an assignment of non-negative integers $a : E(\Gamma) \rightarrow \mathbb{Z}_{\geq 0}$ to the edges of Γ which satisfy the inequalities of a polytope \mathcal{P}_Γ and belong to a certain lattice $L_\Gamma \subset \mathbb{R}^{E(\Gamma)}$, see Section 6.

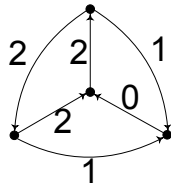

FIGURE 1. A spin diagram.

We show how to construct a basis of regular functions Φ_a , $a \in P_\Gamma = \mathcal{P}_\Gamma \cap L_\Gamma$ in $\mathbb{C}[\mathcal{X}(F_g, SL_2(\mathbb{C}))]$ for each Γ with a choice of $\phi : \pi_1(\Gamma) \cong F_g$. These spin diagram functions have a rich combinatorial theory, and have been studied before by Lawton and Peterson, [LP]. In particular, these authors give a set of rules for computing a product of spin diagram functions. Spin diagrams also play key combinatorial roles in topological field theory and knot theory, see [Baez] for a survey of some of these topics.

The set P_Γ is an affine semigroup, with associated affine semigroup algebra $\mathbb{C}[P_\Gamma]$. Multiplication in this algebra is defined naively, $[a][b] = [a + b]$. We define $X(v_{\Gamma, \ell, \phi})$ to be the affine toric variety $Spec(\mathbb{C}[P_\Gamma])$. Our second main theorem says that the associated graded multiplication operation in $\mathbb{C}[\mathcal{X}(F_g, SL_2(\mathbb{C}))]$ with respect to the filtration defined by $v_{\Gamma, \ell, \phi}$ is this naive multiplication operation.

Theorem 1.2. *The associated graded algebra $gr_{v_{\Gamma, \ell, \phi}}(\mathbb{C}[\mathcal{X}(F_g, SL_2(\mathbb{C}))])$ is isomorphic to $\mathbb{C}[P_\Gamma]$.*

A degeneration $\mathbb{C}[\mathcal{X}(F_g, SL_2(\mathbb{C}))] \Rightarrow \mathbb{C}[P_\Gamma]$ was studied by the author in [M2] in the context of the theory of Newton-Okounkov bodies (see [KK]). In particular $\mathbb{C}[P_\Gamma]$ was realized as the associated graded algebra of $\mathbb{C}[\mathcal{X}(F_g, SL_2(\mathbb{C}))]$ with respect to a full rank (= dimension of $\mathcal{X}(F_g, SL_2(\mathbb{C}))$) valuation.

Next we relate $\mathcal{X}(F_g, SL_2(\mathbb{C}))$ to $X(v_{\Gamma, \ell, \phi})$ topologically. In Section 7 we construct a continuous map $\Xi_\Gamma : \mathcal{X}(F_g, SL_2(\mathbb{C})) \rightarrow X(v_{\Gamma, \ell, \phi})$. We recall that as a toric variety, $X(v_{\Gamma, \ell, \phi})$ is stratified by toric subvarieties $X(F)$ for $F \subset P_\Gamma$ the facets of its defining polyhedron.

Theorem 1.3. *The map Ξ_Γ is surjective, continuous, and proper. If F is not contained in a coordinate hyperplane of $\mathbb{R}^{E(\Gamma)}$, $\Xi_\Gamma : \Xi_\Gamma^{-1}(X(F)) \rightarrow X(F)$ is a homeomorphism. If F is contained in a coordinate hyperplane of $\mathbb{R}^{E(\Gamma)}$, $\Xi_\Gamma : \Xi_\Gamma^{-1}(X(F)) \rightarrow X(F)$ defines a fiber bundle over $X(F)$. In this latter case, if F is the origin of $\mathbb{R}^{E(\Gamma)}$, the fiber space of this bundle is the compact character variety $\mathcal{X}(F_g, SU(2))$, otherwise it is a product of 3-spheres.*

In Section 7 we place symplectic structures on both $\mathcal{X}(F_g, SL_2(\mathbb{C}))$ and $X(v_{\Gamma, \ell, \phi})$, derived from the symplectic form on $SL_2(\mathbb{C})$ obtained from its identification with the cotangent bundle $T^*(SU(2))$.

Theorem 1.4. *The map Ξ_Γ is a symplectomorphism on a dense, open subset of $\mathcal{X}(F_g, SL_2(\mathbb{C}))$.*

This theorem transfers the integrable system defined by the open torus orbit of $X(v_{\Gamma, \ell, \phi})$ to the character variety $\mathcal{X}(F_g, SL_2(\mathbb{C}))$, see Section 7. The momentum image of this system is the open facet of P_Γ .

Our last main theorem shows that the valuations $v_{\Gamma, \ell, \phi}$ come from divisor valuations on a compactification of $\mathcal{X}(F_g, SL_2(\mathbb{C}))$. We bring in the wonderful compactification X of the group $SL_2(\mathbb{C})$. This can be used to build a space $M_\Gamma(X)$, obtained by carrying out the the construction $M_\Gamma(-)$ for the $SL_2(\mathbb{C}) \times SL_2(\mathbb{C})$ space X , see Section 8.

Theorem 1.5. *For each isomorphism $\phi : \pi_1(\Gamma) \rightarrow F_g$, there is a compactification of $\mathcal{X}(F_g, SL_2(\mathbb{C}))$ by the projective scheme $M_\Gamma(X)$. The boundary divisor of this compactification is combinatorially of normal crossings type, and the divisorial valuations of its irreducible components generate the extremal rays of the cone $C_{\Gamma, \phi}$.*

In Section 8 we extend the toric degenerations of Theorem 1.2 to the compactification $M_\Gamma(X)$, obtaining a degeneration $M_\Gamma(X) \Rightarrow X(Q_\Gamma)$ to a toric variety associated to a polytope Q_Γ . The strata of the boundary divisor in Theorem 1.5 are shown to degenerate to toric varieties corresponding to the facets of Q_Γ .

Theorems 1.3 and 1.4 geometrically compares the special fiber of the flat degeneration defined by $v_{\Gamma, \ell, \phi}$ to a general fiber. It is inspired by earlier work of the author with Howard and Millson, [HMM], and the recent work of Harada and Kaveh [HK] and Nishinou, Nohara, and Ueda [NNU]. In [HK], the authors use a construction of Ruan [R] to show that a degeneration of a smooth, projective variety $Y \subset \mathbb{P}^N$ to a toric variety $Y(C) \subset \mathbb{P}^N$ can be used to produce a surjective, continuous, proper map $\Phi : Y \rightarrow Y(C)$ which is a symplectomorphism on a dense, open subset of Y with respect to the standard Kähler form on \mathbb{P}^N . This defines a dense, open integrable system in Y with momentum image C . Theorems 1.1 and 1.4 combine to give a similar conclusion for the character variety $\mathcal{X}(F_g, SL_2(\mathbb{C}))$, which is both affine and singular in general.

1.1. Acknowledgements. We thank Joachim Hilgert, Kiumars Kaveh, Sean Lawton, and Johan Martens for useful conversations which contributed to this project.

CONTENTS

1. Introduction	1
2. Metric graphs and outer space	4
3. Valuations, filtrations, and analytification	5
4. Degeneration, Compactification and Hamiltonian systems in $SL_2(\mathbb{C})$	6
5. Valuations on $\mathbb{C}[\mathcal{X}(F_g, SL_2(\mathbb{C}))]$	10
6. The sets $\mathcal{R}(\Gamma, \phi)$, $\mathcal{S}(\Gamma, \phi)$ and length functions	12
7. The Γ Hamiltonian system in $\mathcal{X}(F_g, SL_2(\mathbb{C}))$	22
8. Compactifications of $\mathcal{X}(F_g, SL_2(\mathbb{C}))$	26
References	30

2. METRIC GRAPHS AND OUTER SPACE

In this section we review material on metric graphs and cellular maps. Then we recall Culler and Vogtmann's definition of $O(g)$ and the length functions $d_\omega : O(g) \rightarrow \mathbb{R}$. See [V], [CV] for these definitions.

2.1. Graph notation and points of $O(g)$. Throughout the paper we use $E(\Gamma), V(\Gamma), L(\Gamma)$ to denote the edges, vertices and leaves of a graph, respectively. We will require all vertices $v \in V(\Gamma)$ to have valence at least 3 (excepting leaves). For each genus g we fix a distinguished graph Γ_g with a single vertex and no leaves. Graphs are also considered as CW complexes, and a map of graphs $\pi : \Gamma \rightarrow \Gamma'$ is taken to be a cellular map on the underlying topological spaces. A cellular map defines a set map on vertices $\pi_v : V(\Gamma) \rightarrow V(\Gamma')$, and takes an edge f to a cellular path $\pi_e(f) \subset \Gamma'$.

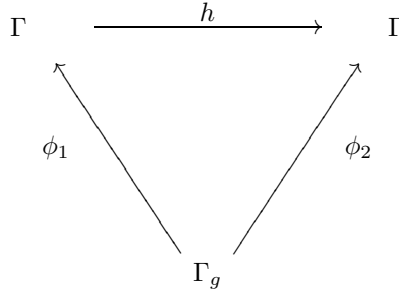
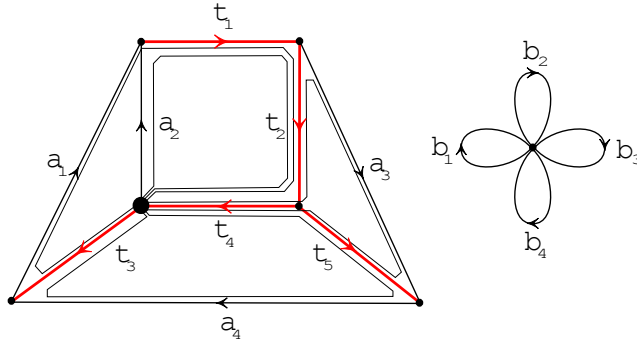

FIGURE 2. Equivalence of markings

Many of our constructions make use of an orientation on a graph, this is an ordering $\delta(e) = (u, v)$ of the endpoints of each edge $e \in E(\Gamma)$. An orientation also defines a partition $\epsilon(v) = i(v) \cup o(v)$ of the edges which contain a given vertex into incoming and outgoing edges. For any vertex $v \in V(\Gamma)$ we let the link $\Gamma_v \subset \Gamma$ be the subgraph induced by those edges in $\epsilon(v)$.

A metric graph (Γ, ℓ) is a graph Γ with an assignment $\ell : E(\Gamma) \rightarrow \mathbb{R}_{>0}$ of positive real lengths to its edges. A marking of a metric graph is a map $\phi : \Gamma_g \rightarrow \Gamma$ which defines an isomorphism on fundamental groups. Two markings $\phi_1 : \Gamma_g \rightarrow \Gamma, \phi_2 : \Gamma_g \rightarrow \Gamma$ are said to be equivalent if there is a map $h : \Gamma \rightarrow \Gamma$ which makes the diagram in Figure 2 commute up to free homotopy, we let $[\phi]$ be the equivalence class of a marking ϕ . As a set, outer space $O(g)$ is the collection of equivalence classes of markings of a metric graphs of genus g .

FIGURE 3. A red spanning tree \mathcal{T} in Γ , the maps are computed below.

$$(2) \quad \psi(a_i) = b_i, \quad \psi(t_i) = 1$$

$$(3) \quad \phi(b_1) = t_3 a_1 t_1 t_2 t_4 \quad \phi(b_2) = a_2 t_1 t_2 t_4 \quad \phi(b_3) = t_4^{-1} t_2^{-1} a_3 t_5^{-1} t_4 \quad \phi(b_4) = t_4^{-1} t_5 a_4 t_3^{-1}$$

For a fixed graph Γ , the collection of supported metrics forms the interior of a simplicial cone C_Γ , equal to the positive orthant in $\mathbb{R}^{E(\Gamma)}$. The points on the boundary of C_Γ can be viewed as metrics on degenerations of Γ , where some edges with a 0 length are collapsed. Each marking ϕ defines a cone $C_{\phi,\Gamma} \subset O(g)$ isomorphic to C_Γ . The statements we make in this paper concerning the embedding $\Sigma : O(g) \rightarrow \mathcal{X}(F_g, SL_2(\mathbb{C}))^{an}$ actually hold for the larger space $\bar{O}(g)$ obtained by considering all $\ell \in C_{\Gamma,\phi}$, $\ell : E(\Gamma) \rightarrow \mathbb{R}_{\geq 0}$.

Outer space is over parametrized by a special class of cellular maps. For a spanning tree $\mathcal{T} \subset \Gamma$, collapsing \mathcal{T} to a single vertex defines a homotopy equivalence $\psi_{\mathcal{T}} : \Gamma \rightarrow \Gamma_g$. An inverse $\phi_{\mathcal{T},V}$ to $\psi_{\mathcal{T}}$ can be constructed from a choice of vertex $V \in V(\Gamma)$ by sending the vertex of Γ_g to V , and an edge $e_i \in E(\Gamma_g)$ to the unique path in \mathcal{T} along with the corresponding edge in $E(\Gamma) \setminus E(\mathcal{T})$, oriented accordingly. We say that $\phi_{\mathcal{T},V} : \Gamma_g \rightarrow \Gamma$ is a distinguished cellular map. Culler and Vogtmann [CV] observe that any marking $\phi : \Gamma_g \rightarrow \Gamma$ can be obtained up to homotopy as a composition of a distinguished map and the cellular automorphism of Γ_g associated to an outer automorphism $\alpha : F_g \rightarrow F_g \cong \pi_1(\Gamma_g)$, see Figure 3. In fact, any marking ϕ is homotopy equivalent to an infinite number of $\phi_{\mathcal{T},V} \circ \alpha$.

2.2. Minimal length homotopy classes and length functions. The cellular length of a cellular path $(e_1, \dots, e_n) = \gamma \subset \Gamma$ is equal to the edge count n . A backtrack in a cellular path $\gamma \subset \Gamma$ is a sequence of edges of the form $e_1, \dots, e_k, e_k^{-1}, \dots, e_1^{-1}$. When a path γ has no backtracks, we say that it is reduced. For any metric graph Γ and free homotopy class $[\gamma]$, there is a unique, reduced cellular representative $\gamma \sim \gamma_{min}$ in Γ . In particular, γ_{min} is the unique representative of $[\gamma_{min}]$ without a backtrack.

Outer space has a natural set of coordinate functions defined by reduced words in the free group F_g . Each element $\omega \in F_g$ defines a homotopy class in $\pi_1(\Gamma_g)$, which can then be pushed forward to Γ by the marking ϕ . By passing to the unique reduced representative of $\pi_1(\phi)(\omega)$, we obtain a function $d_\omega : C_{\phi,\Gamma} \rightarrow \mathbb{R}_{\geq 0}$ by measuring the total length of this representative in (Γ, ℓ) , see [V] page 6. The collection of length functions $d_\omega, \omega \in F_g$ defines an embedding $\iota : O(g) \rightarrow \mathbb{R}^{\langle F_g \rangle}$ [CM], where $\langle F_g \rangle$ is the set of conjugation equivalence classes in F_g , [CV]. In particular, the $C_{\Gamma,\phi}$ define a decomposition into simplicial cones in this topology, [V].

3. VALUATIONS, FILTRATIONS, AND ANALYTIFICATION

In this section we review technical details of valuations which we use in Section 5. We also recall some of the structure of the analytification X^{an} of a complex affine variety $X = Spec(A)$.

3.1. Valuations on tensor products. In what follows, a rank 1 valuation $v : A \rightarrow \mathbb{R} \cup \{-\infty\}$ on a commutative \mathbb{C} algebra is a function which satisfies the following properties.

- (1) $v(ab) = v(a) + v(b)$
- (2) $v(a + b) \leq \max\{v(a), v(b)\}$
- (3) $v(C) = 0$ for all $C \in \mathbb{C}^*$.
- (4) $v(0) = -\infty$

Notice that we only consider valuations which lift the trivial valuation on \mathbb{C} . Let v and w be valuations on commutative \mathbb{C} -domains A and B , these functions define \mathbb{C} -algebra filtrations on A and B .

$$(4) \quad v_{\leq k}(A) = \{a \in A | v(a) \leq k\} \quad w_{\leq k}(B) = \{b \in B | w(b) \leq k\}$$

The associated graded algebras $gr_v(A)$ $gr_w(B)$ are the direct sum vector spaces $\bigoplus_{k \in v(A)} v_{\leq k}(A)/v_{<k}(A)$ and $\bigoplus_{k \in w(B)} w_{\leq k}(B)/w_{<k}(B)$ respectively, with the induced multiplication operation. A filtration F on a domain A comes from a valuation precisely when its associated graded algebra $gr_F(A)$ is also a domain. From now on we use v to denote both the valuation and the induced filtration. Both v and w can be used to define filtrations on the tensor product $A \otimes B$ (taken over \mathbb{C}), it is easy to check that both of these filtrations come from valuations.

$$(5) \quad v_{\leq k}(A \otimes B) = v_{\leq k}(A) \otimes B \quad w_{\leq k}(A \otimes B) = A \otimes w_{\leq k}(B)$$

The sum of two filtrations v, w is defined by the subspaces,

$$(6) \quad (v \oplus w)_{\leq m} = \sum_{i+j \leq m} v_{\leq i} \cap w_{\leq j}.$$

Similarly, the multiple Rv of a filtration is defined by setting

$$(7) \quad (Rv)_{\leq m} = \sum_{k \leq Rm} v_k(A)$$

Lemma 3.1. *Let $v, w : A \otimes B \rightarrow \mathbb{R} \cup \{-\infty\}$ be as above. Any linear combination $S \circ v \oplus T \circ w$, $S, T \in \mathbb{R}_{\geq 0}$ defines a valuation on $A \otimes B$.*

Proof. The associated graded algebra of v as a valuation on $A \otimes B$ is $gr_v(A) \otimes B$, which is manifestly a domain. This implies that v and w define valuations on $A \otimes B$.

Now we consider the sum valuation $S \circ v \oplus T \circ w$. By the first part, without loss of generality, we may take $S, T = 1$. We must prove that the associated graded algebra is a domain, we claim that it is in fact isomorphic to $gr_v(A) \otimes gr_w(B)$. We compute the quotient $(v \oplus w)_{\leq m} / (v \oplus w)_{< m}$.

$$(8) \quad (v \oplus w)_{\leq m} / (v \oplus w)_{< m} = \sum_{i+j \leq m} v_{\leq i} \cap w_{\leq j} / \sum_{i+j < m} v_{\leq i} \cap w_{\leq j}$$

The space $v_{\leq i} \cap w_{\leq j}$ is equal to $v_{\leq i} \otimes w_{\leq j}$, and $v_{\leq i} \otimes w_{\leq j} \subset v_{\leq i'} \otimes w_{\leq j'}$ if and only if $i \leq i'$ and $j \leq j'$. The space $(v \oplus w)_{\leq m} / (v \oplus w)_{< m}$ is spanned by the images of the spaces $v_{\leq i} \otimes w_{\leq j}$ with $i + j = m$, and the intersection of two of these spaces $v_{\leq i} \otimes w_{\leq j} \cap v_{\leq i'} \otimes w_{\leq j'}$ is $v_{\leq \min\{i, i'\}} \otimes w_{\leq \min\{j, j'\}}$, which is contained in $(v \oplus w)_{< m}$. It follows that the above quotient simplifies to the direct sum of the spaces $v_{\leq i} \otimes w_{\leq j} / v_{< i} \otimes w_{\leq j} + v_{\leq i} \otimes w_{< j} = v_{\leq i} / v_{< i} \otimes w_{\leq j} / w_{< j}$, this proves the claim. \square

Lemma 3.1 can be applied to two valuations $v, w : C \rightarrow \mathbb{R} \cup \{-\infty\}$ induced from an inclusion of algebras $C \subset A \otimes B$, this is how we use it in Section 5.

We will also need the following lemma, which relates the associated graded algebra of a filtration by representations of a reductive group G to the associated graded algebra of the invariant ring.

Lemma 3.2. *Let R be a \mathbb{C} algebra with a rational action by a reductive group G , and let v be a G -stable valuation, then the following holds.*

$$(9) \quad gr_v(R^G) = (gr_v(R))^G$$

Proof. This is a consequence of the exactness criteria of reductivity of G applied to the short exact sequence $0 \rightarrow v_{< m} \rightarrow v_{\leq m} \rightarrow v_{\leq m} / v_{< m} \rightarrow 0$. \square

3.2. Analytification. The set of all rank 1 valuations on a domain A which lift the trivial valuation on \mathbb{C} can be given the structure of a topological space called the analytification X^{an} of the associated affine variety $X = Spec(A)$, see [Ber], [P]. The analytification is given coarsest topology which makes the evaluation maps $[f] : X^{an} \rightarrow \mathbb{R}$, $[f](v) = v(f) \in \mathbb{R}$, $f \in A$ continuous, this makes X^{an} into a path connected, locally compact Hausdorff space. For a topological space Y , a set map $p : Y \rightarrow X^{an}$ is continuous if and only if for each generator $x \in X_I \subset \mathbb{C}[X]$, the evaluation of x in $\pi_I \circ p(y)$ for $y \in Y$ defines a continuous map from Y to \mathbb{R} , where $\pi_I : X^{an} \rightarrow T(I)$ is the projection map.

4. DEGENERATION, COMPACTIFICATION AND HAMILTONIAN SYSTEMS IN $SL_2(\mathbb{C})$

In this section we construct a flat degeneration of $SL_2(\mathbb{C})$ to the singular matrices $SL_2(\mathbb{C})^c \subset M_2(\mathbb{C})$. This valuation is shown to be divisorial with respect to the wonderful compactification X of $SL_2(\mathbb{C})$. We place symplectic structures on both $SL_2(\mathbb{C})$ and $SL_2(\mathbb{C})^c$ and recall a surjective, continuous, map $\Xi : SL_2(\mathbb{C}) \rightarrow SL_2(\mathbb{C})^c$ of $SU(2) \times SU(2)$ of Hamiltonian spaces which is a symplectomorphism on a dense open subset of $SL_2(\mathbb{C})$.

4.1. The coordinate rings. The algebraic aspects of $\mathbb{C}[\mathcal{X}(F_g, SL_2(\mathbb{C}))]$ covered in this paper derive from the interplay between two different ways to view the coordinate ring $\mathbb{C}[SL_2(\mathbb{C})]$. As an algebraic variety, the group $SL_2(\mathbb{C})$ is most familiar as the locus of the equation $AD - BC = 1$ in the space of 2×2 matrices $M_2(\mathbb{C})$.

$$(10) \quad SL_2(\mathbb{C}) = \{A, B, C, D \mid \det \begin{bmatrix} A & B \\ C & D \end{bmatrix} = 1\} \subset M_2(\mathbb{C})$$

Following the Peter-Weyl theorem, another description of this ring is provided by spaces of so-called matrix elements of irreducible representations of $SL_2(\mathbb{C})$. Recall that there is one such irreducible $V(i)$ for each non-negative integer $i \in \mathbb{Z}_{\geq 0}$, with $V(1) \cong \mathbb{C}^2$ and $V(i) \cong \text{Sym}^i(\mathbb{C}^2)$. For any $f \in \text{End}(V(i))$, there is a regular function on $SL_2(\mathbb{C})$ by $g \rightarrow \text{Tr}(g^{-1} \circ f)$, giving an inclusion of $SL_2(\mathbb{C}) \times SL_2(\mathbb{C})$ representations $\text{End}(V(i)) \subset \mathbb{C}[SL_2(\mathbb{C})]$. These spaces give the isotypical components of the $SL_2(\mathbb{C}) \times SL_2(\mathbb{C})$ decomposition of $\mathbb{C}[SL_2(\mathbb{C})]$.

$$(11) \quad \mathbb{C}[SL_2(\mathbb{C})] = \bigoplus_{i \in \mathbb{Z}_{\geq 0}} \text{End}(V(i))$$

An element $(g, h) \in SL_2(\mathbb{C}) \times SL_2(\mathbb{C})$ acts on $f : V(a) \rightarrow V(a)$ by pre and post composition, respectively.

$$(12) \quad (g, h) \circ [V \rightarrow f(V)] = [V \rightarrow g \circ f(h^{-1}V)]$$

These descriptions are connected by identifying the generators A, B, C, D above with matrix elements in $\text{End}(V(1)) = M_2(\mathbb{C})$. Let $X_{ij} \in \text{End}(\mathbb{C}^2)$ be the matrix which has ij entry equal to 1 and all other entries 0. The generators of $\mathbb{C}[SL_2(\mathbb{C})]$ are computed on an element $M \in SL_2(\mathbb{C})$ as follows.

$$(13) \quad A(M) = \text{Tr}(X_{00}M) \quad B(M) = \text{Tr}(X_{10}M) \quad C(M) = \text{Tr}(X_{01}M) \quad \text{Tr}(X_{11}M)$$

Let $U_-, U_+ \subset SL_2(\mathbb{C})$ be the groups of upper, respectively lower triangular matrices in $SL_2(\mathbb{C})$. It will be necessary to use the coordinate ring of the *GIT* quotients $SL_2(\mathbb{C})/U_-, U_+ \backslash SL_2(\mathbb{C})$, both of which are identified with \mathbb{C}^2 . The algebras $\mathbb{C}[SL_2(\mathbb{C})]^{U_-}, \mathbb{C}[SL_2(\mathbb{C})]^{U_+}$ are the subspaces of right highest, respectively left lowest weight vectors in the representation $\bigoplus_{i \in \mathbb{Z}_{\geq 0}} \text{End}(V(i)) = \bigoplus_{a \in \mathbb{Z}_{\geq 0}} V(i) \otimes V(i)$.

$$(14) \quad \mathbb{C}[SL_2(\mathbb{C})]^{U_-} = \mathbb{C}[SL_2(\mathbb{C})]^{U_+} = \bigoplus_{i \in \mathbb{Z}_{\geq 0}} V(i)$$

With actions taken on the right hand side, the algebra $\mathbb{C}[SL_2(\mathbb{C})]^{U_-} \subset \mathbb{C}[SL_2(\mathbb{C})]$ is a polynomial ring, generated by A, C , whereas $\mathbb{C}[SL_2(\mathbb{C})]^{U_+} \subset \mathbb{C}[SL_2(\mathbb{C})]$ is generated by B, D . Under the automorphism $(-)^{-1} : SL_2(\mathbb{C}) \rightarrow SL_2(\mathbb{C})$, $\mathbb{C}[U_- \backslash SL_2(\mathbb{C})]$ is likewise identified with a polynomial ring in two variables.

The isotypical decomposition of $\mathbb{C}[SL_2(\mathbb{C})]$ suggests a natural $SL_2(\mathbb{C}) \times SL_2(\mathbb{C})$ -stable filtration defined by the spaces $F_{\leq k} = \bigoplus_{i \leq k} \text{End}(V(i)) \subset \mathbb{C}[SL_2(\mathbb{C})]$. Following [Gr], Chapter 7, this is a filtration of algebras, in particular the image of a product $\text{End}(V(i))\text{End}(V(j))$ lies in the space $\bigoplus_{k \leq i+j} \text{End}(V(k))$. The associated graded algebra of this filtration is the algebra $[\mathbb{C}[SL_2(\mathbb{C})]^{U_-} \otimes \mathbb{C}[SL_2(\mathbb{C})]^{U_+}]^{\mathbb{C}^*}$. Here the the action by \mathbb{C}^* picks out the invariant subalgebra one would expect from the isotypical decomposition, $\bigoplus_{i \in \mathbb{Z}_{\geq 0}} V(i) \otimes V(i) \subset \mathbb{C}[SL_2(\mathbb{C})]^{U_-} \otimes \mathbb{C}[SL_2(\mathbb{C})]^{U_+}$. Hidden in this statement is the important fact that for any non-zero $f \in \text{End}(V(i)), g \in \text{End}(V(j))$, the component $(fg)_{i+j} \in \text{End}(V(i+j))$ is always non-zero, this is a consequence of the fact that $[\mathbb{C}[SL_2(\mathbb{C})]^{U_-} \otimes \mathbb{C}[SL_2(\mathbb{C})]^{U_+}]^{\mathbb{C}^*}$ is a domain.

We let $SL_2(\mathbb{C})^c = [SL_2(\mathbb{C})/U_- \times U_+ \backslash SL_2(\mathbb{C})]/\mathbb{C}^*$, following the notation in [HMM2], [M3]. Multiplication is $SL_2(\mathbb{C}) \times SL_2(\mathbb{C})$ -equivariant, and the isotypical components are irreducible representations of this group, it follows that each product map $[V(i) \otimes V(i)] \otimes [V(j) \otimes V(j)] \rightarrow [V(i+j) \otimes V(i+j)]$ is surjective, and this algebra is generated by the subspace $V(1) \otimes V(1)$. The associated graded algebra can be presented by $\mathbb{C}[A, B, C, D]$ modulo the initial ideal of $\langle AD - BC - 1 \rangle$ with respect to the

filtration F . As A, B, C, D all have the same filtration level, and 1 is a scalar, the associated graded algebra has the following presentation by a binomial.

$$(15) \quad \mathbb{C}[SL_2(\mathbb{C})^c] = \mathbb{C}[A, B, C, D] / \langle AD - BC \rangle$$

Notice that the equation $AD - BC = 0$ cuts out the set of singular matrices in $M_2(\mathbb{C})$. The algebra $\mathbb{C}[SL_2(\mathbb{C})^c]$ is isomorphic to $\mathbb{C}[(V(1) \times V(1))/\mathbb{C}^*]$ by the map $A \rightarrow X \otimes X, B \rightarrow X \otimes Y, C \rightarrow Y \otimes X, D \rightarrow Y \otimes Y$. We let \mathcal{P} be the pointed, polyhedral cone in \mathbb{R}^3 defined by the origin $(0, 0, 0)$ and the rays through the points $\{(0, 0, 1), (1, 0, 1), (0, 1, 1), (1, 1, 1)\}$, and we let P be the affine semigroup $\mathcal{P} \cap \mathbb{Z}^3$. The map $A \rightarrow (0, 0, 1), B \rightarrow (0, 1, 1), C \rightarrow (1, 0, 1), D \rightarrow (1, 1, 1)$ defines an isomorphism of algebras,

$$(16) \quad \mathbb{C}[SL_2(\mathbb{C})^c] \cong \mathbb{C}[P].$$

We also consider the Rees algebra of the filtration F .

$$(17) \quad R = \bigoplus_{k \in \mathbb{Z}_{\geq 0}} F_{\leq k}$$

From a SAGBI-type argument, one can present R as $\mathbb{C}[A, B, C, D, t] / \langle AD - BC - t^2 \rangle$, where $t \circ F_{\leq k} \subset F_{\leq k+1}$ identifies $F_{\leq k}$ with itself as a subspace of $F_{\leq k+1}$. The following are standard properties of Rees algebras.

- (1) R is flat over $\mathbb{C}[t]$ (The scheme $\text{Spec}(R)$ is a flat family over the affine line.)
- (2) $\frac{1}{t}R = \mathbb{C}[SL_2(\mathbb{C})] \otimes \mathbb{C}[t, \frac{1}{t}]$ (All nonzero fibers of $\text{Spec}(R)$ are isomorphic to $SL_2(\mathbb{C})$.)
- (3) $R/t = \mathbb{C}[SL_2(\mathbb{C})^c]$ (The scheme $\text{Spec}(R)$ defines a degeneration of $SL_2(\mathbb{C})$ to $SL_2(\mathbb{C})^c$)

We conclude by defining a valuation $v : \mathbb{C}[SL_2(\mathbb{C})] \rightarrow \mathbb{Z} \cup \{\infty\}$ using the filtration F . For $f = \sum f_a \in \bigoplus_{a \in \mathbb{Z}_{\geq 0}} \text{End}(V(a))$, one has $v(f) = \max\{a \mid f_a \neq 0\}$.

4.2. Symplectic structures. The discussion of integrable systems in Section 7 requires us to fix symplectic forms on $SL_2(\mathbb{C}), SL_2(\mathbb{C})^c$, and the spaces $SL_2(\mathbb{C})/U_-, U_+ \backslash SL_2(\mathbb{C})$. All of the symplectic forms we use stem from the canonical $SU(2) \times SU(2)$ -invariant symplectic form ω on the cotangent bundle $T^*(SU(2))$. The cotangent bundle is an $SU(2) \times SU(2)$ Hamiltonian space, with right and left momentum maps computed as follows, here $h \circ v$ denotes the coadjoint action.

$$(18) \quad h \circ_L(k, v) = (hk, v) \quad h \circ_R(k, v) = (kh^{-1}, h \circ v)$$

$$(19) \quad \mu_L(k, v) = k \circ v \quad \mu_R(k, v) = -v$$

The cotangent bundle $T^*(SU(2))$ is identified with $SL_2(\mathbb{C})$ by Cartan's polar decomposition, using the right-invariant trivialization $T^*(SU(2)) \cong SU(2) \times \mathfrak{su}(2)^*$.

$$(20) \quad T^*(SU(2)) \cong SL_2(\mathbb{C}) \quad (k, v) \rightarrow ke^{-iv}$$

A symplectic form is placed on $SL_2(\mathbb{C})/U_-, U_+ \backslash SL_2(\mathbb{C})$ from ω by viewing these spaces as the right, respectively left *symplectic implosions* of the cotangent bundle with respect to the standard Weyl chamber of $SU(2)$ and its negative. We refer the reader to [GJS] and [Kir] for the fundamentals of the symplectic implosion operation with respect to the action by a compact group.

We let $\varrho \in \mathfrak{su}(2)^*$ be the root vector in $\mathfrak{su}(2)^*$, with $\mathbb{R}_{\geq 0}\varrho, \mathbb{R}_{\leq 0}\varrho \subset \mathfrak{su}(2)^*$ the positive and negative Weyl chambers. The spaces $SL_2(\mathbb{C})/U_+$ and $U_- \backslash SL_2(\mathbb{C})$ are identified with quotient spaces of the subspaces $\mu_R^{-1}(\mathbb{R}_{\leq 0}\varrho), \mu_L^{-1}(\mathbb{R}_{\geq 0}\varrho) \subset T^*(SU(2))$ by the equivalence relation which collapses all (k, v) with $v = 0$ to a single point. The subspaces $\mu_R^{-1}(\mathbb{R}_{\leq 0}\varrho)$ and $\mu_L^{-1}(\mathbb{R}_{\geq 0}\varrho)$ are both topologically half-closed cylinders over a 3-sphere (homeomorphic to $SU(2)$). This equivalence relation collapses the closed sphere at the boundary, creating a topological copy of \mathbb{R}^4 . Implosions of Hamiltonian spaces

all come with induced, often singular symplectic structures, however the forms on $SL_2(\mathbb{C})/U_-$ and $U_+ \backslash SL_2(\mathbb{C})$ both agree with the standard form on \mathbb{C}^2 , see [GJS].

These isomorphisms are S^1 equivariant with respect to the standard action of S^1 on \mathbb{C}^2 and the residual S^1 action on $SL_2(\mathbb{C})/U$ through \mathbb{C}^* . In imploded cotangent coordinates, this action is $t \circ_R [k, v] = [kt^{-1}, v]$ and $t \circ_L [k, v] = [tk, v]$. The momentum maps for these actions are given simply by taking the length of the v coordinate.

We place a symplectic form on $SL_2(\mathbb{C})^c$ by taking the symplectic reduction of $SL_2(\mathbb{C})/U_- \times U_+ \backslash SL_2(\mathbb{C})$ at level 0 by the diagonal S^1 action. The momentum 0 subspace $\mu^{-1}(0) \subset SL_2(\mathbb{C})/U_- \times U_+ \backslash SL_2(\mathbb{C})$ is given by those elements $[k, w][h, v]$ with $w = h \circ v$. By standard results of Kirwan and Kempf, Ness, [Kir], [KN], this symplectic reduction can be identified with $SL_2(\mathbb{C})^c$. Notice that this space carries a residual Hamiltonian S^1 action, and that the momentum map for this action takes $[k, w][h, v]$ to the length $|v|$. Furthermore, the standard form on $SL_2(\mathbb{C})$ and the induced form on $SL_2(\mathbb{C})^c$ both agree with the form induced from embedding these spaces in $End(V(1)) \cong M_2(\mathbb{C})$, see [HMM2] for this point.

4.3. The map Ξ . Using the polar decomposition $SL_2(\mathbb{C}) \cong T^*(SU(2))$, we may define a continuous function on $SL_2(\mathbb{C})$ by setting $\xi(g) = \phi(ke^{-iv})$ equal to $|v|$, the length with respect to the Killing form on $su(2)^*$. This can be computed from the entries of g itself by as follows.

$$(21) \quad \xi(g) = \sqrt{\det(g^*g - \frac{1}{2}Tr(g^*g)I)}$$

Here g^* is the conjugate transpose of $g \in SL_2(\mathbb{C}) \subset M_2(\mathbb{C})$.

The map ξ is smooth on $SL_2(\mathbb{C})_o \subset SL_2(\mathbb{C})$ of matrices $g = ke^{iv}$ with $v \neq 0$, and it generates a Hamiltonian S^1 action on this subspace. However ξ has singularities along the subgroup $SU(2) \subset SL_2(\mathbb{C})$, where the S^1 flow is consequently not well-defined. Next we introduce a map which explains this phenomenon, and "repairs" the undefined flow by relating $SL_2(\mathbb{C})$ to $SL_2(\mathbb{C})^c$. We recall the contraction map $\Xi : SL_2(\mathbb{C}) \rightarrow SL_2(\mathbb{C})^c$ from [M3] and [HMM2]. For $g = ke^{iv}$, let $h \in SU(2)$ be an element which diagonalizes v , that is $h \circ v \in \mathbb{R}_{\geq 0}\rho \subset su(2)^*$. We define $\Xi : SL_2(\mathbb{C}) \rightarrow SL_2(\mathbb{C})^c$ as follows. Elements of $SL_2(\mathbb{C})$ and $SL_2(\mathbb{C})^c$ are represented in their cotangent coordinates.

$$(22) \quad \Xi(k, v) = [k, h \circ v][h, v]$$

It is straightforward to check that $\Xi(k, v)$ defines a class in $SL_2(\mathbb{C})^c$. The following proposition recalls all the properties of Ξ we will need, see [HMM2] for proof.

Proposition 4.1. *The map $\Xi : SL_2(\mathbb{C}) \rightarrow SL_2(\mathbb{C})^c$ is well-defined, surjective, continuous, and defines a symplectomorphism on $SL_2(\mathbb{C})_o$, and the subgroup $SU(2) = SL_2(\mathbb{C}) \setminus SL_2(\mathbb{C})_o$ is collapsed to a single point in the image. Furthermore, the composition of Ξ with $\mu : SL_2(\mathbb{C})^c \rightarrow \mathbb{R}$ is equal to ξ .*

The space $SL_2(\mathbb{C})^c$ carries the S^1 action generated by μ , which can be viewed as the flow of ξ "repaired" by collapsing the "bad" locus $SU(2) \subset SL_2(\mathbb{C})$ with the map Ξ . In this sense, passing from $SL_2(\mathbb{C})$ to $SL_2(\mathbb{C})^c$ replaces the group $SL_2(\mathbb{C})$ with a toric variety in both the algebraic and symplectic categories.

4.4. The wonderful compactification X . Using the descriptions of $\mathbb{C}[SL_2(\mathbb{C})^c]$ and R above, we obtain a compactification X of $SL_2(\mathbb{C})$ with irreducible divisor D as follows.

$$(1) \quad X = Proj(\mathbb{C}[a, b, c, d, t] / \langle ad - bc - t^2 \rangle) = Proj(R)$$

$$(2) \quad D = Proj(\mathbb{C}[a, b, c, d] / \langle ad - bc \rangle) \subset X$$

The divisor D is isomorphic to the toric variety $Proj(\mathbb{C}[P]) = \mathbb{P}^1 \times \mathbb{P}^1$ with its projective embedding by the line bundle $\mathcal{O}(1) \boxtimes \mathcal{O}(1)$. The ideal of D in the projective coordinate ring $\mathbb{C}[X]$ is principally generated by t .

$$(23) \quad \langle t \rangle = \bigoplus_{0 \leq a < k} End(V(a))t^k \subset R$$

It follows from the equation $\frac{1}{t}R = \mathbb{C}[SL_2(\mathbb{C})] \otimes \mathbb{C}[t, \frac{1}{t}]$ that the complement of D is the scheme $\text{Proj}(\frac{1}{t}\mathbb{C}[a, b, c, d, t] / \langle ad - bc - t^2 \rangle) = \text{Spec}(\mathbb{C}[a, b, c, d] / \langle ad - bc - 1 \rangle) = SL_2(\mathbb{C})$.

We induce a valuation \bar{v} on R from the valuation $v \oplus 0$ on $\mathbb{C}[SL_2(\mathbb{C})] \otimes \mathbb{C}[t]$. The associated graded algebra $T = gr_{\bar{v}}(R)$ is presented as $\mathbb{C}[a, b, c, d, t] / \langle ad - bc \rangle$. This defines a flat $SL_2(\mathbb{C}) \times SL_2(\mathbb{C})$ -stable degeneration of X to a projective toric variety $X_0 = \text{Proj}(T) = \text{Proj}(\mathbb{C}[P \times \mathbb{Z}_{\geq 0}])$.

5. VALUATIONS ON $\mathbb{C}[\mathcal{X}(F_g, SL_2(\mathbb{C}))]$

In this section we construct a cone of valuations $C_{\Gamma, \phi} \subset \mathcal{X}(F_g, SL_2(\mathbb{C}))^{an}$ for each marking $\phi : \Gamma_{0,g} \rightarrow \Gamma$ in three steps. First, we define a space $M_{\Gamma}(SL_2(\mathbb{C}))$ for each oriented graph Γ , such that $M_{\Gamma_{0,g}}(SL_2(\mathbb{C}))$ is naturally isomorphic to $\mathcal{X}(F_g, SL_2(\mathbb{C}))$. Then we construct a simplicial cone of valuations $C_{\Gamma} \subset M_{\Gamma}(SL_2(\mathbb{C}))^{an}$ using the valuation $v : \mathbb{C}[SL_2(\mathbb{C})] \rightarrow \mathbb{Z} \cup \{-\infty\}$ constructed in Section 4. We conclude by showing that each marking $\phi : \Gamma_g \rightarrow \Gamma$ gives an isomorphism $\phi^* : M_{\Gamma}(SL_2(\mathbb{C})) \rightarrow M_{\Gamma_g}(SL_2(\mathbb{C}))$, this induces a cone of valuations $C_{\Gamma, \phi} = \phi^*(C_{\Gamma}) \subset \mathcal{X}(F_g, SL_2(\mathbb{C}))^{an}$.

5.1. The space $M_{\Gamma}(X)$ and the cone C_{Γ} . Let X be an affine $SL_2(\mathbb{C}) \times SL_2(\mathbb{C})$ space, and Γ any finite oriented graph with all non-leaf vertices of valence at least three. We define an action of $SL_2(\mathbb{C})^{V(\Gamma)}$ on $X^{E(\Gamma)}$. An element $(\dots g_w \dots) \in SL_2(\mathbb{C})^{V(\Gamma)}$ acts on $(\dots x_e \dots) \in X^{E(\Gamma)}$ by sending it to $(\dots g_v x_e g_u^{-1} \dots)$, where $\delta(e) = (v, u)$. We let $M_{\Gamma}(X)$ be the corresponding GIT quotient.

$$(24) \quad M_{\Gamma}(X) = SL_2(\mathbb{C})^{V(\Gamma)} \backslash X^{E(\Gamma)}$$

Two cases of this construction are of interest, $X = SL_2(\mathbb{C}), SL_2(\mathbb{C})^c$. When the graph is Γ_g (with any orientation), and $X = SL_2(\mathbb{C})$, each $(h_1, \dots, h_g) \in SL_2(\mathbb{C})^{E(\Gamma_{g,0})}$ is conjugated by $g_v \in SL_2(\mathbb{C})^{V(\Gamma_{g,0})}$, so this construction reduces to the GIT definition of the character variety of $F_g = \pi_1(\Gamma_{g,0})$.

$$(25) \quad M_{\Gamma_g}(SL_2(\mathbb{C})) = \mathcal{X}(F_g, SL_2(\mathbb{C}))$$

The coordinate ring $\mathbb{C}[M_{\Gamma}(SL_2(\mathbb{C}))]$ is a subalgebra of $\mathbb{C}[SL_2(\mathbb{C})^{E(\Gamma)}]$, each component of the latter carries a copy v_e of the valuation $v : \mathbb{C}[SL_2(\mathbb{C})] \rightarrow \mathbb{Z} \cup \{-\infty\}$. By Lemma 3.2 there is a cone $C_{\Gamma} = \prod \mathbb{R}_{\geq 0} v_e$ of valuations on $\mathbb{C}[SL_2(\mathbb{C})^{E(\Gamma)}]$, and therefore $\mathbb{C}[M_{\Gamma}(SL_2(\mathbb{C}))]$. We let v_{ℓ} be the valuation corresponding to an assignment $\ell : E(\Gamma) \rightarrow \mathbb{R}_{\geq 0}$. The following proposition allows us to compute the associated graded algebra of an interior valuation from this cone.

Proposition 5.1. *For an interior element $v_{\ell} \in C_{\Gamma}$, the associated graded algebra of $\mathbb{C}[M_{\Gamma}(SL_2(\mathbb{C}))]$ is isomorphic to $\mathbb{C}[M_{\Gamma}(SL_2(\mathbb{C})^c)]$.*

Proof. This follows from Lemmas 3.2 and 3.1. □

5.2. The graph functor. We show that the construction $M_{\Gamma}(SL_2(\mathbb{C}))$ is functorial with respect to cellular graph maps. Then we restrict to cellular homotopy isomorphisms, and we prove that any marking $\phi : \Gamma_g \rightarrow \Gamma$, induces an isomorphism $\phi^* : M_{\Gamma}(SL_2(\mathbb{C})) \cong \mathcal{X}(F_g, SL_2(\mathbb{C})) = M_{\Gamma_g}(SL_2(\mathbb{C}))$. Then we show that if two cellular homotopy isomorphisms $\phi_1, \phi_2 : \Gamma_1 \rightarrow \Gamma_2$ induce the same map on homotopy, $\pi_1(\phi_1) = \pi_1(\phi_2)$, then the maps on varieties also agree, $\phi_1^* = \phi_2^*$. In particular, each equivalence class of markings $[\phi] : \Gamma_g \rightarrow \Gamma$ defines a unique associated isomorphism $\phi^* : M_{\Gamma}(SL_2(\mathbb{C})) \cong \mathcal{X}(F_g, SL_2(\mathbb{C}))$.

Recall that a cellular map $\phi : \Gamma_1 \rightarrow \Gamma_2$ takes an edge $f \in E(\Gamma_1)$ to a path $W_f \subset \Gamma_2$. These paths determine a regular map of affine varieties $\phi^s : SL_2(\mathbb{C})^{E(\Gamma_2)} \rightarrow SL_2(\mathbb{C})^{E(\Gamma_1)}$ by sending $(\dots h_e \dots) \in SL_2(\mathbb{C})^{E(\Gamma_2)}$ to $(\dots, W_f(\dots h_e \dots), \dots) \in SL_2(\mathbb{C})^{E(\Gamma_1)}$. In particular, if ϕ collapses the edge f , then $W_f(\dots, h_e, \dots) = Id$.

If we act on $(\dots h_e \dots) \in SL_2(\mathbb{C})^{E(\Gamma_2)}$ with $(\dots g_w \dots) \in SL_2(\mathbb{C})^{V(\Gamma_2)}$ and pass the result through ϕ^s the definition of the action above implies that every internal element in the word $w_f(\dots h_e \dots)$ is left unchanged, and the resulting element is $g_v w_f(\dots h_e \dots) g_u^{-1}$, where $\delta(f) = (v, u)$. In other words, ϕ also determines a map $\phi^a : SL_2(\mathbb{C})^{V(\Gamma_2)} \rightarrow SL_2(\mathbb{C})^{V(\Gamma_1)}$, and ϕ^s intertwines the map ϕ^a . It follows that ϕ defines a regular map of varieties.

$$(26) \quad \phi^* : M_{\Gamma_2}(SL_2(\mathbb{C})) \rightarrow M_{\Gamma_1}(SL_2(\mathbb{C}))$$

It is straightforward to check that $(\phi_2 \circ \phi_1)^s = \phi_1^s \circ \phi_2^s$ and $(\phi_2 \circ \phi_1)^a = \phi_1^a \circ \phi_2^a$, so that $(\phi_2 \circ \phi_1)^* = \phi_1^* \circ \phi_2^*$. It follows that $M_-(SL_2(\mathbb{C}))$ defines a functor from the category of finite graphs with cellular maps to affine varieties.

Example 5.2. Let $\phi : \Gamma \rightarrow \Gamma$ be an isomorphism of graphs, which reverses the orientation of one edge $e \in E(\Gamma)$ with $\delta(e) = (u, v)$. This induces an automorphism of $M_\Gamma(SL_2(\mathbb{C}))$ by $(-)^{-1} : SL_2(\mathbb{C})^e \rightarrow SL_2(\mathbb{C})^e \subset SL_2(\mathbb{C})^{E(\Gamma)}$. This takes the edge element $g_u h_e g_v^{-1}$ to $g_v h_e^{-1} g_u^{-1}$, and therefore intertwines the $SL_2(\mathbb{C})^{V(\Gamma)}$ action.

Example 5.3. Let $\theta : \Gamma_g \rightarrow \Gamma_g$ be induced from an outer automorphism of F_g , namely an assignment $e_i \rightarrow W_i$ of g generating words to the edges of Γ_g . Then $\theta^s : SL_2(\mathbb{C})^{E(\Gamma_g)} \rightarrow SL_2(\mathbb{C})^{E(\Gamma_g)}$ is the regular map defined by sending $\vec{h} = (h_1, \dots, h_g) \rightarrow (W_1(\vec{h}), \dots, W_g(\vec{h}))$. The inverse of this map is likewise defined by the inverse of θ . This defines the action of $\text{Out}(F_g)$ on $\mathcal{X}(F_g, SL_2(\mathbb{C})) = M_{\Gamma_g}(SL_2(\mathbb{C}))$.

Example 5.4. Let $\psi : \Gamma_g \rightarrow \Gamma$ and $\phi : \Gamma \rightarrow \Gamma_g$ be a pair of maps induced by a choice of spanning tree $\mathcal{T} \subset \Gamma$. The map ϕ^s sends $(h_1, \dots, h_g) \in SL_2(\mathbb{C})^{E(\Gamma_g)}$ to the element in $SL_2(\mathbb{C})^{E(\Gamma)}$ obtained by assigning Id to all edges in \mathcal{T} , and h_i to the edge in $E(\Gamma) \setminus E(\mathcal{T})$ corresponding to the i -th edge of Γ_g . As ϕ maps each vertex in Γ down to the unique vertex of Γ_g , $\phi^a : SL_2(\mathbb{C}) \rightarrow SL_2(\mathbb{C})^{V(\Gamma)}$ is the diagonal embedding.

Let $V \in V(\Gamma)$ be the basepoint image of the unique vertex in Γ_g under ψ . The map ψ^s sends an element $(\dots h_e \dots) \in SL_2(\mathbb{C})^{E(\Gamma)}$ an assignment of words $w_i(\dots h_e \dots)$ to the edges of Γ_g . Let $e_i \in E(\Gamma)$ be the preimage of the i -th edge of Γ_g under ϕ , with $\delta(e_i) = (u_i, v_i)$. The word $w_i(\dots h_e \dots)$ is computed by following the unique path $V \rightarrow u_i, e_i, v_i \rightarrow V$, and recording h_e or h_e^{-1} for each traversed edge, where the sign depends on the orientation of e with respect to the direction of the path.

Lemma 5.5. For any distinguished map $\phi : \Gamma_g \rightarrow \Gamma$, the induced map ϕ^* is an isomorphism of affine varieties.

Proof. We must treat two cases, $\theta : \Gamma_g \rightarrow \Gamma_g$ induced from an outer automorphism of F_g , and $\psi : \Gamma_g \rightarrow \Gamma$, $\phi : \Gamma \rightarrow \Gamma_g$ maps induced by a choice of spanning tree $\mathcal{T} \subset \Gamma$. The first case is handled in Example 5.3. For the second case, we must check that ψ^* and ϕ^* discussed in Example 5.4 are inverse to each other. The discussion in example 5.4 immediately implies that $\psi^* \circ \phi^*$ is the identity on $M_{\Gamma_g}(SL_2(\mathbb{C}))$.

Consider any edge $e \in \mathcal{T} \subset \Gamma$ with $\delta(e) = (u, v)$, $v \neq V$. Using the action of $SL_2(\mathbb{C})^{\{v\}} \subset SL_2(\mathbb{C})^{V(\Gamma)}$ we can move $(\dots h_e \dots)$ to $(\dots, 1, \dots)$, by introducing h_e or h_e^{-1} on the other incident edges of v according to their orientations. The W_i do not change under this operation. The same construction can be applied to $u \neq V$ as above. It follows that we may move any point in $SL_2(\mathbb{C})^{E(\Gamma)}$ into the image of $\phi^* \circ \psi^*$ using the action of $SL_2(\mathbb{C})^{V(\Gamma)}$. As a consequence, the induced maps on invariant rings are 1 – 1 and onto. \square

The map ϕ depends on a choice of basepoint $V \in V(\Gamma)$. Following the definition of ϕ^* , the image $\phi^*(\dots h_e \dots) = (\dots W_i(\dots h_e \dots) \dots)$ differs under a change of basepoint by including or taking away backtracks in the words W_i , a modification which does not change the value of $W_i(\dots, h_e, \dots) \in SL_2(\mathbb{C})$. It follows that ϕ^* is independent of this choice of basepoint. Next we prove a generalization of this fact.

Proposition 5.6. Let $\phi_1, \phi_2 : \Gamma_g \rightarrow \Gamma$ be markings which satisfy $\pi_1(\phi_1) = \pi_1(\phi_2)$, then $\phi_1^* = \phi_2^*$.

Proof. For any edge $e \in E(\Gamma_g)$, the loops $\phi_1(e), \phi_2(e) \subset \Gamma$ are freely homotopic. It follows that both differ from a common minimal length cellular class γ by removing backtracks. Following the argument above, we have $W_i^1(\dots h_e \dots) = W_i^2(\dots h_e \dots)$ for any $(\dots h_e \dots) \in M_\Gamma(SL_2(\mathbb{C}))$. \square

From Proposition 5.6 and Lemma 5.5, it follows that any equivalence class of markings $[\phi] : \Gamma_g \rightarrow \Gamma$ corresponds to a well-defined isomorphism of varieties $\phi^* : M_\Gamma(SL_2(\mathbb{C})) \cong \mathcal{X}(F_g, SL_2(\mathbb{C}))$, and an isomorphism of coordinate rings.

$$(27) \quad \hat{\phi} : \mathbb{C}[\mathcal{X}(F_g, SL_2(\mathbb{C}))] \rightarrow \mathbb{C}[M_\Gamma(SL_2(\mathbb{C}))]$$

As a consequence, there is a distinguished cone of valuations $C_{\Gamma, \phi} \in \mathcal{X}(F_g, SL_2(\mathbb{C}))^{an}$ obtained as the pullback of the valuations in C_Γ along $\hat{\phi}$.

$$\begin{array}{ccc}
M_{\Gamma_1}(SL_2(\mathbb{C})) & \begin{array}{c} \xrightarrow{\phi_2^*} \\ \xrightarrow{\phi_1^*} \end{array} & M_{\Gamma_1}(SL_2(\mathbb{C})) \\
\begin{array}{c} \searrow \theta_2^* \\ \searrow \theta_1^* \end{array} & & \searrow \theta^* \\
& \mathcal{X}(F_g, SL_2(\mathbb{C})) &
\end{array}$$

FIGURE 4.

We finish this section by considering two cellular maps $\phi_1, \phi_2 : \Gamma_1 \rightarrow \Gamma_2$ with $\pi_1(\phi_1) = \pi_1(\phi_2)$. We can choose a spanning tree in Γ_1 , and a corresponding distinguished map $\theta : \Gamma_g \rightarrow \Gamma_1$. This defines two cellular maps $\theta_i = \phi_i \circ \theta : \Gamma_g \rightarrow \Gamma_2$, which are the same map under π_1 . It follows from the proof of Proposition 5.6 that θ_1^*, θ_2^* and therefore ϕ_1^*, ϕ_2^* define the same maps on varieties, see Figure 4.

6. THE SETS $\mathcal{R}(\Gamma, \phi), \mathcal{S}(\Gamma, \phi)$ AND LENGTH FUNCTIONS

We discuss two spanning sets $\mathcal{R}(\Gamma, \phi), \mathcal{S}(\Gamma, \phi) \subset \mathbb{C}[\mathcal{X}(F_g, SL_2(\mathbb{C}))]$ associated to a marking $\phi : \Gamma_g \rightarrow \Gamma$. Both $\mathcal{R}(\Gamma, \phi)$ and $\mathcal{S}(\Gamma, \phi)$ are in bijection with sets of combinatorial gadgets. Elements of $\mathcal{S}(\Gamma, \phi)$ correspond to closed paths in Γ , and the elements of $\mathcal{R}(\Gamma, \phi)$ are in bijection with the spin diagrams with topology Γ . We relate these sets to each other, showing that any element of $\mathcal{S}(\Gamma, \phi)$ has a lower-triangular expansion into spin diagrams in $\mathcal{R}(\Gamma)$. We then show how to evaluate elements from both of these sets in the valuations $v_{\Gamma, \ell, \phi} \in C_{\Gamma, \phi}$. We finish the section by showing that the set $\mathcal{S}(\Gamma, \phi)$ does not depend on the marking ϕ , and we use this to give an embedding of $O(g)$ into $\mathcal{X}(F_g, SL_2(\mathbb{C}))^{an}$.

6.1. Spin diagrams. We fix a marking of a trivalent graph $\phi : \Gamma_g \rightarrow \Gamma$, and use the induced isomorphism $\phi^* : M_{\Gamma}(SL_2(\mathbb{C})) \rightarrow \mathcal{X}(F_g, SL_2(\mathbb{C}))$ to define a basis in $\mathbb{C}[\mathcal{X}(F_g, SL_2(\mathbb{C}))]$ with invariant theory. We observe that the coordinate ring of the space $SL_2(\mathbb{C})^{E(\Gamma)}$ has the following isotypical decomposition under the action of $SL_2(\mathbb{C})^{E(\Gamma)} \times SL_2(\mathbb{C})^{E(\Gamma)}$.

$$(28) \quad \mathbb{C}[SL_2(\mathbb{C})^{E(\Gamma)}] = \bigoplus_{a: E(\Gamma) \rightarrow \mathbb{Z}_{\geq 0}} \bigotimes_{e \in E(\Gamma)} V(a(e)) \otimes V(a(e))$$

Passing to $SL_2(\mathbb{C})^{V(\Gamma)}$ invariants gives a direct sum decomposition of the coordinate ring of $M_{\Gamma}(SL_2(\mathbb{C}))$.

$$(29) \quad \mathbb{C}[M_{\Gamma}(SL_2(\mathbb{C}))] = \bigoplus_{a: E(\Gamma) \rightarrow \mathbb{Z}_{\geq 0}} \left[\bigotimes_{e \in E(\Gamma)} V(a(e)) \otimes V(a(e)) \right]^{SL_2(\mathbb{C})^{V(\Gamma)}}$$

Recall that there is a copy of $SL_2(\mathbb{C})$ for each vertex $v \in V(\Gamma)$, acting on the tensor product $V(a(e)) \otimes V(a(f)) \otimes V(a(g))$, where $v \in \delta(e), \delta(f), \delta(g)$. The Clebsch-Gordon rule implies that the invariant subspace of such a tensor product is at most one dimensional, and this space is nontrivial if and only if the numbers $a(e), a(f), a(g)$ satisfy two conditions.

$$(1) \quad a(e) + a(f) + a(g) \in 2\mathbb{Z}$$

$$(2) \quad a(e), a(f), a(g) \text{ are the sides of a triangle: } |a(e) - a(g)| \leq a(f) \leq a(e) + a(g).$$

We let \mathcal{P}_{Γ} be the real cone of $a : E(\Gamma) \rightarrow \mathbb{R}_{\geq 0}$ which satisfy condition 2 above, $L_{\Gamma} \subset \mathbb{R}^{E(\Gamma)}$ be the lattice of integers which satisfy condition 1, and $P_{\Gamma} = \mathcal{P}_{\Gamma} \cap L_{\Gamma}$ be the associated affine semigroup. As $[V(a(e)) \otimes V(a(f)) \otimes V(a(g))]^{SL_2(\mathbb{C})}$ is multiplicity-free, each space $[\bigotimes_{e \in E(\Gamma)} V(a(e)) \otimes V(a(e))]^{SL_2(\mathbb{C})^{V(\Gamma)}}$ is dimension 0 or 1, with dimension 1 occurring precisely when $a \in P_{\Gamma}$. For our purposes, we may take Φ_a to be any fixed element in this space, see [LP] for a representation theoretic way to define a specific element. We have the following direct sum decomposition.

$$(30) \quad \mathbb{C}[M_\Gamma(SL_2(\mathbb{C}))] = \bigoplus_{a \in P_\Gamma} \mathbb{C}\Phi_a$$

We let $R(\Gamma) \subset \mathbb{C}[M_\Gamma(SL_2(\mathbb{C}))]$ be the collection of these elements, also called spin diagrams. The algebraic properties of these diagrams are explored extensively in [LP]. We use this basis to understand the valuations $v_\ell \in C_\Gamma$, the following holds practically by definition.

$$(31) \quad v_\ell(\Phi_a) = \sum_{e \in E(\Gamma)} \ell(e)a(e)$$

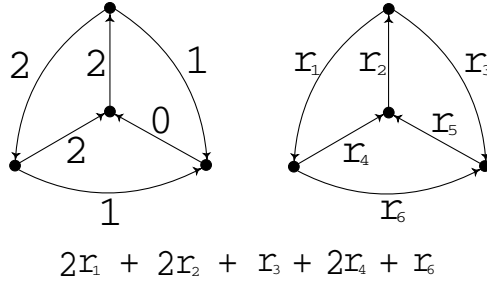

FIGURE 5. Evaluating a spin diagram element on the left in a valuation on the right.

Multiplication in $\mathbb{C}[M_\Gamma(SL_2(\mathbb{C}))]$ can be combinatorially computed using this basis, see [LP]. We need less than a complete treatment of this operation. We place a partial ordering on the lattice points in P_Γ , where $a \prec a'$ if $a' - a \in C_\Gamma$, ie if $a(e) \leq a'(e)$ for all $e \in E(\Gamma)$.

Proposition 6.1. *A product $\Phi_a\Phi_{a'}$ is a linear combination of Φ_t with $t \prec a + a'$, furthermore, the $\Phi_{a+a'}$ term always appears with a non-zero coefficient.*

Proof. The first statement is a consequence of the corresponding fact for $\mathbb{C}[SL_2(\mathbb{C})]$. For the second statement, we choose a valuation $v_\ell \in \text{int}(C_\Gamma)$, and consider $v_\ell(\Phi_a\Phi_{a'}) = v_\ell(\Phi_a) + v_\ell(\Phi_{a'})$. If $\Phi_{a+a'}$ did not appear in $\Phi_a\Phi_{a'}$ then this element would be a linear combination of Φ_t with $t(e) < a(e) + a'(e)$ for some $e \in E(\Gamma)$. For each of these terms we must have $v_\ell(\Phi_t) < v_\ell(\Phi_a) + v_\ell(\Phi_{a'})$, which gives a contradiction. \square

For any $f \in \mathbb{C}[M_\Gamma(SL_2(\mathbb{C}))]$ we may write $f = \sum_{a \in P_\Gamma} C_a \Phi_a$. If there is a $a \in P_\Gamma$ with $C_a \neq 0$ and $a' \prec a$ for all $C_{a'} \neq 0$, we say that Φ_w is the initial term of f , $\text{in}(f) = C_a \Phi_a$. This notion can also be defined in the coordinate ring $\mathbb{C}[SL_2(\mathbb{C})^{E(\Gamma)}]$, where $\text{in}(f)$ is taken to be the contribution from the isotypical space $\otimes_{e \in E(\Gamma)} V(a(e)) \otimes V(a(e))$ with a maximal under \prec . We note that the $SL_2(\mathbb{C})^{V(\Gamma)}$ -stability of this decomposition implies that the initial term of an invariant $f \in \mathbb{C}[M_\Gamma(SL_2(\mathbb{C}))] \subset \mathbb{C}[SL_2(\mathbb{C})^{E(\Gamma)}]$ can be computed in either ring, with the same result.

The coordinate ring $\mathbb{C}[M_\Gamma(SL_2(\mathbb{C})^c)]$ has a decomposition into invariant spaces identical to the decomposition of $\mathbb{C}[M_\Gamma(SL_2(\mathbb{C}))]$ discussed above. Each of these spaces is of course 1-dimensional, and as the multiplication operation on $\mathbb{C}[SL_2(\mathbb{C})^c]$ is graded by the highest weights in the isotypical decomposition, $\mathbb{C}[M_\Gamma(SL_2(\mathbb{C})^c)]$ is graded by the assignments $w \in P_\Gamma$. The following is an immediate consequence.

Proposition 6.2. *The space $M_\Gamma(SL_2(\mathbb{C})^c)$ is the affine toric variety $\text{Spec}(\mathbb{C}[P_\Gamma]) = X(v_{\Gamma, \ell, \gamma})$ from the introduction.*

In this sense, taking associated graded by an element $v \in \text{int}(C_\Gamma)$ replaces the multiplication operation in $\mathbb{C}[M_\Gamma(SL_2(\mathbb{C}))]$ by the naive multiplication operation given by component-wise addition on the isotypical weightings a .

6.2. The spaces $M_{0,k}(SL_2(\mathbb{C}))$ and an alternative construction of $M_\Gamma(SL_2(\mathbb{C}))$. We give a different construction of the space $M_\Gamma(SL_2(\mathbb{C}))$ which is useful in describing a second spanning set $S(\Gamma) \subset \mathbb{C}[M_\Gamma(SL_2(\mathbb{C}))]$. Consider the following left diagonal GIT quotient.

$$(32) \quad M_{0,k}(SL_2(\mathbb{C})) = SL_2(\mathbb{C}) \backslash SL_2(\mathbb{C})^k$$

For an oriented graph Γ , we form the product variety $\prod_{v \in V(\Gamma)} M_{0,\epsilon(v)}(SL_2(\mathbb{C}))$. This space comes with a residual action by $SL_2(\mathbb{C})^{E(\Gamma)} \times SL_2(\mathbb{C})^{E(\Gamma)}$, where there are two copies of $SL_2(\mathbb{C})$ for each edge $e \in E(\Gamma)$. A right hand side quotient by a diagonally embedded $SL_2(\mathbb{C})^{E(\Gamma)} \subset SL_2(\mathbb{C})^{2E(\Gamma)}$ gives the following identity.

$$(33) \quad \left[\prod_{v \in V(\Gamma)} M_{0,\epsilon(v)}(SL_2(\mathbb{C})) \right] / SL_2(\mathbb{C})^{E(\Gamma)} \cong SL_2(\mathbb{C})^{V(\Gamma)} \backslash \left[\prod_{e \in E(\Gamma)} SL_2(\mathbb{C})^{E(\Gamma)} \right] = M_\Gamma(SL_2(\mathbb{C}))$$

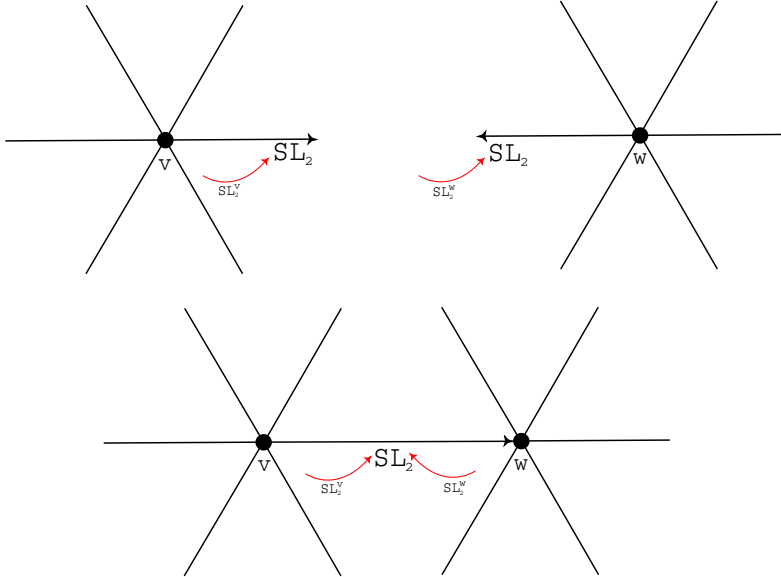

FIGURE 6. The isomorphism takes $SL_2(\mathbb{C}) \backslash [SL_2(\mathbb{C}) \times SL_2(\mathbb{C})]$ with its two right hand actions to $SL_2(\mathbb{C})$ with its left and right actions.

We view the group $SL_2(\mathbb{C})$ as an affine GIT quotient $[SL_2(\mathbb{C}) \times SL_2(\mathbb{C})] / SL_2(\mathbb{C})$, where $SL_2(\mathbb{C})$ acts on the right hand side of both components. The equivariant $SL_2(\mathbb{C}) \times SL_2(\mathbb{C})$ isomorphism between these spaces is provided by the map $(g, h) \rightarrow h^{-1}g$. The quotient $[\prod_{v \in V(\Gamma)} M_{0,\epsilon(v)}(SL_2(\mathbb{C}))] / SL_2(\mathbb{C})^{E(\Gamma)}$ does not depend on the orientation of Γ . This information is used in the choice of which "half" of the edge e we consider to be identified with the right, respectively left sides of $SL_2(\mathbb{C}) \times SL_2(\mathbb{C})$, this determines the isomorphism with $M_\Gamma(SL_2(\mathbb{C}))$.

For an oriented tree \mathcal{T} we define the $M_{0,\mathcal{T}}(SL_2(\mathbb{C}))$ to be $[\prod_{v \in V(\mathcal{T})} M_{0,\epsilon(v)}(SL_2(\mathbb{C}))] / SL_2(\mathbb{C})^{E(\mathcal{T})}$ using the same construction as above. By applying the isomorphism $[SL_2(\mathbb{C}) \times SL_2(\mathbb{C})] / SL_2(\mathbb{C}) \cong SL_2(\mathbb{C})$, we find that this space is isomorphic to the quotient $[SL_2(\mathbb{C})^{E(\Gamma) \cup \mathcal{L}(\mathcal{T})}] / SL_2(\mathbb{C})^{V(\Gamma)}$. Let $\Phi_{\mathcal{T}} : M_{0,\mathcal{L}(\mathcal{T})}(SL_2(\mathbb{C})) \rightarrow M_{0,\mathcal{T}}(SL_2(\mathbb{C}))$ be the map that assigns (g_1, \dots, g_n) to the leaves of \mathcal{T} , and $Id \in SL_2(\mathbb{C})$ to all edges, similar to the map Φ from Section 5. By choosing a base point $V \in V(\mathcal{T})$, we define $\Psi_{\mathcal{T}} : M_{0,\mathcal{T}}(SL_2(\mathbb{C})) \rightarrow M_{0,\mathcal{L}(\mathcal{T})}(SL_2(\mathbb{C}))$ in the analogous manner, an element (\dots, g_e, \dots) is sent to the element $(W_1(\dots g_e \dots), \dots, W_{|\mathcal{L}(\mathcal{T})|}(\dots g_e \dots))$ where W_i is the oriented word obtained by following the unique path from V to the i -th leaf of \mathcal{T} .

For a graph Γ , and a spanning tree \mathcal{T} , we let $T(\mathcal{T}, \Gamma)$ be the tree obtained by splitting each edge in $E(\Gamma) \setminus E(\mathcal{T})$, see Figure 7. There is a natural quotient map associated to gluing the two ends of a split edge back together.

$$(34) \quad \pi_{\mathcal{T}, \Gamma} : M_{0, T(\mathcal{T}, \Gamma)}(SL_2(\mathbb{C})) \rightarrow M_{\Gamma}(SL_2(\mathbb{C})) = M_{0, T(\mathcal{T}, \Gamma)}(SL_2(\mathbb{C})) / SL_2(\mathbb{C})^{E(\Gamma) \setminus E(\mathcal{T})}$$

We let π_0 be this quotient map for the special case $\Gamma = \Gamma_g$.

$$(35) \quad \pi_0 : M_{0, 2g}(SL_2(\mathbb{C})) \rightarrow M_{\Gamma_g}(SL_2(\mathbb{C}))$$

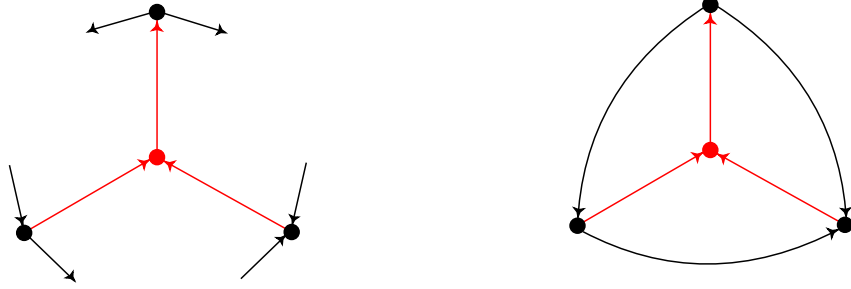

FIGURE 7. A graph Γ on the right, with spanning tree \mathcal{T} in red, and the tree $T(\mathcal{T}, \Gamma)$ on the left.

The following allows us to relate our constructions on the graph Γ to those on the tree $T(\mathcal{T}, \Gamma)$, it is a consequence of the argument used in Lemma 5.5 above.

Proposition 6.3. *The maps $\Phi_{T(\mathcal{T}, \Gamma)}$ and $\Psi_{T(\mathcal{T}, \Gamma)}$ are isomorphisms. Furthermore, the following diagram commutes.*

$$(36) \quad \begin{array}{ccc} M_{0, T(\mathcal{T}, \Gamma)}(SL_2(\mathbb{C})) & \xrightarrow{\pi_{\mathcal{T}, \Gamma}} & M_{\Gamma}(SL_2(\mathbb{C})) \\ \Psi_{\mathcal{T}} \downarrow \uparrow \Phi_{\mathcal{T}} & & \Psi \downarrow \uparrow \Phi \\ M_{0, 2g}(SL_2(\mathbb{C})) & \xrightarrow{\pi_0} & M_{\Gamma_g}(SL_2(\mathbb{C})) \end{array}$$

We finish this subsection by giving a presentation of the coordinate ring $\mathbb{C}[M_{0, n}(SL_2(\mathbb{C}))]$, see also [M1], Section 8. The space $SL_2(\mathbb{C})^n$ is an affine subspace of the space of $2 \times 2n$ matrices, cut out by n determinant equations.

$$(37) \quad SL_2(\mathbb{C})^n = \{[C_{1,1}, C_{1,2}, \dots, C_{n,1}, C_{n,2}] \in M_{2, 2n}(\mathbb{C}) \mid \det(C_{i,1}, C_{i,2}) = 1\}$$

We can therefore realize $M_{0, n}(SL_2(\mathbb{C}))$ as a subspace of the GIT quotient $SL_2(\mathbb{C}) \backslash M_{2, 2n}(SL_2(\mathbb{C}))$. Following Weyl's First Fundamental Theorem of Invariant Theory, the latter is cut out of $\mathbb{C}^{\binom{2n}{2}}$ by Plücker equations. The invariant ring $\mathbb{C}[M_{2, 2n}(SL_2(\mathbb{C}))]^{SL_2(\mathbb{C})}$ is generated by the forms $p_{(i,a), (j,b)} = \det(C_{i,a}, C_{j,b})$, and $M_{0, n}(SL_2(\mathbb{C}))$ is realized of this space as the intersection of the hypersurfaces determined by the equations $p_{(i,1), (j,2)} = 1$.

Proposition 6.4. *Order the indices (i, a) lexicographically. The coordinate ring of $M_{0, n}(SL_2(\mathbb{C}))$ is generated by the $\binom{2n}{2}$ generators $p_{(i,a)}$, subject to the following equations, where $(i, a) < (j, b) < (k, c) < (l, d)$.*

$$(38) \quad p_{(i,a), (j,b)} p_{(k,c), (l,d)} + p_{(i,a), (l,d)} p_{(j,b), (k,c)} = p_{(i,a), (k,c)} p_{(j,b), (l,d)}, \quad p_{(i,1), (i,2)} = 1$$

The algebra $\mathbb{C}[M_{0, n}(SL_2(\mathbb{C}))]$ controls the structure of $M_{\Gamma}(SL_2(\mathbb{C}))$ "at a vertex of valence n ," each index i is associated to an edge, and the ordering of the indices $i \in (i, a)$ above is tantamount to a choice of a ribbon structure at such a vertex. We will also make use of the "opposite" Plücker generators $-p_{(i,a), (j,b)} = p_{(j,b), (i,a)}$ when direction is important. Of course, $M_{0, n}(SL_2(\mathbb{C})) = SL_2(\mathbb{C})^{n-1}$, so this is perhaps an overly complicated presentation, however the combinatorics of the Plücker generators and equations play an important role in describing the set $S(\Gamma) \subset \mathbb{C}[M_{\Gamma}(SL_2(\mathbb{C}))]$. Throughout we will

use "direction" to mean the ordering of indices, as in $p_{(i,a),(j,b)}$ goes from i to j , and "orientation" to mean the data a, b .

6.3. The space $M_{0,3}(SL_2(\mathbb{C}))$. Let v_1, v_2, v_3 be three copies of $v : \mathbb{C}[SL_2(\mathbb{C})] \rightarrow \mathbb{Z} \cup \{-\infty\}$ defined on $\mathbb{C}[M_{0,3}(SL_2(\mathbb{C}))] \subset \mathbb{C}[SL_2(\mathbb{C})^3]$. We apply Lemmas 3.2, 3.1 to $\mathbb{C}[M_{0,3}(SL_2(\mathbb{C}))]$ and find that the associated graded algebra of an interior element of $C_3 = \mathbb{Z}_{\geq 0}\{v_1, v_2, v_3\}$ is $\mathbb{C}[SL_2(\mathbb{C})^c \times SL_2(\mathbb{C})^c \times SL_2(\mathbb{C})^c]^{SL_2(\mathbb{C})} = \mathbb{C}[M_{0,3}(SL_2(\mathbb{C})^c)]$. Next we show that this is an affine semigroup algebra.

Definition 6.5. *The cone \mathcal{P}_3 is defined to be the set of labellings of the following diagram by non-negative real numbers which satisfy $x_1 + y_1 = a, x_2 + y_2 = b, x_3 + y_3 = c$, such that a, b, c form the sides of a triangle, $|a - c| \leq b \leq a + c$. The lattice L_3 is the set of integer labellings of this diagram with $a + b + c \in 2\mathbb{Z}$. We let P_3 be the affine semigroup $\mathcal{P}_3 \cap L_3$.*

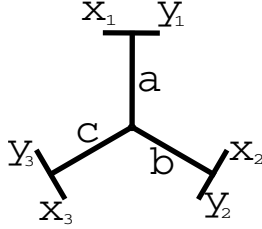

FIGURE 8. Defining diagram of P_3 .

Proposition 6.6. *The algebra $\mathbb{C}[M_{0,3}(SL_2(\mathbb{C})^c)]$ is isomorphic to $\mathbb{C}[P_3]$.*

Proof. Following Section 4, $M_{0,3}(SL_2(\mathbb{C})^c)$ can be rewritten as the GIT quotient

$$(39) \quad SL_2(\mathbb{C}) \backslash [(SL_2(\mathbb{C})/U_+)^3] \times [(U_- \backslash SL_2(\mathbb{C}))^3] / (\mathbb{C}^*)^3.$$

We compute this as a reduction in steps. The quotient $SL_2(\mathbb{C}) \backslash [(SL_2(\mathbb{C})/U_+)^3] = SL_2(\mathbb{C}) \backslash [(\mathbb{C}^2)^3]$ is isomorphic to the affine space $\bigwedge^2(\mathbb{C}^3)$ by the First Fundamental Theorem of Invariant Theory. It can be viewed as the variety associated to the affine semigroup algebra $\mathbb{C}[Q_3]$, where Q_3 is the affine semigroup of triples a, b, c as in the definition of P_3 above. Here a, b, c are the highest weights of the components $(V(a) \otimes V(b) \otimes V(c))^{SL_2(\mathbb{C})} \subset SL_2(\mathbb{C}) \backslash [(\mathbb{C}^2)^3]$. Recall that the character spaces of the diagonal action of \mathbb{C}^* on $SL_2(\mathbb{C})/U = \mathbb{C}^2$ are precisely the $V(a) \subset \mathbb{C}[\mathbb{C}^2]$. It follows that $\mathbb{C}[M_{0,3}(SL_2(\mathbb{C}))]$ is graded by the subspaces $((V(a) \otimes V(b) \otimes V(c))^{SL_2(\mathbb{C})} \otimes V(a) \otimes V(b) \otimes V(c))$. Since $\mathbb{C}[U_- \backslash SL_2(\mathbb{C})] = \mathbb{C}[\mathbb{C}^2]$ is itself toric, we can further grade this algebra by viewing each $V(a)$ as a direct sum of the monomial spaces $\mathbb{C}X^{x_1}Y^{y_1}$, where $x_1 + y_1 = a$. A similar decomposition holds for $V(b), V(c)$. \square

The affine semigroup P_3 is generated by the $3 \times 4 = 12$ weightings with one of a, b, c equal to 0 and the other two entries equal to 1. We label these generators $X_{(i,a),(j,b)}$, indicating a path from i to j with orientation markings on the a, b ends of these paths, respectively. Now we recall the forms $p_{(i,a),(j,b)} \in \mathbb{C}[M_{0,3}(SL_2(\mathbb{C}))]$. If we view $M_{0,3}(SL_2(\mathbb{C}))$ as the space of 2×6 matrices $[C_{1,1}C_{1,2}C_{2,1}, C_{2,2}, C_{3,1}C_{3,2}]$ which satisfy $\det(C_{i,1}C_{i,2}) = 1$, $p_{(i,a),(j,b)}$ is the function $\det(C_{i,a}C_{j,b})$.

Proposition 6.7. *The initial terms $\text{in}(p_{(i,a),(j,b)})$ give a generating set of P_3 .*

Proof. This follows because $p_{(i,a),(j,b)}$ and $X_{(i,a),(j,b)}$ represent the same vector in one of the $((V(1) \otimes V(1) \otimes V(0))^{SL_2(\mathbb{C})} \otimes V(1) \otimes V(1) \otimes V(0))$ spaces. To see this, recall that the algebra $\mathbb{C}[SL_2(\mathbb{C})^c]$ is isomorphic to $\mathbb{C}[V(1) \times V(1)/\mathbb{C}^*]$ by the map $A \rightarrow X \otimes X, B \rightarrow X \otimes Y, C \rightarrow Y \otimes X, D \rightarrow Y \otimes Y$. One uses this to show that $X_{(i,a),(j,b)}$ are the expected initial forms in the associated graded algebra $\mathbb{C}[(SL_2(\mathbb{C})^c)^3]$ of $\mathbb{C}[SL_2(\mathbb{C})^3]$. \square

Note that if generators $p_{(i_1,a_1),(j_1,b_1)}, \dots, p_{(i_n,a_n),(j_n,b_n)}$ are multiplied, the x_i, y_i components of the initial term $\text{in}(\prod p_{(i_s,a_s),(j_s,b_s)})$ records the number of each type of orientation which appears.

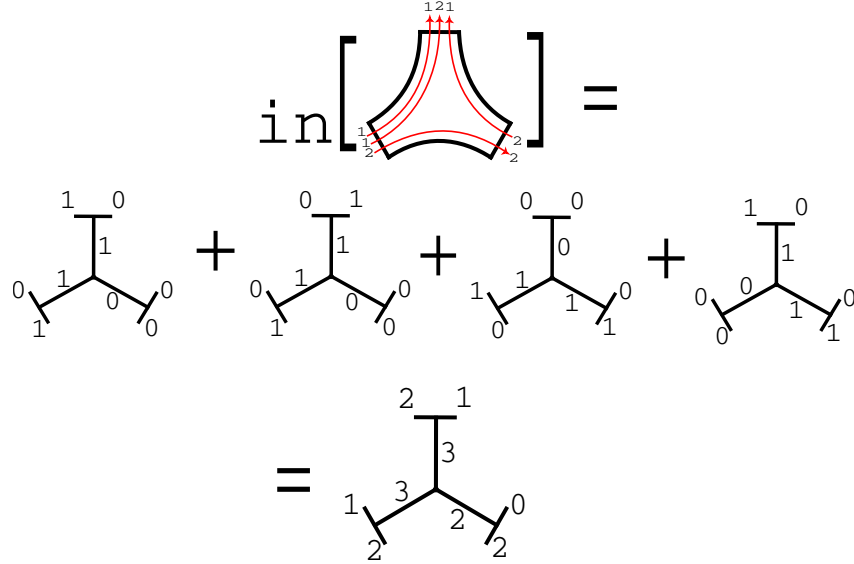

FIGURE 9. Multiplying initial terms in P_3 .

6.4. Γ -tensors. For a graph Γ , we introduce a combinatorial object called an abstract Γ -tensor $V(S, \phi)$, this is the following information (see also Section 8 of [M1]).

- (1) A set of simple, directed paths S_v in each link $\Gamma_v \subset \Gamma$.
- (2) For each edge $e \in E(\Gamma)$ with $\delta(e) = (v, u)$, a direction preserving bijection $\phi_e : S_{v,e} \rightarrow S_{u,e}$ between the paths through e in S_v and S_u .

A marking A of an abstract Γ -tensor is an assignment $A : S_{v,e} \rightarrow \{1, 2\}$ to the end points of each path such that the meeting endpoints of two paths connected by ϕ_e are different. When a path p_{ij} is coupled with marking data $A(i) = a, A(j) = b$, it can be viewed as a Plücker generator $p_{(i,a),(j,b)} \in \mathbb{C}[M_{0,\epsilon(v)}(SL_2(\mathbb{C}))]$. In this way an abstract Γ tensor $V(\S, \phi)$ with marking A defines a monomial $\mathcal{V}(S, \phi, A) \in \mathbb{C}[M_{0,\epsilon(v)}(SL_2(\mathbb{C}))^{V(\Gamma)}]$.

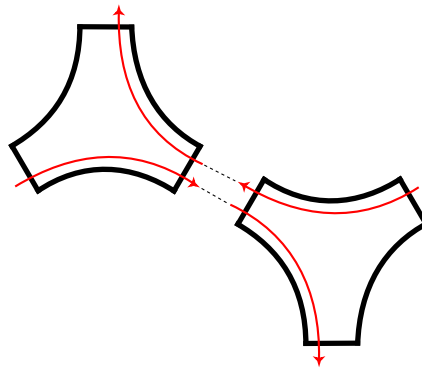

FIGURE 10. An abstract Γ -tensor

By [M1], Proposition 8.5 (see also Proposition 6.12 below), we obtain an invariant form $\mathcal{V}(S, \phi)$ in the subalgebra $\mathbb{C}[M_\Gamma(SL_2(\mathbb{C}))] \subset \mathbb{C}[\prod_{v \in V(\Gamma)} M_{0,\epsilon(v)}(SL_2(\mathbb{C}))^{V(\Gamma)}]$ by taking a signed sum over all $2^{E(\Gamma)}$ possible markings.

$$(40) \quad \mathcal{V}(S, \phi) = \sum_A (-1)^{\rho(A)} V(S, \phi, A)$$

Here $(-1)^{\rho(A)}$ is a product of signs defined by ϕ_e and the marking A at an edge. For each identification of endpoints $\phi(e) = f$, there is a contribution $(-1)^{\rho(\phi, e, f)}$, which is positive if $a(e) = 1, a(f) = 2$ and e is outgoing, and negative if $a(e) = 1, a(f) = 2$ and e is incoming. This assignment is illustrated on an example in Figure 11.

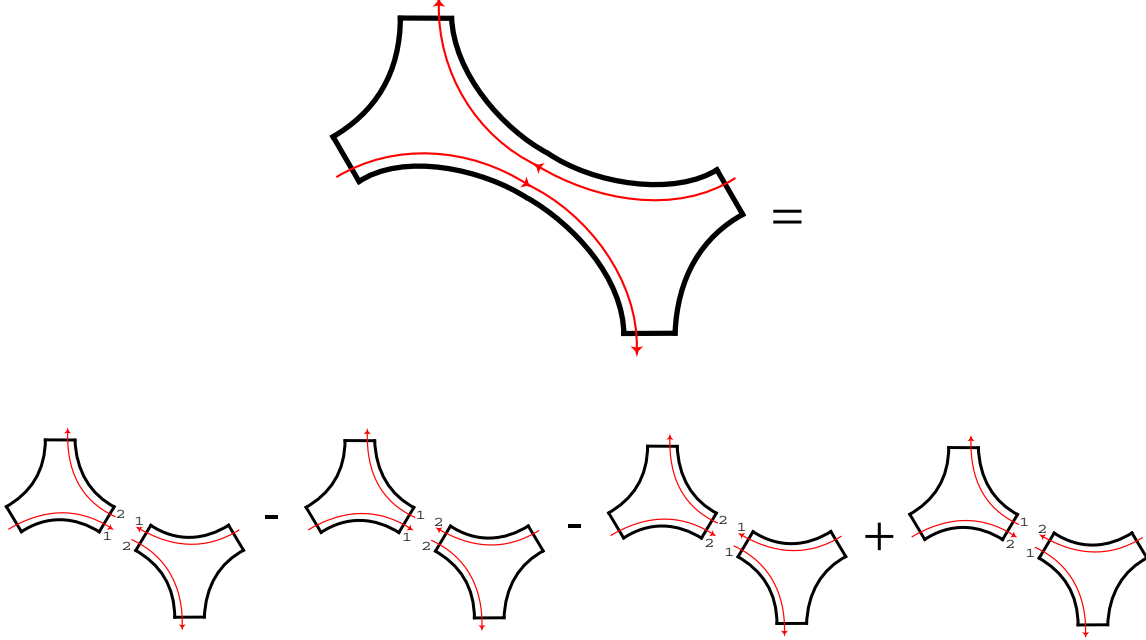

FIGURE 11. A Γ tensor obtained as a signed sum over orientation assignments to an abstract Γ -tensor

We let $S(\Gamma) \subset \mathbb{C}[M_\Gamma(SL_2(\mathbb{C}))]$ be the set of all $\mathcal{V}(S, \phi)$. Each abstract Γ -tensor corresponds naturally to a weighting $w(S, \phi) : E(\Gamma) \rightarrow \mathbb{Z}_{\geq 0}$, where $w(S, \phi)(e)$ is the number of paths crossing e . The next proposition relates $\mathcal{V}(S, \phi)$ to the spin element of $\mathbb{C}[M_\Gamma(SL_2(\mathbb{C}))]$ corresponding to this weighting when Γ is trivalent.

Proposition 6.8. *Let Γ be trivalent, then the initial form $in(\mathcal{V}(S, \phi))$ of a Γ -tensor is a non-zero multiple of $\Phi_{w(S, \phi)}$.*

Proof. We observe that the initial term $in(\mathcal{V}(S, \phi)) \in \mathbb{C}[M_\Gamma(SL_2(\mathbb{C}))]$ can be computed in the algebra $\mathbb{C}[M_{0,3}(SL_2(\mathbb{C}))^{V(\Gamma)}]$, as the $SL_2(\mathbb{C})^{E(\Gamma)}$ invariance of the filtrations involved guarantees that the initial term of an invariant in $\mathbb{C}[M_{0,3}(SL_2(\mathbb{C}))^{V(\Gamma)}]$ is also invariant. The initial term of $in(\mathcal{V}(S, \phi, A))$ is a tensor product (over $v \in V(\Gamma)$) of initial terms of the monomials defined by S in $\mathbb{C}[M_{0,3}(SL_2(\mathbb{C}))]$. Each of the $in(\mathcal{V}(S, \phi, A))$ lies in the $w(S, \phi)$ isotypical component of $\mathbb{C}[M_{0,3}(SL_2(\mathbb{C}))^{V(\Gamma)}]$, so it follows that $in(\mathcal{V}(S, \phi))$ equals the sum of these terms. Initial terms with different quantities of the two possible orientations $\{1, 2\}$ at an edge are linearly independent, as this is the case for the associated elements of $\mathbb{C}[P_3^{V(\Gamma)}]$. Since $\mathcal{V}(S, \phi)$ always has exactly one term with all outgoing assignments 1, this sum cannot vanish. \square

Corollary 6.9. *A valuation $v_\ell \in C_\Gamma$, is computed on a Γ -tensor $\mathcal{V}(S, \phi) \in \mathbb{C}[\mathcal{X}(F_g, SL_2(\mathbb{C}))]$ as follows.*

$$(41) \quad v_\ell(\mathcal{V}(S, \phi)) = \sum_{e \in E(\Gamma)} \ell(e) w(S, \phi)(e)$$

We have stated this corollary for trivalent Γ , but the general case can be recovered by considering a weighting on Γ as a weighting with 0 entries on a trivalent cover $\tilde{\Gamma} \rightarrow \Gamma$.

6.5. Γ -tensors and F_g . For a marking $\phi : \Gamma_g \rightarrow \Gamma$, we let $S(\Gamma, \phi) \subset \mathbb{C}[\mathcal{X}(F_g, SL_2(\mathbb{C}))]$ be the set $\phi^{-1}(S(\Gamma)) \subset \mathbb{C}[\mathcal{X}(F_g, SL_2(\mathbb{C}))]$. We show that the sets $S(\Gamma, \phi) \subset \mathbb{C}[\mathcal{X}(F_g, SL_2(\mathbb{C}))]$ all coincide, and how to compute them as regular functions. From each connected abstract Γ tensor $V(S, \phi)$ we obtain a reduced words $\omega(S, \phi) \in F_g$, this defines a bijection between abstract Γ -tensors and cyclic equivalence classes of elements of F_g . The Γ -tensor $\mathcal{V}(S, \phi)$ is then shown to coincide with the traceword function $\tau_{\omega(S, \phi)}$. We conclude by showing that for a valuation $v_{\Gamma, \ell, \phi} \in C_{\Gamma, \phi}$, $v_{\Gamma, \ell, \phi}(\tau_{\omega(S, P)})$ is $d_{\omega(S, P)}(\Gamma, \ell, \phi)$.

In order to identify the $\mathcal{V}(S, \phi)$ as regular functions, we consider similar forms defined on trees. A \mathcal{T} -tensor $\mathcal{V}(S, \phi, B) \in \mathbb{C}[M_{0, \mathcal{T}}(SL_2(\mathbb{C}))]$ is defined in the same way as a Γ -tensor, with the addition of orientation information B specified at the leaves. By construction, any $\mathcal{V}(S, \phi, B)$ factors as a monomial in simple paths $\mathcal{V}(S_\gamma, \phi_\gamma, B_\gamma)$, the next proposition shows that each of these path tensors can be considered to be a Plücker generator from Subsection 6.4.

Proposition 6.10. *The set of \mathcal{T} -tensors $S(\mathcal{T}) \subset \mathbb{C}[M_{0, \mathcal{T}}(SL_2(\mathbb{C}))]$ coincides with the set of Plücker monomials in $\mathbb{C}[M_{0, \mathcal{L}(\mathcal{T})}(SL_2(\mathbb{C}))]$ under the isomorphisms $\Phi_{\mathcal{T}}$ and $\Psi_{\mathcal{T}}$.*

Proof. This is a straightforward calculation, also covered in Proposition 8.4 of [M1]. □

We use this proposition to prove that $S(\Gamma, \phi)$ coincides with $S(\Gamma_g) \subset \mathbb{C}[\mathcal{X}(F_g, SL_2(\mathbb{C}))]$ for $\phi : \Gamma_g \rightarrow \Gamma$ and $\psi : \Gamma \rightarrow \Gamma_g$ a distinguished pair of maps corresponding to a spanning tree $\mathcal{T} \subset \Gamma$.

Proposition 6.11. *The set of Γ -tensors $S(\Gamma) \subset \mathbb{C}[M_{\Gamma}(SL_2(\mathbb{C}))]$ coincides with the set of Γ_g -tensors in $\mathbb{C}[M_{\Gamma_g}(SL_2(\mathbb{C}))]$ under the isomorphisms $\Phi_{\mathcal{T}}$ and $\Psi_{\mathcal{T}}$.*

Proof. This follows from the observation (see [M1], Proposition 8.5) that any Γ (respectively Γ_g -tensor) can be decomposed into a sum of $T(\mathcal{T}, \Gamma)$ -tensors, using the map $\pi_{\mathcal{T}}$.

$$(42) \quad \mathcal{V}_{\Gamma}(S, \phi) = \sum_B \mathcal{V}_{T(\mathcal{T}, \Gamma)}(S_{T(\mathcal{T}, \Gamma)}, \phi_{T(\mathcal{T}, \Gamma)}, B)(-1)^{\rho(B)}$$

Each of the components $\mathcal{V}_{T(\mathcal{T}, \Gamma)}(S_{T(\mathcal{T}, \Gamma)}, \phi_{T(\mathcal{T}, \Gamma)}, B)$ is a monomial in Plücker generators by Proposition 6.10. This sum therefore amounts to an element of $S(\Gamma_g)$. This argument can then be run in reverse to give the proposition. □

Next we analyze the set $S(\Gamma_g) \subset \mathbb{C}[M_{\Gamma_g}(SL_2(\mathbb{C}))]$ under outer automorphisms. This entails showing that this set coincides with another set of distinguished regular functions on $M_{\Gamma_g}(SL_2(\mathbb{C})) = \mathcal{X}(F_g, SL_2(\mathbb{C}))$. The trace word τ_{ω} associated to a word $\omega \in F_g$ is the regular function that takes $(A_1, \dots, A_g) \in \mathcal{X}(F_g, SL_2(\mathbb{C}))$ to the complex number $tr(\omega(A_1, \dots, A_g))$. Let $\mathcal{W}_g \subset \mathbb{C}[\mathcal{X}(F_g, SL_2(\mathbb{C}))]$ be the set of these functions, we will prove the following proposition with a series of lemmas. First we show that these sets are bijective combinatorially.

Proposition 6.12. *The set $S(\Gamma_g)$ coincides with the set of monomials in the elements of \mathcal{W}_g .*

Notice that \mathcal{W}_g is naturally closed under the action of $Out(F_g)$ on $\mathbb{C}[\mathcal{X}(F_g, SL_2(\mathbb{C}))]$, so Proposition 6.12 implies that $S(\Gamma, \phi) = S(\Gamma_g) \subset \mathbb{C}[\mathcal{X}(F_g, SL_2(\mathbb{C}))]$ for ϕ any composition of an outer automorphism with a distinguished graph map. Proposition 5.6 then implies that this is the case for any marking $\phi : \Gamma_g \rightarrow \Gamma$.

Fix a connected abstract Γ_g -tensor $V(S, \phi)$. We let $T(\Gamma_g, v)$ be the $2g$ tree obtained from the "spanning tree" $\{v\} \subset \Gamma_g$. We label the leaves of $T(\Gamma_g, v)$ with the $2g$ indices $2i - 1, 2i$ $1 \leq i \leq g$, where the $2i - 1$ and $2i$ leaves are identified in the quotient map $T(\Gamma_g, v) \rightarrow \Gamma_g$. We let $p_{(i_1, j_1)} \in S$ be a path in $V(S, \phi)$. The endpoint j_1 is connected with the starting point of the next path $p_{(i_2, j_2)}$, so $j_1 = 2a_1 - 1, i_2 = 2a_1$ or $j_1 = 2a_1, i_2 = 2a_1 - 1$. Continuing this way, we obtain a word $\omega(V(S, \phi), p_{(i_1, j_1)}) = x_{a_1}^{\epsilon_1} x_{a_2}^{\epsilon_2} \dots x_{a_m}^{\epsilon_m}$, where the sign ϵ_i is determined by the rule $j_1 = 2a_1 - 1, i_2 = 2a_1 = 2 \implies \epsilon_i = 1$, $j_1 = 2a_1, i_2 = 2a_1 - 1 \implies \epsilon_i = -1$. By construction, this word is reduced, as Γ_g tensors do not have back-tracks by definition. Given a word ω , we may reverse this recipe to obtain a Γ_g -tensor $V(S_{\omega}, \phi_{\omega})$. All paths in $T(\Gamma_g, v)$ are determined by their endpoints, so we have a $1 - 1$ map from the set of connected Γ_g -tensors $V(S, \phi)$ with a choice of initial path $p_{(i_1, j_1)} \in S$ to the set of reduced words in F_g . Changing the initial path amounts to changing the word $\omega(V(S, \phi), p_{(i_1, j_1)})$ by a cyclic permutation, so we have proved the following lemma.

Lemma 6.13. *The set $S_{con}(\Gamma_g)$ is in bijection with cyclic equivalence classes of reduced words in F_g .*

By Proposition 6.11, the same is true for the connected Γ tensors $S_{con}(\Gamma)$ of any graph Γ . The recipe to compute $\omega(V(S, \phi), p_1) \in F_g$ is almost identical, except one replaces a simple path $p_{(i_s, j_s)}$ with the shortest path p_s in the chosen spanning tree $\mathcal{T} \subset \Gamma$.

Now we show that any connected Γ_g -tensor can be "untangled," in the sense that it is realized as the pullback of a fixed Γ'_g tensor under pull back by a map $\phi_* : M_{\Gamma'_g}(SL_2(\mathbb{C})) \rightarrow M_{\Gamma_g}(SL_2(\mathbb{C}))$, where Γ'_g has a different genus.

Definition 6.14. We let $\mathcal{V}_g \in \mathbb{C}[M_{\Gamma_g}(SL_2(\mathbb{C}))] = \mathbb{C}[SL_2(\mathbb{C}) \backslash SL_2(\mathbb{C})^{2g} / SL_2(\mathbb{C})^g]$ be the Γ_g tensor defined by joining the paths $p_{(2g,1)} \rightarrow p_{(2,3)} \rightarrow \dots \rightarrow p_{(2g-2,2g-1)}$, as in Figure 12.

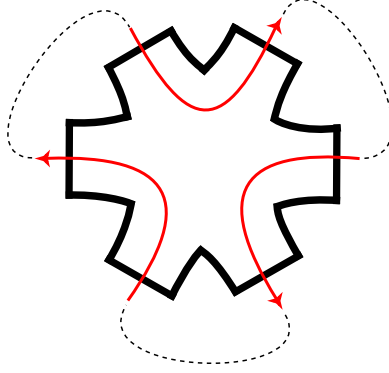

FIGURE 12. The tensor \mathcal{V}_3

We fix a reduced word $\omega \in F_g$, and we let $n = |\omega|$. There is a natural map of $\phi_\omega : \mathcal{X}(F_g, SL_2(\mathbb{C})) \rightarrow \mathcal{X}(F_n, SL_2(\mathbb{C}))$ defined by sending (A_1, \dots, A_g) to the entries of ω in order, $(\omega_1(\vec{A}), \dots, \omega_n(\vec{A}))$. Recall that $\mathcal{X}(F_g, SL_2(\mathbb{C}))$ is the quotient $SL_2(\mathbb{C}) \backslash SL_2(\mathbb{C})^{2g} / SL_2(\mathbb{C})^g = M_{0,2g}(SL_2(\mathbb{C})) / SL_2(\mathbb{C})^g$, by way of the map $\pi_{0,g}(k_1, h_1, \dots, k_g, h_g) = (k_1 h_1^{-1}, \dots, k_g h_g^{-1})$. We define a map ϕ'_ω by sending $(k_1, h_1, \dots, k_g, h_g)$ to $(\omega_1(\vec{k}), \omega_1(\vec{h}), \dots, \omega_n(\vec{k}), \omega_n(\vec{h}))$, this commutes with ϕ_ω under the isomorphisms $\pi_{0,g}, \pi_{0,n}$. We will see where \mathcal{V}_g goes under ϕ_ω^* .

Lemma 6.15.

$$(43) \quad \phi_\omega^*(\mathcal{V}_n) = \mathcal{V}(S_\omega, \phi_\omega)$$

Proof. When the Plücker element $p_{(2i,a),(2i+1,b)}$ is evaluated on $\phi'_\omega(k_1, h_1, \dots, k_g, h_g)$ it gives the determinant of the a column of $\omega_i(\vec{h})$ and the b column of $\omega_{i+1}(\vec{k})$. The pullback $\phi_\omega^*(\mathcal{V}_n)$ therefore coincides with $\mathcal{V}(S_\omega, \phi_\omega)$ by definition. \square

We now introduce the model traceword $\tau_g = tr(A_1 A_2 \dots A_g)$. By the previous lemma, if we can show that $\tau_n = \mathcal{V}_n \in \mathbb{C}[\mathcal{X}(F_n, SL_2(\mathbb{C}))]$, we would have $\mathcal{V}(S_\omega, \phi_\omega) = \tau_\omega = tr(\omega(\vec{A}))$, and Proposition 6.12 would follow.

Lemma 6.16.

$$(44) \quad \tau_n = \mathcal{V}_n \in \mathbb{C}[\mathcal{X}(F_n, SL_2(\mathbb{C}))]$$

Proof. We employ the following commutative diagram.

$$\begin{array}{ccc} ([SL_2(\mathbb{C}) \times SL_2(\mathbb{C})] / SL_2(\mathbb{C})) \times ([SL_2(\mathbb{C}) \times SL_2(\mathbb{C})] / SL_2(\mathbb{C}))^{g-1} & \longrightarrow & SL_2(\mathbb{C}) \times SL_2(\mathbb{C})^{g-1} \\ \downarrow & & \downarrow \\ ([SL_2(\mathbb{C}) \times SL_2(\mathbb{C})] / SL_2(\mathbb{C}))^{g-1} & \longrightarrow & SL_2(\mathbb{C})^{g-1} \\ (k_1, h_1), (k_2, h_2), \dots, (k_g, h_g) & \longrightarrow & (k_1 h_1^{-1}, \dots, k_g h_g^{-1}) \\ \downarrow & & \downarrow \\ (k_1 h_1^{-1}, h_2 k_2^{-1}), \dots, (k_g, h_g) & \longrightarrow & (k_1 h_1^{-1} k_2 h_2^{-1}, \dots, k_g h_g^{-1}) \end{array}$$

The horizontal arrows in this diagram give the isomorphism between $M_{0,2g}(SL_2(\mathbb{C}))/SL_2(\mathbb{C})^g$ and $\mathcal{X}(F_g, SL_2(\mathbb{C}))$. The vertical arrow on the right is the matrix composition operation $(A_1, \dots, A_g) \rightarrow (A_1 A_2, \dots, A_g) \in SL_2(\mathbb{C})^{g-1}$. The vertical arrow on the left lifts this to $([SL_2(\mathbb{C}) \times SL_2(\mathbb{C})]/SL_2(\mathbb{C}))^g$, where we can talk about Γ -tensors.

Notice that τ_{g-1} pulls back to τ_g under the right vertical arrow. It follows that if we can show that $\tau_1 = \mathcal{V}_1 \in \mathbb{C}[SL_2(\mathbb{C})]^{SL_2(\mathbb{C})}$, and that \mathcal{V}_{g-1} pulls back to \mathcal{V}_g under the left vertical arrow, we have the lemma. The first assertion holds by a straightforward calculation. For the second assertion, it suffices to show that the piece of \mathcal{V}_g connecting the $(k_1, h_1), (k_2, h_2)$ is the piece of \mathcal{V}_{g-1} connecting the first pair of indices, evaluated at $(k_1 h_1^{-1}, h_2 k_2^{-1})$.

Fix 2×2 matrices $A, B, C, D \in SL_2(\mathbb{C})$ and two column vectors X, U . Let the columns of a matrix K be K_1, K_2 , and let $K_1 \wedge K_2$ denote the determinant of K . Furthermore, let $M = AB^{-1}, N = DC^{-1}$. The lemma follows if

$$(45) \quad (X \wedge A_1)(B_2 \wedge C_1)(D_2 \wedge U) - (X \wedge A_2)(B_1 \wedge C_1)(D_2 \wedge U) - (X \wedge A_1)(B_2 \wedge C_2)(D_1 \wedge U) + (X \wedge A_2)(B_1 \wedge C_2)(D_1 \wedge U)$$

is equal to

$$(46) \quad (X \wedge M_1)(N_2 \wedge U) - (X \wedge N_2)(N_1 \wedge U)$$

This can be done by a direct computation. □

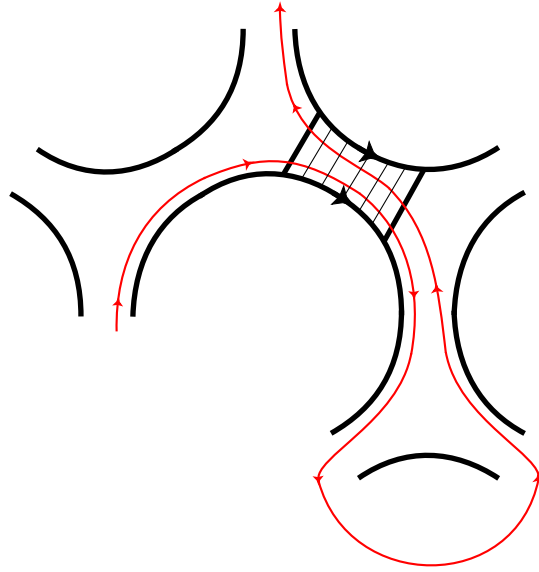

FIGURE 13. A path representing $tr(\dots A \dots A^{-1} \dots)$

Now we have, for each reduced word $\omega \in F_g$, a corresponding form $\mathcal{V}(S_\omega, \phi_\omega) \in \mathbb{C}[\mathcal{X}(F_g, SL_2(\mathbb{C}))]$. Furthermore, for each metric graph (Γ, ℓ) , with a marking $\phi : \Gamma_g \rightarrow \Gamma$, there is a corresponding valuation $v_{\ell, \Gamma, \phi} : \mathbb{C}[\mathcal{X}(F_g, SL_2(\mathbb{C}))] \rightarrow \mathbb{Z} \cup \{-\infty\}$, and the following holds.

$$(47) \quad v_{\Gamma, \ell, \phi}(\tau_\omega) = v_{\Gamma, \ell, \phi}(\mathcal{V}(S_\omega, \phi_\omega)) = d_{\Gamma, \ell, \phi}(\omega)$$

We close this section by showing that $\Sigma : O(g) \rightarrow \mathcal{X}(F_g, SL_2(\mathbb{C}))^{an}$, $\Sigma(\Gamma, \ell, \phi) = v_{\Gamma, \ell, \phi}$ gives an embedding. This map must be 1-1, since the length functions $d_{\Gamma, \ell, \phi}$ distinguish points in $O(g)$. The topology on $\mathcal{X}(F_g, SL_2(\mathbb{C}))^{an}$ is the coarsest topology which makes the evaluation functions $[f](v) = v(f), f \in \mathbb{C}[\mathcal{X}(F_g, SL_2(\mathbb{C}))]$ continuous. This is similar to the topology on $O(g)$, which is the coarsest topology which makes the length functions continuous [CV]. Each length function on $O(g)$ extends to a continuous function on $\mathcal{X}(F_g, SL_2(\mathbb{C}))^{an}$, so it follows that any open set in $O(g)$ is induced from $\mathcal{X}(F_g, SL_2(\mathbb{C}))^{an}$. It remains to check that any evaluation function is continuous on $O(g)$, as this would imply that no new open sets are induced from $f \in \mathbb{C}[\mathcal{X}(F_g, SL_2(\mathbb{C}))], f \neq \tau_\omega$.

For $f = \sum C_\omega \tau_\omega$ and any $(\Gamma, \ell, \phi) \in O(g)$ we must have $v_{\Gamma, \ell, \phi}(f) \leq \max_{C_\omega \neq 0} \{\dots v_{\Gamma, \ell, \phi}(\tau_\omega) \dots\}$. We claim that if we quantify over all such expressions, then we obtain $v_{\Gamma, \ell, \phi}(f)$. To prove the claim, note that f can be expanded in a unique way into (Γ, ϕ) spin diagrams, and the value $v_{\Gamma, \ell, \phi}(f)$ is obtained on one of these diagrams. Now we use the lower-triangular expansion of any spin diagram into trace functions. In fact, this shows that only a finite number of τ_ω are needed over the simplicial cone $C_{\Gamma, \phi}$ defined by a marking ϕ . As the function defined by f is therefore continuous when restricted to any $C_{\Gamma, \phi}$, the result follows from the Pasting Lemma. This proves Theorem 1.1.

7. THE Γ HAMILTONIAN SYSTEM IN $\mathcal{X}(F_g, SL_2(\mathbb{C}))$

In this section we construct each space $M_\Gamma(SL_2(\mathbb{C}))$, $M_\Gamma(SL_2(\mathbb{C})^c)$ as a symplectic reduction. We show that each distinguished map $\phi : \Gamma_g \rightarrow \Gamma$ associated to a spanning tree \mathcal{T} gives a symplectomorphism $\phi^* : \mathcal{X}(F_g, SL_2(\mathbb{C})) \rightarrow M_\Gamma(SL_2(\mathbb{C}))$. Then we construct a surjective, continuous contraction map $\Phi_\Gamma : M_\Gamma(SL_2(\mathbb{C})) \rightarrow M_\Gamma(SL_2(\mathbb{C})^c)$, and we show that this map is a symplectomorphism on a dense, open subspace $M_\Gamma(SL_2(\mathbb{C}))^0 \subset M_\Gamma(SL_2(\mathbb{C}))$. The compact part \mathbb{T}_Γ of the defining torus T_Γ of the toric variety $M_\Gamma(SL_2(\mathbb{C})^c)$ is used to define an integrable system on $M_\Gamma(SL_2(\mathbb{C}))^0$ with moment map $\mu_{\mathbb{T}_\Gamma} \circ \Xi_\Gamma$. We show that the fibers of the contraction map Ξ_Γ are all isomorphic to products of copies of $SU(2) \cong \mathbb{S}^3$, with the exception of the fiber over the origin, which is the compact character variety $\mathcal{X}(F_g, SU(2))$.

7.1. $M_\Gamma(SL_2(\mathbb{C}))$ and $M_\Gamma(SL_2(\mathbb{C})^c)$ as symplectic reductions. Both spaces $SL_2(\mathbb{C})^{E(\Gamma)}$, and the contraction $[SL_2(\mathbb{C})^c]^{E(\Gamma)}$ have Hamiltonian $SU(2)^{V(\Gamma)}$ actions, inherited from the Hamiltonian $SU(2) \times SU(2)$ actions on $SL_2(\mathbb{C})$ and $SL_2(\mathbb{C})^c$, respectively. Following our treatment of $SL_2(\mathbb{C})$ and $SL_2(\mathbb{C})^c$ in Section 4, both of these spaces can be equivariantly embedded into $SU(2)^{V(\Gamma)}$ representations, and the symplectic forms on these representations agree with the product standard forms. The work of Kirwan [Kir] and Kempf-Ness [KN] then shows that the reductions $SL_2(\mathbb{C})^{E(\Gamma)} /_0 SU(2)^{V(\Gamma)}$, $[SL_2(\mathbb{C})^c]^{E(\Gamma)} /_0 SU(2)^{V(\Gamma)}$ carry stratified Kähler structures, and can be identified with $M_\Gamma(SL_2(\mathbb{C}))$ and $M_\Gamma(SL_2(\mathbb{C})^c)$ respectively as complex spaces. See also [FL2], Section 4 for a discussion of this point in this case $\Gamma = \Gamma_g$. Next we show that the symplectic structure on $M_\Gamma(SL_2(\mathbb{C}))$ obtained by this reduction procedure does not depend on Γ .

Let \mathcal{T} be a directed tree with one internal edge $e \in E(\mathcal{T})$ and endpoints $\delta(e) = (u, v)$, and let \mathcal{T}' be the tree obtained from \mathcal{T} by collapsing e to a single vertex w . We let $S_1 \cup S_2 = \mathcal{L}(\mathcal{T})$ be the partition of the leaves of \mathcal{T} defined by e .

Lemma 7.1. *There are symplectomorphisms $\phi : M_\mathcal{T}(SL_2(\mathbb{C})) \rightarrow M_{\mathcal{T}'}(SL_2(\mathbb{C}))$, $\psi : M_{\mathcal{T}'}(SL_2(\mathbb{C})) \rightarrow M_\mathcal{T}(SL_2(\mathbb{C}))$. Furthermore, both maps are isomorphisms of $SU(2)^{\mathcal{L}(\mathcal{T})}$ Hamiltonian spaces.*

Proof. These spaces are defined by Hamiltonian $SU(2)^w$ and $SU(2)^{u,v}$ actions on $SL_2(\mathbb{C})^{E(\mathcal{T}')}$ and $SL_2(\mathbb{C})^{E(\mathcal{T})}$ respectively. We define $\hat{\phi} : \mu_w^{-1}(0) \rightarrow \mu_{u,v}^{-1}(0)$ on an element $(\dots, (k_i, v_i), \dots)$ by keeping all leaf terms $l \rightarrow (k_l, v_l)$, and labeling e with (Id, w_e) , where $w_e \in \mathfrak{su}(2)^*$ is computed by taking the sum of momentum terms from S_1 . Since the point we work with is in $\mu_w^{-1}(0)$, the sum of the momentum components from leaves in S_2 is $-w_e$, it follows that the image of $\hat{\phi}$ is in $\mu_{u,v}^{-1}(0)$.

We define $\hat{\psi} : \mu_{u,v}^{-1}(0) \rightarrow \mu_w^{-1}(0)$ by sending $(\dots, (k_l, v_l), \dots, (k_e, v_e), \dots, (k_j, v_j), \dots)$ to the tuple $((k_l, v_l), \dots, k_e \circ (k_j, v_j))$, where the components associated to $l \in S_1$ are unchanged, and the components associated to $j \in S_2$ are acted upon by k_e . The action is on the left if the associated edge is incoming to v and on the right if the edge is outgoing from v . It follows from definitions that the image of $\hat{\psi}$ is in $\mu_w^{-1}(0)$.

It is straightforward to check that $\hat{\phi}$ and $\hat{\psi}$ intertwine the group actions. The composition $\hat{\psi} \circ \hat{\phi}$ is identity, and $\hat{\phi} \circ \hat{\psi}(\dots, (k_e, v_e), \dots)$ is in the same $SU(2)^{v,u}$ orbit as $(\dots, (k_e, v_e), \dots)$. It follows that these maps descend to give diffeomorphisms. Furthermore, the subspace $\{Id\} \times \mathfrak{su}(2)^* \subset SL_2(\mathbb{C})$ is Lagrangian, so the induced maps are symplectomorphisms. It is also straightforward to check that these maps intertwine the residual $SU(2)^{\mathcal{L}(\mathcal{T})}$ action and the associated momentum maps. \square

Proposition 7.2. *Let $\mathcal{T} \subset \Gamma$ be a spanning tree, with corresponding maps $\phi_\mathcal{T} : \Gamma_g \rightarrow \Gamma$, $\psi_\mathcal{T} : \Gamma \rightarrow \Gamma_g$. This induces maps $\Phi_\mathcal{T} : M_\Gamma(SL_2(\mathbb{C})) \rightarrow M_{\Gamma_g}(SL_2(\mathbb{C}))$, $\Psi_\mathcal{T} : M_{\Gamma_g}(SL_2(\mathbb{C})) \rightarrow M_\Gamma(SL_2(\mathbb{C}))$ which are symplectomorphisms.*

Proof. This follows by repeatedly applying Lemma 7.1 to the edges of \mathcal{T} . □

7.2. The Hamiltonian \mathbb{T}_Γ -space $M_\Gamma(SL_2(\mathbb{C})^c)$. We have given a description of $M_\Gamma(SL_2(\mathbb{C})^c)$ as the affine toric variety associated to the convex body \mathcal{P}_Γ , now we describe a Hamiltonian action by a torus \mathbb{T}_Γ on this space. Recall that $SL_2(\mathbb{C})^c$ is itself a Hamiltonian S^1 space, and that the momentum map $\mu_{S^1} : SL_2(\mathbb{C})^c \rightarrow \mathbb{R}$ takes a class $[k, w][h, v]$ to $|w| = |v|$. The space $SL_2(\mathbb{C})^c$ is an S^1 reduction of $SL_2(\mathbb{C})/U_- \times U_+ \backslash SL_2(\mathbb{C})$, considered as a product of imploded cotangent bundles of $SU(2)$. The $SU(2)^2$ and S^1 actions commute on this product, and the $SU(2)^2$ action descends to the corresponding action on $SL_2(\mathbb{C})^c$, it follows that we may realize $M_\Gamma(SL_2(\mathbb{C})^c)$ as an $SU(2)^{V(\Gamma)} \times (S^1)^{E(\Gamma)}$ reduction of $[SL_2(\mathbb{C})/U_- \times U_+ \backslash SL_2(\mathbb{C})]^{E(\Gamma)}$.

By first reducing with respect to $SU(2)^{V(\Gamma)}$, we are lead to consider the spaces $SU(2)_0 \backslash [SL_2(\mathbb{C})/U]^3$. The momentum level 0 set for the action of $SU(2)$ on $[SL_2(\mathbb{C})/U]^3$ is the space $\mu_{SU(2)}^{-1}(0)$ of imploded triples $[k_1, r_1 \varrho][k_2, r_2 \varrho][k_3, r_3 \varrho]$ such that

$$(48) \quad r_1 k_1 \circ \varrho + r_2 k_2 \circ \varrho + r_3 k_3 \varrho = 0$$

The quotient space $SU(2) \backslash \mu_{SU(2)}^{-1}(0)$ is known as the space of spin-framed triangles in $\mathbb{R}^3 \cong \mathfrak{su}(2)^*$, see [HMM]. It is known that $SU(2) \backslash \mu_{SU(2)}^{-1}(0)$ is symplectomorphic to the affine toric manifold $\bigwedge^2(\mathbb{C}^3)$. Notice that the action of $(S^1)^3$ on this space has momentum map

$$(49) \quad \mu_{(S^1)^3}([k_1, r_1 \varrho][k_2, r_2 \varrho][k_3, r_3 \varrho]) = (r_1, r_2, r_3).$$

It follows that the momentum image is the polyhedral cone \mathcal{P}_3 of non-negative real triples (r_1, r_2, r_3) which can be the sides of a triangle.

Now we may realize $M_\Gamma(SL_2(\mathbb{C})^c)$ as an $(S^1)^{E(\Gamma)}$ reduction of the affine toric symplectic manifold $\prod_{v \in V(\Gamma)} SU(2) \backslash \mu_{SU(2)}^{-1}(0)$. Following the definition of $SL_2(\mathbb{C})^c$, the momentum map of the copy of S^1 associated to an edge $e \in E(\Gamma)$ is the difference in lengths of the two imploded coordinates associated to e in this product. We let $\mathbb{T}_\Gamma \subset (S^1)^{2E(\Gamma)}$ be the complementary product of tori to $(S^1)^{E(\Gamma)}$.

Proposition 7.3. *The space $M_\Gamma(SL_2(\mathbb{C})^c)$ is a Hamiltonian toric space, and the momentum image of the torus \mathbb{T}_Γ is the polyhedron \mathcal{P}_Γ .*

Proof. The space $\prod_{v \in V(\Gamma)} SU(2) \backslash \mu_{SU(2)}^{-1}(0)$ has a Hamiltonian action of $(S^1)^{2E(\Gamma)}$, with momentum image $\prod_{v \in V(\Gamma)} \mathcal{P}_3$. In reducing by $(S^1)^{E(\Gamma)}$, we pass to the subquotient with residual momentum image the subcone of $\prod_{v \in V(\Gamma)} \mathcal{P}_3$ where two components corresponding to the same edge $e \in E(\Gamma)$ have the same value, this is clearly \mathcal{P}_Γ . Furthermore, this is the momentum map of the residual action by the torus \mathbb{T}_Γ . □

7.3. The Γ -collapsing map. Recall that the collapsing map $\Xi : SL_2(\mathbb{C}) \rightarrow SL_2(\mathbb{C})^c$ is a surjective, continuous map of Hamiltonian $SU(2) \times SU(2)$ spaces, and that it preserves the left and right $SU(2)$ momentum mappings on these spaces.

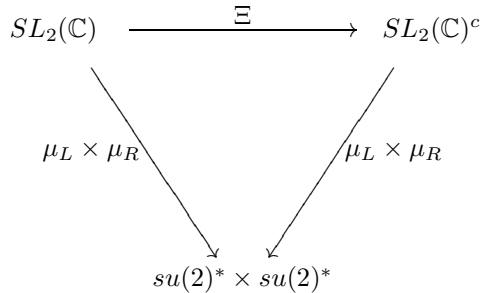

FIGURE 14. Ξ intertwines the momentum maps.

We let $\Xi^{E(\Gamma)} : SL_2(\mathbb{C})^{E(\Gamma)} \rightarrow [SL_2(\mathbb{C})^c]^{E(\Gamma)}$ be the product map, which is likewise a map of Hamiltonian $SU(2)^{V(\Gamma)}$ spaces.

$$\begin{array}{ccc}
SL_2(\mathbb{C})^{E(\Gamma)} & \xrightarrow{\Xi^{E(\Gamma)}} & [SL_2(\mathbb{C})^c]^{E(\Gamma)} \\
\mu_{SU(2)^{V(\Gamma)}} \searrow & & \swarrow \mu_{SU(2)^{V(\Gamma)}} \\
& [su(2)^*]^{V(\Gamma)} &
\end{array}$$

FIGURE 15. $\Xi^{E(\Gamma)}$ also intertwines the momentum maps.

It follows that $\Xi^{E(\Gamma)}$ restricts to a surjective, continuous map on the 0-level sets of the map(s) $\mu_{SU(2)^{V(\Gamma)}}$. We let Ξ_Γ be the map on the quotient by $SU(2)^{V(\Gamma)}$.

$$(50) \quad \Xi_\Gamma : \mathcal{X}(F_g, SL_2(\mathbb{C})) \cong M_\Gamma(SL_2(\mathbb{C})) \rightarrow M_\Gamma(SL_2(\mathbb{C})^c)$$

7.4. The integrable system in $\mathcal{X}(F_g, SL_2(\mathbb{C}))$. By Proposition 4.1 Ξ_Γ is a symplectomorphism on the dense, open subset $M_\Gamma^o(SL_2(\mathbb{C})) \subset M_\Gamma(SL_2(\mathbb{C}))$ of those points (k_e, v_e) with $v_e \neq 0$. It follows that this subspace is an integrable $\mathbb{T}_\Gamma = [S^1]^{E(\Gamma)}$ system, with momentum map computed as $\mu_{\mathbb{T}_\Gamma} \circ \Xi_\Gamma : \mathcal{X}(F_g, SL_2(\mathbb{C})) \rightarrow \mathcal{P}_\Gamma \subset \mathbb{R}^{E(\Gamma)}$. In particular, the Hamiltonians for the $M_\Gamma^o(SL_2(\mathbb{C}))$ system extend continuously to $\mathcal{X}(F_g, SL_2(\mathbb{C}))$.

We let $\Xi_\Gamma^{-1} : M_\Gamma^o(SL_2(\mathbb{C})^c) \rightarrow M_\Gamma^o(SL_2(\mathbb{C}))$ be the inverse map to the restriction of Ξ_Γ to $M_\Gamma^o(SL_2(\mathbb{C}))$. The Hamiltonian action of \mathbb{T}_Γ is computed through Ξ_Γ^{-1} as follows. Let $(t_e) \in \mathbb{T}_\Gamma$, and $(k_e, v_e) \in M_\Gamma(SL_2(\mathbb{C})) = \mathcal{X}(F_g, SL_2(\mathbb{C}))$.

$$(51) \quad (t_e) \star (k_e, v_e) = \Xi_\Gamma^{-1} \circ (t_e) \star \Xi_\Gamma(k_e, v_e) = \Xi_\Gamma^{-1} \circ ([k_e h_e^{-1}, w_e][t_e h_e, v_e]) = (k_e h_e^{-1} t_e h_e, v_e)$$

Recall that h_e is an element chosen so that $h_e \circ v_e = w_e = r_e \varrho_0$, for some $r_e \in \mathbb{R}_{\geq 0}$. The action by (t_e) is well-defined on any point (k_e, v_e) with $|v_e| = |w_e| = r_e > 0$ by Proposition 4.1.

7.5. Induced Γ -decomposition. By Proposition 4.1, the map Ξ_Γ is not 1 – 1 on the subspace $M_\Gamma(SL_2(\mathbb{C})) \setminus M_\Gamma^o(SL_2(\mathbb{C}))$, these are the points (k_e, v_e) with $|v_e| = 0$ for some subset of edges $S \subset E(\Gamma)$. We define $\Gamma_S \subset \Gamma$ to be the graph induced by the *complement* of S , and Γ^S to be the graph induced by S itself, with $v \in V(\Gamma^S)$ only if every edge incident to v is in S , see Figure 16. The next lemma addresses the structure of the possible Γ_S .

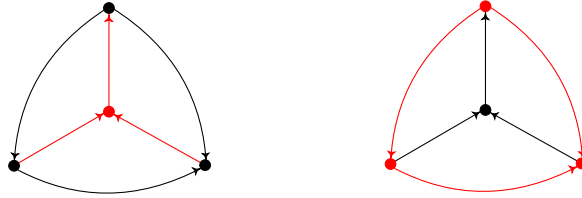

FIGURE 16. The graphs Γ^S (left) and Γ_S (right)

Lemma 7.4. *Let $S \subset E(\Gamma)$ be a set of edges for which some (k_e, v_e) has $v_e = 0$ if and only if $e \in S$, then $\Gamma_S \subset \Gamma$ has no leaves. For any subgraph $\Gamma' \subset \Gamma$ with no leaves, there exists a (k_e, v_e) with $v_e = 0$ for precisely $e \in E(\Gamma) \setminus E(\Gamma')$.*

Proof. Let $w \in V(\Gamma)$, have $\epsilon(w) = \{e_1, \dots, e_m\} \cup \{f_1, \dots, f_k\}$ with the e_i incoming and f_j outgoing. For $(k_e, v_e) \in \mu_{SU(2)^{V(\Gamma)}}^{-1}(0)$ the momentum 0 condition for the copy of $SU(2)$ associated to w is the following.

$$(52) \quad k_{e_1} \circ v_{e_1} + \dots + k_{e_m} \circ v_{e_m} - (v_{f_1} + \dots + v_{f_k}) = 0$$

If $\Gamma_S \subset \Gamma$ has a leaf, then for some $w \in V(\Gamma)$ all of the v_{e_i}, v_{f_j} above are 0 save one. This contradicts the equation.

For the second part, observe that if we can assign non-zero vectors to the edges of any graph which satisfy the momentum 0 condition above, we can take an such assignment to Γ_S and extend it to Γ by placing 0 on all edges of S . For this reason, it suffices to show that any graph supports a non-zero vector assignment.

We fix the genus g and consider the graph Γ_g with one vertex. Any assignment of vectors v_1, \dots, v_g to the edges of Γ_g satisfies the momentum 0 condition, because $\sum Id \circ v_1 + \dots + Id \circ v_g - (v_1 + \dots + v_g) = 0$. We take this as the base case of an induction on the number of edges in a graph Γ . We let Γ' be obtained from Γ by collapsing an edge $f \in E(\Gamma)$, $\delta(f) = (x, y)$ to a vertex $w \in V(\Gamma')$, and we suppose there is some assignment of (k_e, v_e) to the edges of Γ' which satisfies the momentum 0 condition, with all $v_e \neq 0$. The edges incident on w are partitioned into two sets $\epsilon(w) = X \cup Y$ by f , with those in X incident on x and those Y incident on y , with associated sums

$$(53) \quad \sigma = -[\sum_{i \in X} k_i \circ v_i - \sum_{j \in X} v_j] = [\sum_{i \in Y} h_i \circ z_i - \sum_{j \in Y} z_j].$$

There are two cases, $\sigma \neq 0$ and $\sigma = 0$. If $\sigma \neq 0$, we place (Id, σ) on the edge f . As f is incoming on y , we have $-\sigma + [\sum_{i \in Y} h_i \circ z_i - \sum_{j \in Y} z_j] = -\sigma + \sigma = 0$. We also have $\sigma + [\sum_{i \in X} k_i \circ v_i - \sum_{j \in X} v_j] = \sigma - \sigma = 0$, so this assignment satisfies the requisite conditions for Γ .

If $\sigma = 0$, we have two more cases. If f is a separating edge, we rotate all (k_i, v_i) , $i \in Y$ by some $g \in SU(2)$ to make the difference $\neq 0$, and reduce to the previous case. If f is not separating, we take it to be part of a simple loop $\gamma = (f, e_2, \dots, e_k)$ in Γ . Each edge of this loop is directed in some way, if two consecutive edges share a direction, we add a q or $-q$ to both (correcting as necessary with k_i^{-1}). If two consecutive edges switch directions, we switch signs. This can always be done, because there must always be an even number of switch vertices. To see this last point, note that if we have an odd number of switch vertices, then the edge orientation must switch an odd number of times as we go around γ , but this implies that f has both possible orientations, a contradiction. \square

Corollary 7.5. *The polytope $P_\Gamma \subset \mathbb{R}^{E(\Gamma)}$ intersects the coordinate subspace $\mathbb{R}^K \subset \mathbb{R}^{E(\Gamma)}$ if and only if $K = E(\Gamma')$, for $\Gamma' \subset \Gamma$ a subgraph with no leaves.*

We let $M_{\Gamma,S}(SL_2(\mathbb{C})) \subset M_\Gamma(SL_2(\mathbb{C}))$ and $M_{\Gamma,S}(SL_2(\mathbb{C})^c) \subset M_\Gamma(SL_2(\mathbb{C})^c)$ be the subspaces defined by the condition $|v_e| = 0$ if and only if $e \in S$. Clearly Ξ_Γ restricts to a surjective map $\Xi_\Gamma : M_{\Gamma,S}(SL_2(\mathbb{C})) \rightarrow M_{\Gamma,S}(SL_2(\mathbb{C})^c)$. The condition $|v_e| = 0$ if and only if $e \in S$ defines an open face of P_Γ , which is the image of $M_{\Gamma,S}(SL_2(\mathbb{C}))$ and $M_{\Gamma,S}(SL_2(\mathbb{C})^c)$ under the maps $\mu_\mathbb{T} \circ \Xi_\Gamma$ and $\mu_\mathbb{T}$, respectively. Furthermore, $M_{\Gamma,S}(SL_2(\mathbb{C})^c)$ is the \mathbb{T}^c orbit corresponding to this face. We draw two more conclusions about the geometry of these spaces. For the next proposition, we allow a graph Γ_S which may have bivalent vertices, the definition of $M_{\Gamma_S}(-)$ is identical.

Proposition 7.6. *The closure of $M_{\Gamma,S}(SL_2(\mathbb{C})^c)$ is isomorphic to the toric variety $M_{\Gamma_S}(SL_2(\mathbb{C})^c)$.*

Proof. By definition $M_{\Gamma,S}(SL_2(\mathbb{C})^c)$ is covered by the space of tuples (k_e, v_e) satisfying the momentum 0 condition $SU(2)^{V(\Gamma)}$ with $v_e = 0, k_e = Id$ for precisely those $e \in E(\Gamma_S)$. The closure of this space admits points where $v_e = 0$, and therefore k_e is identified to Id . This is the intersection of the subspace $(SL_2(\mathbb{C})^c)^{E(\Gamma_S)} \subset (SL_2(\mathbb{C})^c)^{E(\Gamma)}$ with the momentum level 0 space. As all $e \in S$ are assigned 0 lengths, this subspace is precisely the momentum level 0 set for the action of $SU(2)^{V(\Gamma_S)}$, and the condition $k_e \tilde{I}d$ implied by the definition of the contraction $SL_2(\mathbb{C})^c$ implies the action of $SU(2)^{V(\Gamma)}$ reduces to that of $SU(2)^{V(\Gamma_S)}$. \square

Proposition 7.7. *The map $\Xi_\Gamma : M_{\Gamma,S}(SL_2(\mathbb{C})) \rightarrow M_{\Gamma,S}(SL_2(\mathbb{C})^c)$ defines a $M_{\Gamma_S}(SU(2))$ bundle over $M_{\Gamma,S}(SL_2(\mathbb{C})^c)$*

Proof. First we consider the space $SU(2)^{E(\Gamma^S)} \times \mu_{SU(2)^{V(\Gamma_S)}}^{-1}(0)$, where the latter component is the 0 moment level set covering $M_{\Gamma,S}(SL_2(\mathbb{C})^c)$. A point in this space is a labelling of Γ with (k_e, v_e) , $v_e \neq 0$

$e \in E(\Gamma_S) \subset E(\Gamma)$, and $(k_f, 0)$ for $f \in E(\Gamma^S) \subset E(\Gamma)$. This defines an element of the 0 moment level set for the action of $SU(2)^{V(\Gamma)}$ on $SL_2(\mathbb{C})^{E(\Gamma)}$, indeed there is an injective map.

$$(54) \quad \bar{F} : SU(2)^{E(\Gamma^S)} \times \mu_{SU(2)^{V(\Gamma_S)}}^{-1}(0) \rightarrow \mu_{SU(2)^{V(\Gamma)}}^{-1}(0).$$

By passing to the quotient by $SU(2)^{V(\Gamma)}$ we clearly obtain an isomorphism with $M_{\Gamma,S}(SL_2(\mathbb{C}))$. Next, we note that by definition $SU(2)^{V(\Gamma)}$ splits as a product $SU(2)^{V(\Gamma^S)} \times SU(2)^{V(\Gamma_S)}$, so we carry out the quotient by this group in steps. The group $SU(2)^{V(\Gamma^S)}$ only acts on coordinates corresponding to edges in S , so quotienting by this group gives a map $\hat{F} : M_{\Gamma^S}(SU(2)) \times \mu_{SU(2)^{V(\Gamma_S)}}^{-1}(0) \rightarrow M_{\Gamma,S}(SL_2(\mathbb{C}))$.

Now, two points $(k_f, (k_e, v_e)), (h_f, (h_e, w_e)) \in M_{\Gamma^S}(SU(2)) \times \mu_{SU(2)^{V(\Gamma_S)}}^{-1}(0)$ map to the same point in $M_{\Gamma,S}(SL_2(\mathbb{C})^c)$, if and only if (k_e, v_e) and (h_e, w_e) are related by the action of an element $(g_v) \in SU(2)^{V(\Gamma_S)}$. It follows that $M_{\Gamma^S}(SU(2)) \times \{(h_e, w_e)\}$ lies in the fiber over the class $[(h_e, w_e)]$, and since any other element $(k_f, (k_e, v_e))$ in the fiber can be brought into this set by the action of $SU(2)^{V(\Gamma_S)}$. This proves the proposition. \square

In particular, if we take $S = E(\Gamma)$, the fiber over the unique point in $M_{\Gamma}(SL_2(\mathbb{C})^c)$ defined by the condition $|v_e| = 0$ for all $e \in E(\Gamma)$ is the character variety $M_{\Gamma}(SU(2)) = \mathcal{X}(F_g, SU(2)) \subset \mathcal{X}(F_g, SL_2(\mathbb{C}))$ associated to the group $SU(2)$. In any other case, Γ^S has leaves, and $M_{\Gamma^S}(SU(2))$ is a product of copies of $SU(2)$. This completes the proof of Theorems 1.3 and 1.4.

8. COMPACTIFICATIONS OF $\mathcal{X}(F_g, SL_2(\mathbb{C}))$

In this section we show that the cone $C_{\Gamma,\phi}$ of valuations on $\mathbb{C}[\mathcal{X}(F_g, SL_2(\mathbb{C}))]$ defined by a marking $\phi : \Gamma_g \rightarrow \Gamma$ is induced from a compactification $M_{\Gamma}(SL_2(\mathbb{C})) \subset M_{\Gamma}(X)$. Here $X \subset \mathbb{P}^5$ is the projective $SL_2(\mathbb{C}) \times SL_2(\mathbb{C})$ scheme from Section 4 obtained by taking *Proj* of the following graded algebra.

$$(55) \quad R = \mathbb{C}[a, b, c, d, t] / \langle ad - bc - t^2 \rangle$$

We construct $M_{\Gamma}(X)$ as a *GIT* quotient as in Section 5, using the $SL_2(\mathbb{C}) \times SL_2(\mathbb{C})$ -linearized line bundle $\mathcal{O}(1)$ on \mathbb{P}^5 .

8.1. The *GIT* quotient $M_{\Gamma}(X)$. As X is an $SL_2(\mathbb{C}) \times SL_2(\mathbb{C})$ variety, $X^{E(\Gamma)}$ carries an action of the group $SL_2(\mathbb{C})^{V(\Gamma)}$, as in Section 5. We observe that for each edge $e \in E(\Gamma)$ there is a corresponding divisor $D_e = D \times \prod_{e \neq f \in E(\Gamma)} X$. Furthermore, there is a subspace $D_S = \cap_{e \in S} D_e = \prod_{e \in S} D \times \prod_{f \in E(\Gamma) \setminus S} X$ for every $S \subset E(\Gamma)$. Each subspace D_S is $SL_2(\mathbb{C})^{E(\Gamma)}$ stable, and smooth, making $\hat{D}_{\Gamma} = \cup D_e$ a normal crossings divisor on $X^{E(\Gamma)}$.

We let $\mathcal{L} = i^*(\mathcal{O}(1))$ under $i : X \subset \mathbb{P}^5$, this bundle is $SL_2(\mathbb{C}) \times SL_2(\mathbb{C})$ -linearized and the projective coordinate ring of \mathcal{L} is then R . We place $\mathcal{L}^{\boxtimes E(\Gamma)}$ on $X^{E(\Gamma)}$, which then comes with an $SL_2(\mathbb{C})^{V(\Gamma)}$ action. Notice that this is the line bundle corresponding to the divisor \bar{D}_{Γ} , we define $M_{\Gamma}(X)$ to be the following *GIT* quotient.

$$(56) \quad M_{\Gamma}(X) = SL_2(\mathbb{C})^{V(\Gamma)} \backslash_{\mathcal{L}^{\boxtimes E(\Gamma)}} X^{E(\Gamma)}$$

The projective coordinate ring \bar{R}_{Γ} associated to the line bundle $\mathcal{L}^{\boxtimes E(\Gamma)}$ is a direct sum of the following spaces.

$$(57) \quad \bar{R}_{\Gamma}(m) = \bigoplus_{a: E(\Gamma) \rightarrow [0, m]} \bigotimes_{e \in E(\Gamma)} V(a(e)) \otimes V(a(e)) t^m$$

Once again, t^m serves as a placeholder in this algebra, and multiplication by $t \in V(0, 0)^{\otimes E(\Gamma)} t \subset \bar{R}_{\Gamma}(1)$ shifts a summand in $\bar{R}_{\Gamma}(m)$ to its isomorphic image in $\bar{R}_{\Gamma}(m+1)$. The projective coordinate ring $R_{\Gamma} = [\bar{R}_{\Gamma}]^{SL_2(\mathbb{C})^{V(\Gamma)}}$ of $M_{\Gamma}(X)$ has a similar description to the affine coordinate ring of $\mathbb{C}[M_{\Gamma}(SL_2(\mathbb{C}))]$, it is a direct sum of the following spaces.

$$(58) \quad R_\Gamma(m) = \bigoplus_{a: E(\Gamma) \rightarrow [0, m]} \left[\bigotimes_{e \in E(\Gamma)} V(a(e)) \otimes V(a(e)) \right]^{SL_2(\mathbb{C})^{V(\Gamma)}} t^m$$

Each of the spaces in this sum is spanned by a single spin diagram Φ_a , with $a(e) \leq m$ for all $e \in E(\Gamma)$. Multiplication on R_Γ is induced from the expected inclusions of $R_\Gamma(m) \subset \mathbb{C}[M_\Gamma(SL_2(\mathbb{C}))]$ by these inclusions.

Proposition 8.1. *The space $M_\Gamma(SL_2(\mathbb{C}))$ is a dense, open subset of $M_\Gamma(X)$.*

Proof. The subspaces $R_\Gamma(m)$ filter the algebra $\mathbb{C}[M_\Gamma(SL_2(\mathbb{C}))]$, so the algebra $\frac{1}{t}R_\Gamma$ is isomorphic to $\mathbb{C}[M_\Gamma(SL_2(\mathbb{C}))] \otimes \mathbb{C}[t, \frac{1}{t}]$ by standard properties of Rees algebras. This implies that the complement of the $t = 0$ hypersurface is $M_\Gamma(SL_2(\mathbb{C}))$. \square

8.2. The boundary divisor D_Γ . The divisor $D_\Gamma \subset M_\Gamma(X)$ is defined by the equation $t = 0$. The m -th graded piece of this ideal is the following subspace of $R_\Gamma^{SL_2(\mathbb{C})^{V(\Gamma)}}$.

$$(59) \quad \langle t \rangle \cap R_\Gamma(m) = \bigoplus_{a: E(\Gamma) \rightarrow [0, m-1]} \mathbb{C}\Phi_a t^m$$

The ideal $\langle t \rangle$ is the intersection of the following subspaces I_e , $e \in E(\Gamma)$.

$$(60) \quad I_e(m) = \bigoplus_{a: E(\Gamma) \rightarrow [0, m], a(e) < m} \mathbb{C}\Phi_a t^m$$

Proposition 8.2. *The subspaces I_e are prime ideals, and therefore define the irreducible components of D_Γ . The locus D_e of I_e is the image in $M_\Gamma(X)$ of $\bar{D}_e \subset X^{E(\Gamma)}$, and can be identified with the GIT quotient $SL_2(\mathbb{C})^{V(\Gamma)} \setminus_{\mathcal{L}_\Gamma} [\bar{D}_e \times \prod X]$.*

Proof. We let $\bar{I}_e \subset \bar{R}_\Gamma$ be defined in the same way as the I_e , by definition the locus of \bar{I}_e is $\bar{D}_e \subset X^{E(\Gamma)}$. Furthermore, $I_e = \bar{I}_e \cap R_\Gamma^{SL_2(\mathbb{C})^{V(\Gamma)}}$. This proves the first and second parts, the third part follows from the reductivity of the group $SL_2(\mathbb{C})^{V(\Gamma)}$. \square

The space $SL_2(\mathbb{C})^{E(\Gamma)}$ is compactified by $X^{E(\Gamma)}$, and the cone C_Γ of valuations on $\mathbb{C}[SL_2(\mathbb{C})^{E(\Gamma)}]$ are the divisorial valuations associated to \hat{D}_Γ . These valuations are induced on $\mathbb{C}[M_\Gamma(SL_2(\mathbb{C}))]$ by the inclusion $\mathbb{C}[M_\Gamma(SL_2(\mathbb{C}))] \subset \mathbb{C}[SL_2(\mathbb{C})^{E(\Gamma)}]$, this allows us to characterize the cone C_Γ .

Proposition 8.3. *The divisorial valuations on $\mathbb{C}[M_\Gamma(SL_2(\mathbb{C}))]$ attached to the components D_e are the extremal rays of C_Γ .*

Proof. For an edge $e \in E(\Gamma)$, let $\bar{\eta}_e$ be the generic point of $\bar{D}_e \subset X^{E(\Gamma)}$, and let η_e be the generic point of $D_e \subset M_\Gamma(X)$. We have the inclusion of local rings $\mathcal{O}_{\eta_e} = \mathcal{O}_{\bar{\eta}_e}^{SL_2(\mathbb{C})^{E(\Gamma)}} \subset \mathcal{O}_{\bar{\eta}_e}$. Furthermore, the generator π_e of the maximal ideal of $\mathcal{O}_{\bar{\eta}_e}$ is an invariant, it follows that this same element generates the maximal ideal of \mathcal{O}_{η_e} . \square

For a set $S \subset E(\Gamma)$, the ideal $I_S = \sum_{e \in S} I_e$ cuts out $D_S = \bigcap_{e \in S} D_e$.

$$(61) \quad I_S(m) = \bigoplus_{a: E(\Gamma) \rightarrow [0, m], \exists e \in E(\Gamma), a(e) < m} \mathbb{C}\Phi_a t^m$$

Proposition 8.4. *Each $I_S \subset R_\Gamma$ is prime, and $\text{codim}(D_S) = |S|$.*

Proof. If $f = \sum C_i \Phi_{a_i} \in R_\Gamma(m)$, $g = \sum K_i \Phi_{b_i} \in R_\Gamma(n)$, $f, g \notin I_S$, then $a_i(e) = m$ and $b_i(e) = n$ for all $e \in S$. Let $v_S = \sum_{e \in S} v_e : \mathbb{C}[M_\Gamma(SL_2(\mathbb{C}))] \rightarrow \mathbb{Z} \cup \{\infty\}$ be the sum of the extremal ray generators of C_Γ corresponding to the edges in S . We have $v_S(fg) = v_S(f) + v_S(g) = |S|(n+m)$, so it follows that some component Φ_c of $fg \in R_\Gamma(n+m)$ must have $c(e) = n+m$ for all $e \in S$.

For the second part we show that for any $S \subset S'$ with $|S' \setminus S| = 1$ there is an element $\Phi_a \in I_{S'}$, $\notin I_S$. This implies that the height of I_S is $|S|$, as it can be placed in a strict chain of prime ideals of length $|E(\Gamma)| = \dim(M_\Gamma(SL_2(\mathbb{C})))$. The element Φ_a must have an $a : E(\Gamma) \rightarrow [0, m]$ with $a(e) = m$

for all $e \in S$ and $a(f) < m$ for $f \in S' \setminus S$, for some $m \in \mathbb{Z}$. We let $m = 4$, and observe that each of the trinodes in Figure 17, and all of their permutations, can be part of a spin diagram. These can be combined without limitations to produce a weighting with the desired properties for any Γ .

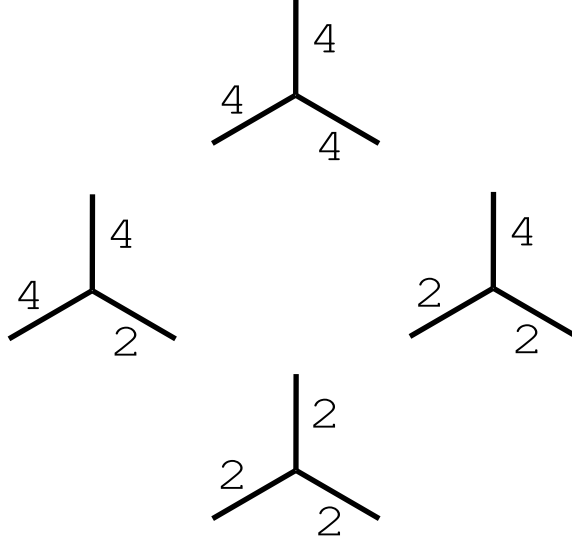

FIGURE 17. building blocks of the element $a \in I_{S'}, \notin I_S$

□

8.3. The induced toric degeneration of $M_\Gamma(X)$. We have shown that the projective coordinate ring R_Γ is a subring of $\mathbb{C}[M_\Gamma(SL_2(\mathbb{C}))] \otimes \mathbb{C}[t]$, and inherits the basis of spin diagrams $\Phi_a t^m$. Lemma 3.2 implies that the valuations $v_{\Gamma, \ell} \in C_\Gamma$ all extend to $\mathbb{C}[M_\Gamma(SL_2(\mathbb{C}))] \otimes \mathbb{C}[t]$ and R_Γ . We use an interior element of C_Γ to induce a toric degeneration on $M_\Gamma(X)$. The following scheme is the special fiber of this degeneration, in analogy with $M_\Gamma(SL_2(\mathbb{C})^c)$. Recall the flat toric degeneration X_0 of X from Section 4.

Definition 8.5. Let $M_\Gamma(X_0)$ be the GIT quotient of $X_0^{E(\Gamma)}$ with respect to the $SL_2(\mathbb{C})^{V(\Gamma)}$ -linearized line bundle $\mathcal{L}_0^{\boxtimes E(\Gamma)}$.

Proposition 8.6. An interior point $v_{\Gamma, \ell} \in C_\Gamma$ defines a flat degeneration $M_\Gamma(X) \Rightarrow M_\Gamma(X_0)$.

Proof. This argument is identical to the proof of Proposition 5.1. □

We let \bar{T}_Γ be the graded coordinate ring of $X_0^{E(\Gamma)}$ with respect to the line bundle $\mathcal{L}_0^{\boxtimes E(\Gamma)}$. The invariant subring $T_\Gamma \subset \bar{T}_\Gamma$ has an identical description to R_Γ as a direct sum of spaces associated to spin diagrams $a : E(\Gamma) \rightarrow \mathbb{Z}$.

$$(62) \quad T_\Gamma(m) = \bigoplus_{a: E(\Gamma) \rightarrow [0, m]} \left[\bigotimes_{e \in E(\Gamma)} V(a(e)) \otimes V(a(e)) \right]^{SL_2(\mathbb{C})^{V(\Gamma)}} t^m$$

The multiplication operation on this algebra is induced from \bar{T}_Γ , so it follows that the product of elements from components labeled by $a, b : E(\Gamma) \rightarrow \mathbb{Z}$ is an element in the component labeled by $a + b : E(\Gamma) \rightarrow \mathbb{Z}$. As each of these components is multiplicity free, it follows that T_Γ is a graded affine semigroup algebra.

Definition 8.7. We define the polytope Q_Γ to be the subset of $a \in P_\Gamma$ satisfying $a(e) \leq 1$.

Proposition 8.8. The algebra T_Γ is isomorphic to the graded affine semigroup algebra defined by Q_Γ with respect to the lattice L_Γ .

Proof. The description of $T_\Gamma(m)$ above implies that the basis of this space defined by the direct sum decomposition is in bijection with the lattice points of mQ_Γ . Multiplication in this algebra is computed by addition on the direct sum labels $a : E(\Gamma) \rightarrow \mathbb{Z}, m \in \mathbb{Z}$. \square

Example 8.9 (Graphs of genus 2). *The character variety $\mathcal{X}(F_2, SL_2(\mathbb{C}))$ is isomorphic to \mathbb{C}^3 . We depict the compactification polytopes $Q_{\Gamma_1}, Q_{\Gamma_2}$ for the two graphs of genus 2 in Figure 18. We have colored the intersection of $Q_{\Gamma_1}, Q_{\Gamma_2}$ with the coordinate hyperplanes in red. The fibers of Ξ_{Γ_i} for points in these intersections are products of 3-spheres $\mathbb{S}^3 \cong SU(2)$, with the exception of the fiber over the origin, which is $\mathcal{X}(F_2, SU(2))$.*

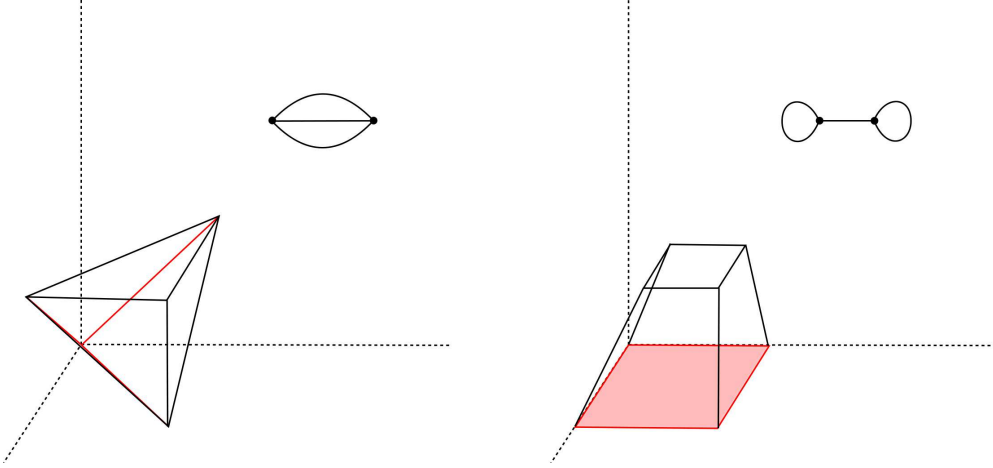

FIGURE 18. The polytopes $Q_{\Gamma_1}, Q_{\Gamma_2}$ for graphs of genus 2

The conditions which define $I_S \subset R_\Gamma$ likewise define ideals $J_S \subset T_\Gamma$. We let $K_S = \cap K_e$, for K_e the divisor defined by J_e .

Proposition 8.10. (1) *The ideal J_S cuts out the toric subspace $K_S \subset M_\Gamma(X_0)$ defined by the face $F_S = \{w \in Q_\Gamma, e \in S | w(e) = 1\}$.*

(2) *$\text{codim}(F_S) = \text{codim}(K_S) = |S|$.*

Proof. The first part follows from the observation that $S_\Gamma^{SL_2(\mathbb{C})^{V(\Gamma)}}(m)/J_S(m)$ has a basis in bijection with the lattice points of mF_S . The second part is identical to proof of Proposition 8.4. \square

Finally we relate D_S and K_S .

Proposition 8.11. *The space K_S is a toric degeneration of D_S .*

Proof. The graded component $R_\Gamma(m)/I_S(m)$ of the coordinate ring of has a basis $[\Phi_a]$ for $[a] \in mF_S \subset mQ_\Gamma$. For $[\Phi_a] \in R_\Gamma(m)/I_S(m)$, $[\Phi_b] \in R_\Gamma(n)/I_S(n)$, multiplication $[\Phi_a][\Phi_b]$ gives a sum $C_i[\Phi_{c_i}]$ for $[c_i] \in (n+m)F_S$, and $c_1 = a + b$. This expansion is obtained from the one in R_Γ by eliminating those Φ_{c_i} with $c_i \in I_S$. This implies that we may use any filtration induced by a v_ℓ in the interior of C_Γ can be used to obtain the toric degeneration to K_S . \square

This concludes the proof of Theorem 1.5.

REFERENCES

- [A] D. Alessandrini, *Amoebas, tropical varieties and compactification of Teichmüller spaces*, arXiv:math/0505269 [math.AG]
- [Baez] J. Baez, *An Introduction to Spin Foam Models of BF Theory and Quantum Gravity*, Lect. Notes Phys. 543 (2000), 25-94.
- [Ber] V. Berkovich, *Spectral theory and analytic geometry over non-Archimedean fields*, Vol. 33 of Mathematical Surveys and Monographs, American Mathematical Society, Providence, RI (1990).
- [CV] M. Culler, K. Vogtmann, *Moduli of graphs and automorphisms of free groups*, Invent. math. (1986), 84, 91-119.
- [CM] M. Culler, J. Morgan, *Group actions on \mathbb{R} -trees*, Proc. Lond. Math. Soc. (1987), 55, 571604.
- [DDW] G. Daskalopoulos, S. Dostoglou, R. Wentworth, *On the Morgan-Shalen compactification of the $SL(2, \mathbb{C})$ character varieties of surface groups*, Duke Math. J. (2000), 101, 2, 189-207.
- [Gr] F.D. Grosshans: *Algebraic homogeneous spaces and invariant theory*, Springer Lecture Notes, vol. 1673, Springer, Berlin, 1997.
- [FL] C. Florentino, S. Lawton, *Character varieties and the moduli quiver representations*, In the tradition of Ahlfors-Bers, Papers from the 5th Ahlfors-Bers Colloquium held at Rice University, Contemporary Mathematics, American Mathematical Society, (2013).
- [FL2] C. Florentino, S. Lawton, *The topology of moduli spaces of free group representations*, Mathematische Annalen (2009), 345, No. 2, 453-489
- [GJS] V. Guillemin, L. Jeffrey, and R. Sjamaar, *Symplectic Implosion*, Transform. Groups 7 (2002), no. 2, 155184.
- [HMM] B. Howard, C. Manon, J. J. Millson *The toric geometry of triangulated polygons in euclidean space*, Canad. J. Math. 63 (2011), 878-937.
- [HMM2] J. Hilgert, C. Manon, J. Martens, *Contraction and the symplectic geometry of the Vinberg monoid*, in preparation.
- [HK] M. Harada, K. Kaveh, *Toric degenerations, integrable systems and Okounkov bodies*, arXiv:1205.5249.
- [KK] K. Kaveh, A. G. Khovanskii, *Newton-Okounkov bodies, semigroups of integral point, graded algebras and intersection theory*, Ann. of Math, 176 (2012), 925-978.
- [KN] G. Kempf, L. Ness, *The length of vectors in representation spaces*, Algebraic Geometry, Proceedings, Copenhagen 1978, Lecture Notes in Mathematics 732, 233-243.
- [Kir] F. C. Kirwan, *Cohomology of quotients in symplectic and algebraic geometry*, Mathematical Notes, (1984) vol. 31, Princeton University Press, Princeton, NJ.
- [LP] S. Lawton, E. Peterson, *Computing $SL(2; \mathbb{C})$ Central Functions with Spin Networks*, Geometriae Dedicata, Volume 153, no. 1 (2011), 73-105.
- [M1] C. Manon, *Compactifications of character varieties and skein relations on conformal blocks*, arXiv:1401.8249 [math.AG]
- [M2] C. Manon, *Newton Okounkov polyhedra for character varieties and configuration spaces* arXiv:1403.3990 [math.AG]
- [M3] C. Manon, *Symplectic geometry of the Vinberg monoid and branching problems*, Mathematisches Forschungsinstitut Oberwolfach Report No. 27/2014, 31-35, DOI: 10.4171/OWR/2014/27
- [M4] C. Manon, *The mdissimilarity map and representation theory of $SL_m(\mathbb{C})$* , J. Alg. Comb. (2011) 33, 2, 199- 213.
- [MS] J. Morgan, P. Shalen, *Valuations, trees, and degeneration of hyperbolic structures*. Ann. of Math. (1984) 120, 401-476.
- [Mum] D. Mumford, *Geometric Invariant Theory*, Ergebnisse der Mathematik und Ihrer Grenzgebiete 34 (1965), Springer.
- [NNU] T. Nishinou, Y. Nohara and K. Ueda: *Toric degenerations of Gelfand-Cetlin systems and potential functions*. Adv. Math. 224 (2010), no. 2, 648706.
- [P] S. Payne, *Analytification is the limit of all tropicalizations*, Math. Res. Lett. (2009) 16, 3, 543-556.
- [R] W. D. Ruan: *Lagrangian torus fibration of quintic hypersurfaces. I. Fermat quintic case*. Winter School on Mirror Symmetry, Vector Bundles and Lagrangian Submanifolds (Cambridge, MA, 1999), volume 23 of AMS/IP Studies in Advanced Mathematics, pp. 297332. Amer. Math. Soc., Providence, RI, 2001.
- [SjL] R. Sjamaar, E. Lerman, *Stratified symplectic spaces and reduction*, Annals of Mathematics 134 (1991), 375422.
- [SpSt] D. Speyer and B. Sturmfels, *The tropical Grassmannian*, Adv. Geom. (2004) 4, 3, 389-411.
- [T] W. Thurston, *On the topology and dynamics of diffeomorphisms of surfaces*, Bull. Amer. Math. Soc. (N.S.) (1988) 19, 2, 417-431.
- [V] K. Vogtman, *Automorphisms of free groups and outer space* Geometriae Dedicata October (2002), Volume 94, Issue 1, pp 1-31.

Christopher Manon:
 cmanon@gmu.edu
 Department of Mathematics,
 George Mason University
 Fairfax, VA 22030 USA

