

Fullerenes with the maximum Clar number*

Yang Gao, Qiuli Li, Heping Zhang[†]

School of Mathematics and Statistics, Lanzhou University, Lanzhou, Gansu 730000, China

E-mail addresses: gaoy12@lzu.edu.cn, qlli@lzu.edu.cn, zhanghp@lzu.edu.cn

Abstract

The Clar number of a fullerene is the maximum number of independent resonant hexagons in the fullerene. It is known that the Clar number of a fullerene with n vertices is bounded above by $\lfloor n/6 \rfloor - 2$. We find that there are no fullerenes with $n \equiv 2 \pmod{6}$ vertices attaining this bound. In other words, the Clar number for a fullerene with $n \equiv 2 \pmod{6}$ vertices is bounded above by $\lfloor n/6 \rfloor - 3$. Moreover, we show that two experimentally produced fullerenes $C_{80}:1$ (D_{5d}) and $C_{80}:2$ (D_2) attain this bound. Finally, we present a graph-theoretical characterization for fullerenes, whose order n is congruent to 2 (respectively, 4) modulo 6, achieving the maximum Clar number $\lfloor n/6 \rfloor - 3$ (respectively, $\lfloor n/6 \rfloor - 2$).

Keywords: Fullerene; Clar number; Clar structure; M -associated graph

AMS subject classification 2010: 05C10, 05C62, 05C90

1 Introduction

Clar number is a stability predictor of the benzenoid hydrocarbon isomers. The concept of Clar number originates from the Clar's sextet theory [1] and Randić's conjugated circuits model [2]. For any two isomeric benzenoid hydrocarbons, the one with larger Clar number is more stable [1, 3]. Hansen and Zheng [4] reduced the Clar number problem of benzenoid hydrocarbons to an integer linear programming. Based on abundant computation, the same authors conjectured the linear programming relaxing is sufficient. The conjecture was confirmed by Abeledo and Atkinson [5].

A fullerene is defined as a finite, trivalent plane graph consisting solely of pentagons and hexagons. Grünbaum and Motzkin [6] showed that fullerene isomer with n atoms exists

*This work is supported by NSFC (Grant Nos.11371180 and 11401279).

[†]Corresponding author.

for $n = 20$ and for all even $n > 22$. To analyze the performance of the Clar number as a stability predictor of the fullerene isomers, we need good upper bounds on the Clar number of fullerenes. Fortunately, Zhang and Ye [7] established an upper bound of the Clar number of fullerenes. An alternative proof was given by Hartuny [8].

Theorem 1.1. [7] *Let F be a fullerene with n vertices. Then $c(F) \leq \lfloor n/6 \rfloor - 2$.*

There are seven experimentally produced fullerenes attaining the bound in Theorem 1.1, namely, $C_{60}:1 (I_h)$ [9], $C_{70}:1 (D_{5h})$ [10], $C_{76}:1 (D_2)$, [11, 12] $C_{78}:1 (D_3)$ [12–14], $C_{82}:3 (C_2)$ [14], $C_{84}:22 (D_2)$ [12, 15] and $C_{84}:23 (D_{2d})$ [12, 15], where $C_n:m$ occurs at position m in a list of lexicographically ordered spirals that describe isolated-pentagon isomers with n atoms [16], and the point group of the isomer is presented inside parenthesis. Ye and Zhang [17] gave a graph-theoretical characterization of fullerenes with at least 60 vertices attaining the maximum Clar number $n/6 - 2$, and constructed all 18 fullerenes attaining the maximum value 8 among all 1812 fullerene isomers of C_{60} . Later, Zhang et al. [18] proposed a combination of the Clar number and Kekulé count to predict the stability of fullerenes, which distinguishes uniquely the buckminsterfullerene C_{60} from its all 1812 fullerene isomers. Recently, Hartuny [8] gave another graph-theoretical characterization of fullerenes, whose Clar numbers are $n/6 - 2$, by establishing a connection between fullerenes and (4,6)-fullerenes, where a (4,6)-fullerene is a trivalent plane graph consisting solely of quadrilaterals and hexagons and is the molecular graph of some possible boron-nitrogen fullerene [19].

In this paper, we will show that there are no fullerenes with $n \equiv 2 \pmod{6}$ vertices attaining this bound. Thus Theorem 1.1 is refined as the following theorem.

Theorem 1.2. *Let F be a fullerene with n vertices. Then*

$$c(F) \leq \begin{cases} \lfloor n/6 \rfloor - 3, & n \equiv 2 \pmod{6}; \\ \lfloor n/6 \rfloor - 2, & \textit{otherwise}. \end{cases}$$

We say a fullerene **extremal** if the Clar number of the fullerene attains the bound in Theorem 1.2. In addition to the seven experimentally produced extremal fullerenes mentioned before, there are two experimentally produced extremal fullerenes $C_{80}:1 (D_{5d})$ [20, 21], $C_{80}:2 (D_2)$ [20] (see Figure 1). Moreover, the minimum fullerene C_{20} is also an extremal fullerene.

Furthermore, we give a graph-theoretical characterization of fullerenes, whose order n is congruent to 2 (respectively, 4) modulo 6, attaining the maximum Clar number $\lfloor n/6 \rfloor - 3$ (respectively, $\lfloor n/6 \rfloor - 2$).

2 Preliminaries

This section presents some concepts and results to be used later. For the concepts and notations of graphs not defined, we refer to [22].

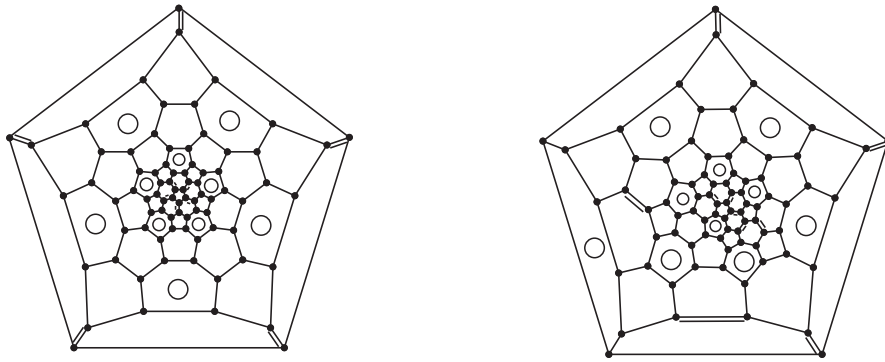

Figure 1. Two experimentally produced extremal fullerenes (a) $C_{80}:1 (D_{5d})$, (b) $C_{80}:2 (D_2)$. (These two graphs are generated by a software package [23] for constructing and analyzing structures of fullerenes before further processing.)

Let F be a fullerene. A **perfect matching** (or **Kekulé structure**) M of F is a set of edges such that each vertex is incident with exactly one edge in M . The faces with exactly half of their bounding edges in a perfect matching M of F are called **alternating faces** with respect to M . A **resonant pattern** of F is a set of independent alternating faces with respect to some perfect matching. The **Clar number** $c(F)$ of F is the maximum size of all resonant patterns of F . A **Clar set** is a set of independent alternating faces of size $c(F)$. If \mathcal{H} is a resonant pattern of F and M_0 is a perfect matching of $F - \mathcal{H}$, then we say (\mathcal{H}, M_0) is a **Clar cover** [24] of F . We say a Clar cover (\mathcal{H}, M_0) is a **Clar structure** if \mathcal{H} is a Clar set of F .

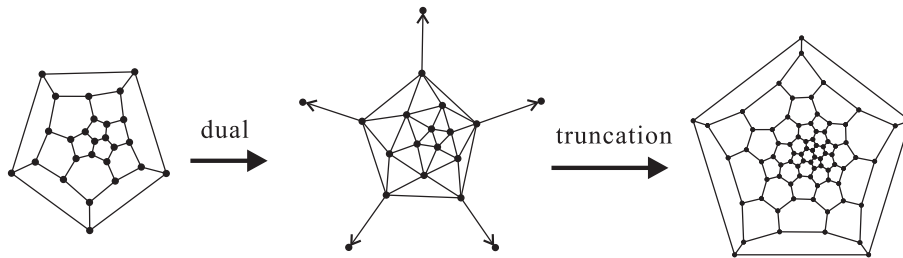

Figure 2. Illustration for the generation procedure of a fullerene with 78 vertices from another fullerene with 26 vertices by Leapfrog transformation. In order to make the procedure geometrically intuitive, one vertex of the graph in the middle has to be chosen at infinity.

Leapfrog transformation for a 2-connected plane graph G is usually defined as the truncation of the dual of G [25, 26]. The **leapfrog graph** $\mathcal{L}(G)$ is obtained from G by performing the leapfrog transformation. The **dual** of a plane graph is built as follows: Place a point in the inner of each face and join two such points if their corresponding faces share a common edge [26]. The **truncation** of a 2-connected plane graph G can be obtained by replacing each

vertex v of degree k with k new vertices, one for each edge incident to v . Pairs of vertices corresponding to the edges of G are adjacent, and k new vertices corresponding to a single vertex of G are joined in the cyclic order given by the embedding to form a face of size k [25]. Figure 2 illustrates the generation procedure of a fullerene with 78 vertices from another fullerene with 26 vertices by leapfrog transformation. Leapfrog transformation is defined equivalently as the dual of the omnicapping [27]. Leapfrog fullerenes have their own chemical importance. Firstly, they obey the isolated-pentagon rule [16]. Secondly, they are known to be one of the two constructions that always have properly closed-shell configurations [28]. Finally, they attain the maximum Fries number $\frac{n}{3}$ and thus are maximally stable in a localised valence bond picture [29].

Let F be a fullerene and (\mathcal{H}, M) a Clar cover of F . For a face f of F , we say that an edge e in M exits f if e shares exactly one vertex with f . The following lemma is essentially due to Hartung [8].

Lemma 2.1. [8] *Let F be a fullerene and (\mathcal{H}, M) a Clar cover of F . Then there are an even number of edges in M (possibly 0) exiting any hexagon and an odd number of edges in M exiting any pentagon.*

A perfect Clar structure [28] (or face-only vertex covering [8]) of a 2-connected plane graph G is a set of vertex-disjoint faces that include each vertex of G once. The following lemma [28] provides a graph-theoretical characterization of leapfrog graphs on the plane.

Lemma 2.2. [28] *A 2-connected plane graph is a leapfrog graph if and only if it is trivalent and has a perfect Clar structure.*

Suppose G is a leapfrog graph. Let \mathcal{P} be a perfect Clar structure of G . We construct a new plane graph as follows: For each face of G not belonging to \mathcal{P} , we allocate a vertex in the inner of it, then connect two vertices with an edge in the resulting graph if their corresponding faces are adjacent in G . It is not difficult to see that the leapfrog graph of the resulting graph is G . This graph is called the reverse leapfrog of G determined by \mathcal{P} , and denote it by $\mathcal{L}^{-1}(G, \mathcal{P})$.

Let G be a 2-connected plane graph satisfying : (1) It consists of only faces of even size, (2) The maximum degree of G is at most 6 and the minimum degree of G is 3, and (3) Each vertex of degree 4 is incident with at least 2 quadrilaterals, each vertex of degree 5 is incident with at least 4 quadrilaterals and each vertex of degree 6 is incident with exactly 6 quadrilaterals. For our purpose we define a generalized diagonalization of G as a choice of diagonal vertices for each quadrilateral so that each vertex of degree 4 is chosen twice or thrice, each vertex of degree 5 is chosen four or five times, each vertex of degree 6 is chosen six times and any other vertex is chosen at most once. A generalised diagonalization of a plane graph in Figure 3 (a) is illustrated in Figure 3 (b). The generalized diagonalization for

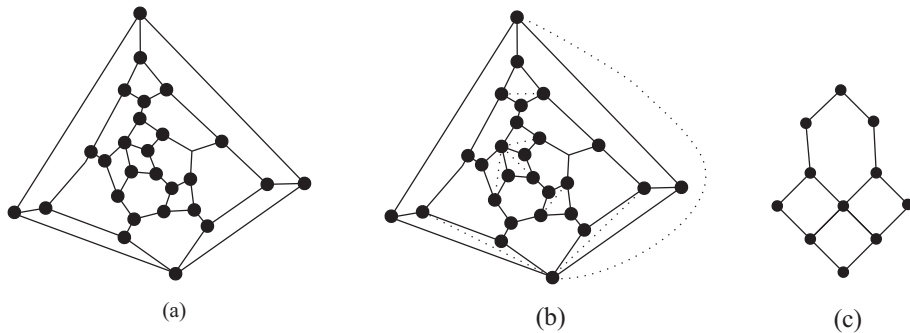

Figure 3. (a) A plane graph; (b) A generalized diagonalization of (a); (c) T .

such graphs is a natural generalization of diagonalization for (4,6)-fullerenes introduced by Hartung [8]. A **diagonalization** of a (4,6)-fullerene is defined as a choice of diagonal vertices for each quadrilateral so that each vertex is chosen at most once [8]. The following theorem of Hartung [8] gives a graph-theoretical characterization of extremal fullerenes with $n \equiv 0 \pmod{6}$ vertices.

Theorem 2.3. [8] *The extremal fullerenes with $n \equiv 0 \pmod{6}$ vertices are in one-to-one correspondence with the diagonalized (4,6)-fullerenes with $n/3 + 4$ vertices.*

A **bipartite graph** is a graph whose vertices can be divided into two disjoint sets such that every edge has an end in each set. The following lemma is well known.

Lemma 2.4. *A connected plane graph is bipartite if and only if it has only faces of even size.*

A graph G is **cyclically k -edge-connected** if deleting less than k edges from G can not separate it into two components such that each of them contains at least one cycle. The **cyclical edge-connectivity** of G , denote by $c\lambda(G)$, is the greatest integer k such that G is cyclically k -edge-connected. Cyclical edge-connectivity plays an important role in handling problems related to fullerenes. For examples, it is used to study the 2-extendability [30] and the lower bound of the forcing number [31] of fullerenes and the hamiltonicity [32] of the leapfrog fullerenes. Došlić [33], Qi and Zhang [34], and Kardoš and Škrekovski [35] determined the cyclical edge-connectivity of fullerenes.

Lemma 2.5. [33–35] *For a fullerene F , $c\lambda(F) = 5$.*

3 Proof of Theorem 1.2

Let F be a fullerene and (\mathcal{H}, M) a Clar cover of F . Then the **expansion** of F is defined as follows: Widen each edge in M into a quadrilateral. Each vertex covered by M becomes an

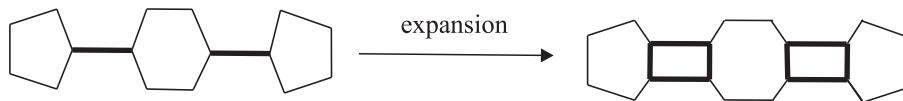

Figure 4. Illustration for expansion.

edge (see Figure 4). Denote this new graph by $\mathcal{E}(\mathcal{H}, M)$ and the set of quadrilaterals by \mathcal{Q} . The following lemma will be useful.

Lemma 3.1. *Let F be a fullerene with a Clar cover (\mathcal{H}, M) . Then*

- (1) $\mathcal{E}(\mathcal{H}, M)$ is a leapfrog graph.
- (2) $\mathcal{E}(\mathcal{H}, M)$ is a bipartite graph.
- (3) $\mathcal{E}(\mathcal{H}, M)$ is face 3-colorable, that is, its faces can be colored with 3 colors such that no two adjacent faces receive the same color.

Proof. (1) We can see that $\mathcal{E}(\mathcal{H}, M)$ is trivalent and $\mathcal{H} \cup \mathcal{Q}$ forms a perfect Clar structure of $\mathcal{E}(\mathcal{H}, M)$. Thus by Lemma 2.2, $\mathcal{E}(\mathcal{H}, M)$ is a leapfrog graph.

(2) If there are an odd number of edges in M exiting a face of f , then f is a pentagon from Lemma 2.1 and changes to an even face after expansion; If there are an even number of edges in M exiting a face of f , then f is a hexagon from Lemma 2.1 and changes to an even face after expansion. Further, there are additional $|M|$ quadrilaterals after expansion. Hence all faces of $\mathcal{E}(\mathcal{H}, M)$ are faces of even size. By Lemma 2.4, it follows that $\mathcal{E}(\mathcal{H}, M)$ is a bipartite graph.

(3) $\mathcal{E}(\mathcal{H}, M)$ is face 3-colorable since $\mathcal{E}(\mathcal{H}, M)$ is trivalent and bipartite. Saaty and Kainen proved that a trivalent plane graph is face 3-colorable if and only if it has only faces of even degree [36]. \square

It is implicit in Fowler's work [28] that if a trivalent plane graph is face 3-colorable, then it has unique face 3-coloring up to permutation. Since $\mathcal{E}(\mathcal{H}, M)$ is face 3-colorable, each color class forms a perfect Clar structure. Thus there are three reverse leapfrog graphs of $\mathcal{E}(\mathcal{H}, M)$ determined by the three perfect Clar structures of $\mathcal{E}(\mathcal{H}, M)$. The one corresponding to the perfect Clar structure $(\mathcal{H}, \mathcal{Q})$ of $\mathcal{E}(\mathcal{H}, M)$, that is, $\mathcal{L}^{-1}((\mathcal{E}(\mathcal{H}, M), (\mathcal{H}, \mathcal{Q})))$, is called the parent of $\mathcal{E}(\mathcal{H}, M)$, and denoted simply by $\mathcal{L}^{-1}(\mathcal{E}(\mathcal{H}, M))$. It has exactly $|M|$ quadrilaterals and $|\mathcal{H}|$ hexagons. The following corollary follows immediately.

Corollary 3.2. *Let F be a fullerene with a Clar cover (\mathcal{H}, M) . Then*

- (1) $\mathcal{L}^{-1}(\mathcal{E}(\mathcal{H}, M))$ is a connected plane bipartite graph.

(2) $\mathcal{L}^{-1}(\mathcal{E}(\mathcal{H}, M))$ consists solely of quadrilaterals and hexagons.

(3) The degree of each vertex of $\mathcal{L}^{-1}(\mathcal{E}(\mathcal{H}, M))$ is at least 3 and at most 6.

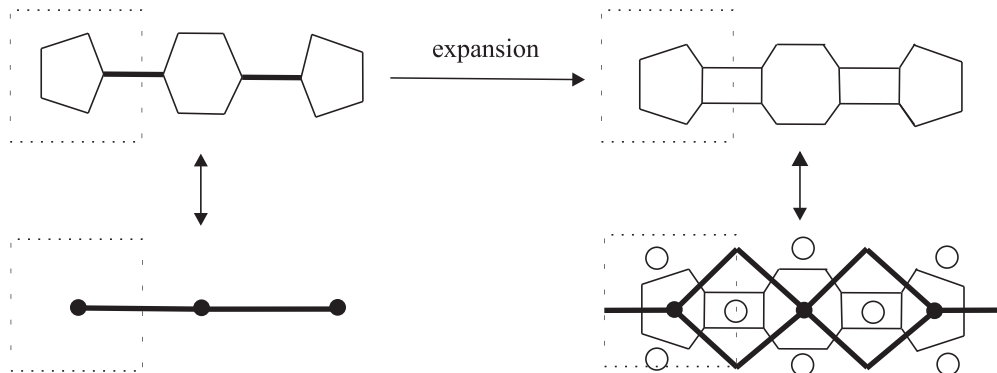

Figure 5. Illustration for the relation between degree of vertices in the M -associated graph and the degree of the corresponding vertices in $\mathcal{L}^{-1}(\mathcal{E}(\mathcal{H}, M))$.

Let F be a fullerene and (\mathcal{H}, M) a Clar cover of F . For every face f of F such that there is at least one edge in M exiting it, we allocate a vertex in the inner of it, then connect two vertices with an edge if corresponding faces are connected by an edge of M in F . The resulting graph is called the M -associated graph.

Clearly, each pentagon of F corresponds to a vertex of odd degree in the M -associated graph, and each hexagon of F corresponds to a vertex of even degree in the M -associated graph. Since F has exactly 12 pentagons and the other hexagons, the M -associated graph has exactly 12 vertices of odd degree. Furthermore, each edge of M in F corresponds to an edge of the M -associated graph. Hence the M -associated graph has $|M|$ edges. It is clear that each vertex of the M -associated graph corresponds to a vertex in $\mathcal{L}^{-1}(\mathcal{E}(\mathcal{H}, M))$. To be more exact, the vertices of degree 1 in the M -associated graph correspond to vertices of degree 3 in $\mathcal{L}^{-1}(\mathcal{E}(\mathcal{H}, M))$, the vertices of degrees 2 and 3 in the M -associated graph correspond to vertices of degree 4 in $\mathcal{L}^{-1}(\mathcal{E}(\mathcal{H}, M))$, the vertices of degrees 4 and 5 in the M -associated graph correspond to vertices of degree 5 in $\mathcal{L}^{-1}(\mathcal{E}(\mathcal{H}, M))$, and the vertices of degree 6 in the associated graph correspond to vertices of degree 6 in $\mathcal{L}^{-1}(\mathcal{E}(\mathcal{H}, M))$ (see Figure 5). We can also see that each vertex in $\mathcal{L}^{-1}(\mathcal{E}(\mathcal{H}, M))$ not corresponding to a vertex in the M -associated graph has degree 3.

The concept of the M -associated graph plays a crucial role in figuring out the structure of a fullerene with prescribed Clar number. Here is a basic property of the M -associated graph.

Lemma 3.3. *Let F be a fullerene with a Clar cover (\mathcal{H}, M) . Then the M -associated graph is simple.*

Proof. Suppose to the contrary that the M -associated graph contains multiple edges or loops. If the M -associated graph contains multiple edges, then there are two edges connecting two non-adjacent faces of F . If the M -associated graph contains loops, then there is an edge connecting two non-adjacent vertices of some face of F . In each case, it is easy to find a cyclic edge-cut of size less than five in F , which contradicts that F is cyclically 5-edge-connected by Lemma 2.5. \square

Suppose F is a fullerene with $n \equiv 2 \pmod{6}$ vertices and $c(F) = \lfloor n/6 \rfloor - 2$. Let (\mathcal{H}, M) be a Clar structure of F . Then we have the following result.

Lemma 3.4. *$|M| = 7$ and each component of the M -associated graph has 2 or 4 vertices of odd degree.*

Proof. It follows directly from $c(F) = \lfloor n/6 \rfloor - 2$ and $n \equiv 2 \pmod{6}$ that $|M| = 7$. Suppose to the contrary that there is a component G of the M -associated graph having less than 2 vertices of odd degree. Since G has an even number of vertices of odd degree, there are no vertices of odd degree in G . Thus G contains a cycle. By Lemma 3.3, G contains at least 3 edges. Since each component of the M -associated graph with k ($k \geq 2$) vertices of odd degree has at least $k - 1 \geq \frac{k}{2}$ edges and the M -associated graph has exactly 12 vertices of odd degree, the components of the M -associated graph other than G have at least 6 edges. Hence M has at least 9 edges, which contradicts that $|M| = 7$.

On the other hand, suppose to the contrary that there is a component G of the M -associated graph having more than 4 vertices of odd degree. Since the number of vertices of odd degree in G is even, G has at least 6 vertices of odd degree. Because $|M| = 7$, G has at most 8 vertices of odd degree. If G has exactly 6 vertices of odd degree, then G has at least 5 edges. All the other components of the M -associated graph have exactly 6 vertices of odd degree, and thus have at least 3 edges. It follows that M has at least 8 edges, which contradicts that M has exactly 7 edges. If G has exactly 8 vertices of odd degree, then G has at least 7 edges, and further the other components of the M -associated graph have at least 2 edges, which contradicts that M has exactly 7 edges. \square

By Lemma 3.4, each component of the M -associated graph has 2 or 4 vertices of odd degree. If a component G of the M -associated graph has exactly 2 vertices of odd degree, then the other components of the M -associated graph other than G have exactly 10 vertices of odd degree and at least 5 edges. Since $|M| = 7$, G has at most 2 edges. Hence G is P_2 or P_3 . If a component G of the M -associated graph has exactly 4 vertices of odd degree, then the other components of the M -associated graph other than G have exactly 8 vertices of odd degree and at least 4 edges. Since $|M| = 7$, G has at most 3 edges. Since G is connected, G has at least 3 edges. Hence G has exactly 3 edges and G is $K_{1,3}$. So all possible components of the M -associated graph are P_2, P_3 , and $K_{1,3}$. Suppose the M -associated graph has n_1

copies of P_2 , n_2 copies of P_3 and n_3 copies of $K_{1,3}$ as its components. We have a system of linear indeterminate equations

$$\begin{cases} n_1 + 2n_2 + 3n_3 = 7; \\ 2n_1 + 2n_2 + 4n_3 = 12. \end{cases} \quad (1)$$

Solving it, we have the following two solutions: (1) $n_1 = 5, n_2 = 1, n_3 = 0$; (2) $n_1 = 4, n_2 = 0, n_3 = 1$.

In order to prove Theorem 1.2, it suffices to prove the following result.

Theorem 3.5. *Let F be a fullerene with $n \equiv 2 \pmod{6}$ vertices. Then $c(F) \neq \lfloor \frac{n}{6} \rfloor - 2$.*

Proof. Suppose to the contrary that $c(F) = \lfloor \frac{n}{6} \rfloor - 2$. Let (\mathcal{H}, M) be a Clar structure of F . Then by the discussion before, the M -associated graph is either $P_3 \cup 5P_2$ or $K_{1,3} \cup 4P_2$. In either case, $\mathcal{L}^{-1}(\mathcal{E}(\mathcal{H}, M))$ has one vertex of degree 4 and the other vertices of degree 3. Moreover, $\mathcal{L}^{-1}(\mathcal{E}(\mathcal{H}, M))$ consists seven quadrilaterals and the other hexagons.

In what follows, we are going to prove such a graph does not exist. Suppose there is a plane graph G satisfying the above property. Since all faces of G are of even size, by Lemma 2.4, G is a bipartite graph. Moreover, the connectivity of G guarantees that the bipartition is unique. Suppose $G = (A, B)$. Without loss of generality, we may assume that the unique 4-degree vertex is contained in A . Then $|E(G)| = 3|A| + 1 = 3|B|$, a contradiction. \square

4 Extremal fullerenes with $n \equiv 4 \pmod{6}$ vertices

In this section, we give a graph-theoretical characterization of the extremal fullerenes whose order is congruent to 4 modulo 6. The following lemma is a counterpart of Lemma 3.4. The proof is analogous to the corresponding proof of Lemma 3.4 and is omitted here.

Lemma 4.1. *Let F be an extremal fullerene with $n \equiv 4 \pmod{6}$ vertices and (\mathcal{H}, M) a Clar structure of F . Then $|M| = 8$ and each component of the M -associated graph has 2, 4 or 6 vertices of odd degree.*

By Lemma 4.1, we can enumerate all possible components of the M -associated graph. All possible components of the M -associated graph are $P_2, P_3, P_4, K_{1,3}, K_{1,4}$ and $K_{1,5}$. Suppose the M -associated graph has n_1 copies of P_2 , n_2 copies of P_3 , n_3 copies of P_4 , n_4 copies of $K_{1,3}$, n_5 copies of $K_{1,4}$ and n_6 copies of $K_{1,5}$ as its components. We have a system of linear indeterminate equations.

$$\begin{cases} n_1 + 2n_2 + 3n_3 + 3n_4 + 4n_5 + 5n_6 = 8; \\ 2n_1 + 2n_2 + 2n_3 + 4n_4 + 4n_5 + 6n_6 = 12. \end{cases} \quad (2)$$

Solving it, we have the following 6 solutions: (1) $n_6 = 1, n_1 = 3, n_i = 0, i \neq 1, 6$; (2) $n_5 = 1, n_1 = 4, n_i = 0, i \neq 1, 5$; (3) $n_4 = 2, n_1 = 2, n_i = 0, i \neq 1, 4$; (4) $n_4 = 1, n_2 = 1, n_1 = 3, n_i = 0, i \neq 1, 2, 4$; (5) $n_3 = 1, n_1 = 5, n_i = 0, i \neq 1, 3$; (6) $n_2 = 2, n_1 = 4, n_i = 0, i \neq 1, 2$. Each solution of the system of linear indeterminate equations (2) corresponds to a possible M -associated graph. Now it is time to determine the structure of $\mathcal{L}^{-1}(\mathcal{E}(\mathcal{H}, M))$.

Theorem 4.2. *Let F be an extremal fullerene with $n \equiv 4 \pmod{6}$ vertices and (\mathcal{H}, M) a Clar structure of F . Then $\mathcal{L}^{-1}(\mathcal{E}(\mathcal{H}, M))$ is a plane graph with $(n+14)/3$ vertices satisfying (i) It consists exactly 8 quadrilaterals and the other hexagons, (ii) It has exactly two vertices of degree 4 and the other vertices of degree 3, (iii) Each vertex of degree 4 is incident with at least 2 quadrilaterals, and (iv) Each partite set contains one vertex of degree 4.*

Proof. Consider all the 6 possible M -associated graphs corresponding to all the 6 solutions of the system of linear indeterminate equations (2). For each possible M -associated graph, $\mathcal{L}^{-1}(\mathcal{E}(\mathcal{H}, M))$ consists exactly 8 quadrilaterals and the other hexagons.

For each possible M -associated graph corresponding to Solutions (1) and (2) of the system of linear indeterminate equations (2), $\mathcal{L}^{-1}(\mathcal{E}(\mathcal{H}, M))$ has exactly one vertex of degree 5 and the other vertices of degree 3. We will show that such a graph does not exist. If not, suppose G is such a plane graph. Since all faces of G are of even size, by Lemma 2.4, G is a bipartite graph. Because G is connected, the bipartition of G is unique. Suppose $G = (A, B)$. Without loss of generality, we may assume that the unique vertex of degree 5 is contained in A . Then $|E(G)| = 3|A| + 2 = 3|B|$, a contradiction.

For each possible M -associated graph corresponding to the other solutions of the system of linear indeterminate equations (2), $\mathcal{L}^{-1}(\mathcal{E}(\mathcal{H}, M))$ has exactly two vertices of degree 4 and the other vertices of degree 3. Amongst these, for each possible M -associated graph corresponding to Solution (5), two vertices of degree 4 in $\mathcal{L}^{-1}(\mathcal{E}(\mathcal{H}, M))$ belong to the same partite set, whereas for each possible M -associated graph corresponding to the other solutions, two vertices of degree 4 in $\mathcal{L}^{-1}(\mathcal{E}(\mathcal{H}, M))$ belong to different partite sets. We claim that two vertices of degree 4 in $\mathcal{L}^{-1}(\mathcal{E}(\mathcal{H}, M))$ belong to different partite sets. Suppose to the contrary that two 4-degree vertices of G belong to the same partite set, say A . Then $|E(G)| = 3|A| + 2 = 3|B|$, a contradiction. Moreover, we can see that each vertex of degree 4 is incident with at least 2 quadrilaterals. \square

By the proof of Theorem 4.2, for an extremal fullerene F with $n \equiv 4 \pmod{6}$ vertices and a Clar structure (\mathcal{H}, M) of F , the M -associated graph is one of the following three graphs: $2K_{1,3} \cup 2P_2$, $K_{1,3} \cup P_3 \cup 3P_2$ and $2P_3 \cup 4P_2$.

Let G be a plane graph which satisfies (i),(ii),(iii) and (iv) in Theorem 4.2. We want to determine the conditions under which G can be transformed into an extremal fullerene. First we know that $\mathcal{L}(G)$ is a trivalent plane graph satisfying (i') It consists of exactly 2 octagons,

8 quadrilaterals and the other hexagons, (ii') All quadrilaterals of it lie in the same perfect Clar structure, and (iii') Each octagon is adjacent to at least two quadrilaterals. For each quadrilateral, we select a pair of opposite edges and contract it into an edge. Clearly, the resulting graph is trivalent. Since quadrilaterals in G correspond to quadrilaterals in $\mathcal{L}(G)$, selecting a pair of opposite edges from a quadrilateral in $\mathcal{L}(G)$ is equivalent to selecting a pair of faces in $\mathcal{L}(G)$ which are connected by this pair of opposite edges. Thus it is further equivalent to choose distinct diagonal vertices from corresponding quadrilateral in G . Since the size of each face connected by a pair of opposite edges in $\mathcal{L}(G)$ is decreased by one after contraction, in order to make the size of each face of the resulting graph be five or six, for each octagon, we should select two or three pair of opposite edges exiting it. We can contract $\mathcal{L}(G)$ into an extremal fullerene exactly when a generalized diagonalization of G is possible. Together with Theorem 4.2, we have the following graph-theoretical characterization for extremal fullerenes with $6k + 4$ vertices.

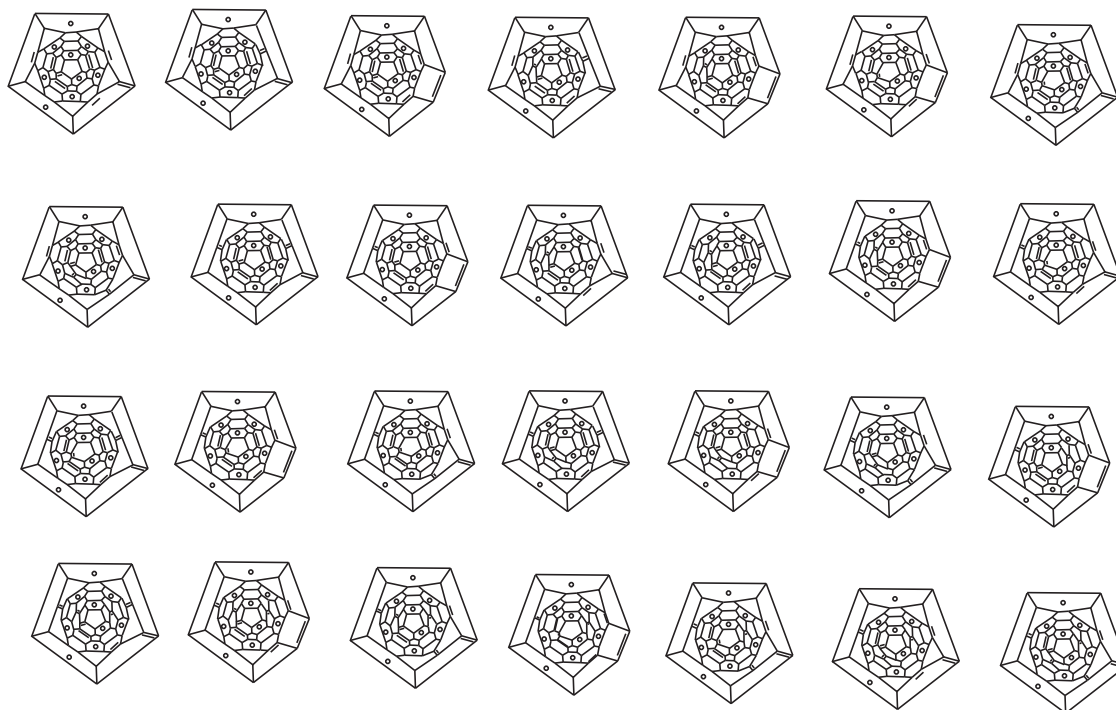

Figure 6. Extremal fullerenes generated from different generalized diagonalizations of the plane graph in Figure 3 (a).

Theorem 4.3. *The extremal fullerenes with $n \equiv 4 \pmod{6}$ vertices are in one-to-one correspondence with the generalized diagonalized plane graphs with $(n + 14)/3$ vertices satisfying (i) It consists exactly 8 quadrilaterals and the other hexagons, (ii) It has exactly two vertices of degree 5 and the other vertices of degree 3, (iii) Each vertex of degree 4 is incident with*

at least 2 quadrilaterals, and (iv) Each partite set of G contains one vertex of degree 4.

As an example, consider a graph illustrated in Figure 3 (a). This graph satisfies Conditions (i), (ii), (iii) and (iv) in Theorem 4.2. Further, it has multiple disjoint two quadrilaterals and two copies of T (see Figure 3 (c)) as subgraphs. Since a quadrilateral has two ways to diagonalize and a copy of T has four ways to diagonalize, we have totally 64 different generalized diagonalization of G . Each corresponds to an extremal fullerene. Eliminating the isomorphic fullerenes from these 64 extremal fullerenes, we have 28 multiple non-isomorphic extremal fullerenes (see Figure 6), including the experimentally produced $C_{70}:1(D_{5h})$.

5 Extremal fullerenes with $n \equiv 2 \pmod{6}$ vertices

In this section, we study the extremal fullerenes whose order is congruent to 2 modulo 6. By a similar argument as in Lemma 3.4, we have the following result.

Lemma 5.1. *Let F be an extremal fullerene with $n \equiv 2 \pmod{6}$ vertices and (\mathcal{H}, M) a Clar structure of F . Then $|M| = 10$ and each component of the M -associated graph has at most 10 vertices of odd degree.*

Note that there are a number of candidates for possible components of the M -associated graph satisfying the constraint in Lemma 5.1. The following lemma reduces the number of candidates for possible components of the M -associated graph considerable.

Lemma 5.2. *Let F be an extremal fullerene with $n \equiv 2 \pmod{6}$ vertices and (\mathcal{H}, M) a Clar structure of F . Then the M -associated graph does not contain P_5 as subgraph.*

Proof. It suffices to show that there is no component of the M -associated graph containing P_5 as subgraph. Suppose to the contrary that there is a component G of the M -associated graph containing P_5 as subgraph. Suppose G contains $2s$ vertices of odd degree. Then by Lemma 5.1, we have $1 \leq s \leq 5$.

Claim 1. G has at least $s + 3$ edges and at most $s + 4$ edges.

For the case $s = 1$, G is a path. Each path containing P_5 as its subgraph has at least $s + 3$ edges. Furthermore, every graph which has exactly $2(s + 1)$ odd-degree vertices and contains P_5 as its subgraph can be obtained from a graph which has exactly $2s$ vertices of odd degree and contains P_5 as its subgraph in terms of one of the following two operations: (1) Add an edge between two vertices of even degree; (2) Add a new vertex and add an edge between this new vertex and a vertex of odd degree. For each operation, at least one edge is added. Thus the associated graph of G has at least $s + 3$ edges.

On the other hand, suppose G has more than $s + 4$ edges. Then the components of the M -associated graph except G have less than $6 - s$ edges since $|M| = 10$. But the components

of the M -associated graph except G have exactly $12 - 2s$ vertices of odd degree, and thus have at least $6 - s$ edges, a contradiction. This proves Claim 1.

By Claim 1 there are two cases to be considered:

Case 1. G has $s + 3$ edges.

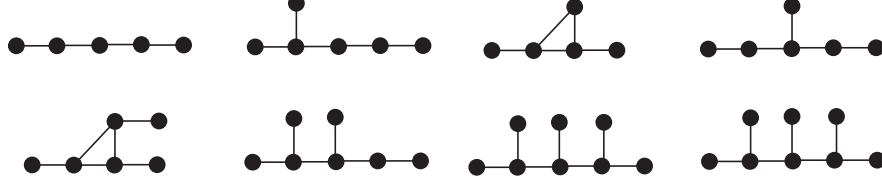

Figure 7. All possible G with $s + 3$ edges.

All possible G 's are illustrated in Figure 7. In each case, $\mathcal{L}^{-1}(\mathcal{E}(\mathcal{H}, M))$ has three vertices of degree 4 corresponding to three non-1-degree vertices of G . These three vertices of degree 4 are contained in the same partite set of $\mathcal{L}^{-1}(\mathcal{E}(\mathcal{H}, M))$. The components of the M -associated graph except G have $7 - s$ edges and exactly $12 - 2s$ vertices of odd degree. By a similar discussion as in Section 3, there is exactly a new vertex of degree 4 in $\mathcal{L}^{-1}(\mathcal{E}(\mathcal{H}, M))$ except the three vertices of degree 4 we already have. Since the $\mathcal{L}^{-1}(\mathcal{E}(\mathcal{H}, M))$ is bipartite and connected, we may assume $\mathcal{L}^{-1}(\mathcal{E}(\mathcal{H}, M)) = (A, B)$. Without loss of generality, we may assume that this new vertex of degree 4 is contained in A . Hence $|\nabla(A)| \equiv 1 \pmod{3}$, but $|\nabla(B)| \equiv 0 \pmod{3}$, where $\nabla(S)$ denotes the set of edges going from S to $V(G) - S$, a contradiction.

Case 2. G has $s + 4$ edges.

All possible G 's are illustrated in Figure 8. The components of the M -associated graph except G have $6 - s$ edges. But the components of the M -associated graph except G have exactly $12 - 2s$ vertices of odd degree. Thus the components of the M -associated graph except G are all P_2 's. Hence there are no vertices of degrees 4, 5 and 6 in $\mathcal{L}^{-1}(\mathcal{E}(\mathcal{H}, M))$ except those correspond to G . If G is one of the graphs in $L_1, L_2, L_4, L_5, L_7, L_8, L_{10}, L_{11}, L_{12}, L_{13}, L_{14}, L_{15}, L_{16}, L_{17}, L_{18}, L_{23}, L_{24}, L_{25}, L_{29}, L_{30}, L_{32}, L_{33}, L_{36}, L_{41}$ and L_{42} , then $\mathcal{L}^{-1}(\mathcal{E}(\mathcal{H}, M))$ has exactly four vertices of degree 4. These four vertices of degree 4 are contained in the same partite set of $\mathcal{L}^{-1}(\mathcal{E}(\mathcal{H}, M))$. We may assume $\mathcal{L}^{-1}(\mathcal{E}(\mathcal{H}, M)) = (A, B)$. Without loss of generality, we may also assume that these four vertices of degree 4 are contained in A . Then $|\nabla(A)| \equiv 1 \pmod{3}$, but $|\nabla(B)| \equiv 0 \pmod{3}$, a contradiction. Otherwise, $\mathcal{L}^{-1}(\mathcal{E}(\mathcal{H}, M))$ has exactly two vertices of degree 4 and one vertex of degree 5. These two 4-degree vertices and one vertex of degree 5 are contained in the same partite set of $\mathcal{L}^{-1}(\mathcal{E}(\mathcal{H}, M))$, say A . Then $|\nabla(A)| \equiv 1 \pmod{3}$, but $|\nabla(B)| \equiv 0 \pmod{3}$, a contradiction. \square

By Lemma 5.2, all possible components of the M -associated graph are enumerated in Figure 9. Suppose the M -associated graph has n_i copies of N_i as its components, and N_i has

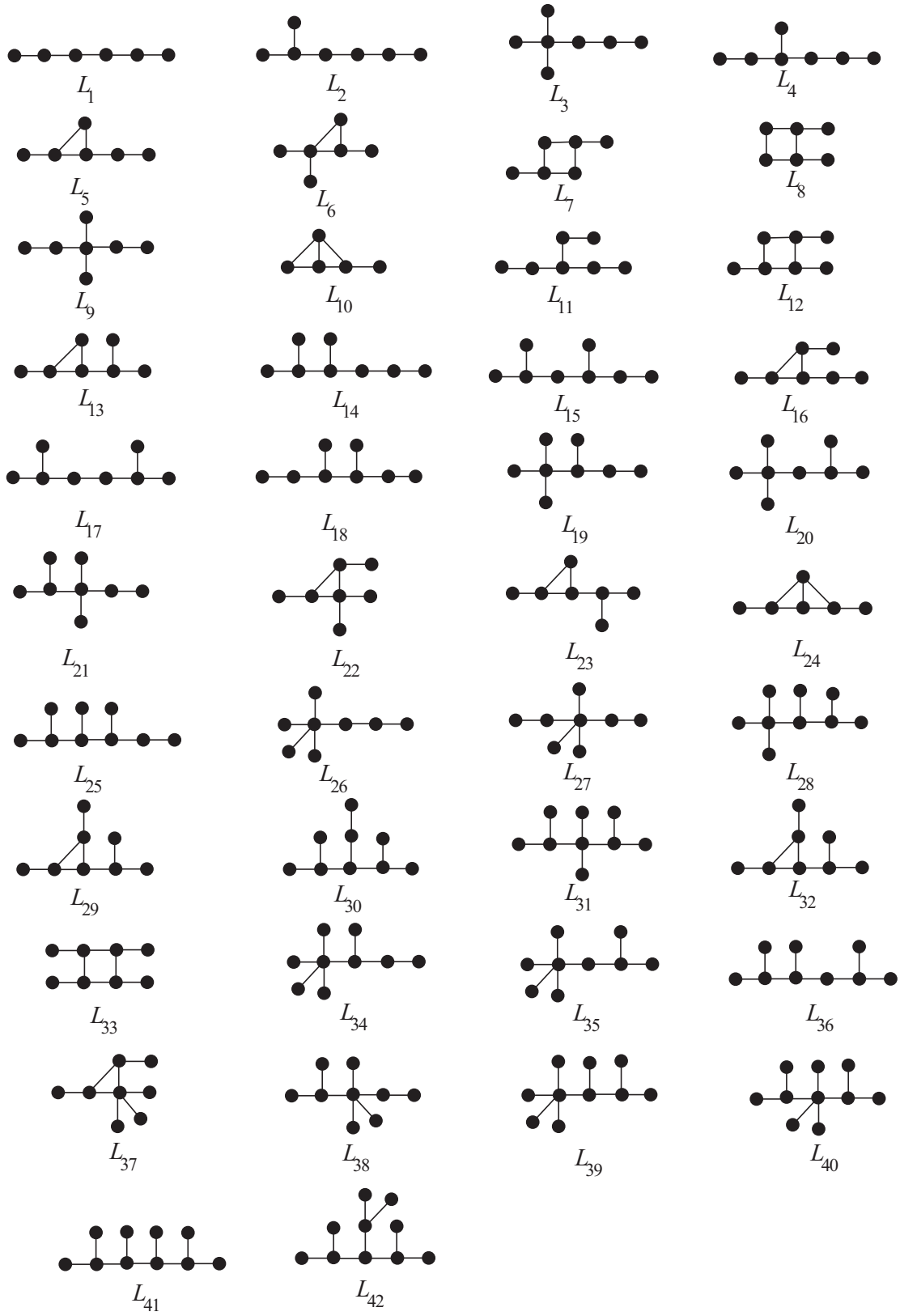

Figure 8. All possible G with $s + 4$ edges.

l_i edges and k_i vertices of odd degree. We have a system of linear indeterminate equations:

$$\begin{cases} \sum_{i=1}^{22} n_i l_i = 10; \\ \sum_{i=1}^{22} n_i k_i = 12. \end{cases} \quad (3)$$

Solving it, we have the following 45 solutions: (1) $n_{22} = 1, n_3 = 1, n_i = 0, i \neq 3, 22$; (2) $n_{21} = 1, n_3 = 2, n_i = 0, i \neq 3, 21$; (3) $n_{20} = 1, n_3 = 2, n_i = 0, i \neq 3, 20$; (4) $n_{19} = 1, n_9 = 1, n_i = 0, i \neq 9, 19$; (5) $n_{19} = 1, n_4 = 1, n_3 = 1, n_i = 0, i \neq 3, 4, 19$; (6) $n_{18} = 1, n_3 = 3, n_i = 0, i \neq 3, 18$; (7) $n_{17} = 1, n_9 = 1, n_3 = 1, n_i = 0, i \neq 3, 9, 17$; (8) $n_{17} = 1, n_4 = 1, n_3 = 2, n_i = 0, i \neq 3, 4, 17$; (9) $n_{16} = 1, n_9 = 1, n_3 = 1, n_i = 0, i \neq 3, 9, 16$; (10) $n_{16} = 1, n_4 = 1, n_3 = 2, n_i = 0, i \neq 3, 4, 16$; (11) $n_{15} = 2, n_i = 0, i \neq 15$; (12) $n_{15} = 1, n_{11} = 1, n_3 = 1, n_i = 0, i \neq 3, 11, 15$; (13) $n_{15} = 1, n_{10} = 1, n_3 = 1, n_i = 0, i \neq 3, 10, 15$; (14) $n_{15} = 1, n_9 = 1, n_4 = 1, n_i = 0, i \neq 4, 9, 15$; (15) $n_{15} = 1, n_5 = 1, n_3 = 2, n_i = 0, i \neq 3, 5, 15$; (16) $n_{15} = 1, n_4 = 2, n_3 = 1, n_i = 0, i \neq 3, 4, 15$; (17) $n_{14} = 1, n_3 = 4, n_i = 0, i \neq 3, 14$; (18) $n_{13} = 1, n_3 = 4, n_i = 0, i \neq 3, 14$; (19) $n_{12} = 1, n_9 = 1, n_3 = 2, n_i = 0, i \neq 3, 9, 12$; (20) $n_{12} = 1, n_4 = 1, n_3 = 3, n_i = 0, i \neq 3, 4, 12$; (21) $n_{11} = 2, n_3 = 2, n_i = 0, i \neq 3, 11$; (22) $n_{11} = 1, n_{10} = 1, n_3 = 2, n_i = 0, i \neq 3, 10, 11$; (23) $n_{11} = 1, n_9 = 2, n_i = 0, i \neq 9, 11$; (24) $n_{11} = 1, n_9 = 1, n_4 = 1, n_3 = 1, n_i = 0, i \neq 3, 4, 9, 11$; (25) $n_{11} = 1, n_5 = 1, n_3 = 3, n_i = 0, i \neq 3, 5, 11$; (26) $n_{11} = 1, n_4 = 2, n_3 = 2, n_i = 0, i \neq 3, 4, 11$; (27) $n_{10} = 2, n_3 = 2, n_i = 0, i \neq 3, 10$; (28) $n_{10} = 1, n_9 = 2, n_i = 0, i \neq 9, 10$; (29) $n_{10} = 1, n_9 = 1, n_4 = 1, n_3 = 1, n_i = 0, i \neq 3, 4, 9, 10$; (30) $n_{10} = 1, n_5 = 1, n_3 = 3, n_i = 0, i \neq 3, 5, 10$; (31) $n_{10} = 1, n_4 = 2, n_3 = 2, n_i = 0, i \neq 3, 4, 10$; (32) $n_9 = 2, n_5 = 1, n_3 = 1, n_i = 0, i \neq 3, 5, 9$; (33) $n_9 = 2, n_4 = 2, n_i = 0, i \neq 4, 9$; (34) $n_9 = 1, n_6 = 1, n_3 = 3, n_i = 0, i \neq 3, 6, 9$; (35) $n_9 = 1, n_5 = 1, n_4 = 1, n_3 = 2, n_i = 0, i \neq 3, 4, 5, 9$; (36) $n_9 = 1, n_4 = 3, n_3 = 1, n_i = 0, i \neq 3, 4, 9$; (37) $n_8 = 1, n_3 = 5, n_i = 0, i \neq 3, 8$; (38) $n_7 = 1, n_3 = 5, n_i = 0, i \neq 3, 7$; (39) $n_6 = 1, n_4 = 1, n_3 = 4, n_i = 0, i \neq 3, 4, 6$; (40) $n_5 = 2, n_3 = 4, n_i = 0, i \neq 3, 5$; (41) $n_5 = 1, n_4 = 2, n_3 = 1, n_i = 0, i \neq 3, 4, 5$; (42) $n_4 = 4, n_3 = 2, n_i = 0, i \neq 3, 4$; (43) $n_2 = 1, n_3 = 6, n_i = 0, i \neq 1, 8$; (44) $n_1 = 1, n_9 = 1, n_3 = 4, n_i = 0, i \neq 1, 3, 9$; (45) $n_1 = 1, n_2 = 1, n_3 = 5, n_i = 0, i \neq 1, 2, 3$.

According to the above solutions, we can determine the structure of $\mathcal{L}^{-1}(\mathcal{E}(\mathcal{H}, M))$.

Theorem 5.3. *Let F be an extremal fullerene with $n \equiv 2 \pmod{6}$ vertices and (\mathcal{H}, M) a Clar structure of F . Then $\mathcal{L}^{-1}(\mathcal{E}(\mathcal{H}, M))$ is a plane graph with $(n+16)/3$ vertices consisting of exactly 10 quadrilaterals and the other hexagons from the following three classes of graphs.*

- (1) *Plane graphs satisfy: (i) Each has exactly two vertices of degree 5 and the other vertices of degree 3, (ii) Each vertex of degree 5 is incident with at least 4 quadrilaterals, and (iii) Each partite set contains one vertex of degree 5.*

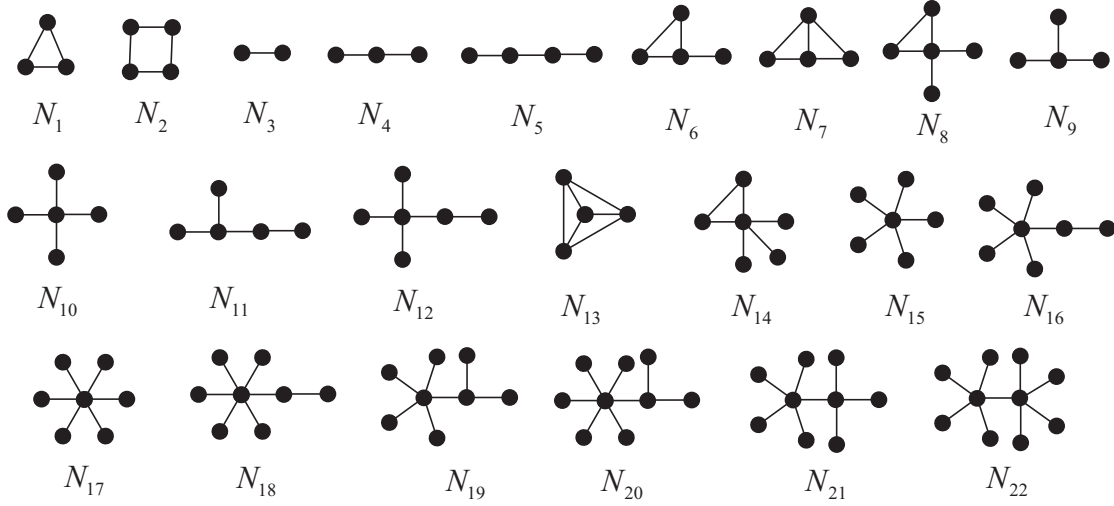

Figure 9. All possible components of the M -associated graph of an extremal fullerene with $n \equiv 2 \pmod{6}$ vertices.

(2) *Plane graphs satisfy: (i) Each has exactly two vertices of degree 4, one vertex of degree 5 and the other vertices of degree 3, (ii) The unique vertex of degree 5 is incident with at least 4 quadrilaterals, and each vertex of degree 4 is incident with at least 2 quadrilaterals, and (iii) One partite set contains two vertices of degree 4 and the other partite set contains one vertex of degree 5.*

(3) *Plane graphs satisfy: (i) Each has exactly four vertices of degree 4 and the other vertices of degree 3, (ii) Each vertex of degree 4 is incident with at least 2 quadrilaterals, and (iii) Each partite set contains two vertices of degree 4.*

Proof. Consider all the 45 possible M -associated graphs corresponding to all the 45 solutions of the system of linear indeterminate equations (3). For each possible M -associated graph, $\mathcal{L}^{-1}(\mathcal{E}(\mathcal{H}, M))$ consists exactly 10 quadrilaterals and the other hexagons. For each possible M -associated graph corresponding to Solutions (3), (6), (7) and (8) of the system of linear indeterminate equations (3), $\mathcal{L}^{-1}(\mathcal{E}(\mathcal{H}, M))$ has exactly one vertex of degree 6, one vertex of degree 4 and the other vertices of degree 3. For each possible M -associated graph corresponding to Solutions (1), (2), (11), (13) and (27) of the system of linear indeterminate equations (3), $\mathcal{L}^{-1}(\mathcal{E}(\mathcal{H}, M))$ has exactly two vertices of degree 5 and other vertices of degree 3. For each possible M -associated graph corresponding to Solutions (4), (5), (9), (10), (12), (14), (15), (16), (17), (19), (20), (22), (28), (29), (30), (31) and (37) of the system of linear indeterminate equations (3), $\mathcal{L}^{-1}(\mathcal{E}(\mathcal{H}, M))$ has exactly one vertex of degree 5, two vertices of degree 4 and the other vertices of degree 3. For each possible M -associated graph corresponding to the other solutions of the system of linear indeterminate equations (3),

$\mathcal{L}^{-1}(\mathcal{E}(\mathcal{H}, M))$ has exactly four vertices of degree 4 and the other vertices of degree 3.

We proceed to conclude this theorem by proving the following four claims. Since all graphs discussed in these claims are connected plane graphs having only faces of even degree, such graphs are bipartite and have the unique bipartition (A, B) .

Claim 1. There is no plane graph satisfying (1) It has exactly one vertex of degree 6, one vertex of degree 4 and the other vertices of degree 3, and (2) It consists exactly 10 quadrilaterals and the other hexagons.

Suppose $G = (A, B)$ is a desired plane graph. Without loss of generality, we may assume that the unique 4-degree vertex is contained in A . Then $|\nabla(A)| \equiv 1 \pmod{3}$, but $|\nabla(B)| \equiv 0 \pmod{3}$, a contradiction. This proves Claim 1.

Claim 2. Suppose G is a plane graph satisfying (1) It has two vertices of degree 5 and the other vertices of degree 3, and (2) It consists exactly 10 quadrilaterals and the other hexagons. Then each partite set of G contains one vertex of degree 5.

Suppose to the contrary that two 5-degree vertices are contained in the same partite set, say A . Then $|\nabla(A)| \equiv 2 \pmod{3}$, but $|\nabla(B)| \equiv 0 \pmod{3}$, a contradiction. This proves Claim 2.

Claim 3. Suppose G is a plane graph satisfying (1) It has exactly two vertices of degree 4, one vertex of degree 5 and the other vertices of degree 3, and (2) It consists exactly 10 quadrilaterals and the other hexagons. Then one partite set of G contains two vertices of degree 4 and the other partite set of G contains one vertex of degree 5.

Suppose to the contrary that each partite set of G contains one vertex of degree 4. Without loss of generality, we may assume that the unique vertex of degree 5 is contained in A . Then $|\nabla(A)| \equiv 0 \pmod{3}$, but $|\nabla(B)| \equiv 1 \pmod{3}$, a contradiction. This proves Claim 3.

Claim 4. Suppose G is a plane graph satisfying (1) It has exactly 4 vertices of degree 4 and the other vertices of degree 3, and (2) It consists exactly 10 quadrilaterals and the other hexagons. Then each partite set of G contains two vertices of degree 4.

Suppose to the contrary that one partite set of G , say A , contains one vertex of degree 4 and the other partite set B contains three vertices of degree 4 or one partite set of G , say A , contains no vertex of degree 4 and the other partite set B contains four vertices of degree 4. If A contains one vertex of degree 4 and B contains three 4-degree vertices, then $|\nabla(A)| \equiv 1 \pmod{3}$, but $|\nabla(B)| \equiv 0 \pmod{3}$, a contradiction. If A contains no vertex of degree 4 and B contains four vertices of degree 4, then $|\nabla(A)| \equiv 0 \pmod{3}$, but $|\nabla(B)| \equiv 1 \pmod{3}$, a contradiction. This proves Claim 4. \square

By the proof of Theorem 5.3, for an extremal fullerene F with $n \equiv 2 \pmod{6}$ vertices and a Clar structure (\mathcal{H}, M) of F , the M -associated graph is one of the graphs corresponding to the Solutions (11), (12), (13), (14), (15), (16), (21), (22), (23), (24), (25), (26), (27),

(28), (29), (30), (31), (32), (33), (35), (36), (40), (41) and (42) of the system of linear indeterminate equations (3). Hence only N_3 , N_4 , N_5 , N_9 , N_{10} , N_{11} and N_{12} may serve as components of the M -associated graph.

Let G be a plane graph from the three classes of graphs in Theorem 5.3. We want to determine the conditions under which G can be changed into an extremal fullerene. It can be easily seen that $\mathcal{L}(G)$ is a trivalent plane graph satisfying (i') It consists 10 quadrilaterals, and the others decagons, octagons and hexagons, (ii') All quadrilaterals lie in the same perfect Clar structure, and (iii') Each decagon is adjacent to at least four quadrilaterals, and each octagon is adjacent to at least two quadrilaterals. For each quadrilateral, we select a pair of opposite edges and contract it into an edge. Clearly, the resulting graph is trivalent. Analogous to the discussion immediately before Theorem 4.3, in order to make the resulting graph be a fullerene, we should select four or five pair of opposite edges exiting any octagon and two or three pair of opposite edges exiting any octagon. We can contract $\mathcal{L}(G)$ into an extremal fullerene exactly when a generalized diagonalization of G is possible. Together with Theorem 5.3, we have the following graph-theoretical characterization for extremal fullerenes on $6k + 2$ vertices.

Theorem 5.4. *The extremal fullerenes with $n \equiv 2 \pmod{6}$ vertices are in one-to-one correspondence with the generalized diagonalized plane graphs with $(n + 16)/3$ vertices from the three classes graphs described in Theorem 5.3.*

As two examples, two generalized diagonalized plane graphs in Figure 10 correspond to two experimentally produced extremal fullerenes $C_{80}:1 (D_5d)$, $C_{80}:2 (D_2)$.

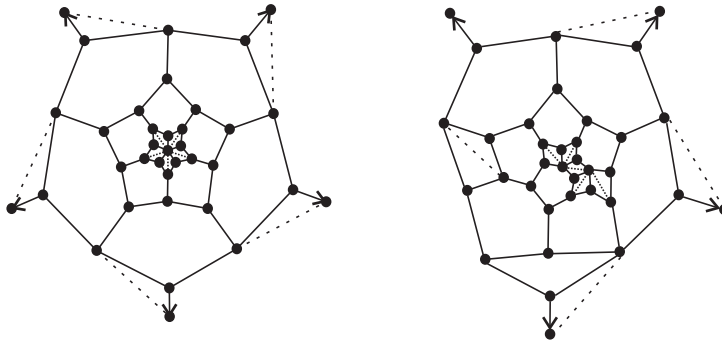

Figure 10. Two generalized diagonalized plane graphs.

6 Conclusions and further directions

Theorem 4.3 and Theorem 5.4, together with Theorem 2.3, form a complete graph-theoretical characterization of extremal fullerenes. These results reduce the problem of constructing

Table 1. The Clar numbers of the IPR fullerene isomers with 78 atoms

Isomer	Clar number
$C_{78} : 1 (D_3)$	11
$C_{78} : 2 (C_{2v})$	10
$C_{78} : 3 (C_{2v})$	9
$C_{78} : 4 (D_{3h})$	11
$C_{78} : 5 (D_{3h})$	8

extremal fullerenes with n vertices to the problem of constructing some plane graphs with about $n/3$ vertices.

Up to our knowledge, there are only two experimentally produced fullerenes, that is, $C_{78}:2 (C_{2v})$ [13, 14] and $C_{78}:3 (C_{2v})$ [14], are not extremal. Furthermore, there is only one IPR fullerene isomer $C_{78}:4 (D_{3h})$, which is not experimentally produced, having larger Clar number than these two experimentally produced fullerenes (see Table 1). However, Fowler et al. [37] predicted that $C_{78}:4 (D_{3h})$ is most stable among its all isomers. Thus Clar number performs well as a stability predictor for IPR fullerenes. Carr et al. [38] proved that the Clar number of a fullerene with n vertices is bounded below by $\lceil (n - 380)/61 \rceil$. It seems like this bound can not be attained for any fullerene. In the future work, we will intend to look for an improved lower bound for the Clar number of fullerenes whose extremal classes correspond to those “least stable” fullerenes.

References

- [1] E. Clar, The Aromatic Sextet, Wiley, London, 1972.
- [2] M. Randić, Aromaticity of polycyclic conjugated hydrocarbons, Chem. Rev. 103 (2003) 3449–3606.
- [3] R.B. King, Applications of Graph Theory and Topology in Inorganic Cluster and Coordination Chemistry, CRC Press, Boca Raton, 1993.
- [4] P. Hansen, M. Zheng, The Clar number of a benzenoid hydrocarbon and linear programming, J. Math. Chem. 15 (1994) 93–107.
- [5] H. Abeledo, G.W. Atkinson, Unimodularity of the Clar number problem, Lin. Algebra Appl. 420 (2007) 441–448.

- [6] B. Grünbaum, T. Motzkin, The number of hexagons and the simplicity of geodesics on certain polyhedra, *Can. J. Math.* 15 (1963) 744–751.
- [7] H. Zhang, D. Ye, An upper bound for Clar number of fullerene graphs, *J. Math. Chem.* 42 (2007) 123–133.
- [8] E. Hartung, Fullerenes with complete Clar structure, *Discr. Appl. Math.* 161 (2013) 2952–2957.
- [9] H. Kroto, J.R. Heath, S.C. O’Brien, R.F. Curl, R.E. Smalley, C_{60} : Buckminsterfullerene, *Nature* 318 (1985) 162–163.
- [10] R. Taylor, J. Hare, A.K. Abdul-Sada, H.W. Kroto, Isolation, separation and characterisation of the fullerenes C_{60} and C_{70} : The third form of carbon, *J. Chem. Soc. Chem. Comm.* (1990) 1423–1425.
- [11] R. Ettl, I. Chao, F. Diederich, R. Whetten, Isolation of C_{76} , a chiral (D_2) allotrope of carbon, *Nature* 353 (1991) 149–153.
- [12] R. Taylor, G.J. Langley, A.G. Avent, T.J. Dennis, H.W. Kroto, D.R.M. Walton, ^{13}C NMR spectroscopy of C_{76} , C_{78} , C_{84} and mixtures of C_{86} – C_{102} ; Anomalous chromatographic behaviour of C_{82} , and evidence for $C_{70}H_{12}$, *J. Chem. Soc. Perkin Tran. 2* (1993) 1029–1036.
- [13] F. Diederich, R.L. Whetten, C. Thilgen, R. Ettl, I. Chao, M.M. Alvarez, Fullerene isomerism: Isolation of C_{2v} - C_{78} and D_3 - C_{78} , *Science* 254 (1991) 1768–1770.
- [14] K. Kikuchi, N. Nakdhara, T. Wakabayashi, S. Suzuki, H. Shiromaru, Y. Miyake, K. Saito, I. Ikemoto, M. Kainosho, Y. Achiba, NMR characterization of isomers of C_{78} , C_{82} and C_{84} fullerenes, *Nature* 357 (1992) 142–145.
- [15] D.E. Manolopoulos, P.W. Fowler, R. Taylor, H.W. Kroto, D.R.M. Walton, Faraday communications. An end to the search for the ground state of C_{84} ?, *J. Chem. Soc. Faraday Trans. 88* (1992) 3117–3118.
- [16] P.W. Fowler, D.E. Manolopoulos, *An Atlas of Fullerenes*, Oxford University Press, Oxford, 1995.
- [17] D. Ye, H. Zhang, Extremal fullerene graphs with the maximum Clar number, *Discr. Appl. Math.* 157 (2009) 3152–3173.
- [18] H. Zhang, D. Ye, Y. Liu, A combination of Clar number and Kekulé count as an indicator of relative stability of fullerene isomers of C_{60} , *J. Math. Chem.* 48 (2010) 733–740.

- [19] P.W. Fowler, T. Heine, D. Mitchell, R. Schmidt, G. Seifert, Boron-nitrogen analogues of the fullerenes: the isolated square rule, *J. Chem. Soc. Faraday Trans.* 92 (1996) 2197–2201.
- [20] F.H. Hennrich, R. Michel, A. Fischer, S. Richard-Schneider, S. Gilb, M.M. Kappes, D. Fuchs, M. Bürk, K. Kobayashi, S. Nagase, Isolation and characterization of C_{80} , *Angew. Chem. Int. Ed. Engl.* 35 (1996) 1732–1734.
- [21] C.-R. Wang, T. Sugai, T. Kai, T. Tomiyama, H. Shinohara, Production and isolation of an ellipsoidal C_{80} fullerene, *Chem. Commun.* (2000) 557–558.
- [22] D.B. West, *Introduction to Graph Theory*, second ed., Prentice Hall, New Jersey, 2001.
- [23] P. Schwerdtfeger, L. Wirz, J. Avery, Fullerene-A software package for constructing and analyzing structures of regular fullerenes, *J. Comput. Chem.* 34 (2013) 1508–1526.
- [24] H. Zhang, F. Zhang, The Clar covering polynomial of hexagonal systems I, *Discr. Appl. Math.* 69 (1996) 147–167.
- [25] C. Godsil, G. Royle, *Algebraic Graph Theory*, Springer-Verlag, New York, 2001.
- [26] T. Pisanski, M. Randić, Bridges between geometry and graph theory, in: C.A. Gorini (Ed.), *Geometry at Work: Papers in Applied Geometry*, Vol. 53, Mathematical Association of America, Washington, DC, 2000, pp. 174–194.
- [27] P.W. Fowler, J.I. Steer, The leapfrog principle: a rule for electron counts of carbon clusters, *J. Chem. Soc., Chem. Commun.* (1987) 1403–1405.
- [28] P. Fowler, T. Pisanski, Leapfrog transformations and polyhedra of Clar type, *J. Chem. Soc. Faraday Trans.* 90 (1994) 2865–2871.
- [29] P. Fowler, Localized models and leapfrog structures of fullerenes, *J. Chem. Soc. Perkin Tran.* 2 (1992) 145–146.
- [30] H. Zhang, F. Zhang, New lower bound on the number of perfect matchings in fullerene graphs, *J. Math. Chem.* 30 (2001) 343–347.
- [31] H. Zhang, D. Ye, W.C. Shiu, Forcing matching numbers of fullerene graphs, *Discr. Appl. Math.* 158 (2010) 573–582.
- [32] D. Marušič, Hamilton cycles and paths in fullerenes, *J. Chem. Inf. Model.* 47 (2007) 732–736.

- [33] T. Došlić, Cyclical edge-connectivity of fullerene graphs and $(k, 6)$ -cages, *J. Math. Chem.* 33 (2003) 103–112.
- [34] Z. Qi, H. Zhang, A note on the cyclic number of fullerene graphs, *J. Math. Chem.* 43 (2008) 134–140.
- [35] F. Kardoš, R. Škrekovski, Cyclic edge-cuts in fullerene graphs, *J. Math. Chem.* 44 (2008) 121–132.
- [36] T. Saaty, P. Kainen, *The Four Color Problem, Assaults and Conquest*, McGraw-Hill International Book Company, New York, 1977.
- [37] P.W. Fowler, R.C. Batten, D.E. Manolopoulos, Faraday communications. The higher fullerenes: a candidate for the structure of C_{78} , *J. Chem. Soc. Faraday Trans.* 87 (1991) 3103–3104.
- [38] J.A. Carr, X. Wang, D. Ye, Packing resonant hexagons in fullerenes, *Discrete Optimization* 13 (2014) 49–54.