

THE DIRECTED GRID THEOREM

KEN-ICHI KAWARABAYASHI AND STEPHAN KREUTZER

ABSTRACT. The grid theorem, originally proved by Robertson and Seymour in Graph Minors V in 1986, is one of the most central results in the study of graph minors. It has found numerous applications in algorithmic graph structure theory, for instance in bidimensionality theory, and it is the basis for several other structure theorems developed in the graph minors project.

In the mid-90s, Reed and Johnson, Robertson, Seymour and Thomas (see [40, 26]), independently, conjectured an analogous theorem for directed graphs, i.e. the existence of a function $f : \mathbb{N} \rightarrow \mathbb{N}$ such that every digraph of directed tree-width at least $f(k)$ contains a directed grid of order k . In an unpublished manuscript from 2001, Johnson, Robertson, Seymour and Thomas gave a proof of this conjecture for planar digraphs. But for over 15 years, this was the most general case proved for the Reed, Johnson, Robertson, Seymour and Thomas conjecture.

In this paper, nearly two decades after the conjecture was made, we are finally able to confirm the Reed, Johnson, Robertson, Seymour and Thomas conjecture in full generality and to prove the directed grid theorem.

As consequence of our results we have several results using our directed grid theorem. For example, we are able to improve results in Reed et al. in 1996 [42] (see also [39]) on disjoint cycles of length at least l . We expect many more algorithmic results to follow from the grid theorem.

Ken-ichi Kawarabayashi's research is partly supported by JST ERATO Kawarabayashi Large Graph Project and by JSPS KAKENHI Grant Number JP18H05291 and JP20A402.

Stephan Kreutzer's research is partly supported by DFG Emmy-Noether Grant *Games* and by the European Research Council (ERC) under the European Union's Horizon 2020 research and innovation programme (grant agreement No 648527).

An extended abstract appeared in the Proceedings of the 47th ACM Symposium on Theory of Computing (STOC 2015). This paper also combines some proofs from [29, 31].

1. INTRODUCTION

Structural graph theory has proved to be a powerful tool for coping with computational intractability. It provides a wealth of concepts and results that can be used to design efficient algorithms for hard computational problems on specific classes of graphs occurring naturally in applications. Of particular importance is the concept of *tree-width*, introduced by Robertson and Seymour as part of their seminal graph minor series [44]¹. Graphs of small tree-width can recursively be decomposed into subgraphs of constant size which can be combined in a tree like way to yield the original graph. This property allows to use algorithmic techniques such as dynamic programming, divide and conquer etc. to solve many hard computational problems efficiently on graphs of small tree-width. In this way, a huge number of problems has been shown to become tractable, e.g. solvable in linear or polynomial time, on graph classes of bounded tree-width. See e.g. [5, 6, 7, 16] and references therein. But methods from structural graph theory, especially graph minor theory, also provide a powerful and vast toolkit of concepts and ideas to handle graphs of large tree-width and to understand their structure.

One of the most fundamental theorems in this context is the *grid theorem*, proved by Robertson and Seymour in [45]. It states that there is a function $f : \mathbb{N} \rightarrow \mathbb{N}$ such that every graph of tree-width at least $f(k)$ contains a $k \times k$ -grid as a minor. The known upper bounds on this function $f(k)$, initially being enormous, have subsequently been improved and are now polynomial [8, 9]. The grid theorem is important both for structural graph theory as well as for algorithmic applications. For instance, algorithmically it is the basis of an algorithm design principle called *bidimensionality theory*, which has been used to obtain many approximation algorithms, PTASs, subexponential algorithms and fixed-parameter algorithms on graph classes excluding a fixed minor. See [11, 12, 13, 14, 19, 18] and references therein.

Furthermore, the grid theorem also plays a key role in Robertson and Seymour's graph minor algorithm and their solution to the disjoint paths problem [47] (also see [28]) in a technique known as the *irrelevant vertex technique*. Here, a problem is solved by showing that it can be solved efficiently on graphs of small tree-width and otherwise, i.e. if the tree-width is large and therefore the graph contains a large grid, that a vertex deep in the middle of the grid is irrelevant for the problem solution and can therefore be deleted. This yields a natural recursion that eventually leads to the case of small tree-width. Such applications also appear in some other problems, see [23, 32, 28, 35].

Furthermore, with respect to graph structural aspects, the excluded grid theorem is the basis of the seminal structure and decomposition theorems in graph minor theory such as in [48].

The structural parameters and techniques discussed above all relate to undirected graphs. However, in various applications in computer science, the most natural model are directed graphs. Given the enormous success width parameters had for problems defined on undirected graphs, it is natural to ask whether they can also be used to analyse the structure of digraphs and the complexity of NP-hard problems on digraphs. In principle it is possible to apply the structure theory for undirected

¹Strictly speaking, Halin [24] came up with the same notion in 1976, but it went unnoticed until it was rediscovered by Robertson and Seymour [45] in 1984.

graphs to directed graphs by ignoring the direction of edges. However, this implies an information loss and may fail to properly distinguish between simple and hard input instances (for example, the disjoint paths problem is NP-complete for directed graphs even with only two source/terminal pairs [20], yet it is solvable in polynomial time for any fixed number of terminals for undirected graphs [28, 47]). Hence, for computational problems whose instances are digraphs, methods based on undirected graph structure theory may be less useful.

As a first step towards a structure theory specifically for directed graphs, Reed [41] and Johnson, Robertson, Seymour and Thomas [26] proposed a concept of *directed tree-width* and showed that the k -disjoint paths problem is solvable in polynomial time for any fixed k on any class of graphs of bounded directed tree-width. Reed [40] and Johnson et al. [26] also conjectured a directed analogue of the grid theorem.

Conjecture 1.1. (Reed and Johnson, Robertson, Seymour, Thomas) *There is a function $f : \mathbb{N} \rightarrow \mathbb{N}$ such that every digraph of directed tree-width at least $f(k)$ contains a cylindrical grid of order k as a butterfly minor*

Actually, according to [26], this conjecture was formulated by Robertson, Seymour and Thomas, together with Alon and Reed at a conference in Annecy, France in 1995. Here, a *cylindrical grid* consists of k concentric directed cycles and $2k$ paths connecting the cycles in alternating directions. See Figure 1 for an illustration and Definition 3.3 for details. A *butterfly minor* of a digraph G is a digraph obtained from a subgraph of G by contracting edges which are either the only outgoing edge of their tail or the only incoming edge of their head. See Definition 2.2 for details.

In an unpublished manuscript, Johnson et al. [27] proved the conjecture for planar digraphs. Very recently, we started working on this conjecture and made some progress: in [31], this result was generalised to all classes of directed graphs excluding a fixed undirected graph as an undirected minor. This includes classes of digraphs of bounded genus. Another related result was established in [29], where a half-integral directed grid theorem was proved. More precisely, it was shown that there is a function $f : \mathbb{N} \rightarrow \mathbb{N}$ such that every digraph G of directed tree-width at least $f(k)$ contains a half-integral grid of order k . Here, essentially, a *half-integral grid* in a digraph G is a cylindrical grid in the digraph obtained from G by duplicating every vertex, i.e. adding for each vertex an isomorphic copy with the same in- and out-neighbours. However, despite the conjecture being open for nearly 20 years now, no progress beyond the results mentioned before has been obtained. The main result of this paper, building on [42, 31, 29], is to finally solve this long standing open problem.

Theorem 1.2. *There is a function $f : \mathbb{N} \rightarrow \mathbb{N}$ such that every digraph of directed tree-width at least $f(k)$ contains a cylindrical grid of order k as a butterfly minor.*

We believe that this grid theorem for digraphs is a first but important step towards a more general structure theory for directed graphs based on directed tree-width, similar to the grid theorem for undirected graphs being the basis of more general structure theorems. Furthermore, it is likely that the duality of directed tree-width and directed grids will make it possible to develop algorithm design techniques such as bidimensionality theory or the irrelevant vertex technique for directed graphs. We are particularly optimistic that this approach will prove useful for algorithmic versions of Erdős-Pósa type results and in the study of the directed disjoint paths problem. The half-integral directed grid theorem in [29] has been

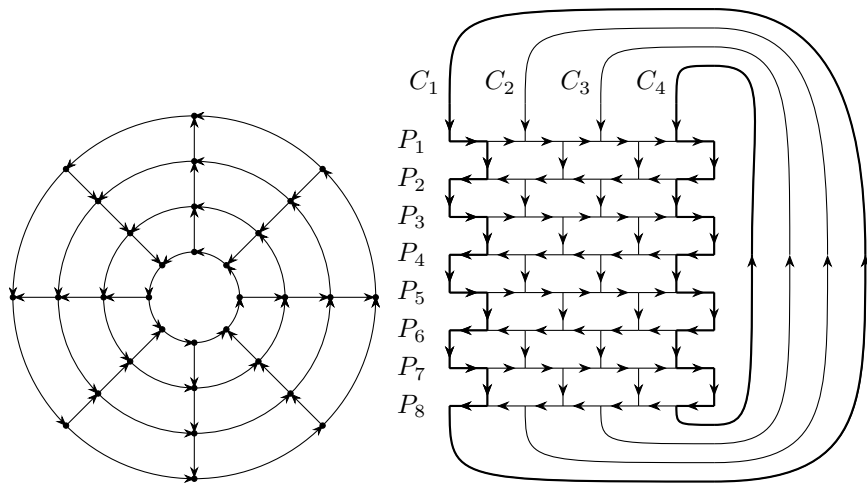

FIGURE 1. Cylindrical grid G_4 and the cylindrical wall of order 4. The perimeters of the wall are depicted using thick edges.

used to show that a variant of the quarter-integral directed disjoint paths problem can be solved in polynomial time. It is conceivable that our grid theorem here will allow us to show that the half-integral directed disjoint paths problem can be solved in polynomial time. Here, the half-integral directed disjoint paths problem is the problem to decide for a given digraph G and k pairs $(s_1, t_1), \dots, (s_k, t_k)$ of vertices whether there are directed paths P_1, \dots, P_k such that P_i links s_i to t_i and such that no vertex of G is contained in more than two paths from $\{P_1, \dots, P_k\}$. While we are optimistic that the directed grid theorem will provide the key for proving that the problem is solvable in polynomial time, this requires much more work and significant new ideas and we leave this for future work. Note that in a sense, half-integral disjoint paths are the best we can hope for, as the directed disjoint paths problem is NP-complete even for only $k = 2$ source/target pairs [20].

However, the directed grid theorem may also prove relevant for the integral directed disjoint paths problem. In a recent breakthrough, Cygan et al. [10] showed that the planar directed disjoint paths problem is fixed-parameter tractable using an irrelevant vertex technique (but based on a different type of directed grid). They show that if a planar digraph contains a grid-like subgraph of sufficient size, then one can delete a vertex in this grid without changing the solution. The bulk of the paper then analyses what happens if such a grid is not present. If one could prove a similar irrelevant vertex rule for the directed grids used in our paper, then the grid theorem would immediately yield the dual notion in terms of directed tree-width for free. The directed disjoint paths problem beyond planar graphs therefore is another prime algorithmic application we envisage for directed grids.

Since the first version of this paper appeared in STOC'15, building on our directed grid theorem, much progress has been made with respect to directed structure results and with respect to algorithmic applications (including the half disjoint paths problem). In the conclusion section at the end of this paper, we give several results that build on our directed grid theorem, including the directed

flat wall theorem and the tangle-tree theorem, using the directed grid theorem. Moreover, we also made progress towards the half disjoint paths problem.

Another obvious application of our result is to Erdős-Pósa type results such as Younger’s conjecture proved by Reed et al. in 1996 [42]. In fact, in their proof of Younger’s conjecture, Reed et al. construct a version of a directed grid. This technique was indeed a primary motivation for considering directed tree-width and a directed grid minor as a proof of the directed grid conjecture would yield a simple proof for Younger’s conjecture. In fact our grid theorem implies the following stronger result than Reed et al. in 1996 [42] (see also [39]): for every ℓ and every integer $n \geq 0$, there exists an integer $t_n = t_n(\ell)$ such that for every digraph G , either G has n pairwise vertex disjoint directed cycles of length at least ℓ or there exists a set T of at most t_n vertices such that $G - T$ has no directed cycle of length at least ℓ . Namely, we can also impose the condition on the length of directed cycles, while the proof of Reed et al. does not imply this statement.

The undirected version was proved by Birmelé, Bondy and Reed [4], and very recently, Havet and Maia [25] proved the case $\ell = 3$ for directed graphs.

Organisation and high level overview of the proof structure. In Section 3, we state our main result and present relevant definitions. In Sections 4 to 6, then, we present the proof of our main result.

At a very high level, the proof works as follows. It was already shown in [41] that if a digraph G has high directed tree-width, it contains a *directed bramble* of very high order (see Section 3). From this bramble one either gets a subdivision of a suitable form of a directed clique, which contains the cylindrical grid as butterfly minor, or one can construct a structure that we call a *web* (see Definition 5.13).

Our main technical contributions of this paper are in Sections 5 and 6. In Section 5 we show that this web can be ordered and rerouted to obtain a nicer version of a web called a *fence*. Actually, we need a much stronger property for this fence. Let us observe that a fence is essentially a cylindrical grid with one edge of each cycle deleted. In Section 5, we also prove that there is a linkage from the bottom of the fence back to its top (in addition, we require some other properties that are too technical to state here).

Hence, in order to obtain a cylindrical grid, all that is needed is to find such a linkage that is disjoint from (a sub-fence of) the fence. The biggest problem here is that the linkage from the bottom of the fence back to its top can go anywhere in the fence. Therefore, we cannot get a sub-fence that is disjoint from this linkage. This means that we have to create a cylindrical grid from this linkage, together with some portion of the fence. This, however, is by far the most difficult part of the proof, which we present in Section 6.

Let us mention that our proof is constructive in the sense that we can obtain the following theorem, which may be of independent interest.

Theorem 1.3. *There is a function $g : \mathbb{N} \rightarrow \mathbb{N}$ such that given any directed graph and any fixed constant k , in polynomial time, we can obtain either*

- (1) a cylindrical grid of order k as a butterfly minor, or
- (2) a directed tree decomposition of width at most $g(k)$.

Note that the second conclusion follows from the result in [27], which says that for fixed l , there is a polynomial time algorithm² to construct a directed tree decomposition of a given directed graph G of width $3l$, if G has directed tree-width at most l . So for Theorem 1.3, if we set $g(k) = 3 \cdot f(k)$, where $f(k)$ is the function of Theorem 1.2, then if the directed tree-width of a given directed graph is at least $f(k)$, we obtain the first conclusion from the constructive proof of Theorem 1.2. Otherwise, we obtain the second conclusion by the result in [27].

Acknowledgement. We would like to thank Julia Chuzhoy as well as an anonymous STOC referee for reading an earlier full version of this paper, and suggesting useful improvements for the presentation. Moreover, we would like to thank the referee who pointed out many small mistakes. The referee’s patience leads to much better shape of this paper.

2. PRELIMINARIES

In this section we fix our notation and briefly review relevant concepts from graph theory. We refer to, e.g., [15] for background. For any $n \in \mathbb{N}$ we define $[n] := \{1, \dots, n\}$. For any set U and $k \in \mathbb{N}$ we define $[U]^{\leq k} := \{X \subseteq U : |X| \leq k\}$. We define $[U]^{-k}$ etc. analogously. We write 2^U for the power set of U .

2.1. Background from graph theory. Let G be a digraph. We refer to its vertex set by $V(G)$ and its edge set by $E(G)$. If $(u, v) \in E(G)$ is an edge then u is its *tail* and v its *head*. Unless stated explicitly otherwise, all paths in this paper are directed. We therefore simply write *path* for *directed path*.

Notation 2.1. *The following non-standard notation will be used frequently throughout the paper. If Q_1 and Q_2 are paths and e is an edge whose tail is the last vertex of Q_1 and whose head is the first vertex of Q_2 then Q_1eQ_2 is the path $Q = Q_1 + e + Q_2$ obtained from concatenating e and Q_2 to Q_1 . We will usually use this notation in reverse direction and, given a path Q and an edge $e \in E(Q)$, write “Let Q_1 and Q_2 be subpaths of Q such that $Q = Q_1eQ_2$.” Hereby we define the subpath Q_1 to be the initial subpath of Q up to the tail of e and Q_2 to be the suffix of Q starting at the head of e .*

In this paper we will work with a version of directed minors known as *butterfly minors* (see [26]).

Definition 2.2 (butterfly minor). *Let G be a digraph. An edge $e = (u, v) \in E(G)$ is butterfly-contractible if e is the only outgoing edge of u or the only incoming edge of v . In this case the graph $G^!$ obtained from G by butterfly-contracting e is the graph with vertex set $(V(G) - \{u, v\}) \cup \{x_{u,v}\}$, where $x_{u,v}$ is a fresh vertex. The edges of $G^!$ are the same as the edges of G except for the edges incident with u or v . Instead, the new vertex $x_{u,v}$ has the same neighbours as u and v , eliminating parallel edges. A digraph H is a butterfly-minor of G if it can be obtained from a subgraph of G by butterfly contraction.*

See Figure 2 for an illustration of butterfly contractions. We illustrate butterfly-contractions by the following example, which will be used frequently in the paper.

²actually, the time complexity is $f(k)n^c$ for some absolute constant c that does not depend on k

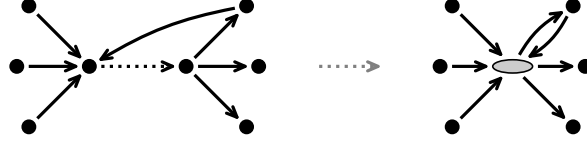

FIGURE 2. Butterfly contracting the dotted edge in the digraph on the left.

Example 2.3. Let G be a digraph. Let $P = P_1 e P_2$ be a directed path in G consisting of two subpaths P_1, P_2 joined by an edge e with tail in P_1 and head in P_2 . If every edge in $E(G) \setminus E(P)$ incident to a vertex $v \in V(P_1)$ has v as its head and every edge in $E(G) \setminus E(P)$ incident to a vertex $u \in (P_2)$ has u as its tail then P can be butterfly-contracted into a single vertex, as then every edge in $E(P_1)$ is the only outgoing edge of its tail and every edge in $E(P_2) \cup \{e\}$ is the only incoming edge of its head.

We will also use the well-known concept of subdivisions.

Definition 2.4 (subdivision). Let G be a digraph. A digraph H is a subdivision of G if H can be obtained from G by replacing a set $\{e_1, \dots, e_k\} \subseteq E(G)$ of edges by directed paths P_1, \dots, P_k such that if $e_i = (u, v)$ then P_i links u to v and P_i is internally vertex disjoint from $G \cup \bigcup\{P_j : i \neq j\}$.

Definition 2.5 (intersection graph). Let \mathcal{P} and \mathcal{Q} be sets of pairwise disjoint paths in a digraph G . The intersection graph $\mathcal{I}(\mathcal{P}, \mathcal{Q})$ of \mathcal{P} and \mathcal{Q} is the bipartite (undirected) graph with vertex set $\mathcal{P} \cup \mathcal{Q}$ and an edge between $P \in \mathcal{P}$ and $Q \in \mathcal{Q}$ if $P \cap Q \neq \emptyset$.

We will also frequently use Ramsey's theorem (see e.g.[15]).

Theorem 2.6 (Ramsey's Theorem). For all integers $q, l, r \geq 1$, there exists a (minimum) integer $R_l(r, q) \geq 0$ so that if Z is a set with $|Z| \geq R_l(r, q)$, Q is a set of q colours and $h : [Z]^l \rightarrow Q$ is a function assigning a colour from Q to every l -element subset of Z then there exist $T \subseteq Z$ with $|T| = r$ and $x \in Q$ so that $h(X) = x$ for all $X \in [T]^l$.

We will also need the following lemmas adapted from [38]. By K_s , for some $s \geq 1$, we denote the (up to isomorphism) complete graph on s vertices.

Lemma 2.7. For all integers $n, k \geq 0$, if $G := K_{n, (2k+1)}$ and $\gamma : V(G) \rightarrow [V(G)]^{\leq k}$ such that $v \notin \gamma(v)$ for all $v \in V(G)$ then there is $H \cong K_n \subseteq G$ such that $\gamma(v) \cap V(H) = \emptyset$ for all $v \in V(H)$.

Proof. We construct the following auxiliary graph A : $V(A) = V(G)$ and for all $v \in V(A)$ we add an edge $\{v, u\}$ for every $u \in \gamma(v)$. By construction, for every $S \subseteq V(A)$, the subgraph $A[S]$ contains at most $|S| \cdot k$ edges and therefore contains a vertex of degree at most $2k$. In other words, A is $2k$ -degenerate.

As $|V(A)| = n(2k+1)$, A contains an independent set $I \subseteq V(A)$ of size n and $H := G[I]$ satisfies the condition of the lemma. \square

Lemma 2.8. There is a computable function $f_{\text{clique}} : \mathbb{N} \times \mathbb{N} \rightarrow \mathbb{N}$ such that for all $n, k \geq 0$, if $G := K_{f_{\text{clique}}(n, k)}$ and $\gamma : E(G) \rightarrow [V(G)]^{\leq k}$ such that $\gamma(e) \cap e = \emptyset$

for all $e \in E(G)$ then there is $H \cong K_n \subseteq G$ such that $\gamma(e) \cap V(H) = \emptyset$ for all $e \in E(H)$.

Proof. Let $R(n) := R_2(n, 2)$ denote the n -th Ramsey number as defined above. We define the function f_{clique} inductively as follows. For all $n \geq 0$ let $f_{\text{clique}}(n, 0) := n$ and for $k > 0$ let

$$f_{\text{clique}}(n, k) := (k + 1) \cdot R(\max\{f_{\text{clique}}(n, k - 1), f_{\text{clique}}(n - 1, k)\}) + 1.$$

We prove the lemma by induction on k . For $k = 0$ there is nothing to show. So let $k > 0$. Choose a vertex $v \in V(G)$. For each $u \in V(G) \setminus \{v\}$ let $\eta(u) := \gamma(v, u)$. By assumption, $u \notin \eta(u)$ and thus, as $|V(G)| \geq (k + 1) \cdot R(\max\{f_{\text{clique}}(n, k - 1), f_{\text{clique}}(n - 1, k)\}) + 1$, we can apply Lemma 2.7 to $G - v$ and η to obtain a set $U \subseteq V(G) \setminus \{v\}$ of order $R(\max\{f_{\text{clique}}(n, k - 1), f_{\text{clique}}(n - 1, k)\})$ such that $U \cap \gamma(\{v, u\}) = \emptyset$ for all $u \in U$.

Let $G_v := G[U]$, the subgraph of G induced by U . We colour an edge e in G_v by v if $v \in \gamma(e)$ and by \bar{v} otherwise. Let $l := \max\{f_{\text{clique}}(n, k - 1), f_{\text{clique}}(n - 1, k)\}$. By Ramsey's theorem, as $|G_v| = R(l)$ there is a set $X \subseteq V(G_v)$ of size l such that all edges between elements of X are coloured v or there is such a set where all edges are coloured \bar{v} .

In the first case, let G' be the subgraph of G_v induced by X and let $\gamma'(e) := \gamma(e) \setminus \{v\}$, for all edges $e \in E(G')$. Then, $|\gamma'(e)| \leq k - 1$ for all $e \in E(G')$ and as $|X| \geq f_{\text{clique}}(n, k - 1)$, we can apply the induction hypothesis to find the desired clique $H \cong K_n$ in G' .

So suppose X induces a subgraph where all edges are labelled by \bar{v} . Let $G' := G[X]$ and $\gamma'(e) := \gamma(e)$ for all $e \in E[G']$. As $|G'| \geq f_{\text{clique}}(n - 1, k)$, by the induction hypothesis, G' contains a subgraph $H' \cong K_{n-1}$ such that $\gamma(e) \cap (V(H') \cup \{v\}) = \emptyset$ for all $e \in E(H')$. Furthermore, $(V(H') \cup \{v\}) \cap \gamma(\{v, u\}) = \emptyset$ for all $u \in V(H')$. Hence, $H := G[V(H') \cup \{v\}]$ is the required subgraph of G isomorphic to K_n with $\gamma(e) \cap V(H) = \emptyset$ for all $e \in E(H)$. \square

We also need the next result by Erdős and Szekeres [17].

Theorem 2.9 (Erdős and Szekeres' Theorem). *Let s, t be integers and let $n = (s - 1)(t - 1) + 1$. Let a_1, \dots, a_n be distinct integers. Then there exist $1 \leq i_1 < \dots < i_s \leq n$ such that $a_{i_1} < \dots < a_{i_s}$ or there exist $1 \leq i_1 < \dots < i_t \leq n$ such that $a_{i_1} > \dots > a_{i_t}$.*

2.2. Linkages, Separations, Half-Integral and Minimal Linkages. A *linkage* \mathcal{P} is a set of mutually vertex-disjoint directed paths in a digraph. For two vertex sets Z_1 and Z_2 , \mathcal{P} is a Z_1 - Z_2 *linkage* if each member of \mathcal{P} is a directed path from a vertex in Z_1 to a vertex in Z_2 . The *order* of the linkage, denoted by $|\mathcal{P}|$, is the number of paths. We write $\bigcup \mathcal{P}$ for the subgraph consisting of the paths in \mathcal{P} . Furthermore, we define $V(\mathcal{P}) := \bigcup \{V(P) : P \in \mathcal{P}\}$ and $E(\mathcal{P}) := \bigcup \{E(P) : P \in \mathcal{P}\}$.

Definition 2.10 (well-linked sets). *Let G be a digraph and $A \subseteq V(G)$. A is well-linked, if for all $X, Y \subseteq A$ with $|X| = |Y| = r$ there is an X - Y -linkage of order r .*

A separation (A, B) in an undirected graph is a pair $A, B \subseteq G$ such that $G = A \cup B$. The order is $|V(A \cap B)|$. A *separation* in a directed graph G is an ordered pair (X, Y) of subsets of $V(G)$ with $X \cup Y = V(G)$ so that no edge has its tail in $X \setminus Y$ and its head in $Y \setminus X$. The *order* of (X, Y) is $|X \cap Y|$. We shall frequently need the following version of Menger's theorem.

Theorem 2.11 (Menger's Theorem). *Let $G = (V, E)$ be a digraph with $A, B \subseteq V$ and let $k \geq 0$ be an integer. Then exactly one of the following holds:*

- *there is a linkage from A to B of order k or*
- *there is a separation (X, Y) of G of order less than k with $A \subseteq X$ and $B \subseteq Y$.*

Let $A, B \subseteq V(G)$. A *half-integral A - B linkage of order k* in a digraph G is a set \mathcal{P} of k A - B -paths such that no vertex of G is contained in more than two paths in \mathcal{P} . The next lemma collects simple facts about half-integral linkages which are needed below.

Lemma 2.12. *Let G be a digraph and $A, B, C \subseteq V(G)$.*

- (1) *If G contains a half-integral A - B linkage of order k then G contains an A - B -linkage of order $\frac{k}{2}$.*
- (2) *If $|B| = k$ and G contains an A - B -linkage \mathcal{L} of order k and a B - C -linkage \mathcal{L}' of order k then G contains an A - C -linkage of order $\frac{k}{2}$.*

Proof. Part (2) follows immediately from Part (1) as \mathcal{L} and \mathcal{L}' can be combined to a half-integral A - C -linkage (this follows as $|B| = k$ and therefore the endpoints of \mathcal{L} and \mathcal{L}' in B coincide).

For Part (1), suppose towards a contradiction that G does not contain an A - B -linkage of order $\frac{k}{2}$. Hence, by Menger's theorem, there is a separation (X, Y) of G of order $< \frac{k}{2}$ such that $A \subseteq X$ and $B \subseteq Y$. But then there cannot be a half-integral A - B -linkage of order k as every vertex in $X \cap Y$ can only be used twice. \square

We now define *minimal linkages*, which play an important role in our proof.

Definition 2.13 (minimal linkages). *Let G be a digraph and let $H \subseteq G$ be a subgraph. Let \mathcal{L} be a linkage of order k , for some $k \geq 1$, and let C be the set of start vertices of \mathcal{L} and D be the set of endpoints. \mathcal{L} is minimal with respect to H , or H -minimal, if for all edges $e \in \bigcup_{P \in \mathcal{L}} E(P) \setminus E(H)$ there is no C - D -linkage of order k in the graph $(\mathcal{L} \cup H) - e$.*

If \mathcal{P} and \mathcal{L} are linkages then we simply say that \mathcal{L} is \mathcal{P} -minimal, instead of \mathcal{L} being $\bigcup \mathcal{P}$ -minimal. The following lemma will be used later on.

Lemma 2.14. *Let G be a digraph. Let \mathcal{P} be a linkage and let \mathcal{L} be a linkage such that \mathcal{L} is \mathcal{P} -minimal. Then \mathcal{L} is \mathcal{P}' -minimal for every $\mathcal{P}' \subseteq \mathcal{P}$.*

Proof. It suffices to show the lemma for the case where $\mathcal{P}' = \mathcal{P} \setminus \{P\}$ for some path P . The general case then follows by induction.

Suppose \mathcal{L} is not \mathcal{P}' -minimal. Let A and B be the set of start and end vertices of the paths in \mathcal{L} , respectively. Hence, there is an edge $e \in E(\mathcal{L}) \setminus E(\mathcal{P}')$ such that there is an A - B -linkage \mathcal{L}' of order k in $(\mathcal{P}' \cup \mathcal{L}) - e$. Clearly, this edge has to be in $E(P) \cap E(\mathcal{L})$ as it would otherwise violate the minimality of \mathcal{L} with respect to \mathcal{P} .

Furthermore, \mathcal{L}' must use every edge in $E(\mathcal{L}) \setminus E(\mathcal{P})$ as again it would otherwise violate the \mathcal{P} -minimality of \mathcal{L} . Let $Q \subseteq P$ be the maximum directed subpath of $P \cap \mathcal{L}$ containing e and let $s, t \in V(G)$ be its first and last vertex, respectively.

If s and t are both end vertices of paths in \mathcal{L} then this implies that $Q \in \mathcal{L}$ and no vertex of Q is adjacent in $\mathcal{L} \cup \mathcal{P}'$ to any vertex of \mathcal{P}' . Hence in $(\mathcal{L} \cup \mathcal{P}') - e$ there is no path from s to t , contradicting the choice of \mathcal{L}' .

It follows that at least one of s, t is not an endpoint of a path in \mathcal{L} . We assume that s is this vertex. The case for t is analogous. So suppose s is not an end vertex of any path in \mathcal{L} . Let e_s be the edge in $E(\mathcal{L})$ with head s . As any two paths in \mathcal{P} are pairwise vertex-disjoint, the edge e_s cannot be in $E(\mathcal{P})$.

By construction of Q , no vertex in $V(Q) \setminus \{s, t\}$ is incident to any edge in $E(\mathcal{L}) \cup E(\mathcal{P})$ other than the edges in Q . Furthermore, as explained above, e_s must be in $E(\mathcal{L}')$ as it is not in $E(\mathcal{P})$. As s is not an end vertex of a path in \mathcal{L} , and hence not an end vertex of a path in \mathcal{L}' , this implies that there must be an outgoing edge of s in \mathcal{L}' . But this must be on the path Q . Hence, \mathcal{L}' must include Q , and thus the edge e , a contradiction. \square

Note that deleting paths from \mathcal{L} can destroy minimality. I.e. if \mathcal{L} is \mathcal{P} -minimal and $\mathcal{L}' \subset \mathcal{L}$ then \mathcal{L}' may no longer be \mathcal{P} -minimal. In the rest of the paper we will mainly use the following property of minimal linkages.

Lemma 2.15. *Let G be a digraph and $H \subseteq G$ be a subgraph. Let \mathcal{L} be an H -minimal linkage between two sets A and B . Let $P \in \mathcal{L}$ be a path and let $e \in E(P) \setminus E(H)$. Let P_1, P_2 be the two components of $P - e$ such that the tail of e lies in P_1 . Then there are at most $r := |\mathcal{L}|$ pairwise vertex-disjoint paths from P_1 to P_2 in $H \cup \mathcal{L}$.*

Proof. As \mathcal{L} is H -minimal, there are no r pairwise vertex disjoint A - B paths in $(H \cup \mathcal{L}) - e$. Let S be a minimal A - B separator in $(H \cup \mathcal{L}) - e$. Hence, $|S| = r - 1$ and S contains exactly one vertex from every $P' \in \mathcal{L} \setminus \{P\}$.

Towards a contradiction, suppose there were r pairwise vertex-disjoint paths from P_1 to P_2 in $(H \cup \mathcal{L}) - e$. At most $r - 1$ of these contain a vertex from S and hence there is a P_1 - P_2 path P' in $(H \cup \mathcal{L}) - e - S$. But then $P_1 \cup P' \cup P_2$ contains an A - B path in $(H \cup \mathcal{L}) - e - S$, contradicting the fact that S is an A - B separator in $(H \cup \mathcal{L}) - e$. Hence, there are at most $r - 1$ disjoint paths from P_1 to P_2 in $(H \cup \mathcal{L}) - e$ and therefore at most r pairwise vertex-disjoint P_1 - P_2 paths in $(H \cup \mathcal{L})$. \square

3. DIRECTED TREE-WIDTH

The main result of this paper is the grid theorem for directed tree-width. Directed tree-width was introduced by Johnson, Robertson, Seymour and Thomas in 2001 [26], in the same paper the directed grid conjecture was made. See also [36] for a thorough introduction to directed tree-width and its obstructions.

Unfortunately, Adler [1] proved that there are digraphs G and butterfly minors H of G such that the directed tree-width of H is larger than the directed tree-width of G . That is, taking butterfly minors may increase the directed tree-width.

In [27], Johnson et al. proposed a slightly more general variant of directed tree-decompositions which allows for bags to be empty and proved that any directed tree-decomposition in the original sense of [26] can be converted into a directed tree-decomposition without increasing the width which allows empty bags and with the property that for every edge of the tree-decomposition the union of all bags below the edges induced a strong component of the digraph without the guard of the edge. Furthermore, the number of nodes in the tree-decomposition only grows at most quadratic. A detailed comparison of various proposed definitions of directed tree-width can be found in [34].

In this paper we essentially use the modified version of directed tree-width proposed in [27] with only a insignificant variation in our guarding condition which has no impact on the width of the decomposition but makes the guarding condition symmetric.

Unlike the original definition of directed tree-width, we will show below that the variant of directed tree-width with empty bags is closed under taking butterfly minors.

By an *arborescence* we mean a rooted tree in which every edge is oriented away from the root r_0 , i.e. an acyclic directed graph T such that T has a vertex r_0 , called the *root* of T , with the property that for every vertex $r \in V(T)$ there is a unique directed path from r_0 to r .

For $r \in V(T)$ we denote the sub-arborescence of T induced by the set of vertices in T reachable from R by T_t . In particular, r is the root of T_r .

Definition 3.1. A directed tree decomposition of a digraph G is a triple (T, β, γ) , where T is an arborescence, $\beta : V(T) \rightarrow 2^{V(G)}$ and $\gamma : E(T) \rightarrow 2^{V(G)}$ are functions such that

- (1) $\{\beta(t) : t \in V(T)\}$ is a partition of $V(G)$ into (possibly empty) sets and
- (2) if $e = (s, t) \in E(T)$ and $A = \bigcup\{\beta(t') : t' \in V(T_t)\}$ and $B = V(G) \setminus A$ then there is no closed directed walk in $G - \gamma(e)$ containing a vertex in A and a vertex in B .

For $t \in V(T)$ we define $\Gamma(t) := \beta(t) \cup \bigcup\{\gamma(e) : e \sim t\}$, where $e \sim t$ if e is incident with t , and we define $\beta(T_t) := \bigcup\{\beta(t') : t' \in V(T_t)\}$.

The width of (T, β, γ) is the least integer w such that $|\Gamma(t)| \leq w + 1$ for all $t \in V(T)$. The directed tree-width of G is the least integer w such that G has a directed tree decomposition of width w .

The sets $\beta(t)$ are called the *bags* and the sets $\gamma(e)$ are called the *guards* of the directed tree decomposition. As proved in [34], the variant of directed tree-width we use here is closed under taking butterfly minors. For convenience, we give a proof of this fact below.

Lemma 3.2. Let G be a digraph and let H be a butterfly minor of G . Then $dtw(H) \leq dtw(G)$.

Proof. It is easily seen that if H is a subdigraph of G then $dtw(H) \leq dtw(G)$. Thus it suffices to show that if $e = (u, v) \in E(G)$ is butterfly contractible and H is obtained from G by contracting e , then $dtw(H) \leq dtw(G)$.

Let $\mathcal{T} := (T, \beta, \gamma)$ be a directed tree-decomposition of G of minimal width k . Let $t_u, t_v \in V(T)$ be such that $u \in \beta(t_u)$ and $v \in \beta(t_v)$.

Suppose first that $\delta^+(u) = 1$. To simplify notation, we may assume that e is contracted onto v , that is $V(H) = V(G) \setminus \{u\}$ and $E(H) := E(G) \setminus \{e' : e' = (s, u) \in E(G) \text{ or } e' = e\} \cup \{(s, v) : (s, u) \in E(G) \text{ and } (s, v) \notin E(G)\}$.

Let $\mathcal{T}' := (T, \beta', \gamma')$ be obtained from \mathcal{T} as follows. We set $\beta'(t_u) := \beta(t_u) \setminus \{u\}$ and for all $t \in V(T) \setminus \{t_u\}$ we set $\beta'(t) := \beta(t)$. If $e \in E(T)$ is an edge with $u \in \gamma(e)$ then we define $\gamma'(e) := \gamma(e) \setminus \{u\} \cup \{v\}$, otherwise we define $\gamma'(e) := \gamma(e)$.

We claim that \mathcal{T}' is a directed tree-decomposition of H of width $\leq k$. It is easy to see that the width of \mathcal{T}' is still bounded by k .

What remains to be shown is the guarding condition. Towards this aim, let $e = (s, t) \in E(T)$ be an edge and let $W' \subseteq H$ be a closed directed walk containing a

vertex in $\bigcup\{\beta'(t') : t' \in V(T_{t'})\}$ and a vertex in $V(H) \setminus \bigcup\{\beta'(t') : t' \in V(T_{t'})\}$. We need to show that W' contains a vertex of $\gamma'(e)$.

If $W' \subseteq H$ then $V(W') \cap \gamma(e) \neq \emptyset$, as \mathcal{T} is a directed tree-decomposition. Let $x \in V(W') \cap \gamma(e)$. By construction, $x \in \gamma'(e)$ and thus $V(W') \cap \gamma'(e) \neq \emptyset$. Otherwise, W' is obtained from a walk $W \subseteq G$ by replacing a subwalk $s \rightarrow u \rightarrow v$ by the new edge $s \rightarrow v$, as v is the only out-neighbour of u in G . Let $a \in V(W') \cap \bigcup\{\beta'(t') : t' \in V(T_{t'})\}$ and $b \in V(H) \setminus \bigcup\{\beta'(t') : t' \in V(T_{t'})\}$. It follows immediately from the construction that $a \in V(W) \cap \bigcup\{\beta(t') : t' \in V(T_{t'})\}$ and $b \in V(G) \setminus \bigcup\{\beta(t') : t' \in V(T_{t'})\}$. By assumption on \mathcal{T} , $V(W) \cap \gamma(e) \neq \emptyset$. If there is $x \in V(W) \cap \gamma(e) \setminus \{u\}$ then $x \in \gamma'(e)$ and thus $V(W') \cap \gamma'(e) \neq \emptyset$. Thus we may assume that $V(W) \cap \gamma(e) = \{u\}$. But then $v \in \gamma'(e)$ and again $V(W') \cap \gamma'(e) \neq \emptyset$.

This completes the case where $\delta^+(u) = 1$. If $\delta^+(u) > 1$ then $\delta^-(v) = 1$ and we proceed in the same way as above but with the rôle of u and v exchanged. We set $\beta'(t_v) := \beta(t_v) \setminus \{v\}$ and for all $t \in V(T) \setminus \{t_v\}$ we set $\beta'(t) := \beta(t)$. If $e \in E(T)$ is an edge with $v \in \gamma(e)$ then we define $\gamma'(e) := \gamma(e) \setminus \{v\} \cup \{u\}$, otherwise we define $\gamma'(e) := \gamma(e)$. The proof that (T, β', γ') is a directed tree-decomposition of H is analogous to the case above. \square

We now recall the concept of cylindrical grids as defined in [40, 26].

Definition 3.3 (cylindrical grid). *A cylindrical grid of order k , for some $k \geq 1$, is a digraph G_k consisting of k directed cycles C_1, \dots, C_k of length $2k$, pairwise vertex disjoint, together with a set of $2k$ pairwise vertex disjoint paths P_1, \dots, P_{2k} of length $k - 1$ such that*

- each path P_i has exactly one vertex in common with each cycle C_j and both endpoints of P_i are in $V(C_1) \cup V(C_k)$
- the paths P_1, \dots, P_{2k} appear on each C_i in this order and
- for odd i the cycles C_1, \dots, C_k occur on all P_i in this order and for even i they occur in reverse order C_k, \dots, C_1 .

See Figure 1 for an illustration of G_4 .

Definition 3.4. *Let us define an elementary cylindrical wall W_k of order k to be the digraph obtained from the cylindrical grid G_k by replacing every vertex v of degree 4 in G_k by two new vertices v_s, v_t connected by an edge (v_s, v_t) such that v_s has the same in-neighbours as v and v_t has the same out-neighbours as v .*

A cylindrical wall of order k is a subdivision of W_k . Clearly, every cylindrical wall of order k contains a cylindrical grid of order k as a butterfly minor. Conversely, a cylindrical grid of order k contains a cylindrical wall of order $\frac{k}{2}$ as subgraph.

Again, see Figure 1 for an illustration. What we actually show in this paper is that every digraph of large directed tree-width contains a cylindrical wall of high order as subgraph.

Directed tree-width has a natural duality, or obstruction, in terms of directed brambles (see [40, 41]).

Definition 3.5. *Let G be a digraph. A bramble in G is a set \mathcal{B} of strongly connected subgraphs $B \subseteq G$ such that if $B, B' \in \mathcal{B}$ then $B \cap B' \neq \emptyset$.*

A cover of \mathcal{B} is a set $X \subseteq V(G)$ of vertices such that $V(B) \cap X \neq \emptyset$ for all $B \in \mathcal{B}$. Finally, the order of a bramble is the minimum size of a cover of \mathcal{B} . The bramble number $\text{bn}(G)$ of G is the maximum order of a bramble in G .

Our definition here differs slightly from the definition in [41] where it is allowed for two bramble elements B and B' to be disjoint as long as there are edges linking B and B' both ways. Again this definition has the problem of not being closed under taking butterfly minors whereas our definition above is easily seen to be closed under taking butterfly minors. It is not hard to see that if G has a bramble of order $2k + 1$ with respect to the definition in [41] then it has a bramble of order k in our definition (and clearly any bramble with respect to our definition is a bramble as defined in [41]).

The next lemma is mentioned in [41] and can be proved by converting brambles into havens and back using [26, (3.2)]. See also [36] for a proof.

Lemma 3.6. *There are constants c, c' such that for all digraphs G , $\text{bn}(G) \leq c \cdot \text{dtw}(G) \leq c' \cdot \text{bn}(G)$.*

Using this lemma we can state our main theorem equivalently as follows, which is the result we prove in this paper.

Theorem 3.7. *There is a computable function $f : \mathbb{N} \rightarrow \mathbb{N}$ such that for all digraphs G and all $k \in \mathbb{N}$, if G contains a bramble of order at least $f(k)$ then G contains a cylindrical grid of order k as a butterfly minor.*

4. GETTING A WEB

The main objective of this section is to show that every digraph containing a bramble of high order either contains a cylindrical wall of order k or contains a structure that we call a *web*.

Definition 4.1 (*(p, q) -web*). *Let $p, q, d > 0$ be integers. A (p, q) -web $(\mathcal{P}, \mathcal{Q})$ with avoidance d in a digraph G consists of two linkages $\mathcal{P} = \{P_1, \dots, P_p\}$ and $\mathcal{Q} = \{Q_1, \dots, Q_q\}$ such that*

- (1) \mathcal{P} is an A - B linkage for two distinct vertex sets $A, B \subseteq V(G)$ and \mathcal{Q} is a C - D linkage for two distinct vertex sets $C, D \subseteq V(G)$,
- (2) for $1 \leq i \leq q$, Q_i intersects all but at most $\frac{1}{d} \cdot p$ paths in \mathcal{P} and
- (3) \mathcal{P} is \mathcal{Q} -minimal.

We say that $(\mathcal{P}, \mathcal{Q})$ has avoidance $d = 0$ if Q_i intersects every path in \mathcal{P} , for all $1 \leq i \leq q$.

The set $C \cap V(\mathcal{Q})$ is called the *top* of the web, denoted $\text{top}((\mathcal{P}, \mathcal{Q}))$, and $D \cap V(\mathcal{Q})$ is the *bottom* $\text{bot}((\mathcal{P}, \mathcal{Q}))$. The web $(\mathcal{P}, \mathcal{Q})$ is *well-linked* if $C \cup D$ is well-linked in G .

The notion of top and bottom refers to the intuition, used in the rest of the paper, that the paths in \mathcal{Q} are thought of as *vertical* paths and the paths in \mathcal{P} as *horizontal*. In this section we will prove the following theorem.

Theorem 4.2. *For every $k, p, l, c \geq 1$ there is an integer l' such that the following holds. Let G be a digraph of bramble number at least l' . Then G contains a cylindrical grid of order k as a butterfly minor or a $(p', l \cdot p')$ -web with avoidance c , for some $p' \geq p$, such that the top and the bottom of the web are subsets of a well-linked set $A \subseteq V(G)$.*

The starting point for proving the theorem are brambles of high order in directed graphs. In the first step we adapt an approach developed in [31], based on [43], to our setting.

Lemma 4.3. *Let G be a digraph and \mathcal{B} be a bramble in G . Then there is a path $P := P(\mathcal{B})$ intersecting every $B \in \mathcal{B}$.*

Proof. We inductively construct the path P as follows. Choose a vertex $v_1 \in V(G)$ such that $v_1 \in V(B_1)$ for some $B_1 \in \mathcal{B}$ and set $P := (v_1)$. During the construction we will maintain the property that there is a bramble element $B \in \mathcal{B}$ such that the last vertex v (i.e., the endvertex) of P is the only element of P contained in B . Clearly this property is true for the path $P = (v_1)$ constructed so far.

As long as there still is an element $B \in \mathcal{B}$ such that $V(P) \cap V(B) = \emptyset$, let v be the last vertex of P and $B' \in \mathcal{B}$ be such that $P \cap B' = \{v\}$. By definition of a directed bramble, there is a path in $G[V(B \cup B')]$ from v to a vertex in B . Choose P' to be such a path so that only its endpoint is contained in B and all other vertices of P' are contained in B' . Hence, P' only shares v with P and we can therefore combine P and P' to a path ending in B to obtain the desired path. \square

Lemma 4.4. *Let G be a digraph, \mathcal{B} be a bramble of order $2k \cdot (k+1)$ and $P = P(\mathcal{B})$ be a path intersecting every $B \in \mathcal{B}$. Then there is a set $A \subseteq V(P)$ of order k which is well-linked.*

Proof. We first construct a sequence of subpaths P_1, \dots, P_{2k} of P and brambles $\mathcal{B}_1, \dots, \mathcal{B}_{2k} \subseteq \mathcal{B}$ of order $k+1$ as follows. Let P_1 be the minimal initial subpath of P such that $\mathcal{B}_1 := \{B \in \mathcal{B} : B \cap P_1 \neq \emptyset\}$ is a bramble of order $k+1$. Now suppose P_1, \dots, P_i and $\mathcal{B}_1, \dots, \mathcal{B}_i$ have already been constructed. Let v be the last vertex of P_i and let s be the successor of v on P . Let P_{i+1} be the minimal subpath of P starting at s such that

$$\mathcal{B}_{i+1} := \{B \in \mathcal{B} : B \cap \bigcup_{l \leq i} V(P_l) = \emptyset \text{ and } B \cap P_{i+1} \neq \emptyset\}$$

has order $k+1$. As long as $i < 2k$ this is always possible as \mathcal{B} has order $2k \cdot (k+1)$.

Now let P_1, \dots, P_{2k} and $\mathcal{B}_1, \dots, \mathcal{B}_{2k}$ be constructed in this way. For $1 \leq i \leq k$ let a_i be the first vertex of P_{2i} and let Q_i be the minimal subpath of P containing P_{2i-1} and P_{2i} . We define $A := \{a_1, \dots, a_k\}$.

We show next that A is well-linked. Let $X, Y \subseteq A$ be such that $|X| = |Y| = r$.

Suppose there is no linkage of order r from X to Y . By Menger's theorem (Theorem 2.11) there is a set $S \subseteq V(G)$ of order $|S| < r$ such that there is no path from X to Y in $G \setminus S$. Clearly, $X \cap Y \subseteq S$.

As $|S| < r$, by the pigeon hole principle, there are indices i and j such that $a_i \in X \setminus S$, $a_j \in Y \setminus S$ and $S \cap V(Q_i) = S \cap V(Q_j) = \emptyset$. W.l.o.g. assume $i < j$.

By construction, \mathcal{B}_{2i} and \mathcal{B}_{2j-1} are both brambles of order $k+1$ and hence S is not a hitting set of \mathcal{B}_{2i} or \mathcal{B}_{2j-1} . Hence, there are bramble elements $B \in \mathcal{B}_{2i}$ and $B' \in \mathcal{B}_{2j-1}$ such that $S \cap B = S \cap B' = \emptyset$. But as any two bramble elements of \mathcal{B} intersect this implies that there is a path in $B \cup B'$ from a vertex of $v \in V(P_{2i})$ to a vertex $w \in V(P_{2j-1})$ and hence, as a_i is the start vertex of P_{2i} and a_j is the start vertex of P_{2j} a path linking a_i to a_j avoiding S , which is a contradiction. \square

We will now define the first of various sub-structures we are guaranteed to find in digraphs of large directed tree-width.

Definition 4.5 (path system). *Let G be a digraph and let $l, p \geq 1$. An l -linked path system of order p is a sequence $\mathcal{S} := (\mathcal{P}, \mathcal{L}, \mathcal{A})$, where*

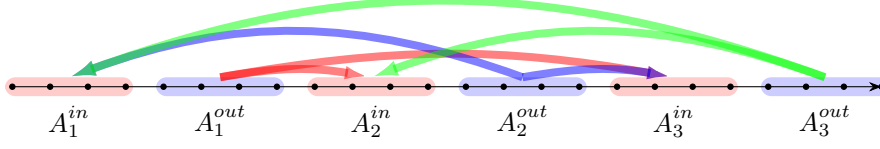

FIGURE 3. A 4-linked path system of order 3.

- $\mathcal{A} := (A_i^{in}, A_i^{out})_{1 \leq i \leq p}$ such that $A := \bigcup_{1 \leq i \leq p} A_i^{in} \cup A_i^{out} \subseteq V(G)$ is a well-linked set of order $2 \cdot l \cdot p$ and $|A_i^{in}| = |A_i^{out}| = l$, for all $1 \leq i \leq p$,
- $\mathcal{P} := (P_1, \dots, P_p)$ is a sequence of pairwise vertex disjoint paths and for all $1 \leq i \leq p$, $A_i^{in}, A_i^{out} \subseteq V(P_i)$ and all $v \in A_i^{in}$ occur on P_i before any $v' \in A_i^{out}$ and the first vertex of P_i is in A_i^{in} and the last vertex of P_i is in A_i^{out} and
- $\mathcal{L} := (L_{i,j})_{1 \leq i \neq j \leq p}$ is a sequence of linkages such that for all $1 \leq i \neq j \leq p$, $L_{i,j}$ is a linkage of order l from A_i^{out} to A_j^{in} .

The system \mathcal{S} is clean if for all $1 \leq i \neq j \leq p$ and all $Q \in L_{i,j}$, $Q \cap P_s = \emptyset$ for all $1 \leq s \leq p$ with $s \notin \{i, j\}$.

See Figure 3 for an illustration of path systems. The next lemma follows easily from Lemma 4.4.

Lemma 4.6. *Let G be a digraph and $l, p \geq 1$. There is a computable function $f_1 : \mathbb{N} \times \mathbb{N} \rightarrow \mathbb{N}$ such that if G contains a bramble of order $f_1(l, p)$ then G contains an l -linked path system \mathcal{S} of order p .*

Proof. We set $f_1(l, p) := (4 \cdot l \cdot p) \cdot (2 \cdot l \cdot p + 1)$. Let \mathcal{B} be a bramble of order at least $f_1(l, p)$. Let P be a path hitting every $B \in \mathcal{B}$ and let $A \subseteq V(P)$ be a well-linked subset of $V(P)$ with $|A| = 2 \cdot l \cdot p$ as in Lemma 4.4. Let a_1, \dots, a_{2lp} be the elements of A in the order in which they occur on P when traversing P from beginning to end.

For $1 \leq i \leq p$ let $A_i := \{a_{2l(i-1)+1}, \dots, a_{2li}\}$, $A_i^{in} := \{a_{2l(i-1)+1}, \dots, a_{2l(i-1)+l}\}$, $A_i^{out} := \{a_{2l(i-1)+l+1}, \dots, a_{2li}\}$, and let P_i be the minimal subpath of P containing the elements of A_i . The well-linkedness of A implies that for all $1 \leq i \neq j \leq p$ there is a linkage $L_{i,j}$ of order l from A_i^{out} to A_j^{in} . Thus, if we set $\mathcal{P} := (P_1, \dots, P_p)$, $\mathcal{A} := (A_i^{in}, A_i^{out})_{1 \leq i \leq p}$ and $\mathcal{L} := (L_{i,j})_{1 \leq i \neq j \leq p}$ then the triple $(\mathcal{P}, \mathcal{L}, \mathcal{A})$ satisfies the requirements of Definition 4.5 and is an l -linked path system of order p as required. \square

We now show how to construct a clean path system from a general path system.

Lemma 4.7. *Let G be a digraph. There is a computable function $f_3 : \mathbb{N}^4 \rightarrow \mathbb{N}$ such that for all integers $l, p, k, c \geq 1$, if G contains a bramble of order $f_3(l, p, k, c)$ then G contains a clean l -linked path system \mathcal{S} of order p or a well-linked $(p', k \cdot p')$ -web of avoidance c , for some $p' \geq p$.*

Proof. Let $l, p, k, c \geq 1$. For all $0 \leq i \leq p$ let $l_i := c^i \cdot l$. Let $n := p$. Furthermore, let $p_0 := p$ and for $0 < i \leq p$ let $p_i := f_{clique}((p_{i-1} + 1) \cdot (1 + 4k \cdot l_i)^{n-i}, 2k \cdot l_i)$, where

f_{clique} is the function defined in Lemma 2.8. Finally, define $f_3(l, p, k, c) := f_1(l_n, p_n)$, where f_1 is the function defined in Lemma 4.6.

Let G be a digraph containing a bramble of order $f_3(l, p, k, c)$. By Lemma 4.6, G contains an l_n -linked path system $\mathcal{S} := (\mathcal{P}, \mathcal{L}, \mathcal{A})$ of order p_n . By backwards induction on i , we define for all $0 \leq i \leq n$

- disjoint sets $\mathcal{Y}_i, \mathcal{P}_i \subseteq \mathcal{P}$ with $|\mathcal{Y}_i| = n - i$ and $|\mathcal{P}_i| = p_i$ and
- for all $P_s, P_t \in \mathcal{Y}_i \cup \mathcal{P}_i$ with $s \neq t$ a \mathcal{P}_i -minimal $A_s^{out} - A_t^{in}$ -linkage $L_{s,t}^i$ of order l_i such that no path in $L_{s,t}^i$ hits any path in $\mathcal{Y}_i \setminus \{P_s, P_t\}$.

Clearly, \mathcal{Y}_0 contains $n = p$ paths and induces a clean $l = l_0$ -linked path system of order p .

Initially, we set $\mathcal{P}_n := \mathcal{P}$ and $\mathcal{Y}_n := \emptyset$. Furthermore, for all $1 \leq i \neq j \leq p_n$, we choose a \mathcal{P} -minimal $A_i^{out} - A_j^{in}$ -linkage $L_{i,j}^n$. Clearly this satisfies the conditions above.

Now suppose $\mathcal{Y}_i, \mathcal{P}_i$ and the $L_{s,t}^i$ satisfying the conditions above have already been defined.

Step 1. We label each pair $s \neq t$ with $P_s, P_t \in \mathcal{P}_i$ by

$$\gamma(s, t) := \left\{ P \in \mathcal{P}_i : P \neq P_s, P_t \text{ and } \begin{array}{l} P \text{ hits at least } (1 - \frac{1}{c})l_i \text{ paths in } L_{s,t}^i \text{ or} \\ P \text{ hits at least } (1 - \frac{1}{c})l_i \text{ paths in } L_{t,s}^i \end{array} \right\}.$$

If there is a pair s, t such that $|\gamma(s, t)| \geq 2 \cdot k \cdot l_i$ then for at least one of $L_{s,t}^i$ or $L_{t,s}^i$, say $L_{s,t}^i$, there is a set $\gamma \subseteq \gamma(s, t)$ of order $k \cdot l_i$ such that all $P \in \gamma$ hit at least $(1 - \frac{1}{c})l_i$ paths in $L_{s,t}^i$. As by Lemma 2.14 the \mathcal{P}_i -minimal linkage $L_{s,t}^i$ is also γ -minimal, $(L_{s,t}^i, \gamma)$ form a $(l_i, k \cdot l_i)$ -web with avoidance c . This yields the second outcome of the lemma. Note that the web is well-linked as the vertical paths γ are formed by paths from \mathcal{P} and, by definition of path systems, these start and end in elements of the well-linked set A .

So suppose that all sets $\gamma(s, t)$ contain at most $2k \cdot l_i$ paths. Note that, by construction, γ is symmetric, i.e. $\gamma(s, t) = \gamma(t, s)$ for all s, t , and therefore γ defines a labelling of the clique $K_{|\mathcal{P}_i|}$ so that we can apply Lemma 2.8. As $|\mathcal{P}_i| \geq f_{clique}((p_{i-1} + 1)(1 + 4k \cdot l_i)^{n-i}, 2k \cdot l_i)$, by Lemma 2.8, there is a set $\mathcal{P}'_i \subseteq \mathcal{P}_i$ of order $(p_{i-1} + 1)(1 + 4k \cdot l_i)^{n-i}$ such that for any pair $s \neq t$ with $P_s, P_t \in \mathcal{P}'_i$ there is no path $P \in \mathcal{P}'_i \setminus \{P_s, P_t\}$ hitting $(1 - \frac{1}{c})l_i$ paths in $L_{s,t}^i$ or $L_{t,s}^i$.

So far we have found a set \mathcal{P}'_i such if $P_s \neq P_t \in \mathcal{P}'_i$ then there is no path $P \neq P_s, P_t$ hitting at least $(1 - \frac{1}{c})l_i$ paths in $L_{s,t}^i$. However, such a path P could still exist for a linkage $L_{s,t}$ or $L_{t,s}$ between a $P_s \in \mathcal{Y}_i$ and a $P_t \in \mathcal{P}'_i$. We address this problem in the second step.

Step 2. Let $(Y_1, \dots, Y_{n-i}) = \mathcal{Y}_i$ be an enumeration of all paths in \mathcal{Y}_i . For all $1 \leq s \leq n - i$ and t such that $P_t \in \mathcal{P}'_i$ let $L_{s,t}^i$ and $L_{t,s}^i$ be the linkages between Y_s and P_t as constructed above. Inductively, we will construct sets $\mathcal{Q}_j^i \subseteq \mathcal{P}'_i$, for $0 \leq j \leq n - i$, such that $|\mathcal{Q}_j^i| = (p_{i-1} + 1)(1 + 4kl_i)^{n-i-j}$ and for any $1 \leq s \leq j$ (with $j \geq 1$) and $P_t \in \mathcal{Q}_j^i$, there is no path $P \in \mathcal{Q}_j^i \setminus \{P_t\}$ such that P hits at least $(1 - \frac{1}{c})l_i$ paths in $L_{s,t}^i$ or $L_{t,s}^i$.

Let $\mathcal{Q}_0^i := \mathcal{P}_i^l$ which clearly satisfies the conditions. So suppose that \mathcal{Q}_j^i , for some $j < n - i$, has already been defined. Set $s := j + 1$. For every $P_t \in \mathcal{Q}_j^i$ define

$$\gamma(t) := \left\{ P \in \mathcal{Q}_j^i \setminus \{P_t\} : \begin{array}{l} P \text{ hits at least } (1 - \frac{1}{c})l_i \text{ paths in } L_{s,t}^i \text{ or} \\ P \text{ hits at least } (1 - \frac{1}{c})l_i \text{ paths in } L_{t,s}^i \end{array} \right\}.$$

Again, if there is a $P_t \in \mathcal{Q}_j^i$ such that $|\gamma(t)| \geq 2 \cdot k \cdot l_i$ then choose $\gamma \subseteq \gamma(t)$ of size $|\gamma| = k \cdot l_i$ such that for one of $L_{s,t}^i$ or $L_{t,s}^i$, say $L_{s,t}^i$, every $P \in \gamma$ hits at least $(1 - \frac{1}{c})l_i$ paths in $L_{s,t}^i$. Then $(\gamma, L_{s,t}^i)$ is a well-linked web as requested.

Otherwise, as $|\mathcal{Q}_j^i| = (p_{i-1} + 1)(1 + 4k \cdot l_i)^{n-i-j}$, by Lemma 2.7, there is a subset \mathcal{Q}_{j+1}^i of order $(p_{i-1} + 1)(1 + 4k \cdot l_i)^{n-i-(j+1)}$ such that for no $P_t \in \mathcal{Q}_{j+1}^i$ there is a path $P \in \mathcal{Q}_{j+1}^i \cup \mathcal{Y}_i$ hitting at least $(1 - \frac{1}{c})l_i$ paths in $L_{s,t}^i$ or $L_{t,s}^i$.

Now suppose that \mathcal{Q}_{n-i}^i has been defined. We choose a path $P_n \in \mathcal{Q}_{n-i}^i$ and set $\mathcal{Y}_{i-1} := \mathcal{Y}_i \cup \{P_n\}$, and define $\mathcal{P}_{i-1} := \mathcal{Q}_{n-i}^i \setminus \{P_n\}$. By construction, $|\mathcal{Y}_{i-1}| = n - (i - 1)$ and $|\mathcal{P}_{i-1}| = p_{i-1}$. Furthermore, for every pair $P_s, P_t \in \mathcal{Y}_{i-1} \cup \mathcal{P}_{i-1}$ there is a linkage L from A_s^{out} to A_t^{in} of order $\frac{1}{c} \cdot l_i = l_{i-1}$ such that P_n does not hit any path in L and, by induction hypothesis, neither does any $P' \in \mathcal{Y}_i$. Hence, for any such pair P_s, P_t we can choose a \mathcal{P}_{i-1} -minimal $A_s^{out} - A_t^{in}$ -linkage avoiding every path in \mathcal{Y}_{i-1} .

Hence, \mathcal{Y}_{i-1} and \mathcal{P}_{i-1} satisfy the conditions above and we can continue the induction.

If we do not get a web as the second outcome of the lemma then after p iterations we have constructed \mathcal{Y}_0 and \mathcal{P}_0 and the linkages $L_{s,t}^0$ for every $P_s, P_t \in \mathcal{Y}_0$ with $s \neq t$. Clearly, \mathcal{Y}_0 induces a clean $l = l_0$ -linked path system of order $p_0 = p$ which is the first outcome of the lemma. \square

The following lemma completes the proof of Theorem 4.2.

Lemma 4.8. *For every $k, p, l, c \geq 1$ there is an integer l' such that the following holds. Let \mathcal{S} be a clean l' -linked path system of order $3k$. Then either G contains a bidirected clique of order k as a butterfly minor or a well-linked $(p', l \cdot p')$ -web with avoidance c , for some $p' \geq p$.*

Proof. Let $K := 2 \cdot \binom{3k}{2}$. We define a function $f : [K] \rightarrow \mathbb{N}$ with $f(t) := (c \cdot K \cdot l)^{(K-t+1)} p$ and set $l' := f(1)$. For all $1 \leq t \leq K$ we define $g(t) := \frac{f(t)}{K \cdot l}$.

Let $\mathcal{S} := (\mathcal{P}, \mathcal{L}, \mathcal{A})$ be a clean l' -linked path system of order $3k$, where $\mathcal{P} := (P_1, \dots, P_{3k})$, $\mathcal{L} := (L_{i,j})_{1 \leq i \neq j \leq 3k}$ and $\mathcal{A} := (A_i^{in}, A_i^{out})_{1 \leq i \leq 3k}$. We fix an ordering of the pairs $\{(i, j) : 1 \leq i \neq j \leq 3k\}$. Let $\sigma : [K] \rightarrow \{(i, j) : 1 \leq i \neq j \leq 3k\}$ be the bijection between $[K]$ and $\{(i, j) : 1 \leq i \neq j \leq 3k\}$ induced by this ordering. We will inductively construct linkages $L_{i,j}^r$, where $r \leq K$, such that

- (1) for all $1 \leq s < r$, $L_{\sigma(s)}^r$ consists of a single path P from A_i^{out} to A_j^{in} , where $(i, j) := \sigma(s)$, and P does not share an internal vertex with any path in any L_q^r with $q \neq s$,
- (2) $|L_{\sigma(r)}^r| = f(r)$
- (3) for all $q > r$ we have $|L_{\sigma(q)}^r| = g(r) = \frac{f(r)}{K \cdot l}$, and $L_{\sigma(q)}^r$ is $L_{\sigma(r)}^r$ -minimal, and
- (4) for all $1 \leq i \neq j \leq 3k$ and all $P \in L_{\sigma^{-1}(i,j)}^{r-1}$ the path P has no vertex in common with any P_t for $t \neq i, j$.

For $r = 1$ we choose a linkage $L_{\sigma(1)}^1$ satisfying Condition 2 and 4 and for $q > 1$ we choose the other linkages as in Condition 3 and 4. Such linkages exist as \mathcal{S} is a clean path system.

Now suppose the linkages have already been defined for $r \geq 1$. Let $(i, j) := \sigma(r)$.

If there is a path $P \in L_{i,j}^r$ which, for all $q > r$, is internally disjoint to at least $\frac{1}{c} \cdot g(r)$ paths in $L_{\sigma(q)}^r$, define $L_{i,j}^{r+1} = \{P\}$. Let $(s, t) := \sigma(r+1)$ and let $L_{s,t}^{r+1}$ be an $A_s^{out} - A_t^{in}$ -linkage of order $\frac{g(r)}{c} = f(r+1)$ such that no path in $L_{s,t}^{r+1}$ has an internal vertex in $V(P) \cup \bigcup_{r' \leq r} V(L_{\sigma(r')}^r)$ and, furthermore, every path in $L_{s,t}^{r+1}$ is disjoint from all $P \in \mathcal{P} \setminus \{P_s, P_t\}$. Such a linkage exists by the choice of P .

For each $q > r+1$ and $(s', t') = \sigma(q)$ choose an $A_{s'}^{out} - A_{t'}^{in}$ -linkage L_q^{r+1} of order $g(r+1) = \frac{g(r)}{(c \cdot K \cdot l)}$ satisfying Condition (4) such that every path in it has no inner vertex in $V(P) \cup \bigcup_{r' \leq r} V(L_{\sigma(r')}^r)$ and which is $L_{s,t}^{r+1}$ -minimal. So in this case, we can construct linkages $L_{i,j}^{r+1}$ as desired.

Otherwise, for all paths $P \in L_{i,j}^r$ there are i', j' with $\sigma^{-1}(i', j') > r$ such that P hits more than $(1 - \frac{1}{c})g(r)$ paths in $L_{i',j'}^r$. As $|L_{i,j}^r| = f(r) = g(r) \cdot K \cdot l$, by the pigeon hole principle, there is a $q > r$ such that at least $\frac{f(r)}{K} = g(r) \cdot l$ paths in $L_{i,j}^r$ hit all but at most $\frac{1}{c} \cdot g(r)$ paths in $L_{\sigma(q)}^r$. Let $\mathcal{Q} \subseteq L_{i,j}^r$ be the set of such paths. As a result, $(L_{\sigma(q)}^r, \mathcal{Q})$ forms a $(g(r), \frac{f(r)}{K})$ -web with avoidance c . As $\frac{f(r)}{K} = g(r) \cdot l$ and the endpoints of the paths in \mathcal{Q} are in the well-linked set $A_i^{out} \cup A_j^{in} \subseteq A$, this case gives the second possible output of the lemma.

Hence, we may assume that the previous case never happens and eventually $r = K$. We now have paths P_1, \dots, P_{3k} and between any pair P_i, P_j with $i < j$ a path $L_{i,j}^l$ from A_i^{out} to A_j^{in} and a path $L_{j,i}^l$ from A_j^{out} to A_i^{in} . Furthermore, for all $(i, j) \neq (i', j')$ these paths are pairwise vertex disjoint except possibly at their endpoints in case they begin or end in the same path in $\{P_1, \dots, P_{3k}\}$. Furthermore, if $s \neq i, j$ then $L_{i,j}^l$ is disjoint from P_s .

By definition of path systems, A_i^{in} occurs on P_i before A_i^{out} . We would now like to use the construction in Example 2.3 to show that $\bigcup_{1 \leq i \leq 3k} P_i \cup \bigcup_{1 \leq i \neq j \leq 3k} L_{i,j}^l$ contains a bidirected clique grid of order k as a butterfly minor. However, the path $L_{i,j}^l$, which goes from A_i^{out} to A_j^{in} might have internal vertices on the subpath of P_i containing A_i^{in} or on the subpath of P_j containing A_j^{out} . Hence the example is not readily applicable.

Instead, we construct the clique as follows. Essentially, we will use three paths P_{3i-2}, P_{3i-1} , and P_{3i} to construct a single vertex of the clique minor. See Figure 4 for an illustration of the following construction.

For all $1 \leq i \leq k$, let P_{3i-2}^{in} be the maximal initial subpath of P_{3i-2} not including the start vertex of $L_{3i-2,3i-1}^l$, let P_{3i-1}^{in} be the minimal initial subpath of P_{3i-1} containing A_i^{in} and P_{3i-1}^{out} be the minimal final subpath of P_{3i-1} containing A_i^{out} . Finally, let P_{3i}^{out} be the path P_{3i} without its start vertex, which is the last vertex of $L_{3i-1,3i}^l$.

W.l.o.g. we may assume that for all $1 \leq i \neq j \leq 3k$ the path $L_{i,j}^l$ has exactly one vertex in common with P_i^{out} and exactly one vertex in common with P_j^{in} .

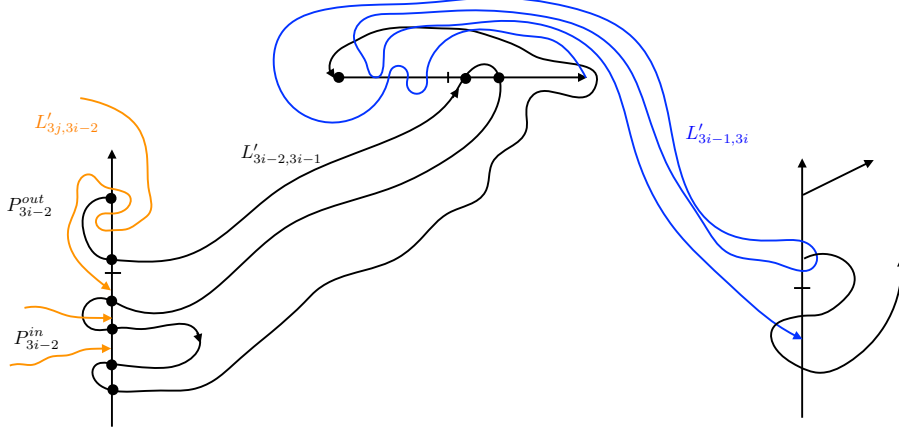

FIGURE 4. Illustration of the proof of Lemma 4.8.

For all $1 \leq i \leq k$ and $1 \leq j \neq i \leq k$ let $v_i(j)$ be the first vertex of $L'_{3j,3i-2}$ on P_{3i-2} when traversing $L'_{3j,3i-2}$ from beginning to end. We let $I_i := \{v_i(j) : 1 \leq j \neq i \leq k\} \subseteq V(P_{3i-2}^{in})$ and $O_i := \{v_j(i) : 1 \leq j \neq i \leq k\} \subseteq V(P_{3i}^{out})$.

Our goal is to use the paths $P_{3i-2}, P_{3i-1}, P_{3i}, L'_{3i-2,3i-1}$, and $L'_{3i-1,3i}$ to construct a butterfly minor with vertex set $O_i \cup I_i \cup \{r_i\}$, for some fresh vertex r_i , and an edge from every $v \in I_i$ to r_i and from r_i to every $v \in O_i$. Doing this for all $1 \leq i \leq k$ simultaneously then yields a subdivided bidirected clique on k vertices which contains the bidirected clique on k vertices as butterfly minor.

Towards this aim, let r_i be the first vertex of $L'_{3i-1,3i}$ on P_{3i-1} , when traversing P_{3i-1} from beginning to end. Let L be the final subpath of $L'_{3i-1,3i}$ starting at r_i . Let P'_{3i-1} be the initial subpath of P_{3i-1} ending in r_i and let P'_{3i-2} be the initial subpath of P_{3i-2} ending in the start vertex of $L'_{3i-2,3i-1}$. Let $H_i^1 := P'_{3i-2} \cup L'_{3i-2,3i-1} \cup P'_{3i-1}$. Finally, let H_i^2 be the digraph obtained from the union of $L \cup P_{3i}$ and for each $j \neq i$ the initial subpath of $L_{3i,3j-2}$ up to $v_j(i)$, i.e. the first vertex $L_{3i,3j-2}$ has in common with P_{3j-2} .

By construction, for all $1 \leq i \leq k$, $H_i^1 \cap H_i^2 = r_i$ and H_i^1 contains a path from every $v \in I_i$ to r_i and H_i^2 contains a path from r_i to every $v \in O_i$. Furthermore, if $j \neq i$ then $H_i^1 \cap H_j^1 = H_i^2 \cap H_j^2 = \emptyset$ and $H_i^1 \cap H_j^2$ is the unique vertex in $I_i \cap O_j$. Thus, for all $1 \leq i \leq k$, H_i^1 contains an inbranching $B_i^1 \subseteq H_i^1$ with root r_i which spans all vertices of I_i and H_i^2 contains an outbranching B_i^2 with root r_i which spans all vertices in O_i and contracting, for all $1 \leq i \leq k$, all edges of B_i^1, B_i^2 not incident with any vertex in $I_i \cup O_i$ yields a subdivided bidirected clique on k vertices as butterfly minor. Contracting the paths of length 2 between vertices r_i, r_j , $i \neq j$, yields the bidirected clique on k vertices, which is the first outcome of the lemma. \square

The previous lemma has the following simple corollary.

Corollary 4.9. *For every $k, p, l, c \geq 1$ there is an integer l' such that the following holds. Let \mathcal{S} be a clean l' -linked path system of order $6k^2$. Then either G contains a*

cylindrical grid of order k as a butterfly minor or a well-linked $(p', l \cdot p')$ -web with avoidance c , for some $p' \geq p$.

We are now ready to prove Theorem 4.2.

Proof of Theorem 4.2. Let $k, p, l, c \geq 0$ be given as in the statement of the theorem. Let l_1 be the number l' defined for k, p, l, c in Corollary 4.9. Let f be the function as defined in Lemma 4.7. Let $m := \max\{k, p\}$. We define $l' := f(l_1, m, l, c)$. By Lemma 4.7, if G contains a bramble of order l' , then G contains a clean l_1 -linked path system $(\mathcal{P}, \mathcal{L}, \mathcal{A})$ of order m or a well-linked $(p', l \cdot p')$ -web with avoidance c , for some $p' \geq m$. As $m \geq p$, the latter yields the second outcome of the theorem.

If instead we obtain the path system, then Corollary 4.9 implies that G contains a cylindrical grid of order $m \geq k$, which is the first outcome of the theorem, or a well-linked $(p', l \cdot p')$ -web with avoidance c , for some $p' \geq m \geq p$. This yields the second outcome of the theorem. \square

We close the section with a simple lemma allowing us to reduce every web to a web with avoidance 0.

Lemma 4.10. *Let p', q', d be integers and let $p \geq \frac{d}{d-1}p'$ and $q \geq q' \cdot \binom{p}{\lfloor \frac{1}{d}p \rfloor}$. If a digraph G contains a (p, q) -web $(\mathcal{P}, \mathcal{Q})$ with avoidance d then it contains a (p', q') -web with avoidance 0.*

Proof. For all $Q \in \mathcal{Q}$ let $\mathcal{A}(Q) \subseteq \mathcal{P}$ be the paths $P \in \mathcal{P}$ with $P \cap Q = \emptyset$. By definition of avoidance in webs, $|\mathcal{A}(Q)| \leq \frac{1}{d}p$. Hence, by the pigeon hole principle, there is a set $\mathcal{A} \subseteq \mathcal{P}$ and a set $\mathcal{Q}' \subseteq \mathcal{Q}$ of at least q' paths such that $\mathcal{A}(Q) = \mathcal{A}$ for all $Q \in \mathcal{Q}'$. Let $\mathcal{P}' := \mathcal{P} \setminus \mathcal{A}$. Hence, $P \cap Q \neq \emptyset$ for all $P \in \mathcal{P}'$ and $Q \in \mathcal{Q}'$. As $p \geq \frac{d}{d-1} \cdot p'$ we have $p - \frac{1}{d}p \geq p'$ and hence $|\mathcal{P}'| \geq p'$. Furthermore, \mathcal{P}' is \mathcal{Q}' -minimal. For, Lemma 2.14 implies that \mathcal{P} is \mathcal{Q}' -minimal. But \mathcal{P}' is obtained from \mathcal{P} by deleting only those paths P which have an empty intersection with every $Q \in \mathcal{Q}'$. Clearly, deleting these does not destroy minimality. Therefore, $(\mathcal{P}', \mathcal{Q}')$ contains a (p', q') -web with avoidance 0. \square

5. FROM WEBS TO FENCES

The objective of this section is to show that if a digraph contains a large well-linked web, then it also contains a big fence whose bottom and top come from a well-linked set. We give a precise definition of a fence and then state the main theorem of this section. The results obtained in this section are inspired by results in [42], which we generalise and extend. Some of the results we prove in this section are stated and proved in greater generality than actually needed in this section. We need them in full generality in Section 6 below.

Definition 5.1 (fence). *Let p, q be integers. A (p, q) -fence in a digraph G is a sequence $\mathcal{F} := (P_1, \dots, P_{2p}, Q_1, \dots, Q_q)$ with the following properties:*

- (1) P_1, \dots, P_{2p} are pairwise vertex disjoint paths of G and $\{Q_1, \dots, Q_q\}$ is an A - B -linkage for two distinct sets $A, B \subseteq V(G)$, called the top and bottom, respectively. We denote the top A by $\text{top}(\mathcal{F})$ and the bottom B by $\text{bot}(\mathcal{F})$.
- (2) For $1 \leq i \leq 2p$ and $1 \leq j \leq q$, $P_i \cap Q_j$ is a path (and therefore non-empty).
- (3) For $1 \leq j \leq q$, the paths $P_1 \cap Q_j, \dots, P_{2p} \cap Q_j$ appear in this order on Q_j .

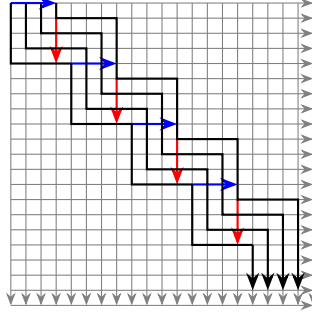

FIGURE 5. Constructing a fence in a grid.

- (4) For $1 \leq i \leq 2p$, if i is odd then $P_i \cap Q_1, \dots, P_i \cap Q_q$ are in order in P_i and if i is even then $P_i \cap Q_q, \dots, P_i \cap Q_1$ are in order in P_i .

The fence \mathcal{F} is well-linked if $A \cup B$ is well-linked.

The main theorem of this section is to show that any digraph with a large web where bottom and top come from a well-linked set contains a large well-linked fence.

Theorem 5.2. *For every $p, q, d \geq 1$ there are p', q' such that any digraph G containing a well-linked (p', q') -web with avoidance d contains a well-linked (p, q) -fence.*

To prove the previous theorem we first establish a weaker version where instead of a fence we obtain an acyclic grid. We give the definition first.

Definition 5.3 (acyclic grid). *An acyclic (p, q) -grid is a (p, q) -web $(\mathcal{P}, \mathcal{Q})$ with avoidance 0, where $\mathcal{P} = \{P_1, \dots, P_p\}$ and $\mathcal{Q} = \{Q_1, \dots, Q_q\}$, such that*

- (1) for $1 \leq i \leq p$ and $1 \leq j \leq q$, $P_i \cap Q_j$ is a path R_{ij} ,
- (2) for $1 \leq i \leq p$, the paths R_{i1}, \dots, R_{iq} are in order in P_i and
- (3) for $1 \leq j \leq q$, the paths R_{1j}, \dots, R_{pj} are in order in Q_j .

The definition of top and bottom as well as well-linkedness is taken over from the underlying web.

Theorem 5.4. *For all integers $t, d \geq 1$, there are integers p, q such that every digraph G containing a well-linked (p, q) -web $(\mathcal{P}, \mathcal{Q})$ with avoidance d contains a well-linked acyclic (t, t) -grid.*

Theorem 5.2 is now easily obtained from Theorem 5.4 using the following lemma, which is (4.7) in [42]. It is easily seen that in the construction in [42] the top and bottom of the fence are subsets of the top and bottom of the acyclic grid it is constructed from.

Lemma 5.5. *For every integer $p \geq 1$, there is an integer $p'' \geq 1$ such that every digraph with a (p'', p'') -grid has a (p, p) -fence such that the top and bottom of the fence are subsets of the top and bottom of the grid, respectively.*

As we will be using this result frequently, we demonstrate the construction in Figure 5. Essentially, we construct the fence inside the grid by starting at the top left corner and then taking alternatingly vertical and horizontal parts of the acyclic grid. This yields the vertical paths of the fence (marked as dotted black lines from the top left to the bottom right in the figure). To get the alternating horizontal

paths we use the short paths marked by solid black arrows in the figure. Note that by this construction, the horizontal and vertical paths of the new fence each contain subpaths of the horizontal as well as vertical paths of the original grid.

We now turn towards the proof of Theorem 5.4. We first need some definitions.

Definition 5.6. Let \mathcal{Q}^* be a linkage. Let $\mathcal{Q} \subseteq \mathcal{Q}^*$ be a sublinkage of order q and let P be a path intersecting every path in \mathcal{Q} .

- (1) Let $r \geq 0$. An edge $e \in E(P) - E(\mathcal{Q}^*)$ is r -splittable with respect to \mathcal{Q} (and \mathcal{Q}^*) if there is a set $\mathcal{Q}' \subseteq \mathcal{Q}$ of order r such that $Q \cap P_1 \neq \emptyset$ and $Q \cap P_2 \neq \emptyset$ for all $Q \in \mathcal{Q}'$, where P_1, P_2 are the two subpaths of $P - e$ such that $P = P_1 e P_2$.
- (2) Let P be a path. \mathcal{Q} is a q -segmentation of P if P can be divided into subpaths $P = P_1 e_1 \dots P_{q-1} e_{q-1} P_q$, for suitable edges $e_1, \dots, e_{q-1} \in E(P)$, such that \mathcal{Q} can be ordered as (Q_1, \dots, Q_q) and $\emptyset \neq V(Q_i) \cap V(P) \subseteq V(P_i)$. We say that \mathcal{Q} is a segmentation of P with respect to \mathcal{Q}^* if $e_i \in E(P) \setminus E(\mathcal{Q}^*)$ for all $1 \leq i \leq q - 1$.

We next lift the previous definition to pairs $(\mathcal{P}, \mathcal{Q})$ of linkages.

Definition 5.7. Let \mathcal{P} and \mathcal{Q}^* be linkages and let $\mathcal{Q} \subseteq \mathcal{Q}^*$ be a sublinkage of order q . Let $r \geq 0$.

- (1) An (r, q') -split of $(\mathcal{P}, \mathcal{Q})$ (with respect to \mathcal{Q}^*) is a pair $(\mathcal{P}', \mathcal{Q}')$ of linkages of order $r = |\mathcal{P}'|$ and $q' = |\mathcal{Q}'|$ with $\mathcal{Q}' \subseteq \mathcal{Q}$ such that there is a path $P \in \mathcal{P}$ and edges $e_1, \dots, e_{r-1} \in E(P) \setminus E(\mathcal{Q}^*)$ such that $P = P_1 e_1 P_2 \dots e_{r-1} P_r$ and $\mathcal{P}' := (P_1, \dots, P_r)$ and every $Q \in \mathcal{Q}'$ can be divided into subpaths Q_1, \dots, Q_r such that $Q = Q_1 e'_1 \dots e'_{r-1} Q_r$, for suitable edges $e'_1, \dots, e'_{r-1} \in E(Q)$, and $\emptyset \neq V(Q) \cap V(P_i) \subseteq V(Q_{r+1-i})$, for all $1 \leq i \leq r$.
- (2) An (r, q') -segmentation is a pair $(\mathcal{P}', \mathcal{Q}')$ where \mathcal{P}' is a linkage of order r and \mathcal{Q}' is a linkage of order q' such that \mathcal{Q}' is a q' -segmentation of every path P_i into segments $P_1^i e_1^i P_2^i \dots e_{q'-1}^i P_{q'}^i$.
- (3) A segmentation $(\mathcal{P}', \mathcal{Q}')$ is strong if for every $Q \in \mathcal{Q}'$ and $P_i \in \mathcal{P}'$, if Q intersects P_i in segment P_l^i , for some l , then Q intersects every $P_j \in \mathcal{P}'$ in segment P_l^j .

We say that $(\mathcal{P}', \mathcal{Q}')$ is a (strong) (r, q') -segmentation of $(\mathcal{P}, \mathcal{Q})$ if $\mathcal{Q}' \subseteq \mathcal{Q}$ and every path in \mathcal{P}' is a subpath of a path in \mathcal{P} .

An (r, q) -split $(\mathcal{P}, \mathcal{Q})$ and an (r, q) -segmentation $(\mathcal{P}, \mathcal{Q})$ is well-linked if the set of start and end vertices of the paths in \mathcal{Q} is a well-linked set.

We also need a slightly weaker version of a split.

Definition 5.8. Let \mathcal{P} and \mathcal{Q}^* be linkages and let $\mathcal{Q} \subseteq \mathcal{Q}^*$ be a sublinkage of order q . Let $r \geq 0$. A weak (r, q') -split of $(\mathcal{P}, \mathcal{Q})$ is defined in the same way as an (r, q') -split but without the requirement that all paths in \mathcal{P}' are subpaths of the same path in \mathcal{P} .

Formally, a weak (r, q') -split of $(\mathcal{P}, \mathcal{Q})$ (with respect to \mathcal{Q}^*) is a pair $(\mathcal{P}', \mathcal{Q}')$ of linkages of order $r = |\mathcal{P}'|$ and $q' = |\mathcal{Q}'|$ with $\mathcal{Q}' \subseteq \mathcal{Q}$ such that \mathcal{P}' can be ordered $\mathcal{P}' := (P_1, \dots, P_r)$ in such a way that every P_i is a subpath of a path $P \in \mathcal{P}$ and every $Q \in \mathcal{Q}'$ can be divided into subpaths Q_1, \dots, Q_r such that $Q = Q_1 e'_1 \dots e'_{r-1} Q_r$, for suitable edges $e'_1, \dots, e'_{r-1} \in E(Q)$, and $\emptyset \neq V(Q) \cap V(P_i) \subseteq V(Q_{r+1-i})$, for all $1 \leq i \leq r$.

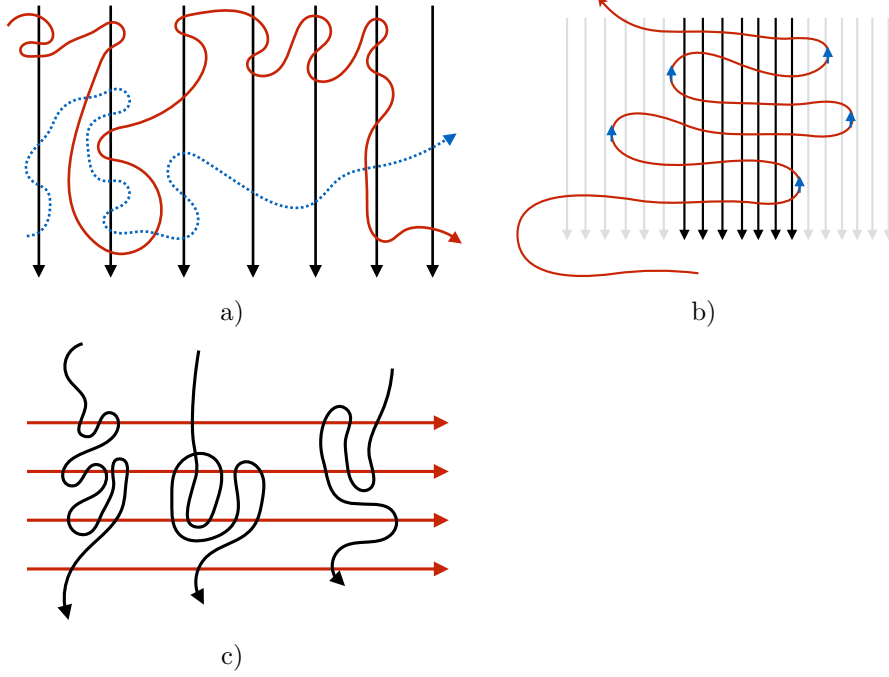

FIGURE 6. a) A $(2, 7)$ -segmentation and b) a $(6, 7)$ -split. c) An alternative view of segmentations, here a $(4, 3)$ -segmentation.

Remark 5.9. *To simplify the presentation we agree on the following notation when working with r -splits as in the previous definition. If \mathcal{P} only contains a single path P we usually simply write an (r, q) -split of (P, \mathcal{Q}) instead of $(\{P\}, \mathcal{Q})$. Furthermore, as the order in an r -split is important, we will often write r -splits as $((P_1, \dots, P_r), \mathcal{Q}')$.*

Note that in an (r, q') -split $(\mathcal{P}', \mathcal{Q}')$ of $(\mathcal{P}, \mathcal{Q})$, all paths in \mathcal{P}' are obtained from a single path in \mathcal{P} . The previous concepts are illustrated in Figure 6. Part a) of the figure illustrates a (strong) segmentation, where the vertical (black) paths are the paths in \mathcal{Q} which segment the two paths in \mathcal{P} (red and blue dotted). An alternative way of looking at segmentations is shown in Part c). Here, a $(4, 3)$ -segmentation is shown where the paths in \mathcal{Q} are again the vertical (black) paths and the paths in \mathcal{P} are the straight (red) horizontal paths. This way of viewing segmentations will be useful in Section 6 below. In Part b) of Figure 6, a single path P (marked in red) is split at 5 edges, marked by the arrows on P . The paths in \mathcal{Q} involved in the split are marked by solid black vertical paths whereas the paths in \mathcal{Q} which do not split P are displayed in light grey.

Note that we can make any segmentation $(\mathcal{P}, \mathcal{Q})$ strong by sacrificing either some paths in \mathcal{P} or some paths in \mathcal{Q} . We will need both ways in the sequel.

Lemma 5.10. *(1) For every $p, q \geq 1$, if $(\mathcal{P}, \mathcal{Q})$ is a (p', q) -segmentation for some $p' \geq q! \cdot p$, then there is a $\mathcal{P}' \subseteq \mathcal{P}$ of order p such that $(\mathcal{P}', \mathcal{Q})$ is a strong (p, q) -segmentation.*

- (2) For every $p, q \geq 1$ there is a $q' \geq 1$ such that if $(\mathcal{P}, \mathcal{Q})$ is a $(2p, q')$ -segmentation, then there is $\mathcal{Q}' \subseteq \mathcal{Q}$ of order q and $\mathcal{P}' \subseteq \mathcal{P}$ of order p such that $(\mathcal{P}', \mathcal{Q}')$ is a strong (p, q) -segmentation.

Proof. We first prove Part (1). For every $P \in \mathcal{P}$ let $P(\mathcal{Q}) := (Q_{i_1}, \dots, Q_{i_q})$ be the order in which the paths in \mathcal{Q} occur on P when traversing P from beginning to end. As $(\mathcal{P}, \mathcal{Q})$ is a segmentation, this is well defined. As $p' \geq q! \cdot p$ there is a subset $\mathcal{P}' \subseteq \mathcal{P}$ of order p such that $P(\mathcal{Q}) = P'(\mathcal{Q})$ for all $P, P' \in \mathcal{P}'$. Hence, $(\mathcal{P}', \mathcal{Q}')$ is a strong (p, q) -segmentation as required.

We now prove the second part. Let $x_{2p} := q$ and for $0 \leq j < 2p$ let $x_j := (x_{j+1} - 1)^2 + 1$. We set $q' := x_0$.

Fix an ordering (P_1, \dots, P_{2p}) of \mathcal{P} and for every $P_i \in \mathcal{P}$ let $P_1^i, \dots, P_{q'}^i$ be the segments of P_i such that $P = P_1^i e_1 \dots e_{q'-1} P_{q'}^i$ and every $Q \in \mathcal{Q}$ intersects P_i in exactly one segment. We will also fix an ordering $(Q_1, \dots, Q_{q'})$ of \mathcal{Q} .

For every subset $\mathcal{Q}^* := \{Q_{i_1}, \dots, Q_{i_k}\} \subseteq \mathcal{Q}$, defined by some indices $i_1 < \dots < i_k$, and every $P \in \mathcal{P}$ let $\pi(P, \mathcal{Q}^*) := (j_1, \dots, j_k)$ be such that the paths in \mathcal{Q}^* occur on P (when traversing P from beginning to end) in the order Q_{j_1}, \dots, Q_{j_k} .

For $0 \leq i \leq 2p$ we will construct a sequence $\mathcal{Q}_i \subseteq \mathcal{Q}$ of order x_i such that there is an ordering (Q_1, \dots, Q_{x_i}) of the paths in \mathcal{Q}_i and for all $1 \leq j \leq i$, the paths in \mathcal{Q}_i occur on P_j in this order (when traversing from beginning to end) or in reverse order (Q_{x_i}, \dots, Q_1) .

Choose $\mathcal{Q}_0 = \mathcal{Q}$ which has order x_0 . Now suppose \mathcal{Q}_i has already been constructed. Let $\pi(P_{i+1}, \mathcal{Q}_i) := (j_1, \dots, j_{x_i})$. By the choice of x_i and Theorem 2.9, there is a subsequence $j_{a_1}, \dots, j_{a_{x_{i+1}}}$ such that $j_{a_1} < \dots < j_{a_{x_{i+1}}}$ or $j_{a_1} > \dots > j_{a_{x_{i+1}}}$. We set $\mathcal{Q}_{i+1} := \{Q_{j_{a_l}} : 1 \leq l \leq x_{i+1}\}$.

Now let \mathcal{Q}_{2p} be as constructed. We set $\mathcal{Q}' := \mathcal{Q}_{2p}$. Let (Q_1, \dots, Q_{2p}) be the order in which the paths in \mathcal{Q}' occur on P_1 . Then for every $1 \leq i \leq 2p$, the paths in \mathcal{Q}' occur on P_i in this order or in reverse order. Hence, there is a subset $\mathcal{P}' \subseteq \mathcal{P}$ of order p such that all paths in \mathcal{Q}' occur on every $P \in \mathcal{P}'$ in the same order. \square

We next show the following lemma, which is essentially shown in [42].

Lemma 5.11. *Let $r, s \geq 0$. Let \mathcal{Q}^* be a linkage and let $\mathcal{Q} \subseteq \mathcal{Q}^*$ be a sublinkage of order q . Let P be a path intersecting every path in \mathcal{Q} . If $q \geq r \cdot s$ then P contains an r -splittable edge with respect to \mathcal{Q} and \mathcal{Q}^* or there is an s -segmentation $\mathcal{Q}' \subseteq \mathcal{Q}$ of P with respect to \mathcal{Q}^* .*

Proof. Let $(Q_1, \dots, Q_{r \cdot s}) \subseteq \mathcal{Q}$ be a linkage of order $r \cdot s$. For $1 \leq j \leq r \cdot s$, let F_j be the minimal subpath of P that includes $V(P \cap Q_j)$. Note that as \mathcal{Q}^* is a linkage, if $Q \neq Q' \in \mathcal{Q}^*$, $v \in V(P) \cap V(Q)$ and $v' \in V(P) \cap V(Q')$ then every subpath of P containing v and v' must contain an edge $e \notin E(\mathcal{Q}^*)$.

Suppose first that for some edge $e \in E(P) \setminus E(\mathcal{Q}^*)$ there are at least r distinct values j_1, \dots, j_r such that e belongs to F_{j_1}, \dots, F_{j_r} . Then e is r -splittable as witnessed by $\mathcal{Q}' := \{Q_{j_1}, \dots, Q_{j_r}\}$.

Thus we may assume that every edge of $E(P) \setminus E(\mathcal{Q}^*)$ occurs in F_j for fewer than r values of j . Consequently there are s distinct numbers j_1, \dots, j_s so that F_{j_1}, \dots, F_{j_s} are pairwise vertex-disjoint. Thus $\mathcal{Q}' := (Q_{j_1}, \dots, Q_{j_s})$ is an s -segmentation of P . \square

The lemma has the following consequence which we will use frequently below.

Corollary 5.12. *Let H be a digraph and let \mathcal{Q}^* be a linkage in H and let $\mathcal{Q} \subseteq \mathcal{Q}^*$ be a linkage of order q . Let $P \subseteq H$ be a path intersecting every path in \mathcal{Q} . Let $c \geq 0$ be such that for every edge $e \in E(P) \setminus E(\mathcal{Q}^*)$ there are no c pairwise vertex disjoint paths in $H - e$ from P_1 to P_2 , where $P = P_1eP_2$. For all $s, r \geq 0$, if $q \geq (r + c) \cdot s$ then*

- a) *there is an s -segmentation $\mathcal{Q}' \subseteq \mathcal{Q}$ of P with respect to \mathcal{Q}^* or*
- b) *a $(2, r)$ -split $((P_1, P_2), \mathcal{Q}'')$ of (P, \mathcal{Q}) with respect to \mathcal{Q}^* .*

Proof. By Lemma 5.11, there is an s -segmentation of P or an $(r + c)$ -splittable edge $e \in E(P) - E(\mathcal{Q}^*)$. In the second case, let $P = P_1eP_2$ and let $\mathcal{Q}' \subseteq \mathcal{Q}$ be of order $(r + c)$ witnessing that e is $(r + c)$ -splittable. Thus, every path in \mathcal{Q}' intersects P_1 and P_2 . As there are at most c disjoint paths from P_1 to P_2 in $H - e$, at most c of the paths in \mathcal{Q}' hit P_1 before they hit P_2 . Hence, there is a subset $\mathcal{Q}'' \subseteq \mathcal{Q}'$ of order r such that for all $Q \in \mathcal{Q}''$ the last vertex of $V(P_2 \cap Q)$ occurs before the first vertex of $V(P_1 \cap Q)$. Hence, $((P_1, P_2), \mathcal{Q}'')$ is a $(2, r)$ -split. \square

We will mostly apply the previous lemma in a case where $H \subseteq G$ is a subgraph induced by two linkages \mathcal{P}, \mathcal{Q} and $P \in \mathcal{P}$.

We now present one of our main constructions showing that for every x, y, q every web of sufficiently high order either contains an (x, q) -segmentation or a (y, q) -split. This construction will again be used in Section 6 below. We first refine the definition of webs from Section 4. The difference between the webs (with avoidance 0) used in Section 4 and the webs with linkedness c defined here is that we no longer require that in a web $(\mathcal{P}, \mathcal{Q})$, \mathcal{P} is \mathcal{Q} -minimal. Instead we require that in every path P , if we split P at an edge e , i.e. $P = P_1eP_2$, then there are at most c paths from P_1 to P_2 in $\mathcal{P} \cup \mathcal{Q}$. This is necessary as in the various constructions below, minimality will not be preserved but this forward path property is preserved. We give a formal definition now.

Definition 5.13 ((p, q) -web with linkedness c). *Let $p, q, c \geq 0$ be integers and let \mathcal{Q}^* be a linkage. A (p, q) -web with linkedness c with respect to \mathcal{Q}^* in a digraph G consists of two linkages $\mathcal{P} = \{P_1, \dots, P_p\}$ and $\mathcal{Q} = \{Q_1, \dots, Q_q\} \subseteq \mathcal{Q}^*$ such that*

- (1) *\mathcal{Q} is a C - D linkage for two distinct vertex sets $C, D \subseteq V(G)$ and \mathcal{P} is an A - B linkage for two distinct vertex sets $A, B \subseteq V(G)$,*
- (2) *for $1 \leq i \leq q$, Q_i intersects every path $P \in \mathcal{P}$,*
- (3) *for every $P \in \mathcal{P}$ and every edge $e \in E(P) \setminus E(\mathcal{Q}^*)$ there are at most c disjoint paths from P_1 to P_2 in $\mathcal{P} \cup \mathcal{Q}$ where P_1, P_2 are the subpaths of P such that $P = P_1eP_2$.*

The set $C \cap V(\mathcal{Q})$ is called the top of the web, denoted $\text{top}((\mathcal{P}, \mathcal{Q}))$, and $D \cap V(\mathcal{Q})$ is the bottom $\text{bot}((\mathcal{P}, \mathcal{Q}))$. The web $(\mathcal{P}, \mathcal{Q})$ is well-linked if $C \cup D$ is well-linked.

Remark 5.14. *Every (p, q) -web with avoidance 0 is a (p, q) -web with linkedness p . The linkedness p follows from Lemma 2.15.*

Lemma 5.15. *For all $c, x, y, q \geq 0$ and $p \geq x$ there is a number q' such that if G contains a (p, q') -web $\mathcal{W} := (\mathcal{P}, \mathcal{Q})$ with linkedness c , then*

- (1) *G contains a (y, q) -split $(\mathcal{P}', \mathcal{Q}')$ of $(\mathcal{P}, \mathcal{Q})$ or*

- (2) an (x, q) -segmentation $(\mathcal{P}', \mathcal{Q}')$ of $(\mathcal{P}, \mathcal{Q})$ with the following additional properties: at most $y - 1$ paths in \mathcal{P}' are subpaths of the same path in \mathcal{P} . In addition, for every path $P \in \mathcal{P}$, either $V(P) \subseteq V(\mathcal{P}')$ or $V(P) \cap V(\mathcal{P}') = \emptyset$. Finally, if $P_1, \dots, P_l \in \mathcal{P}'$ are the subpaths of the same path $P \in \mathcal{P}$, for some $l \leq y - 1$, so that P_1, \dots, P_l occur on P in this order, then for all $l_1 < l_2 \leq l$, no path $Q \in \mathcal{Q}'$ intersects any P_{l_2} after the first vertex Q has in common with P_{l_1} .

Furthermore, if \mathcal{W} is well-linked then so is $(\mathcal{P}', \mathcal{Q}')$.

Proof. Fix $\mathcal{Q}^* := \mathcal{Q}$ for the rest of the proof. All applications of Corollary 5.12 will be with respect to this original linkage \mathcal{Q}^* .

For all $0 \leq i \leq xy$ we define values q_i inductively as follows. We set $q_{xy} := q$ and $q_{i-1} := q_i \cdot (q_i + c)$. We define $q^i := q_0$.

Let $(\mathcal{P}, \mathcal{Q})$ be a (p, q_0) -web. For $0 \leq i \leq xy$ we construct a sequence $\mathcal{M}_i := (\mathcal{P}^i, \mathcal{Q}^i, \mathcal{S}_{seg}^i, \mathcal{S}_{split}^i)$, where $\mathcal{Q}^i, \mathcal{S}_{seg}^i$ and \mathcal{S}_{split}^i are linkages of order q_i, x_i and y_i , respectively, and \mathcal{P}^i is a linkage of order at least $p - i$ such that $\mathcal{Q}^i \subseteq \mathcal{Q}^*$ and $(\mathcal{S}_{seg}^i, \mathcal{Q}^i)$ is an (x_i, q_i) -segmentation and $(\mathcal{S}_{split}^i, \mathcal{Q}^i)$ is a (y_i, q_i) -split of $(\mathcal{P}, \mathcal{Q})$. Furthermore, $(\mathcal{P}^i, \mathcal{Q}^i)$ has linkedness c and $\mathcal{P}^i \cap \mathcal{S}_{seg}^i = \emptyset$, for all i . Recall that, in particular, this means that the paths in \mathcal{S}_{split}^i are the subpaths of a single path in \mathcal{P} that is split by edges $e \in E(P) \setminus E(\mathcal{Q}^*)$.

We first set $\mathcal{M}_0 := (\mathcal{P}^0 := \mathcal{P}, \mathcal{Q}^0 := \mathcal{Q}^*, \mathcal{S}_{seg}^0 := \emptyset, \mathcal{S}_{split}^0 := \emptyset)$. Clearly, this satisfies the conditions on \mathcal{M}_0 defined above.

Now suppose that \mathcal{M}_i has already been defined for some $i \geq 0$. If $\mathcal{S}_{split}^i \setminus \mathcal{S}_{seg}^i = \emptyset$, we first choose a path $P \in \mathcal{P}^i$ and set $\mathcal{S}_{split} = \{P\}$ and $\mathcal{P}^{i+1} := \mathcal{P}^i \setminus \{P\}$.

Otherwise, if $\mathcal{S}_{split}^i \setminus \mathcal{S}_{seg}^i \neq \emptyset$, we set $\mathcal{S}_{split} := \mathcal{S}_{split}^i$ and $\mathcal{P}^{i+1} := \mathcal{P}^i$. In both cases, we set $\mathcal{S}_{seg} := \mathcal{S}_{seg}^i$.

Now, let $P \in \mathcal{S}_{split} \setminus \mathcal{S}_{seg}$. We apply Corollary 5.12 to P, \mathcal{Q}^i and \mathcal{Q}^* setting $r = s = q_{i+1}$ in the statement of the lemma. If we get a q_{i+1} -segmentation $\mathcal{Q}_1 \subseteq \mathcal{Q}^i$ of P with respect to \mathcal{Q}^* we set

$$\mathcal{Q}^{i+1} := \mathcal{Q}_1, \quad \mathcal{S}_{seg}^{i+1} := \mathcal{S}_{seg}^i \cup \{P\} \quad \text{and} \quad \mathcal{S}_{split}^{i+1} := \mathcal{S}_{split}^i.$$

Otherwise, we get a $(2, q_{i+1})$ -split $((P_1, P_2), \mathcal{Q}_2)$ where $\mathcal{Q}_2 \subseteq \mathcal{Q}^i$. Then we set

$$\begin{aligned} \mathcal{Q}^{i+1} &:= \mathcal{Q}_2, \\ \mathcal{S}_{seg}^{i+1} &:= \mathcal{S}_{seg}^i \quad \text{and} \\ \mathcal{S}_{split}^{i+1} &:= (\mathcal{S}_{split}^i \setminus \{P\}) \cup \{P_1, P_2\}. \end{aligned}$$

It is easily verified that the conditions for $\mathcal{M}^{i+1} := (\mathcal{P}^{i+1}, \mathcal{Q}^{i+1}, \mathcal{S}_{seg}^{i+1}, \mathcal{S}_{split}^{i+1})$ are maintained. In particular, the linkedness c of $(\mathcal{P}^{i+1}, \mathcal{Q}^{i+1})$ is preserved as deleting or splitting paths cannot increase forward connectivity (in contrast to the minimality property). This concludes the construction of \mathcal{M}_{i+1} .

We stop this process as soon as for some i

- (1) $|\mathcal{S}_{split}^i| \geq y$ or
- (2) $|\mathcal{S}_{seg}^i| \geq x$ and $|\mathcal{S}_{split}^i \setminus \mathcal{S}_{seg}^i| = 0$.

Note that in the construction, after every y steps, either we have found a set \mathcal{S}_{split}^i of size y or $\mathcal{S}_{split}^i \setminus \mathcal{S}_{seg}^i$ has become empty at some point. More precisely, we

start with a path $P \in \mathcal{P}$ to put into \mathcal{S}_{split} . Then in every step we try to split a path in \mathcal{S}_{split} . If this works and we find a splittable edge, we add both subpaths to \mathcal{S}_{split} . Otherwise, the path will be added to \mathcal{S}_{seg} and then we do not try to split it again later on. Hence, continuing in this way, for the path P we started with, either it will be split y times and we stop the construction or at some point all its subpaths generated by splitting will also be contained in \mathcal{S}_{seg} . We then stop working on P and choose a new path $P' \in \mathcal{P}$ for which we repeat the process.

Hence, in the construction above, in each step we either increase x_i and decrease $|\mathcal{S}_{split}^i \setminus \mathcal{S}_{seg}^i|$ or we increase y_i . After at most $i \leq xy$ steps, either we have constructed a set \mathcal{S}_{seg}^i of order x and $\mathcal{S}_{split}^i \setminus \mathcal{S}_{seg}^i = \emptyset$ or a set \mathcal{S}_{split}^i of order y .

If we found a set \mathcal{S}_{split}^i of order y then we can choose any set $\mathcal{Q}' \subseteq \mathcal{Q}^i$ of order q and $(\mathcal{S}_{split}^i, \mathcal{Q}')$ is the first outcome of the lemma.

So suppose that instead we get a set $\mathcal{S}_{seg} := \mathcal{S}_{seg}^i$ of order $y' \geq y$ such that $\mathcal{S}_{seg} \setminus \mathcal{S}_{split}^i = \emptyset$. This implies that we get a segmentation $(\mathcal{S}_{seg}, \mathcal{Q}^i)$ such that for every path $P \in \mathcal{P}$, either $V(P) \cap V(\mathcal{S}_{seg}) = \emptyset$ or $V(P) \subseteq V(\mathcal{S}_{seg})$. Note further that as we are in the second case, no path P was split y or more times. Hence at most $y - 1$ paths in \mathcal{S}_{seg} belong to the same path $P \in \mathcal{P}$. Furthermore, if P_1, \dots, P_l belong to the same path $P \in \mathcal{P}$, then they are obtained from P by splits. Hence, if they occur on P in this order, then the paths in \mathcal{Q}^i have to go through P_1, \dots, P_l in the reverse order P_l, \dots, P_1 . Hence, $(\mathcal{S}_{seg}, \mathcal{Q}^i)$ satisfy the conditions for the second outcome of the lemma.

Finally, it is easily seen that if \mathcal{W} is well-linked then so is $(\mathcal{S}_{split}^i, \mathcal{Q}')$ (in case of the first outcome) or $(\mathcal{S}_{seg}, \mathcal{Q}^i)$ (in case of the second outcome). This concludes the proof of the lemma. \square

Lemma 5.15 and the second part of Lemma 5.10 together imply the following corollary needed in Section 6 below.

Corollary 5.16. *For all $c, x, y, q \geq 0$ and $p \geq 2x$ there is a number q' such that if G contains a (p, q') -web $\mathcal{W} := (\mathcal{P}, \mathcal{Q})$ with linkedness c , then G contains*

- (1) a (y, q) -split $(\mathcal{P}', \mathcal{Q}')$ of $(\mathcal{P}, \mathcal{Q})$ or
- (2) a strong (x, q) -segmentation $(\mathcal{P}', \mathcal{Q}')$ of $(\mathcal{P}, \mathcal{Q})$ with the following additional properties: at most $y - 1$ paths in \mathcal{P}' are subpaths of the same path in \mathcal{P} . In addition, if $P_1, \dots, P_l \in \mathcal{P}'$ are the subpaths of the same path $P \in \mathcal{P}$, for some $l \leq y - 1$, so that P_1, \dots, P_l occur on P in this order, then for all $l_1 < l_2 \leq l$, no path $Q \in \mathcal{Q}'$ intersects any P_{l_2} after the first vertex Q has in common with P_{l_1} .

Furthermore, if \mathcal{W} is well-linked then so is $(\mathcal{P}', \mathcal{Q}')$.

Note that in contrast to Lemma 5.15, in the previous corollary it is no longer true that for every path $P \in \mathcal{P}$, either $V(P) \subseteq V(\mathcal{P}')$ or $V(P) \cap V(\mathcal{P}') = \emptyset$.

Consider the case that the outcome of the previous lemma is a y -split. This case is illustrated in Figure 6 b). We call the structure that we obtain in this case a *pseudo-fence*.

Definition 5.17 (pseudo-fence). *A (p, q) -pseudo-fence is a pair $(\mathcal{P} := (P_1, \dots, P_{2p}), \mathcal{Q})$ of pairwise disjoint paths, where $|\mathcal{Q}| = q$, such that each $Q \in \mathcal{Q}$ can be divided into segments Q_1, \dots, Q_{2p} occurring in this order on Q such that for all i , each P_i*

intersects all $Q \in \mathcal{Q}$ in their segment Q_i and P_i does not intersect any Q in any other segment. Furthermore, for all $1 \leq i \leq p$, there is an edge e_i connecting the endpoint of P_{2i} to the start point of P_{2i-1} or an edge e_i connecting the endpoint of P_{2i-1} to the start point of P_{2i} .

A weak (p, q) -pseudo-fence (P, Q) is defined in the same way except that instead of the edges e_i there is for each $1 \leq i \leq p$ a path L_i which connects the endpoint of one of the paths P_{2i} or P_{2i-1} to the start vertex of the other path such that L_i does not intersect any P_s , $1 \leq s \leq 2p$ and for all $Q \in \mathcal{Q}$, $V(L_i \cap Q) \subseteq V(Q_{2i} \cup Q_{2i-1})$.

The top of $(\mathcal{P}, \mathcal{Q})$ is the set of start vertices and the bottom the set of end vertices of \mathcal{Q} .

The next lemma follows immediately from the definitions.

Proposition 5.18. *Let $(\mathcal{P}', \mathcal{Q}')$ be a $(2y, q)$ -split of some pair $(\mathcal{P}, \mathcal{Q})$ of linkages. Then $(\mathcal{P}', \mathcal{Q}')$ form a (y, q) -pseudo-fence.*

In the following three lemmas (which generalise the results in [42]), we show how in each of the two cases of the Lemma 5.15 we get an acyclic grid. We first need some preparation.

Lemma 5.19. *There are functions $f_r, f_p : \mathbb{N} \rightarrow \mathbb{N}$ such that for every $k \geq 1$, if \mathcal{P} and \mathcal{R} are linkages of order at least $f_p(k)$ and $f_r(k)$, respectively, and $(\mathcal{P}, \mathcal{R})$ is a strong $(f_p(k), f_r(k))$ -segmentation, then there is a sequence $\hat{P}_1, \dots, \hat{P}_k \in \mathcal{P}$ and a path A consisting of subpaths of paths in \mathcal{P} and \mathcal{R} such that A intersects $\hat{P}_1, \dots, \hat{P}_k$ in this order, $A \cap \hat{P}_i$ is a path for all $1 \leq i \leq k$ and the start and end vertex of A are on paths from \mathcal{R} .*

Furthermore,

- (1) there exists such a sequence $\hat{P}_1, \dots, \hat{P}_k$ and path A such that A starts at the start vertex of a path $R \in \mathcal{R}$ and
- (2) there exists such a sequence $\hat{P}_1, \dots, \hat{P}_k$ and path A such that A ends at the endpoint of a path $R \in \mathcal{R}$.

Proof. We define $f_r(k) := 3k \cdot f_p(k) \cdot \binom{f_p(k)}{3k} \cdot 3k! + (k+1) \cdot \binom{f_p(k)}{k} \cdot k!$. To define $f_p(k)$ we set $f_p(1) = 1$. For $k > 1$ let $b_0 := 2^{f_p(k-1)+k}$ and let, for $0 < i \leq k$, $b_i := (2b_{i-1})^{b_{i-1}+k}$. We set $f_p(k) := b_k$.

We assume that $|\mathcal{P}| = f_p(k)$, otherwise we choose an arbitrary subset of \mathcal{P} of order exactly $f_p(k)$ and work with that.

We first need to define some notation used throughout the proof. For any path X we denote by $\overset{\circ}{X}$ the interior of X , i.e. X without its endpoints. Let X be a subpath of a path in \mathcal{R} and let $\mathcal{P}' \subseteq \mathcal{P}$ be such that X intersects every $P \in \mathcal{P}'$. Let $P_1 \in \mathcal{P}'$ be the first path in \mathcal{P}' that X intersects. Let x_1, \dots, x_s be the vertices in $V(X) \cap V(P_1)$ in the order in which they appear on X . Let X_i be the subpath of X from x_i to x_{i+1} . If $\overset{\circ}{X}_i$ intersects at least l paths in \mathcal{P}' then we call X_i a \mathcal{P}' -bridge of X of order l . It will be important in the sequel that a \mathcal{P}' -bridge has its endpoints on the first path in \mathcal{P}' that X intersects.

We are now ready to prove the lemma. We will prove the lemma satisfying Condition (1). The proof for Condition (2) follows by the same argument applied after reversing the directions of all edges.

For every $R \in \mathcal{R}$ we construct a sequence $(\mathcal{B}_i, \mathcal{P}_i, \tilde{R}_i)_{0 \leq i \leq k}$ inductively as follows. We will maintain the property that $|\mathcal{P}_i| \geq b_{k-i}$. We set $\mathcal{B}_0 := \emptyset, \tilde{R}_0 := R$, and

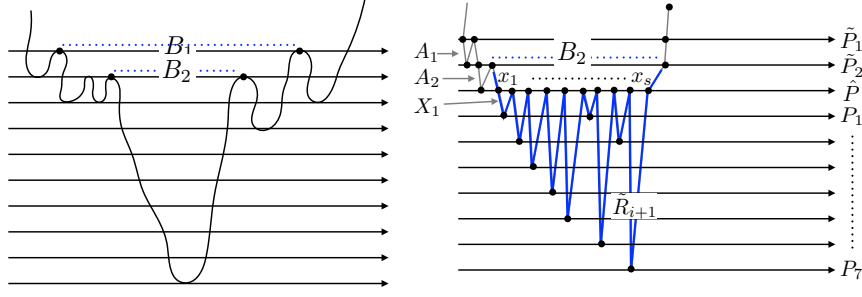

FIGURE 7. Construction in the first part of Lemma 5.19.

$\mathcal{P}_0 := \mathcal{P}$. As $|\mathcal{P}| = f_p(k) = b_k$ this satisfies the condition on $|\mathcal{P}_0|$. Now suppose $\mathcal{B}_i, \tilde{R}_i, \mathcal{P}_i$ have already been defined. If \tilde{R}_i contains a \mathcal{P}_i -bridge B of order $b_{k-(i+1)}$, then we set $\tilde{R}_{i+1} := \tilde{B}$, $\mathcal{P}_{i+1} := \{P \in \mathcal{P}_i : \tilde{B} \cap P \neq \emptyset\}$, and $\mathcal{B}_{i+1} := \mathcal{B}_i \cup \{B\}$.

If there is no such bridge the construction stops after $i(R) := i$ steps. If $i(R) = k$, then we proceed as follows. Let $\mathcal{B}_k := (B_1, \dots, B_k)$. Let P_1, \dots, P_k be the paths in \mathcal{P} containing the first vertex of B_1, \dots, B_k , respectively. By construction, for $i \geq 1$, B_{i+1} is a subpath of B_i constituting a \mathcal{P}_i -bridge. Furthermore, the first vertex of B_{i+1} is on the path P_{i+1} and P_{i+1} is the first path in \mathcal{P}^i that B_i intersects. Thus, each B_i contains an initial subpath A_i linking P_i to P_{i+1} which is internally vertex disjoint from P_1, \dots, P_k . We call $(A_1, \dots, A_{k-1}, P_1, \dots, P_k)$ the *routing sequence of R of type 1* and the sequence (P_1, \dots, P_k) the *routeable paths* of the sequence.

Now suppose the construction stops at some step $i(R) < k$. See Figure 7 for an illustration of the following construction. Let $\tilde{P}_1, \dots, \tilde{P}_i$ be the paths in \mathcal{P} containing the first vertex of B_1, \dots, B_i , respectively. As before, there are paths A_1, \dots, A_{i-1} such that A_j links \tilde{P}_j to \tilde{P}_{j+1} and is internally vertex disjoint from $\tilde{P}_1, \dots, \tilde{P}_i$ and also from $\bigcup \mathcal{P}_i$. Furthermore, the current path \tilde{R}_{i+1} does not intersect any of $\tilde{P}_1, \dots, \tilde{P}_i$. Let \hat{P} be the first path in \mathcal{P}_i that \tilde{R}_{i+1} intersects and let A_i be the initial subpath of \tilde{R}_{i+1} that connects P_i and \hat{P} . Let x_1, \dots, x_s be the vertices of $V(\hat{P}) \cap V(\tilde{R}_{i+1})$ in the order in which they occur on \tilde{R}_{i+1} . For $1 \leq j < s$, let X_j be the subpath of \tilde{R}_{i+1} from x_j to x_{j+1} and let $\mathcal{Y}_j := \{P \in \mathcal{P}_i \setminus \{\hat{P}\} : X_j \cap P \neq \emptyset\}$. As the construction above cannot be extended to $i+1$, B_i does not contain a \mathcal{P}_i -bridge of order $b_{k-(i+1)}$ and hence $|\mathcal{Y}_j| < b_{k-(i+1)}$, for all $1 \leq j < s$.

Claim 1. There are paths $P_1, \dots, P_k \in \mathcal{P}_i \setminus \{\hat{P}\}$ and indices $i_1 < \dots < i_k$ such that for all $1 \leq j \leq k$: X_{i_j} has a non-empty intersection with P_j but does not intersect $P_{j'}$ for all $j \neq j'$.

Proof. Let $b := b_{k-(i+1)}$. For $0 \leq i \leq b+k$ let $h_i := (2b)^{b+k-i}$. For $i \geq 0$ we will construct a sequence $(c_i, \mathcal{I}_i, \mathcal{C}_i)$ where

- \mathcal{C}_i is a set of sets such that $|\bigcup \mathcal{C}_i| \geq h_i$ and for each $\mathcal{Y} \in \mathcal{C}_i$ there is $\mathcal{Y}_l \in \{\mathcal{Y}_1, \dots, \mathcal{Y}_{s-1}\}$ with $\mathcal{Y} \subseteq \mathcal{Y}_l$,
- $0 < c_i \leq b$ and $|\mathcal{Y}| \leq c_i$ for all $\mathcal{Y} \in \mathcal{C}_i$,
- $\mathcal{I}_i \subseteq \mathcal{P}$ and $\mathcal{I}_i \cap \mathcal{Y} = \emptyset$ for all $\mathcal{Y} \in \mathcal{C}_i$, and

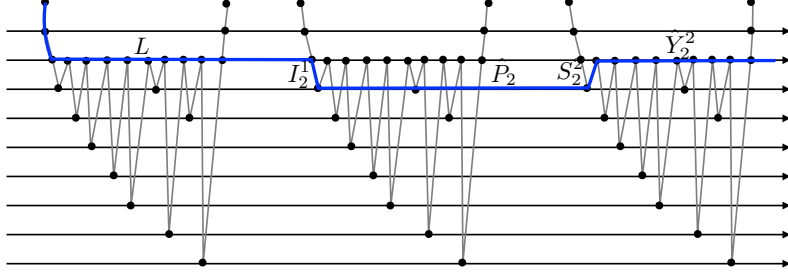

FIGURE 8. Constructing the path in the second part of Lemma 5.19.

- for every $P \in \mathcal{I}_i$ there is an X_j such that X_j intersects P but no other path in \mathcal{I}_i .

We initialise the construction by setting $\mathcal{C}_0 := \{\mathcal{Y}_l : \mathcal{Y}_l \neq \emptyset, 1 \leq l \leq s-1\}$, $\mathcal{I}_i = \emptyset$, and $c_0 = b$. As $|\bigcup \mathcal{C}_0| = |\mathcal{P}_i| \geq (2b)^{b+k}$ and, by assumption above, $|\mathcal{Y}_j| < b$, this satisfies the conditions above.

So suppose $(c_i, \mathcal{I}_i, \mathcal{C}_i)$ have already been defined. Let l be minimal such that $\mathcal{Y}_l \in \mathcal{C}_i$. Let $P \in \mathcal{Y}_l$ be the first path that is being hit by X_l . If $|\bigcup\{\mathcal{Y}^l \in \mathcal{C}_i : P \notin \mathcal{Y}^l\} \setminus \mathcal{Y}_l| \geq h_{i+1}$ then set $\mathcal{C}_{i+1} := \{\mathcal{Y}^l \setminus \mathcal{Y}_l \in \mathcal{C}_i : \mathcal{Y}^l \in \mathcal{C}_i, P \notin \mathcal{Y}^l\}$, $\mathcal{I}_{i+1} := \mathcal{I}_i \cup \{P\}$, and $c_{i+1} := c_i$. Otherwise, set $\mathcal{C}_{i+1} := \{\mathcal{Y}^l \in \mathcal{C}_i : P \in \mathcal{Y}^l\}$, $\mathcal{I}_{i+1} := \mathcal{I}_i$, and $c_{i+1} := c_i - 1$. As $h_i = (2b)^{b+k-i} \geq 2 \cdot (2b)^{b+k-(i+1)} + b = 2 \cdot h_{i+1} + b$ we have $|\bigcup \mathcal{C}_{i+1}| \geq h_{i+1}$. Thus, again this satisfies the conditions above.

We claim that after $l \leq b+k$ steps we have found the sequence \mathcal{I}_l of order k as required. For, in every step we either add a path to \mathcal{I}_i or decrease c_i . As $|\bigcup \mathcal{C}_i| \geq h_i$, c_i can never become 0 and therefore after $< b$ steps in which c_i is decreased we always add a path to \mathcal{I}_i in the remaining k steps. \dashv

For the path R as above we now choose paths P_1, \dots, P_k as in the previous claim.

We call $(A_1, \dots, A_{i-1}, \tilde{P}_1, \dots, \tilde{P}_i, A_i, \hat{P}, X_{i_1}, \dots, X_{i_k}, P_1, \dots, P_k)$ a *routing sequence of type 2* and $\tilde{P}_1, \dots, \tilde{P}_i, \hat{P}, P_1, \dots, P_k$ the *routable paths*. This concludes the construction of routing sequences.

We now have for every path $R \in \mathcal{R}$ a routing sequence of type 1 or 2. Suppose first there are $3k \cdot f_p(k) \cdot \binom{f_p(k)}{3k} \cdot 3k!$ paths in \mathcal{R} with a routing sequence of type 2. See Figure 8 for an illustration of the following construction. Then there must be $3k$ paths R_1, \dots, R_{3k} with the same sequence of routable paths $(\tilde{P}_1, \dots, \tilde{P}_i, \hat{P}, P_1, \dots, P_k)$.

Let

$$(A_1^i, \dots, A_l^i, A_{l+1}^i, \tilde{P}_1, \dots, \tilde{P}_l, \hat{P}, X_1^i, \dots, X_k^i, P_1, \dots, P_k)$$

be the routing sequence of R_i . Recall that the paths X_j^i all start on \hat{P} . We assume that R_1, \dots, R_{3k} are ordered in the order in which they appear on the paths in \mathcal{P} . For all $1 \leq i, j \leq k$ let I_j^i be the initial subpath of X_j^i from the first vertex of X_j^i to the first vertex X_j^i has in common with P_i and let S_j^i be the suffix of X_j^i from the last vertex X_j^i has in common with P_i to the end of X_j^i , which again lies on \hat{P} .

Let \hat{P}_i^j be the subpath of P_i from the endpoint of I_i^j to the start vertex of S_i^{i+1} . Finally, let \hat{Y}_j^i be the subpath of \hat{P} from the end vertex of S_j^i to the first vertex of I_{j+1}^{i+1} .

Then,

$$I_1^l \cdot \hat{P}_1^l \cdot S_1^{l+1} \cdot \hat{Y}_1^{l+1} \cdot I_2^{l+2} \cdot \hat{P}_3^{l+2} \cdot S_2^{l+3} \dots S_k^{l+2k-1}$$

is a path A^l intersecting P_1, \dots, P_k in this order and such that $A^l \cap P_i$ is a path, for all $1 \leq i \leq k$. What is left to do is to connect the first vertex of a path in \mathcal{R} to the first vertex of A^l . For this we use the first part $(A_1^i, \dots, A_l^i, \tilde{P}_1, \dots, \tilde{P}_l)$ of the routing sequence for R_i , $1 \leq i \leq l$. By construction, A_1^i, \dots, A_l^i are paths internally disjoint from $\tilde{P}_1, \dots, \tilde{P}_l, P_1, \dots, P_k$ with A_j^i linking \tilde{P}_j to \tilde{P}_{j+1} . Furthermore, \tilde{P}_1 is the first path in \mathcal{P} hit by R_1 . Hence, $\tilde{P}_1 \cup \dots \cup \tilde{P}_l \cup A_1^1 \cup \dots \cup A_l^l$ contains a subpath L from the first vertex of R_1 to the first vertex of A^l not intersecting any of P_1, \dots, P_k . Thus, $A = L \cdot A^l$ is a valid outcome of the lemma.

So now suppose there are no $2k \binom{f_p(k)}{2k} \cdot 2k!$ paths with a routing sequence of type 2. Hence, there are at least $(k+1) \cdot \binom{f_p(k)}{k} \cdot k!$ paths with a routing sequence of type 1 and therefore there are $k+1$ paths $R_0, \dots, R_k \in \mathcal{R}$ with a routing sequence $(A_1^i, \dots, A_{k-1}^i, P_1, \dots, P_k)$ of type 1, for $0 \leq i \leq k$, such that R_0, \dots, R_k occur in this order on the paths P_i . Let A_0^0 be the initial subpath of R_0 from the first vertex of R_0 to the first vertex on P_1 . For $0 \leq j < k$ let \hat{P}_j be the subpath of P_j from the last vertex of A_{j-1}^{j-1} to the first vertex of A_j^j . Then $A = A_0^0 \cdot \hat{P}_1 \cdot A_1^1 \cdot \hat{P}_2 \dots A_{k-1}^{k-1}$ constitutes the required outcome of the lemma. In both cases the construction implies that the path A starts and ends on a vertex of a path in \mathcal{R} . \square

Note that, in general, it is not possible to satisfy Condition (1) and (2) of the previous lemma simultaneously.

We will use the lemma to construct a directed grid from a given web. We first consider the case of splits.

Lemma 5.20. *Let f_p, f_r be the functions defined in Lemma 5.19. For all $k \geq 0, q \geq f_p(k)$ and $p \geq f_r(k) \binom{q}{k} k!k$, if G contains a weak (p, q) -split $(\mathcal{S}_{split}, \mathcal{Q})$, then G contains a (k, k) -grid $(\mathcal{P}', \mathcal{Q}')$ with $\mathcal{Q}' \subseteq \mathcal{Q}$. Finally, if $(\mathcal{S}_{split}, \mathcal{Q})$ is well-linked then so is $(\mathcal{P}', \mathcal{Q}')$.*

Proof. W.l.o.g. we assume that $p = f_r(k) \binom{q}{k} k!k$. Let $r := \binom{q}{k} k!k$ and let $\mathcal{S}_{split} = (P_1^1, \dots, P_1^{f_r(k)}, \dots, P_r^1, \dots, P_r^{f_r(k)})$ be ordered in the order in which the paths in \mathcal{Q} traverse the paths in \mathcal{S}_{split} . By definition, for all $1 \leq i \leq r, 1 \leq j \leq f_r(k)$, the path P_i^j intersects every path in \mathcal{Q} and every path $Q \in \mathcal{Q}$ can be split into disjoint segments Q_1, \dots, Q_p occurring in this order on Q such that for all $1 \leq i \leq r, 1 \leq j \leq f_r(k)$, the path Q intersects P_i^j only in segment $Q_{p+1-(i-1) \cdot f_r(k) - j}$. For all $1 \leq i \leq r$ and $Q \in \mathcal{Q}$ let Q^i be the minimal subpath of Q containing $V(Q) \cap (\bigcup_{1 \leq j \leq f_r(k)} V(P_i^j))$ and let $\mathcal{Q}^i := \{Q^i : Q \in \mathcal{Q}\}$.

As $|\mathcal{Q}| \geq f_p(k)$, we can now apply Lemma 5.19 to $(\mathcal{Q}^i, \{P_i^1, \dots, P_i^{f_r(k)}\})$, for all $1 \leq i \leq r$, to obtain a sequence $\hat{\mathcal{Q}}^i := (Q_1^i, \dots, Q_k^i)$ of paths $Q_l^i \in \mathcal{Q}^i$ and a path A_i as in the statement of the lemma.

As $r = \binom{q}{k}k!k$, there are paths $Q_1, \dots, Q_k \in \mathcal{Q}$ and numbers $j_1 < \dots < j_k$ such that $Q_l^{j_l}$ is a subpath of Q_l , for all $1 \leq l \leq k$. Hence, $(\{A_{i_1}, \dots, A_{i_k}\}, \{Q_1, \dots, Q_k\})$ is a (k, k) -grid. As we do not split any path in \mathcal{Q} , well-linkedness is preserved. \square

We now consider the case where the result of Lemma 5.15 is a segmentation.

Lemma 5.21. *Let f_p, f_r be the functions defined in Lemma 5.19. Let t be an integer and let $q \geq f_r(3t) \cdot \binom{f_p(3t)}{3t} \cdot (3t)! \cdot 4t$ and $r \geq f_p(3t) \cdot q!$. If G contains an (r, q) -segmentation $(\mathcal{S}_{seg}, \mathcal{Q})$, then G contains a (t, t) -grid $W' = (\mathcal{P}', \mathcal{Q}')$ such that $\mathcal{P}' \subseteq \mathcal{S}_{seg}$. Furthermore, the set of start and end vertices of \mathcal{Q}' are subsets of the start and end vertices of \mathcal{Q} . In particular, if the set of start and end vertices of \mathcal{Q} is well-linked, then so is W' .*

Finally, the grid $(\mathcal{P}', \mathcal{Q}')$ can be chosen so that one (but not both) of the following properties is satisfied. Let $\mathcal{P}' := (P_1, \dots, P_t)$ be an ordering of \mathcal{P}' in order in which they occur on the paths \mathcal{Q}' of the grid.

- (1) For every $Q' \in \mathcal{Q}'$, let $Q \in \mathcal{Q}$ be the path with the same start vertex as Q' . Then the first path $P \in \mathcal{P}'$ hit by Q is P_1 .
- (2) For every $Q' \in \mathcal{Q}'$, let $Q \in \mathcal{Q}$ be the path with the same end vertex as Q' . Then the last path $P \in \mathcal{P}'$ hit by Q is P_t .

Proof. Let $\mathcal{S}_{seg} := (P_1, \dots, P_r)$ and $\mathcal{Q} := (Q_1, \dots, Q_q)$.

Note that in some sense this case is symmetric to the case of Lemma 5.20 in that here each P_i can be partitioned into segments $P_{i,1}, \dots, P_{i,q}$ so that Q_j intersects P_i only in $P_{i,j}$. So in principle the same argument as in Lemma 5.20 with the role of \mathcal{P} and \mathcal{Q} exchanged applies to get a grid. However, in this case the paths in \mathcal{Q} would be split so that the well-linkedness would not be preserved. We therefore need some extra arguments to restore well-linkedness.

By Part (1) of Lemma 5.10, there is a subset $\mathcal{P}' \subseteq \{P_1, \dots, P_r\}$ of order $f_p(3t)$ such that $(\mathcal{P}', \mathcal{Q})$ is a strong segmentation. By renumbering the paths we may assume that $\mathcal{P}' = \{P_1, \dots, P_{f_p(3t)}\}$.

Let $q' := \binom{f_r(3t)}{3t} \cdot (3t)! \cdot 4t$. Let $\mathcal{Q} := (Q_1^1, \dots, Q_1^{f_r(3t)}, \dots, Q_{q'}^1, \dots, Q_{q'}^{f_r(3t)})$ be ordered in the order in which the paths in \mathcal{Q} appear on the paths in \mathcal{P}' . As $|\mathcal{P}'| = f_p(3t)$, for every $1 \leq i \leq q'$, applying Lemma 5.19 to $(\mathcal{P}', \{Q_i^1, \dots, Q_i^{f_r(3t)}\})$, yields a sequence $\mathcal{P}_i \subseteq \mathcal{P}'$ of order $3t$ and a path A_i as in the statement of Lemma 5.19. By choosing the paths A_i according to Property (1) or (2) in Lemma 5.19, we can satisfy Condition 1 or 2 of the present lemma. In the sequel, we present the proof in case we choose the first option. The case of the second option is completely analogous. So suppose the sets \mathcal{P}_i and the paths A_i have all been chosen according to Property (1) of Lemma 5.19.

As $q' = \binom{f_r(3t)}{3t} \cdot (3t)! \cdot 4t$, there are at least $4t$ values $i_1 < \dots < i_{4t}$ such that $\mathcal{P}_{i_j} = \mathcal{P}_{i_{j'}}$, for all $1 \leq j \leq j' \leq 4t$.

Let $\mathcal{H} := (H_1, \dots, H_{3t}) := \mathcal{P}^i$ for some (and hence all) $1 \leq j \leq 4t$. \mathcal{H} will be the set of horizontal paths in the grid we construct, i.e. \mathcal{H} will play the role of \mathcal{P}' in the statement of the lemma. This implies the condition of the lemma that $\mathcal{P}' \subseteq \mathcal{S}_{seg}$. For $1 \leq j \leq 4t$, let $V_j := A_{i_j}$ and let $\mathcal{V} := \{V_1, \dots, V_{4t}\}$. Hence $(\mathcal{H}, \mathcal{V})$ is an acyclic $(3t, 4t)$ -grid, but it is not yet well-linked.

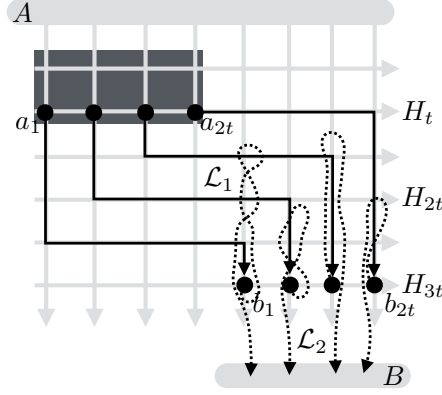

FIGURE 9. Illustration of the construction in the proof of Lemma 5.21.

In the following, let A be the set of start vertices of the paths in \mathcal{Q} and let B be the set of their end vertices. As we have chosen the sequence \mathcal{P}^i so that it satisfies Condition (1) of Lemma 5.19, all V_i start at a vertex $v_i \in A$. For $1 \leq i \leq 2t$ let a_i be a vertex in $V(V_i \cap H_{t+1})$ and let b_i be the end vertex of V_{2t+i} . Then $\mathcal{H} \cup \mathcal{V}$ contains a linkage \mathcal{L}_1 from $\{a_1, \dots, a_{2t}\}$ to $\{b_1, \dots, b_{2t}\}$ of order $2t$. See Figure 9 for an illustration (where $t = 2$).

By construction, each b_i is on a path Q_i and hence Q_i contains a subpath T_i from b_i to its endpoint in B . By construction, this path T_i does not intersect any V_1, \dots, V_{2t} and does not contain any vertex of the initial subpaths of the H_i from the beginning to their intersection with V_{2t} . Hence, T_1, \dots, T_{2t} forms a linkage \mathcal{L}_2 from b_1, \dots, b_{2t} to B . The linkage \mathcal{L}_2 is illustrated by the dotted lines in Figure 9.

By construction, \mathcal{L}_1 and \mathcal{L}_2 can be combined to form a half-integral linkage from $\{a_1, \dots, a_{2t}\}$ to B which does not intersect any V_i , with $1 \leq i \leq 2t$, at any vertex on V_i before a_i and does not intersect any H_i at any vertex before H_i intersects V_{2t} , i.e. it does not intersect the area marked in dark grey in Figure 9. By Lemma 2.12, there is an (integral) linkage \mathcal{L}' from $\{a_1, \dots, a_{2t}\}$ to B in the graph $\bigcup \mathcal{L}$ of order t . Hence, \mathcal{L}' contains t pairwise vertex disjoint paths L_1, \dots, L_t from a subset $C := \{a_{i_1}, \dots, a_{i_t}\}$ to B , such that L_l has a_{i_l} as the start vertex. By deleting all vertical paths V_j with $j \neq i_l$, for all $1 \leq l \leq t$, and joining V_{i_l} and L_l to form a new path V_{i_l}'' , we obtain a well-linked acyclic (t, t) -grid $(\{H_1, \dots, H_t\}, \{V_{i_1}'', \dots, V_{i_t}''\})$. \square

We are now ready to prove Theorem 5.4.

Proof of Theorem 5.4. Let f_p, f_r be the functions defined in Lemma 5.19. Let t, d be integers and let a (p, q) -web of avoidance d in a digraph G be given. We will determine the minimal value for p and q in the course of the proof. By Lemma 4.10, G contains a (p_1, q_1) -web with avoidance 0 as long as

$$(1) \quad p \geq \frac{d}{d-1} p_1 \quad \text{and} \quad q \geq q_1 \binom{p}{\lceil \frac{1}{d} p \rceil}.$$

As noted above, any such a (p_1, q_1) -web is a (p_1, q_1) -web with linkedness $c = p_1$. By Lemma 5.15, there is a minimal value for q_1 such that if we set

$$(2) \quad p_1 = p_2, \quad x = p_2 \quad \text{and} \quad y = f_p(3t)q_2!$$

then G contains a (p_2, q_2) -split or a $(f_p(3t)q_2!, q_2)$ -segmentation. In the first case, if

$$(3) \quad q_2 \geq f_p(t) \quad \text{and} \quad p_2 \geq f_q(t) \binom{q_2}{t} \cdot t! \cdot t,$$

then Lemma 5.20 implies that G contains an acyclic well-linked (t, t) -grid. In the other case, if

$$(4) \quad q_2 \geq f_r(t) \binom{f_p(3t)}{3t} \cdot (3t)! \cdot 4t \quad \text{and} \quad p_2 \geq f_p(3t)q_2!$$

then Lemma 5.21 implies that G contains an acyclic well-linked (t, t) -grid as required. Clearly, for any $t, d \geq 0$ we can always choose the numbers $p, p_1, p_2, q, q_1, q_2, x, y$ so that all inequalities above are satisfied, which concludes the proof. \square

As noted at the beginning of this section, the main result of this section, Theorem 5.2, follows from Theorem 5.4.

So far we have shown that every digraph which contains a large well-linked web also contains a large well-linked fence $(\mathcal{P}, \mathcal{Q})$. The well-linkedness of $(\mathcal{P}, \mathcal{Q})$ implies the existence of a minimal bottom-up linkage as defined in the following definition.

Definition 5.22. *Let $(\mathcal{P}, \mathcal{Q})$ be a fence. A $(\mathcal{P}, \mathcal{Q})$ -bottom-up linkage is a linkage \mathcal{R} from $\text{bot}(\mathcal{P}, \mathcal{Q})$ to $\text{top}(\mathcal{P}, \mathcal{Q})$. It is called minimal $(\mathcal{P}, \mathcal{Q})$ -bottom-up linkage, if \mathcal{R} is $(\bigcup \mathcal{P} \cup \bigcup \mathcal{Q})$ -minimal.*

We close this section by establishing a simple routing principle in fences which will be needed below. This is (3.2) in [42].

Lemma 5.23. *Let $(P_1, \dots, P_{2p}, Q_1, \dots, Q_q)$ be a (p, q) -fence in a digraph G , with the top A and the bottom B . Let $A' \subseteq A$ and $B' \subseteq B$ with $|A'| = |B'| = r$ for some $r \leq p$. Then there are vertex disjoint paths Q'_1, \dots, Q'_r in $\bigcup_{1 \leq i \leq 2p} P_i \cup \bigcup_{1 \leq j \leq q} Q_j$ such that $(P_1, \dots, P_{2p}, Q'_1, \dots, Q'_r)$ is a (p, r) -fence with top A' and bottom B' .*

We will also need the analogous statement for pseudo-fences which we prove next. Note that, as pseudo-fences are a special form of weak pseudo-fences, the next lemma also applies to pseudo-fences.

Lemma 5.24. *Let $(\mathcal{P}, \mathcal{Q})$ be a weak (p, q) -pseudo-fence and let A be its top and B be its bottom. Let $A' \subseteq A$ and $B' \subseteq B$ be such that $|A'| = |B'| \leq p$. Then there is an $A'-B'$ -linkage \mathcal{L} of order $\frac{1}{3}|A|$ in $\mathcal{P} \cup \mathcal{Q}$.*

Proof. Let $k := |A'|$ and let $A' := \{a_1, \dots, a_k\}$ and $B' := \{b_1, \dots, b_k\}$. Let Q_1, \dots, Q_k be the paths in \mathcal{Q} with start vertices a_1, \dots, a_k and let Q'_1, \dots, Q'_k be the paths in \mathcal{Q} with end vertices b_1, \dots, b_k . For each $1 \leq i \leq k$ let $P_i^1 := P_{2i}$ and $P_i^2 := P_{2i-1}$. This is possible as $k \leq p$. By definition of a weak pseudo-fence, there is a path L_i connecting the end of P_i^1 to the beginning of P_i^2 or vice versa. Thus, for all $1 \leq i \leq k$, $Q_i \cup P_i^1 \cup L_i \cup P_i^2 \cup Q'_i$ contains a path S_i from a_i to b_i .

Recall that for $i \neq i'$ the paths L_i and $L_{i'}$ are pairwise disjoint. Moreover, L_i is contained in the segment $Q_{2i} \cup Q_{2i-1}$ of \mathcal{Q} . This implies that no vertex of G is

contained in more than three paths of $\mathcal{S} := \{S_1, \dots, S_k\}$. This implies that there cannot be a $A'-B'$ -separator of order $< \frac{1}{3}k$ and therefore, by Menger's theorem, there is an integral $A-B$ -linkage of order $\frac{1}{3}k$ as required. \square

6. FROM FENCES TO CYLINDRICAL GRIDS

So far we have seen that every digraph of sufficiently high directed tree-width either contains a cylindrical grid or a well-linked fence. In this section we complete the proof of our main result by showing that if G contains a well-linked fence of sufficient order, then it contains a cylindrical grid of large order as a butterfly minor. The main result of this section is the following theorem, which completes the proof of Theorem 1.2.

Theorem 6.1. *Let G be a digraph. For every $k \geq 1$ there are integers $p, r \geq 1$ such that if G contains a (p, p) -fence \mathcal{F} and a minimal \mathcal{F} -bottom-up linkage \mathcal{R} of order r then G contains a cylindrical grid of order k as a butterfly minor.*

Let \mathcal{F} and \mathcal{R} be as in the statement of Theorem 6.1. We prove the theorem by analysing how \mathcal{R} intersects \mathcal{F} . Essentially, we follow the paths in \mathcal{R} from the bottom of \mathcal{F} (i.e., the start vertices of \mathcal{R}) to its top (i.e., the end vertices of \mathcal{R}) and somewhere along the way we will find a cylindrical grid of large order as a butterfly minor, either (i) because \mathcal{R} avoids a sufficiently large sub-fence, or (ii) because it contains subpaths that “jump” over large fractions of the fence or (iii) because \mathcal{R} and \mathcal{Q} intersect in a way that they generate a cylindrical grid locally. We will consider the three cases separately in the following subsections.

6.1. Bottom up linkages which avoid a sub-fence. We first prove the easiest case, namely when \mathcal{R} “avoids” a sufficiently large sub-fence of \mathcal{F} (i.e., Case (i) above). This is needed in the arguments below.

Definition 6.2 (sub-fence). *Let $\mathcal{F} := (\mathcal{P}, \mathcal{Q})$ be a fence. A sub-fence of \mathcal{F} is a fence $\mathcal{F}' := (\mathcal{P}', \mathcal{Q}')$ with $E(\mathcal{P}') \cup E(\mathcal{Q}') \subseteq E(\mathcal{Q}) \cup E(\mathcal{P})$ such that $\text{top}(\mathcal{F}') \cup \text{bot}(\mathcal{F}') \subseteq V(\mathcal{Q})$ and there are disjoint linkages $\mathcal{L}, \mathcal{L}'$ of order $|\mathcal{Q}'|$ from $\text{top}(\mathcal{F})$ to $\text{top}(\mathcal{F}')$ and from $\text{bot}(\mathcal{F}')$ to $\text{bot}(\mathcal{F})$ which are internally vertex disjoint from $\mathcal{P}' \cup \mathcal{Q}'$.*

A sub-grid of a grid is defined analogously.

To deal with Case (i) we first prove a technical lemma which essentially is [42, (3.3)].

Lemma 6.3. *For every t , if $\mathcal{F} := (\mathcal{P}, \mathcal{Q})$ is a (q, q) -fence, where $q := (t - 1)(2t - 1) + 1$, and \mathcal{R} is an \mathcal{F} -bottom-up linkage of order q such that no path in \mathcal{R} has any internal vertex in $\mathcal{P} \cup \mathcal{Q}$, then $\mathcal{P} \cup \mathcal{Q} \cup \mathcal{R}$ contains a cylindrical grid of order t as a butterfly minor.*

Proof. Let $(\mathcal{P}, \mathcal{Q})$ be a (q, q) -fence and let \mathcal{R} be a linkage of order q from the bottom $B := \text{bot}(\mathcal{F})$ to the top $A := \text{top}(\mathcal{F})$ of the fence such that no internal vertex of \mathcal{R} is in $\mathcal{P} \cup \mathcal{Q}$.

Let a_1, \dots, a_q be the elements of A and b_1, \dots, b_q be the elements of B such that \mathcal{Q} links a_i and b_i , for all $1 \leq i \leq q$. For all $1 \leq j \leq q$ let i_j be such that \mathcal{R} contains a path linking b_j and a_{i_j} . By Theorem 2.9, there is a sequence $j_1 < j_2 < \dots < j_t$ such that $i_{j_s} < i_{j_{s'}}'$ whenever $s < s'$ or there is a sequence $j_1 < j_2 < \dots < j_{2t}$ such

that $i_{j_s} > i_{j_{s'}}$ whenever $s < s'$. In either case, let \mathcal{R}' be the paths in \mathcal{R} linking b_{j_s} to $a_{i_{j_s}}$ for all $1 \leq s \leq t$ (or $1 \leq s \leq 2t$ respectively).

In the first case, by Lemma 5.23, there are two sets $\mathcal{P}', \mathcal{Q}'$ of vertex disjoint paths in $\mathcal{P} \cup \mathcal{Q}$ such that $(\mathcal{P}', \mathcal{Q}')$ is a (t, t) -fence with top $\{a_{i_{j_s}} : 1 \leq s \leq t\}$ and bottom $\{b_{j_s} : 1 \leq s \leq t\}$ and it is easily seen that \mathcal{Q}' can be chosen so that it links $a_{i_{j_s}}$ to b_{j_s} . Hence, $(\mathcal{P}', \mathcal{Q}')$ together with \mathcal{R} yields a cylindrical grid of order t , obtained by contracting each path in \mathcal{R} into a single edge.

In the second case, again by Lemma 5.23, there are vertex disjoint paths \mathcal{P}' and \mathcal{Q}' in $\mathcal{P} \cup \mathcal{Q}$ such that $(\mathcal{P}', \mathcal{Q}')$ is a $(t, 2t)$ -fence with top $\{a_{i_{j_s}} : 1 \leq s \leq 2t\}$ and bottom $\{b_{j_s} : 1 \leq s \leq 2t\}$ and it is easily seen that \mathcal{Q}' can be chosen so that it links $a_{i_{j_{2t+1-s}}}$ to b_{j_s} . Let $\mathcal{Q}' = (Q_1, \dots, Q_{2t})$ be ordered from left to right, i.e. Q_s links $a_{i_{j_{2t+1-s}}}$ to b_{j_s} . To obtain a cylindrical grid of order t , we take for each $P \in \mathcal{P}'$ the minimal subpath P^* of P containing all vertices of $V(P) \cap \bigcup_{1 \leq i \leq t} V(Q_i)$. Hence, from each such $P \in \mathcal{P}'$ we only take the “left half”. Let $\mathcal{P}^* := \{P^* : P \in \mathcal{P}'\}$. Then $(\mathcal{P}^*, \{Q_1, \dots, Q_t\})$ form a fence of order t . Furthermore, for all $1 \leq s \leq t$, $Q_s \cup R_s \cup Q_{2t+1-s} \cup R_{2t+1-s}$ constitutes a cycle C_s . Here, R_s is the path in \mathcal{R}' linking b_{i_s} to $a_{i_{j_{2t+1-s}}}$. Furthermore, C_i and C_j are pairwise vertex disjoint whenever $i \neq j$. Hence, C_1, \dots, C_t and \mathcal{P}^* together contain a cylindrical grid of order t as butterfly minor. \square

The previous lemma shows that whenever we have a fence and a bottom-up linkage \mathcal{R} disjoint from the fence, this implies a cylindrical grid of large order as a butterfly minor. We show in the next lemma that it suffices if the linkage \mathcal{R} is only disjoint from a sufficiently large sub-fence rather than from the entire fence. This lemma completes Case (i) above and will be applied frequently in the sequel to ensure that the bottom-up linkage hits every part of a very large fence.

Lemma 6.4. *For every $p \geq 1$ let $t' := 2((p-1)(2p-1)+1)$ and $t := 3t'$. Let G be a digraph containing a (t, t) -fence $\mathcal{F} := (\mathcal{P}, \mathcal{Q})$ and a linkage \mathcal{R} of order t' from the bottom of \mathcal{F} to the top. Furthermore, let $(\mathcal{P}', \mathcal{Q}')$ be a (t', t') -sub-fence \mathcal{F}' of \mathcal{F} such that*

- (1) $V(P') \cap V(R') = \emptyset$ for all $P' \in \mathcal{P}'$ and $R' \in \mathcal{R}$,
- (2) $V(Q') \cap V(R') = \emptyset$ for all $Q' \in \mathcal{Q}'$ and $R' \in \mathcal{R}$ and
- (3) \mathcal{F}' is “in the middle” of the fence \mathcal{F} , i.e. if $\mathcal{P} = (P_1, \dots, P_{2t})$ is ordered from top to bottom and $\mathcal{Q} = (Q_1, \dots, Q_t)$ is ordered from left to right, then $(\bigcup \mathcal{P}' \cup \bigcup \mathcal{Q}') \cap (P_1 \cup \dots \cup P_{2t'} \cup P_{2t-2t'} \cup \dots \cup P_{2t} \cup Q_1 \cup \dots \cup Q_{t'} \cup Q_{t-t'} \cup \dots \cup Q_t) = \emptyset$.

Then G contains a cylindrical grid of order p as a butterfly minor.

Proof. Choose a set $A := \{a_1, \dots, a_{t'}\}$ and $B := \{b_1, \dots, b_{t'}\}$ of vertices from the top and the bottom of \mathcal{F} such that \mathcal{R} links A to B . Further, let $A' := \{a'_1, \dots, a'_{t'}\}$ and $B' := \{b'_1, \dots, b'_{t'}\}$ be the top and the bottom of \mathcal{F}' such that \mathcal{Q}' contains a path linking a'_i to b'_i , for all i . We fix a plane embedding of \mathcal{F} and assume that the vertices $a_1, \dots, a_{t'}$ are ordered so that they appear from left to right on the top of \mathcal{F} and likewise for $b_1, \dots, b_{t'}$, $a'_1, \dots, a'_{t'}$ and $b'_1, \dots, b'_{t'}$.

As \mathcal{F}' is in the middle of \mathcal{F} , by Lemma 5.23, there is a linkage \mathcal{L} in $G[\mathcal{P} \cup \mathcal{Q}]$ linking B' to B . Furthermore, there is an A - A' -linkage \mathcal{L}' of order t' . Note that \mathcal{L}

and \mathcal{L}' are vertex disjoint and moreover no path in $\mathcal{L} \cup \mathcal{L}'$ contains a vertex from \mathcal{F}' except from the vertices in $A' \cup B'$. Hence, the linkages \mathcal{L}, \mathcal{R} and \mathcal{L}' can be combined to form a half-integral linkage from B' to A' . By Lemma 2.12, this yields an integral linkage \mathcal{L}'' from a subset $B'' \subseteq B'$ to a subset $A'' \subseteq A'$ of order $t'' := \frac{1}{2}t'$. By Lemma 5.23 there are paths $\mathcal{P}'', \mathcal{Q}''$ in $G[\mathcal{P}' \cup \mathcal{Q}']$ such that $(\mathcal{P}'', \mathcal{Q}'')$ yields a (t'', t'') -fence with top A'' and bottom B'' . Now we can apply Lemma 6.3 to obtain the desired cylindrical grid of order p as a butterfly minor. \square

In the sequel, we will also need the analogous statement of Lemma 6.4 for acyclic grids instead of fences. The only difference between the two cases is that in a fence, when routing from the top to the bottom, we can route paths to the left as well as to the right (as the paths in \mathcal{P} hit the vertical paths in \mathcal{Q} in alternating directions) whereas in an acyclic grid we can only route from left to right. Furthermore, we need to apply Lemma 5.5 to the middle section to obtain a fence there. Otherwise, the same proof as before establishes the next lemma.

Lemma 6.5. *For every $p \geq 1$ there is an integer t' with the following properties. Let $t := 3t'$. Let G be a digraph containing a (t, t) -grid W with bottom (b_1, \dots, b_t) and top (a_1, \dots, a_t) , both ordered from left to right, and a linkage \mathcal{R} of order t' such that \mathcal{R} joins the last third $(b_{2t'+1}, \dots, b_t)$ of the bottom vertices to the first third $(a_1, \dots, a_{t'})$ of the top vertices. Furthermore, let $W' := (\mathcal{P}', \mathcal{Q}')$ be a (t', t') -subgrid of W such that*

- (1) $V(\mathcal{P}') \cap V(\mathcal{R}') = \emptyset$ for all $P' \in \mathcal{P}'$ and $R' \in \mathcal{R}$,
- (2) $V(\mathcal{Q}') \cap V(\mathcal{R}') = \emptyset$ for all $Q' \in \mathcal{Q}'$ and $R' \in \mathcal{R}$,
- (3) W' is “in the middle” of the grid W , i.e. if $\mathcal{P} = (P_1, \dots, P_t)$ is ordered from top to bottom and $\mathcal{Q} = (Q_1, \dots, Q_t)$ is ordered from left to right, then $(\bigcup \mathcal{P}' \cup \bigcup \mathcal{Q}') \cap (P_1 \cup \dots \cup P_{t'} \cup P_{2t'+1} \cup \dots \cup P_t \cup Q_1 \cup \dots \cup Q_{t'} \cup Q_{2t'+1} \cup \dots \cup Q_t) = \emptyset$.

Then G contains a cylindrical grid of order p as a butterfly minor.

Proof. Let t' be the integer such that Lemma 5.5 guarantees that every (t', t') -grid contains a fence of order $p' := 2((p-1)(2p-1) + 1)$. We first apply Lemma 5.5 to the subgrid W' to get a (p', p') -fence \mathcal{F} in W' whose top and bottom are part of the top and bottom of W' . Let $A' := (a'_1, \dots, a'_{p'})$ be the top and let $B' := (b'_1, \dots, b'_{p'})$ be the bottom of \mathcal{F} , both ordered from left to right.

Choose a subset $\mathcal{R}' \subseteq \mathcal{R}$ of order p' and let B be the set of start vertices of the paths in \mathcal{R}' and let A be their end vertices. Choose in W a linkage L' of order p' from B' to B and a linkage L'' of order p' from A to A' . Then $L' \cup \mathcal{R}' \cup L''$ is a half-integral linkage of order $2((p-1)(2p-1) + 1)$ from B' to A' which is internally disjoint from \mathcal{F} . By Lemma 2.12, there is also an integral linkage L of order $((p-1)(2p-1) + 1)$ from B' to A' . Hence we can apply Lemma 6.3 to obtain the desired cylindrical grid of order p as a butterfly minor. \square

6.2. Taming jumps. The previous results solve the easy cases in our argument, i.e. where the bottom-up linkage \mathcal{R} avoids a large part of the fence (i.e., Case (i) from the beginning of the section). It has the following consequence that we will use in all our arguments below. Suppose \mathcal{F} is a huge fence and \mathcal{R} is an \mathcal{F} -bottom-up linkage. If \mathcal{R} avoids any small sub-fence, where “small” essentially means $4k^2$, then

this implies that $\mathcal{F} \cup \mathcal{R}$ contains a cylindrical grid of order k as a butterfly minor. Hence, for that not to happen, almost all paths of \mathcal{R} must hit every small sub-fence of \mathcal{F} . In particular, this observation will be used in the next lemma to show that \mathcal{R} not only must hit every small sub-fence, but it must in fact go through \mathcal{F} in a very nice way, namely going up “row by row”. This analysis will imply Case (ii) above. We give a formal definition and a proof of this statement next.

Definition 6.6. Let $\mathcal{F} := (\mathcal{P}, \mathcal{Q})$ with $\mathcal{P} := (P_1, \dots, P_{2p})$ and $\mathcal{Q} := (Q_1, \dots, Q_q)$ be a (p, q) -fence. For $1 \leq i \leq 2p$, the i -th row of \mathcal{F} , denoted $\text{row}_i(\mathcal{F})$, is $P_i \cup \bigcup_{1 \leq j \leq q} Q_j^i$, where Q_j^i is the subpath of Q_j starting at the first vertex of Q_j after the last vertex of $V(Q_j \cup P_{i-1})$ and ending at the last vertex of $V(Q_j \cap P_i)$ on Q_j . For $i = 1$, we take the initial subpath of Q_j up to the last vertex of $Q_j \cap P_1$. For convenience, for $i = 2p$ we let Q_j^i end at the last vertex of Q_j .

Hence, the i -th row of a fence is the union of the vertical paths between P_{i-1} and P_i , including P_i but none of P_{i-1} , so that rows are disjoint.

Definition 6.7. Let \mathcal{F} be a fence and let \mathcal{R} be an \mathcal{F} -bottom-up linkage. Let $R \in \mathcal{R}$ be a path. For some $i > j$ with $i - j \geq 2$, a jump from i to j in R is a subpath J of R which is internally vertex disjoint from \mathcal{F} such that the start vertex u of J is in row i of \mathcal{F} and its end vertex v is in row j . The length of the jump J is $i - j$.

Note that if J is a jump linking u and v , then there is no path from u to v in \mathcal{F} .

Lemma 6.8. For every $t, t' \geq 1$ there are integers $p, q, r \geq 1$ such that if $\mathcal{F} := (\mathcal{P}, \mathcal{Q})$ is a (p, q) -fence and \mathcal{R} is an \mathcal{F} -minimal \mathcal{F} -bottom-up-linkage of order r then either

- (1) $\mathcal{P} \cup \mathcal{Q} \cup \mathcal{R}$ contains a cylindrical grid of order t as a butterfly minor or
- (2) a sub-fence $(\mathcal{P}', \mathcal{Q}')$ of $(\mathcal{P}, \mathcal{Q})$ of order t' and a $(\mathcal{P}', \mathcal{Q}')$ -minimal $(\mathcal{P}', \mathcal{Q}')$ -bottom-up-linkage \mathcal{R}' of order t' such that \mathcal{R}' goes up row by row, i.e. for every $R \in \mathcal{R}'$, the last vertex of R in the i -th row of $(\mathcal{P}', \mathcal{Q}')$ occurs on R before the first vertex of the j -th row for all $j < i - 1$.

Proof. Let $t'' := 6((t - 1)(2t - 1) + 1)$, $d_{2t''} := 2t''$ and, for $0 \leq l < 2t''$, let $d_i := 20t''^2 \cdot d_{i+1}$. We define $p := 2d_0$ and $q := d_0$.

We prove the lemma by eliminating jumps in \mathcal{R} . In the first step, we eliminate jumps that jump over a large part of the fence.

Step 1. Taming long jumps. For $0 \leq l \leq 2t''$, we inductively construct a sequence of sub-fences \mathcal{F}_l of \mathcal{F} of order at least d_l , \mathcal{F}_l -minimal \mathcal{F}_l -bottom-up-linkages \mathcal{R}_l of order d_l and sets J_l of jumps such that $|J_l| = l$ and each jump in J_l is disjoint from \mathcal{F}_l and intersects \mathcal{F}_{l-1} only at its endpoints. Note that J_l is increasing in size while both \mathcal{F}_l and \mathcal{R}_l are decreasing.

We set $J_0 := \emptyset$, $\mathcal{F}_0 := \mathcal{F}$ and $\mathcal{R}_0 := \mathcal{R}$, which satisfy the case $l = 0$. Now suppose $\mathcal{F}_l, \mathcal{R}_l$ and J_l have already been constructed, for some $l \geq 0$.

If there is a path $R \in \mathcal{R}_l$ which contains a jump J in \mathcal{F}_l of length at least $5d_{l+1}$, then let i_l be the row containing its start vertex u_l and j_l be the row containing its end v_l . We set $J_{l+1} := J_l \cup \{J\}$. By construction, $i_l - j_l \geq 5d_{l+1}$. Hence, between row i_l and j_l there is a $(5d_{l+1}, d_l)$ -fence \mathcal{F}_{l+1}' . We choose a $(d_{l+1}, 2d_{l+1})$ sub-fence \mathcal{F}_{l+1}'' of \mathcal{F}_{l+1}' between row $i_l - 2d_{l+1}$ and $j_l + 2d_{l+1}$ which does not contain the at most four vertical paths containing the endpoints of J and R . This is possible as $d_i > 5d_{i+1} + 4$.

Using Lemma 5.23, we construct in $\mathcal{F}_l \cup \mathcal{R}_l$ a half-integral linkage of order $2d_{l+1}$ from the bottom of \mathcal{F}_{l+1}'' to its top as follows: we choose a subset \mathcal{R}'_l of \mathcal{R}_l of order $2d_{l+1}$, a linkage L of order $2d_{l+1}$ from the bottom of \mathcal{F}_{l+1}'' to the set of start vertices of \mathcal{R}'_l , and a linkage L' from the set of end vertices of the paths in \mathcal{R}'_l to the top of \mathcal{F}_{l+1}'' and then concatenate the paths in L, \mathcal{R}'_l and L' . The linkages L, L' exist by Lemma 5.23. Therefore, by Lemma 2.12, there also is an integral linkage \mathcal{R}'_{l+1} of order d_{l+1} from the bottom of \mathcal{F}_{l+1}'' to its top. Let \mathcal{F}_{l+1} be a (d_{l+1}, d_{l+1}) -sub-fence of \mathcal{F}_{l+1}'' whose top and bottom are the endpoints of \mathcal{R}'_{l+1} , which exists by Lemma 5.23. Let \mathcal{R}_{l+1} be an \mathcal{F}_{l+1} -minimal linkage with the same endpoints as \mathcal{R}'_{l+1} . This completes the construction of $J_l, \mathcal{F}_l, \mathcal{R}_l$ in case a path $R \in \mathcal{R}_l$ as above exists.

Otherwise, i.e. if there is no such $R \in \mathcal{R}_l$, the construction stops here.

Suppose first that we have constructed $J_l, \mathcal{F}_l, \mathcal{R}_l$ for all $l \leq 2t''$. Then we have found a sub-fence $\mathcal{F}_{2t''}$ of order $d_{2t''} = 2t''$ contained in rows j to i of \mathcal{F} , for some $j < i$, and a set \mathcal{J} of $2t''$ jumps $J_1, \dots, J_{2t''}$ such that the jump J_l that starts at u_l and ends in v_l satisfies the following:

- $i_l > i + 2t''$ and $j_l < j - 2t''$, for all $1 \leq l \leq 2t''$, and
- $i_l \geq i_{l+1} + 2t''$ and $j_l \leq j_{l+1} - 2t''$, for all $1 \leq l < 2t''$.

Recall that each J_i starts at u_i and ends in v_i . Let $s_1, \dots, s_{2t''}$ be $2t''$ vertices in $\text{top}(\mathcal{F}_{2t''})$ ordered from left to right and let $s'_1, \dots, s'_{2t''}$ be $2t''$ vertices in $\text{bot}(\mathcal{F}_{2t''})$ such that s_r and s'_r are on the same path $Q_r \in \mathcal{Q}$, for all r . It is easily seen that there is a linkage \mathcal{L}_1 with $E(\mathcal{L}_1) \subseteq E(\mathcal{F})$ of order $2t''$ linking $\{v_1, \dots, v_{2t''}\}$ to $\{s_1, \dots, s_{2t''}\}$ and a linkage \mathcal{L}_2 with $E(\mathcal{L}_2) \subseteq E(\mathcal{F})$ linking $\{s'_1, \dots, s'_{2t''}\}$ to $\{u_1, \dots, u_{2t''}\}$. Obviously, $V(\mathcal{L}_1) \cap V(\mathcal{L}_2) = \emptyset$ and they are internally disjoint from $\mathcal{F}_{t''}$. Hence, $\mathcal{L} := \mathcal{L}_1 \cup \mathcal{L}_2 \cup \mathcal{J}$ is a half-integral linkage of order $2t''$ from $\{s'_1, \dots, s'_{2t''}\}$ to $\{s_1, \dots, s_{2t''}\}$. By Lemma 2.12, \mathcal{L} contains an integral linkage \mathcal{L}' of order t'' from $\{s'_1, \dots, s'_{2t''}\}$ to $\{s_1, \dots, s_{2t''}\}$. By Lemma 6.4, $\mathcal{F}_{2t''} \cup \mathcal{L}'$ contains a cylindrical grid of order t as a butterfly minor, which is the first outcome of the lemma.

Step 2. Taming short jumps. So now suppose that the construction stops after $l < 2t''$ steps. Hence, we now have a sub-fence $\mathcal{F}' := \mathcal{F}_l = (\mathcal{P}', \mathcal{Q}')$ of order $d := d_l$ and we can choose an \mathcal{F}' -minimal \mathcal{F}' -bottom-up linkage $\mathcal{R}' \subseteq \mathcal{R}_l \cup \mathcal{F}_l$ of order t' . Note that any jump in \mathcal{R}' must come from a jump in \mathcal{R}_l . Hence, as \mathcal{R}_l does not contain any jump of length $5d_{l+1}$, \mathcal{R}' cannot contain any such long jumps.

Let $\mathcal{P}' = (P_1, \dots, P_{2d_{l+1}})$ be the ordering of \mathcal{P}' ordered from top to bottom. Let $\mathcal{P}'' := \{P_{1+10t'd_{l+1} \cdot i + (i \bmod 2)} \in \mathcal{P}' : 0 \leq i < 2t'\}$. This is well-defined as $d \geq 20t'^2 d_{l+1}$. Note that \mathcal{P}'' contains paths in alternating directions as we have added $(i \bmod 2)$ in each step.

Let \mathcal{Q}'' be a linkage in \mathcal{F}' of order t' linking the set of end vertices of \mathcal{R}' to the set of start vertices of \mathcal{R}' . Such a linkage exists by Lemma 5.23. Then $\mathcal{F}'' := (\mathcal{P}'', \mathcal{Q}'')$ is a sub-fence of \mathcal{F}' of order t' .

We claim that \mathcal{R}' traverses \mathcal{F}'' row by row. Towards a contradiction, suppose there are i, j such that $j < i - 1$ and \mathcal{R}' contains a path R which hits a vertex in row j of \mathcal{F}'' before the last vertex R has in common with row i . Note that the distance between i and j in \mathcal{F}' is at least $(i - j) \cdot 10t'd_{l+1}$.

We group the rows between row i and row j into groups H_s of $5d_{l+1}$ rows each. For $1 \leq s \leq 2t'$ let H_i be the union of the rows h of \mathcal{F}' for $i - 5d_{l+1} \cdot s \leq h < i - 5d_{l+1} \cdot (s - 1)$.

By construction, \mathcal{R}' does not contain any jump of length $5d_{l+1}$. Hence, as R goes from the bottom of \mathcal{F}' to its top, R must intersect at least one row of each H_s , $1 \leq s \leq 2t'$, before the first vertex it has in common with row j .

Furthermore, R continues from the last vertex v it has in common with row i to the top of \mathcal{F}' . Hence, after v R must again intersect at least one row in each group H_s , for $1 \leq s \leq 2t'$.

Now let e be the first edge of R after v that is not in $E(\mathcal{F}')$ (this edge must exist as R goes up) and let R_1, R_2 be the two components of $R - e$ with R_1 being the initial subpath of R . Then for each $1 \leq s \leq t'$, there is a path L_s from R_1 to R_2 in $H_{2s} \cup H_{2s-1}$. By construction, if $s \neq s'$ then $L_s \cap L_{s'} = \emptyset$. Thus there are t' vertex disjoint paths in $\mathcal{R}' \cup \mathcal{F}'$ from R_1 to R_2 which, by Lemma 2.15, contradicts the assumption that \mathcal{R}' is \mathcal{F}' -minimal. \square

6.3. Avoiding a pseudo-fence. In this subsection we prove two lemmas needed later on in the proof. Essentially, the two lemmas deal with the case that we have a fence $\mathcal{F} = (\mathcal{P}, \mathcal{Q})$ and a bottom-up linkage which avoids the paths in \mathcal{Q} . This is proved in Lemma 6.10 below. We also need a variant of it where instead of a fence we only have a *pseudo-fence*. Recall Definition 5.17 of a (weak) pseudo-fence.

Lemma 6.9. *For every $p \geq 1$ there are integers t', t'' such that if G is a digraph containing a (t'', t') -pseudo-fence $W = (\mathcal{P}, \mathcal{Q})$ and a linkage \mathcal{R} of order t' from the bottom of W to the top of W such that no internal vertex of any path in \mathcal{R} is contained in $V(\mathcal{Q})$, then G contains a cylindrical grid of order p as a butterfly minor.*

The same is true if \mathcal{W} is only a weak pseudo-fence.

Proof. Let $t'' := 2t' + t_1'' \cdot \binom{t'}{\lfloor \frac{t'}{2} \rfloor}$. Let $\mathcal{P} := (P_1, \dots, P_{2t''})$ be ordered from top to bottom, i.e. in the order in which the paths in \mathcal{P} appear on the paths in $\mathcal{Q} := (Q_1, \dots, Q_{t'})$. We will state various conditions on t' and t'' during the proof which will give us the necessary bound on t', t'' .

Let U be the subgraph of W containing $P_1, \dots, P_{2t'}$ and for each $Q \in \{Q_1, \dots, Q_{t'}\}$ the minimal initial segment of Q containing all vertices of

$$V(Q) \cap \bigcup_{1 \leq i \leq 2t'} V(P_i).$$

Analogously, let D be the lower part of W , i.e. the part formed by $P_{2t''-2t'}, \dots, P_{2t''}$ and the minimal final segments of the Q_i containing all vertices Q_i has in common with $P_{2t''-2t'}, \dots, P_{2t''}$. Finally, let M be the middle part, i.e. the subgraph of W induced by the paths $P_{2t'+1}, \dots, P_{2t''-2t'-1}$ and the subpaths of the Q_i connecting U to D . See Figure 10 a) for an illustration of the construction in this proof.

We will write $\mathcal{P}_U, \mathcal{P}'_M, \mathcal{P}_D$ for the paths in \mathcal{P} contained in U, M, D , respectively. Similarly, we write $\mathcal{Q}_U, \mathcal{Q}_M, \mathcal{Q}_D$ for the subpaths of the paths in \mathcal{Q} connecting the paths in $\mathcal{P}_U, \mathcal{P}'_M, \mathcal{P}_D$, resp.

We now divide M into two parts, M_l and M_r . For every $P \in \mathcal{P}'_M$ let $\mathcal{Q}(P) \subseteq \mathcal{Q}$ be the set of the first $\frac{t'}{2}$ paths in \mathcal{Q} that P intersects. By the pigeon hole principle, as $|\mathcal{P}'_M| \geq 2t_2'' \binom{t'}{\lfloor \frac{t'}{2} \rfloor}$ there is a subset $\mathcal{P}_M \subseteq \mathcal{P}'_M$ of order $2t_2''$ such that $\mathcal{Q}(P) = \mathcal{Q}(P')$ for all $P, P' \in \mathcal{P}'_M$. We define M_l as $\mathcal{Q}(P)$ for some (and hence all) $P \in \mathcal{P}_M$ together

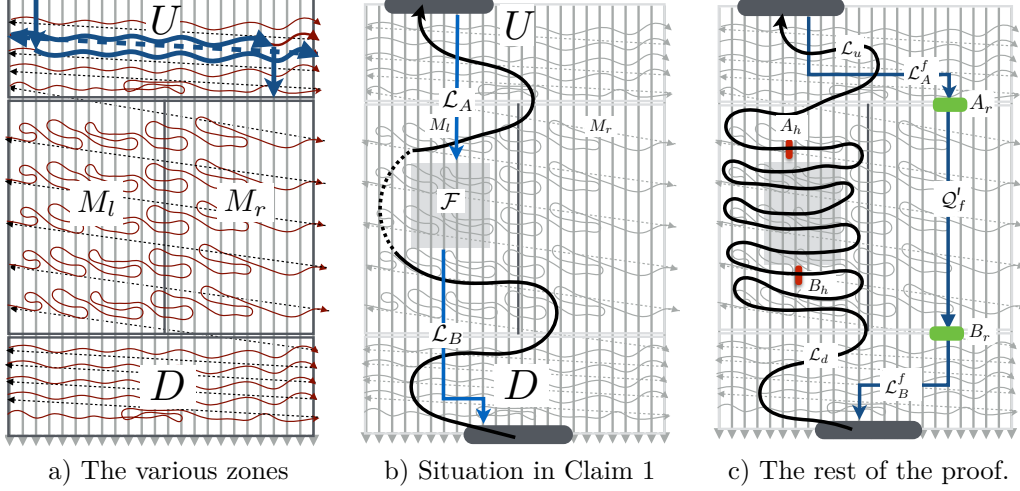

FIGURE 10. Illustration for the Proof of Lemma 6.9.

with the minimal initial subpaths of the $P \in \mathcal{P}'_M$ containing all vertices of $\mathcal{Q}(P)$. M_r contains the other paths of \mathcal{Q}_M and the parts of the paths of \mathcal{P}'_M not contained in M_l . We write $\mathcal{P}_{M_l}, \mathcal{P}_{M_r}$ and $\mathcal{Q}_{M_l}, \mathcal{Q}_{M_r}$ for the corresponding paths.

To simplify the presentation we rename the paths in $\mathcal{P}_U, \mathcal{P}_M, \mathcal{P}_D$ such that $\mathcal{P}_U := (P_1^u, \dots, P_{2t'}^u)$, $\mathcal{P}_M := (P_1^m, \dots, P_{2t''}^m)$ and $\mathcal{P}_D := (P_1^d, \dots, P_{2t''}^d)$.

Observe that $(\mathcal{Q}_{M_l}, \mathcal{P}_{M_l})$ forms a strong $(\frac{1}{2}t', 2t'')$ -segmentation. Let f_r, f_p be the functions defined in Lemma 5.19. We require that $t' \geq f_p(t'_1)$ and $t'' \geq t'_1 \cdot f_r(t'_1)$, for some t'_1, t''_1 determined below. For each $1 \leq j \leq t'_1$ we apply Lemma 5.19 to each of the strong $(f_r(t'_1), f_p(t'_1))$ -segmentations $(\mathcal{Q}_{M_l}, \{P_{(j-1) \cdot f_p(t'_1)+1}^m, \dots, P_{j \cdot f_p(t'_1)}^m\})$ to obtain for each j a sequence $\hat{\mathcal{Q}}^j := (\hat{Q}_1^j, \dots, \hat{Q}_{t'_1}^j)$ of paths in \mathcal{Q}_{M_l} and a path L_j as in the statement of the lemma. In particular, L_j intersects each \hat{Q}_i^j in a path and the paths $\hat{Q}_1^j, \dots, \hat{Q}_{t'_1}^j$ occur in this order on L_j .

Now, as we require $t''_1 \geq t''_2 \cdot \left(\frac{1}{2}t'_1\right) \cdot t'_1!$, there are indices $1 \leq j_1 < j_2 \cdots < j_{t''_2} \leq t''_1$ such that $\hat{\mathcal{Q}}^{j_i} = \hat{\mathcal{Q}}^{j_{i'}}$ for all $1 \leq i < i' \leq t''_2$. W.l.o.g. we may assume that $j_i = i$, for all $1 \leq i \leq t''_2$, and $\hat{\mathcal{Q}}^{j_i} = (Q_1, \dots, Q_{t'_1})$. Let $\mathcal{L} := (L_1, \dots, L_{t''_2})$ and $\hat{\mathcal{Q}} := (Q_1, \dots, Q_{t'_1})$. Thus, $(\mathcal{L}, \hat{\mathcal{Q}})$ form an acyclic (t''_2, t'_1) -grid \mathcal{H} .

We require that t''_2, t'_1 are large enough so that when we apply Lemma 5.5 to \mathcal{H} we obtain a (t''_3, t'_2) -fence \mathcal{H}' whose top and bottom is part of the top and bottom of \mathcal{H} , for some numbers t''_3, t'_2 to be determined below.

Let A be the end vertices of \mathcal{R} and B be the start vertices of \mathcal{R} . Hence, A is contained in the top of the pseudo-fence W and B is part of its bottom. We now take a new linkage $\mathcal{R}_1 \subseteq G[V(\mathcal{R}) \cup V(\mathcal{P}_U) \cup V(\mathcal{P}_D) \cup (V(\mathcal{Q}) \setminus V(\mathcal{Q}_{M_r} \cup \mathcal{Q}_{M_l})) \cup \mathcal{H}']$ from B to A of order $|\mathcal{R}|$ such that \mathcal{R}_1 is \mathcal{H}' -minimal. Since no internal vertex of any path in \mathcal{R} is contained in $V(\mathcal{Q})$, such a choice is possible. Note that $\mathcal{R}_1 \cap \mathcal{Q}_{M_r} = \emptyset$.

We now apply Lemma 6.8 to \mathcal{H}' and \mathcal{R}_1 . For this, we require that t', t''_3, t'_2 are big enough so that if we apply Lemma 6.8 to \mathcal{H}' and \mathcal{R}_1 then we either get a cylindrical

grid of order p or a sub-fence \mathcal{H}'' of \mathcal{H}' of order r_2 and a \mathcal{H}'' -minimal bottom-up linkage $\mathcal{R}_2 \subseteq \mathcal{R}_1$ of order r_2 which goes up \mathcal{H}'' row-by-row as in the statement of the lemma.

In the first case, i.e. if we get a cylindrical grid of order p as outcome, we are done. So we may assume that the second case applies and hence we get a sub-fence $\mathcal{H}'' \subseteq \mathcal{H}'$ and a bottom-up linkage $\mathcal{R}_2 \subseteq \mathcal{R}_1 \cup \mathcal{H}'$ of order r_2 which goes up \mathcal{H}'' row-by-row. Let \mathcal{H}_2 be a sub-fence of \mathcal{H}'' of order t_4 for some number t_4 to be determined below which consists of t_4 vertical paths of \mathcal{H}'' and $2t_4$ horizontal paths.

Let H_1, \dots, H_{2t_4} be the horizontal paths of \mathcal{H}_2 and V_1, \dots, V_{t_4} be the vertical paths. Let $w' = 2((p-1)(2p-1) + 1)$ and $w := 18w'$. We require that $t_4 \geq 2 \cdot t_5 \cdot w$ for some number t_5 determined below. For each $1 \leq j \leq 2t_5$ let \mathcal{H}^j be the sub-fence of \mathcal{H}'' comprising the paths $H_{(j-1) \cdot w + 1}, \dots, H_{j \cdot w}$ and the minimal subpaths of the V_i connecting $H_{(j-1) \cdot w + 1}$ and $H_{j \cdot w}$.

Claim 1. There is a number r_6 such that if there is an index $1 \leq j \leq 2t_5$ and a sub-linkage $\mathcal{R}_3 \subseteq \mathcal{R}_2$ of order r_6 such that \mathcal{R}_3 is disjoint from \mathcal{H}^j then G contains a cylindrical grid of order p as a butterfly minor.

Proof. See Figure 10 b) for an illustration of this step of the proof. Let A' be the top of \mathcal{H}^j and B' be its bottom. Recall that by construction the vertices in A' are on distinct paths of \mathcal{Q}_l and so are the vertices of B' . Let B'' be the start vertices of \mathcal{R}_3 . Thus taking the paths in \mathcal{Q}_l down from B' to D and applying Lemma 5.24, yields a linkage \mathcal{L}_B of order $\frac{1}{3}w$ from B' to B'' . Let B''' be the end vertices of the linkage \mathcal{L}_B and let A''' be the end vertices of the paths in \mathcal{R}_3 starting at B''' . Again, by applying Lemma 5.24, we obtain a linkage \mathcal{L}_A from A''' to A' of order $\frac{1}{9}w$. Thus, $\mathcal{L}_A \cup \mathcal{R}_3 \cup \mathcal{L}_B$ contains a half-integral linkage \mathcal{L} from B' to A' of order $\frac{1}{18}w$ which, by construction, is disjoint from \mathcal{H}^j . Let $A_l \subseteq A'$ be the end vertices of \mathcal{L} and B_l be its start vertices.

We now apply Lemma 5.23 to \mathcal{H}_j to get a sub-fence \mathcal{H}'_j of \mathcal{H}_j with top A_l and bottom B_l of order $\frac{1}{18}w = w' \geq (p-1)(2p-1) + 1$. Applying Lemma 6.3 to \mathcal{H}'_j and \mathcal{L} yields a cylindrical grid of order p as required. \dashv

By Claim 1 we may now assume that for each block \mathcal{H}_j there are fewer than r_6 paths in \mathcal{R}_2 with an empty intersection with \mathcal{H}^j .

Now we take the blocks \mathcal{H}_{2j} for $1 \leq j \leq t_5$. Thus there is a linkage $\mathcal{R}_3 \subseteq \mathcal{R}_2$ of order $r_3 := r_2 - t_5 \cdot r_6$ such that every path in \mathcal{R}_3 intersects in each \mathcal{H}_{2j} , $1 \leq j \leq t_5$, at least one path. We require that $r_3 \geq r_4 \cdot (t_4 + 2w)^{t_5}$ (observe that $t_4 + 2w$ is the total number of t_4 vertical and $2w$ horizontal paths in any \mathcal{H}^j). By the pigeon hole principle, we can thus take a linkage $\mathcal{R}_4 \subseteq \mathcal{R}_3$ of order r_4 such that every path $R \in \mathcal{R}_4$ intersects in each block \mathcal{H}^j the same path I^j .

As \mathcal{R}_2 goes up \mathcal{H}_2 row by row, $(\{I^j : 1 \leq j \leq t_5\}, \mathcal{R}_4)$ is a weak (t_5, r_4) -split. We require that t_5 and r_4 are large enough so that applying Lemma 5.20 yields an (p_5, p_5) -grid $\mathcal{H}_3 = (\mathcal{I}, \mathcal{R}_5)$ with $\mathcal{R}_5 \subseteq \mathcal{R}_4$. Furthermore, we require that p_5 is large enough so that we can apply Lemma 5.5 to get a (p_6, p_6) -fence $\mathcal{F} = (\mathcal{I}', \mathcal{R}_6)$ whose top and bottom is contained in the top and bottom of \mathcal{H}_3 . Note that the fence \mathcal{H}_3 "goes upwards" with respect to the original pseudo-fence W , i.e. the top B_h of \mathcal{H}_3 occurs on the paths in \mathcal{R}_5 before its bottom A_h .

Recall that A is the set of end vertices of \mathcal{R} and B the set of start vertices. Thus \mathcal{R}_5 contains a linkage \mathcal{L}_u from A_h to A of order p_6 . Let $A_f \subseteq A$ be the set of end vertices of \mathcal{L}_u . Similarly, \mathcal{R}_5 contains a linkage \mathcal{L}_d from B to B_h of order p_6 . Let B_f be the set of start vertices of \mathcal{L}_d .

We choose a linkage $\mathcal{Q}_f \subseteq \mathcal{Q}_r$ of order p_6 in \mathcal{Q}_r . Let A_r be the start vertices of \mathcal{Q}_f . See Figure 10 c) for an illustration of this step.

By Lemma 5.24 there is a linkage \mathcal{L}_A^f from A_f to A_r of order $\frac{1}{3}p_6$. We require $p_6 \geq 18p$. Let $A_r' \subseteq A_r$ be the set of end vertices of \mathcal{L}_A^f , let $\mathcal{Q}_f' \subseteq \mathcal{Q}_f$ be the set of paths with start vertices in A_r' , and let B_r be the end vertices of \mathcal{Q}_f' . Again by Lemma 5.24, there is a linkage \mathcal{L}_B^f from B_r to B_f of order $\frac{1}{9}p_6$.

Thus $\mathcal{L}_u \cup \mathcal{L}_A^f \cup \mathcal{Q}_f' \cup \mathcal{L}_B^f \cup \mathcal{L}_d$ contains a half-integral linkage from A_h to B_h and therefore an integral linkage \mathcal{L}^f from A_h to B_h of order $\frac{1}{18}p_6$.

Finally, we require that p_6 is large enough so that we can apply Lemma 6.4 to \mathcal{F} and \mathcal{F}^f to get a cylindrical grid of order p as required. \square

We now prove the result mentioned above that if we have a fence with a bottom-up linkage avoiding the vertical paths then we also have a cylindrical grid of large order as a butterfly minor. Towards this aim, observe that if $(\mathcal{P}, \mathcal{Q})$ is a $(p, q+1)$ -fence, with $\mathcal{P} := (P_1^1, P_1^2, \dots, P_p^1, P_p^2)$ ordered from top to bottom and $\mathcal{Q} := (Q_1, \dots, Q_{q+1})$ ordered from left to right, then for each $1 \leq i \leq p$ the path Q_{q+1} contains an edge from the last vertex of P_i^1 to the start vertex of P_i^2 . I.e. $(\mathcal{P}, \mathcal{Q})$ contains a (p, q) -pseudo-fence as subgraph. The next lemma therefore follows immediately from the previous lemma.

Lemma 6.10. *For every $p \geq 1$ there is an integer t' such that if G is a digraph containing a (t, t) -fence $W = (\mathcal{P}, \mathcal{Q})$, for some $t \geq 3 \cdot t'$, and a linkage \mathcal{R} of order t' from bottom of W to top of W such that no path in \mathcal{R} contains any vertex of $V(\mathcal{Q})$, then G contains a cylindrical grid of order p as a butterfly minor.*

6.4. Constructing a Cylindrical Grid. In this section we complete the proof of our main result, Theorem 3.7, and thus also of Theorem 1.2.

The starting point is Theorem 5.2, i.e. we assume that there are linkages \mathcal{P} of order $6p$ and \mathcal{Q} of order q forming a well-linked fence. Let $\mathcal{F} := (\mathcal{P}, \mathcal{Q})$ with $\mathcal{P} := (P_1, \dots, P_{6p})$ and $\mathcal{Q} := (Q_1, \dots, Q_q)$ be a $(3p, q)$ -fence with top $A := \{a_1, \dots, a_q\}$ and bottom $B := \{b_1, \dots, b_q\}$. Let a_i and b_i be the endpoints of Q_i , for all $1 \leq i \leq q$. Recall that we assume that \mathcal{P} and \mathcal{Q} are ordered from top to bottom and from left to right, respectively. We divide \mathcal{F} into three parts $\mathcal{F}_1, \mathcal{F}_2, \mathcal{F}_3$, where, for $i = 1, 2, 3$, \mathcal{F}_i consists of the paths P_j with $2(i-1)p+1 \leq j \leq 2ip$ together with the subpaths of the paths Q in \mathcal{Q} from the first vertex that Q has in common with $P_{2(i-1)p+1}$ (or the first vertex of Q in case $i = 1$) and the last vertex of Q before Q intersects P_{2p+1} (or the last vertex of Q in case $i = 3$). See Figure 11.

Let $\mathcal{R} = \{R_1, \dots, R_{\frac{q}{3}}\}$ be such that the linkage \mathcal{R} joins the last third $(b_{\frac{2}{3}q+1}, \dots, b_q)$ of the bottom vertices to the first third $(a_1, \dots, a_{\frac{q}{3}})$ of the top vertices. By Lemma 6.8, we may assume that \mathcal{R} goes up row by row in \mathcal{F} . We define the following notation for the rest of this section.

- Let x_i be the last vertex of R_i in \mathcal{F}_3 for $i = 1, \dots, \frac{q}{3}$. Let $X = \{x_1, \dots, x_{\frac{q}{3}}\}$.
- Let y_i be the first vertex of R_i in \mathcal{F}_1 for $i = 1, \dots, \frac{q}{3}$. Let $Y = \{y_1, \dots, y_{\frac{q}{3}}\}$.

- Let \mathcal{R}' be the linkage obtained from \mathcal{R} by taking the subpath of each path in \mathcal{R} between one endpoint in X and the other endpoint in Y .
- Let a'_i be the first vertex of Q_i in \mathcal{F}_2 , for $1 \leq i \leq q$. Let $A' = \{a'_1, \dots, a'_q\}$.
- Let b'_i be the last vertex of Q_i in \mathcal{F}_2 , for $1 \leq i \leq q$. Let $B' = \{b'_1, \dots, b'_q\}$.
- Let Q'_i be the subpath of Q_i between a'_i and b'_i for $i = 1, \dots, q$. Let $\mathcal{Q}' = \{Q'_1, \dots, Q'_q\}$.

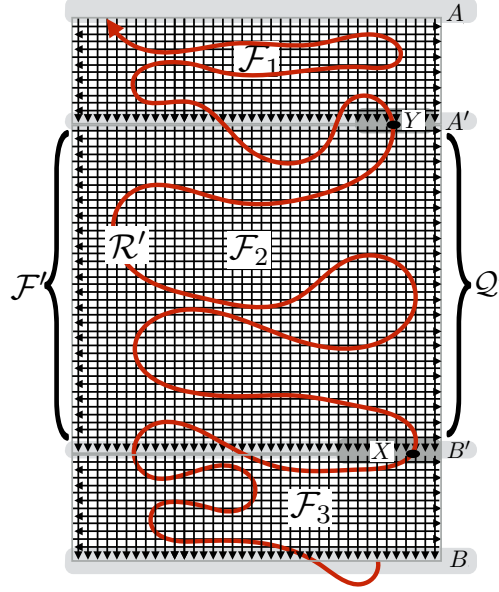

FIGURE 11. Schematic overview of the situation in Section 6.4.

Let $\mathcal{F}' = \bigcup \mathcal{Q}' \cup \bigcup \mathcal{R}' \cup \bigcup \{P_i : 2p+1 \leq i \leq 4p\}$. Figure 11 illustrates the notation introduced so far. By our assumption, no vertex in \mathcal{F}' is in \mathcal{F}_1 or in \mathcal{F}_3 , except for the endpoints of paths in $\mathcal{Q}' \cup \mathcal{R}'$.

The next goal of our proof, which is Lemma 6.11 – the most technical in this section – is to further develop the structure in \mathcal{F}' in the following way: we have a linkage $\mathcal{R}'' \subseteq \mathcal{R}'$ of large order and a linkage \mathcal{Q}'' in \mathcal{F}' of large order such that for every $Q \in \mathcal{Q}''$ there is a split edge $e(Q) \in E(Q) \setminus E(\mathcal{R}'')$ splitting Q into two subpaths $l(Q)$ and $u(Q)$ with $Q = u(Q)e(Q)l(Q)$. Furthermore, for every $R \in \mathcal{R}''$ there are distinct edges $e_1(R), e_2(R)$ splitting R into subpaths $l(R), u_1(R)$ and $u_2(R)$ such that $R = l(R)e_1(R)u_1(R)e_2(R)u_2(R)$ and

- (1) the subpath $u_1(R)e_2(R)u_2(R)$ does not intersect $l(Q)$ for every $Q \in \mathcal{Q}''$
- (2) $u_1(R)$ and $u_2(R)$ both intersect every $u(Q)$ for $Q \in \mathcal{Q}''$
- (3) $l(R)$ intersects every $l(Q)$ for $Q \in \mathcal{Q}''$ (but may also intersect $u(Q)$).

More precisely, we show the following lemma.

Lemma 6.11. *For every t, r', q' there are r, q, q^* and p , where q^* only depends on q' and t but not on r' , such that if $\mathcal{R}', \mathcal{Q}'$ and \mathcal{P} are as above and of order r, q and $3p$, respectively, then either G contains a cylindrical grid of order t as a butterfly minor or there is a linkage $\mathcal{R}'' \subseteq \mathcal{R}'$ of order r' and a linkage \mathcal{Q}'' in \mathcal{F}' of order q' such*

that the start and endpoints of paths in \mathcal{Q}'' come from the set of start and endpoints of the paths in \mathcal{Q}' and such that every $Q \in \mathcal{Q}''$ hits every $R \in \mathcal{R}''$. Furthermore, for every $Q \in \mathcal{Q}''$ and every $e \in E(Q) \setminus E(\mathcal{R}'')$ there are at most q^* paths from Q_1 to Q_2 in $\mathcal{R}'' \cup \mathcal{Q}'' - e$, where $Q = Q_1 e Q_2$.

In addition, for every $Q \in \mathcal{Q}''$ there is an edge $e = e(Q) \in E(Q) \setminus E(\mathcal{R}'')$ splitting Q into two subpaths $l(Q)$ and $u(Q)$ with $Q = u(Q) e l(Q)$ and for every $R \in \mathcal{R}''$ there are edges $e_1 = e_1(R), e_2 = e_2(R)$ splitting R into three subpaths R_1, R_2, R_3 with $R = R_1 e_1 R_2 e_2 R_3$ such that R_2 and R_3 both intersect $u(Q)$ for all $Q \in \mathcal{Q}''$ but not $l(Q)$ and R_1 intersects $l(Q)$ for all $Q \in \mathcal{Q}''$.

Proof. Let g be the function implicitly defined in Lemma 6.10, i.e. let $g : \mathbb{N} \rightarrow \mathbb{N}$ be such that if $t' = g(p)$ then the condition of Lemma 6.10 is satisfied. Furthermore, let $f_r, f_p : \mathbb{N} \rightarrow \mathbb{N}$ be the functions defined in Lemma 5.19. Starting from $\mathcal{R}', \mathcal{Q}'$ and \mathcal{P} , in the course of the proof we will take several subsets of these of decreasing order and split paths in other ways. Instead of calculating numbers directly we will state the necessary conditions on the order of these sets as we go along.

In analogy to Definition 6.6 we divide \mathcal{F}_2 into rows $\mathcal{Z}_0, \dots, \mathcal{Z}_{k+1}$ ordered from top to bottom, each containing $2 \cdot q_1$ paths from \mathcal{P} . We require

$$(5) \quad p \geq (k+2) \cdot 2q_1$$

$$(6) \quad k \geq 2 \cdot q_2.$$

\mathcal{R}'

Recall that \mathcal{R}' consists of subpaths of paths $R_i \in \mathcal{R}$ starting at x_i and ending at y_i . As by assumption \mathcal{R} goes up row by row, the initial subpath of R_i from its beginning to x_i may contain some vertices of \mathcal{F}_2 but only in row \mathcal{Z}_{k+1} . Similarly, the final subpath of R_i from y_i to the end can contain vertices of \mathcal{F}_2 but only in \mathcal{Z}_0 . Hence, $R_i \cap \bigcup_{j=1}^k \mathcal{Z}_j \subseteq \mathcal{R}'$.

$\mathcal{Z}, \mathcal{P}_Z \subseteq \mathcal{P}$
 \mathcal{Q}_Z

Let $\mathcal{Z} := \bigcup_{i=1}^k \mathcal{Z}_i$ and let $\mathcal{P}_Z \subseteq \mathcal{P}$ be the set of paths in \mathcal{P} contained in \mathcal{Z} and let \mathcal{Q}_Z be the maximal subpaths of paths in \mathcal{Q} which are entirely contained in \mathcal{Z} . Finally, for every $1 \leq i \leq k$ let $\mathcal{Q}_{\mathcal{Z}_i}$ be the maximal subpaths of the paths in \mathcal{Q} contained in \mathcal{Z}_i .

Recall that \mathcal{R}' consists of subpaths of \mathcal{R} and that \mathcal{R} is a bottom up linkage which, by the assumption above, goes up row by row. Hence, \mathcal{R}' also goes up row by row in terms of \mathcal{Z} within \mathcal{F}_2 .

The rest of the proof of this lemma goes as follows: We first show that there is no row \mathcal{Z}_i and sets $\mathcal{Q}_1 \subseteq \mathcal{Q}$ and $\mathcal{R}_1 \subseteq \mathcal{R}'$, both of large order, such that $V(\mathcal{Q}_1) \cap V(\mathcal{Z}_i) \cap V(\mathcal{R}_1) = \emptyset$. This actually means that there is no subset $\mathcal{R}_1 \subseteq \mathcal{R}'$ that ‘‘jumps’’ over some row \mathcal{Z}_i . Otherwise, a reduction to Lemma 6.10 will lead to a cylindrical grid of order t as a butterfly minor.

We then start constructing a desired structure in several steps. In Step 1 below, roughly, we obtain a grid $\mathcal{H} := (\mathcal{B}', \mathcal{R}_3)$ such that $\mathcal{R}_3 \subseteq \mathcal{R}'$ and the paths in \mathcal{B}' start and end on vertices of paths in \mathcal{Q}' . To obtain such a grid we apply Lemma 5.19. Thus the statements in Lemma 5.19 also hold for this grid \mathcal{H} .

Next in Step 2 we take an \mathcal{R}_3 -minimal linkage \mathcal{Q}_3 such that the start and end vertices of the paths in \mathcal{Q}_3 are from the set of start and end vertices of the maximal subpaths of \mathcal{Q}' in \mathcal{Z} . Then in Claim 2 below, we do have many ‘‘jumps’’ over some big part of the grid \mathcal{H} . Note that unlike in the lemmas above, here the jumps go downwards. See Figure 12 for an illustration of constructing a cylindrical grid of order t as a butterfly minor, if many such jumps exist.

Now Steps 1 and 2 allow us to show that there are desired linkages $\mathcal{R}'' \subseteq \mathcal{R}'$ of order r'' and a linkage \mathcal{Q}'' in \mathcal{F}' of order q'' , that are obtained from \mathcal{Q}_3 and \mathcal{R}_3 by possibly shrinking or taking some subset of them.

Now let us begin with Claim 1. For the following claim we require

$$(7) \quad q_1 \geq 2 \cdot g(t).$$

Claim 1. If there is a row \mathcal{Z}_i , for some $1 \leq i \leq k$, and sets $\mathcal{Q}_1 \subseteq \mathcal{Q}$ and $\mathcal{R}_1 \subseteq \mathcal{R}'$, both of order q_1 , such that $V(\mathcal{Q}_1) \cap V(\mathcal{Z}_i) \cap V(\mathcal{R}_1) = \emptyset$ then G contains a cylindrical grid of order t as a butterfly minor.

Proof. Suppose \mathcal{Q}_1 and \mathcal{R}_1 exist. Let $\mathcal{P}_{\mathcal{Z}_i}$ be the set of paths from \mathcal{P} contained in \mathcal{Z}_i and let $\mathcal{Q}_{\mathcal{Z}_i}^1$ be the subpaths of paths in \mathcal{Q}_1 restricted to \mathcal{Z}_i . Then $(\mathcal{P}_{\mathcal{Z}_i}, \mathcal{Q}_{\mathcal{Z}_i}^1)$ form a (q_1, q_1) -fence such that \mathcal{R}_1 avoids $\mathcal{Q}_{\mathcal{Z}_i}^1$. Let $A_{\mathcal{Z}_i} \subseteq A$ and $B_{\mathcal{Z}_i} \subseteq B$ be the end points and start points of the paths in \mathcal{R}_1 , respectively. Let $A'_{\mathcal{Z}_i}$ be the set of start points and $B'_{\mathcal{Z}_i}$ be the set of end points of $\mathcal{Q}_{\mathcal{Z}_i}^1$. Then, in \mathcal{F} , there is a linkage \mathcal{L}_A from $A_{\mathcal{Z}_i}$ to $A'_{\mathcal{Z}_i}$ of order q_1 and there is a linkage \mathcal{L}_B of order q_1 from $B'_{\mathcal{Z}_i}$ to $B_{\mathcal{Z}_i}$ such that these two linkages are internally disjoint from $(\mathcal{P}_{\mathcal{Z}_i}, \mathcal{Q}_{\mathcal{Z}_i}^1)$. Hence, $\mathcal{L}_A \cup \mathcal{L}_B \cup \mathcal{R}_1$ forms a half-integral linkage from the bottom $B'_{\mathcal{Z}_i}$ to the top $A'_{\mathcal{Z}_i}$ of the fence $(\mathcal{P}_{\mathcal{Z}_i}, \mathcal{Q}_{\mathcal{Z}_i}^1)$. By Lemma 2.12, there also exists an integral linkage $\mathcal{L} \subseteq \mathcal{L}_A \cup \mathcal{L}_B \cup \mathcal{R}_1$ of order $\frac{q_1}{2} = g(t)$ from $B'_{\mathcal{Z}_i}$ to $A'_{\mathcal{Z}_i}$. Hence, by Lemma 6.10, G contains a cylindrical grid of order t as a butterfly minor as required. \dashv

By the previous claim, we can now assume that in each row \mathcal{Z}_i at most $q_1 \cdot \binom{q}{q_1}$ paths in \mathcal{R}' avoid at least q_1 paths in \mathcal{Q}' restricted to \mathcal{Z}_i . For otherwise, by the pigeon hole principle there would be a row \mathcal{Z}_i and a set $\mathcal{R}_1 \subseteq \mathcal{R}'$ of order q_1 such that every $R \in \mathcal{R}_1$ avoids the same set $\mathcal{Q}_1 \subseteq \mathcal{Q}_{\mathcal{Z}_i}$ of at least q_1 paths. Hence, by the previous claim, this would imply a cylindrical grid of order t as a butterfly minor. The rest of the proof needs several steps.

Step 1. Let us now consider the rows $\mathcal{Z}' := \{\mathcal{Z}_{2i} : 1 \leq i \leq q_2\}$, which is possible as $k \geq 2q_2$. It follows that there is a set $\mathcal{R}_2^* \subseteq \mathcal{R}'$ of order $r_2^* := r - q_2 \cdot q_1 \cdot \binom{q}{q_1}$ such that in each $Z \in \mathcal{Z}'$ each path of \mathcal{R}_2^* hits all but at most q_1 paths in \mathcal{Q}' restricted to row Z . As we require

$$(8) \quad r \geq q_2 \cdot q_1 \cdot \binom{q}{q_1} + \binom{q}{q_1}^{q_2} \cdot r_2$$

and therefore $r_2^* \geq \binom{q}{q_1}^{q_2} \cdot r_2$, we can find a set $\mathcal{R}_2 \subseteq \mathcal{R}_2^*$ of order r_2 such that any two paths in \mathcal{R}_2 hit in each row $Z \in \mathcal{Z}'$ exactly the same set $\mathcal{Q}'_Z \neq \emptyset$ of paths in \mathcal{Q}' restricted to Z . We now choose in each row $\mathcal{Z}_{2i} \in \mathcal{Z}'$, for $1 \leq i \leq q_2$, a path $Q_{2i} \in \mathcal{Q}'_{\mathcal{Z}_{2i}}$ such that every $R \in \mathcal{R}_2$ has a non-empty intersection with Q_{2i} in \mathcal{Z}_{2i} . For all $1 \leq i \leq q_2$ let Q_i^2 be the restriction of Q_{2i} to row $\mathcal{Z}_{2i} \in \mathcal{Z}'$ and let $\mathcal{Q}_2 := \{Q_i^2 : 1 \leq i \leq q_2\}$.

As \mathcal{R}' , and hence \mathcal{R}_2 , goes up row by row, it follows that all paths in \mathcal{R}_2 go through the paths in \mathcal{Q}_2 strictly in the same order $Q_{q_2}^2, \dots, Q_1^2$. Hence, $(\mathcal{Q}_2, \mathcal{R}_2)$ forms a weak (q_2, r_2) -split of $(\mathcal{Q}', \mathcal{R}_2)$ (recall Definition 5.8 of weak splits). We

require

$$(9) \quad r_2 \geq f_p(r_3)$$

$$(10) \quad q_2 \geq f_q(q_5) \binom{r_2}{r_3} r_3! q_5,$$

where f_p, f_q are the functions defined in Lemma 5.19.

W.l.o.g. we assume that $q_2 = f_q(q_5) \binom{r_2}{r_3} r_3! q_5$. Let $q_2^* := \binom{r_2}{r_3} r_3! q_5$. For ease of presentation we renumber the paths in \mathcal{Q}_2 as $(Q_1^1, \dots, Q_1^{f_q(q_5)}, \dots, Q_{q_2^*}^1, \dots, Q_{q_2^*}^{f_q(q_5)})$ in the order in which the paths in \mathcal{R}_2 traverse the paths in \mathcal{Q}_2 . By definition, for all $1 \leq i \leq q_2^*, 1 \leq j \leq f_q(q_5)$, the path Q_i^j intersects every path in \mathcal{R}_2 and every path $R \in \mathcal{R}_2$ can be split into disjoint segments R_1, \dots, R_{q_2} occurring in this order on R such that for all $1 \leq i \leq q_2^*, 1 \leq j \leq f_q(q_5)$, the path R intersects Q_i^j only in segment $R_{q_2+1-(i-1) \cdot f_q(q_5)-j}$.

For all $1 \leq i \leq q_2^*$ and $R \in \mathcal{R}_2$ let R^i be the minimal subpath of R containing $V(R) \cap (\bigcup_{1 \leq j \leq f_q(q_5)} V(Q_i^j))$ and let $\mathcal{R}_2^i := \{R^i : R \in \mathcal{R}_2\}$. As $|\mathcal{R}_2| \geq f_p(r_3)$,

we can now apply Lemma 5.19 to $(\mathcal{R}_2^i, \{Q_i^1, \dots, Q_i^{f_q(q_5)}\})$, for all $1 \leq i \leq q_2^*$, to obtain a sequence $\hat{\mathcal{R}}_2^i := (R_1^i, \dots, R_{r_3}^i)$ of paths $R_j^i \in \mathcal{R}_2^i$ and a path A_i as in the statement of the lemma. As $q_2 \geq q_2^* f_q(q_5)$ and $q_2^* = \binom{r_2}{r_3} r_3! q_5$, there are paths

$R_1, \dots, R_{r_3} \in \mathcal{R}_2$ and q_5 values $i_1 < \dots < i_{q_5}$ such that $R_s^{i_l}$ is a subpath of R_s , for all $1 \leq l \leq q_5, 1 \leq s \leq r_3$. For $1 \leq l \leq q_5$ let $B_l := A_{i_l}$ and let $\mathcal{B}' := \{B_1, \dots, B_{q_5}\}$ and $\mathcal{R}_3 := \{R_1, \dots, R_{r_3}\}$. Hence, $\mathcal{H} := (\mathcal{B}', \mathcal{R}_3)$ forms a (q_5, r_3) -grid such that $\mathcal{R}_3 \subseteq \mathcal{R}_2$.

W.l.o.g. let $\mathcal{R}_3 := (R_1, \dots, R_{r_3})$ be ordered in the order in which the paths in \mathcal{R}_3 occur on the grid \mathcal{H} , from left to right, and let $\mathcal{B}' := (B_1, \dots, B_{q_5})$ be ordered in the order in which they appear in \mathcal{H} from top to bottom. That is, the paths in \mathcal{R}_3 go through the paths in \mathcal{B}' in the order B_{q_5}, \dots, B_1 .

Note that, by Lemma 5.19, the paths A_{i_j} start and end on vertices of paths in \mathcal{Q}' . As the paths in \mathcal{Q}' are subpaths of paths in \mathcal{Q} chosen from different rows \mathcal{Z}_i , there is a path in the original fence linking the endpoint of B_{2i-1} to the start vertex of B_{2i} .

Let \mathcal{B} be the set of maximal subpaths of paths in \mathcal{B}' with both endpoints on paths in \mathcal{R}_3 but which are internally vertex disjoint from \mathcal{R}_3 .

Finally, for every $B \in \mathcal{B}'$ let $r_u(B) := \min\{l : V(B) \cap V(\mathcal{Z}_l) \neq \emptyset\}$ and let $r_l(B)$ be the maximal number in this set. That is, the path B is formed by subpaths of paths in \mathcal{Q}_2 in the rows $\bigcup_{l=r_u(B)}^{r_l(B)} \mathcal{Z}_l$.

Recap. Let us quickly recap the notation that is still needed in the remainder of the proof. \mathcal{R}_3 is the bottom up linkage which together with the paths in \mathcal{B}' constitutes the grid \mathcal{H} . \mathcal{B} is the set of maximal subpaths of paths in \mathcal{B}' which start and end on paths in \mathcal{R}_3 but are otherwise disjoint from \mathcal{R}_3 . \mathcal{Q}' are the subpaths of the vertical paths in the original fence \mathcal{F} connecting \mathcal{F}_1 to \mathcal{F}_3 . Finally, $r_u(B)$ and $r_l(B)$ are defined as in the previous paragraph. \square

Step 2. Let $\tilde{\mathcal{Q}}_2 := \{Q \in \mathcal{Q}' : V(Q) \cap V(\mathcal{B}') \neq \emptyset\}$, i.e. $\tilde{\mathcal{Q}}_2$ contains those paths from \mathcal{Q}' that contain a subpath which is part of the grid \mathcal{H} . Now let $\mathcal{Q}_3 \subseteq \bigcup(\mathcal{R}_3 \cup (\mathcal{Q}' \setminus \tilde{\mathcal{Q}}_2)) \cap \mathcal{Z}$ be an \mathcal{R}_3 -minimal linkage of order q_3 , for some value

 \mathcal{R}_2^i $\hat{\mathcal{R}}_2^i$ \mathcal{B}' \mathcal{R}_3 \mathcal{H} \mathcal{B} $r_u(B), r_l(B)$

of q_3 to be determined below, such that the start and end vertices of the paths in \mathcal{Q}_3 are from the set of start and end vertices of the maximal subpaths of \mathcal{Q}' in \mathcal{Z} . This is possible as we require

$$(11) \quad q \geq q_3 + q_2.$$

We set $q^* := q_3$. Note that, by minimality, for every $Q \in \mathcal{Q}_3$ and every edge $e \in E(Q) \setminus E(\mathcal{R}_3)$, if $Q = Q_1 e Q_2$ then there are at most q^* paths from Q_1 to Q_2 in $(\mathcal{R}_3 \cup \mathcal{Q}_3) - e$. Furthermore, note that as \mathcal{R}_3 and \mathcal{Q}_3 are sets of pairwise disjoint paths, this property even holds for edges in $E(Q) \cap E(\mathcal{R}_3)$. For, if $e \in E(R) \cap E(Q)$ for some $R \in \mathcal{R}_3$ and $Q \in \mathcal{Q}_3$ then there is a maximal common subpath P of R and Q that contains e . Let x, y be the endpoints of P with x being the start vertex. But then Q must contain an edge $e' \in E(Q) \setminus E(R)$ with endpoint x or such an edge e'' with start point y . Assume e' exists and let $Q = Q_1 e' Q_2$ and $Q = \hat{Q}_1 e' \hat{Q}_2$. But then, any linkage L of order q^* from Q_1 to Q_2 in $(\mathcal{R}_3 \cup \mathcal{Q}_3) - e$ must be a linkage from \hat{Q}_1 to \hat{Q}_2 as no path in $\mathcal{R}_3 \cup \mathcal{Q}_3$ other than R and Q contains any vertex of P . This is needed below.

We require that

$$(12) \quad r_3 \geq t_w \cdot t_c,$$

$$(13) \quad q_5 \geq t_w \cdot t_r,$$

for some values of t_c, t_w, t_r to be determined below.

Recall that $\mathcal{R}_3 := (R_1, \dots, R_{r_3})$ is ordered in the order in which the paths in \mathcal{R}_3 occur on the grid \mathcal{H} , from left to right, and that $\mathcal{B}' := (B_1, \dots, B_{q_5})$ is ordered in the order in which the paths appear in \mathcal{H} from top to bottom. For $1 \leq j \leq t_c$ let $\mathcal{R}^j := \{R_{(j-1) \cdot t_w + 1}, \dots, R_{j \cdot t_w}\}$. Furthermore, for every $1 \leq i \leq t_r$ we let \mathcal{R}_i^j be the set of subpaths of paths $R \in \mathcal{R}^j$ starting at the first vertex of $R \cap B_{i \cdot t_w}$ and ending at the last vertex of $R \cap B_{(i-1) \cdot t_w + 1}$. Finally, let $\mathcal{S}_{i,j}$ be the subgrid of \mathcal{H} induced by the paths \mathcal{R}_i^j and the minimal subpaths of the paths $B \in \{B_{i \cdot t_w}, \dots, B_{(i-1) \cdot t_w + 1}\}$ which contain all of $V(B) \cap V(\mathcal{R}_i^j)$. We set $I := \{1, \dots, t_r\}$ and $J := \{1, \dots, t_c\}$. Finally, we set $r_u(\mathcal{S}_{i,j}) := r_u(B_{(i-1) \cdot t_w + 1})$ and $r_l(\mathcal{S}_{i,j}) := r_l(B_{i \cdot t_w})$. As the paths B start and end on vertices of paths in \mathcal{Q}' by Lemma 5.19 all paths B which intersect $\mathcal{S}_{i,j}$ are contained in $\bigcup_{r_u(\mathcal{S}_{i,j}) \leq l \leq r_l(\mathcal{S}_{i,j})} \mathcal{Z}_l$.

For all $i \in I$ and $j \in J$ let $\alpha(\mathcal{S}_{i,j})$ be the set of paths $Q \in \mathcal{Q}_3$ which contain a subpath $Q^* \subseteq Q$ with first vertex in $V(\mathcal{R}_3) \cap \bigcup_{l < r_u(\mathcal{S}_{i,j})} V(\mathcal{Z}_l)$, last vertex in $V(\mathcal{R}_3) \cap \bigcup_{l > r_l(\mathcal{S}_{i,j})} V(\mathcal{Z}_l)$ and internally vertex disjoint from $V(\mathcal{R}_3 \cap \mathcal{S}_{i,j})$. We call such a subpath Q^* a "jump" of Q over $\mathcal{S}_{i,j}$. Note that the paths Q^* do not really "jump" over $\mathcal{S}_{i,j}$, they merely avoid the paths in \mathcal{R}_3 within $\mathcal{S}_{i,j}$. However, if there are sufficiently many of such paths this will allow us to apply Lemma 6.9.

Claim 2. There is a number t_2 depending only on t such that if there is a pair $i \in I, j \in J$ such that $|\alpha(\mathcal{S}_{i,j})| \geq t_2$ then G contains a cylindrical grid of order t as a butterfly minor.

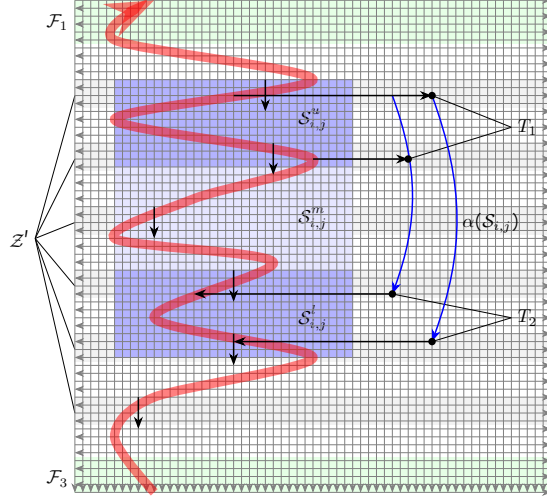

FIGURE 12. Illustration of the construction in Claim 2 of Lemma 6.11.

Proof. See Figure 12 for an illustration of the following construction. First, we require that

$$(14) \quad t_2 \geq t_3$$

$$(15) \quad t_w \geq t'_v + 2 \cdot t_3,$$

for some numbers t_3 and t'_v determined below. Let $\mathcal{S}_{i,j}^u$ be the subgrid of $\mathcal{S}_{i,j}$ induced by the paths $B_{(i-1)t_w+1}, \dots, B_{(i-1)t_w+t_3}$, let $\mathcal{S}_{i,j}^l$ be the subgrid of $\mathcal{S}_{i,j}$ induced by the paths $B_{it_w-t_3}, \dots, B_{it_w}$ and let $\mathcal{S}_{i,j}^m$ be the remaining subgrid, i.e. the subgrid of $\mathcal{S}_{i,j}$ induced by the paths $B_{(i-1)t_w+t_3+1}, \dots, B_{it_w-t_3-1}$.

For every $Q \in \alpha(\mathcal{S}_{i,j})$ choose a subpath Q^* as above, i.e. a path Q^* that jumps over the subgrid $\mathcal{S}_{i,j}$. Recall that $\mathcal{S}_{i,j}$ is the subgrid of \mathcal{H} formed by the paths in \mathcal{R}_i^j and the minimal subpaths of the paths $B \in \{B_{(i-1)t_w+1}, \dots, B_{it_w}\}$ which contain all of $V(B) \cap V(\mathcal{R}_i^j)$. Each B_l , for $(i-1)t_w+1 \leq l \leq it_w$, is constructed from subpaths of paths $Q^l \in \mathcal{Q}^l$ within distinct rows $Z_{l'} \in \mathcal{Z}^l$. As \mathcal{R}^l and therefore \mathcal{R}_3 is going up row by row within \mathcal{F} , and \mathcal{Z}^l only contains every second row of \mathcal{Z} , there is no path from any vertex in some row $Z_{2l} \in \mathcal{Z}^l$ to a vertex in row $Z_{2(l+1)}$ that does not contain a vertex of some path $Q^l \in \mathcal{Q}^l$. See Figure 12 for an illustration.

Hence, there is an initial subpath \hat{Q}_1 of Q^* which has a non-empty intersection with at least t_3 distinct rows in $\mathcal{S}_{i,j}^u$ and a terminal subpath \hat{Q}_2 of Q^* which has a non-empty intersection with t_3 rows in $\mathcal{S}_{i,j}^l$. Let \hat{Q} be the remaining subpath of Q^* such that $Q^* = \hat{Q}_1 \hat{Q} \hat{Q}_2$.

As $|\alpha(\mathcal{S}_{i,j})| \geq t_2 \geq t_3$ we can choose a set $\{Q_1, \dots, Q_{t_3}\}$ of t_3 distinct paths $Q \in \alpha(\mathcal{S}_{i,j})$ and t_3 distinct rows $\{Z_i : i \in I'\}$ that intersect $\mathcal{S}_{i,j}^u$, for an index set I' of order t_3 , and a set $T_1 := \{v_i : i \in I'\}$ of vertices on these rows which are on distinct paths \hat{Q}_1 , for $Q \in \{Q_1, \dots, Q_{t_3}\}$. Furthermore, we can choose t_3 rows $\{Z_i : i \in J'\}$ that intersect $\mathcal{S}_{i,j}^l$, for some index set J' of order t_3 , and a set $T_2 := \{u_i : i \in J'\}$ of vertices on these rows which are on distinct paths \hat{Q}_2 for $Q \in \{Q_1, \dots, Q_{t_3}\}$.

$$\begin{array}{l} \mathcal{S}_{i,j}^u \\ \mathcal{S}_{i,j}^l \\ \mathcal{S}_{i,j}^m \end{array}$$

Now observe that the paths in \mathcal{R}_3 also intersect every row in $\mathcal{S}_{i,j}^u$ and thus there is a linkage \mathcal{L}_u of order t_3 from the bottom of $\mathcal{S}_{i,j}$, i.e. the last vertices \mathcal{R}_3 has in common with $\mathcal{S}_{i,j}^m$, to the set T_1 .

Similarly, there is a linkage \mathcal{L}' of order t_3 from T_2 to the top of $\mathcal{S}_{i,j}^m$. Thus,

$$\bigcup \mathcal{L} \cup \bigcup \mathcal{L}' \cup \bigcup \mathcal{R}_3 \cup \bigcup \{\hat{Q} : Q \in \{Q_1, \dots, Q_{t_3}\}\}$$

contains a half-integral linkage of order t_3 , and thus an integral linkage \mathcal{L}'' of order $\frac{1}{2}t_3$, from the bottom of $\mathcal{S}_{i,j}^m$ to its top which avoids $V(\mathcal{R}_3 \cap \mathcal{S}_{i,j}^m)$. See Figure 12 for an illustration. Note that this linkage \mathcal{L}'' satisfies the condition of Lemma 6.9. We require that

$$(16) \quad \frac{1}{2}t_3 \geq t'$$

$$(17) \quad t'_v \geq t'',$$

where t', t'' are the integers defined in Lemma 6.9. We can now apply Lemma 6.9 to obtain a cylindrical grid of order t as a butterfly minor, as required. \dashv

Thus, we can now assume that $|\alpha(\mathcal{S}_{i,j})| \leq t_2$ for all $i \in I$ and $j \in J$. In particular, this implies that every $Q \in \mathcal{Q}_3 \setminus \alpha(\mathcal{S}_{i,j})$ intersects a path in $\mathcal{S}_{i,j}$.

As we require that

$$(18) \quad t_r \geq \binom{q_3}{t_2}^{t_c} \cdot t'_r,$$

for some number t'_r determined below, there is a subset $I' \subseteq I$ of order t'_r such that $\alpha(\mathcal{S}_{s,j}) = \alpha(\mathcal{S}_{s',j})$ for all $s, s' \in I'$ and $j \in J$. Furthermore, as

$$(19) \quad t_c \geq t'_c \binom{q_3}{t_2},$$

for some number t'_c determined below, there is a subset $J' \subseteq J$ of order t'_c such that $\alpha(\mathcal{S}_{i,j}) = \alpha(\mathcal{S}_{i,j'})$ for all $i \in I'$ and $j, j' \in J'$.

Now let $\mathcal{Q}_4 := \mathcal{Q}_3 \setminus \alpha(\mathcal{S}_{i,j})$ for some (and hence all) $i \in I', j \in J'$. Let $q_4 := |\mathcal{Q}_4|$. \mathcal{Q}_4
So every $Q \in \mathcal{Q}_4$ has a non-empty intersection with some $R \in \mathcal{R}_i^j$.

For every $Q \in \mathcal{Q}_4$ and all $i \in I'$ let $v_i(Q)$ be the last vertex on Q in $V(\bigcup_{j \in J'} \mathcal{R}_i^j)$, i.e. the last vertex of Q in the row i , when traversing Q from beginning to end.

For simplicity of notation we assume that $I' := \{1, \dots, t'_r\}$.

Claim 3. $v_1(Q), \dots, v_{t'_r}(Q)$ appear on Q in this order and furthermore, for all $i \in I'$, the subpath of Q from v_i to the end of Q has a non-empty intersection with $V(\mathcal{R}_{i+1}^j)$, for all $j \in J'$.

Proof. If, for some $i \in I'$, the subpath of Q from v_i to the end of Q has an empty intersection with $V(\mathcal{R}_{i+1}^j)$, for some $j \in J'$, then Q_i would be in $\alpha(\mathcal{S}_{i,j})$, a contradiction to the choice of I' and \mathcal{Q}_4 . Furthermore, if there were $i < i' \in I'$ such that $v_i(Q)$ appears on Q after $v_{i'}(Q)$, then again the subpath of Q from $v_i(Q)$ to the end of Q would not intersect any $\mathcal{R}_{i'}^j$, for $j \in J'$. Hence, by definition of $\alpha(\mathcal{S}_{i',j})$, Q would be contained in $\alpha(\mathcal{S}_{i',j})$, contradicting the choice of \mathcal{Q}_4 . \dashv

Now, for all $Q \in \mathcal{Q}_4$, $i \in I'$ with $i > 1$ and $j \in J'$ let

$$\beta_Q(\mathcal{S}_{i,j}) := \{R \in \mathcal{R}^j : Q \text{ intersects } R \cap \mathcal{R}_i^j \text{ in the subpath of } Q \text{ from } v_{i-1}(Q) \text{ to the end of } Q\}.$$

Note that $\beta_Q(\mathcal{S}_{i,j}) \neq \emptyset$ by Claim 3. As

$$(20) \quad q_4 \geq 2^{t_w} \cdot q_6,$$

for some number q_6 determined below, there is some $\mathcal{R}_{i,j} \subseteq \mathcal{R}^j$ and some $\mathcal{Q}_{i,j} \subseteq \mathcal{Q}_4$ such that $|\mathcal{Q}_{i,j}| = q_6$ and $\beta_Q(\mathcal{S}_{i,j}) = \mathcal{R}_{i,j}$ for all $Q \in \mathcal{Q}_{i,j}$. As we require that

$$(21) \quad t_r' \geq \left(\binom{q_4}{q_6} \cdot 2^{t_w} \right)^{t_c'} \cdot t_r''$$

$$(22) \quad t_c' \geq \left(\frac{q_4}{q_6} \right) \cdot 2^{t_w} \cdot t_c''$$

there is a set $I'' \subseteq I'$ with $|I''| = t_r''$ and a set $J'' \subseteq J'$ with $|J''| = t_c''$ such that $\mathcal{R}_{i,j} = \mathcal{R}_{i',j'}$, for all $i, i' \in I''$ and $j \in J''$ and $\mathcal{Q}_{i,j} = \mathcal{Q}_{i',j'}$ for all $i, i' \in I''$ and $j, j' \in J''$.

We let $\mathcal{Q}'' := \mathcal{Q}_{i,j}$ for some (and hence all) $i \in I''$ and $j \in J''$ and set $\mathcal{R}'' := \bigcup_{j \in J''} \mathcal{R}_{i,j}$ for some $i \in I''$. We claim that if

$$(23) \quad t_c'' = r \quad \text{and} \quad q_6 = q'$$

then \mathcal{R}'' and \mathcal{Q}'' constitute the second outcome of the lemma. We have already argued above that for every $Q \in \mathcal{Q}''$ and every edge $e \in E(Q) \setminus E(\mathcal{R}'')$ there are at most q^* paths from Q_1 to Q_2 in $\mathcal{R}'' \cup \mathcal{Q}'' - e$, where $Q = Q_1 e Q_2$. Hence, by our construction of \mathcal{R}'' and \mathcal{Q}'' and by Claim 3 it remains to define the edges $e_1(R), e_2(R)$ and $e(Q)$ for all $R \in \mathcal{R}''$ and $Q \in \mathcal{Q}''$.

We require that

$$(24) \quad t_r'' \geq 3.$$

Hence we can choose $i_1 < i_2 < i_3 \in I''$. For $R \in \mathcal{R}''$ choose $e_1(R) \in E(R)$ as the first edge on R after the last vertex of R in $\bigcup_{j \in J''} \mathcal{R}_{i_3}^j$ and $e_2(R)$ as the first edge on R after $\bigcup_{j \in J''} \mathcal{R}_{i_2}^j$. For every $Q \in \mathcal{Q}''$ let $e(Q)$ be the first edge $e \in E(Q) \setminus E(\mathcal{R}'')$ on Q after $v_{i_2}(Q)$ (which exists as \mathcal{R}_3 only goes up). Let $u(Q)$ and $l(Q)$ be the subpaths of Q such that $Q = u(Q) e l(Q)$. Then, if $R = R_1 e_1(R) R_2 e_2(R) R_3 \in \mathcal{R}''$, then R_1 does not intersect any $u(Q)$, for $Q \in \mathcal{Q}''$ but R_1 intersects $l(Q)$ and each of R_2 and R_3 intersect $u(Q)$. Hence, this constitutes the second outcome of the lemma. \square

Recap. Towards the end of the proof of Theorem 6.1, let us recall the current situation. After Lemma 6.11, we have a linkage \mathcal{R}'' of order r'' and the linkage \mathcal{Q}'' of order q'' as in the statement of the lemma. In particular, for every $Q \in \mathcal{Q}''$ there is a split edge $e(Q) \in E(Q) \setminus E(\mathcal{R}'')$ splitting Q into two subpaths $l(Q)$ and $u(Q)$ with $Q = u(Q) e l(Q)$. Furthermore, for every $R \in \mathcal{R}''$ there are distinct edges $e_1(R), e_2(R)$ splitting R into subpaths $l(R), u_1(R)$ and $u_2(R)$ such that $R = l(R) e_1(R) u_1(R) e_2(R) u_2(R)$ and

- (1) the subpath $u_1(R) e_2(R) u_2(R)$ does not intersect $l(Q)$ for every $Q \in \mathcal{Q}''$

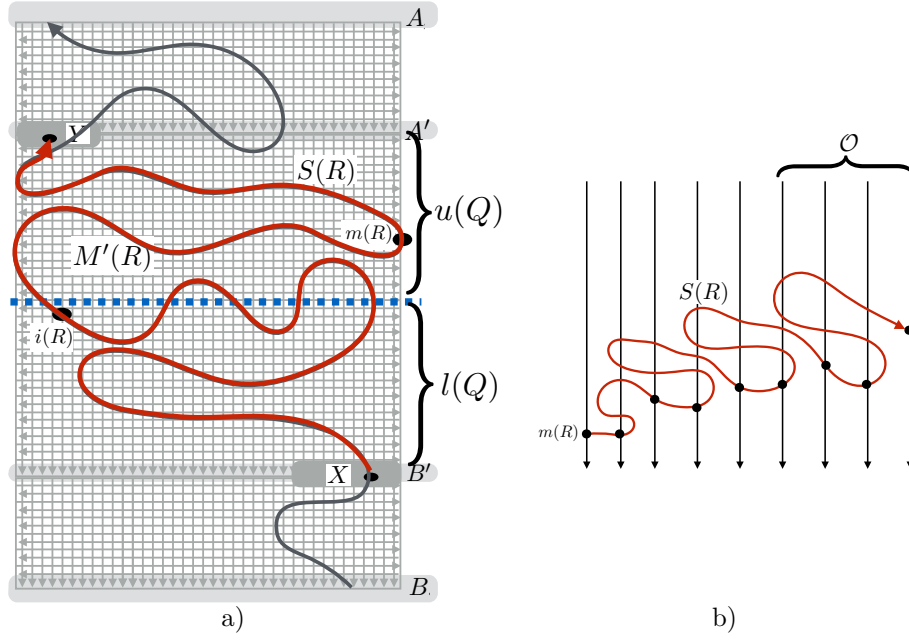

FIGURE 13. Illustration of a) the final part of the proof and b) of the construction of the set \mathcal{O} .

- (2) $u_1(R)$ and $u_2(R)$ both intersect every $u(Q)$ for $Q \in \mathcal{Q}''$
- (3) $l(R)$ intersects every $l(Q)$ for $Q \in \mathcal{Q}''$ (but may also intersect $u(Q)$).

Finally, recal the definition of q^* from Lemma 6.11. J

In the sequel we will impose various conditions on the size of the linkages we construct which will eventually determine the values of p and r in Theorem 6.1. We refrain from calculating these numbers precisely but rather state conditions on the size of the linkages. It is straightforward to verify that these conditions can always be satisfied.

We first need to introduce some notation. By construction, at most q^* paths in \mathcal{R}'' can intersect $l(Q)$ after it has intersected $u(Q)$. We can therefore take a subset $\mathcal{R}^* \subseteq \mathcal{R}''$ of order $r^* \geq r'' - q^* \cdot q''$ such that, for all $Q \in \mathcal{Q}''$, no path in \mathcal{R}^* intersects $l(Q)$ after it has intersected $u(Q)$. \mathcal{R}^*, r^*

For every $R \in \mathcal{R}^*$ let us define $i(R)$ to be the last vertex of R in $l(Q'')$. Let $M'(R)$ be the subpath of R of minimal length which starts at the successor of $i(R)$ and which intersects every $u(Q)$ for $Q \in \mathcal{Q}''$. Such a vertex $i(R)$ as well as the subpath $M'(R)$ exist by construction, i.e. by Property (1)–(3) above. See Figure 13 a) for an illustration of the construction so far. $i(R)$
 $M'(R)$

By the pigeon hole principle and as we require

$$(25) \quad r^* \geq r_1 \cdot q'$$

there is a set $\mathcal{R}_1 \subseteq \mathcal{R}^*$ of order r_1 and a path $Q^i \in \mathcal{Q}''$ such that $i(R) \in V(Q^i)$ for all $R \in \mathcal{R}_1$. \mathcal{R}_1, r_1

For every $R \in \mathcal{R}_1$ and every $v \in V(R) \cap l(\hat{Q})$ for some $\hat{Q} \in \mathcal{Q}''$ let \langle_v^R be the \langle_v

$omit(v), t$

order on \mathcal{Q}'' in which $Q <_v^R Q'$ if on the subpath R' of R starting at v to the end of R , the first vertex that R' has in common with $u(Q)$ appears before the first vertex R' has in common with $u(Q')$. As v uniquely determines the path R we drop the extra index R and just write $<_v$. For any such v let $(Q'_1, \dots, Q'_{q''})$ be the paths in \mathcal{Q}'' ordered with respect to $<_v$ and define $omit(v) := \{Q'_{q''-t}, \dots, Q'_{q''}\}$, for some suitable number t determined below. We call t the *omission width*. A vertex $v \in V(R) \cap l(Q)$ for some $Q \in \mathcal{Q}''$ is *good*, if $Q \notin omit(v)$. The following lemma explains the importance of a good vertex.

Lemma 6.12. *For every $R \in \mathcal{R}_1$ there is a path $Q \in \mathcal{Q}''$ such that R contains a good vertex $v(R) \in V(l(Q))$ and the subpath of R from the beginning of R to $v(R)$ intersects $l(Q)$ for all $Q \in \mathcal{Q}'' \setminus omit(v(R))$.*

Proof. We give a constructive proof of this lemma. For $0 \leq i \leq t$, where t is the omission width, we construct a set $\mathcal{O}_i \subseteq \mathcal{Q}''$, a path $Q_i \in \mathcal{Q}'' \setminus \mathcal{O}_i$ and a vertex $v_i \in V(R) \cap l(Q_i)$ such that

- (1) $\mathcal{O}_i \subseteq omit(v_i)$,
- (2) the subpath of R from the beginning of R to v_i intersects $l(Q)$ for all $Q \in \mathcal{Q}'' \setminus \mathcal{O}_i$, and
- (3) the subpath of R from v_i to $i(R)$ intersects $l(Q)$ for all $Q \in \mathcal{O}_i$.

Let $\mathcal{O}_0 := \emptyset$. Let $Q_0 \in \mathcal{Q}''$ be the path containing the last vertex $v_0 := i(R)$ that R has in common with $l(Q)$ for any $Q \in \mathcal{Q}''$. Clearly this satisfies Property (1)-(3) above.

So suppose \mathcal{O}_i, Q_i, v_i have already been constructed. If $Q_i \notin omit(v_i)$ then v_i is good and we are done. Otherwise, $Q_i \in omit(v_i)$ and we set $\mathcal{O}_{i+1} := \mathcal{O}_i \cup \{Q_i\}$. Let v_{i+1} be the last vertex that R has in common with $l(Q)$ for any $Q \in \mathcal{Q}'' \setminus \mathcal{O}_{i+1}$. Let $Q_{i+1} \in \mathcal{Q}'' \setminus \mathcal{O}_{i+1}$ be the path containing v_{i+1} . By construction, Q_{i+1} is the last path on R before v_i such that R intersects $l(Q_{i+1})$ and such that $Q_{i+1} \notin \mathcal{O}_{i+1}$. We claim that $\mathcal{O}_{i+1} \subseteq omit(v_{i+1})$. By induction hypothesis, $\mathcal{O}_i \subseteq omit(v_i)$. Hence, in the order $<_{v_i}$, every path in \mathcal{O}_{i+1} was among the last t paths with respect to $<_{v_i}$. Now suppose some $Q \in \mathcal{O}_{i+1}$ is not in $omit(v_{i+1})$. This means that Q is no longer among the last t paths hit by R with respect to $<_{v_{i+1}}$. The only reason for this to happen is that the subpath of R from v_{i+1} to v_i intersects $u(Q)$. But, by Property (3) above, the subpath of R from v_i to $i(R)$ intersects $l(Q)$. But this violates the construction of \mathcal{R}^* as in \mathcal{R}^* , no path $R' \in \mathcal{R}^*$ intersects any $l(Q)$ after it has intersected $u(Q)$. Hence, the subpath of R between v_{i+1} and v_i cannot intersect $u(Q)$ and therefore $\mathcal{O}_{i+1} \subseteq omit(v_{i+1})$ as required. The other conditions are obviously satisfied as well.

This concludes the construction of \mathcal{O}_i, v_i, Q_i for all i . By construction, in every step i in which no good vertex is found (i.e., $Q_i \notin omit(v_i)$), the set \mathcal{O}_i increases. However, as $\mathcal{O}_i \subseteq omit(v_i)$ and $|omit(v_i)| \leq t$ by definition, this process must terminate after at most $j \leq t$ iterations. Hence, v_j is a good vertex. \square

We require

$$(26) \quad r_1 \geq r_2 \cdot q'' \cdot \binom{q''}{t}$$

so that the previous lemma implies the next corollary.

Corollary 6.13. *There is a set $\mathcal{R}_2 \subseteq \mathcal{R}_1$ of order r_2 , a set $\mathcal{O}_1 \subseteq \mathcal{Q}''$ of order t and a path $Q \in \mathcal{Q}'' \setminus \mathcal{O}_1$ such that every $R \in \mathcal{R}_2$ contains a good vertex $v(R) \in V(Q)$ satisfying the condition in Lemma 6.12 and $\text{omit}(v(R)) = \mathcal{O}_1$.*

The point of $\text{omit}(v(R)) = \mathcal{O}_1$ is that, as indicated in Figure 13 b), we get some “buffer” area \mathcal{O}_1 . More precisely, we want to apply Lemma 5.15 to $\mathcal{Q}'' \setminus \mathcal{O}_1$ and a subset of \mathcal{R}_2 , and then it is important for us that the outcome of Lemma 5.15 does not involve the “buffer” area, because this area is needed to connect the “bottom” of the outcome to the top. This way, we shall construct a cylindrical grid of order k as a butterfly minor.

Let us give one more remark: Hereafter, if we obtain a large “split” when applying Lemma 5.15, rather quickly, we can construct a cylindrical grid of order k as a butterfly minor. On the other hand, if the outcome is a large segmentation, the situation is more complicated, and almost the entire rest of the paper is devoted to this particular case. Let us look at more details.

Definition 6.14. *For every $R \in \mathcal{R}_2$ let $v(R)$ be the good vertex as defined in the previous corollary. We define $M(R)$ to be the subpath of R of minimal length starting at the successor of $v(R)$ on R so that $M(R)$ intersects every $u(Q)$ for all $Q \in \mathcal{Q}'' \setminus \mathcal{O}_1$. Let $m(R)$ be the endpoint of $M(R)$. We define $S(R)$ to be the subpath of R of minimal length starting at the successor of $m(R)$ on R such that $S(R)$ intersects $u(Q)$ for all $Q \in \mathcal{Q}''$. Finally, we define $I(R)$ to be the initial subpath of R from its beginning to $v(R)$ (see Figure 13 a)).*

By construction, $I(R)$ intersects $l(Q)$ for all $Q \in \mathcal{Q}'' \setminus \mathcal{O}_1$, where \mathcal{O}_1 is as in the previous corollary.

For every $R \in \mathcal{R}_2$ let \prec_R^S be the order on \mathcal{Q}'' in which $Q \prec_R^S Q'$ if the first vertex $S(R)$ has in common with Q appears on $S(R)$ before the first vertex $S(R)$ has in common with Q' . By the pigeon hole principle and as we require

$$(27) \quad r_2 \geq r_3 \cdot (q'')! \cdot q''$$

we can choose a subset $\mathcal{R}_3 \subseteq \mathcal{R}_2$ of order r_3 such that $\prec_R^S = \prec_{R'}^S$ for all $R, R' \in \mathcal{R}_3$ and $v(R) = v(R')$ for all $R, R' \in \mathcal{R}_3$. Let $\prec^S := \prec_R^S$ for some (and hence all) $R \in \mathcal{R}_3$.

Let $Q_1, \dots, Q_{q''}$ be the paths in \mathcal{Q}'' ordered by \prec^S and let $\mathcal{O} := \{Q_{q''-t}, \dots, Q_{q''}\}$, where t is the omission width. We write $M(\mathcal{R}_3) := \{M(R) : R \in \mathcal{R}_3\}$.

We require that $|\mathcal{Q}'' \setminus \mathcal{O}_1| = q'' - t \geq 2 \cdot \max\{q_s, q_1\}$, for suitable numbers q_s, q_1 determined below, and that r_3 is such that

$$(28) \quad \begin{aligned} &\text{if in Lemma 5.15 we take } p := q'' - t, q' := r_3, c := q'', y := q_s, \\ &x := q_1 \text{ and } q := r_5 \text{ then there is a } (q_s, r_5)\text{-split or a } (q_1, r_5)\text{-} \\ &\text{segmentation,} \end{aligned}$$

for a suitable number r_5 determined below.

Applying Lemma 5.15 to $(\mathcal{Q}'' \setminus \mathcal{O}_1, M(\mathcal{R}_3))$, which has linkedness q^* , where $\mathcal{Q}'' \setminus \mathcal{O}_1$ takes on the role of \mathcal{P} and $M(\mathcal{R}_3)$ plays the role of \mathcal{Q} , we either get

- (1) a (q_s, r_5) -split $(\mathcal{Q}_s, \mathcal{R}_5)$ obtained from a single path $Q \in \mathcal{Q}'' \setminus \mathcal{O}_1$ which is split into q_s subpaths, i.e. $Q = Q_1 \cdot e_1 \cdot Q_2 \dots e_{q_s-1} \cdot Q_{q_s}$, or
- (2) we obtain a (q_1, r_5) -segmentation $(\mathcal{Q}_1, \mathcal{R}_5)$ consisting of a subset $\mathcal{R}_5 \subseteq M(\mathcal{R}_3)$ of order r_5 and a set \mathcal{Q}_1 of order q_1 of subpaths of paths in $\mathcal{Q}'' \setminus \mathcal{O}_1$ satisfying the extra conditions of Lemma 5.15.

In the first case, as mentioned above, we can get a cylindrical grid of order k as a butterfly minor as follows.

Lemma 6.15. *If applying Lemma 5.15 to $(\mathcal{Q}'' \setminus \mathcal{O}_1, M(\mathcal{R}_3))$ yields a (q_s, r_5) -split $(\mathcal{Q}_s, \mathcal{R}_5)$, then G contains a cylindrical grid of order k as a butterfly minor.*

Proof. See Figure 14 for an illustration of the following construction. Let $\mathcal{R}_4 = \{R \in \mathcal{R}^* : M(R) \in \mathcal{R}_5\}$ be a linkage of order $r_4 := r_5$. Hence, \mathcal{R}_4 is a linkage from the bottom of the original fence \mathcal{F} to its top and \mathcal{R}_4 and \mathcal{Q}_s form a pseudo-fence \mathcal{F}_p .

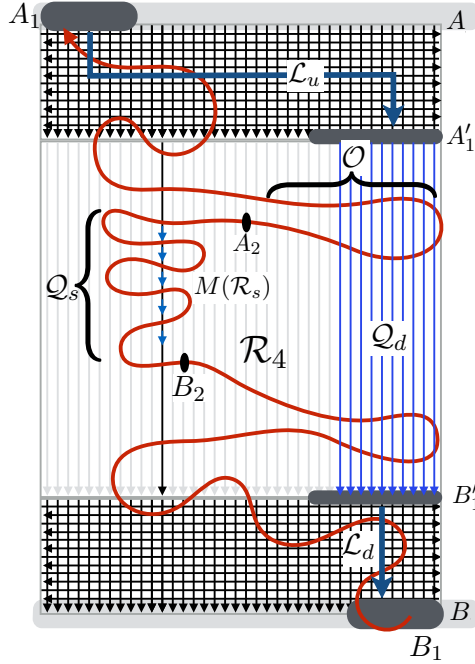

FIGURE 14. Creating a grid from a split and the resulting pseudo-fence.

We can now define paths back from the end vertices of \mathcal{R}_4 to their start vertices as follows. Let $A_1 \subseteq A$ be the endpoints of the paths in \mathcal{R}_4 and let $B_1 \subseteq B$ be the start vertices of the paths in \mathcal{R}_4 . Choose a set $\mathcal{Q}_d \subseteq \mathcal{O}_1$ of order r_4 , which is possible as we require

$$(29) \quad t \geq r_4.$$

Recall the definition of A', B' from above and see Figure 11 for an illustration. Let $A'_1 \subseteq A'$ and $B'_1 \subseteq B'$ be the set of start and end vertices of the paths in \mathcal{Q}_d . Then by routing through \mathcal{F}_1 and through \mathcal{F}_3 there is a linkage \mathcal{L}_u of order r_4 from A_1 to A'_1 and a linkage \mathcal{L}_d of order r_4 from B'_1 to B_1 . Hence, $\mathcal{L}_u \cup \mathcal{Q}_d \cup \mathcal{L}_d$ form a linkage \mathcal{L} of order r_4 from A_1 to B_1 .

Let B_2 be the start vertices of the paths in $M(\mathcal{R}_4)$ and A_2 be their end vertices. Every path $R \in \mathcal{R}_4$ can be split into three disjoint subpaths, $D(R), M(R), U(R)$, where $D(R)$ is the initial component of $R - M(R)$ and $U(R)$ is the subpath following $M(R)$. Then, $\mathcal{L} \cup \bigcup \{U(R), D(R) : R \in \mathcal{R}_4\}$ forms a half-integral linkage from A_2

to B_2 of order r_4 and hence, by Lemma 2.12, there is an integral linkage \mathcal{L}' of order $\frac{1}{2}r_4$ from A_2 to B_2 .

Note that $M(\mathcal{R}_4)$ and \mathcal{L}' are vertex disjoint (but \mathcal{Q}_s may not be disjoint from \mathcal{L}'). We require that $\frac{1}{2}r_4$ and q_s are large enough so that we can apply Lemma 6.9 to \mathcal{L}' , $M(\mathcal{R}_4)$ and \mathcal{Q}_s to obtain a cylindrical grid of order k as a butterfly minor. \square

It remains to consider the second case above, i.e. where we obtain a (q_1, r_5) -segmentation $\mathcal{S}_1 := (\mathcal{Q}_1, \mathcal{R}_5)$. This case and part of the following construction is illustrated in Figure 15. \mathcal{S}_1

Recap. Let us recall the current situation and the notation still relevant for the remainder of the proof.

- \mathcal{F} is the original fence and $\mathcal{F}_1, \mathcal{F}_3$ are its upper and lower part used for rerouting paths.
- \mathcal{Q}'' is the vertical linkage of order q'' in the "middle" of the fence \mathcal{F} taken so that every $Q \in \mathcal{Q}''$ can be split into two parts $u(Q)$ and $l(Q)$ occurring in this order on Q .
- \mathcal{R}_3 is the bottom-up linkage we work with. From the "middle paths" $\{M(R) : R \in \mathcal{R}_3\}$ we obtained the segmentation \mathcal{S}_1 .
- $\mathcal{O}, \mathcal{O}_1 \subseteq \mathcal{Q}''$ are linkages where \mathcal{O}_1 is constructed in Corollary 6.13 and is the set of omitted paths for the paths $M(R)$, for $R \in \mathcal{R}_3$, and \mathcal{O} plays a similar role for the paths in $\{S(R) : R \in \mathcal{R}_3\}$.
- Every $R \in \mathcal{R}_3$ contains a *good vertex* $v(R)$ such that $omit(v(R)) = \mathcal{O}_1$. Furthermore, $v(R) = v(R')$ for all $R, R' \in \mathcal{R}_3$. See Definition 6.14.
- We defined $M(R)$ as the subpath of R of minimal length starting at the successor of $v(R)$ so that $M(R)$ intersects $u(Q)$ for all $Q \in \mathcal{Q}'' \setminus \mathcal{O}_1$. $m(R)$ was the end point of $M(R)$ and $S(R)$ is the minimal subpath of R starting at the successor of $m(R)$ intersecting $u(Q)$ for all $Q \in \mathcal{Q}''$. Finally, $I(R)$ was the initial subpath of R up to $v(R)$. Recall that by construction, $M(R) \cap l(Q) = \emptyset$ for all $R \in \mathcal{R}_3$ and $Q \in \mathcal{Q}''$.
- $\mathcal{S}_1 := (\mathcal{Q}_1, \mathcal{R}_5)$ is a (q_1, r_5) -segmentation. Recall that the paths in \mathcal{R}_5 are paths $M(R)$ for some $R \in \mathcal{R}_3$.
- Finally, recall that q_s is the number such that when we applied Lemma 5.15 we either got a (q_s, r_5) -split or the segmentation \mathcal{S}_1 .

▾

We define $\hat{\mathcal{R}}_5 := \{R \in \mathcal{R}_3 : M(R) \in \mathcal{R}_5\}$. Recall that when obtaining the segmentation \mathcal{S}_1 , some paths in \mathcal{Q}_1 can be obtained by splitting a single path in $\mathcal{Q}'' \setminus \mathcal{O}_1$. However, no path in $\mathcal{Q}'' \setminus \mathcal{O}_1$ is split more than $q_s - 1$ times. We define an equivalence relation \sim on \mathcal{Q}_1 by letting $Q \sim Q'$ if Q and Q' are subpaths of the same path in \mathcal{Q}'' . Recall that Lemma 5.15 guarantees that either every or no vertex of a path in \mathcal{Q}'' occurs on a path in \mathcal{Q}_1 . As $M(\mathcal{R}^*) \cap l(\mathcal{Q}'') = \emptyset$, it follows that in each equivalence class of \sim there is exactly one path containing a vertex in $l(\mathcal{Q}'')$. Let \mathcal{Q}_1'' be the set of paths in \mathcal{Q}_1 containing a vertex in $l(\mathcal{Q}'')$. Hence, $(\mathcal{Q}_1'', \mathcal{R}_5)$ form a q_1'' -segmentation of order r_5 for some $q_1'' \geq \frac{q_1}{q_s - 1}$. See Figure 15 for an illustration of the current situation. $\hat{\mathcal{R}}_5$
 \sim
 \mathcal{Q}_1''
 q_1''

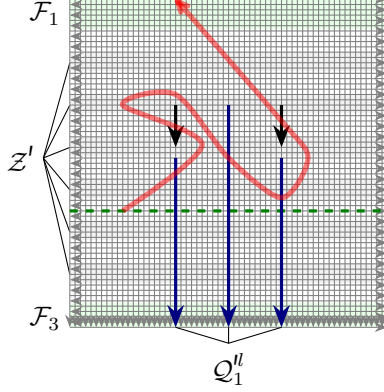

FIGURE 15. The situation before Lemma 6.16. The blue paths are the paths in \mathcal{Q}_1'' .

Our next goal is to show that if there is a set $\mathfrak{R}^S \subseteq S(\hat{\mathcal{R}}_5)$ of large order that avoids a big portion of the segmentation $(\mathcal{Q}_1'', \mathcal{R}_5)$ we can obtain a cylindrical grid of order k as a butterfly minor. This will be shown in the following lemma.

This lemma is technical, but once we prove it, we will end up with a situation where whenever we create another segmentation S that is obtained from a subset of $S(\hat{\mathcal{R}}_5)$, every row in S has to overlap with the segmentation $(\mathcal{Q}_1'', \mathcal{R}_5)$. This structure will be the key to complete our proof.

Lemma 6.16. *There are integers o_1, r^s depending only on k and q_s such that if there is a set $\Omega \subseteq \mathcal{Q}_1''$ of order o_1 and a set $\mathfrak{R}^S \subseteq S(\hat{\mathcal{R}}_5)$ of order r^s such that no path in \mathfrak{R}^S intersects any path in Ω , then G contains a cylindrical grid of order k as a butterfly minor.*

Proof. Recall the equivalence relation \sim above. For every $Q \in \mathcal{Q}_1$ we denote the \sim -equivalence class of Q by $[Q]_{\sim}$. By Lemma 5.15, at most $q_s - 1$ paths belong to the same equivalence class. For $Q \in \mathcal{Q}_1$ we denote by $\sigma(Q) = (Q_1, \dots, Q_j)$, for some $j = j(Q) \leq q_s - 1$, the sequence of paths $Q_1, \dots, Q_j \in \mathcal{Q}_1$ such that $[Q]_{\sim} = \{Q_1, \dots, Q_j\}$ and the paths Q_1, \dots, Q_j occur in the (reverse) order Q_j, \dots, Q_1 on the path $Q'' \in \mathcal{Q}''$ that contains Q .

If $\sigma(Q) = (Q_1, \dots, Q_j)$ for some $Q \in \mathcal{Q}_1$, then every path $R \in \mathcal{R}_5$ can be divided into j segments R_1, \dots, R_j occurring in this order on R and $V(R) \cap V(Q_i) \subseteq V(R_i)$. In particular, Q_1 must be the path that contains a vertex in $l(Q'')$. We call this the *first* member of the equivalence class.

The idea of the proof of this lemma is that we are already given the segmentation (Ω, \mathfrak{R}_5) , and all we need in order to find a cylindrical grid of order k as a butterfly minor is to find a linkage of large size from the end of \mathfrak{R}_5 to the start by using the linkage \mathfrak{R}^S without intersecting a big part of the segmentation.

Towards this end, we need the following simple claim. Note that the conditions on q_s imposed in the previous parts of the proof guarantee that $q_s \geq 2$ so that $(q_s)^d \geq d$. Let $\mathfrak{R}^M := \{M(R) : S(R) \in \mathfrak{R}^S\}$.

$\sigma(Q)$

Claim 1. Let $R \in \mathfrak{R}^M$. For every $d \geq 1$ if $\Omega_1 \subseteq \Omega$ is of order at least $(q_s)^d$ such that R intersects every $Q \in \Omega_1$, then there is a subset $\Omega(R) \subseteq \Omega_1$ of order d and an initial subpath R' of R such that for every $Q \in \Omega(R)$, if $\sigma(Q) = (Q_1, \dots, Q_j)$ then there is an index $1 \leq j' \leq j$ such that R' intersects $Q_1, \dots, Q_{j'}$ but none of $Q_{j'+1}, \dots, Q_j$. Furthermore, for each $Q \in \Omega_1$ there is a subpath $R'' = R''(Q)$ which contains all of $V(Q) \cap V(R')$ but is disjoint from all other $Q \in \Omega_1$ with $Q \neq Q'$.

Proof. We prove the claim by induction on d . For $d = 1$ we choose the first path $Q \in \Omega_1$ that R intersects and set $\Omega(R) := (Q)$ and R' as the initial subpath of R of minimal length such that R' intersects Q . As R traverses $\sigma(Q) = (Q_1, \dots, Q_j)$ in the order Q_1, \dots, Q_j , we are guaranteed that $Q = Q_1$ and the conditions of the claim are met.

Now let $d > 1$. Let $Q \in \Omega_1$ be the first path in Ω_1 that R intersects. Let $\sigma(Q) = (Q_1, \dots, Q_j)$. Then R can be split into j subpaths R_1, \dots, R_j where R_i is the maximal subpath of R starting at the first vertex R has in common with Q_i and which does not include any vertex of $V(Q_{i+1})$, or to the end of R in case $i = j$.

For every $Q' \in \Omega_1 \setminus \{Q\}$ let $i(Q')$ be the minimal index such that $V(R_{i(Q')}) \cap V(Q') \neq \emptyset$. By the pigeon hole principle there is an index $1 \leq i \leq q_s - 1$ such that $i = i(Q')$ for at least $\frac{|\Omega_1 \setminus \{Q\}|}{q_s - 1} \geq \frac{q_s^d - 1}{q_s - 1} \geq q_s^{d-1}$ paths $Q' \in \Omega_1$. Let $\tilde{\Omega}_1 := \{Q' \in \Omega_1 : i = i(Q')\}$.

Let \tilde{R} be the minimal initial subpath of R including R_i . Then applying the construction inductively to \tilde{R} and $\tilde{\Omega}_1$ yields an initial subpath \tilde{R}' of \tilde{R} and a subset $\Omega(\tilde{R}) \subseteq \tilde{\Omega}_1$ of order $d - 1$ satisfying the conditions of the claim. But then, setting $\Omega(R) := \Omega(\tilde{R}) \cup \{Q\}$, taking $R' = \tilde{R}'$ satisfies the claim. \dashv

We require that

$$(30) \quad o_l \geq (q_s)^{o'}$$

$$(31) \quad r^s \geq \binom{o_l}{o'} \cdot p'$$

for some suitable numbers o', p' to be determined below. Then, by Claim 1, there are sets $\Omega_1 \subseteq \Omega$ of order o' and $\tilde{\mathfrak{R}}' \subseteq \mathfrak{R}^M$ of order p' so that $\Omega_1 = \Omega(R)$ for every path $R \in \tilde{\mathfrak{R}}'$. Furthermore, for every $R \in \tilde{\mathfrak{R}}'$ let R' be the initial subpath satisfying the condition of the claim and let $\hat{R} \in \mathcal{R}''$ be the path of which R is a subpath. We define $M'(\hat{R}) := R'$ and define $S'(\hat{R})$ to be the subpath of R starting at the successor of the endpoint of $M'(\hat{R})$ and ending at the last vertex of $S(\hat{R})$. Hence, $M'(\hat{R})$ and $S'(\hat{R})$ are obtained from $M(\hat{R})$ and $S(\hat{R})$ by shortening $M(\hat{R})$ and adding the removed part of $M(\hat{R})$ to the beginning of $S(\hat{R})$ to obtain $S'(\hat{R})$.

Let $\mathfrak{R}^{M'} := \{M'(R) : R \in \tilde{\mathfrak{R}}'\}$ and let $\mathfrak{R}^{S'} := \{S'(\hat{R}) : M'(\hat{R}) \in \mathfrak{R}^{M'}\}$. Let $f_r, f_p : \mathbb{N} \rightarrow \mathbb{N}$ be the functions defined in Lemma 5.19.

Observe that $(\Omega_1, \mathfrak{R}^{M'})$ forms an (o', p') -segmentation. In particular, Claim 1 implies that the paths in $\mathfrak{R}^{M'}$ go through the paths in Ω_1 as indicated in Figure 16.

We require that $p' \geq p'' \cdot f_q(o)$ and

$$(32) \quad o' \geq (p'' \cdot f_q(o))! \cdot f_p(o)$$

 Ω_1 $\mathfrak{R}^{M'}$ $\mathfrak{R}^{S'}$

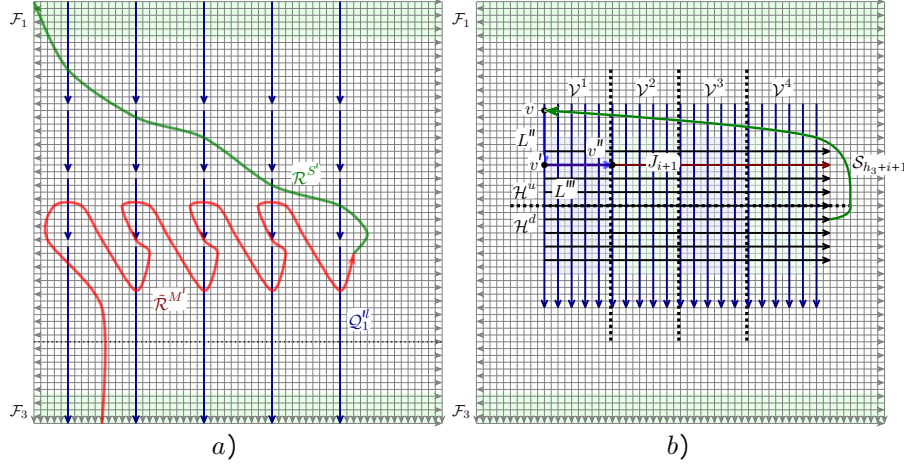

FIGURE 16. Illustration of the construction in Lemma 6.16

for some suitable values of p'' and o to be determined below. Let $\tilde{\mathfrak{R}}^{M'}$ be a subset of $\mathfrak{R}^{M'}$ of order $p'' \cdot f_q(o)$. Then $(\Omega_1, \tilde{\mathfrak{R}}^{M'})$ forms an (o', p'') -segmentation and therefore, by Lemma 5.10 Part (1), there is a subset $\Omega_2 \subseteq \Omega_1$ of order $f_q(o)$ such that $(\Omega_2, \tilde{\mathfrak{R}}^{M'})$ forms a strong $(f_p(o), p'' \cdot f_q(o))$ -segmentation. Let $(R_1, \dots, R_{p'' \cdot f_q(o)})$ be the order in which the paths in $\tilde{\mathfrak{R}}^{M'}$ occur on the paths in Ω_2 . For each $1 \leq i \leq p''$ we can now apply Lemma 5.19 to $(\Omega_2, \{R_{(i-1)f_q(o)+1}, \dots, R_{if_q(o)}\})$ to obtain a sequence $\bar{Q}_i := (Q_1^i, \dots, Q_o^i)$ and a path A_i as in the statement of the lemma. Furthermore, we can choose the path A_i so that it satisfies Property 2 of the lemma, i.e. so that it ends at an endpoint of a path in $\{R_{(i-1)f_q(o)+1}, \dots, R_{if_q(o)}\}$.

We require that

$$(33) \quad p'' \geq \binom{f_p(o)}{o} \cdot o! \cdot h_2,$$

for some suitable number h_2 to be determined below. Then there are h_2 values $i_1 < \dots < i_{h_2}$ such that $\bar{Q}_{i_j} = \bar{Q}_{i_{j'}}$ for all $1 \leq j, j' \leq h_2$. Let $(Q_1, \dots, Q_o) = \bar{Q}_{i_1}$ and, for $1 \leq j \leq h_2$, let $H_j := A_{i_j}$. Then $((H_1, \dots, H_{h_2}), (Q_1, \dots, Q_o))$ form a grid with the paths H_1, \dots, H_{h_2} occurring in this order from top to bottom on the paths Q_1, \dots, Q_o .

Note that by the construction in Lemma 5.19 every H_i has the following property.

For any Q_i with $1 \leq i \leq o$ let $\sigma(Q_i) = (Q^1, \dots, Q^j)$ and let j' be maximal such that H_i intersects $Q^{j'}$. Then H_i starts at Q^1 , then intersects $Q^{j''}$ for all $j'' \leq j'$, but once it has intersected $Q^{j'}$ it will never again intersect any $Q^{j''}$ for some $j'' < j'$.

This property is needed below. See Figure 16 a) for an illustration of the current situation. We require that

$$(34) \quad h_2 = h_3 + k',$$

$$(35) \quad o = 4k'$$

for suitable numbers h_3, k^l determined below. Let $\mathcal{H}^u := (H_1, \dots, H_{h_3})$ and let $\mathcal{H}_d := (H_{h_3+1}, \dots, H_{h_3+k^l})$. For $1 \leq i \leq 4$ let $\mathcal{V}^i := (Q_{(i-1)k^l+1}, \dots, Q_{i \cdot k^l})$.

We will now construct a cylindrical grid of order k as a butterfly minor as follows. By construction, every path H_i can be extended by a path R for some $R \in \mathfrak{R}^{S'}$. Let $S_{h_3+1}, \dots, S_{h_2} \in \mathfrak{R}^{S'}$ be the paths such that S_i extends H_i , for all $h_3 + 1 \leq i \leq h_2$. As the paths S_i do not intersect any $Q \in \mathfrak{Q}_1$ but do intersect $u(Q)$ for every $Q \in \mathfrak{Q}''$ this means that for every $1 \leq i \leq o$ every S_i intersects a path $Q_j^u \in \mathfrak{Q}_1$ such that Q_j and Q_j^u are subpaths of the same path $\hat{Q}_j \in \mathfrak{Q}''$. Furthermore, by construction of \mathfrak{Q}_1 , Q_j^u must occur on \hat{Q}_j before Q_j .

For $0 \leq i \leq k^l$ we inductively construct a set $\mathcal{I}_i \subseteq \mathcal{H}^u$ and for $1 \leq i \leq k^l$ a path $J_i \in \mathcal{H}^u$ and a path L_i with the following properties. L_i has as first vertex the last vertex of H_{h_3+i} and as last vertex the first vertex on J_i that J_i has in common with any path in $\mathcal{V}^2 \cup \mathcal{V}^3 \cup \mathcal{V}^4$ (when traversing J_i from beginning to end). Furthermore, all J_i occur in the grid \mathcal{H} “higher up” than every path in \mathcal{I}_i , i.e. on the paths in \mathcal{V} , the paths J_1, \dots, J_i occur before the paths in \mathcal{I}_i . Finally, $\{L_1, \dots, L_i\}$ is a half-integral linkage. Note that $V(J_i) \cap V(L_i) \neq \emptyset$.

Initially we set $\mathcal{I}_0 := \mathcal{H}^u$ which obviously satisfies the condition.

Now suppose $0 \leq i < k^l$ and \mathcal{I}_i , and if $i \geq 1$ also J_1, \dots, J_i and L_1, \dots, L_i , have already been defined satisfying the conditions above.

Consider the initial subpath of S_{h_3+i+1} which ends at the first vertex v that S_{h_3+i+1} has in common with \hat{Q}_{i+1} . Let $\sigma(\hat{Q}_{i+1}) = (Q_1^{i+1}, \dots, Q_{i+1}^{i+1})$ and let l be the maximal index such that the paths $R \in \mathfrak{R}^l$ intersect Q_l^{i+1} . Let j be the index such that $v \in V(Q_j^{i+1})$.

- If $j < l$ then let $J_{i+1} = H_m$ for the minimal m such that $H_m \in \mathcal{I}_i$, i.e. J_{i+1} is the highest path in \mathcal{I}_i . We set $\mathcal{I}_{i+1} = \mathcal{I}_i \setminus \{J_{i+1}\}$. We construct L_{i+1} as follows. As S_{h_3+i+1} does not intersect Q_1^{i+1} , it follows that $j > 1$. Let L^l be the initial subpath of S_{h_3+i+1} up to v and let L^m be the subpath of \hat{Q}_{i+1} from v downwards to a vertex $v' \in V(J_{i+1}) \cap V(Q_1^{i+1})$. Finally, let L^m be the subpath of J_{i+1} from v' to the first vertex v'' that J_{i+1} has in common with any path in $\mathcal{V}^2 \cup \mathcal{V}^3 \cup \mathcal{V}^4$. Then $L^l \cup L^m \cup L^m$ contains a path L_{i+1} from the endpoint of H_{h_3+i+1} to v'' . Hence, $\mathcal{I}_{i+1}, J_{i+1}$ and L_{i+1} satisfy the conditions above.
- If $j > l$ then again let J_{i+1} be the highest path in \mathcal{I}_i , i.e. let $J_{i+1} = H_m$ for the minimal m such that $H_m \in \mathcal{I}_i$. We set $\mathcal{I}_{i+1} = \mathcal{I}_i \setminus \{J_{i+1}\}$ and construct L_{i+1} as follows. Let L^l be the initial subpath of S_{h_3+i+1} that ends at the vertex v and let L^m be a subpath of \hat{Q}_{i+1} of minimal length from v to a vertex $v' \in V(J_{i+1}) \cap V(Q_l^{i+1})$. Finally, let L^m be the subpath of J_{i+1} from v' to the first vertex v'' that J_{i+1} has in common with any path in $\mathcal{V}^2 \cup \mathcal{V}^3 \cup \mathcal{V}^4$. Then $L^l \cup L^m \cup L^m$ contains a path L_{i+1} from the endpoint of S_{h_3+i+1} to v'' . Hence, $\mathcal{I}_{i+1}, J_{i+1}$ and L_{i+1} satisfy the conditions above. See Figure 16 b) for an illustration.
- Finally, suppose $j = l$. Suppose first that at least half of the paths in \mathcal{I}_i occur on Q_l^i before v . We set \mathcal{I}^l to be these paths. Let J_{i+1} be the highest path in \mathcal{I}^l and set $\mathcal{I}_{i+1} := \mathcal{I}^l \setminus \{J_{i+1}\}$. We then construct the path L_{i+1} as in the first case above.

Otherwise, if more than half of the paths in \mathcal{I}_i occur lower than v then let \mathcal{I}' be the paths in \mathcal{I}_i below v and choose the highest path $J_{i+1} \in \mathcal{I}'$. We set $\mathcal{I}_{i+1} := \mathcal{I}' \setminus \{J_{i+1}\}$ and proceed as in the second case above to construct the path L_{i+1} .

This completes the construction of \mathcal{I}_i, J_i and L_i . We require

$$(36) \quad k' \geq 6\hat{k},$$

where \hat{k} is the number defined in Lemma 6.5 (called t' in the statement of the lemma). We now choose a subgrid \mathcal{U} in $\mathcal{I}_{k'}$ and \mathcal{V}_3 of order $6\hat{k}$. Let H_1^u, \dots, H_k^u be the horizontal paths in \mathcal{U} ordered from top to bottom. Let a_i and b_i be the start and end vertex of H_i^u , respectively.

Then, we use the paths $J_1, \dots, J_{k'}, L_1, \dots, L_{k'}$, the subgrid of \mathcal{H} restricted to the parts in \mathcal{V}^4 and the subgrid of \mathcal{H} restricted to the parts in \mathcal{V}^2 to construct a half-integral linkage \mathcal{L}' from $B := \{b_{\frac{2}{3}k'+1}, \dots, b_{k'}\}$ to $A := \{a_1, \dots, a_{\frac{1}{3}k'}\}$. By Lemma 2.12 there also exists an integral linkage \mathcal{L} of order $\frac{1}{2}|\mathcal{L}'| = 3\hat{k}$ from B to A . Thus, we can apply Lemma 6.5 to obtain a cylindrical grid of order k as a butterfly minor, as requested. \square

By the previous lemma, if

$$(37) \quad r_5 \geq (q_1'')^{o_l} \cdot (\hat{r}_5' + r^s)$$

$$(38) \quad q_1'' \geq \hat{q}_1' - o_l,$$

for some suitable numbers \hat{r}_5' and \hat{q}_1' to be determined below, then either we get a cylindrical grid of order k , in which case we are done, or we can assume that there is a set $\hat{R}_5' \subseteq \hat{R}_5$ of order \hat{r}_5' and a set $\hat{Q}_1' \subseteq \hat{Q}_1''$ of order \hat{q}_1' , such that for every $R \in \hat{R}_5'$, the subpath $S(R)$ intersects every path in \hat{Q}_1' . Furthermore, the pair $(\hat{Q}_1', M(\hat{R}_5'))$ still forms a segmentation.

Now, if

$$(39) \quad \hat{q}_1' \geq \hat{r}_5'! \cdot q_1^l,$$

for some suitable number q_1^l determined below, then we can apply Lemma 5.10 Part (1) to get a set $\mathcal{Q}_1^l \subseteq \hat{Q}_1'$ of order q_1^l such that $(\mathcal{Q}_1^l, M(\hat{R}_5'))$ forms a strong segmentation.

We are now ready to complete the proof. In the rest, the key idea is to apply the same construction to $(\mathcal{Q}_1^l \setminus \mathcal{O}, S(\hat{R}_5'))$ (which again has linkedness q^*). Again, if we obtain the split case, then we can finish the proof fairly quickly. So we are left with the segmentation \mathcal{S} as outcome of Corollary 5.16 applied to $(\mathcal{Q}_1^l \setminus \mathcal{O}, S(\hat{R}_5'))$.

Now we look at the intersection of \mathcal{S} and $(\mathcal{Q}_1^l, M(\hat{R}_5'))$. If some part of \mathcal{S} is “separated” from $(\mathcal{Q}_1^l, M(\hat{R}_5'))$, the situation is described as in Figure 18 (a), and we obtain a cylindrical grid of order k as a butterfly minor. So \mathcal{S} is indeed “included” in $(\mathcal{Q}_1^l, M(\hat{R}_5'))$, as in Figure 18 (b). We shall see how to handle this case below but before, we first apply the same construction to $(\mathcal{Q}_1^l \setminus \mathcal{O}, S(\hat{R}_5'))$ (which again has linkedness q^*).

We require that r_5^l is large enough so that if in Corollary 5.16 we set p to q_1^l , y to q_s , x to q_5 , c to q^* and q to q_7 , for suitable values of q_s, q_5, r_7 to be determined

below, then r'_5 is larger than the number q' specified in the lemma. We can then apply Corollary 5.16 to $(\mathcal{Q}'_1 \setminus \mathcal{O}, S(\hat{R}'_5))$ and either we get

- (1) a (q_s, r_7) -split $(\mathcal{Q}_s, \mathcal{R}_7^S)$ obtained from a single path $Q \in \mathcal{Q}'_1 \setminus \mathcal{O}$ which is split into q_s subpaths, i.e. $Q = Q_1 \cdot e_1 \cdot Q_2 \cdots e_{q_s-1} \cdot Q_{q_s}$, or
- (2) we obtain a strong (q_5, r_7) -segmentation $(\mathcal{Q}_5, \mathcal{R}_7^S)$ defined by a subset $(\mathcal{Q}_5, \mathcal{R}_7^S)$ $\mathcal{R}_7^S \subseteq S(\hat{R}'_5)$ of order r_7 and a set \mathcal{Q}_5 of order q_5 of subpaths of paths in $\mathcal{Q}'_1 \setminus \mathcal{O}$ satisfying the extra conditions of Corollary 5.16.

In the first case, we can get a cylindrical grid of order t as a butterfly minor as before. Indeed, as before, whenever we get a split of large order, we are done. For completeness, we give a proof here.

Lemma 6.17. *If applying Corollary 5.16 to $(\mathcal{Q}'_1 \setminus \mathcal{O}, S(\hat{R}'_5))$ yields a (q_s, r_7) -split $(\mathcal{Q}_s, \mathcal{R}_7^S)$ obtained from a single path $Q \in \mathcal{Q}'_1 \setminus \mathcal{O}$ which is split into q_s subpaths, then G contains a cylindrical grid of order k as a butterfly minor.*

Proof. Let $\hat{\mathcal{R}}_7 \subseteq \{R \in \mathcal{R}^* : S(R) \in \mathcal{R}_7^S\}$. Hence, $\hat{\mathcal{R}}_7$ is a linkage of order r_7 from the bottom of the original fence \mathcal{F} to its top and $\hat{\mathcal{R}}_7$ and \mathcal{Q}_s form a pseudo-fence \mathcal{F}'_p .

We can now define paths back from the end vertices of $\hat{\mathcal{R}}_7$ to their start vertices as follows. Let $A_1 \subseteq A$ be the set of end vertices of the paths in $\hat{\mathcal{R}}_7$ and let $B_1 \subseteq B$ be set of the start vertices of the paths in $\hat{\mathcal{R}}_7$. Choose a set $\mathcal{Q}_d \subseteq \mathcal{O}$ of order r_7 , which is possible as we require

$$(40) \quad t \geq r_7.$$

Let $A'_1 \subseteq A'$ and $B'_1 \subseteq B'$ be the set of start and end vertices of the paths in \mathcal{Q}_d . Then there is a linkage \mathcal{L}_u of order r_7 from A_1 to A'_1 in \mathcal{F}_1 and a linkage \mathcal{L}_d of order r_7 from B'_1 to B_1 in \mathcal{F}_3 . Hence, $\mathcal{L}_u \cup \mathcal{Q}_d \cup \mathcal{L}_d$ form a linkage \mathcal{L} of order r_7 from A_1 to B_1 . Let B_2 be the start vertices of the paths in \mathcal{R}_7^S and A_2 be their end vertices.

Every path $R \in \hat{\mathcal{R}}_7$ can be split into three disjoint subpaths, $D(R), S(R), U(R)$, where $D(R)$ is the initial component of $R - S(R)$ and $U(R)$ is the subpath following $S(R)$. Then, $\mathcal{L} \cup \bigcup \{U(R), D(R) : R \in \hat{\mathcal{R}}_7\}$ form a half-integral linkage from A_2 to B_2 of order r_7 and hence, by Lemma 2.12, there is an integral linkage \mathcal{L}' of order $\frac{1}{2}r_7$ from A_2 to B_2 . Note that \mathcal{R}_7^S and \mathcal{L}'' are vertex disjoint. Hence, if

$$(41) \quad \frac{1}{2}r_7 \geq f'(k)$$

$$(42) \quad q_s \geq f''(k),$$

where f', f'' are the functions implicitly defined in Lemma 6.9, i.e. setting t' to $f'(k)$ and t'' to $f''(k)$ in the statement of the lemma yields a cylindrical grid of order k , we can apply Lemma 6.9 to $(\mathcal{Q}_s, \mathcal{R}_7^S)$ and \mathcal{L}'' to obtain a cylindrical grid of order k as a butterfly minor. \square

So we can now assume that instead we get a strong (q_5, r_7) -segmentation $\mathcal{S}_2 := (\mathcal{Q}_5, \mathcal{R}_7^S)$. Let $\mathcal{R}_7^M \subseteq \mathcal{R}_5$ be the paths R in \mathcal{R}_5 which have a continuation in \mathcal{R}_7^S , i.e. $\mathcal{R}_7^M := \{M(R) : R \in \hat{\mathcal{R}}_5 \text{ and } S(R) \in \mathcal{R}_7^S\}$. Let $\mathcal{S}'_1 := (\mathcal{Q}'_1, \mathcal{R}_7^M)$ be the restriction of \mathcal{S}_1 to these paths \mathcal{R}_7^M . (Recall that \mathcal{S}_1 is the first segmentation obtained above.) Note that every path R in \mathcal{R}_7^M ends in a vertex v such that the

\mathcal{S}_2
 \mathcal{R}_7^M
 \mathcal{S}'_1

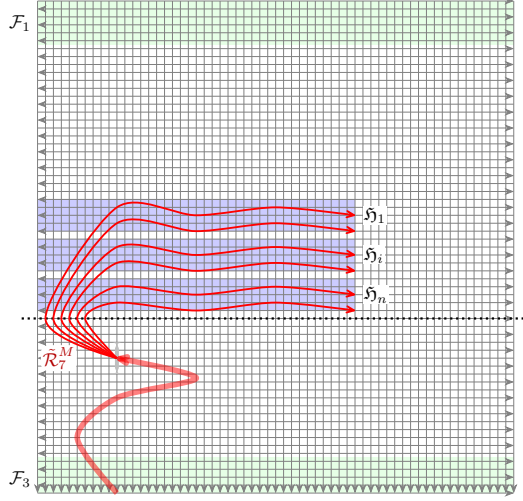
FIGURE 17. Horizontal strips in the segmentation \mathcal{S}_1'' .

successor of v on R' is the start vertex of a path in \mathcal{R}_7^S , where R' is the path such that $M(R') = R$.

We now show that if we look at \mathcal{S}_1' and \mathcal{S}_2 , they either give the situation in Figure 18 (a) or that in Figure 18 (b). Then we shall show that this situation does not allow the “down” jumps as in Figure 19 (the red arrows). For this purpose, having a pseudo-fence in the following lemma is critical. More precisely we prove the following lemma.

Lemma 6.18. *For all q_6, r_8 there are minimal values for r_7 and q_5 such that $\mathcal{Q}_5 \cup \mathcal{R}_7^M \cup \mathcal{R}_7^S$ contains a cylindrical grid of order k as a butterfly minor or a pseudo-fence $(\mathcal{Q}_6, \mathcal{R}_8)$ for some $\mathcal{R}_8 \subseteq \mathcal{R}_7^M \cup \mathcal{R}_7^S$ of order r_8 and some $\mathcal{Q}_6 \subseteq \mathcal{Q}_5$ of order q_6 .*

Proof. We first consider the pair $(\mathcal{Q}_5, \mathcal{R}_7^M)$. Note that the paths in \mathcal{Q}_5 are obtained from paths in \mathcal{Q}_1^l but possibly by splitting paths in \mathcal{Q}_1^l . Recall that $(\mathcal{Q}_1^l, \mathcal{R}_7^M)$ is a strong segmentation \mathcal{S}_1' . It follows that $(\mathcal{Q}_5, \mathcal{R}_7^M)$ is still a strong segmentation but it is not necessarily true that every path in \mathcal{R}_7^M hits every path in \mathcal{Q}_5 . However, to obtain \mathcal{Q}_5 from \mathcal{Q}_1^l , a path in \mathcal{Q}_1^l can be split at most $q_s - 1$ times. Hence, if

$$(43) \quad r_7 \geq (h_2 \cdot h) \cdot q_s^{q_5}$$

then there is a set $\mathcal{Q}_6 \subseteq \mathcal{Q}_5$ of order $q_6 \geq \frac{q_5}{q_s}$ and a set $\tilde{\mathcal{R}}_7^M \subseteq \mathcal{R}_7^M$ of order $\tilde{r}_7 \geq h_2 \cdot h$ such that $\mathcal{S}_1'' := (\mathcal{Q}_6, \tilde{\mathcal{R}}_7^M)$ is a strong segmentation and every $R \in \tilde{\mathcal{R}}_7^M$ intersects every $Q \in \mathcal{Q}_6$.

Let $(R_1, \dots, R_{\tilde{r}_7})$ be an ordering of $\tilde{\mathcal{R}}_7^M$ in the order in which the paths appear on the paths in \mathcal{Q}_6 from top to bottom. We split \mathcal{S}_1'' into horizontal strips as follows. For all $1 \leq i \leq h$ let $\mathfrak{H}_i^M := (\mathcal{Q}_6, \mathcal{H}_i^M)$ where $\mathcal{H}_i^M := \{R_{(i-1) \cdot h_2 + 1}, \dots, R_{i \cdot h_2}\}$.

As $r_7 \geq h_2 \cdot h$, every \mathfrak{H}_i^M is itself a strong segmentation using h_2 paths of $\tilde{\mathcal{R}}_7^M$ and the corresponding subpaths of \mathcal{Q}_6 . See Figure 17 for an illustration.

For every \mathfrak{H}_i^M let $\mathcal{H}_i^S \subseteq \mathcal{R}_7^S$ be the paths in \mathcal{R}_7^S whose start vertex is the successor of the end vertex of a path in \mathcal{H}_i^M . We define $\mathfrak{H}_i^S := (\mathcal{Q}_6, \mathcal{H}_i^S)$. Again, this is a strong segmentation. Furthermore, every horizontal path $R \in \mathcal{H}_i^M$ can be continued by a path in \mathcal{H}_i^S .

By construction of \mathcal{Q}'' , for every $1 \leq i \leq h$ and for every $Q \in \mathcal{Q}_6$, at most q^* paths in \mathcal{H}_i^S can contain a vertex $v \in V(Q)$ such that v appears on Q after the last vertex Q has in common with any path in \mathcal{H}_i^M .

Hence, we can take a subset $\mathcal{H}_i^{!S} \subseteq \mathcal{H}_i^S$ of order $h_3 := h_2 - q_6 \cdot q^*$ such that no path in $\mathcal{H}_i^{!S}$ contains a vertex $v \in V(Q)$, for any $Q \in \mathcal{Q}_6$, which appears after the last vertex Q shares with \mathcal{H}_i^M . We now claim that the horizontal strips must intersect nicely as illustrated in Figure 18 b).

Claim 1. $\mathcal{Q}_5 \cup \mathcal{R}_7^M \cup \mathcal{R}_7^S$ contains a cylindrical grid of order k as a butterfly minor or there is a subset $\mathcal{Q}_5' \subseteq \mathcal{Q}_6$ of order q_5' and for every $1 \leq i \leq h$ a subset $\tilde{\mathcal{H}}_i^S \subseteq \mathcal{H}_i^{!S}$ of order h_4 , for some suitable numbers q_5' and h_4 to be determined below, such that every $R \in \tilde{\mathcal{H}}_i^S$ intersects every $Q \in \mathcal{Q}_5'$ in the subpath of Q between the top path $R_{(i-1) \cdot h_2 + 1}$ and the lowest path $R_{i \cdot h_2}$ in \mathcal{H}_i^M .

Proof. For every $R \in \mathcal{H}_i^{!S}$ let $\pi_i(R)$ be the set of paths $Q \in \mathcal{Q}_6$ such that R intersects Q only in vertices which occur on Q before the first vertex Q has in common with \mathcal{H}_i^M . Now suppose there are at least $\tilde{h} \cdot \binom{q_6}{q_7}$ paths $R \in \mathcal{H}_i^{!S}$ with $|\pi_i(R)| \geq q_7$, for some numbers \tilde{h} and q_7 to be determined below. By the pigeon hole principle, there is a set $\tilde{\mathcal{H}}_i^S \subseteq \mathcal{H}_i^{!S}$ of order \tilde{h} such that $\pi_i(R) = \pi_i(R')$ for all $R \in \tilde{\mathcal{H}}_i^S$ and $|\pi_i(R)| \geq q_7$. We claim that in this case we obtain a cylindrical grid of order k . The construction is illustrated in Figure 18 a).

Let $\mathcal{V} := \pi_i(R)$ for some (and hence all) $R \in \tilde{\mathcal{H}}_i^S$. Let $\tilde{\mathcal{H}}_i^M \subseteq \mathcal{H}_i^M$ be the set of paths in \mathcal{H}_i^M ending in the predecessor of a start vertex of a path in $\tilde{\mathcal{H}}_i^S$. Finally, let $\tilde{\mathcal{Q}}^M$ be the set of minimal subpaths of paths $Q \in \mathcal{V}$ containing every vertex Q has in common with $\tilde{\mathcal{H}}_i^M$. By construction, every $Q \in \tilde{\mathcal{Q}}^M$ is disjoint from every $R \in \tilde{\mathcal{H}}_i^S$. For every $Q \in \mathcal{V}$ we can therefore take the subpath $i(Q)$ from the beginning of Q to the predecessor of the first vertex Q has in common with $\tilde{\mathcal{H}}_i^M$. Let $\tilde{\mathcal{Q}}^S := \{i(Q) : Q \in \mathcal{V}\}$. Then $\tilde{\mathcal{Q}}^S$ and $\tilde{\mathcal{H}}_i^S$ form a strong (q_7, \tilde{h}) -segmentation. By Lemma 5.21 using Property (2), if

$$(44) \quad \tilde{h} \geq f_r(h_6) \cdot \binom{f_p(3h_6)}{3h_6} \cdot (3h_6)! \cdot 4h_6$$

$$(45) \quad q_7 \geq f_p(3h_6) \cdot \tilde{h}!,$$

for some suitable number h_6 to be determined below, then $(\tilde{\mathcal{Q}}^M, \tilde{\mathcal{H}}_i^M)$ contains an acyclic (h_6, h_6) -grid $\mathcal{G} := (\mathcal{V}_{\mathcal{G}}, \mathcal{H}_{\mathcal{G}})$ such that the paths $\mathcal{H}_{\mathcal{G}}$ are obtained from subpaths of $\tilde{\mathcal{Q}}^M$ and $\tilde{\mathcal{H}}_i^M$ preserving the end vertices of the paths in $\tilde{\mathcal{H}}_i^M$. Here f_r, f_p are the functions defined in Lemma 5.19. Let $\mathcal{V}_{\mathcal{G}} := (V_1, \dots, V_{q_7})$ be ordered in the order in which they appear on the paths in $\mathcal{H}_{\mathcal{G}}$ and let $\mathcal{H}_{\mathcal{G}} := (H_1, \dots, H_{h_6})$ be ordered in the order in which they appear on $\mathcal{V}_{\mathcal{G}}$.

The following argument is illustrated in Figure 18 a). To this end let \mathcal{U} be the subgrid of \mathcal{G} formed by $(\mathcal{V}_{\mathcal{U}}, \mathcal{H}_{\mathcal{U}})$ where $\mathcal{V}_{\mathcal{U}}$ is the set of minimal subpaths of $\mathcal{V}_{\mathcal{G}}$

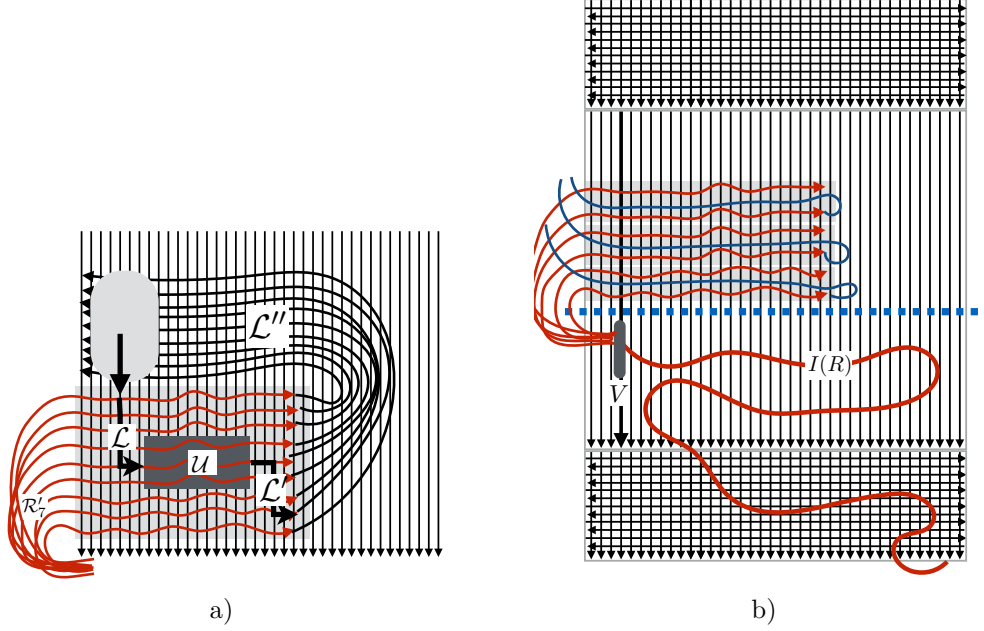

FIGURE 18. a) Creating a cylindrical grid from two disjoint horizontal strips and b) two segmentations \mathcal{S}_1 and \mathcal{S}_2 forming a pseudo-fence.

to include every vertex of $H_{\frac{1}{3}h_6}, \dots, H_{\frac{2}{3}h_6}$ and $\mathcal{H}_{\mathcal{U}}$ are the minimal subpaths of $H_{\frac{1}{3}h_6}, \dots, H_{\frac{2}{3}h_6}$ including every vertex they have in common with $\mathcal{V}_{\mathcal{U}}$. Note that the top and the bottom of this grid are the endpoints of the paths in $\mathcal{H}_{\mathcal{U}}$, i.e. the grid is “tilted”.

Then in \mathcal{G} there is a linkage \mathcal{L} of order $\frac{1}{3}h_6$ from the start vertices of $V_1, \dots, V_{\frac{1}{3}h_6}$ to the top of \mathcal{U} , i.e. the start vertices of $\mathcal{H}_{\mathcal{U}}$, and a linkage \mathcal{L}' of order $\frac{1}{3}h_6$ from the bottom of \mathcal{U} , i.e. the end vertices of $\mathcal{H}_{\mathcal{U}}$, to the end vertices of $H_{\frac{2}{3}h_6}, \dots, H_{h_6}$. Furthermore, in $\tilde{\mathcal{H}}_i^S \cup \tilde{\mathcal{Q}}^S$ which forms a strong (q_7, \tilde{h}) -segmentation, as mentioned above, there is a linkage \mathcal{L}'' from the end vertices of $H_{\frac{2}{3}h_6}, \dots, H_{h_6}$ to the start vertices of $V_1, \dots, V_{\frac{1}{3}h_6}$. As $\mathcal{L}, \mathcal{L}', \mathcal{L}''$ are pairwise disjoint except for the end vertices they have in common, they form a linkage \mathcal{L}''' from the bottom of \mathcal{U} to the top which is disjoint from \mathcal{U} . We require that

$$(46) \quad h_6 \geq 3\hat{k},$$

where \hat{k} is the integer defined in Lemma 6.5 (called t' in the statement of the lemma). We can now apply Lemma 6.5 to obtain a cylindrical grid of order k as a butterfly minor. \dashv

By the previous claim, in every \mathcal{H}_i^M there is a path $R \in \mathcal{H}_i^M$ and a path $R' \in \mathcal{H}_i^S$ such that the endpoint of R is the start vertex of R' and a set $\gamma(R') \subseteq \mathcal{Q}_6$ of order q_7 such that R' hits every path $Q \in \mathcal{Q}_i^S$ within \mathcal{H}_i^M . For all $1 \leq i \leq h$ we choose such a path R_i and R'_i . Note that \mathcal{S}_2 is a strong segmentation of \mathcal{Q}'' , hence no

path R'_i can intersect any $Q \in \mathcal{Q}'_i$ at a vertex v which occurs on Q before a vertex $w \in V(Q) \cap V(R'_j)$ for some $j < i$.

We require

$$(47) \quad h \geq \binom{q''}{q_7} \cdot r_8.$$

Thus, we can choose a set \mathcal{R}_8 of paths R_i and R'_i such that $\gamma(R_i) = \gamma(R'_i)$ for all $R_i, R'_i \in \mathcal{R}_8$. Let $\mathcal{Q}'_6 := \gamma(R'_i)$ for some (and hence all) $R'_i \in \mathcal{R}_8$. Hence, \mathcal{R}_8 and \mathcal{Q}'_6 form a pseudo-fence as required. \square

Finally, we are ready to finish the proof. Suppose now the previous lemma does not result in a cylindrical grid of order k . Hence, we now have a pseudo-fence $(\mathcal{Q}'_6, \mathcal{R}_8)$ for some $\mathcal{R}_8 \subseteq \mathcal{R}_7^M \cup \mathcal{R}_7^S$ of order r_8 and some $\mathcal{Q}'_6 \subseteq \mathcal{Q}_5$ of order q_6 . The current situation is illustrated in Figure 18 b).

We shall show that the current situation does not allow the “down” jumps as in Figure 19 (the red arrows). For this purpose, having a pseudo-fence $(\mathcal{Q}'_6, \mathcal{R}_8)$ is critical.

Recall Definition 6.14 of the vertex $v(Q)$. Let $V \in \mathcal{Q}''$ be the path such that every $R \in \mathcal{R}_3$ contains a good vertex $v(R)$ on V . We define $\mathcal{Q}_7 := \mathcal{Q}'_6 \cup \{V\}$. Now, \mathcal{R}_8 and \mathcal{Q}_7 are no longer a pseudo-fence, but they are a pseudo-fence in restriction to \mathcal{Q}'_6 and furthermore, every path $R \in \mathcal{R}_8$ also intersects V .

Recall that \mathcal{R}_8 is a set of paths $R_i \in \mathcal{R}_7^M$ and $R'_i \in \mathcal{R}_7^S$ such that R'_i is the continuation of R_i , i.e. there is a path $\hat{R}_i \in \mathcal{R}^*$ and R_i, R'_i are subpaths of \hat{R}_i such that the start vertex of R'_i is the successor on \hat{R}_i of the end vertex of R_i . Let (R'_1, \dots, R'_{r_8}) be an ordering of the paths $R'_i \in \mathcal{R}_8 \cap \mathcal{R}_7^S$ in the order in which they occur on the paths in \mathcal{Q}'_6 . We require

$$(48) \quad r_8 \geq (h'_9)^2,$$

for some value of h'_9 to be determined below. As in the proof of the previous lemma we define horizontal strips $\mathcal{H}_i := \{R_{(i-1)h'_9+1} \cup R'_{(i-1)h'_9+1}, \dots, R_{ih'_9} \cup R'_{ih'_9}\}$, for all $1 \leq i \leq h'_9$, and let $\mathcal{V}_i := \{m_i(Q) : Q \in \mathcal{Q}'_6\}$ where $m_i(Q)$ is the minimal subpath of Q containing every vertex of $V(\mathcal{H}_i)$. Recall from above that every path $R \in \mathcal{R}^*$ is split into three distinct parts, $I(R)$, $M(R)$ and $S(R)$. The subpaths $M(R)$ and $S(R)$ are part of the construction of \mathcal{R}_8 , where the $M(R)$ play the role of the R_i above and the $S(R)$ play the role of R'_i . We will now use the initial subpaths $I(R)$. Recall further that the endpoint of each $I(R)$ for $R \in \mathcal{R}_3$ is on the path V .

We require that

$$(49) \quad h'_9 \geq 2q^* + 2$$

to make sure that the following lemma holds.

Lemma 6.19. *There is a $1 \leq i \leq h'_9$ such that $I := \{I(R) : M(R) \in \mathcal{H}_i\}$ is disjoint from $\mathcal{H}_i \cup \mathcal{V}_i$.*

Proof. Towards a contradiction, suppose the claim was false. For every $1 \leq i \leq h'_9$ choose a path $M(\hat{R}_i) \in \mathcal{H}_i$ such that $I(\hat{R}_i)$ intersects $\mathcal{H}_i \cup \mathcal{V}_i$. As $I(\hat{R}_i)$ ends in V , in fact ends in $l(V)$, and furthermore, every path $R \in \mathcal{H}_i$ intersects $u(V)$, this implies that there is a path P_i from $u(V)$ to $l(V)$ in $\mathcal{H}_i \cup \mathcal{V}_i \cup I(\hat{R}_i)$. Note that for

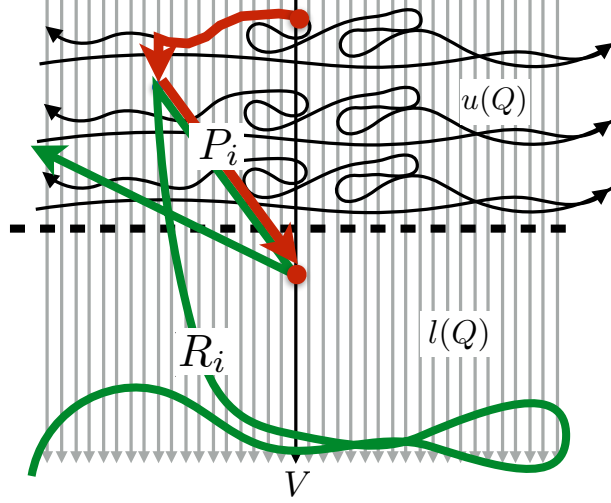

FIGURE 19. Illustration for the last lemma.

$i \neq j$ the paths P_i and P_j may not be disjoint, as, e.g., $I(R_i)$ may intersect \mathcal{H}_i and \mathcal{H}_j .

However, the set $\{P_i : 1 \leq i \leq h'_9\}$ forms a half-integral linkage from $u(V)$ to $l(V)$ and therefore, by Lemma 2.12, there also is an integral linkage of order $\frac{1}{2}h'_9$. See Figure 19 for an illustration.

As $h'_9 \geq 2q^* + 2$, this contradicts the fact that in \mathcal{Q}'' at most q^* paths can go from some $u(Q)$ to $l(Q)$, see Lemma 6.11. \square

Let $i \leq h'_9$ be such that $I := \{I(\hat{R}) : M(\hat{R}) \in \mathcal{H}_i\}$ is disjoint from $\mathcal{H}_i \cup \mathcal{V}_i$. Let $\mathcal{H} \subseteq \{M(R) : M(R) \in \mathcal{H}_i\}$ be a set of order h_{10} , for some h_{10} to be determined below. Note that \mathcal{H} is a subset of \mathcal{H}_i with the paths $S(R)$ removed, which are no longer needed. We require that

$$(50) \quad h'_9 \geq h_{10}$$

$$(51) \quad h_{10} \geq f_r(s) \binom{f_p(3s)}{3s} \cdot (3s)! \cdot 4s$$

$$(52) \quad q_6 \geq f_p(3s) \cdot h_{10}!$$

where $s = 18s'$ and s' is such that if in Lemma 6.5 we set t' to s' and thus t to $6s$ then the lemma implies a cylindrical grid of order k as a butterfly minor. Here, f_r, f_p are the functions defined in Lemma 5.19.

By Lemma 5.21, $(\mathcal{V}_i, \mathcal{H})$ contains an (s, s) -grid $\mathcal{U} := (\mathcal{V}'_i, \hat{\mathcal{H}})$ which can be chosen so that the start vertices of the paths $M(R)$ are preserved. Let (H_1, \dots, H_s) be an ordering of $\hat{\mathcal{H}}$ in the order in which they occur on the paths in \mathcal{V}'_i and let (V_1, \dots, V_s) be an ordering of \mathcal{V}'_i in the order in which the paths occur on the paths in \mathcal{H} .

We now take the subgrid \mathcal{U}' induced by $(H_{\frac{1}{3}s+1}, \dots, H_{\frac{2}{3}s})$ and $(V_{\frac{1}{3}s+1}, \dots, V_{\frac{2}{3}s})$. More precisely, for every $H \in \{H_{\frac{1}{3}s+1}, \dots, H_{\frac{2}{3}s}\}$ let $\rho(H)$ be the minimal subpath of H containing all of $H \cap \bigcup \{V_{\frac{1}{3}s+1}, \dots, V_{\frac{2}{3}s}\}$ and for all $V' \in \{V_{\frac{1}{3}s+1}, \dots, V_{\frac{2}{3}s}\}$ let

$\rho(V')$ be the minimal subpath of V' containing all of $V' \cap \bigcup \{H_{\frac{1}{3}s+1}, \dots, H_{\frac{2}{3}s}\}$. Then \mathcal{U}' is the grid induced by $\{\rho(\{H_{\frac{1}{3}s+1}, \dots, H_{\frac{2}{3}s}\})\}$ and $\{\rho(V_{\frac{1}{3}s+1}, \dots, V_{\frac{2}{3}s})\}$. Let $(t_1, \dots, t_{\frac{1}{3}s})$ be the start vertices and $(b_1, \dots, b_{\frac{1}{3}s})$ be the end vertices of the paths $(\rho(\{H_{\frac{1}{3}s+1}, \dots, H_{\frac{2}{3}s}\}))$. Let $T := \{t_1, \dots, t_{\frac{1}{3}s}\}$ and $B := \{b_{\frac{1}{3}s-\frac{1}{9}}, \dots, b_{\frac{1}{3}s}\}$.

We can now construct a linkage from B to T as follows. Let \mathcal{I}' be the set of paths $I(R)$ with end vertex in T . By construction, every $I(R)$ intersects every $l(Q)$ for $Q \in \{V_{\frac{2}{3}s}, \dots, V_s\}$, but does not intersect any vertex in \mathcal{U}' . Hence, $\{V_{\frac{2}{3}s}, \dots, V_s\} \cup \{H_{\frac{2}{3}s}, \dots, H_s\} \cup \mathcal{I}'$ contains a half-integral linkage from B to T , and therefore by Lemma 2.12, also an integral linkage \mathcal{L} from B to T of order $\frac{1}{6}s$.

By our choice of s , Lemma 6.5 implies that \mathcal{U}' together with \mathcal{L} contains a cylindrical grid of order k as a butterfly minor. This completes the proof of Theorem 6.1 and hence the proof of Theorem 3.7 and therefore Theorem 1.2.

7. CONCLUSION

In this paper we proved the directed grid conjecture by Reed and Johnson, Robertson, Seymour and Thomas. We view this result as a first but significant step towards a more general structure theory for directed graphs based on directed tree-width, similar to the grid theorem [45] for undirected graphs being the basis of more general structure theorems [48].

Our proof indeed yields the following algorithmic result, which is perhaps of independent interest.

- There is a function $f : \mathbb{N} \rightarrow \mathbb{N}$ such that given any directed graph and any fixed constant k , in polynomial time, we can obtain either
- (1) a cylindrical grid of order k as a butterfly minor or
 - (2) a directed tree decomposition of width at most $f(k)$.

In fact, since our cylindrical grid is obtained from two linkages \mathcal{P}, \mathcal{Q} , together with \mathbb{R} , such that all of $\mathcal{P}, \mathcal{Q}, \mathbb{R}$ are disjoint paths joining two vertices of the well-linked set, our proof implies the following.

Theorem 7.1. *There is a function $f : \mathbb{N} \rightarrow \mathbb{N}$ such that given a well-linked set F of order $f(k)$ in any directed graph and any constant k , there is a cylindrical wall W of order k , such that for any k vertices of degree at least three (i.e., vertices of either outdegree at least two or indegree at least two), there are k disjoint paths from F to W and from W to F*

In addition, such a cylindrical grid can be found in polynomial time if k is fixed.

This is indeed the analogue of the main result in [45].

Since the first version of this paper appears in STOC'15, there is some progress made for the directed graph structure theory and algorithms, building on our directed grid theorem. Firstly, building on our directed grid theorem, the directed version of the flat wall theorem (the weak structure theorem) in [47] is obtained in [21]. This is a significant step towards the directed version of the main structure theorem in [48], as in [33], the flat wall theorem is the base case for the (new) proof of the main graph minor structure theorem in [48].

Secondly, the tangle tree-decomposition theorem, proved by Robertson and Seymour in [46] in the graph minor series, turns out to be an extremely valuable tool in structural and algorithmic graph theory. In [22], the authors introduce directed

tangles and provide a directed tree-decomposition of digraphs G that distinguishes all maximal directed tangles in G . Furthermore, for any integer k , they construct a directed tree-decomposition that distinguishes all directed tangles of order k (and the construction results in a polynomial time algorithm for fixed k). Building on our directed grid theorem and this result, we can decide for a given digraph G and k pairs $(s_1, t_1), \dots, (s_k, t_k)$ of vertices either there are directed paths P_1, \dots, P_k such that P_i links s_i to t_i and such that no vertex of G is contained in more than two paths from $\{P_1, \dots, P_k\}$, or there are no k directed disjoint paths P_1, \dots, P_k such that P_i links s_i to t_i , see [22]. This improves the previous result in [29].

We also believe that this theorem will prove to be very useful for further applications of directed tree-width, for instance to Erdős-Pósa type results for directed graphs. Indeed, building on our directed grid theorem, a sufficient condition when Erdős-Pósa type results holds for strongly connected directed graphs is given in [3]. Furthermore, it is likely that the duality of directed tree-width and directed grids will make it possible to develop algorithm design techniques such as bidimensionality theory or the irrelevant vertex technique for directed graphs. We are particularly optimistic that this approach will lead to new results for the directed disjoint paths problem. We leave this for future research.

REFERENCES

- [1] I. Adler. Directed tree-width examples. *J. Comb. Theory, Ser. B*, 97(5), 718–725, 2007.
- [2] I. Adler, S. G. Kolliopoulos, P. K. Krause, D. Lokshtanov, S. Saurabh, and D. M. Thilikos. Tight bounds for linkages in planar graphs. In *ICALP*, pages 110–121, 2011.
- [3] S. A. Amiri, K. Kawarabayashi, S. Kreutzer, P. Wollan: The Erdos-Posa Property for Directed Graphs. CoRR abs/1603.02504 (2016)
- [4] E. Birmelé, J.A. Bondy, and B.A. Reed. The Erdős-Pósa property for long circuits. *Combinatorica*, 27(2), 135–145, 2007.
- [5] H. Bodlaender. A linear time algorithm for finding tree-decompositions of small treewidth. *SIAM Journal on Computing*, 25(6):1305–1317, 1996.
- [6] H. L. Bodlaender. Treewidth: Algorithmic techniques and results. In *Proc. of Mathematical Foundations of Computer Science (MFCS)*, volume 1295 of *Lecture Notes in Computer Science*, pages 19–36, 1997.
- [7] H. L. Bodlaender. Discovering treewidth. In *31st International Conference on Current Trends in Theory and Practice of Computer Science*, pages 1–16, 2005.
- [8] C. Chekuri and J. Chuzhoy. Polynomial bounds for the grid-minor theorem. In *Symp. on Theory of Computing (STOC)*, pp. 60 – 69, 2014.
- [9] J. Chuzhoy. Excluded Grid Theorem: Improved and Simplified. In *Symp. on Theory of Computing (STOC)* pp. 645 – 654, 2015.
- [10] M. Cygan, D. Marx, M. Pilipczuk, and M. Pilipczuk. The planar directed k -vertex-disjoint paths problem is fixed-parameter tractable. In *54th Annual IEEE Symposium on Foundations of Computer Science (FOCS)*, pages 197–206, 2013.
- [11] E. Demaine and M. Hajiaghayi. The bidimensionality theory and its algorithmic applications. *The Computer Journal*, pages 332–337, 2008.
- [12] E. Demaine and M. Hajiaghayi. Linearity of grid minors in treewidth with applications through bidimensionality. *Combinatorica*, 28(1):19–36, 2008.
- [13] E. D. Demaine and M. T. Hajiaghayi. Fast algorithms for hard graph problems: Bidimensionality, minors, and local treewidth. In *Graph Drawing*, pages 517–533, 2004.
- [14] E. D. Demaine and M. T. Hajiaghayi. Bidimensionality: new connections between FPT algorithms and PTASs. In *ACM-SIAM Symp. on Discrete Algorithms (SODA)*, pages 590–601, 2005.
- [15] R. Diestel. *Graph Theory*. Springer-Verlag, 3rd edition, 2005.
- [16] R. G. D. Downey and M. Fellows. *Fundamentals of Parameterized Complexity*. Springer, 2013.
- [17] P. Erdős and G. Szekeres. A combinatorial problem in geometry. *Compositio Mathematica*, 2:463–470, 1935.

- [18] F. V. Fomin, D. Lokshtanov, V. Raman, and S. Saurabh. Bidimensionality and EPTAS. In *ACM-SIAM Symp. on Discrete Algorithms (SODA)*, pages 748–759, 2011.
- [19] F. V. Fomin, D. Lokshtanov, S. Saurabh, and D. M. Thilikos. Bidimensionality and kernels. In *ACM-SIAM Symp. on Discrete Algorithms (SODA)*, pages 503–510, 2010.
- [20] S. Fortune, J. E. Hopcroft, and J. Wyllie. The directed subgraph homeomorphism problem. *Theor. Comput. Sci.*, 10:111–121, 1980.
- [21] A. Giannopoulou, K. Kawarabayashi, S. Kreutzer, and O. Kwon The directed flat wall theorem, *ACM-SIAM Symposium on Discrete Algorithms (SODA'20)*, 239–258.
- [22] A. Giannopoulou, K. Kawarabayashi, S. Kreutzer, and O. Kwon Directed Tangle Tree-Decompositions and Applications, *ACM-SIAM Symposium on Discrete Algorithms (SODA'22)*, 377–405.
- [23] M. Grohe, K. Kawarabayashi, D. Marx and P. Wollan, Finding topological subgraphs is fixed-parameter tractable, *the 43rd ACM Symposium on Theory of Computing (STOC'11)*, 479–488.
- [24] R. Halin, S -function for graphs, *J. Geometry* **8** (1976), 171–186.
- [25] F. Havet and A. K. Maia. On disjoint directed cycles with prescribed minimum lengths. INRIA Research Report, RR-8286, 2013.
- [26] T. Johnson, N. Robertson, P. D. Seymour, and R. Thomas. Directed tree-width. *J. Comb. Theory, Ser. B*, 82(1):138–154, 2001.
- [27] T. Johnson, N. Robertson, P. D. Seymour, and R. Thomas. Excluding a grid minor in digraphs. unpublished manuscript, 2001.
- [28] K. Kawarabayashi, Y. Kobayashi and B. Reed, The disjoint paths problem in quadratic time, *J. Combin. Theory Ser. B* **102** (2012), 424–435.
- [29] K. Kawarabayashi, Y. Kobayashi, and S. Kreutzer. An excluded half-integral grid theorem for digraphs and the directed disjoint paths problem. In *Proc. of the ACM Symposium on Theory of Computing (STOC)*, pp. 70-78, 2014.
- [30] K. Kawarabayashi, M. Krčál, D. Král, and S. Kreutzer. Packing directed cycles through a specified vertex set. In *ACM-SIAM Symp. on Discrete Algorithms (SODA)*, pp. 365-377, 2013.
- [31] K. Kawarabayashi and S. Kreutzer. An excluded grid theorem for digraphs with forbidden minors. In *ACM-SIAM Symp. on Discrete Algorithms (SODA)*, pp. 72-81, 2014.
- [32] K. Kawarabayashi and B. Reed, A nearly linear time algorithm for the half disjoint paths packing, *ACM-SIAM Symp. on Discrete Algorithms (SODA)*, 446–454.
- [33] K. Kawarabayashi, R. Thomas and P. Wollan, Quickly excluding a non-planar graph, CoRR abs/2010.12397 (2020)
- [34] Gunwoo Kim. *Comparing Definitions for Directed Tree Decompositions and Their Behaviour Under Taking Butterfly Minors*. Bachelor's Thesis at the Technical University Berlin. 2022.
- [35] J. Kleinberg, Decision algorithms for unsplittable flows and the half-disjoint paths problem, *Proc. 30th ACM Symposium on Theory of Computing (STOC), 1998*, 530–539.
- [36] S. Kreutzer and S. Ordyniak. Width-Measures for Directed Graphs and Algorithmic Applications. In *Quantitative Graph Theory: Mathematical Foundations and Applications*, CRC Press, 2014.
- [37] S. Kreutzer and S. Tazari. On Brambles, Grid-Like Minors, and Parameterized Intractability of Monadic Second-Order Logic. In *ACM-SIAM Symp. on Discrete Algorithms (SODA)*, pp. 354–364, 2010., (full version to appear in the Journal of the ACM).
- [38] S. Kreutzer and S. Tazari. Directed nowhere dense classes of graphs. In *ACM-SIAM Symp. on Discrete Algorithms (SODA)*, pp. 1552-1562, 2012.
- [39] http://www.openproblemgarden.org/op/erdos_posa_property_for_long_directed_cycles
- [40] B. Reed. Tree width and tangles: A new connectivity measure and some applications. In R. Bailey, editor, *Surveys in Combinatorics*, pages 87–162. Cambridge University Press, 1997.
- [41] B. Reed. Introducing directed tree-width. *Electronic Notes in Discrete Mathematics*, 3:222 – 229, 1999.
- [42] B. A. Reed, N. Robertson, P. D. Seymour, and R. Thomas. Packing directed circuits. *Combinatorica*, 16(4):535–554, 1996.
- [43] B. A. Reed and D. R. Wood. Polynomial treewidth forces a large grid-like-minor. *Eur. J. Comb.*, 33(3):374–379, 2012.
- [44] N. Robertson and P. D. Seymour. Graph minors I – XXIII, 1982 – 2010. Appearing in Journal of Combinatorial Theory, Series B from 1982 till 2010.

- [45] N. Robertson and P. D. Seymour. Graph minors V. Excluding a planar graph. *Journal of Combinatorial Theory, Series B*, 41(1):92–114, 1986.
- [46] N. Robertson and P. D. Seymour. Graph minors X. Obstructions to tree-decomposition. *Journal of Combinatorial Theory, Series B*, 52(2):153–190, 1991.
- [47] N. Robertson and P. Seymour. Graph minors XIII. The disjoint paths problem. *Journal of Combinatorial Theory, Series B*, 63:65–110, 1995.
- [48] N. Robertson and P. Seymour. Graph minors XVI. Excluding a non-planar graph. *Journal of Combinatorial Theory, Series B*, 77:1–27, 1999.

NATIONAL INSTITUTE OF INFORMATICS, 2-1-2 HITOTSUBASHI, CHIYODA-KU, TOKYO, JAPAN
Email address: `k_keniti@nii.ac.jp`

CHAIR FOR LOGIC AND SEMANTICS, TECHNICAL UNIVERSITY BERLIN, SEKR TEL 7-3, ERNST-REUTER PLATZ 7, 10587 BERLIN, GERMANY
Email address: `stephan.kreutzer@tu-berlin.de`