

# FROM SELF-SIMILAR GROUPS TO SELF-SIMILAR SETS AND SPECTRA

ROSTISLAV GRIGORCHUK, VOLODYMYR NEKRASHEVYCH, AND ZORAN ŠUNIĆ

*To the memory of Gilbert Baumslag, a great colleague and a great friend*

ABSTRACT. The survey presents developments in the theory of self-similar groups leading to applications to the study of fractal sets and graphs and their associated spectra.

## 1. INTRODUCTION

The purpose of this survey is to present some recent developments in the theory of self-similar groups and its applications to the study of fractal sets. For brevity, we will concentrate only on the following two aspects (for other aspects see [BGN03]):

- (i) Construction of new fractals by using algebraic tools and interpretation of well known fractals (the first Julia set, Sierpiński gasket, Basilica fractal, and other Julia sets of post-critically finite rational maps on the Riemann sphere) in terms of self-similar groups and their associated objects – Schreier graphs.
- (ii) Study of the spectra of the Laplacian on Schreier graphs of self-similar groups and on the associated fractals by appropriate limiting processes.

The presentation will be focused on a few representative examples for which the “entire program” (going from a self-similar group to its associated self-similar objects and calculation/description of their spectra) is successfully implemented, such as the first Grigorchuk group<sup>1</sup>  $\mathcal{G}$ , the lamplighter group  $\mathcal{L}_2$ , the 3-peg Hanoi Towers group  $\mathcal{H}$ , and the tangled odometers group  $\mathcal{T}$ , but also some examples with only partial implementation, such as the Basilica group  $\mathcal{B}$  and the iterated monodromy group  $\text{IMG}(z^2 + i)$ .

## 2. SELF-SIMILAR GROUPS AND THEIR SCHREIER GRAPHS

**2.1. Schreier graphs.** Let  $G$  be a finitely generated group, generated by a finite symmetric set  $S$  ( $S$  being symmetric means  $S = S^{-1}$ ) acting on a set  $Y$  (all actions in this survey will be left actions). The *Schreier graph* of the action of  $G$  on  $Y$  with respect to  $S$  is the oriented graph  $\Gamma(G, S, Y)$  defined as follows. The vertex set of the Schreier graph is  $Y$  and the edge set is  $S \times Y$ . For  $s \in S$  and  $y \in Y$ , the

---

2010 *Mathematics Subject Classification.* Primary 37A30; Secondary 28A80; 05C50, 20E08, 43A07.

*Key words and phrases.* self-similar groups, Schreier graphs, spectra, self-similar sets, fractals, Julia sets, amenable action, Laplacian.

The authors acknowledge partial support by the US National Science Foundation under Grants No. DMS-1105520 and DMS-1207699.

<sup>1</sup>the second and the third author insist on the use of this terminology

edge  $(s, y)$  connects  $y$  to  $sy$ . When the graph is drawn, the edge  $(s, y)$  is usually labeled just by  $s$ , since its orientation from  $y$  to  $sy$  uniquely indicates the correct “full label”  $(s, y)$ . In other words, one usually draws  $y \bullet \xrightarrow{s} \bullet sy$  instead of  $y \bullet \xrightarrow{(s,y)} \bullet sy$ .

The Schreier graph  $\Gamma(G, S, Y)$  is connected if and only if the action is transitive (some authors define Schreier graphs only in the transitive/connected case).

*Example 1.* Let  $Y = \{1, 2, 3, 4\}$  and  $D_4$  be the subgroup of the symmetric group on  $Y$  (with its usual left action) generated by  $S = \langle \sigma, \bar{\sigma}, \tau \rangle$ , where  $\sigma$  is the 4-cycle  $\sigma = (1234)$ ,  $\bar{\sigma}$  is its inverse  $\bar{\sigma} = \sigma^{-1} = (1432)$ , and  $\tau$  is the transposition  $\tau = (24)$  (note that one can interpret  $D_4$  as the dihedral group of isometries of a square with vertices 1,2,3,4;  $\sigma$  is the rotation by  $\pi/2$  and  $\tau$  the mirror symmetry with respect to the line 13). The Schreier graph  $\Gamma(D_4, S, Y)$  is drawn on the left in Figure 1.

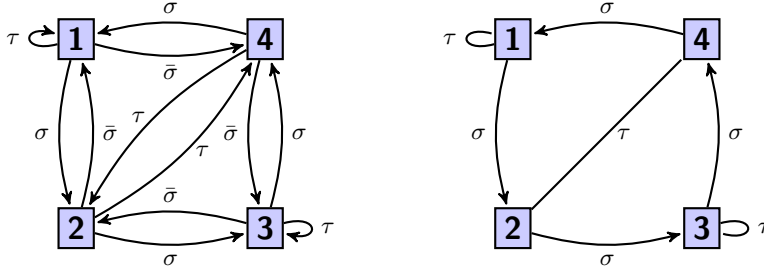

FIGURE 1. The Schreier graph  $\Gamma(D_4, S, Y)$ , and its simplified drawing

The edge  $(s, y)$  connects  $y$  to  $sy$  and the edge  $(s^{-1}, sy)$  goes in the opposite direction and connects  $sy$  to  $y$ . In order to avoid clutter in the drawings, for each pair of mutually inverse generators  $s, s^{-1} \in S$  that are not involutions, one usually chooses one of them, say  $s$ , and only draws the oriented edges labeled by  $s$ , while all edges labeled by  $s^{-1}$  are suppressed. Further, for an involution  $s \in S$  and  $y \in Y$ , only one unoriented edge is drawn between  $y$  and  $sy$  (see the graph on the right in Figure 1 and note that  $\sigma$  is not an involution, while  $\tau$  is).

**2.2. Random walk operators on Schreier graphs.** The Schreier graph  $\Gamma = \Gamma(G, S, Y)$  is regular with every vertex having both the out-degree and the in-degree equal to  $|S|$ . The *random walk* operator on  $\Gamma$  (also known as the *Markov operator*) is the operator

$$M : \ell^2(\Gamma) \rightarrow \ell^2(\Gamma)$$

$$(Mf)(y) = \frac{1}{|S|} \sum_{s \in S} f(sy).$$

where  $\ell^2(\Gamma) = \ell^2(Y)$  is the Hilbert space of square summable functions on  $Y$

$$\ell^2(\Gamma) = \ell^2(Y) = \left\{ f : Y \rightarrow \mathbb{R} \mid \sum_{y \in Y} |f(y)|^2 < \infty \right\}.$$

Thus, given a function  $f : Y \rightarrow \mathbb{R}$  on the vertex set  $Y$ , the operator  $M$  produces an updated function  $Mf : Y \rightarrow \mathbb{R}$  by replacing the value at each vertex  $y$  by the average of the  $f$ -values at the neighbors of  $y$  in the Schreier graph.

For  $x \in \mathbb{R}$ , let  $M(x)$  be the operator  $M(x) = M - xI$ . The *spectrum*  $\text{Sp}(M)$  of  $M$  is the set of values of  $x$  for which the operator  $M(x)$  from the pencil of operators  $\{M(x) \mid x \in \mathbb{R}\}$  is not invertible. Note that the operator  $M$  is bounded (in fact  $\|M\| \leq 1$ ) and, since  $S$  is symmetric, it is self-adjoint. Therefore its spectrum is a closed subset of the interval  $[-1, 1]$ . When  $Y$  is finite, the spectrum  $\text{Sp}(M)$  is just the set of eigenvalues of the operator  $M$ , but in general the spectrum only contains the set of eigenvalues of  $M$ . Recall that  $\lambda$  is an *eigenvalue* of  $M$  if and only if  $Mf = \lambda f$ , for some nonzero function  $f \in \ell^2(\Gamma)$ ; such a nonzero function is called an *eigenfunction* of  $M$ .

Let  $G = \langle S \rangle$  act on two sets  $Y$  and  $\tilde{Y}$  and  $\delta : \tilde{Y} \rightarrow Y$  be a surjective  $G$ -equivariant map, that is, a surjective function  $\delta$  such that  $g\delta(\tilde{y}) = \delta(g\tilde{y})$ , for  $g \in G$  and  $\tilde{y} \in \tilde{Y}$  (equivalently,  $s\delta(\tilde{y}) = \delta(s\tilde{y})$ , for  $s \in S$  and  $\tilde{y} \in \tilde{Y}$ ). On the level of Schreier graphs  $\delta$  induces a surjective graph homomorphism from  $\Gamma_{\tilde{Y}} = \Gamma(G, S, \tilde{Y})$  to  $\Gamma_Y = \Gamma(G, S, Y)$  preserving edge labels and sending the edge  $\tilde{y} \xrightarrow{s} s\tilde{y}$  to the edge  $\delta(\tilde{y}) \xrightarrow{s} s\delta(\tilde{y})$ . We say that  $\Gamma_{\tilde{Y}}$  is a *covering* of  $\Gamma_Y$  and  $\delta$  is a *covering map*.

Assume that both  $\tilde{Y}$  and  $Y$  are finite. For every function  $f \in \ell^2(\Gamma_Y)$ , define the *lift*  $\tilde{f} \in \ell^2(\Gamma_{\tilde{Y}})$  by  $\tilde{f}(\tilde{y}) = f(\delta(\tilde{y}))$ , for  $\tilde{y} \in \tilde{Y}$ . For all  $f \in \ell^2(\Gamma_Y)$ , we have

$$(M_{\tilde{Y}}\tilde{f})(\tilde{y}) = (M_Y f)(\delta(\tilde{y})).$$

If  $f$  is an eigenfunction of  $M_Y$  with eigenvalue  $\lambda$ , then  $\tilde{f}$  is an eigenfunction of  $M_{\tilde{Y}}$  with the same eigenvalue. Therefore, whenever there exists a surjective  $G$ -equivariant map  $\delta : \tilde{Y} \rightarrow Y$  between two finite sets  $\tilde{Y}$  and  $Y$ , the spectrum of  $M_Y$  is included in the spectrum of  $M_{\tilde{Y}}$ , that is,  $\text{Sp}(M_Y) \subseteq \text{Sp}(M_{\tilde{Y}})$ .

Let  $\{Y_n\}_{n=0}^\infty$  be a sequence of finite  $G$ -sets (sets with a  $G$ -action defined on them),  $\{\delta_n : Y_{n+1} \rightarrow Y_n\}_{n=0}^\infty$  a sequence of surjective  $G$ -equivariant maps,  $Y$  be a  $G$ -set, and  $\{\tilde{\delta}_n : Y \rightarrow Y_n\}_{n=0}^\infty$  a sequence of surjective  $G$ -equivariant maps such that  $\delta_n\tilde{\delta}_{n+1} = \tilde{\delta}_n$ , for  $n \geq 0$ . Denote  $\Gamma_n = \Gamma(G, S, Y_n)$ ,  $\Gamma = \Gamma(G, S, Y)$ , and the corresponding random walk operators by  $M_n$  and  $M$ , respectively. The sequences of equivariant maps  $\{\delta_n\}$  and  $\{\tilde{\delta}_n\}$  induce graph coverings between the corresponding Schreier graphs such that the following diagram commutes

$$(2.1) \quad \begin{array}{ccccccc} \Gamma_0 & \xleftarrow{\delta_0} & \Gamma_1 & \xleftarrow{\delta_1} & \Gamma_2 & \xleftarrow{\delta_2} & \dots \\ \tilde{\delta}_0 \uparrow & & \tilde{\delta}_1 \nearrow & & \tilde{\delta}_2 \nearrow & & \dots \\ \Gamma & & & & & & \end{array}$$

and we obtain an increasing sequence  $\{\text{Sp}(M_n)\}_{n=0}^\infty$  of finite sets, each consisting of the eigenvalues of  $M_n$ . We are interested in situations in which this sequence is sufficient to determine the spectrum of  $M$  in the sense that

$$\overline{\bigcup_{n=0}^\infty \text{Sp}(M_n)} = \text{Sp}(M).$$

*Example 2.* This example is relatively straightforward, but it illustrates the setup we introduced above. Consider the infinite dihedral group  $D_\infty = \langle a, b \rangle$ , generated

by two involutions  $a$  and  $b$ . We may think of it as the group of isometries of the set of integer points on the real line, with the action of  $a$  and  $b$  given by  $a(n) = 1 - n$  and  $b(n) = -n$ . Let  $Y = \mathbb{Z}$  and  $\Gamma$  be the Schreier graph  $\Gamma = \Gamma(D_\infty, S, Y)$ , drawn in the bottom row in Figure 2. For  $n \geq 0$ , let  $Y_n = \{0, \pm 1, \dots, \pm 2^{n-1} - 1, 2^{n-1}\}$ . Note that  $Y_n$  is a set of unique representatives of the residue classes modulo  $2^n$ , for  $n \geq 0$ . Thus we may think of  $Y_n$  as  $\mathbb{Z}/2^n\mathbb{Z}$ . The action of  $D_\infty$  on  $\mathbb{Z}$  induces a well defined action on the set of residue classes  $\mathbb{Z}/2^n\mathbb{Z}$ , for  $n \geq 0$ , and we denote  $\Gamma_n = \Gamma(D_\infty, S, Y_n)$ . The sequence of Schreier graphs  $\{\Gamma_n\}$  is indicated in the top row in Figure 2. For  $n \geq 0$ , the maps  $\delta_n : Y_{n+1} \rightarrow Y_n$  and  $\tilde{\delta}_n : Y \rightarrow Y_n$ , given by  $\delta_n(y) = \text{mod}(y, 2^n)$ , for  $y \in \mathbb{Z}/2^{n+1}\mathbb{Z}$ , and  $\tilde{\delta}_n(y) = \text{mod}(y, 2^n)$ , for  $y \in \mathbb{Z}$ , where  $\text{mod}(y, 2^n)$  is the remainder obtained when  $y$  is divided by  $2^n$ , are  $D_\infty$ -equivariant.

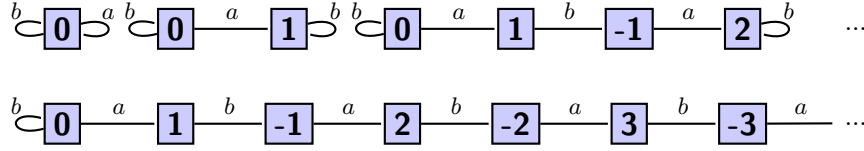

FIGURE 2. The Schreier graphs  $\Gamma_0, \Gamma_1, \Gamma_2, \dots$  (top row) and  $\Gamma$  (bottom row) for the infinite dihedral group  $D_\infty = \langle a, b \rangle$

For  $n \geq 0$ ,  $\text{Sp}(M_n)$  consists of  $2^n$  distinct eigenvalues of multiplicity 1

$$\text{Sp}(M_n) = \{1\} \cup \frac{1}{2} \bigcup_{i=0}^{n-1} f^{-i}(0) = \{1, 0\} \cup \frac{1}{2} \left\{ \underbrace{\pm \sqrt{2 \pm \sqrt{2 \pm \dots \pm \sqrt{2}}}}_{i \text{ plus-minus signs}} \mid i=1, \dots, n-1 \right\},$$

where  $f(x) = x^2 - 2$ . On the other hand, the spectrum of the doubly infinite path  $\Gamma$  is  $[-1, 1]$  and we have

$$\text{Sp}(M) = [-1, 1] = \frac{1}{2} \overline{\bigcup_{n=0}^{\infty} f^{-n}(0)} = \overline{\bigcup_{n=0}^{\infty} \text{Sp}(M_n)}.$$

**2.3. Adjacency operator on Schreier graphs and Schreier spectrum.** For the Schreier graph  $\Gamma = \Gamma(G, S, Y)$  of the action of  $G = \langle S \rangle$  on  $Y$ , the *adjacency operator* on  $\Gamma$  is the operator  $A : \ell^2(\Gamma) \rightarrow \ell^2(\Gamma)$  defined by

$$(Af)(y) = \sum_{s \in S} f(sy).$$

The random walk operator  $M = \frac{1}{|S|}A$  is the normalized version of the adjacency operator  $A$  and their spectra are just multiples of each other. Denote the spectrum of  $A$  by  $\text{Sp}(\Gamma)$  and call it the *Schreier spectrum* of  $\Gamma$ . This is the so called *adjacency spectrum*, but we want to emphasize the scope of all our considerations, namely, adjacency spectra of Schreier graphs of finitely generated groups. For the purposes of our calculations, the Schreier spectra turn out to be the most convenient, but it is easy to switch to their Markovian or Laplacian versions when needed (the *Laplacian* operator is the operator  $L = I - M$ , where  $I$  is the identity operator).

**2.4. Rooted regular trees and self-similar groups.** We introduce the class of self-similar groups acting on regular rooted trees, providing a framework for examples like Example 2, and a source of other examples.

Let  $X$  be a finite set, usually called the *alphabet*, of size  $k$ . The set of all finite words over  $X$  is denoted by  $X^*$ . The set  $X^*$  can be naturally equipped with the structure of a *rooted  $k$ -regular tree* as follows. The vertices of the tree are the words in  $X^*$ , the *root* is the empty word  $\epsilon$ , the *level  $n$*  is the set  $X^n$  of words of length  $n$  over  $X$ , and the children of each vertex  $u \in X^*$  are the  $k$  vertices of the form  $ux$ , for  $x \in X$ . We use  $X^*$  to denote the set of finite words over  $X$ , the set of vertices of the rooted tree we just described, as well as the tree itself.

The group  $\text{Aut}(X^*)$  of all automorphisms of the rooted  $k$ -regular tree  $X^*$  preserves the root and all levels of the tree. Every automorphism  $g \in \text{Aut}(X^*)$  induces a permutation  $\alpha_g$  of  $X$ , defined by  $\alpha_g(x) = g(x)$ , called the *root permutation* of  $g$ . It represents the action of  $g$  at the first letter in each word. For every automorphism  $g \in \text{Aut}(X^*)$  and every vertex  $u \in X^*$ , there exists a unique tree automorphism of  $X^*$ , denoted by  $g_u$ , such that, for all words  $w \in X^*$ ,

$$g(uw) = g(u)g_u(w).$$

The automorphism  $g_u$  is called the *section* of  $g$  at  $u$ . It represents the action of  $g$  on the tails of words that start with  $u$ . Every automorphism  $g$  is uniquely determined by its root permutation  $\alpha_g$  and the  $k$  sections at the first level  $g_x$ , for  $x \in X$ . Indeed, for every  $x \in X$  and  $w \in X^*$  we have

$$(2.2) \quad g(xw) = \alpha_g(x)g_x(w).$$

When  $X = \{0, 1, \dots, k-1\}$ , a succinct representation, called *wreath recursion*, of the automorphism  $g \in \text{Aut}(X^*)$ , describing its root permutation and its first level sections is given by

$$(2.3) \quad g = \alpha_g(g_0, g_1, \dots, g_{k-1}).$$

In addition of being short and clear, it has many other advantages, not the least of which is that it emphasizes the fact that  $\text{Aut}(X^*)$  is isomorphic to the semidirect product  $\text{Sym}(X) \ltimes (\text{Aut}(X^*))^X$ , that is, to the permutational wreath product  $\text{Sym}(X) \wr_X \text{Aut}(X^*)$ , where  $\text{Sym}(X)$  is the group of all permutations of  $X$ .

A set  $S \subseteq \text{Aut}(X^*)$  of tree automorphisms is *self-similar* if it is closed under taking sections, that is, every section of every element of  $S$  is itself in the set  $S$ . Thus, for every word  $u$ , the action of every automorphism  $s \in S$  on the tails of words that start with  $u$  looks exactly like the action of some element of  $S$ . Note that for a set  $S$  to be self-similar it is sufficient that it contains the first level sections of all of its elements. Indeed, this is because  $g_{uv} = (g_u)_v$ , for all words  $u, v \in X^*$ . A group  $G \leq \text{Aut}(X^*)$  of tree automorphisms is *self-similar* if it is self-similar as a set. Every group generated by a self-similar set is itself self-similar. This is because “sections of the product are products of sections” and “sections of the inverse are inverses of sections”. To be precise, for all tree automorphisms  $g$  and  $h$  and all words  $u \in X^*$ ,

$$(gh)_u = g_{h(u)}h_u \quad \text{and} \quad (g^{-1})_u = (g_{g^{-1}(u)})^{-1}$$

The observation that groups generated by self-similar sets are themselves self-similar enables one to easily construct many examples of finitely generated self-similar groups, as demonstrated in the next subsection.

*Remark 2.1.* It should be clarified that when we speak of a subset  $S$  or a subgroup  $G$  of  $\text{Aut}(X^*)$  as a self-similar set, we do not use this terminology in the, by now widely accepted and used, sense of Hutchinson [Hut81]. It would be more precise to say, and it is often said, that the action is self-similar, that is, the action is adapted to the self-similar nature of the rooted tree and its boundary, the Cantor set. Self-similar sets in the sense of Hutchinson do play a role here, as such sets appear as limit spaces of contracting self-similar groups (see Section 3) and our considerations lead to results on Laplacians on such self-similar sets (see Section 7).

**2.5. Automaton groups.** An *automaton*, in our context, is any finite self-similar set  $S$  of tree automorphisms. The group  $G(S) = \langle S \rangle$ , called the *automaton group* over  $S$  (or of  $S$ ), is a finitely generated self-similar group. A simple way to define an automaton is by defining the action of each of its elements recursively as in (2.2).

*Example 3.* Consider the binary rooted tree based on the alphabet  $X = \{0, 1\}^*$ . Define a finite self-similar set  $S = \{a, b\}$  of tree automorphisms recursively by

$$\begin{aligned} a(0u) &= 1a(u) & b(0u) &= 0b(u), \\ a(1u) &= 0b(u) & b(1u) &= 1a(u), \end{aligned}$$

for every word  $u \in X^*$ , and  $a(\epsilon) = b(\epsilon) = \epsilon$ . Evidently, the root permutations and the sections of  $a$  and  $b$  are given in the following table.

$$\begin{array}{c|cc} s & \alpha_s & s_0 \quad s_1 \\ \hline a & (01) & a \quad b \\ \hline b & () & b \quad a \end{array}$$

where  $()$  and  $(01)$  denote, respectively, the trivial and the nontrivial permutation of  $X = \{0, 1\}$ . Calculating the action of any element of  $S$  on any word in  $X^*$  by using the recursive definition is straightforward. For instance,

$$a(10101) = 0b(0101) = 00b(101) = 001a(01) = 0011a(1) = 00110.$$

One may think of the elements of an automaton  $S$  as the *states* of a certain type of transducer, a so-called *Mealy machine*. The recursive definition 2.2 of the action of  $s \in S$  is interpreted as follows. To calculate the action of the state  $s$  on some input word  $xu$  starting with  $x$ , the machine first rewrites  $x$  into  $\alpha_s(x)$ , changes its state to  $s_x$ , and lets the new state handle the rest of the input  $u$  in the same manner. It reads the first letter of  $u$ , rewrites it appropriately, then moves to an appropriate state, which then handles the rest of the input, and so on, until the entire input word is read. It is common to represent the automaton  $S$  by an oriented labeled graph as follows. The vertex set is the set of states  $S$ , and each pair of a state  $s \in S$  and a letter  $x \in X$  determines a directed edge from  $s$  to  $s_x$  labeled by  $x|\alpha_s(x)$  (equivalently, by  $s|x(x)$ ).

*Example 4.* Four examples of finite self-similar sets of tree automorphisms are given in Figure 3. The self-similar groups defined by these sets are the lamplighter group  $\mathcal{L}_2 = \mathbb{Z} \rtimes (\oplus_{\mathbb{Z}} \mathbb{Z}/2\mathbb{Z})$  (top left), the dihedral group  $D_\infty$  (top right), the binary odometer group  $\mathbb{Z}$  (bottom left), and the tangled odometers group  $\mathcal{T}$  (bottom right). In the last three automata the state  $e$  represents the trivial automorphism of the tree, which does not change any input word. Thus, we use  $\epsilon$  for the empty word, that is, the root of  $X^*$ ,  $()$  for the trivial permutation of  $X$ , and  $e$  for the trivial automorphism of the tree  $X^*$ . To avoid clutter, in the automaton for  $\mathbb{Z}$  we

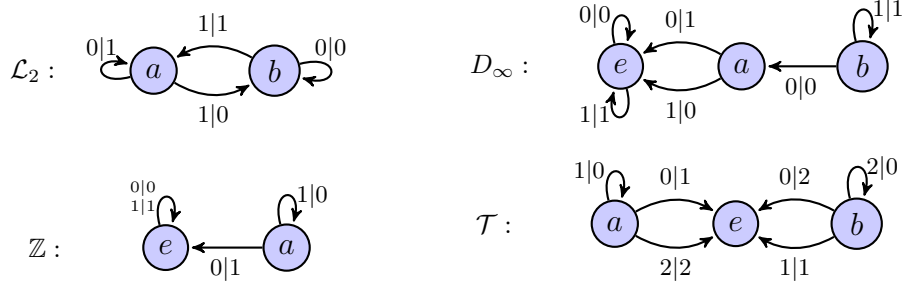

FIGURE 3. Automata defining  $\mathcal{L}_2$ ,  $D_\infty$ ,  $\mathbb{Z}$ , and  $\mathcal{T}$

used the convention that the same edge may be used with several labels, while in the automaton for  $\mathcal{T}$  the convention that the loops associated to the trivial state  $e$  are not drawn. Note that the first three automata are defined over the binary alphabet  $X = \{0, 1\}$  while the last one is defined over the ternary alphabet  $X = \{0, 1, 2\}$ , hence that group acts on the ternary rooted tree.

One can easily switch back and forth between the various representations of the given automata. For instance, the recursive definition of the action of the dihedral group  $D_\infty = \langle a, b \rangle$  on the binary rooted tree is given by

$$\begin{aligned} a(0u) &= 1u, & b(0u) &= 0a(u), \\ a(1u) &= 0u, & b(1u) &= 1b(u), \end{aligned}$$

Tabular representation of the self-similar set defining  $\mathcal{T}$  and the wreath recursion describing the same set are given on the left and on the right, respectively in

$$(2.4) \quad \begin{array}{c|cc} s & \alpha_s & s_0 \quad s_1 \quad s_2 \\ \hline a & (01) & e \quad a \quad e \\ b & (02) & e \quad e \quad b \end{array} \quad \begin{aligned} a &= (01)(e, a, e) \\ b &= (02)(e, e, b) \end{aligned}$$

It is clear that defining a finitely generated self-similar group is an easy task, in particular for automaton groups (note that not all finitely generated self-similar groups are automaton groups). One can methodically construct, one by one, all automaton groups by constructing all automata with a given number of states over an alphabet of a given size. However, it is not an easy task to recognize the group that is generated by a given automaton. A full classification of all automaton groups defined by automata with given number of states  $m$  and size of the alphabet  $k$  has been achieved only for  $m = k = 2$  [GNS00], while for the next smallest case  $m = 3$  and  $k = 2$  only a partial classification was obtained [BGK<sup>+</sup>08].

**2.6. The boundary action and the convergence  $\Gamma_n \rightarrow \Gamma$ .** Let  $G = \langle S \rangle$ , with  $S$  symmetric and finite, be a finitely generated subgroup of  $\text{Aut}(X^*)$  and, for  $n \geq 0$ , let  $\Gamma_n = \Gamma(G, S, X^n)$  be the corresponding Schreier graph of the action on level  $n$ . The map  $\delta_n : X^{n+1} \rightarrow X^n$  given by deleting the last letter in each word is  $G$ -equivariant and induces a sequence of coverings of degree  $|X|$

$$\Gamma_0 \xleftarrow{\delta_0} \Gamma_1 \xleftarrow{\delta_1} \Gamma_2 \xleftarrow{\delta_2} \dots$$

Under the covering  $\delta_n$  each of the  $|X|$  edges  $ux \bullet \xrightarrow{s} \bullet s(u)s_u(x)$  in  $\Gamma_{n+1}$ , for  $x \in X$ , is mapped to the edge  $u \bullet \xrightarrow{s} \bullet s(u)$  in  $\Gamma_n$ .

*Example 5.* The first Grigorchuk group  $\mathcal{G}$  is the self-similar group  $\mathcal{G} = \langle a, b, c, d \rangle$  generated by four involutions  $a, b, c$ , and  $d$  acting on the binary tree and given by the wreath recursion

$$a = (01)(e, e), \quad b = ()(a, c), \quad c = ()(a, d), \quad d = ()(e, b).$$

The Schreier graphs of its action on levels 0,1,2, and 3, are given in Figure 4. This group was constructed by the first author in [Gri80] as a particularly simple

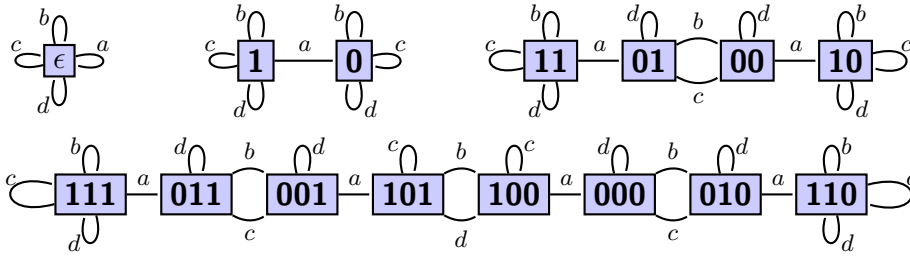

FIGURE 4. The Schreier graphs  $\Gamma_0, \Gamma_1, \Gamma_2$  (top row), and  $\Gamma_3$  (bottom row) for the first Grigorchuk group  $\mathcal{G}$

example of a finitely generated, infinite 2-group. It was the first example of a group of intermediate growth and the first example of an amenable group that is not elementary amenable [Gri84](we will get back to this aspect later).

*Example 6.* The Basilica group is the self-similar group  $\mathcal{B} = \langle a, b \rangle$  generated by the binary tree automorphisms  $a$  and  $b$  given by the wreath recursion

$$a = (01)(e, b), \quad b = ()(e, a).$$

The Schreier graphs of its action on levels 0,1,2, and 3, are given in Figure 5.

The group  $\mathcal{B}$  was first considered in [GŻ02a] and [GŻ02b] where it was proved that it is a weakly branch, torsion free group which is not sub-exponentially amenable. It was later proved by Bartholdi and Virág [BV05], using speed estimates for random walks, that this group is amenable, thus providing the first example of an amenable group that is not sub-exponentially amenable.

*Example 7.* The Hanoi Towers group is the self-similar group  $\mathcal{H} = \langle a, b, c \rangle$  generated by three involutions acting on the ternary tree given by the wreath recursion

$$a = (01)(e, e, a), \quad b = (02)(e, b, e), \quad c = (12)(c, e, e).$$

The Schreier graphs of its action on levels 0,1, and 2 are given in Figure 6.

The group  $\mathcal{H}$  was introduced in [GŠ06]. It models the well known Hanoi Towers game on three pegs in such a way that the Schreier graph  $\Gamma_n$  models the game for  $n$  disks. It is the first example of a finitely generated branch group that admits a surjective homomorphism onto the infinite dihedral group  $D_\infty$  (note that branch groups can only have virtually abelian proper quotients [Gri00], and any finitely generated branch group that admits a surjective homomorphism to an infinite virtually abelian group must map onto  $\mathbb{Z}$  or onto  $D_\infty$  [DG08]).



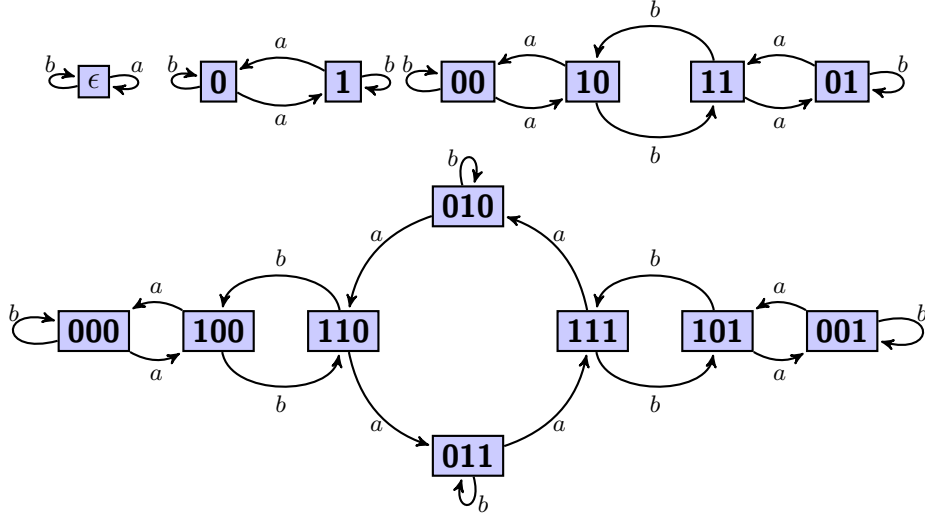

FIGURE 5. The Schreier graphs  $\Gamma_0, \Gamma_1, \Gamma_2$  (top row), and  $\Gamma_3$  (bottom row) for the Basilica group  $\mathcal{B}$

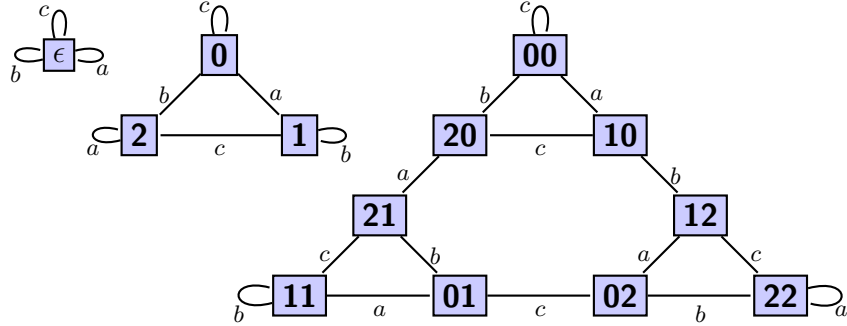

FIGURE 6. The Schreier graphs  $\Gamma_0, \Gamma_1,$  and  $\Gamma_2$  for the Hanoi Towers group  $\mathcal{H}$

The *boundary*  $X^\omega$  of the tree  $X^*$  is the space of ends of the tree  $X^*$ . More concretely, this is the space of all infinite rays

$$X^\omega = \{ x_1x_2x_3\dots \mid x_1, x_2, x_3, \dots \in X \},$$

that is, infinite paths without backtracking that start at the root. It has the structure of a metric space (in fact, ultrametric space) with metric defined by  $d(\xi, \zeta) = 1/2^{|\xi \wedge \zeta|}$ , where  $\xi \wedge \zeta$  denotes the longest common prefix of the infinite rays  $\xi$  and  $\zeta$ , and  $|\xi \wedge \zeta|$  denotes its length. Thus, the longer the common prefix the closer the rays are. The induced topology is the product topology on  $\prod_{i=1}^\infty X$ , where the finite space  $X$  is given the discrete metric, implying that, topologically, the boundary  $X^\omega$  is a Cantor set, and hence compact.

The action of any group of tree automorphisms  $G \leq \text{Aut}(X^*)$  naturally induces an action on the boundary of the tree  $X^*$ . The action of any automorphism  $g \in$

$\text{Aut}(X^*)$  on  $X^\omega$  is given by (2.2) with the understanding that  $w$  in that formula now applies to rays in  $X^\omega$ , that is, to right-infinite words over  $X$ . If, for  $n \geq 0$ , we denote by  $\tilde{\delta}_n : X^\omega \rightarrow X^n$  the map that deletes the tail of any ray beyond the first  $n$ -letters we obtain a sequence of  $G$ -equivariant maps. Thus we obtain the following diagram of  $G$ -equivariant maps.

$$(2.5) \quad \begin{array}{ccccccc} X^0 & \xleftarrow{\delta_0} & X^1 & \xleftarrow{\delta_1} & X^2 & \xleftarrow{\delta_2} & \dots \\ \uparrow \tilde{\delta}_0 & & \nearrow \tilde{\delta}_1 & & \nearrow \tilde{\delta}_2 & & \nearrow \dots \\ X^\omega & & & & & & \end{array}$$

Even if  $G = \langle S \rangle$  acts *level transitively* on the tree  $X^*$  (transitively on each level  $X^n$  of the tree) and all Schreier graphs  $\Gamma_n = \Gamma(G, S, X^n)$  are connected, the Schreier graph  $\Gamma(G, S, X^\omega)$  of the action of  $G$  on the tree boundary is not connected. Indeed, since this graph is uncountable and the group  $G$  is countable, each orbit of the action on the boundary is countable and there must be uncountably many connected components (orbits) in the graph  $\Gamma(G, S, X^\omega)$ . Picking a connected component is equivalent to picking a point on the boundary that represents it, that is, picking an infinite ray  $\xi = x_1x_2x_3 \cdots \in X^\omega$ . Choose such a ray  $\xi$  and let  $\Gamma = \Gamma_\xi = \Gamma(G, S, G\xi)$  be the Schreier graph of the boundary action of  $G$  on the orbit  $G\xi = \{g(\xi) \mid g \in G\}$ . We call the Schreier graph  $\Gamma = \Gamma_\xi$  the *orbital Schreier graph* of  $G$  at  $\xi$ . It is a countable graph of degree  $|S|$  and, since the restrictions of the maps  $\tilde{\delta}_n$ , for  $n \geq 0$ , to the orbit  $G\xi$  are  $G$ -equivariant, the induced maps  $\tilde{\delta}_n : \Gamma \rightarrow \Gamma_n$  are coverings. Therefore, we are precisely in the situation described by the diagram (2.1). Moreover, we can now state a sufficient condition under which the spectra of the sequence of finite graphs  $\{\Gamma_n\}$  approximates the spectrum of  $\Gamma$ .

**Theorem 2.2** (Bartholdi-Grigorchuk [BG00]). *Let  $G = \langle S \rangle \leq \text{Aut}(X^*)$  be a finitely generated, self-similar, level-transitive group of automorphisms of the rooted tree  $X^*$  and let  $\xi \in X^\omega$  be a point on the tree boundary. For  $n \geq 0$ , let  $\Gamma_n = \Gamma(G, S, X^n)$  be the Schreier graph of the action of  $G$  on level  $n$  of the tree and let  $\Gamma = \Gamma_\xi = \Gamma(G, S, G\xi)$  be the orbital Schreier graph of  $G$  at  $\xi$ . If the action of  $G$  on the orbit  $G\xi$  is amenable, then*

$$\overline{\bigcup_{n=0}^{\infty} \text{Sp}(\Gamma_n)} = \text{Sp}(\Gamma).$$

We recall the definition of an amenable action. The action of  $G$  on  $Y$  is *amenable* if there exists a normalized, finitely additive,  $G$ -invariant measure  $\mu$  on all subsets of  $Y$ , that is, there exists a function  $\mu : 2^Y \rightarrow [0, 1]$  such that

- (normalization)  $\mu(Y) = 1$ ,
- (finite additivity)  $\mu(A \sqcup B) = \mu(A) + \mu(B)$ , for disjoint subsets  $A, B \subseteq Y$ ,
- ( $G$ -invariance)  $\mu(A) = \mu(gA)$ , for  $g \in G$ ,  $A \subseteq Y$ .

For a finitely generated group  $G = \langle S \rangle$  (with  $S$  finite and symmetric, as usual) acting transitively on a set  $Y$ , the amenability of the action is equivalent to the amenability of the Schreier graph  $\Gamma = \Gamma(G, S, Y)$  of the action and one of the many equivalent ways to define/characterize the amenability of  $\Gamma$  is as follows. The graph  $\Gamma$  is amenable if and only if

$$\inf \left\{ \frac{|\partial F|}{|F|} \mid F \text{ finite and nonempty set of vertices of } \Gamma \right\} = 0,$$

where the *boundary*  $\partial F$  of the set  $F$  is the set of vertices in  $\Gamma$  that are not in  $F$  but have a neighbor in  $F$ , that is,  $\partial F = \{ v \in \Gamma \mid v \notin F \text{ and } sv \in F \text{ for some } s \in S \}$ .

One sufficient condition for the amenability of the graph  $\Gamma$  is obtained by looking at its growth. Let  $\Gamma$  be any connected graph of uniformly bounded degree. Choose any vertex  $v_0 \in \Gamma$  and, for  $n \geq 0$ , let  $\gamma_{v_0}(n)$  be the number of vertices in  $\Gamma$  at combinatorial distance no greater than  $n$  from  $v_0$ . If the growth of  $\gamma_{v_0}(n)$  is subexponential (that is,  $\limsup_{n \rightarrow \infty} \sqrt[n]{\gamma_{v_0}(n)} = 1$ ), then  $\Gamma$  is an amenable graph.

By definition, a group  $G$  is amenable if its left regular action on itself is amenable. In such a case, every action of  $G$  is amenable and Theorem 2.2 applies. The class of amenable groups includes all finite and all solvable groups and is closed under taking subgroups, homomorphic images, extensions, and directed unions. The smallest class of groups that contains all finite and all abelian groups and is closed under taking subgroups, homomorphic images, extensions, and directed unions is known as the class of *elementary amenable* groups. There are amenable groups that are not elementary amenable and many such examples came from the theory of self-similar groups, starting with the first Grigorchuk group  $\mathcal{G}$ . The amenability of this group was proved by showing that it has subexponential (in fact intermediate, between polynomial and exponential) growth [Gri84]. Other examples of amenable but not elementary amenable groups include Basilica group  $\mathcal{B}$  [BV05], Hanoi Towers group  $\mathcal{H}$ , tangled odometers group  $\mathcal{T}$ , and many other automaton groups. See [BKN10] and [AAV13] for useful sufficient conditions for amenability of automaton groups based on random walk considerations and the notion of activity growth introduced by Sidki [Sid00].

A large and interesting class of examples to which Theorem 2.2 applies is the class of contracting self-similar groups.

**Definition 2.3.** Let  $G \leq \text{Aut}(X^*)$  be a self-similar group of automorphisms of the rooted regular tree  $X^*$ . The group  $G$  is said to be *contracting* if there exists a finite set  $\mathcal{N} \subseteq G$  such that, for every  $g \in G$ , there exists  $n$  such that  $g_v \in \mathcal{N}$ , for all words  $v \in X^*$  of length at least  $n$ . The smallest set  $\mathcal{N}$  satisfying this property is called the *nucleus* of the group.

Since the growth of each orbital Schreier graph  $\Gamma$  of a finitely generated, self-similar, contracting group is polynomial [BG00], such a graph  $\Gamma$  is amenable and, therefore, its spectrum can be approximated by the spectra of the finite graphs in the sequence  $\{\Gamma_n\}$ , as in Theorem 2.2. Note that it is not known yet whether all finitely generated contracting groups are amenable.

### 3. ITERATED MONODROMY GROUPS

The content of this section is not necessary in order to follow the rest of the survey, but it provides excellent examples, motivation, and context for our considerations.

**3.1. Definition.** Let  $\mathcal{M}$  be a path connected and locally path connected topological space, and let  $f : \mathcal{M}_1 \rightarrow \mathcal{M}$  be a finite degree covering map, where  $\mathcal{M}_1$  is a subset of  $\mathcal{M}$ . The main examples for us are *post-critically finite complex rational functions*. Namely, a rational function  $f \in \mathbb{C}(z)$  is said to be post-critically finite if the forward orbit  $O_x = \{f^{on}(x)\}_{n \geq 1}$  of every critical point  $x$  of  $f$  (seen as a self-map of the Riemann sphere  $\widehat{\mathbb{C}}$ ) is finite. Let  $P$  be the union of the forward

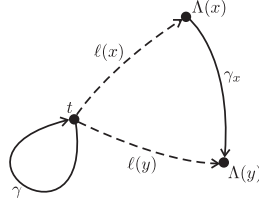
FIGURE 7. Computation of  $\text{IMG}(f)$ 

orbits  $O_x$ , for all critical points. Denote  $\mathcal{M} = \widehat{\mathbb{C}} \setminus P$  and  $\mathcal{M}_1 = f^{-1}(\mathcal{M})$ . Then  $\mathcal{M}_1 \subseteq \mathcal{M}$  and  $f : \mathcal{M}_1 \rightarrow \mathcal{M}$  is a finite degree covering map.

Let  $t \in \mathcal{M}$ , and consider the *tree of preimages*  $T_f$  whose set of vertices is the disjoint union of the sets  $f^{-n}(t)$ , where  $f^{-0}(t) = \{t\}$ . We connect every vertex  $v \in f^{-n}(t)$  to the vertex  $f(v) \in f^{-(n-1)}(t)$ . We then obtain a tree rooted at  $t$ .

If  $\gamma$  is a loop in  $\mathcal{M}$  starting and ending at  $t$  then, for every  $v \in f^{-n}(t)$ , there exists a unique path  $\gamma_v$  starting at  $v$  such that  $f^{on} \circ \gamma_v = \gamma$ . Denote by  $\gamma(v)$  the end of the path  $\gamma_v$ . Then  $v \mapsto \gamma(v)$  is an automorphism of the rooted tree  $T_f$ . We get in this way an action (called the *iterated monodromy action*) of the fundamental group  $\pi_1(\mathcal{M}, t)$  on the rooted tree  $T_f$ . The quotient of the fundamental group by the kernel of the action is called the *iterated monodromy group* of  $f$ , and is denoted  $\text{IMG}(f)$ . In other words,  $\text{IMG}(f)$  is the group of all automorphisms of  $T_f$  that are equal to a permutation of the form  $v \mapsto \gamma(v)$  for some loop  $\gamma$ .

**3.2. Computation of  $\text{IMG}(f)$ .** Let  $X$  be a finite alphabet of size  $\deg f$ , and let  $\Lambda : X \rightarrow f^{-1}(t)$  be a bijection. For every  $x \in X$ , choose a path  $\ell(x)$  starting at  $t$  and ending at  $\Lambda(x)$ . Let  $\gamma \in \pi_1(\mathcal{M}, t)$ . Denote by  $\gamma_x$  the path starting at  $\Lambda(x)$  such that  $f \circ \gamma_x = \gamma$ , and let  $\Lambda(y)$  be the end of  $\gamma_x$ . Then the paths  $\ell(x)$ ,  $\gamma_x$ , and  $\ell(y)^{-1}$  form a loop, which we will denote  $\gamma|_x$  (see Figure 7).

**Proposition 3.1** (Nekrashevych [Nek05]). *Let  $X$  be an alphabet in a bijection  $\Lambda : X \rightarrow f^{-1}(t)$ . Let  $\ell(x)$ ,  $y$ , and  $\gamma|_x$  be as above. Then  $\Lambda$  can be extended to an isomorphism of rooted trees  $\Lambda : X^* \rightarrow T_f$  that conjugates the iterated monodromy action of  $\pi_1(\mathcal{M}, t)$  on  $T_f$  with the action on  $X^*$  defined by the recursive rule:*

$$\gamma(xv) = y\gamma|_x(v).$$

*In particular,  $\text{IMG}(f)$  is a self-similar group.*

The self-similar action of  $\text{IMG}(f)$  on  $X^*$  described in the last proposition is called the *standard action*. It depends on the choice of the connecting paths  $\ell(x)$ , for  $x \in X$ , and the bijection  $\Lambda : X \rightarrow f^{-1}(t)$ . Changing the connecting paths amounts to post-composition of the wreath recursion with an inner automorphism of the wreath product  $\text{Sym}(X) \wr_X \text{IMG}(f)$ .

*Example 8* (Basilica group  $\mathcal{B} = \text{IMG}(z^2 - 1)$ ). The polynomial  $z^2 - 1$  is post-critically finite with  $P = \{0, -1, \infty\}$ . The fundamental group of  $\widehat{\mathbb{C}} \setminus P$  is generated by two loops  $a, b$  going around the punctures 0 and  $-1$ , respectively. With an appropriate choice of the connecting paths (see [Nek05, Subsection 5.2.2.]), the wreath recursion for  $\text{IMG}(z^2 - 1)$  is exactly the same as the one in Example 6. Thus,  $\mathcal{B} = \text{IMG}(z^2 - 1)$ .

*Example 9* (Tangled odometers group  $\mathcal{T} = \text{IMG}\left(-\frac{z^3}{2} + \frac{3z}{2}\right)$ ). The polynomial  $f(z) = -z^3/2 + 3z/2$  has three critical points: 1,  $-1$ , and  $\infty$ . All of them are fixed points of  $f$ , hence  $P = \{1, -1, \infty\}$ , and the fundamental group of is generated by loops around 1 and  $-1$ . The corresponding iterated monodromy group is defined by the wreath recursion (2.4), and this is the tangled odometers group  $\mathcal{T}$ .

*Example 10* (Hanoi Towers group  $\mathcal{H} = \text{IMG}\left(z^2 - \frac{16}{27z}\right)$ ). The iterated monodromy group of the rational function  $z^2 - 16/(27z)$  is conjugate in  $\text{Aut}(X^*)$  to the Hanoi Towers group  $\mathcal{H}$  (see [GŠ07]).

*Example 11* (Dihedral group  $D_\infty = \text{IMG}(z^2 - 2)$  and binary odometer group  $\mathbb{Z} = \text{IMG}(z^2)$ ). The iterated monodromy group of the polynomial  $z^2 - 2$  is the dihedral group  $D_\infty$  and of the polynomial  $z^2$  is the binary odometer group  $\mathbb{Z}$  (infinite cyclic group) from Example 4.

**3.3. Limit spaces of contracting self-similar groups.** Suppose that  $G$  is a contracting self-similar group. Let  $X^{-\omega}$  be the space of all left-infinite sequences  $\dots x_2 x_1$  of elements of  $X$  with the direct product topology. We say that two sequences  $\dots x_2 x_1$  and  $\dots y_2 y_1$  in  $X^{-\omega}$  are *asymptotically equivalent* if there exists a sequence  $\{g_k\}_{k=1}^\infty$  of elements in  $G$ , taking a finite set of values, such that  $g_k(x_k \dots x_1) = y_k \dots y_1$ , for all  $k \geq 1$ . It is easy to see that this is an equivalence relation. The *limit space* of  $G$  is the quotient of the topological space  $X^{-\omega}$  by the asymptotic equivalence relation. It is always a metrizable space of finite topological dimension (if  $G$  is contracting). Note that the asymptotic equivalence relation is invariant with respect to the shift  $\dots x_2 x_1 \mapsto \dots x_3 x_2$ . Consequently, the shift induces a continuous self-map on the limit space of  $G$ . The obtained map is called the *limit dynamical system* of the group  $G$ .

**Theorem 3.2** (Nekrashevych [Nek05]). *Suppose that  $f$  is a post-critically finite complex rational function. Then  $\text{IMG}(f)$  is a contracting self-similar group with respect to any standard action. The limit dynamical system of  $\text{IMG}(f)$  is topologically conjugate to the restriction of  $f$  onto its Julia set.*

The *Julia set* of a complex rational function  $f$  can be defined as the closure of the set of points  $c$  such that there exists  $n$  such that  $f^n(c) = c$  and  $\left|\frac{d}{dz}f^n(z)\right|_{z=c} > 1$ . The Julia sets of  $z \mapsto z^2 - 1$ ,  $z \mapsto -\frac{z^3}{2} + \frac{3z}{2}$ , and  $z \mapsto z^2 - \frac{16}{27z}$  are given in Figure 8. Theorem 3.2 provides context and explanation for the striking similarity between the structure of the Schreier graphs of the Basilica group in Figure 5 and the Basilica fractal in Figure 8, as well as between the structure of the Schreier graphs of the Hanoi Towers group in Figure 6 and the Sierpiński gasket in Figure 8.

4. RELATION TO OTHER OPERATORS AND SPECTRA

**4.1. Hecke type operators.** Let  $G = \langle S \rangle$ , with  $S$  finite and symmetric, be a finitely generated group and  $\lambda : G \rightarrow \mathcal{U}(\mathcal{W})$  a unitary representation of  $G$  on a Hilbert space  $\mathcal{W}$ . To each element  $\mathbf{m} = \sum_{i=1}^n \alpha_i \cdot g_i$  of the group algebra  $\mathbb{C}[G]$  one can associate the operator

$$\lambda(\mathbf{m}) = \sum_{i=1}^n \alpha_i \lambda(g_i).$$

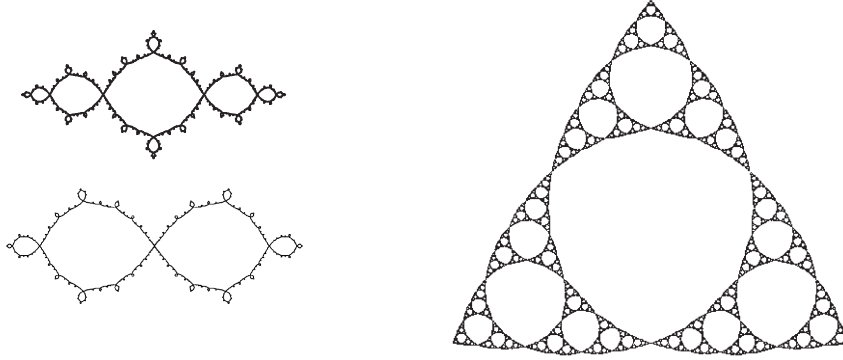

FIGURE 8. Julia set of  $z \mapsto z^2 - 1$  (top left),  $z \mapsto -\frac{z^3}{2} + \frac{3z}{2}$  (bottom left), and  $z \mapsto z^2 - \frac{16}{27z}$  (right)

In particular, we consider the *Hecke type operator*  $H_\lambda$  on the Hilbert space  $\mathcal{W}$  associated to the group algebra element  $\mathfrak{h} = \frac{1}{|S|} \sum_{s \in S} s$  and given by

$$H_\lambda = \frac{1}{|S|} \sum_{s \in S} \lambda(s).$$

**4.2. Koopman representation and Hecke type operators.** Let  $G$  be a countable group acting on a measure space  $(Y, \mu)$  by measure-preserving transformations. The *Koopman representation*  $\pi$  is the unitary representation of  $G$  on the Hilbert space  $L^2(Y, \mu)$  given by

$$(\pi(g)f)(y) = f(g^{-1}y)$$

for  $f \in L^2(Y, \mu)$  and  $y \in Y$ .

Let  $G = \langle S \rangle \leq \text{Aut}(X^*)$  be a finitely generated, self-similar, level-transitive group of automorphisms of the rooted regular tree  $X^*$ . Note that the boundary  $X^\omega$ , which has the structure of a Cantor set  $\prod_{i=1}^{\infty} X$ , is a measure space with respect to the product of uniform measures on  $X$  (for the cylindrical set  $uX^*$ , we have  $\mu(uX^*) = \frac{1}{|X|^{|u|}}$ ). The group  $G$  acts on  $X^\omega$  by measure-preserving transformations and we may consider the Koopman representation  $\pi$  of  $G$  on  $L^2(X^\omega, \mu)$  and the associated Hecke type operator  $H_\pi$  on  $L^2(X^\omega, \mu)$ , given by

$$H_\pi = \frac{1}{|S|} \sum_{s \in S} \pi(s).$$

For every  $n \geq 0$ , we may also consider the representation  $\pi_n$  on  $L^2(X^n, \mu_n)$  on the finite probability space  $X^n$  with uniform probability measure  $\mu_n$ , corresponding to level  $n$  of the tree, and the associated Hecke type operator

$$H_{\pi_n} = \frac{1}{|S|} \sum_{s \in S} \pi_n(s).$$

Denote  $\text{Sp}(H_\pi) = \text{Sp}(\pi)$  and  $\text{Sp}(H_{\pi_n}) = \text{Sp}(\pi_n)$ , for  $n \geq 0$ .

**Theorem 4.1** (Bartholdi-Grigorchuk [BG00]). *Let  $G$  be a finitely generated, self-similar, level-transitive group of automorphisms of the rooted regular tree  $X^*$ . Then*

$$\mathrm{Sp}(\pi) = \overline{\bigcup_{n=0}^{\infty} \mathrm{Sp}(\pi_n)}.$$

Note that, unlike in Theorem 2.2, no additional requirements (such as amenability of the action) are needed in the last result.

**4.3. Quasi-regular representations and Hecke type operators.** It is well known that every transitive left action of a group  $G$  on any set  $Y$  is equivalent to the action of  $G$  on the left coset space  $G/P$ , where  $P = \mathrm{Stab}_G(y)$  is the stabilizer of the point  $y \in Y$  (since the action is transitive this point may be chosen arbitrarily). In fact, Schreier graphs originate as the graphs of the action of groups on their coset spaces.

For a countable group  $G$  and any subgroup  $P \leq G$ , the *quasi-regular representation* is the unitary representation  $\rho_{G/P}$  of  $G$  on the Hilbert space  $\ell^2(G/P)$  given by

$$(\rho_{G/P}(g)f)(hP) = f(g^{-1}hP),$$

for  $f \in \ell^2(G/P)$  and  $h \in G$ . When  $P$  is the trivial group we obtain the *left regular representation*  $\rho_G$  defined by

$$(\rho_G(g)f)(h) = f(g^{-1}h),$$

for  $f \in \ell^2(G)$  and  $h \in G$ .

Let  $G = \langle S \rangle \leq \mathrm{Aut}(X^*)$  be a finitely generated, self-similar, level-transitive group of automorphisms of the rooted regular tree  $X^*$  and let  $\xi = x_1x_2x_3\dots$  be a point on the boundary  $X^\omega$ . For  $n \geq 0$ , the point  $x_1x_2\dots x_n$  is the unique point at level  $n$  on the ray  $\xi$ . Let

$$P_n = \mathrm{Stab}_G(x_1x_2\dots x_n), \text{ for } n \geq 0, \text{ and} \\ P = \mathrm{Stab}_G(\xi).$$

Note that  $\bigcap_{n=0}^{\infty} P_n = P_\xi$ .

Denote by  $\rho_n$  the quasi-regular representation  $\rho_{G/P_n}$  corresponding to the subgroup  $P_n$  (thus, to the action of  $G$  on level  $n$  of the tree) and by  $\rho_\xi$  the representation  $\rho_{G/P_\xi}$ . We consider the Hecke type operator  $H_{\rho_\xi}$  on  $\ell^2(G/P_\xi)$

$$H_{\rho_\xi} = \frac{1}{|S|} \sum_{s \in S} \rho_\xi(s)$$

and, for  $n \geq 0$ , the Hecke type operator

$$H_{\rho_n} = \frac{1}{|S|} \sum_{s \in S} \rho_n(s).$$

Denote  $\mathrm{Sp}(H_{\rho_\xi}) = \mathrm{Sp}(\rho_\xi)$  and  $\mathrm{Sp}(H_{\rho_n}) = \mathrm{Sp}(\rho_n)$ , for  $n \geq 0$ .

The following result extends Theorem 2.2 and compares the Schreier spectrum to the spectrum of the Hecke type operators  $H_\pi$  and  $H_{\rho_\xi}$  associated to the Koopman representation  $\pi$  and the quasi-regular representation  $\rho_\xi$ , respectively.

**Theorem 4.2** (Bartholdi-Grigorchuk [BG00]). (a) Let  $G = \langle S \rangle \leq \text{Aut}(X^*)$  be a finitely generated, self-similar, level-transitive group of automorphisms of the rooted regular tree  $X^*$  and let  $\xi \in X^\omega$ . Then, for  $n \geq 0$ ,

$$\frac{1}{|S|} \text{Sp}(\Gamma_n) = \text{Sp}(\rho_n) = \text{Sp}(\pi_n)$$

and

$$\frac{1}{|S|} \text{Sp}(\Gamma_\xi) = \text{Sp}(\rho_\xi) \subseteq \text{Sp}(\pi).$$

(b) If the action of  $G$  on the orbit  $G\xi$  is amenable, then

$$\frac{1}{|S|} \overline{\bigcup_{n=0}^{\infty} \text{Sp}(\Gamma_n)} = \frac{1}{|S|} \text{Sp}(\Gamma_\xi) = \text{Sp}(\rho_\xi) = \text{Sp}(\pi).$$

(c) If the group  $P_\xi$  is amenable, then

$$\frac{1}{|S|} \text{Sp}(\Gamma_\xi) = \text{Sp}(\rho_\xi) \subseteq \text{Sp}(\rho_G),$$

where  $\rho_G$  is the left-regular representation of  $G$  (and  $\text{Sp}(\rho_G)$  is the spectrum of the corresponding Hecke type operator  $H_{\rho_G}$ ).

By part (b) in the last result, if the group  $G$  is amenable, then all orbital Schreier graphs have the same spectrum (there is no dependence on the choice of the point  $\xi \in X^\omega$ , since the representation  $\pi$  does not depend on it). More generally, if all orbital Schreier graphs  $\Gamma_\xi$ , for  $\xi \in X^\omega$  are amenable, as it happens in the case of contracting self-similar groups, then they all have the same spectrum. Examples of nonamenable groups with amenable orbital Schreier graphs  $\Gamma_\xi$  were provided in [GN05] (thus, part (b) applies to some nonamenable groups).

We point out that part (b) is mistakenly stated in [BG00] under the assumption that either the action of  $G$  on the orbit  $G\xi$  is amenable or  $P_\xi$  is amenable. The assumption that  $P_\xi$  is amenable only applies in part (c), and this part of Theorem 4.2 follows from [BG00, Proposition 3.5].

## 5. METHOD OF COMPUTATION

The method of computation of spectra, introduced in [BG00] and further implemented and refined in [GŽ01, GŠ08, GN07, GNŠ14] is based on the use of invariant sets of multidimensional rational maps and the Schur complement. We will present the approach in the next two subsections, one addressing the global picture, and the other the details.

**5.1. A global preview of the method.** Let  $A$  be an operator for which we would like to calculate the spectrum. Include  $A$  and the entire pencil  $\{A(x) \mid x \in \mathbb{C}\}$  with  $A(x) = A - xI$  into a multidimensional pencil of operators

$$\{ A^{(d)}(x_1, x_2, \dots, x_d) \mid x_1, \dots, x_d \in \mathbb{C} \}$$

such that

$$A(x) = A^{(d)}(x, x_2^{(0)}, x_3^{(0)}, \dots, x_d^{(0)}),$$

for some particular values  $x_2^{(0)}, x_3^{(0)}, \dots, x_d^{(0)} \in \mathbb{C}$ . Define the joint spectrum by

$$\text{Sp}(A^{(d)}) = \left\{ (x_1, x_2, \dots, x_d) \in \mathbb{C}^d \mid A^{(d)}(x_1, x_2, \dots, x_d) \text{ is not invertible} \right\}.$$



Then

$$\mathrm{Sp}(A) = \mathrm{Sp}(A^{(d)}) \cap \ell,$$

where  $\ell$  is the line

$$\ell = \left\{ (x_1, x_2, \dots, x_d) \in \mathbb{C}^d \mid x_2 = x_2^{(0)}, x_3 = x_3^{(0)}, \dots, x_d = x_d^{(0)} \right\}$$

in the  $d$ -dimensional space  $\mathbb{C}^d$ .

In the case of a self-adjoint operator  $A$ , which is always our case, we can use the field  $\mathbb{R}$  instead of  $\mathbb{C}$ .

The problem naturally splits into three steps:

- (i) Determine a suitable higher-dimensional pencil containing  $\{A(x) \mid x \in \mathbb{R}\}$ .
- (ii) Determine the joint spectrum  $\mathrm{Sp}(A^{(d)})$ .
- (iii) Determine the intersection  $\mathrm{Sp}(A) = \mathrm{Sp}(A^{(d)}) \cap \ell$ .

In the examples that were successfully treated by this approach, the joint spectrum  $\mathrm{Sp}(A^{(d)})$  is an invariant set under some rational  $d$ -dimensional map  $F : \mathbb{R}^d \rightarrow \mathbb{R}^d$ . Thus, in practice, the step (ii) is understood as

- (ii)' Determine the joint spectrum  $\mathrm{Sp}(A^{(d)})$  as an  $F$ -invariant set for a suitable  $d$ -dimensional rational map  $F : \mathbb{R}^d \rightarrow \mathbb{R}^d$ .

It may be somewhat counterintuitive why one should “increase the dimension of the problem in order to solve it”, but the method has worked well in situations where direct approaches have failed. What happens is that the joint spectrum in  $\mathbb{R}^d$ , corresponding to the  $d$ -fold pencil of operators, is sometimes well behaved and easier to describe than the spectrum of the original 1-fold pencil. On the other hand, even when appropriate  $A^{(d)}$  and  $F$  are found, the structure of the  $F$ -invariant set can be quite complicated and have the shape of a “strange attractor”.

**5.2. More details.** Let  $G = \langle S \rangle$  be an automaton group generated by the elements of the finite and symmetric self-similar set  $S$ . For  $n \geq 0$ , the representations  $\pi_n$  and  $\rho_n$  are equivalent and may be viewed as representations on the  $|X|^n$ -dimensional vector space  $\ell^2(X^n)$ . The  $|X|^n \times |X|^n$  adjacency matrix  $A_n$  (the rows and the columns are indexed by the words over  $X$  of length  $n$ ) of  $\Gamma_n$  is given by

$$A_n = \sum_{s \in S} \pi_n(s).$$

The  $|X|^n \times |X|^n$  matrix  $\pi_n(s)$  is given recursively, for  $n > 0$ , by blocks of size  $|X|^{n-1} \times |X|^{n-1}$

$$(5.1) \quad \pi_n(s) = [B_{y,x}(s)]_{y,x \in X}$$

corresponding to the decomposition

$$\ell^2(X^n) = \bigoplus_{x \in X} \ell^2(xX^{n-1}),$$

and the block  $B_{y,x}(s)$  is given by

$$B_{yx}(s) = \begin{cases} \pi_{n-1}(s_x), & s(x) = y \\ 0, & \text{otherwise} \end{cases}$$

For  $n = 0$ , the space  $\ell^2(X^0)$  corresponding to the root of the tree is 1-dimensional and  $\pi_0(s)$  is the  $1 \times 1$  identity matrix  $\pi_0(s) = [1]$ . We call (5.1) the *matrix wreath*

recursion of  $S$  (it directly corresponds to the wreath recursion that defines the generators  $s \in S$ ).

From now on, we use the notation  $s_n = \pi_n(s)$ .

*Example 12.* For the first Grigorchuk group  $\mathcal{G}$  the matrix wreath recursion gives

$$a_0 = b_0 = c_0 = d_0 = [1]$$

and for  $n > 0$ ,

$$a_n = \begin{bmatrix} 0 & 1 \\ 1 & 0 \end{bmatrix} \quad b_n = \begin{bmatrix} a_{n-1} & 0 \\ 0 & c_{n-1} \end{bmatrix} \quad c_n = \begin{bmatrix} a_{n-1} & 0 \\ 0 & d_{n-1} \end{bmatrix} \quad d_n = \begin{bmatrix} 1 & 0 \\ 0 & b_{n-1} \end{bmatrix},$$

where, in each case, 0 and 1 denote the zero matrix and the identity matrix, respectively, of appropriate size ( $2^{n-1} \times 2^{n-1}$ ). Therefore,  $A_0 = [4]$  and, for  $n > 0$ ,

$$A_n = \begin{bmatrix} 2a_{n-1} + 1 & 1 \\ 1 & b_{n-1} + c_{n-1} + d_{n-1} \end{bmatrix}.$$

*Example 13.* For the tangled odometers group  $\mathcal{T}$  the matrix wreath recursion gives

$$a_0 = b_0 = a_0^{-1} = b_0^{-1} = [1]$$

and for  $n \geq 0$ ,

$$\begin{aligned} a_{n+1} &= \begin{bmatrix} 0 & a_n & 0 \\ 1 & 0 & 0 \\ 0 & 0 & 1 \end{bmatrix} & (a^{-1})_{n+1} &= \begin{bmatrix} 0 & 1 & 0 \\ (a^{-1})_n & 0 & 0 \\ 0 & 0 & 1 \end{bmatrix} \\ b_{n+1} &= \begin{bmatrix} 0 & 0 & b_{n-1} \\ 0 & 1 & 0 \\ 1 & 0 & 0 \end{bmatrix} & (b^{-1})_{n+1} &= \begin{bmatrix} 0 & 0 & 1 \\ 0 & 1 & 0 \\ (b^{-1})_n & 0 & 0 \end{bmatrix}. \end{aligned}$$

Therefore,  $A_0 = [4]$  and, for  $n \geq 0$ ,

$$A_{n+1} = \begin{bmatrix} 0 & 1 + a_n & 1 + b_n \\ 1 + (a^{-1})_n & 2 & 0 \\ 1 + (b^{-1})_n & 0 & 2 \end{bmatrix}.$$

Once the recursive definition of the adjacency operator  $A_n$  is established we consider the matrix

$$A_n(x) = A_n - xI = \left( \sum_{s \in S} s_n \right) - xI,$$

and more generally, a matrix of the form

$$A_n^{(d)}(x_1, \dots, x_d) = A_n - x_1 I - \left( \sum_{i=2}^d x_i \cdot g_i \right) = \left( \sum_{s \in S} s_n \right) - x_1 I - \left( \sum_{i=2}^d x_i \cdot g_i \right),$$

for some auxiliary operators  $g_2, \dots, g_d$ . There is no known general approach how to choose appropriate auxiliary operators. In practice, one needs to come up with good choices that make the subsequent calculations feasible.

We then calculate, by using elementary column and row transformations and the Schur complement, the determinant of  $A_n^{(d)}$  in terms of the determinant of  $A_{n-1}^{(d)}$  and obtain a recursive expression of the form

$$(5.2) \quad \det(A_n^{(d)}(x_1, \dots, x_d)) = P_n(x_1, \dots, x_d) \det(A_{n-1}^{(d)}(F(x_1, \dots, x_d))),$$

where  $P_n(x_1, \dots, x_d)$  is a polynomial function and  $F : \mathbb{R}^d \rightarrow \mathbb{R}^d$  is a rational function in the variables  $x_1, \dots, x_d$ . Clearly, if the point  $(x'_1, \dots, x'_d)$  is in the zero set of  $\det(A_{n-1}^{(d)}(x_1, \dots, x_d))$ , then any point in  $F^{-1}(x'_1, \dots, x'_d)$  is in the zero set of  $\det(A_n^{(d)}(x_1, \dots, x_d))$ . Thus, describing the joint spectrum through iterations of the recursion (5.2) leads to iterations of the rational map  $F$ .

Understanding the structure of the zero sets of  $\det(A_n^{(d)}(x_1, \dots, x_d))$ , for  $n \geq 0$ , and relating them to the zero sets of  $\det(A_n(x))$  is accomplished, in the situations when we are able to resolve this problem, by finding a function  $\psi : \mathbb{R}^d \rightarrow \mathbb{R}$  and a polynomial function  $f : \mathbb{R} \rightarrow \mathbb{R}$  such that

$$\psi(F(x_1, \dots, x_d)) = f(\psi(x_1, \dots, x_d)),$$

that is, by finding a semi-conjugacy from the  $d$ -dimensional rational function  $F$  to a polynomial function  $f$  in a single variable. Since we have

$$\psi(F^{om}(x_1, \dots, x_d)) = f^{om}(\psi(x_1, \dots, x_d)),$$

the iterations of  $F$  are related to the iterations of  $f$  and then the desired spectrum is described through the iterations of the latter.

## 6. CONCRETE EXAMPLES AND COMPUTATION RESULTS

In this section we present several concrete examples of calculations of spectra based on the method suggested in the Section 5. All groups in this section are amenable. By Theorem 4.2, the choice of the point on the boundary is irrelevant for the Schreier spectrum and this is why no such choice is discussed in these examples.

One of the examples, the Hanoi Towers group  $\mathcal{H}$ , leads to results on the Sierpiński gasket. The spectrum of Sierpiński gasket goes back to the work of the physicists Rammal and Toulouse [RT82]. It was turned into a mathematical framework by Fukushima and Shima [FS92]. Note that, in these works, the Sierpiński gasket was approximated by a sequence of graphs that are 4-regular (with the exception of the three corner vertices, which have degree 2), while our approach yields an approximation through a different, but related, sequence of 3-regular graphs. A method for spectra calculations in more general cases, called *spectral decimation*, was developed by Kumagai, Malozemov, Shima, Teplyaev, Strichartz and others [Kum93, Mal94, Shi96, Tep98, MT03, Str06]. Connections with Julia sets are well-known, as for instance given by Teplyaev [Tep04].

**6.1. The first Grigorchuk group  $\mathcal{G}$ .** As was already mentioned, the method sketched above was introduced in [BG00] in order to compute the spectrum of the sequence of Schreier graphs  $\{\Gamma_n\}$  and the boundary Schreier graph  $\Gamma$  for the case of the first Grigorchuk group  $\mathcal{G}$ , as well as several other examples, including the Gupta-Sidki 3-group [GS83].

**Theorem 6.1** (Bartholdi-Grigorchuk [BG00]). *For  $n \geq 1$ , the spectrum of the graph  $\Gamma_n$ , as a set, has  $2^n$  elements (thus, all eigenvalues are distinct) and is equal to*

$$\text{Sp}(\Gamma_n) = \left\{ 1 \pm \sqrt{5 + 4 \cos \frac{2k\pi}{2^n}} \mid k = 0, \dots, 2^{n-1} \right\} \setminus \{-2, 0\}.$$

The spectrum of  $\Gamma$  (the Schreier spectrum of  $\mathcal{G}$ ), as a set, is equal to

$$\mathrm{Sp}(\Gamma) = [-2, 0] \cup [2, 4].$$

*Remark 6.2.* There is a different way in which the spectrum of  $\Gamma_n$  can be written. Namely, for  $n \geq 2$ ,

$$\mathrm{Sp}(\Gamma_n) = \{4, 2\} \cup \left( 1 \pm \sqrt{5 \pm 2 \bigcup_{i=0}^{n-2} f^{-i}(0)} \right),$$

where

$$f(x) = x^2 - 2.$$

Note that

$$f^{-k}(0) = \pm \sqrt{2 \pm \sqrt{2 \pm \sqrt{2 \pm \cdots \pm \sqrt{2}}}},$$

where the root sign appears exactly  $k$  times. The closure  $\overline{\bigcup_{i=0}^{\infty} f^{-i}(0)}$  is equal to the interval  $[-2, 2]$  and is the Julia set of the polynomial  $f$ . Therefore,

$$\begin{aligned} \mathrm{Sp}(\Gamma) &= \{4, 2\} \cup \left( 1 \pm \sqrt{5 \pm 2 \cdot [-2, 2]} \right) = \{4, 2\} \cup \left( 1 \pm \sqrt{[1, 9]} \right) \\ &= \{4, 2\} \cup (1 \pm [1, 3]) = [-2, 0] \cup [2, 4]. \end{aligned}$$

For the calculations in this example, we may use the 2-dimensional auxiliary pencil of operators defined by

$$A_n^{(2)}(x, y) = a_n + b_n + c_n + d_n - (1+x)I + (y-1)a_n.$$

The recursive formula for the determinant of  $A_n(x, y)$  is, for  $n \geq 2$ ,

$$\det(A_n^{(2)}(x, y)) = (x^2 - 4)^{2^{n-2}} \det(A_{n-1}^{(2)}(F(x, y))),$$

where  $F : \mathbb{R}^2 \rightarrow \mathbb{R}^2$  is given by

$$F(x, y) = \left( x - \frac{xy^2}{x^2 - 4}, \frac{2y^2}{x^2 - 4} \right).$$

The map  $\psi : \mathbb{R}^2 \rightarrow \mathbb{R}$  that semi-conjugates  $F$  to  $f(x) = x^2 - 2$  is

$$\psi(x, y) = \frac{x^2 - 4 - y^2}{2y}.$$

The 2-dimensional joint spectrum of  $A_n(x, y)$  is a family of hyperbolae and intersecting this family with the line  $y = 1$  gives the desired spectrum.

The more general problem of determining the spectrum of the operator associated to any element of the form  $ta + ub + vc + wd$  in the group algebra  $\mathbb{R}[\mathcal{G}]$  is considered in [GLN14], where it is shown that, apart from few exceptions (such as the case  $u = v = w$  considered above), the spectrum is always a Cantor set.

## 6.2. The Hanoi Towers group $\mathcal{H} = \text{IMG} \left( z^2 - \frac{16}{27z} \right)$ and Sierpiński gasket.

**Theorem 6.3** (Grigorchuk-Šunić [GŠ06, GŠ08]). *For  $n \geq 1$ , the spectrum of the graph  $\Gamma_n$ , as a set, has  $3 \cdot 2^{n-1} - 1$  elements and is equal to*

$$\{3\} \cup \bigcup_{i=0}^{n-1} f^{-i}(0) \cup \bigcup_{j=0}^{n-2} f^{-j}(-2),$$

where

$$f(x) = x^2 - x - 3.$$

The multiplicity of the  $2^i$  eigenvalues in  $f^{-i}(0)$ ,  $i = 0, \dots, n-1$  is  $a_{n-i}$ , and the multiplicity of the  $2^j$  eigenvalues in  $f^{-j}(-2)$ ,  $j = 0, \dots, n-2$ , is  $b_{n-j}$ , where, for  $m \geq 1$ ,

$$a_m = \frac{3^{m-1} + 3}{2} \quad \text{and} \quad b_m = \frac{3^{m-1} - 1}{2}.$$

The spectrum of  $\Gamma$  (the Schreier spectrum of  $\mathcal{H}$ ), as a set, is equal to

$$\overline{\bigcup_{i=0}^{\infty} f^{-i}(0)}.$$

It consists of a set of isolated points, the backward orbit  $I = \bigcup_{i=0}^{\infty} f^{-i}(0)$  of 0 under  $f$ , and the set  $J$  of accumulation points of  $I$ . The set  $J$  is a Cantor set and is the Julia set of the polynomial  $f$ .

The KNS spectral measure is concentrated on the union of the backward orbits

$$\left( \bigcup_{i=0}^{\infty} f^{-i}(0) \right) \cup \left( \bigcup_{i=0}^{\infty} f^{-i}(-2) \right).$$

The KNS measure of each eigenvalue in  $f^{-i}\{0, -2\}$ , for  $i = 0, 1, \dots$ , is  $\frac{1}{2 \cdot 3^{i+1}}$ .

*Remark 6.4.* The Kesten-von-Neumann-Serre measure (KNS measure for short) is the weak limit of the counting spectral measures  $\mu_n$  associated to the graph  $\Gamma_n$ , for  $n \geq 0$  ( $\mu_n(B) = m_n(B)/|X|^n$ , where  $m_n(B)$  counts, including multiplicities, the eigenvalues of  $\Gamma_n$  in  $B$ ).

For the calculations in this example, the auxiliary pencil of operators used in [GŠ08] is 2-dimensional and given by

$$A_n^{(2)}(x, y) = a_n + b_n + c_n - xI + (y-1)d_n,$$

where the block structure of  $d_n$  is

$$d_n = \begin{bmatrix} 0 & 1 & 1 \\ 1 & 0 & 1 \\ 1 & 1 & 0 \end{bmatrix}.$$

The recursive formula for the determinant of  $A_n^{(2)}(x, y)$  is, for  $n \geq 2$ ,

$$\det(A_n^{(2)}(x, y)) = (x^2 - (1+y)^2)^{3^{n-2}} (x^2 - 1 + y - y^2)^{2 \cdot 3^{n-2}} \det(A_{n-1}^{(2)}(F(x, y))),$$

where  $F : \mathbb{R}^2 \rightarrow \mathbb{R}^2$  is given by

$$F(x, y) = \left( x + \frac{2y^2(-x^2 + x + y^2)}{(x-1-y)(x^2-1+y-y^2)}, \frac{y^2(x-1+y)}{(x-1-y)(x^2-1+y-y^2)} \right).$$

The map  $\psi : \mathbb{R}^2 \rightarrow \mathbb{R}$  that semi-conjugates  $F$  to  $f(x) = x^2 - x - 3$  is

$$\psi(x, y) = \frac{x^2 - 1 - xy - 2y^2}{y}.$$

### 6.3. The Tangled Odometers Group $\mathcal{T} = \text{IMG}\left(-\frac{z^3}{2} + \frac{3z}{2}\right)$ and the first Julia set.

**Theorem 6.5** (Grigorchuk-Nekrashevych-Šunić [GNŠ14]). *For  $n \geq 0$ , the spectrum of the graph  $\Gamma_n$ , as a set, has  $2^{n+1} - 1$  elements and is equal to*

$$\{4\} \cup \bigcup_{i=0}^{n-1} f^{-i}(2) \cup \bigcup_{j=0}^{n-1} f^{-j}(-2),$$

where

$$f(x) = x^2 - 2x - 4.$$

The multiplicity of the  $2^i$  eigenvalues in  $f^{-i}(2)$ ,  $i = 0, \dots, n-1$  is  $3^{n-1-i}$ , the multiplicity of the  $2^j$  eigenvalues in  $f^{-j}(-2)$ ,  $j = 0, \dots, n-1$ , is 1, and the multiplicity of the eigenvalue 4 is 1.

The spectrum of  $\Gamma$  (the Schreier spectrum of  $\mathcal{T}$ ), as a set, is equal to

$$\overline{\bigcup_{i=0}^{\infty} f^{-i}(2)}.$$

It consists of a set of isolated points, the backward orbit  $I = \bigcup_{i=0}^{\infty} f^{-i}(2)$  of 2 under  $f$ , and the set  $J$  of accumulation points of  $I$ . The set  $J$  is a Cantor set and is the Julia set of the polynomial  $f$ .

The KNS spectral measure is concentrated on the backward orbit

$$I = \bigcup_{i=0}^{\infty} f^{-i}(2)$$

of  $f$ . The KNS measure of each eigenvalue in  $f^{-i}\{2\}$ , for  $i = 0, 1, \dots$ , is  $\frac{1}{3^{i+1}}$ .

For the calculations in this example, the auxiliary pencil of operators used in [GNŠ14] is 3-dimensional and given by

$$A_n^{(3)}(x, y, z) = a_n + b_n + a_n^{-1} + b_n^{-1} - xc_n - (z+2)d_n + (y-1)g_n,$$

where the block structure of  $c_n$ ,  $d_n$  and  $g_n$  is

$$c_n = \begin{bmatrix} 1 & 0 & 0 \\ 0 & 0 & 0 \\ 0 & 0 & 0 \end{bmatrix}, \quad d_{n+1} = \begin{bmatrix} 0 & 0 & 0 \\ 0 & 1 & 0 \\ 0 & 0 & 1 \end{bmatrix}, \quad e_{n+1} = \begin{bmatrix} 0 & 1 & 1 \\ 1 & 0 & 0 \\ 1 & 0 & 0 \end{bmatrix}.$$

### 6.4. Lamplighter group $\mathcal{L}_2 = \mathbb{Z} \ltimes \bigoplus_{\mathbb{Z}} \mathbb{Z}/2\mathbb{Z}$ .

**Theorem 6.6** (Grigorchuk-Žuk [GŽ01]). *For  $n \geq 0$ , the spectrum of the graph  $\Gamma_n$ , as a set, is equal to*

$$\text{Sp}(\Gamma_n) = \{4\} \cup \left\{ 4 \cos \frac{p}{q} \pi \mid 1 \leq p < q \leq n+1 \text{ and } p \text{ and } q \text{ relatively prime} \right\}.$$

The multiplicity of the eigenvalue  $4 \cos \frac{p}{q} \pi$ , for  $1 \leq p < q \leq n + 1$ , and  $p$  and  $q$  relatively prime is equal to

$$\frac{2^n - 2^{\text{mod}(n,q)}}{2^q - 1} + 1_{\{q \text{ divides } n+1\}},$$

where  $\text{mod}(n, q)$  is the remainder obtained when  $n$  is divided by  $q$ , and  $1_{\{q \text{ divides } n+1\}}$  is the indicator function equal to 1 when  $q$  divides  $n + 1$  and to 0 otherwise. The multiplicity of the eigenvalue 4 is 1.

The spectrum of  $\Gamma$  (the Schreier spectrum of  $\mathcal{L}_2$ ), as a set, is equal to

$$\text{Sp}(\Gamma) = [-4, 4].$$

The KNS spectral measure is discrete and, for the eigenvalue  $4 \cos \frac{p}{q} \pi$ , with  $1 \leq p < q$  and  $p$  and  $q$  relatively prime, is equal to  $\frac{1}{2^q - 1}$ .

The above result has several interesting corollaries. First, note that there exist an infinite ray  $\zeta \in \partial X^*$  for which the corresponding parabolic subgroup  $P_\zeta = \text{St}_{\mathcal{L}_2}(\zeta)$  is trivial [GŻ01] (in fact, this is true for all infinite rays that are not eventually periodic [NP11, GK14]). For such a ray  $\zeta$ , the Schreier graph  $\Gamma_\zeta = \Gamma(\mathcal{L}_2, P_\zeta, S)$  and the Cayley graph  $\Gamma(\mathcal{L}_2, S)$  are isomorphic. The calculation of the spectrum of  $\mathcal{L}_2$  led to a counterexample of the Strong Atiyah Conjecture. The Strong Atiyah Conjecture states that if  $\mathcal{M}$  is a closed Riemannian manifold with fundamental group  $G$ , then its  $L^2$ -Betti numbers come from the following subgroup of the additive group of rational numbers

$$\text{fin}^{-1}(G) = \left\langle \left\{ \frac{1}{|H|} \mid H \text{ a finite subgroup of } G \right\} \right\rangle \leq \mathbb{Q}.$$

This is contradicted by the following result.

**Theorem 6.7** (Grigorchuk, Linnell, Schick, Żuk [GLSŻ00]). *There exists a closed Riemannian 7-dimensional manifold  $\mathcal{M}$  such that all finite groups in its fundamental group  $G$  are elementary 2-abelian,  $\text{fin}^{-1}(G) = \mathbb{Z}[\frac{1}{2}]$ , but its third  $L^2$ -Betti number is  $\beta_{(2)}^3(\mathcal{M}) = \frac{1}{3}$ .*

Note that other versions of Atiyah Conjecture were later also disproved by using examples based on lamplighter-like groups [Aus13, LW13].

**6.5. Basilica group  $\mathcal{B} = \text{IMG}(z^2 - 1)$  and  $\text{IMG}(z^2 + i)$ .** We do not have complete results for these two examples, but some progress was achieved.

The Schreier spectrum of Basilica group  $\mathcal{B}$  was considered in [GŻ02b], using the auxiliary 2-dimensional pencil of operators given by

$$A_n^{(2)}(x, y) = a_n + a_n^{-1} + y(b_n^{-1} + b_n^{-1}) - xI.$$

Partial results were also obtained by Rogers and Teplyaev by using the spectral decimation method [RT10].

The group  $K = \text{IMG}(z^2 + i)$  of binary tree automorphisms is generated by three involutions defined by the wreath recursion

$$a = (01)(e, e) \quad b = ()(a, c) \quad c = ()(b, e).$$

The Schreier spectrum of  $\text{IMG}(z^2 + i)$  was considered in [GSŠ07], using the auxiliary 3-dimensional pencil of operators given by

$$A_n^{(3)}(x, y, z) = a_n + yb_n + zc_n - xI.$$

In both cases, the corresponding multi-dimensional map  $F : \mathbb{R}^d \rightarrow \mathbb{R}^2$  was found, but the shape of the corresponding  $F$ -invariant subset (that is, the joint spectrum) is unknown.

## 7. LAPLACIANS ON THE LIMIT FRACTALS

For some contracting self-similar groups  $G$ , the Hecke type operators  $H_{\pi_n}$ , when appropriately rescaled, converge to a well defined *Laplacian* on the limit space. The process of finding the rescaling coefficient and proving existence of the limit Laplacian has much in common with the process of computing the spectra of operators  $H_{\pi_n}$ , as described in Section 5. A general theory, working for all contracting groups is still missing, but many interesting examples can be analyzed.

The technique in the known examples is based on the theory of Dirichlet forms on self-similar sets, see [Kig01]. A connection of this theory with self-similar groups, and the examples described in this section are discussed in more detail in [NT08].

Let  $G$  be a self-similar group generated by a finite symmetric set  $S$  and, for  $n \geq 0$ , let  $L_n = 1 - H_{\pi_n}$  be the corresponding Laplacian on the Schreier graph  $\Gamma_n$ . Let  $\mathcal{E}_n$  be the quadratic form with matrix  $L_n$ , that is, the form given by  $\mathcal{E}_n(x, y) = \langle L_n x, y \rangle$ .

Choose a letter  $x_0 \in X$ , and consider for every  $n \geq 1$  the subset  $V_n = x_0^{-\omega} X^n$  of the space  $X^{-\omega}$  encoding the limit space of  $G$ . We have  $V_n \subseteq V_{n+1}$ , and we naturally identify  $V_n$  with  $X^n$  by the bijection  $v \mapsto x_0^{-\omega} v$ . We also consider  $\mathcal{E}_n$  as a form on  $\ell^2(V_n) = \ell^2(X^n)$ .

The *trace*  $\mathcal{E}'_{n+1}$  of  $\mathcal{E}_{n+1}$  on  $V_n$  is the quadratic form  $\mathcal{E}$  such that for  $f \in \ell^2(V_n)$  the value of  $\mathcal{E}(f, f)$  is equal to the infimum of values of  $\mathcal{E}_{n+1}(g, g)$  over all functions  $g \in \ell^2(V_{n+1})$  such that  $g|_{V_n} = f$ .

The matrix of  $\mathcal{E}'_{n+1}$  is found as the *Schur complement* of the matrix  $L_{n+1}$  of  $\mathcal{E}_{n+1}$ .

Namely, decompose the matrix  $L_{n+1}$  into the block form  $\begin{bmatrix} A & B \\ C & D \end{bmatrix}$  according to the decomposition of  $\ell^2(X^{n+1})$  into the direct sum  $\ell^2(x_0 X^n) \oplus \ell^2((X \setminus \{x_0\})X^n)$  (so that  $A$ ,  $B$ ,  $C$ , and  $D$  are of sizes  $k^n \times k^n$ ,  $k^n \times (k-1)k^n$ ,  $(k-1)k^n \times k^n$ , and  $(k-1)k^n \times (k-1)k^n$ , respectively, where  $k = |X|$  is the size of the alphabet). Then the matrix of  $\mathcal{E}'_{n+1}$  is  $A - BD^{-1}C$ .

Let us consider some examples. Let  $G = \text{IMG}(z^2 - 1)$  be the Basilica group. Consider the Laplacian  $1 - \alpha(a + a^{-1}) - \beta(b + b^{-1})$ , and the corresponding Dirichlet forms  $\mathcal{E}_n$ . Then it follows from the recursive definition of the generators  $a$  and  $b$  that the decomposition of  $L_{n+1}$  into blocks  $\begin{bmatrix} A & B \\ C & D \end{bmatrix}$  (for  $x_0 = 1$ ) is

$$\begin{bmatrix} 1 - \beta(a + a^{-1}) & -\alpha(1 + b^{-1}) \\ -\alpha(1 + b) & 1 - 2\beta \end{bmatrix},$$

hence the matrix of  $\mathcal{E}_{n+1, x_0}$  is  $(1 - \frac{\alpha}{2}) - (\beta(a + a^{-1}) + \frac{\alpha}{2})$ . Consequently, if we take  $\alpha = \frac{2-\sqrt{2}}{2}$ , and  $\beta = \frac{\sqrt{2}-1}{2}$ , then we have  $\mathcal{E}'_{n+1} = \lambda \mathcal{E}_n$  for  $\lambda = \frac{1}{\sqrt{2}}$ . It follows then from the general theory, see [Kig03], that the forms  $\lambda^{-n} \mathcal{E}_n$  converge to a Laplacian on the limit space of  $G$ , that is, on the Julia set of  $z^2 - 1$ .

In some cases one needs to take slightly bigger sets  $V_n$ . For example, consider the Hanoi Towers group  $\mathcal{H}$ . Let  $V_n$  be the set of sequences of the form  $0^{-\infty} X^n$ ,  $1^{-\infty} X^n$ , and  $2^{-\infty} X^n$ . Let  $a = (01)(e, e, a)$ ,  $b = (02)(e, b, e)$ , and  $c = (12)(c, e, e)$ ,



and consider, for positive real numbers  $x, y$ , the form  $\mathcal{E}_n$  on  $\ell^2(V_n)$  given by the matrix

$$\begin{bmatrix} y(1-a) - 2x & -x & -x \\ -x & y(1-b) - 2x & -x \\ -x & -x & y(1-c) - 2x \end{bmatrix}$$

with respect to the decomposition  $\ell^2(V_n) = \ell^2(0^{-\omega}X^n) \oplus \ell^2(1^{-\omega}X^n) \oplus \ell^2(2^{-\omega}X^n)$ , where  $a, b, c$  act on the corresponding subspaces  $\ell^2(x^{-\omega}X^n)$  using the representation  $\pi_n$  (after we identify  $x^{-\omega}X^n$  with  $X^n$  in the natural way).

Then a direct computation using the recursive definition of the generators  $a, b, c$ , and the Schur complement shows that trace of  $\mathcal{E}_{n+1}$  on  $V_n$  is given by the same matrix where  $(x, y)$  is replaced by  $(\frac{3}{5+3x/y}x, y)$ . Passing to the limit  $y \rightarrow \infty$ , and restricting to functions on which the limit of the quadratic form is finite (which will correspond to identifying sequences  $\dots x^{-\omega}v$  representing the same points of the limit space), we get rescaling  $x \mapsto \frac{3}{5}x$ , hence convergence of  $(5/3)^n \mathcal{E}_n$  to a Laplacian on the limit space of  $\mathcal{H}$ , which is the Sierpiński gasket.

---

**Acknowledgment.** Many thanks to Christoph Bandt for his generous help and valuable input.

#### REFERENCES

- [AAV13] Gideon Amir, Omer Angel, and Bálint Virág. Amenability of linear-activity automaton groups. *J. Eur. Math. Soc. (JEMS)*, 15(3):705–730, 2013.
- [Aus13] Tim Austin. Rational group ring elements with kernels having irrational dimension. *Proc. Lond. Math. Soc. (3)*, 107(6):1424–1448, 2013.
- [BG00] L. Bartholdi and R. I. Grigorchuk. On the spectrum of Hecke type operators related to some fractal groups. *Tr. Mat. Inst. Steklova*, 231(Din. Sist., Avtom. i Beskon. Gruppy):5–45, 2000.
- [BGK<sup>+</sup>08] Ievgen Bondarenko, Rostislav Grigorchuk, Rostyslav Kravchenko, Yevgen Muntyan, Volodymyr Nekrashevych, Dmytro Savchuk, and Zoran Šunić. On classification of groups generated by 3-state automata over a 2-letter alphabet. *Algebra Discrete Math.*, (1):1–163, 2008.
- [BGN03] Laurent Bartholdi, Rostislav Grigorchuk, and Volodymyr Nekrashevych. From fractal groups to fractal sets. In *Fractals in Graz 2001*, Trends Math., pages 25–118. Birkhäuser, Basel, 2003.
- [BKN10] Laurent Bartholdi, Vadim A. Kaimanovich, and Volodymyr V. Nekrashevych. On amenability of automata groups. *Duke Math. J.*, 154(3):575–598, 2010.
- [BV05] Laurent Bartholdi and Bálint Virág. Amenability via random walks. *Duke Math. J.*, 130(1):39–56, 2005.
- [DG08] Thomas Delzant and Rostislav Grigorchuk. Homomorphic images of branch groups, and Serre’s property (FA). In *Geometry and Dynamics of Groups and Spaces*, volume 265 of *Progr. Math.*, pages 351–374. Birkhäuser, 2008.
- [FS92] M. Fukushima and T. Shima. On a spectral analysis for the Sierpiński gasket. *Potential Anal.*, 1(1):1–35, 1992.
- [GK14] R. Grigorchuk and R. Kravchenko. On the lattice of subgroups of the lamplighter group. *Internat. J. Algebra Comput.*, 24(6):837–877, 2014.
- [GLN14] Rostislav Grigorchuk, Daniel Lenz, and Tatiana Nagnibeda. Spectra of schreier graphs of grigorchuk’s group and schroedinger operators with aperiodic order. <http://arxiv.org/abs/1412.6822>, 2014.
- [GLSŽ00] Rostislav I. Grigorchuk, Peter Linnell, Thomas Schick, and Andrzej Żuk. On a question of Atiyah. *C. R. Acad. Sci. Paris Sér. I Math.*, 331(9):663–668, 2000.
- [GN05] R. Grigorchuk and V. Nekrashevych. Amenable actions of nonamenable groups. *Zap. Nauchn. Sem. S.-Peterburg. Otdel. Mat. Inst. Steklov. (POMI)*, 326(Teor. Predst. Din. Sist. Komb. i Algoritm. Metody. 13):85–96, 281, 2005.

- [GN07] Rostislav Grigorchuk and Volodymyr Nekrashevych. Self-similar groups, operator algebras and Schur complement. *J. Modern Dyn.*, 1(3):323–370, 2007.
- [GNS00] R. I. Grigorchuk, V. V. Nekrashevich, and V. I. Sushchanskiĭ. Automata, dynamical systems, and groups. *Tr. Mat. Inst. Steklova*, 231(Din. Sist., Avtom. i Beskon. Gruppy):134–214, 2000.
- [GNS14] Rostislav Grigorchuk, Volodymyr Nekrashevych, and Zoran Šunić. Analysis on the first julia set. in preparation, 2014.
- [Gri80] R. I. Grigorchuk. On Burnside’s problem on periodic groups. *Funktsional. Anal. i Prilozhen.*, 14(1):53–54, 1980.
- [Gri84] R. I. Grigorchuk. Degrees of growth of finitely generated groups and the theory of invariant means. *Izv. Akad. Nauk SSSR Ser. Mat.*, 48(5):939–985, 1984.
- [Gri00] R.I. Grigorchuk. Just infinite branch groups. In Markus P. F. du Sautoy Dan Segal and Aner Shalev, editors, *New horizons in pro-p groups*, pages 121–179. Birkhäuser Boston, Boston, MA, 2000.
- [GS83] Narain D. Gupta and Said N. Sidki. On the Burnside problem for periodic groups. *Math. Z.*, 182(3):385–388, 1983.
- [GŠ06] Rostislav Grigorchuk and Zoran Šunić. Asymptotic aspects of Schreier graphs and Hanoi Towers groups. *C. R. Math. Acad. Sci. Paris*, 342(8):545–550, 2006.
- [GŠ07] Rostislav Grigorchuk and Zoran Šunić. Self-similarity and branching in group theory. In *Groups St. Andrews 2005. Vol. 1*, volume 339 of *London Math. Soc. Lecture Note Ser.*, pages 36–95. Cambridge Univ. Press, Cambridge, 2007.
- [GŠ08] Rostislav Grigorchuk and Zoran Šunić. Schreier spectrum of the Hanoi Towers group on three pegs. In *Analysis on graphs and its applications*, volume 77 of *Proc. Sympos. Pure Math.*, pages 183–198. Amer. Math. Soc., Providence, RI, 2008.
- [GŠŠ07] Rostislav Grigorchuk, Dmytro Savchuk, and Zoran Šunić. The spectral problem, substitutions and iterated monodromy. In *Probability and mathematical physics*, volume 42 of *CRM Proc. Lecture Notes*, pages 225–248. Amer. Math. Soc., Providence, RI, 2007.
- [GŽ01] Rostislav I. Grigorchuk and Andrzej Żuk. The lamplighter group as a group generated by a 2-state automaton, and its spectrum. *Geom. Dedicata*, 87(1-3):209–244, 2001.
- [GŽ02a] Rostislav I. Grigorchuk and Andrzej Żuk. On a torsion-free weakly branch group defined by a three state automaton. *Internat. J. Algebra Comput.*, 12(1-2):223–246, 2002.
- [GŽ02b] Rostislav I. Grigorchuk and Andrzej Żuk. Spectral properties of a torsion-free weakly branch group defined by a three state automaton. In *Computational and statistical group theory (Las Vegas, NV/Hoboken, NJ, 2001)*, volume 298 of *Contemp. Math.*, pages 57–82. Amer. Math. Soc., Providence, RI, 2002.
- [Hut81] John E. Hutchinson. Fractals and self-similarity. *Indiana Univ. Math. J.*, 30(5):713–747, 1981.
- [Kig01] Jun Kigami. *Analysis on fractals*, volume 143 of *Cambridge Tracts in Mathematics*. Cambridge University Press, 2001.
- [Kig03] Jun Kigami. Harmonic analysis for resistance forms. *J. Funct. Anal.*, 204(2):399–444, 2003.
- [Kum93] Takashi Kumagai. Regularity, closedness and spectral dimensions of the Dirichlet forms on P.C.F. self-similar sets. *J. Math. Kyoto Univ.*, 33(3):765–786, 1993.
- [LW13] Franz Lehner and Stephan Wagner. Free lamplighter groups and a question of Atiyah. *Amer. J. Math.*, 135(3):835–849, 2013.
- [Mal94] Leonid Malozemov. Spectral theory of the differential Laplacian on the modified Koch curve. In *Geometry of the spectrum (Seattle, WA, 1993)*, volume 173 of *Contemp. Math.*, pages 193–224. Amer. Math. Soc., Providence, RI, 1994.
- [MT03] Leonid Malozemov and Alexander Teplyaev. Self-similarity, operators and dynamics. *Math. Phys. Anal. Geom.*, 6(3):201–218, 2003.
- [Nek05] Volodymyr Nekrashevych. *Self-similar groups*, volume 117 of *Mathematical Surveys and Monographs*. American Mathematical Society, Providence, RI, 2005.
- [NP11] Volodymyr Nekrashevych and Gábor Pete. Scale-invariant groups. *Groups Geom. Dyn.*, 5(1):139–167, 2011.

- [NT08] Volodymyr Nekrashevych and Alexander Teplyaev. Groups and analysis on fractals. In P. Exner, J. P. Keating, P. Kuchment, T. Sunada, and A. Teplyaev, editors, *Analysis on Graphs and its Applications*, volume 77 of *Proceedings of Symposia in Pure Mathematics*, pages 143–170. A.M.S., 2008.
- [RT82] R. Rammal and G. Toulouse. Spectrum of the Schrödinger equation on a self-similar structure. *Phys. Rev. Lett.*, 49(16):1194–1197, 1982.
- [RT10] Luke G. Rogers and Alexander Teplyaev. Laplacians on the basilica Julia sets. *Commun. Pure Appl. Anal.*, 9(1):211–231, 2010.
- [Shi96] Tadashi Shima. On eigenvalue problems for Laplacians on p.c.f. self-similar sets. *Japan J. Indust. Appl. Math.*, 13(1):1–23, 1996.
- [Sid00] Said Sidki. Automorphisms of one-rooted trees: growth, circuit structure, and acyclicity. *J. Math. Sci. (New York)*, 100(1):1925–1943, 2000.
- [Str06] Robert S. Strichartz. *Differential equations on fractals*. Princeton University Press, Princeton, NJ, 2006. A tutorial.
- [Tep98] Alexander Teplyaev. Spectral analysis on infinite Sierpiński gaskets. *J. Funct. Anal.*, 159(2):537–567, 1998.
- [Tep04] Alexander Teplyaev. Spectral zeta function of symmetric fractals. In *Fractal geometry and stochastics III*, volume 57 of *Progr. Probab.*, pages 245–262. Birkhäuser, Basel, 2004.

*E-mail address:* grigorch@math.tamu.edu

*E-mail address:* nekrash@math.tamu.edu

*E-mail address:* sunic@math.tamu.edu

, DEPARTMENT OF MATHEMATICS, TEXAS A&M UNIVERSITY, COLLEGE STATION, TX 77843-3368, USA