

# EMMA: A Resource Oriented Framework for Service Choreography over Wireless Sensor and Actor Networks

Duhart Clement<sup>1</sup>, Sauvage Pierre<sup>1</sup>, and Bertelle Cyrille<sup>2</sup>

<sup>1</sup>Department of Computer Science, LACSC, ECE Paris, France,  
<duhart, sauvage>@ece.fr

<sup>2</sup>LITIS, FR CNRS 3638, Le Havre University, France,  
cyrille.bertelle@univ-lehavre.fr

## Abstract

Current Internet of Things (IoT) development requires service distribution over Wireless Sensor and Actor Networks (WSAN) to deal with the drastic increasing of network management complexity. Because of the specific constraints of WSAN, centralized approaches are strongly limited. Multi-hop communication used by WSAN introduces transmission latency, packet errors, router congestion and security issues. As it uses local services, a decentralized service model avoid long path communications between nodes and applications. But the main issue is then to have such local services installed on the desired nodes. Environment Monitoring and Management Agent (EMMA) system proposes a set of software to deploy and to execute such services over WSAN through middleware based on Contiki OS. This contribution presents EMMA middleware, methodology and tools used to determine efficient service mapping and its deployment.

**Keywords:** Internet of Things (IoT), Wireless Sensor Network (WSN), Service Choreography (SC), Middleware, Mobile Agent and Petri Network

## 1 Introduction

The development of the Internet of Things (IoT) has some emphasis about current scientist issues and future industrial applications. Among the IoT applications, the Responsive Environments (RE) are a part of a novel technological area. RE aims to transform our daily environments into intelligent spaces. Historically the domotic systems were automata systems for controlling appliances. Nowadays the term of RE is referring to an environment connected to Internet. On one hand, the data collection is used by remote service providers to

manage macro issues, i.e. the energy providers which have to regulate energy production. And on the other hand, the different appliances are managed by different service companies over Internet. An alarm system can be monitored by distant security guardians and an health care system helps older people in their daily tasks. A major challenge for the IoT is the sharing of a common network infrastructure between all current and future services. Wireless Sensor and Actor Networks (WSAN) are used to connect locally the different appliances into a common wireless mesh networks. Appliances get an Internet access through others appliances. WSAN has important constraints in terms of bandwidth, throughput and payload. The network protocols proposed for WSAN, such as ZigBee, were incompatible with Internet Protocol (IP), the Internet standard.

Since the 90's, a lot of research works have experimented approaches around IP to facilitate WSAN incorporation into Internet. IPv6 LoW Power Wireless Area Networks (6LoWPAN) protocol has been standardized to use IPV6 over IEEE 802.15.4 (ZigBee) developed for energy constrained devices [7, 14, 16]. An HTTP based application layer called Constrained Application Protocol (CoAP) is currently investigated to provide WEB based communication transactions [17]. This protocol provides mechanisms for webservice interfaces like REpresentational State Transfer (REST) or Simple Object Access Protocol (SOAP) [21]. A lot of open discussions remain regarding software architectures for RE. Assuming that all appliances use a common network protocol, their applications stay heterogeneous which is addressed commonly by a central system. However in such situation, packet congestion appears around the routers according to network depth. Hence a new approach called Service Choreography (SC) is emerging to distribute locally the data exchanges. But the data heterogeneity is not still managed in framework found in literature.

This paper focuses on methodology of design, analysis and deployment of such distributed services over Wireless Sensor and Actor Networks (WSAN). Section 2 presents a literature review regarding the different programming approaches of middleware to focus on current limitations of future required Resource Oriented Architecture (ROA). The proposed framework Environment Monitoring and Management Agent (EMMA) is introduced in Section 3. This framework facilitates service choreography by providing a flexible distributed Publish-Subscribe mechanisms over CoAP. Efficient methodology to distribute such data exchanges is presented in Section 4 according to node hosting capacity with the consideration of deployment processes. Section 5 presents results about association mapping of this rules and discuss about efficient deployment process. Finally, Section 6 concludes about EMMA approach and future works.

## 2 Related work

A middleware is a piece of abstraction software which provides advanced functionalities of hardware and network engines to applications. It is composed at least of a network stack, a multi-task manager and the drivers. Hadim et al. [13] and Rahman et al. [22] detail the different challenges regarding the net-

work (scalability, mobility and dynamic topology), design (hardware abstraction, resource awareness and modular programming) and data (aggregation, heterogeneity and quality of service). The design of middleware stays an intensive research domain because its technologies issues are inherent of large applications area. Rubio et al. [23] proposes a classification of programming middleware for WSN: the *macro-programming* and the *node-centric*.

The *macro-programming* consider a WSN like an integrated system. Each node is a processing unit which executes particular operations assigned at a macro-level. The literature provides three main different approaches of *macro-programming* in which the system is considered indifferently like a cluster of processing units, a distributed database or a Multi Agent System (MAS). Kushwaha et al. [19] presents the OASIS architecture to design applications composed of different tasks distributed over the WSN. They exchange directly their data in order to build computation flows over the WSN. These tasks and their interconnections are designed offline and deployed remotely from supervisors. Hence the operations are executed directly inside the WSN but they are managed remotely. Costa et al. [4] proposes an architecture which considers the WSN like a distributed database. Instead of collecting all data into a database, the requests are directly transmitted by broadcasting over the WSN. The nodes resolve locally the request in order to provide an aggregated response to the requester. Fok et al. [10] and Hackmann et al. [12] have developed another macro-programming approach based on mobile agents. Each node has a Virtual Machine (VM) in order to execute soft-coded applications. An application is composed of different role based agents which exchange data and perform operations onto a virtual tuple space. In MAS, each agent tries to satisfy its goals under its constraints in order to reach a global stationary point. Hence new constraints or goals can be added on runtime by the addition of agents in the virtual tuple space. This strong uncoupling between the application and hardware levels facilitates dynamic and online reprogramming of the WSN such as there is no global problem formulation. Moreover, Liu et al. [20] show that this approach is useful to load-balance energy consumption over the WSN using mobile agent moving over the nodes according to the residual energy repartition.

The *node-centric* design considers the nodes like autonomous devices connected to WSN. In such approach, the application term is referring to the software embedded into the nodes. They collaborate with others nodes or Internet services like a traditional distributed system. Hence the middleware provides mechanisms for networked applications including service discovery, protocol interfaces and data heterogeneity management. Dunkels et al [8] has developed a complete micro-operating system able to execute such applications in parallel on a single node. These applications communicate with other local applications through an event-based messaging engine and remotely with others services with the uIP stack. They propose an advanced solution using standard protocol 6LoWPAN to deploy remotely the binary applications over the air like on traditional computer systems. However in WSN, the nodes can not be configured manually and individually according to the large scale of the network. Delicato et al [5], Souto et al [9] and Khedo et al. [15] propose mechanisms based

on Publish-Subscribe pattern to configure remotely the data exchanges between the applications. The applications subscribe to a class of data through their middleware in order to receive them when they are published on the network.

Both approaches have different interests according to the WSN purposes. For example in data collection, a distributed database is more interesting than a *node-centric* approach because the system is homogeneous and do not require to collect systematically all data on a central database. In case of IoT applications, the devices and the services are produced and added by different manufacturers along the network lifetime. The lack of standard middleware forces the manufacturers to use *node-centric* middleware in their products. In such situation, the inherent heterogeneity of the applications and the network communications should be managed by supervisors in order to maintain network consistency and to preserve its resources. Kuorilehto et al. [18] conclude their survey that *Currently, they implement technologies and algorithms for application distribution but lack an approach combining a distributing middleware layer to OS providing a single node control.* Recently, Cherrier and al. [3, 2] has proposed a new framework based on choreography of services for WSN. They combine both approaches proposing a distributed *node-centric* based middleware with a high level language to describe macro-applications. The nodes provide web-services to produce or consume data which can be used simultaneously by different applications. Hence the authors propose a model of Finite State Machine (FSM) in order to guarantee the system consistency according to the different network exchanges between the node applications. The authors compare their work with centralized approaches based on the orchestration of services in which a gateway collects all the data and controls remotely the system. They demonstrate analytically and empirically that choreography model has better performances in terms of reliability, energy efficiency and scalability than orchestration. However the resource limitations in term of memory on node do not allows them to manage the heterogeneity of sequential protocols used at application layer such as SOAP. Hence, Guinard et al [11] proposes a ROA framework for service choreography. This REpresentational State Transfer (RESTFUL) model uses the Publish-Subscribe mechanisms at resource level. Hence, the protocols which require sequential exchanges are implemented like a FSM of several Publish-Subscribe instead of a part of the webservice. An application is resumed by a graph of resource interactions described like Publish-Subscribe configurations. When a resource is changing, its contain is transmitted to its dependent resources in order to form a cascading computation flow over the WSN. In literature review, the establishment of choreography at resource level between node applications are operated manually from supervisor.

In this paper, the following questions are addressed to propose a Resource Oriented Architecture (ROA) middleware with self-reconfiguration mechanisms for service choreography over WSN:

*How to map automatically the resources over the WSN ?*  
*How to guarantee the consistency of their interactions ?*  
*And how to deploy them in a large scale network ?*

## 3 EMMA Framework

EMMA is a middleware for service choreography over WSA. Its Resource Oriented Architecture (ROA) encapsulates node services into containers in order to form a resource tuple space. Among the different services, a VM executes reactive agents which models an augmented Publish-Subscribe mechanism distributed over the WSA. These agents have the ability to transcode CoAP requests in order to manage locally the heterogeneity with other middlewares or remote services using CoAP. Such as these agents are themselves resources, they have the capacity to be self-deployed with self-rewriting abilities.

A SC is a service choreography formed by a set of services connected by the agents. The resource tuple space provided by the middleware forms a complete abstraction between the service choreography and its execution supports on node. A remote supervisor is responsible to define the best mapping of resources to deploy SC in order to preserve nodes and network load. This mapping takes in consideration the deployment process which is itself a SC composed of agents.

This Section presents the middleware architecture with the different basic EMMA services of agent executions, system interfaces and data storages. The proposed graphical framework based on an augmented Petri Network provides an easy solution to design complex SC with composition features. Its use allows mathematical background to be reused in order to analysis event diffusion of the SC in order to guarantee its consistency. Finally, the different strategies of resource deployment are presented with peer-to-peer deployment, composed deployment and self-deployment.

### 3.1 Middleware

#### 3.1.1 Resource Abstraction

EMMA middleware is based on REST architecture which publishes data through CoAP resources. These resources are managed by encapsulated services which can be a driver, a processing or a memory storage. These services are implemented through an internal POSIX file API which provides resource reading, editing, creation or deletion by external CoAP requests. By default, the middleware provides three types of services illustrated in Figure 1a :

- *Agent service (A)*: An agent resource is a script evaluated to send CoAP requests to other resources. Such as an agent is a resource, it can be created, modified or deleted by another agent including itself.
- *System service (S)*: A system resource contains node information such as routing tables, sensor data, actuator state, energy consumption, etc. These resources are input and output interfaces of the system.
- *Local service (L)*: A local resource contains temporary data used and produced by agents to manage system resources.

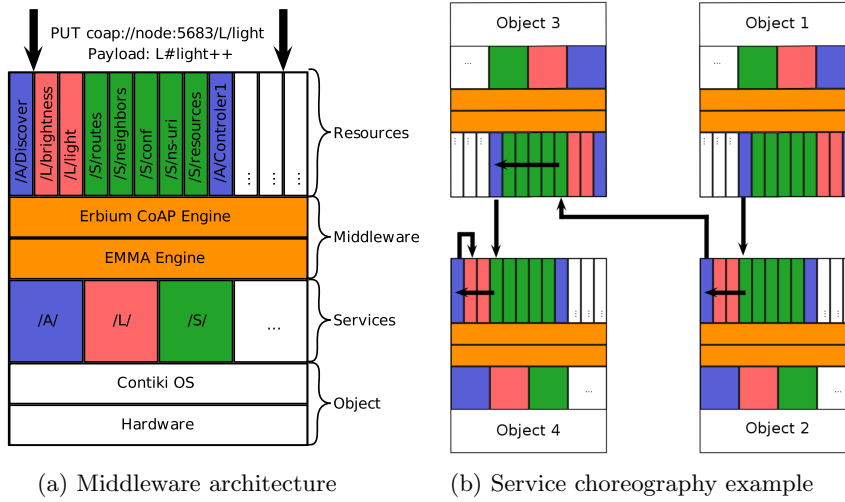

Figure 1: The middleware provides an abstraction between hard-coded service of the node and their reprogrammable choreography by EMMA agents.

### 3.1.2 Agent Service

The agent service is used to model the service choreography by defining distributed configurations of Publish-Subscribe. An agent is a rule to transmit the contain of a resource to another one according to the conditional resource state of the node. If a sensor updates its value contained in a resource, the sensitive agents update other depending resources which forms a cascading computation flow over the WSN such as illustrated in Figure 1b. The resource tuple space abstracts the network communication which allows the agent to update indifferently a local or a remote resource on another node. The resources are accessible through an Unified Resource Identifier (URI) composed of the node IP, the EMMA listening port and its service name.

An EMMA agent  $a$  is a JavaScript Object Notation (JSON) file stored on node  $n$  which contains a set  $X$  of resources. It is composed of three elements:

- **A boolean activation function**  $PRE_a(X_n)$   
Example:  $/L/threshold < /S/brightness$
- **A set of resource targets**  $y \in Y$   
Example:  $PUT[aaaa::2]:5683/S/light$
- **A set of payload preprocessing functions**  $POST_a^y(X_n, y)$   
Example:  $\{ 'value': '/S/light ++ \};$

When its boolean activation function  $PRE_a(X_n)$  is true, it sends CoAP requests to target resource  $y \in Y$  according to  $POST_a^y(X_n, y)$  such as resume in Eq (1).

$$\text{If } PRE_a(X_n) \text{ is true : } \forall y \in Y, y \xleftarrow[\text{action}]{} POST_a^y(X_n, y) \quad (1)$$

Such as illustrated in following agent examples, the *PRE* field specifies the firing condition to send a request to each resource target stored in *TARGET* field. A target is defined by a CoAP action and an URI. The payload stored in *POST* field for each resource target is a template file which is processed to replace variables by their resource value. If the payload contains mathematical operations, they are performed before to send the request. This payload can contain unresolved variables which are replaced by the resource values of the target node. Such as agents are also resources, they can create or delete agents including themselves which offers them self-deployment ability.

```

1 {
2   "NAME": "AgentSensor",
3   "PRE": "L#brightness<50 && S#time%10 == 0",
4   "POST": [
5     "'value':R#light+1'",
6     "L#brightness"
7   ],
8   "TARGET": [
9     "PUT[aaaa::2]:5683/L/light",
10    "PUT[aaaa::1]:5683/database/light"
11  ]
12 }

```

JSON Agent 1: This agent is hosted on a brightness sensor which orders to a light to increase its value before to transmit the measured brightness to a database each 10 seconds if the mesured brightness is lower than 50.

```

1 {
2   "NAME": "DiscoverDeployer",
3   "PRE": "S#rand%2==0",
4   "POST": [
5     "A#DiscoverDeployer",
6     {
7       "PRE": "S#rand%5==0",
8       "POST": [
9         "'resources':S#resources"
10      ],
11      "TARGET": [
12        "PUT[aaaa::1]:5683/NetworkInfo"
13      ]
14    }
15  ],
16  "TARGET": [
17    "POST[ff02::2]:5683/A/DiscoverDeployer",
18    "POST[0::1]:5683/A/DiscoverNotifier"
19  ]
20 }

```

JSON Agent 2: The agent DiscoverDeployer is a self-deployer agent which is sent periodically and randomly to its neighbors and installs on them the DiscoverNotifier agent. This agent will send periodically and randomly the resource list of the node to the proxy aaaa::1.

### 3.1.3 Heterogeneity Management

The CoAP is based on Hyper Text Transfer Protocol (HTTP) which do not define data formatting nor URI specifications. Hence, this lack do not allows different CoAP middlewares to communicate directly. Traditionally, this issue is managed by a proxy server which translates the requests. In this sense, CoAP has an internal static Publish-Subscribe mechanism which allows the proxy to collect data from all nodes in order to ensure translations.

The EMMA middleware allows this translation to be operated directly by the agents. Because their requests are fully specified through the fields *POST* and *TARGET*, they can send natively any kind of payload with any URI. For example, if a remote middleware uses Extensible Markup Language (XML) formatting language, the *POST* field of the agent should contain the required XML template. Moreover the agent can generate requests to subscribe to CoAP Observer mechanism in order to collect the data of another middleware. The combination of these two types of agent allows an EMMA node to subscribe data to another middleware in order to generate CoAP requests for another one such as illustrated in Listening 3.

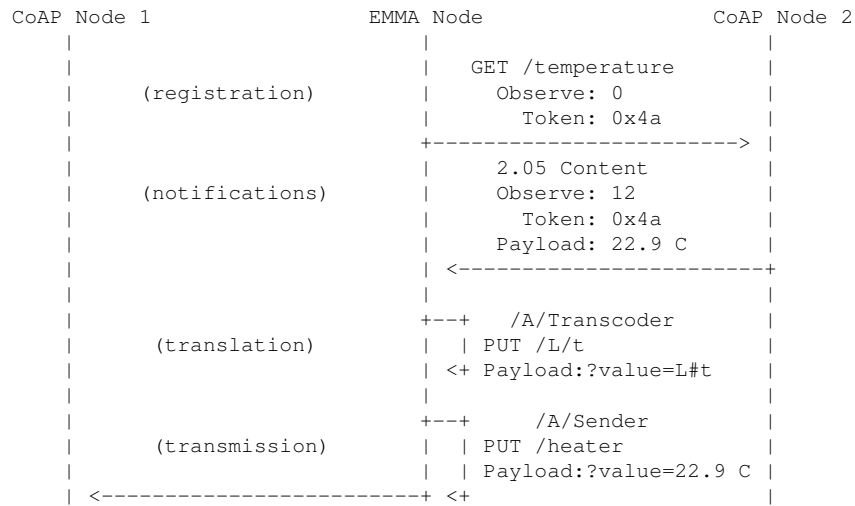

JSON Agent 3: An EMMA node contains an agent which subscribes to Observer mechanism of the node 2. When a data is pushed by this node on a temporary EMMA resource, a transcoder agent is fired to generate a CoAP request for another node. This example illustrates heterogeneity management by an EMMA node between a temperature sensor and an heater which cannot communicate directly without the mediation of a proxy.

The management of data heterogeneity for service choreography is a crucial issue which has not be found in literature review such as it requires to centralize data on proxy. The proposed specification of agents provides this feature on each node executing EMMA middleware.



## 3.2 Service Choreography

Service Choreography (SC) is a set of node web services interconnected in order to exchange their data in peer-to-peer fashion. They are configured through the augmented Publish-Subscribe of EMMA to distribute the deployment processes, the control-command loops between sensors and actuators, the service discovery mechanisms and the management of data heterogeneity. The design of SC is a challenge regarding problem complexity of concurrent accesses on distributed resources during event diffusion over the WSN. The proposed framework uses an augmented Petri Network to model them at an abstraction level and to analyse their logical properties.

### 3.2.1 Petri Network Abstraction

EMMA design model is an augmented Petri Network in which requests are modeled by tokens, agents by transitions and resources by places. A transition is fired if these two conditions are satisfied: (1) a token appears in any input places and (2) the agent boolean test returns true. This transition activation produces a token for each output places and changes target resource values by corresponding pre-processed payload. Agents are also resources then, each transition is associated to a place. If this kind of place is deleted, the associated transition is destroyed, in the same way for creation or edition. Therefore, this Petri Network model is dynamic and can change during its execution. This model illustrated in Figure 2 allows SC to be simulated independently of its execution supports. Its behavior is validated thanks to classical algorithms found in literature of Petri Network such as safety, liveness, reversibility, determinism, termination, output-correctness and input-dependence [1]. Moreover classical patterns can be reused directly such as Sequence, Parallel Split, Synchronization, Exclusive Choice, Simple Merge, Multi-choice, Structured Synchronizing Merge, Multi-Merge, Arbitrary Cycles, Multiple Instances [24].

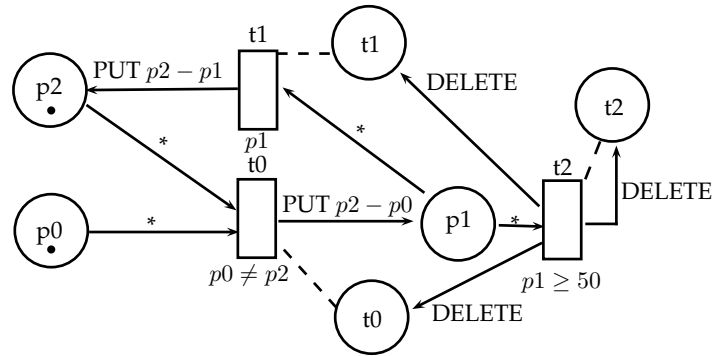

Figure 2: This distributed application computes the differential value  $p1(t) = p0(t - 1) - p0(t)$  through agent t1 and t2. If reaching the value 50, the agent t2 is fired and uninstalls application including itself.

### 3.2.2 Dynamic Deployment Process

Deployment process consists to install resources, including agents, on nodes. There are several ways to generate deployment process according to distributed application complexity, network topology and already deployed applications:

- *Direct deployment* sends directly agents to each node from supervisor. This approach is interesting for configuration adjustments but not efficient if there are a lot of resources to deploy in deep networks and moreover unavailable in case of hidden node problem [6] .
- *Composed deployment* illustrated in Figure 3a uses agents to carry other agents. They are sent on a node in order to install locally the resources and also to launch other deployment agents in a particular region of the WSN. These deployment agents produce deployment chains like a Matroska game. This ability allows deployment process to be distributed over the WSN, however the overhead produced by these agents is important according to the number of contained deployment agents.
- *Self-deployment* is a flooding approach in which a deployment agent is broadcast to all neighbors. It contains all resources to deploy over the WSN for a SC. When it arrives on a node, it deploys resources required by this node according to its resource context. Then it moves to next ones such as illustrated in Figure 3b. This kind of agents have a very large size but they are interesting in deploying common SC like the Service Discovery mechanism.

These deployment chains are themselves SC. They are designed and validated by EMMA Petri Network and deployed by one of the above deployment way. Therefore, the application deployment process has to be considered during the mapping process of distributed applications.

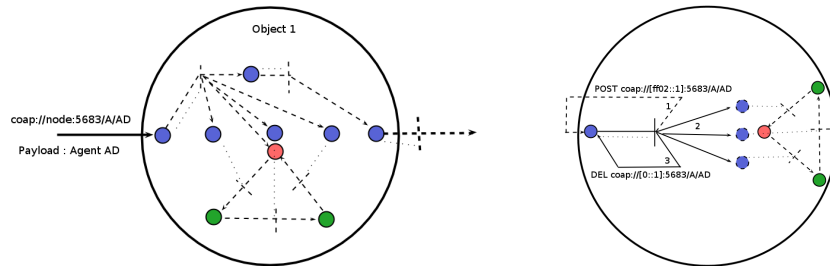

(a) Example of a Matroska deployment agent AD arriving on a node to install resources before to sent next deployment agent to the next target node. (b) Example of a self-deployment agent which duplicates itself to its neighbors before to install the agents and to delete itself.

Figure 3: Available deployment approaches with EMMA framework.

### 3.3 Choreography Mapping Methodology

Mapping process consists to associate for each required resources of a SC an empty resource space on a node in order to minimize network communication costs. This mapping process is composed of three specification stages: functional design, instantiation process and SC deployment.

#### 3.3.1 Functional Design

The functional design uses previously presented Petri Network to model the SC. The different input-output resources produced by node services are connected through agent resources  $A$  (modelled by transitions) in addition of temporary resource  $L$  (corresponding to places). This specification stage introduces the concept of scope which manages structural dependencies such as illustrated in top of Figure 4. For implementation reason, a transition resource  $a$  must be on the same node  $n$  that the resources of its input places  $X_n$  required by its activation function  $PRE_a(X_n)$ . Otherwise for a reason of efficiency, a SC designer would like to force several resources to be located on the same node because of the frequency of their exchanges. All resources inside a common scope are mapped on the same node, and several scopes can be mapped on the same node. Then, the scopes form mapping specifications to determine enabling hosting nodes. The distribution of the scopes over the WSA is itself specified by scope links:

- *Scope dependencies:* A scope which requires several identical scopes is connected by a link of multiplicity  $M$ . For example, an agent of data aggregation requires  $M$  values produced by sensor resources. Hence the scope containing the agent is linked to the scope which models the sensor resources by a multiplicity parameter equal to  $M$ .
- *Network topology constraints:* The SC design is operated independently of the target network. However it is possible to constraint the resource mapping in respect of network constraints such as the maximal number of communication hops between two scopes.

#### 3.3.2 Instantiation Process

The instantiation process generates the global SC graph according to a target WSA. The list of required resources produced by node services is established in order to determine the scopes which can be mapped according to their multiplicity parameters and the network constraints. The mapping problem presented in Section 4 evaluates the set of mapping permutations in order to minimize an objective function representing global network load. In addition of the SC graph, the mapper adds the SC of the deployment process to keep free resource for the composed agents responsible of the agent  $A$  and temporary  $L$  resource installations.

### 3.3.3 Choreography Deployment

SC deployment process generates for each node an agent which contains all resources to deploy on it. These agents are included into one to another by back propagation along a deployment path which is by default the routing tree from supervisor. Their composition is limited by their size according to the memory capacity of the nodes along the deployment path. This procedure is reiterated until that the WSAW coverage is reached in order to send the generated deployment agents to the corresponding nodes from supervisor.

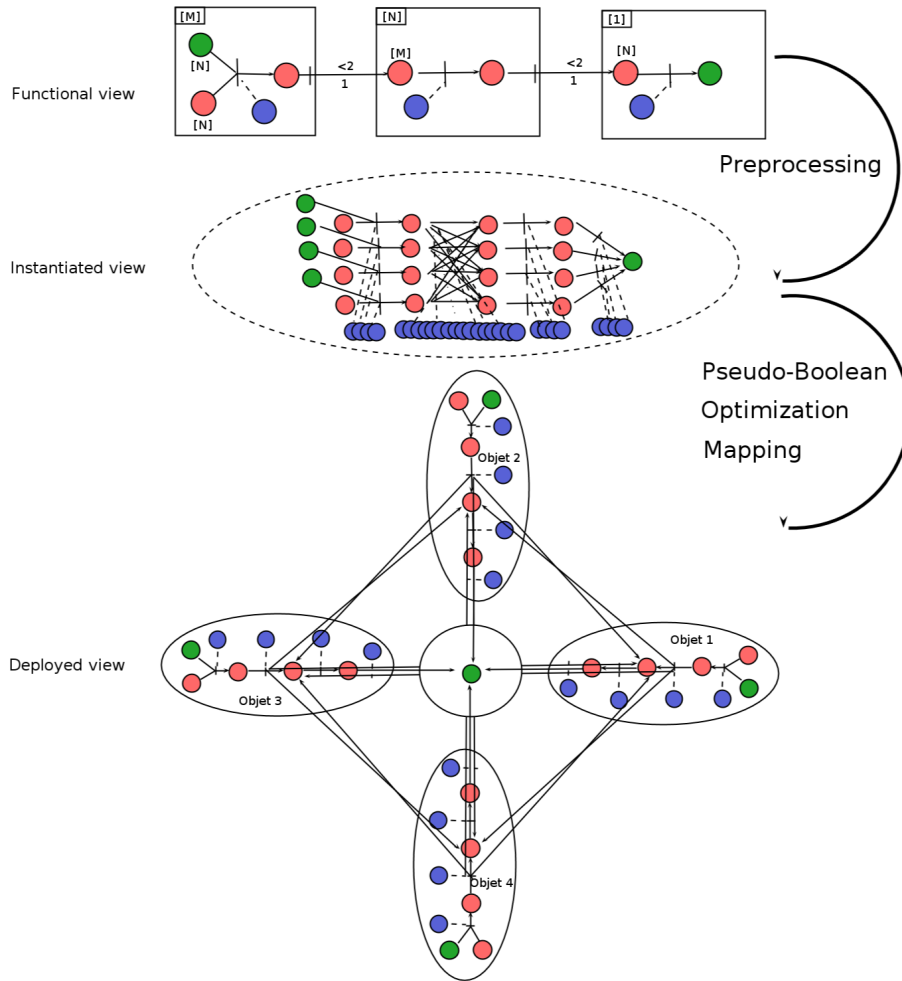

Figure 4: Overview of the three steps of mapping process: Functional Design, Instantiation Process and Choreography Deployment.

## 4 Theoretical Background

Application mapping problem consists to determine an efficient distribution of resources on nodes to minimize communication loads. Based on functional constraints and network topology with node hosting capacities, instantiated graph is mapped over WSA<sub>N</sub> with its deployment process.

### 4.1 Model Definitions

#### 4.1.1 Network

A WSA<sub>N</sub> is composed of a set of nodes  $N = \{n_1, n_2, \dots\}$  modelled by a distance matrix  $D$  in which  $d_{n_1, n_2}$  represents the cost metric between  $n_1$  and  $n_2$ . By default, the cost metric is determined by the routing algorithm according to the number of hops between two nodes. It can model any others parameters such as the bandwidth, the link quality or an aggregation of them. If and only if the communications are bi-directional,  $\forall n_1, n_2 \in N : d_{n_1, n_2} = d_{n_2, n_1}$ . Because of node memory limitation, the routing tables of nodes are partial, a node  $n_1$  can be hidden to  $n_2$  and so  $d_{n_2, n_1} = \infty$ .

#### 4.1.2 Scopes

The set of scopes  $S = \{S_1, \dots, S_m\}$  represents the whole application to deploy on WSA<sub>N</sub>. A scope is composed of resources which have to be deployed on the same node. Several scopes can be mapped on a same node, as long as the node capacity is sufficient. Two scopes are called linked if one resource of the first scope interacts with one of the second. This communication is modeled by data exchange frequency  $f$  (integer) and a weight  $p$  (integer) which represents number of packets required to transmit payload. Cost of communications  $a$  between two resources is denoted  $c_a$ .

$$c_a = f_a \times p_a \quad (2)$$

The set of all communications from scope  $s_1$  to scope  $s_2$  is denoted  $A_{s_1, s_2}$ , defined in Eq (3), such as the sum of all resource communication costs between scopes  $s_1$  and  $s_2$ . If the communications between two scopes are not symmetric:  $A_{s_1, s_2} \neq A_{s_2, s_1}$ , hence  $c_{s_1, s_2} \neq c_{s_2, s_1}$ .

$$c_{s_1, s_2} = \sum_{a \in A_{s_1, s_2}} c_a = \sum_{a \in A_{s_1, s_2}} f_a \times p_a \quad (3)$$

The multiplicity parameter  $M(s) \in \mathbb{R}^{+*}$  defines how many times scope  $s$  needs to be deployed on the network according to its dependent scopes  $s' \in S'$ . Even if the number of scopes is determined during instantiation step, the multiplicity parameter is used by the mapper to exclude unavailable solutions.

### 4.1.3 Resources

A resource  $r_n$  is an empty space of memory on the node  $n$  associated to a unique access path defined by scope/type/name. Each resource has a type denoted  $t$  corresponding to its management service. There are two main categories of resources:

- *Choreography resources* are a set of resources which have to be mapped and deployed on nodes for the SC.
- *External resources* are a set of resources already present on the nodes because they are a part of another SC or permanent system resources.

$\forall n \in N$ ,  $R_n$  defines the set of resources on node  $n$ .  $R_n$  admits a unique partitioning by resource types with at most  $t$  subsets. A free resource denoted  $r^j$  is an empty space to host resource on a node according to its type  $j$ . Free resource set of type  $j$  is denoted  $\dot{R}_n^j$  which is included in set of all resources  $\dot{R}_n$  on node  $n$ . An external resource is denoted  $\bar{r}$  among set of already deployed resources  $\overline{R}_n$  and  $\overline{R}_n^j$  the set of external resources of type  $j$ .

$$\forall n \in N, R_n = \overline{R}_n \cup \dot{R}_n \quad (4)$$

## 4.2 Problem Formulation

### 4.2.1 Knapsack Problems

The formulation of SC mapping problem is composed of two variants of the Knapsack problem:

- *Multiple Knapsack Problem (MKP)*: Each node is considered like a Knapsack in which resources should be deployed according to the node capacity.
- *Multiple Choice Knapsack Problem (MCKP)*: The nodes have a finite partition for each resource type. In addition of the constraint on hosting capacity, the number of elements by type is limited on each node.

There are also associative constraints when several resources are grouped in a scope, all of this resources have to be mapped on the same node according to its free resources by type. But a same scope cannot be mapped several times on the same node according to its multiplicity parameters. Indeed, multi-mapping of those target resources on the same node produced an ambiguity which cannot be resolved automatically without explicit designer indications. Finally, the problem formulation is defined by:

*How to map scopes which requires different number and types of resources over a set of node partitions which do not have the same hosting capacities in terms of resource type and memory size in order to minimize the network communication load ?*

### 4.2.2 Mappable Applications

**Definition 1.** *size()* operator is defined as:

- *size(r)* refers to the memory space used by a resource  $r$
- *size(R)* refers to the memory space used by all resources in  $R$
- *size(n)* refers to the memory available on a node  $n$

**Definition 2.**  $\forall s \in S, N_s \subseteq N$  denotes the set of nodes on which the scope  $s$  is mappable. A scope  $s$  is mappable on a node  $n$  if and only if:

- Node  $n$  has a free resource  $\dot{r}_2$  for each resource  $\dot{r}_1$  of the same type.

$$\forall \dot{r}_1 \in \dot{R}_s^i, \exists \dot{r}_2 \in \dot{R}_n^i \quad (5)$$

- Node  $n$  contains a resource  $\overline{r}_2$  with the same name and type for each required external resource  $\overline{r}_1$ .

$$\forall \overline{r}_1 \in \overline{R}_s^i, \exists \overline{r}_2 \in \overline{R}_n^i \text{ such as } \overline{r}_1 = \overline{r}_2 \quad (6)$$

- Node  $n$  has enough available memory to contain resources of scope  $s$

$$\text{size}(\dot{R}_s) \leq \text{size}(n) - \text{size}(\overline{R}_n) \quad (7)$$

**Definition 3.**  $\forall n \in N, S_n \subseteq S$  denoted the set of scopes mappable on  $n$ .

**Definition 4.** An application is mappable if (but not only if) all of its scopes are mappable according to their multiplicities:  $\forall s \in S, \exists N_s$  such as  $|N_s| \geq M(s)$ .

The previous definition is used to trivially determine that a problem may not be satisfiable. Indeed *emma-design-tools* preprocessor evaluates possibility to have solution before to solve Pseudo-Boolean Optimization problem.

### 4.3 Pseudo-Boolean Optimization

Pseudo Boolean Optimization (PBO) is a problem defined by a pseudo-boolean function to minimize (or maximize), respecting the constraints expressed by equations (or inequations). Here, PBO is used to find the best mapping of whole SC over WSA to minimize communication costs between nodes.

$$\forall s \in S, \forall n \in N_s : x_0^0, x_0^1, \dots, x_1^0, \dots, x_s^n \in X$$

represent boolean value of the scope  $s$  mapping on node  $n$ . The set of mapping combinations is equal to the sum of mapping availability of a scope  $s$  over the set of nodes :

$$|X| = \sum_{s \in S} |N_s| \quad (8)$$

### 4.3.1 Cost Function

The cost function  $z(X)$  evaluates the impact of the mappings  $X$  on the network communication load. The Pseudo Boolean Optimization (PBO) solver determines the best combinations of scopes and nodes among the set  $X$  of permutations in order to minimize the communication costs between the linked scopes. The communication cost  $c_{s_1, s_2}$  from the scope  $s_1$  to  $s_2$  is defined such as the number of exchanged packets times the frequency of their exchanges. In addition, the distance of communication path between the nodes  $n$  and  $n'$  which hosts the scopes is defined in  $d_{n, n'}$  such as the number of router hops. Finally, the pseudo-boolean function to minimize is defined in Eq. (9) such as the multiplication of communication costs between the pair of scopes and the number of router hops between them.

$$\min z(X) = \sum_{s \in S} \sum_{n \in N_s} \sum_{s' \in S} \sum_{n' \in N_{s'}} c_{s, s'} d_{n, n'} x_s^n x_{s'}^{n'} \quad (9)$$

### 4.3.2 Constraint Set

The minimization of the function  $z(X)$  is constraint by the following set of equations to define available mappings.

The Eq. (10) constraint the solver to map each scope on different nodes according to its multiplicity parameter  $M(s)$ .

$$\forall s \in S : \sum_{n \in N_s} x_s^n = M(s) \quad (10)$$

The Eq. (11) forces the mapping of linked scopes to have a network route between their hosting nodes. The constraint is inversely defined such as if there is no route between hosting nodes of two linked scopes  $d_{n, n'} = \infty$ , their communication cost is forced to null which is a forbidden value to exclude solutions.

$$\sum_{s \in S} \sum_{n \in N_s} \sum_{s' \in S} \sum_{\substack{n' \in N_{s'} \\ d_{n, n'} = \infty}} c_{s, s'} x_s^n x_{s'}^{n'} = 0 \quad (11)$$

The Eq. (12) defines that the number of resource of type  $i$  contained in a scope  $s$  to map on  $n$  must be lower or equal than available spaces for this resource type on the node.

$$\forall n \in N, \forall i \in T : \sum_{s \in S_n} |\dot{R}_s^i| x_s^n \leq |\dot{R}_n^i| \quad (12)$$

The Eq. (13) limits the total memory usage by the mapped resources on a node to its available hardware memory.

$$\forall n \in N : \sum_{s \in S_n} x_s^n \text{size}(\dot{R}_s) \leq \text{size}(n) - \text{size}(\overline{R}_n) \quad (13)$$



## 5 Procedure and Evaluations

This section resumes the installation procedure of Service Choreography (SC) on a WSN composed of EMMA and others CoAP nodes. The deployment process is evaluated for the two kinds of deployment agents proposed in EMMA framework. The experimental support of self-deployment and composed agents is a SC for *Network and Service Discovery* mechanism. The results explain the choice of composed agents for SC deployment in EMMA mapping engine. Then, the resolution time of mapping problem is investigated on a classical problem in distributed systems: the Philosopher Dining. This example offers an enough SC complexity in order to provide a representative benchmark. These evaluations are not compared with other solutions because authors were not able to find in literature review similar approaches for automatic mapping and distributed deployment of SC.

### 5.1 Installation Procedure

1. *Network and Service Discovery* consists to recuperate the lists of nodes and their resources in order to determine the map of the WSN composed of the network topology and node services.
  - (a) *EMMA nodes* are discovered by the Agent 2 previously presented which self-deploys on each EMMA node an agent which pushes periodically and randomly the list of contained resources of its hosting node to the supervisor. Because the neighbors and route tables are included in system resources, all 6LoWPAN nodes are discovered.
  - (b) *Other CoAP nodes* are directly requested from the supervisor on their *Resource Discovery* (`coap://[IPv6]/.well-known/core`) to get the list of their resources including their meta description.
2. *Service Choreography (SC) Deployment* maps and deploys the different SC according to the discovered services and network topology.
  - (a) *Common SC* are self-deployment agents which are responsible to install common SC such as log collection agent and energy management configuration presented in Section 3.2.2.
  - (b) *Mapping Process* determines the best mapping of SC in order to minimize the network communication load and built the composed deployment agents presented in Section 4.
  - (c) *SC Deployment* launches the different deployment agents on their WSN area. This deployment is terminated when the Discover Notifier agents previously deployed transmit the complete list of deployed resources for each node.
3. *CoAP Node Integration* consists to build and launch manually the agents in order to connect them to deployed SC. The data heterogeneity at CoAP layer is managed by translator agents such as presented in Section 3.1.3.

## 5.2 Network and Service Discovery Deployment

EMMA agents allow deployment process to be performed by three different approaches: *direct deployment*, *composed deployment* and *self-deployment*. Direct deployment is the common approach in most of contributions for SC middleware. However, it produces an important load in deep network because all deployments are transmitted from the supervisor. Below results compares the two proposed strategies by EMMA between a self-deployment Agent 2 in Figure 5b and a composed Agent 1 in Figure 5a alone a 14-hop network. The experimentation evaluates the best strategy to deploy the Service Discover mechanism.

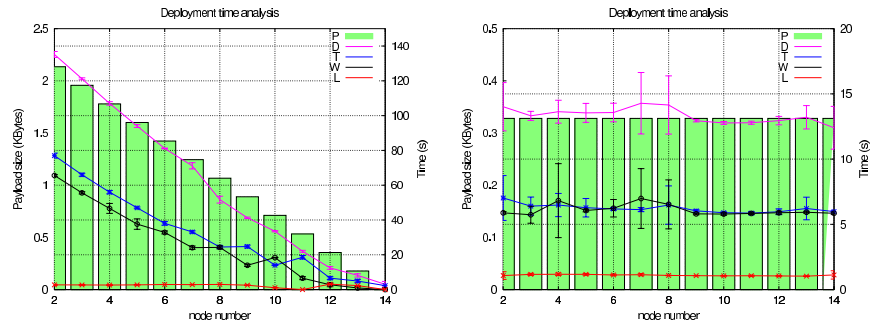

(a) Composed agent contains a Matroska (b) Self-deployment agents contains all of deployment agents to deploy SC. agents to deploy for all nodes.

Figure 5: EMMA deployment process benchmarks.

Above figures print deployment time  $D$  equal to agent writing time  $W$  to store agent contained in payload of size  $P$ , transmitted in  $T$  ms to node and executed in  $L$  ms on it. Such as agent execution is processed by block, transmission time of deployment agent  $i$  is equal to total transmission time minus writing time on next node which is resumed in Eq 14.

$$D(i) = W(i) + (T(i) - W(i + 1)) + L(i) \quad (14)$$

Figure 5a shows the impact of cumulated agent overhead along the deployment path. For each node, the deployment agent contains SC agents and the composed agents for the next node. This strategy is interesting in distributing the deployment process over WSAW areas which avoids network congestion on routers close of the supervisor. However the deployment of identical SC by this approach produces a useless redundancy. Figure 5b presents the deployment of a self-deployment agent which is broadcast over the WSAW. It deploys the SC on the node at its arriving before moving on the next nodes. Its constant overhead is low regarding contained SC, however its use for the deployment of whole SC implies that its payload is very large. Finally, the *self-deployment* is efficient for installation of common SC at initialization in order to avoid redundant compositions whereas the *composed deployment* is used for resource deployment delegation to a local node in the WSAW area of interest.

### 5.3 Philosopher Dining Mapping

Service Choreography (SC) mapping process is evaluated on a classical computer system problem of concurrent algorithm for synchronization issues. This application models a set of appliances which have to share energy tokens in order to avoid simultaneous energy consumption. For example in Smart Home application, electric-cars should not reload their battery at the same time that the hot water tank. In EMMA functional design, each philosopher is a scope composed of two places which models the tokens and two transitions for their exchanges such as illustrated in Figure 6a. The Figure 6b presents the mapping result for 20 philosophers on 4 nodes with its composed agent of deployment.

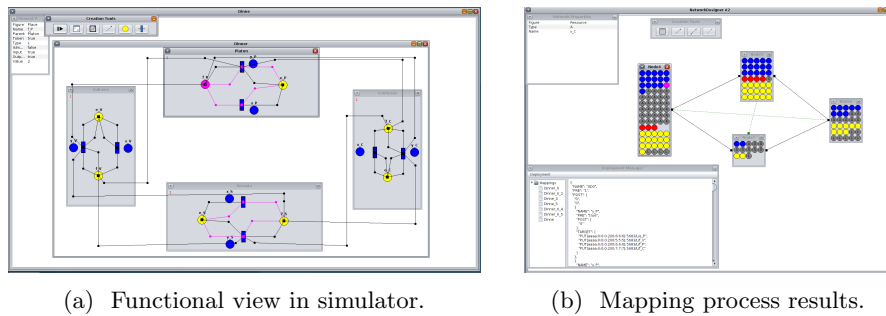

Figure 6: Dining Philosopher SC

In Figure 7, the mapping solver is evaluated according to the number of philosopher scopes and nodes in the WSAN. The number of generated constraints in Figure 7a increases proportionally with the number of nodes whereas the number of scopes has a low impact. The Figure 7b shows an exponential rising of the resolution time according to the number of nodes which means that the size of the WSAN is the major factor instead of SC complexity.

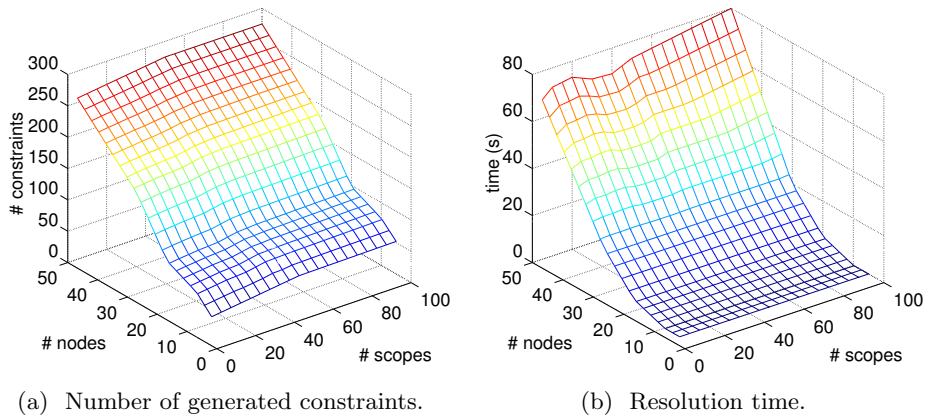

Figure 7: EMMA Application mapping benchmarks.

## 6 Conclusion

This paper presents EMMA framework which provides a set of tools to design distributed architectures for Responsive Environments (RE). Its Resource Oriented Architecture (ROA) provides an abstraction layer between the WSAN and its networked applications. The different services provided by the nodes are interconnected by a distributed Publish-Subscribe mechanism in order to form a Service Choreography (SC). Instead of proposing a new model, this work is original through the adaptation of well-known mathematical models to design and validate SC. Moreover, the framework implementation is based on standard technologies in order to propose an automatic solution to map, deploy and execute SC over heterogeneous WSAN. Hence this framework should be a first step toward distributed IoT applications with self-reconfiguration features.

## Annexe: Implementation

The EMMA middleware is implemented on Contiki OS by a set of standalone module applications. It is composed of the Erbium CoAP server-client, a File System (FS) for resource management with a JSON parser and a preprocessing engine for variable parsing. These modules communicate by an event messaging engine in order to take advantage of micro-controllers sleeping mode for energy saving purposes. The different component footprints are provided in Table 1.

Modules	RAM	Program memory
emma-client	381 Bytes	8267 Bytes
emma-server	456 Bytes	4528 Bytes
emma-resource	648 Bytes	4108 Bytes
emma-JSONparser	0 Bytes	382 Bytes
emma-preprocessor	95 Bytes	4116 Bytes
emma-service-system	60 Bytes	2845 Bytes
emma-service-numeric	10 Bytes	576 Bytes
emma-service-agent	210 Bytes	6586 Bytes
Total	1.9 KBytes	31.4 KBytes

Table 1: Memory footprints of EMMA modules on Contiki OS.

The EMMA mapper is a JAVA application with Human Computer Interface (HCI) to design Service Choreography (SC) and to print graphically their mapping on the WSAN. It is composed of a CoAP proxy based on Californium framework to collect network and service informations and a PBO solver based on SAT4J framework. The different results have been experimented on COOJA simulator using ATMEL avr-raven board composed of a radio transceiver IEEE 802.15.4 and an ATmega1284PV micro-controller 8-bits running at 8 Mhz with 16 KBytes RAM and 128 KBytes Flash memory.

## References

- [1] J. Billington, G. Wheeler, and M. Wilbur-Ham. Protean: a high-level petri net tool for the specification and verification of communication protocols. *IEEE Transactions on Software Engineering*, 14(3):301–316, Mar 1988.
- [2] S. Cherrier, Y. M. Ghamri-Doudane, S. Lohier, and G. Roussel. Services collaboration in wireless sensor and actuator networks: orchestration versus choreography. In *Symposium on Computers and Communications (ISCC)*, pages 000411–000418, Cappadocia, Turkey, July 2012. IEEE.
- [3] S. Cherrier, I. Salhi, Y. Ghamri-Doudane, S. Lohier, and P. Valembois. Bec 3: Behaviour crowd centric composition for iot applications. *Mobile Networks and Applications*, 19(1):18–32, 2014.
- [4] P. Costa, L. Mottola, A. L. Murphy, and G. P. Picco. Teenylime: Transiently shared tuple space middleware for wireless sensor networks. In *International Workshop on Middleware for Sensor Networks (MidSens)*, volume 1 of *MidSens '06*, pages 43–48, New York, NY, USA, Nov 2006. ACM.
- [5] P. L. Delicato FlviaCoimbra, Pires PauloF and da Costa Carmo Luiz Fernando Rust. A flexible middleware system for wireless sensor networks. In M. Endler and D. Schmidt, editors, *Middleware 2003*, volume 2672 of *Lecture Notes in Computer Science*, pages 474–492. Springer Berlin Heidelberg, 2003.
- [6] C. Duhart, M. Cotsaftis, and C. Bertelle. Wireless sensor network cloud services: Towards a partial delegation. In *International Conference on Smart Communications in NetworkTechnologies (SaCoNeT)*, Vilanova i la Geltru, Spain, June 2014. IEEE.
- [7] A. Dunkels. Full tcp/ip for 8-bit architectures. In *International Conference on Mobile systems, Applications and Services (MobiSys)*, volume 1, pages 85–98, San Francisco, CA, USA, May 2003. ACM.
- [8] A. Dunkels, B. Gronvall, and T. Voigt. Contiki-a lightweight and flexible operating system for tiny networked sensors. In *International Conference on Local Computer Networks (LCN)*, pages 455–462, Clearwater, Florida, USA, Oct 2004. IEEE, IEEE.
- [9] S. Eduardo, G. Germano, V. Glauco, V. Mardoqueu, R. Nelson, and F. Carlos. A message-oriented middleware for sensor networks. In *Workshop on Middleware for Pervasive and Ad-hoc Computing (WMPAC)*, MPAC '04, pages 127–134, New York, NY, USA, 2004. ACM.
- [10] C.-L. Fok, G.-C. Roman, and C. Lu. Agilla: A mobile agent middleware for self-adaptive wireless sensor networks. *ACM Transaction on Autonomous and Adaptive Systems*, 4(3):16–26, July 2009.

- [11] D. Guinard, V. Trifa, and E. Wilde. A resource oriented architecture for the web of things. In *Internet of Things (IOT), 2010*, pages 1–8. IEEE, 2010.
- [12] G. Hackmann, C.-L. Fok, G.-C. Roman, and C. Lu. Agimone: Middleware support for seamless integration of sensor and ip networks. In P. Gibbons, T. Abdelzaher, J. Aspnes, and R. Rao, editors, *Distributed Computing in Sensor Systems*, volume 4026 of *Lecture Notes in Computer Science*, pages 101–118. Springer Berlin Heidelberg, 2006.
- [13] S. Hadim and N. Mohamed. Middleware: Middleware challenges and approaches for wireless sensor networks. *IEEE Distributed Systems Online*, 7(3):1–1, 2006.
- [14] V. Jean-Philippe and D. Adam. *Interconnecting smart objects with ip: The next internet*. Morgan Kaufmann, 2010.
- [15] K. Khedo and R. Subramanian. A service-oriented component-based middleware architecture for wireless sensor networks. *International Journal of Computer Science and Network Security*, 9(3):174–182, 2009.
- [16] J. Ko, O. Gnawali, D. Culler, and A. Terzis. Evaluating the performance of rpl and 6lowpan in tinyos. In *Extending the Internet to Low power and Lossy Networks (IP+SN 2011)*, volume 1, pages 193–208, Chicago USA, April 2011. ACM.
- [17] M. Kovatsch, S. Duquennoy, and A. Dunkels. A low-power coap for contiki. In *International Conference on Mobile Ad-Hoc and Sensor Systems (MASS)*, volume 1, pages 855–860, Valencia, Spain, Oct 2011. IEEE.
- [18] M. Kuorilehto, M. Hannikainen, and T. D. Hamaainen. A survey of application distribution in wireless sensor networks. *Journal Wireless Communication Network (EURASIP)*, 2005(5):774–788, Oct. 2005.
- [19] M. Kushwaha, I. Amundson, X. Koutsoukos, S. Neema, and J. Sztipanovits. Oasis: A programming framework for service-oriented sensor networks. In *International Conference on Communication Systems Software and Middleware (COMSWARE)*, pages 1–8, Bangalore INDIA, Jan 2007. IEEE.
- [20] W. Liu and B. Chen. Optimal control of mobile monitoring agents in immune-inspired wireless monitoring networks. *Journal of Network and Computer Applications*, 34(6):1818 – 1826, 2011. Control and Optimization over Wireless Networks.
- [21] G. Moritz, F. Golatowski, and D. Timmermann. A lightweight soap over coap transport binding for resource constraint networks. In *International Conference on Mobile Adhoc and Sensor Systems (MASS)*, volume 1, pages 861–866, Valencia, Spain, Oct 2011. IEEE.

- [22] M. Rahman. Middleware for wireless sensor networks: Challenges and Approaches. *IEEE Distributed System Online*, 7(3):2–6, 2006.
- [23] B. Rubio, M. Diaz, and J. M. Troya. Programming approaches and challenges for wireless sensor networks. In *Systems and Networks Communications, 2007. ICSNC 2007. Second International Conference on*, pages 36–36. IEEE, 2007.
- [24] N. Russell, A. H. Ter Hofstede, and N. Mulyar. Workflow control flow patterns: A revised view. Technical report, BPM Center Report, 2006.