

Tight Span of Subsets of The Plane

With The Maximum Metric

Mehmet KILIÇ * Şahin KOÇAK * †

July 27, 2021

Abstract

We prove that a nonempty closed and geodesically convex subset of the l_∞ plane \mathbb{R}_∞^2 is hyperconvex and we characterize the tight spans of arbitrary subsets of \mathbb{R}_∞^2 via this property: Given any nonempty $X \subseteq \mathbb{R}_\infty^2$, a closed, geodesically convex and minimal subset $Y \subseteq \mathbb{R}_\infty^2$ containing X is isometric to the tight span $T(X)$ of X .

Keywords: tight span, hyperconvexity, injective envelope, Manhattan plane.

MSC[2010]: 51F99, 52A30.

1 Introduction

The notion of hyperconvexity and the associated notion of hyperconvex or injective hull of metric spaces were introduced in the two important papers Aronszajn - Panitchpakdi [2] and Isbell [8]. About twenty years later Dress [4] rediscovered the injective hull (which he called the tight span) of metric spaces and opened new ways of looking at the problem of optimal realizations of finite metric spaces in weighted graphs. Though that paper of Dress was a turning point, it remained a notoriously difficult problem to construct the tight span of finite metric spaces with more than a few points and relate them to optimal realizations ([10], [12], [1]). Recently D. Eppstein [5] gave an algorithm which decides whether the tight span of a finite metric space can be embedded into the l_1 plane (i.e. the so-called Manhattan plane) and he constructed the tight span of a subset of the Manhattan plane under a certain condition (see Thm 1 below). In this note we want to characterize (in Thm 2) the tight span of any subset of the l_∞ -plane

*Anadolu University, Science Faculty, Department of Mathematics, 26470, Eskişehir, Turkey, e-mails: kompaktuzay@gmail.com, skocak@anadolu.edu.tr

†Corresponding Author.

(which is isometric to Manhattan plane) without any restrictions (and without relying on Eppstein's theorem).

Aronszajn-Panitchpakdi called a metric space (X, d) hyperconvex, if for any collection $(x_i)_{i \in I}$ of points in X and any collection $(r_i)_{i \in I}$ of nonnegative real numbers satisfying $d(x_i, x_j) \leq r_i + r_j$ for all $i, j \in I$, the intersection of closed balls around x_i with radius r_i is nonempty: $\bigcap_{i \in I} \bar{B}(x_i, r_i) \neq \emptyset$. ($\bar{B}(x_i, r_i) = \{x \in X \mid d(x_i, x) \leq r_i\}$). They showed that a hyperconvex metric space X is retract of any space Y , where X is isometrically embedded in, whereby the retraction can be chosen nonexpansive (i.e. distance - non - increasing).

Isbell adopted a more categorical point of view and constructed in the category, whose objects are metric spaces and whose morphisms are non-expansive maps, injective objects and injective hulls for any metric spaces. An injective object in this category is a metric space X , which satisfies the following property: For any isometric embedding $i : Y \rightarrow Z$ and any morphism $f : Y \rightarrow X$ in this category, there exists an extension of f to Z ; i.e. a morphism $\tilde{f} : Z \rightarrow X$ such that the following diagram commutes:

$$\begin{array}{ccc} Y & \xrightarrow{i} & Z \\ & \searrow f & \swarrow \tilde{f} \\ & X & \end{array}$$

Isbell showed that for any metric space X there exists an injective metric space \tilde{X} with an isometric embedding $i : X \hookrightarrow \tilde{X}$ such that there is no proper injective subspace of \tilde{X} containing $i(X)$. He also showed that this property characterizes \tilde{X} up to isometry. He called this space the injective envelope of the metric space X . For an excellent survey on hyperconvexity and injectivity we refer to [7]. It turns out that a metric space is hyperconvex if and only if it is injective and consequently the injective hull and the hyperconvex hull of a metric space X (i.e. a minimal hyperconvex space containing X) are isometric objects (see also [9]). We note for later use the rather startling property that a metric space is hyperconvex if any isometric embedding $f : X \rightarrow X \cup \{y\}$, where $y \notin X$, has a non-expansive retraction (see [7]).

We recall briefly the construction of the injective envelope of Isbell (or, with another terminology, the “tight span” of Dress). Let X be any metric space. Consider the set $T(X)$ of functions $f : X \rightarrow \mathbb{R}^{\geq 0}$ satisfying the following two properties:

- i) $f(x) + f(y) \geq d(x, y)$, for all $x, y \in X$.
- ii) $\inf_{y \in X} (f(x) + f(y) - d(x, y)) = 0$, for all $x \in X$.

The second property implies that the functions satisfying these properties are min-

imal in the sense that the point-wise values of a function f can not be lowered. On the other hand, if f is a minimal function satisfying the first property (i.e. if g is another function satisfying the first property and $g \leq f$, then $g = f$), then f satisfies the second property.

The tight span (or injective envelope) $T(X)$ of X is obtained by putting the supremum metric d_∞ on the set $T(X)$:

$$d_\infty(f, g) = \sup_{x \in X} |f(x) - g(x)|.$$

2 Tight Span of Subsets of The l_∞ Plane

D. Epstein gave the following theorem about the tight span of subsets of the Manhattan plane (Lemma 9 in [5]):

Theorem 1 *Let X be a nonempty subset of the l_1 plane (not necessarily finite). If the orthogonal convex hull H of X is connected, then H is isometric to the tight span of X . (Orthogonal convex hull is defined to consist of all points surrounded by X , and a point p in the l_1 plane is said to be surrounded by X if each of the four closed axis-aligned quadrants with p as their apex contains at least one point of X .)*

Remark 1 *This theorem is not true as it stands, since, for example for an open square, the orthogonal convex hull equals this open square and is not hyperconvex; hence, it can not be the tight span. But D. Epstein remarks that one can fix the theorem by taking the closure of the orthogonal convex hull ([6]).*

It is well-known that the l_1 plane is isometric to the l_∞ plane (though this is false for higher dimensions) and we prefer, only as a matter of taste, the l_∞ plane with the maximum metric, since the l_∞ spaces are the natural home of tight spans.

We will give below a theorem (*Thm 2*) characterizing the tight span of any subset of the l_∞ plane. We first recall that in the l_∞ plane, which we denote by \mathbb{R}_∞^2 (i.e. (\mathbb{R}^2, d_∞) with $d_\infty((p_1, p_2), (q_1, q_2)) = \max\{|p_1 - q_1|, |p_2 - q_2|\}$), between any two points $p = (p_1, p_2)$ and $q = (q_1, q_2)$ there exist paths whose length equal $d_\infty(p, q)$. Such a path realizing the distance between the points p and q is called a geodesic if it is parameterized by arc length. In this sense \mathbb{R}_∞^2 is a strictly intrinsic metric space in the terminology of [3] and geodesic space in the terminology of [11]. A subspace $X \subseteq \mathbb{R}_\infty^2$ is called geodesically convex if for any two points $p, q \in X$, there exists a geodesic in \mathbb{R}_∞^2 which is contained in X . In other words, a subspace $X \subseteq \mathbb{R}_\infty^2$ is strictly intrinsic with respect to the induced metric if and only if it is geodesically convex. We can now formulate the following theorem:

Theorem 2 *Let $X \subseteq \mathbb{R}_\infty^2$ be a nonempty subspace. Let $Y \subseteq \mathbb{R}_\infty^2$ be a closed, geodesically convex subspace containing X and minimal with these properties. Then Y is isometric to the tight span of $T(X)$ of X .*

Before giving the proof we note that our assumptions are also necessary. It is well-known that a hyperconvex metric space is complete (see [7]) and we show that it is also strictly intrinsic (though this property doesn't seem to be noted in the literature):

Lemma 1 *A hyperconvex metric space is strictly intrinsic.*

(We defer the proof of this lemma to the appendix).

Theorem 2 is obviously a consequence of the following

Theorem 3 *A nonempty closed and geodesically convex subspace of \mathbb{R}_∞^2 is hyperconvex.*

Proof. Let $A \subseteq \mathbb{R}_\infty^2$ be a closed and geodesically convex subspace. It will be enough to show that A is injective. Let $A \cup \{z\}$ be an arbitrary one-point extension of the metric space A . We have to show that there exists a nonexpansive retraction $A \cup \{z\} \rightarrow A$. We first note that it will be enough to assume $z \in \mathbb{R}_\infty^2$. Because, otherwise we can extend the metric on $A \cup \{z\}$ to $\mathbb{R}_\infty^2 \cup \{z\}$ (see Lemma 5 in the appendix) and find by hyperconvexity of \mathbb{R}_∞^2 a nonexpansive retraction $r : \mathbb{R}_\infty^2 \cup \{z\} \rightarrow \mathbb{R}_\infty^2$. Consider the point $p = r(z)$ and the embedding $A \hookrightarrow A \cup \{p\}$. If there is a nonexpansive retraction $r_p : A \cup \{p\} \rightarrow A$, then $r_p \circ r|_{A \cup \{z\}} : A \cup \{z\} \rightarrow A$ is a nonexpansive retraction. So we can work with one-point extensions $A \hookrightarrow A \cup \{p\}$ for $p \in \mathbb{R}_\infty^2$ (in fact $p \in \mathbb{R}_\infty^2 \setminus A$).

Before proceeding with the proof, we want to give a few technical definitions and lemmas (whose proofs we defer to the appendix) we shall use during the proof.

Definition 1 *i) For $p, q \in \mathbb{R}_\infty^n$ we define*

$$D_{pq} = \{u \in \mathbb{R}^n \mid d_\infty(p, u) + d_\infty(u, q) = d_\infty(p, q)\}.$$

(see Fig. 1 for $n = 2$)

D_{pq} is the union of geodesic segments from p to q .

ii) For $p \in \mathbb{R}_\infty^n$ we define $S_i^\varepsilon(p) = \{q \in \mathbb{R}^n \mid d_\infty(p, q) = \varepsilon(q_i - p_i)\}$ for $i = 1, 2, \dots, n$ and $\varepsilon = \pm$ and call them the sectors at the point p (see Fig. 2)

Note that for $q \in S_1^\varepsilon(p)$, $D_{pq} = S_i^\varepsilon(p) \cap S_i^{-\varepsilon}(q)$.

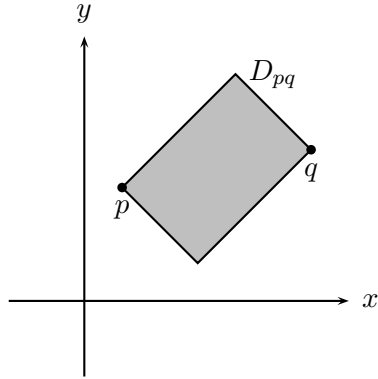

Figure 1: Union of geodesic segments from p to q

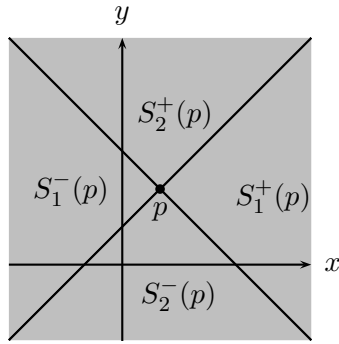

Figure 2: Sectors of a point p in the l_∞ plane

iii) For $p = (p_1, p_2) \in \mathbb{R}_\infty^2$ and $\varepsilon_1, \varepsilon_2 = \pm$ we call the set

$$I^{\varepsilon_1 \varepsilon_2}(p) = \{(p_1 + \varepsilon_1 t, p_2 + \varepsilon_2 t) \mid t \geq 0\}$$

the $\varepsilon_1 \varepsilon_2$ -ray at the point p (see Fig. 3)

Note that $I^{\varepsilon_1 \varepsilon_2}(p) = S_1^{\varepsilon_1}(p) \cap S_2^{\varepsilon_2}(p)$.

Lemma 2 Let $u \in \mathbb{R}_\infty^2$, $p \in S_1^\varepsilon(u)$, $q \in S_2^\delta(u)$ and γ a geodesic between the points p and q . Then there exists a t (in the domain of definition of γ) such that $\gamma(t) \in I^{\varepsilon\delta}(u)$.

Lemma 3 Let $A \subseteq \mathbb{R}_\infty^2$ a geodesically convex subspace and $p \in \mathbb{R}_\infty^2$. If each sector $S_i^\varepsilon(p)$ of the point p contains a point of A , then p belongs to the set A .

Lemma 4 Let $A \subseteq \mathbb{R}_\infty^n$ a connected subspace and $p \in \mathbb{R}_\infty^n$. If two opposite sectors $S_i^+(p)$ and $S_i^-(p)$ of the point p intersect the set A , but no other sectors of p intersect A , then $p \in A$.

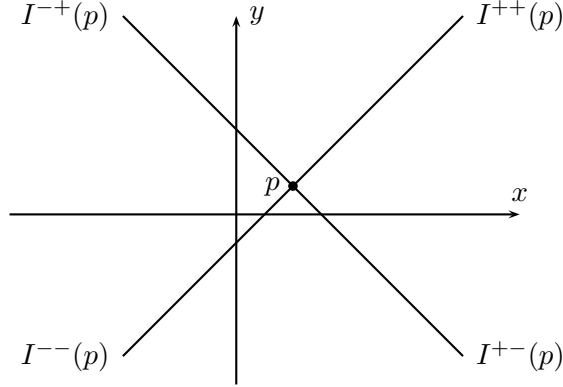

Figure 3: The $\varepsilon_1\varepsilon_2$ -rays at the point p

Now we continue with the proof of Theorem 3.

Let any point $p = (p_1, p_2) \in \mathbb{R}^2 \setminus A$ be given. We have to construct a nonexpansive retraction $A \cup \{p\} \rightarrow A$. We consider three cases, depending on how many sectors of p intersect the set A .

Three-Sectors Case:

Let us assume that three sectors of p intersect A . Without loss of generality we can take the sectors $S_1^+(p)$, $S_2^+(p)$ and $S_2^-(p)$. Since A is closed and connected (as a geodesically convex subspace), the ray $\{(p_1 + t, p_2) \mid t \geq 0\}$ intersects the set A at a point with minimal t , say t_0 (i.e. the first intersection point). Denote this point by $q = (q_1, q_2)$. In the interior of the sector $S_1^-(q)$ there can be no point of the set A . To see this, assume to the contrary that there exists a point $u \in A$ lying in this region. Without loss of generality we can assume that u lies above the line pq (i.e. with an ordinate higher than that of p). Now consider a point $v \in A \cap S_2^-(p)$. By geodesical convexity of A there is a geodesic between u and v , which must intersect the line pq . But this produces a point $w \in A$ left to the point q , which contradicts the choice of q (see Fig. 4).

We define the function $r : A \cup \{p\} \rightarrow A$,

$$r(x) = \begin{cases} x & , \quad x \in A \\ q & , \quad x = p. \end{cases}$$

The function r is a nonexpansive retraction. To see this let $a = (a_1, a_2) \in A$. We saw above that $a \notin (S_1^-(q))^\circ$. There are now three possibilities: $a \in S_1^+(q)$, $a \in S_2^+(q)$ and $a \in S_2^-(q)$.

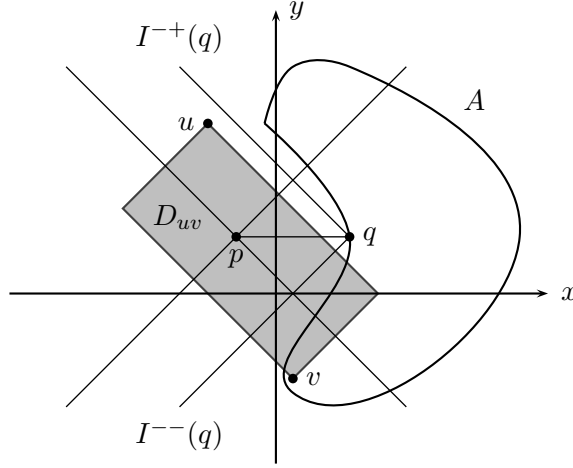

Figure 4: Three-sectors case

If $a \in S_1^+(q)$; then

$$\begin{aligned} d_\infty(a, q) &= a_1 - q_1 = a_1 - (p_1 + t_0) \\ &\leq a_1 - p_1 = d_\infty(a, p). \end{aligned}$$

If $a \in S_2^+(q)$; then

$$d_\infty(a, q) = a_2 - q_2 = a_2 - p_2 \leq d_\infty(a, p).$$

If $a \in S_2^-(q)$; then

$$d_\infty(a, q) = q_2 - a_2 = p_2 - a_2 \leq d_\infty(a, p).$$

So, in all cases $d_\infty(a, q) \leq d_\infty(a, p)$, as claimed.

Two-Sectors Case:

Let us assume that two sectors of p intersect A . Since A is connected, these two sectors can not be opposite sectors by Lemma 4. So, without loss of generality we can assume that the sectors are $S_1^+(p)$ and $S_2^+(p)$. First note that the line $\{(p_1 + t, p_2 - t) \mid t \in \mathbb{R}\}$ can not intersect the set A , since otherwise A would intersect at least three sectors of p . Now imagine that we move this line along the ray $I^{++}(p)$ towards A (i.e. consider the lines $I^{+-}(p_1 + t, p_2 + t) \cup I^{-+}(p_1 + t, p_2 + t)$ for $t \geq 0$). Let t_0 be the supremum of the parameters t , for which the corresponding lines do not intersect A .

Let $q = (q_1, q_2) = (p_1 + t_0, p_2 + t_0)$ (see Fig. 5).

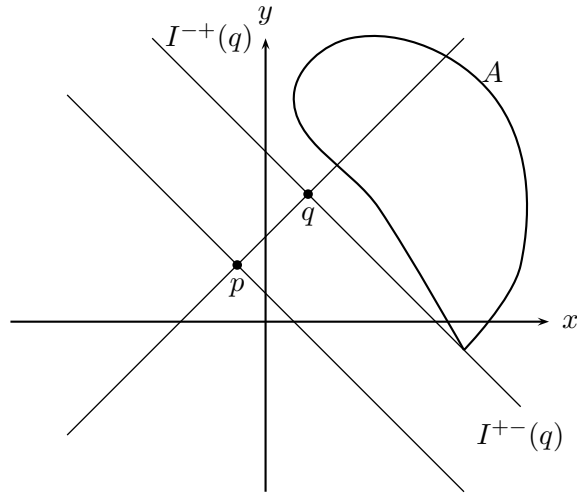

Figure 5: Two-sectors case

Now we define $r : A \cup \{p\} \rightarrow A \cup \{q\}$,

$$r(x) = \begin{cases} x & , x \in A \\ q & , x = p \end{cases}$$

The function r is nonexpansive. To see this, let $a = (a_1, a_2) \in A$. The point a can belong to $S_1^+(q)$ or $S_2^+(q)$.

If $a \in S_1^+(q)$; then

$$d_\infty(a, q) = a_1 - q_1 = a_1 - (p_1 + t_0) \leq a_1 - p_1 = d_\infty(a, p).$$

If $a \in S_2^+(q)$; then

$$d_\infty(a, q) = a_2 - q_2 = a_2 - (p_2 + t_0) \leq a_2 - p_2 = d_\infty(a, p).$$

So we have $d_\infty(a, q) \leq d_\infty(a, p)$, as claimed.

Now if $q \in A$, then $r : A \cup \{p\} \rightarrow A$ is a nonexpansive retraction and we are done.

If $q \notin A$, then there are two possibilities. Either the line $I^{-+}(q) \cup I^{+-}(q)$ intersects A or it does not intersect A . If it intersects A , it can not intersect both of the rays $I^{+-}(q)$ and $I^{-+}(q)$. Because otherwise the unique geodesic between two such points would contain q and thus q would belong to A . So assume without loss of generality that A intersects $I^{+-}(q)$ (see Fig. 5). Now consider the ray $\{(q_1 + t, q_2) \mid t > 0\}$ and denote its first intersection point with A by q' . The set A intersects three sectors of q and by the proof of the first case we have a nonexpansive retraction $r' : A \cup \{q\} \rightarrow A$ mapping $q \mapsto q'$. Combining the two nonexpansive retractions we get a retraction $r' \circ r : A \cup \{p\} \rightarrow A$.

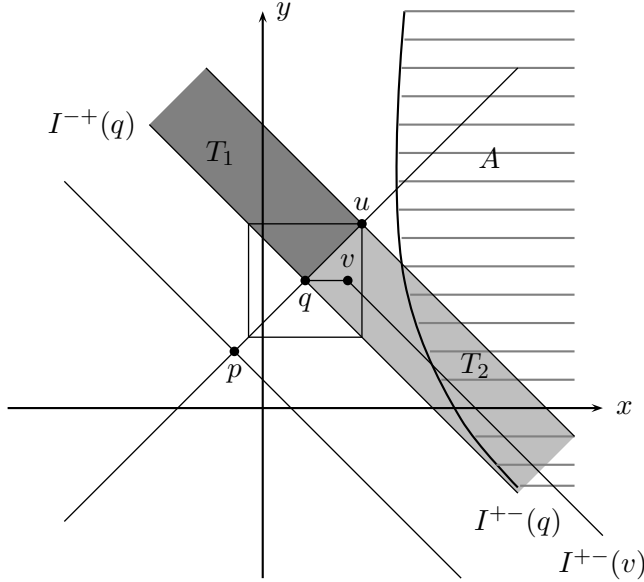

Figure 6: Two-sectors sub-case

We now consider the case where the line $I^{-+}(q) \cup I^{+-}(q)$ does not intersect A (see Fig. 6). Since A is closed there is a closed ball $\bar{B}(q, \varepsilon_0)$ not intersecting A . Let $u = (q_1 + \varepsilon_0, q_2 + \varepsilon_0)$ and consider the stripe T_1 bounded by the two rays $I^{-+}(q)$, $I^{-+}(u)$ and the segment $[qu]$ and the stripe T_2 bounded by the rays $I^{+-}(q)$, $I^{+-}(u)$ and the segment $[qu]$. The set A intersects one and only one of these stripes. It intersects one of them by the definition q and it can not intersect both of them, because otherwise a geodesic between two such points would intersect the segment $[qu]$, contradicting the choice of u , and we can assume without loss of generality that A intersects the stripe T_2 .

Now take any point $v = (q_1 + \varepsilon, q_2)$ inside $\bar{B}(q, \varepsilon_0)$ such that the ray $I^{+-}(v)$ intersects A . We are now in the position of the three-sectors case with respect to the point v . Now combining the nonexpansive functions $r : A \cup \{p\} \rightarrow A \cup \{q\}$, $r_1 : A \cup \{q\} \rightarrow A \cup \{v\}$ and $r_2 : A \cup \{v\} \rightarrow A$, we get a nonexpansive retraction $r_2 \circ r_1 \circ r : A \cup \{p\} \rightarrow A$.

One-Sector Case:

Now we consider the final case, where only one sector of p intersects A and we can assume this sector to be $S_1^+(p)$ (In fact, A must then lie in the interior of this sector). Imagine that we move the "right elbow" $I^{++}(p) \cup I^{+-}(p)$ of p horizontally to the right, i.e. we consider the elbows $I^{++}(p_1 + t, p_2) \cup I^{+-}(p_1 + t, p_2)$ for $t \geq 0$. Let t_0 denote the supremum of the parameters t , for which the corresponding elbows do not intersect A . Denote $q = (p_1 + t_0, p_2)$. If $q \in A$, then we are done, since we get a nonexpansive retraction $r : A \cup \{p\} \rightarrow A$, sending p to q . If $q \notin A$, but the elbow $I^{++}(q) \cup I^{+-}(q)$ of q intersects A , then we are in a position of two-sectors case or three-sectors case with respect to q and combining the nonexpansive functions $r : A \cup \{p\} \rightarrow A \cup \{q\}$ (sending p to q) and $r' : A \cup \{q\} \rightarrow A$, we get a nonexpansive retraction $r' \circ r : A \cup \{p\} \rightarrow A$ and we are done.

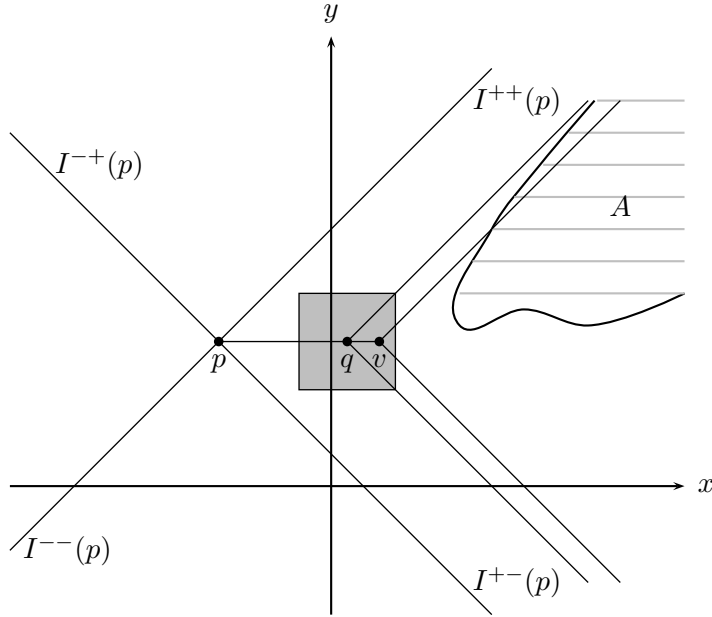

Figure 7: One-sector case

Now we consider the case where the elbow $I^{++}(q) \cup I^{+-}(q)$ of q does not intersect A (see Fig. 7). As $q \notin A$ and A is closed, there is a ball $\bar{B}(q, \varepsilon)$ not intersecting A . Choose a δ with $0 < \delta < \varepsilon$ such that the right elbow $I^{++}(v) \cup I^{+-}(v)$ of the point $v = (q_1 + \delta, q_2)$ intersects A . The map $r' : A \cup \{q\} \rightarrow A \cup \{v\}$, sending q to v and fixing the points of A is obviously a nonexpansive function.

Since the set A intersects two or three sectors of v , we can construct a nonexpansive retraction $r'' : A \cup \{v\} \rightarrow A$ and combining r, r' and r'' , we get a nonexpansive retraction $r'' \circ r' \circ r : A \cup \{p\} \rightarrow A$. ■

3 Some Examples

Using Theorem 2 one can produce easily many examples of tight spans of (finite or infinite) subspaces of the plane \mathbb{R}_∞^2 . We give below several examples.

Example 1 *Tight span of a three-point metric space $X = \{P_1, P_2, P_3\}$ with $d(P_2, P_3) = a$, $d(P_1, P_3) = b$ and $d(P_1, P_2) = c$. Assume without loss of generality $a \geq b$. Note that this space can be embedded into \mathbb{R}_∞^2 , e.g. as in Fig. 8 (the point p_i being the image of P_i under this embedding).*

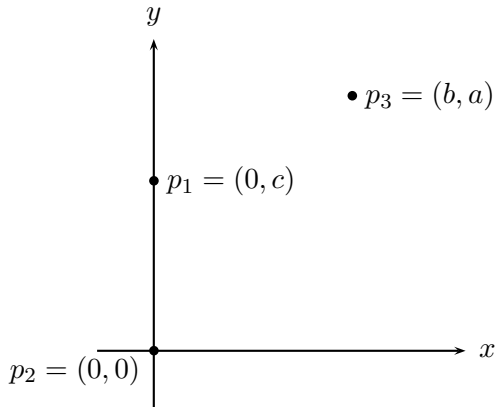

Figure 8: Embedding of a three-point metric space with side-lengths a, b, c in \mathbb{R}_∞^2

Now consider the set $T \subseteq \mathbb{R}_\infty^2$ in Fig. 9 (where the bold segments are parallel to the diagonals).

T is a closed, geodesically convex set containing X and minimal with these properties. So, it is isometric to the tight span of X .

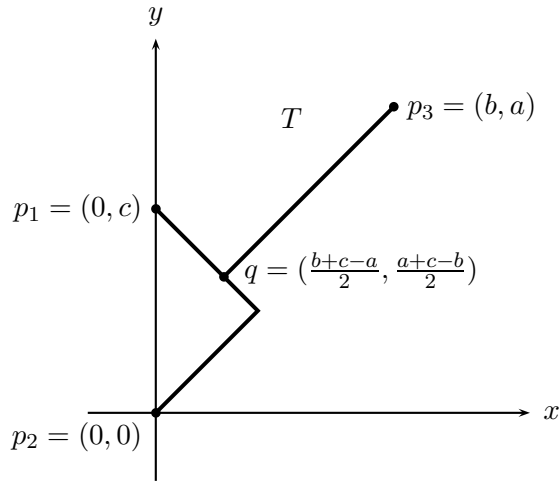

Figure 9: Tight span of the three-point metric space in Fig.8 inside \mathbb{R}_{∞}^2

Other realizations of the tight span of X could be, for example the set S in Fig. 10, or U in Fig. 11, since S and U are also closed, geodesically convex and minimal sets containing X . Obviously T , S and U are isometric spaces (as they should be, since they are tight spans of X).

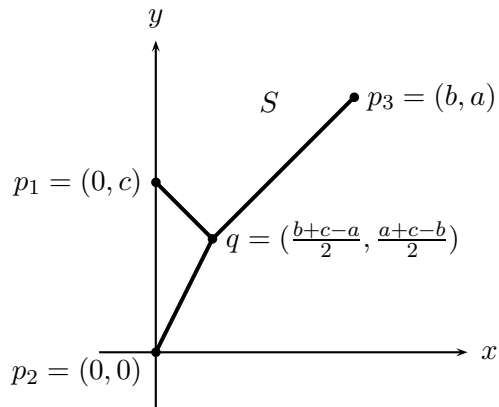

Figure 10: Another (isometric) tight span of the same three-point metric space inside \mathbb{R}_{∞}^2

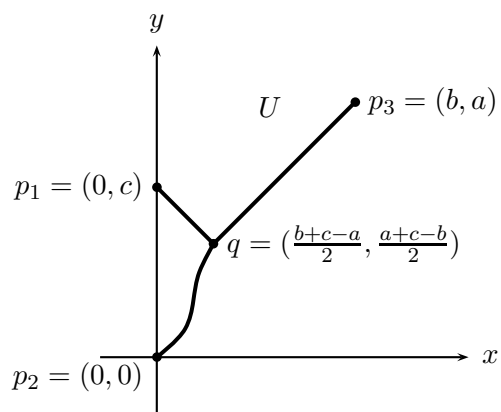

Figure 11: Still another (isometric) tight span of the same three-point metric space inside \mathbb{R}_∞^2

Example 2 *Tight span of a four point metric space $X = \{P_1, P_2, P_3, P_4\}$ with distances as shown in Fig. 12.*

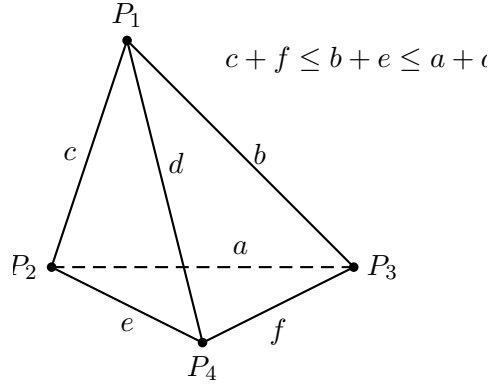

Figure 12: A four-point metric space

We can always arrange (by renaming the points) that the inequalities $c + f \leq b + e \leq a + d$ hold. This space can be embedded into \mathbb{R}_∞^2 , e.g. as in Fig. 13.

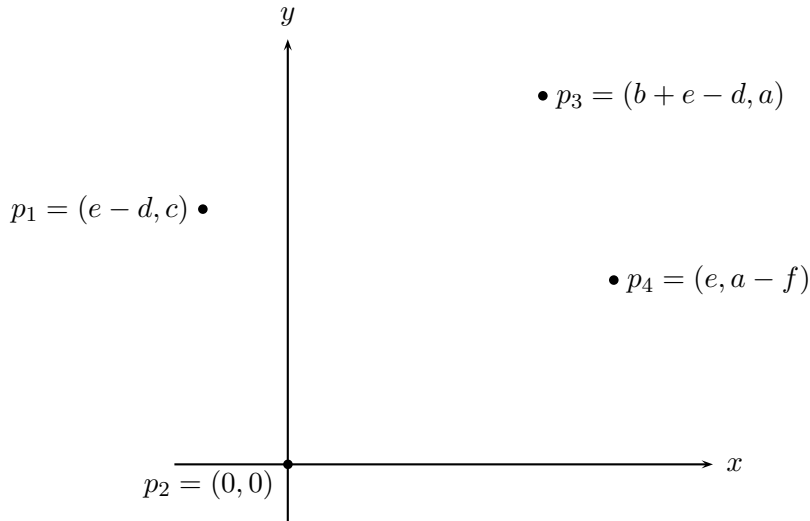

Figure 13: Embedding of the four-point metric space in Fig.12 in \mathbb{R}_∞^2

Now consider the set $T \subseteq \mathbb{R}_\infty^2$ in Fig. 14 (where the bold segments are parallel to the diagonals).

T is a closed, geodesically convex set containing X and minimal with these proper-

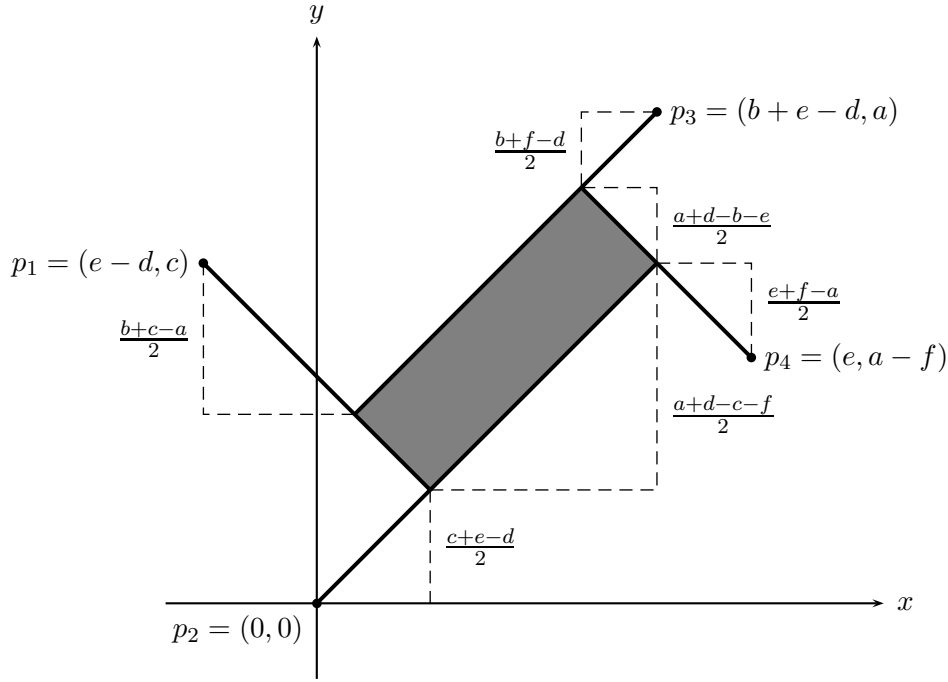

Figure 14: Tight span of the four-point metric space in Fig.13 inside \mathbb{R}_{∞}^2

ties. So, it is isometric to the tight span of X .

Example 3 In this sample of examples we show the tight spans of some infinite subsets of \mathbb{R}_{∞}^2 (see the Figs. 15-20). In each case, by Theorem 2, it is enough to see that the corresponding spaces T_i are closed, geodesically convex subspaces containing the given spaces X_i and minimal with these properties. During checking these properties one should bear in mind that for two points on a line parallel to a diagonal, there exists a unique geodesic between these points and it is the segment between these points.

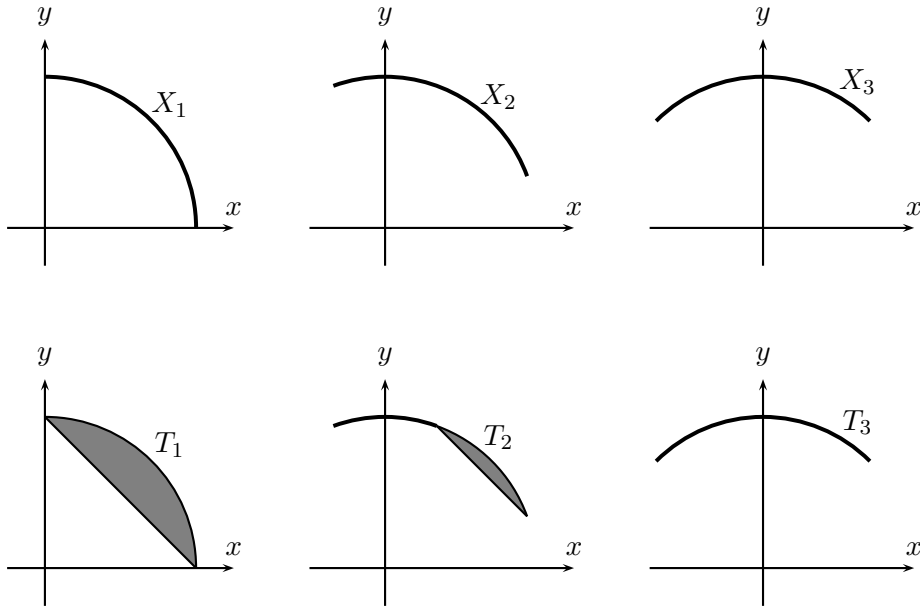

Figure 15: Three subsets X_1, X_2 and $X_3 \subset \mathbb{R}_{\infty}^2$ and their tight spans T_1, T_2 and T_3

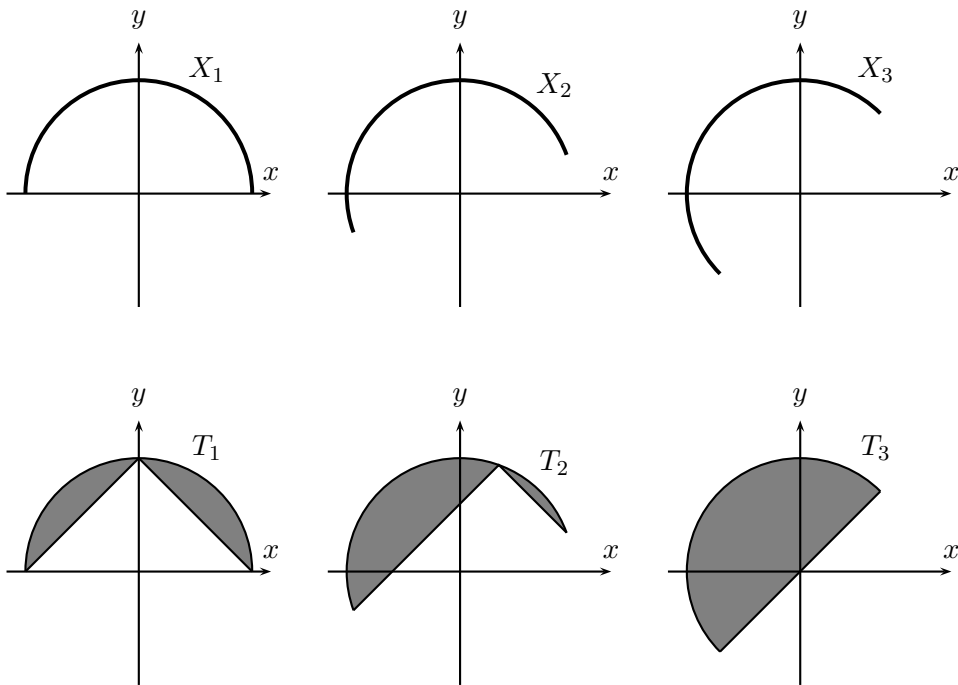

Figure 16: Three subsets X_1, X_2 and $X_3 \subset \mathbb{R}_{\infty}^2$ and their tight spans T_1, T_2 and T_3

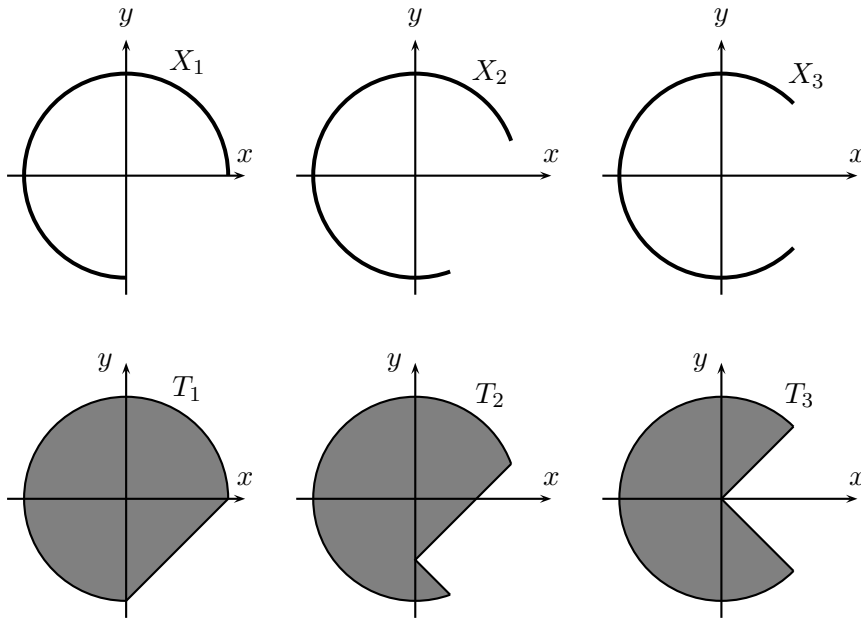

Figure 17: Three subsets X_1, X_2 and $X_3 \subset \mathbb{R}^2_\infty$ and their tight spans T_1, T_2 and T_3

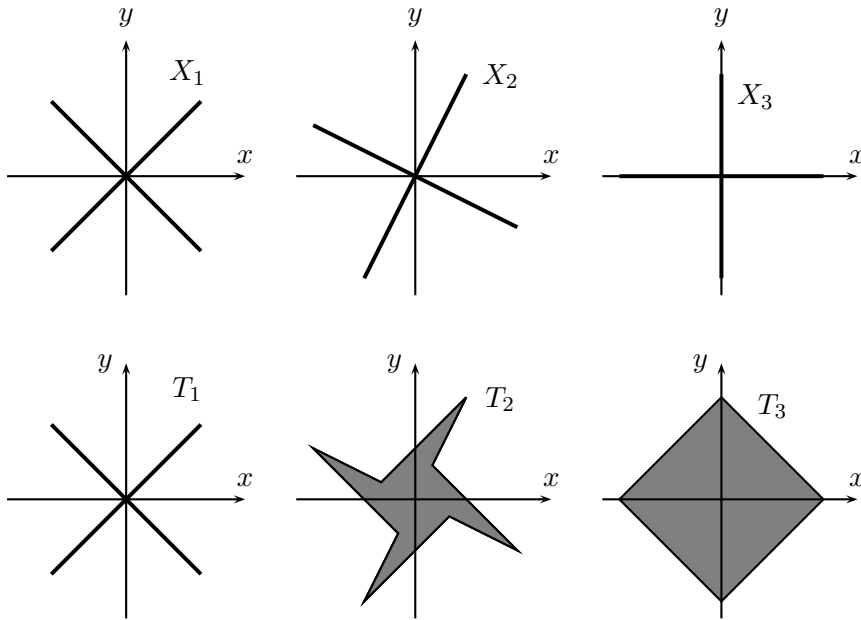

Figure 18: Three subsets X_1, X_2 and $X_3 \subset \mathbb{R}^2_\infty$ and their tight spans T_1, T_2 and T_3

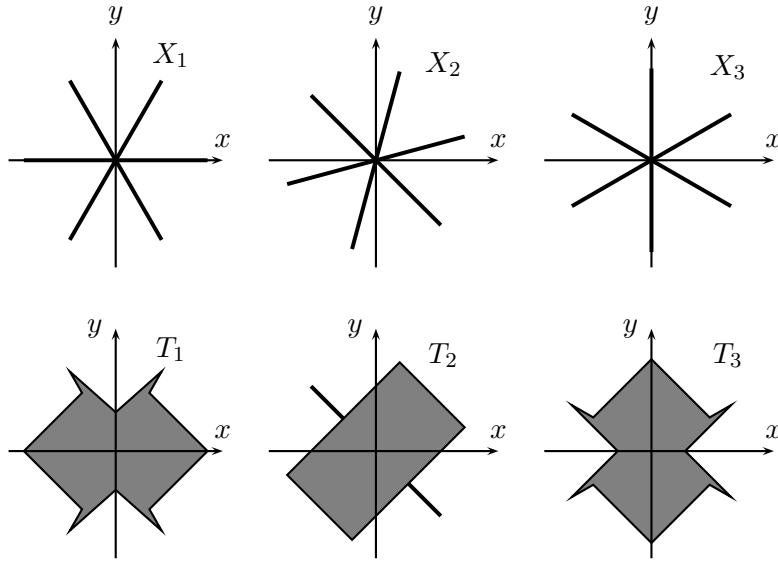

Figure 19: Three subsets X_1, X_2 and $X_3 \subset \mathbb{R}_{\infty}^2$ and their tight spans T_1, T_2 and T_3

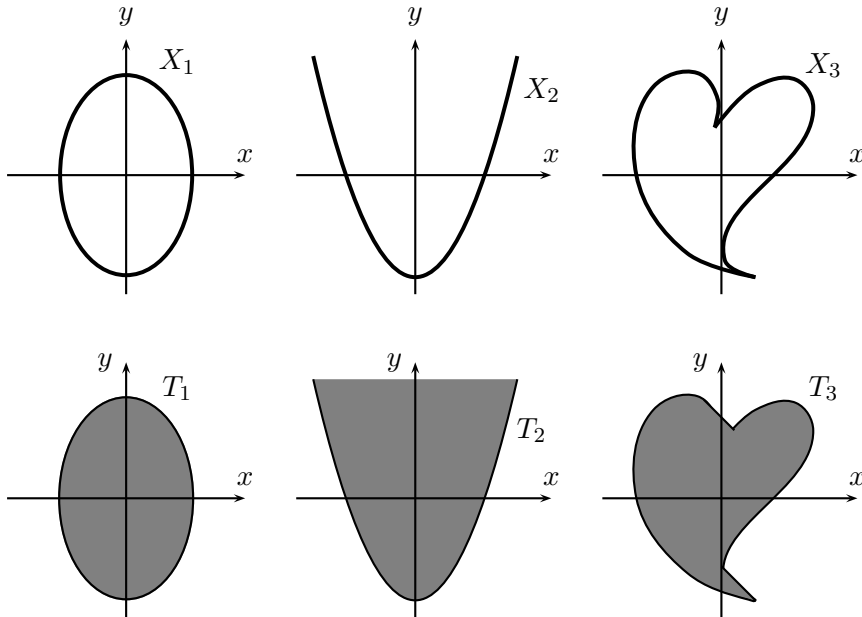

Figure 20: Three subsets X_1, X_2 and $X_3 \subset \mathbb{R}_{\infty}^2$ and their tight spans T_1, T_2 and T_3

4 What about \mathbb{R}_∞^n ?

It is tempting to hope that the Theorem 2 would hold \mathbb{R}_∞^n for $n \geq 3$ also. This is however unfortunately not true as we show in Example 5 below. The main reason is that, Theorem 3, on which the Theorem 2 is based, is not true either.

Example 4 *The plane $L = \{(x, y, z) \mid x + y + z = 0\} \subseteq \mathbb{R}_\infty^3$ with the induced metric is not hyperconvex. So a nonempty, closed and geodesically convex subspace of \mathbb{R}_∞^3 need not be hyperconvex.*

To see this, note that the discs around a point in L are regular hexagons (see Fig. 21) and they don't satisfy the hyperconvexity condition (see Fig. 22).

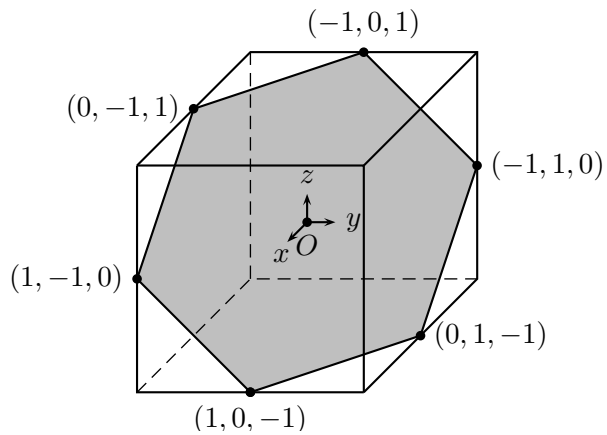

Figure 21: hexagonal slice of a cube

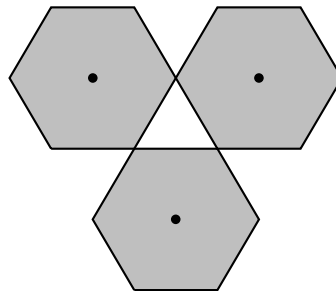

Figure 22: Pairwise intersecting hexagons with empty intersection

Example 5 Let $X = \{A = (1, 1, 1), B = (1, -2, -2), C = (-1, 0, 1)\} \subseteq \mathbb{R}_\infty^3$. Then the set Y shown in Fig. 23 is a closed, geodesically convex subspace containing X and minimal with these properties. But Y is not isometric to the tight span $T(X)$ of X . ($T(X)$ is the union of the segments $[AO] \cup [BO] \cup [CO] \subset \mathbb{R}_\infty^3$.)

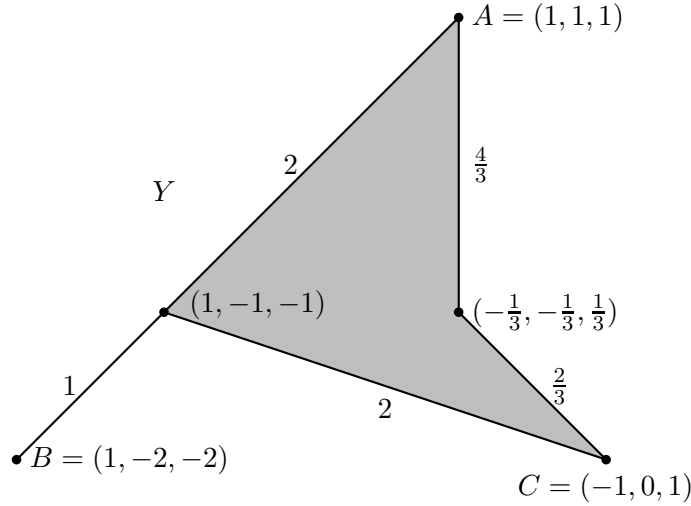

Figure 23: A counterexample in \mathbb{R}_∞^3

5 Appendix

Proof. (of Lemma 1)

A complete metric space (X, d) is strictly intrinsic if for every $x, y \in X$ there exists a midpoint i.e. a point $z \in X$ such that $d(x, z) = d(z, y) = \frac{1}{2}d(x, y)$ (see [3], Theorem 2.4.16). Since a hyperconvex metric space is complete, so it will be enough to show that midpoints exist. Assume to the contrary that for some $x, y \in X$ no midpoint exists. Now consider an external point $z \notin X$ and define on $X \cup \{z\}$ a metric satisfying $d(x, z) = d(y, z) = \frac{1}{2}d(x, y)$ (to achieve this the Lemma 5 below can be used taking $Y = \{x, y, z\}$). The hyperconvex metric space (X, d) is injective and hence there exists a nonexpansive retraction $r : X \cup \{z\} \rightarrow X$. Now, consider the point $r(z) = z' \in X$. By nonexpansiveness we get

$$d(x, z') \leq d(x, z) = \frac{1}{2}d(x, y)$$

and

$$d(z', y) \leq d(z, y) = \frac{1}{2}d(x, y),$$

which show that z' is a midpoint of x and y contradicting our assumption. ■

Proof. (of Lemma 2)

If one of the points p or q belongs to the set $S_1^\varepsilon(u) \cap S_2^\delta(u) = I^{\varepsilon\delta}(u)$, then we are done. So, let us assume $p \in S_1^\varepsilon(u) \setminus I^{\varepsilon\delta}(u)$ and $q \in S_2^\delta(u) \setminus I^{\varepsilon\delta}(u)$. In that case $D_{pq} \setminus I^{\varepsilon\delta}(u)$ becomes a disconnected set, since $D_{pq} \cap S_1^\varepsilon(u)^\circ$ and $D_{pq} \cap S_2^\delta(u)^\circ$ give a disjoint decomposition of this set. The points p and q belong to different components of $D_{pq} \setminus I^{\varepsilon\delta}(u)$ and hence there must be some t with $\gamma(t) \in I^{\varepsilon\delta}(u)$. ■

Proof. (of Lemma 3)

Let $a_1 \in S_1^+(p)$ and $a_2 \in S_2^+(p)$ be points on A . Since A is geodesically convex there exist a geodesic γ inside A connecting a_1 and a_2 . According to Lemma 2 there exist a t_0 with $\gamma(t_0) \in I^{++}(p) \cap A$. If $a_3 \in S_1^-(p)$ and $a_4 \in S_2^-(p)$ are points on A then there exist a geodesic α inside A connecting these points and a t_1 with $\alpha(t_1) \in I^{--}(p) \cap A$. So, we can write $\gamma(t_0) = (p_1 + t, p_2 + t)$ and $\alpha(t_1) = (p_1 - k, p_2 - k)$ for some $t, k \geq 0$. As the only geodesic connecting the points $\gamma(t_0)$ and $\alpha(t_1)$ is the segment $[\gamma(t_0), \alpha(t_1)]$, we get $p \in A$. ■

Proof. (of Lemma 4)

Assume $p \notin A$. Then $S_i^+(p) \cap A$ and $S_i^-(p) \cap A$ constitute a disjoint and open decomposition of A contradicting the connectivity of A . ■

Lemma 5 *Let (X, d_X) and (Y, d_Y) be metric spaces with $X \cap Y \neq \emptyset$, and assume $d_X|_{X \cap Y} = d_Y|_{X \cap Y}$. Then there exists a metric d on $X \cup Y$, such that $d|_X = d_X$ and $d|_Y = d_Y$.*

Proof. One can take, for example,

$$d(x, y) := \inf_{u \in X \cap Y} \{d(x, u) + d(u, y)\}$$

■

References

- [1] I. Althöfer, On Optimal Realizations of Finite Metric Spaces by Graphs, *Discrete Comput. Geom.* 3, 103-122, 1988.
- [2] N. Aronszajn, P. Panitchpakdi, Extension of uniformly continuous transformations and hyperconvex metric spaces, *Pacific J. Math.* 6 (1956), 405–439.
- [3] D. Burago, Y. Burago, S. Ivanov, *A Course in Metric Geometry*, Graduate Studies in Mathematics, American Mathematical Society, USA, 2001.

- [4] A. Dress, Trees, tight extensions of metric spaces, and the cohomological dimension of certain groups: A note on combinatorial properties of metric spaces, *Advances in Mathematics* 53 (1984), 321–402.
- [5] D. Eppstein, Optimally fast incremental Manhattan plane embedding and planar tight span construction, *Journal of Computational Geometry* 2(1) (2011), 144–182.
- [6] D. Eppstein, personal communication.
- [7] R. Espinola, M.A. Khamsi (Eds. W.A. Kirk and B. Sims), Introduction to Hyperconvex Spaces, *Handbook of Metric Fixed Point Theory*, Kluwer Academic Publishers, Dordrecht, 2001.
- [8] J. R. Isbell, Six theorems about injective metric spaces, *Comment. Math. Helvetici* 39 (1964), 65–76.
- [9] M.A. Khamsi, W.A. Kirk, *An Introduction to Metric Spaces and Fixed Point Theory*, John Wiley, New York, 2001.
- [10] J. Koolen, A. Lesser, V. Moulton, Optimal realizations of generic five-point metrics, *European J. of Combin.*, 30, 1164–1171, 2009.
- [11] A. Papadopoulos, *Metric Spaces, Convexity and Nonpositive Curvature*, *Irma Lectures in Mathematics and Theoretical Physics*, European Mathematical Society, Germany, 2005.
- [12] B. Sturmfels, J. Yu, Classification of six-point metrics, *Electron. J. of Combin.*, 11, 2004, R44.