

GENERATORS OF THE SISTER OF EUCLIDEAN PICARD MODULAR GROUP

BAOHUA XIE

ABSTRACT. The sister of Eisenstein-Picard modular group was described in [8]. In this paper we give a similar definition of the sister of the Euclidean-Picard modular group and find its generators by using a geometric method.

1. INTRODUCTION

An important and difficult problem in complex hyperbolic geometry is to determine the generators systems and finite presentations for the lattices in $\mathbf{PU}(2, 1)$. The most frequent method is to construct a fundamental domain and use the Poincaré's polyhedron theorem. It should be pointed out that, even though fundamental domains of arithmetic lattices are well known to exist, their explicit determination in the context of the non-constant curvature setting of complex hyperbolic space is a difficult task. There is also a simple algorithm for one to get the generators of some lattices. In particular, we do not need to know the fundamental domain for the action of lattice on the complex hyperbolic plane. See the works [5, 13, 14]. However, it is hard to get more information of the lattices by this method.

There are not so many examples of explicit arithmetic lattices or non-arithmetic lattices of $\mathbf{PU}(2, 1)$. See, for example, the works of Mostow[7], Falbel and Parker[3], Parker[9], Deraux, Falbel and Paupert[1], Deraux, Parker and Paupert[2]. Perhaps the first example for the complex hyperbolic space in two complex dimensions was due to Picard [11, 12], which we now call Picard modular group.

Let \mathcal{O}_d be the ring of integers in the quadratic imaginary number field $\mathbb{Q}(i\sqrt{d})$, where d is a positive square-free integer. If $d \equiv 1, 2 \pmod{4}$, then $\mathcal{O}_d = \mathbb{Z}[i\sqrt{d}]$ and if $d \equiv 3 \pmod{4}$, then $\mathcal{O}_d = \mathbb{Z}[\omega_d]$, where $\omega_d = (1 + i\sqrt{d})/2$. The Picard modular groups are subgroups of $\mathbf{PU}(2, 1)$ with entries in \mathcal{O}_d and written $\mathbf{PU}(2, 1; \mathcal{O}_d)$. The Picard modular groups $\mathbf{PU}(2, 1; \mathcal{O}_d)$ can be considered as the natural algebraic generalization of the classical modular group $\mathbf{PSL}(2, \mathbb{Z})$.

For $d = 1, 2, 3, 7, 11$ the rings \mathcal{O}_d have Euclidean algorithms and the corresponding groups $\Gamma^{(d)} = \mathbf{PU}(2, 1; \mathcal{O}_d)$ are the Euclidean Picard modular groups. As is to be expected, these are much closer in properties to the modular group than in the non-Euclidean cases. Of particular interest are the group $\Gamma^{(1)}$ and $\Gamma^{(3)}$, which are called the Gauss-Picard modular group and the Eisenstein-Picard modular group. However, the explicit algebraic or geometric properties such as generators, fundamental domains and presentations are still unknown in all but very few cases. More specifically, presentation and fundamental domains have been obtained for

2010 *Mathematics Subject Classification.* 32M05, 22E40; Secondary 32M15.

Key words and phrases. Complex hyperbolic space, Generators, Picard modular groups.

$\Gamma^{(d)}$ when $d = 1$ and $d = 3$. More recently, generators for $\mathbf{PU}(2, 1; \mathcal{O}_d)$ with $d = 2, 7, 11$ were given in [17].

In this paper, we will use the geometric arguments in [3, 15, 17] to obtain the generators of the sister of some Euclidean-Picard modular groups. In [8], the sister of the Einsenstein-Picard modular group $\mathbf{PU}(2, 1; \mathcal{O}_3)$ was defined explicitly. It's fundamental domain and generators was obtained in [16]. Similarly, we can also define the sister of the other Picard modular groups. Let $\Gamma_s^{(d)}$ be the sister of Euclidean Picard modular groups $\mathbf{PU}(2, 1; \mathcal{O}_d)$. We claim that the same feature shared by Euclidean Picard modular groups is that the quotient $\mathbf{H}_{\mathbb{C}}^2/\Gamma_s^{(d)}$ has only one cusp. This is achieved by showing that $\Gamma^{(d)}$ and $\Gamma_s^{(d)}$ has a subgroup with the same finite index.

We will start with finding suitable generators of the stabilizer of infinity of $\Gamma_s^{(d)}$ and then construct a fundamental domain for the stabilizer acting on the boundary of complex hyperbolic space. We also obtain a presentation of the isotropy subgroup fixing infinity by analyzing the combinatorics of the fundamental domain. Finally, we will determine some isometric spheres such that the intersection of these isometric spheres and the fundamental domain for the stabilizer has one cusp.

Our main results are the following three theorems.

Theorem 1.1. *The group $\Gamma_s^{(2)}$ is generated by the elements*

$$I_0^{(2)} = \begin{bmatrix} 0 & 0 & i/\sqrt{2} \\ 0 & 1 & 0 \\ i\sqrt{2} & 0 & 0 \end{bmatrix}, R_1^{(2)} = \begin{bmatrix} 1 & 0 & 0 \\ 0 & -1 & 0 \\ 0 & 0 & 1 \end{bmatrix}, R_2^{(2)} = \begin{bmatrix} 1 & 2 & -2 \\ 0 & -1 & 2 \\ 0 & 0 & 1 \end{bmatrix},$$

$$R_3^{(2)} = \begin{bmatrix} 1 & -i\sqrt{2} & -1 \\ 0 & -1 & i\sqrt{2} \\ 0 & 0 & 1 \end{bmatrix} \quad \text{and} \quad T^{(2)} = \begin{bmatrix} 1 & 0 & i/\sqrt{2} \\ 0 & 1 & 0 \\ 0 & 0 & 1 \end{bmatrix}.$$

Theorem 1.2. *The group $\Gamma_s^{(7)}$ is generated by the elements*

$$I_0^{(7)} = \begin{bmatrix} 0 & 0 & i/\sqrt{7} \\ 0 & 1 & 0 \\ i\sqrt{7} & 0 & 0 \end{bmatrix}, R_1^{(7)} = \begin{bmatrix} 1 & 0 & 0 \\ 0 & -1 & 0 \\ 0 & 0 & 1 \end{bmatrix}, R_2^{(7)} = \begin{bmatrix} 1 & 1 & i\omega_7/\sqrt{7} \\ 0 & -1 & 1 \\ 0 & 0 & 1 \end{bmatrix},$$

$$R_3^{(7)} = \begin{bmatrix} 1 & \overline{\omega}_7 & -1 \\ 0 & 1 & \omega_7 \\ 0 & 0 & 1 \end{bmatrix} \quad \text{and} \quad T^{(7)} = \begin{bmatrix} 1 & 0 & i/\sqrt{7} \\ 0 & 1 & 0 \\ 0 & 0 & 1 \end{bmatrix}.$$

Theorem 1.3. *The group $\Gamma_s^{(11)}$ is generated by the elements*

$$I_0^{(11)} = \begin{bmatrix} 0 & 0 & i/\sqrt{11} \\ 0 & 1 & 0 \\ i\sqrt{11} & 0 & 0 \end{bmatrix}, R_1^{(11)} = \begin{bmatrix} 1 & 0 & 0 \\ 0 & -1 & 0 \\ 0 & 0 & 1 \end{bmatrix}, R_2^{(11)} = \begin{bmatrix} 1 & 1 & i\omega_{11}/\sqrt{11} \\ 0 & -1 & 1 \\ 0 & 0 & 1 \end{bmatrix},$$

$$R_3^{(11)} = \begin{bmatrix} 1 & \overline{\omega}_{11} & -3/2 + i/2\sqrt{11} \\ 0 & -1 & \omega_{11} \\ 0 & 0 & 1 \end{bmatrix} \quad \text{and} \quad T^{(11)} = \begin{bmatrix} 1 & 0 & i/\sqrt{11} \\ 0 & 1 & 0 \\ 0 & 0 & 1 \end{bmatrix}.$$

2. COMPLEX HYPERBOLIC SPACE

2.1. The Siegel domain. A general reference for complex hyperbolic geometry is [6]. Let $\mathbb{C}^{2,1}$ denote the complex vector space of dimension 3, equipped with a non-degenerate Hermitian form of signature $(2, 1)$. There are several such forms. If we use the second Hermitian form on $\mathbb{C}^{2,1}$, for column vectors $\mathbf{z} = (z_1, z_2, z_3)^t$ and $\mathbf{w} = (w_1, w_2, w_3)^t$,

$$\langle \mathbf{z}, \mathbf{w} \rangle = \mathbf{w}^* J \mathbf{z} = z_1 \overline{w_3} + z_2 \overline{w_2} + z_3 \overline{w_1},$$

where

$$J = \begin{pmatrix} 0 & 0 & 1 \\ 0 & 1 & 0 \\ 1 & 0 & 0 \end{pmatrix}$$

and \mathbf{w}^* is the Hermitian transpose of \mathbf{w} .

The projective model of complex hyperbolic space $\mathbf{H}_{\mathbb{C}}^2$ is defined to be the collection of negative lines in $\mathbb{C}^{2,1}$, namely, those points \mathbf{z} satisfying $\langle \mathbf{z}, \mathbf{z} \rangle < 0$.

We mainly take the *Siegel domain* \mathfrak{S} as a upper half-space model for the complex hyperbolic space, that is given by

$$\mathfrak{S} = \{(z_1, z_2) \in \mathbb{C}^2 : 2\Re z_1 + |z_2|^2 < 0\}.$$

The boundary of the *Siegel domain* \mathfrak{S} is identified with the one-point compactification of the Heisenberg group. The Heisenberg group \mathfrak{H} is $\mathbb{C} \times \mathbb{R}$ with the group law

$$(\zeta_1, t_1) \diamond (\zeta_2, t_2) = (\zeta_1 + \zeta_2, t_1 + t_2 + 2\Im(\zeta_1 \bar{\zeta}_2)).$$

There is a canonical projection from \mathfrak{H} to \mathbb{C} called *vertical projection* and denoted by Π , given by $\Pi : (\zeta, t) \mapsto \zeta$.

The Cygan metric on \mathfrak{H} is given by

$$\rho_0((\zeta_1, t_1), (\zeta_2, t_2)) = \left| |\zeta_1 - \zeta_2|^2 - it_1 + it_2 - 2i\Im(\zeta_1 \bar{\zeta}_2) \right|.$$

We can extend the Cygan metric to an incomplete metric on $\bar{\mathfrak{S}} - \{\infty\}$ as follows

$$\tilde{\rho}_0((\zeta_1, t_1, u_1), (\zeta_2, t_2, u_2)) = \left| |\zeta_1 - \zeta_2|^2 + |u_1 - u_2| - it_1 + it_2 - 2i\Im(\zeta_1 \bar{\zeta}_2) \right|.$$

Any point $\mathbf{p} \in \mathfrak{S}$ admits a unique lift to $\mathbb{C}^{2,1}$ of the following form, called its standard lift

$$(1) \quad \mathbf{p} = \begin{bmatrix} (-|\zeta|^2 - u + it)/2 \\ \zeta \\ 1 \end{bmatrix}$$

with $(\zeta, t, u) \in \mathbb{C} \times \mathbb{R} \times]0, \infty[$. In particular,

$$q_\infty = \begin{bmatrix} 1 \\ 0 \\ 0 \end{bmatrix}.$$

Then the triple (ζ, t, u) is called the horospherical coordinates of \mathbf{p} and $\mathfrak{S} = \mathfrak{H} \times \mathbb{R}_+$ and $\partial\mathfrak{S} = (\mathfrak{H} \times \{0\}) \cup \{q_\infty\}$.

2.2. Complex hyperbolic isometries. Let $\mathbf{U}(2, 1)$ be the group of matrices that are unitary with respect to the form $\langle \cdot, \cdot \rangle$. The group of holomorphic isometries of complex hyperbolic space is the projective unitary group $\mathbf{PU}(2, 1) = \mathbf{U}(2, 1)/\mathbf{U}(1)$, with a natural identification $\mathbf{U}(1) = \{e^{i\theta}I, \theta \in [0, 2\pi)\}$. We now describe the action of the stabilizer of q_∞ on the Heisenberg group.

The Heisenberg group acts on itself by *Heisenberg translations*. For $(\tau, v) \in \mathfrak{A}$, this is

$$T_{(\tau, v)} : (z, t) \mapsto (z + \tau, t + v + 2\Im(\tau\bar{z})) = (\tau, v) \diamond (z, t).$$

Heisenberg translation by $(0, v)$ for any $v \in \mathbb{R}$ is called *vertical translation* by v .

The unitary group $\mathbf{U}(1)$ acts on the Heisenberg group by *Heisenberg rotations*. For $e^{i\theta} \in \mathbf{U}(1)$, the rotation fixing $q_0 = (0, 0, 0)$ is given by

$$R_\theta : (z, t) \mapsto (e^{i\theta}z, t).$$

For $r \in \mathbb{R}_+$, *Heisenberg dilation* by r fixing q_∞ and $q_0 = (0, 0, 0) \in \partial\mathbf{H}_\mathbb{C}^2$ is given by

$$D_r : (z, t) \mapsto (rz, r^2t).$$

The stabilizer of q_∞ in $\mathbf{PU}(2, 1)$ is generated by all Heisenberg translations, rotations and dilations. The matrices of the 3 kinds of isometries are

$$T_{(z, t)} = \begin{bmatrix} 1 & -\bar{z} & -(|z|^2 - it)/2 \\ 0 & 1 & z \\ 0 & 0 & 1 \end{bmatrix}, R_\theta = \begin{bmatrix} 1 & 0 & 0 \\ 0 & e^{i\theta} & 0 \\ 0 & 0 & 1 \end{bmatrix}, D_r = \begin{bmatrix} r & 0 & 0 \\ 0 & 1 & 0 \\ 0 & 0 & 1/r \end{bmatrix}.$$

Note that Heisenberg translations and rotations preserve each horosphere based at q_∞ , whereas Heisenberg dilations permute horosphere based at q_∞ . For this reason the group generated by all Heisenberg translations and rotations, which is the semidirect product $\mathbf{U}(1) \ltimes \mathfrak{A}$, is called the *Heisenberg isometry group* $Isom(\mathfrak{A})$. In addition, the group $Isom(\mathfrak{A})$ consists exactly of those matrices of the following form:

$$\begin{bmatrix} 1 & -\bar{z}e^{i\theta} & -(|z|^2 - it)/2 \\ 0 & e^{i\theta} & z \\ 0 & 0 & 1 \end{bmatrix}.$$

Recall from [3] that the exact sequence

$$0 \longrightarrow \mathbb{R} \longrightarrow \mathfrak{A} \xrightarrow{\Pi} \mathbb{C} \longrightarrow 0,$$

induces the exact sequence

$$(2) \quad 0 \longrightarrow \mathbb{R} \longrightarrow Isom(\mathfrak{A}) \xrightarrow{\Pi_*} Isom(\mathbb{C}) \longrightarrow 1.$$

Explicitly, $\Pi_*(Isom(\mathfrak{A})) = \begin{bmatrix} e^{i\theta} & \zeta_0 \\ 0 & 1 \end{bmatrix}$, acting on \mathbb{C} by $w \rightarrow e^{i\theta}w + z$ and $Ker(\Pi_*)$ consist of Heisenberg vertical translation.

2.3. Isometric spheres. Given an element $G \in \mathbf{PU}(2, 1)$ satisfying $G(q_\infty) \neq q_\infty$, we define the isometric sphere of G to be the hypersurface

$$\{\mathbf{z} \in \mathbf{H}_\mathbb{C}^2 : |\langle \mathbf{z}, q_\infty \rangle| = |\langle \mathbf{z}, G^{-1}(q_\infty) \rangle|\}.$$

We often consider spheres with respect to the Cygan metric. The Cygan sphere of radius $r \in \mathbb{R}_+$ and centre $(z_0, t_0, 0) \in \mathfrak{A}$ is given by

$$\{(z, t, u) \in \mathbf{H}_\mathbb{C}^2 : |z - z_0|^2 + u + it - it_0 + 2i\Im(z\bar{z}_0)\} = r^2\}.$$

Note that Cygan spheres are always convex.

If $G \in \mathbf{PU}(2, 1)$ has the matrix form

$$(3) \quad \begin{bmatrix} z_{11} & z_{12} & z_{13} \\ z_{21} & z_{22} & z_{23} \\ z_{31} & z_{32} & z_{33} \end{bmatrix},$$

then $G(q_\infty) \neq q_\infty$ if and only if $z_{31} \neq 0$. The isometric sphere of G is a Cygan sphere of radius $r = \sqrt{2/|z_{31}|}$ and centre $G^{-1}(q_\infty)$, which in horospherical coordinates is

$$(z_0, t_0, 0) = (z_{32}/z_{31}, 2\Im(z_{33}/z_{31}), 0).$$

3. THE SISTER GROUPS OF PICARD MODULAR GROUPS

Let \mathcal{O}_d be the ring of integers in the quadratic imaginary number field $\mathbb{Q}(i\sqrt{d})$, where d is a positive square-free integer. If $d \equiv 1, 2 \pmod{4}$, then $\mathcal{O}_d = \mathbb{Z}[i\sqrt{d}]$ and if $d \equiv 3 \pmod{4}$, then $\mathcal{O}_d = \mathbb{Z}[\omega_d]$, where $\omega_d = (1 + i\sqrt{d})/2$. The group $\Gamma^{(d)} = \mathbf{PU}(2, 1; \mathcal{O}_d)$ is called *Euclidean Picard modular group* if the ring \mathcal{O}_d is Euclidean, namely, the rings $\mathcal{O}_1, \mathcal{O}_2, \mathcal{O}_3, \mathcal{O}_7, \mathcal{O}_{11}$.

The sister of the Eisenstein-Picard modular group $\mathbf{PU}(2, 1; \mathcal{O}_3)$ was defined explicitly in [?]. In fact, we find that the similar definition of sister groups can be extended to the other Picard modular groups. In this paper, we will only consider the case $d = 2, 7, 11$. Let $\Gamma_s^{(d)}$ be the collection of all elements of $\mathbf{PU}(2, 1)$ that, when written in the form (3), have $z_{11}, z_{12}, z_{13}(i\sqrt{d}), z_{21}/(i\sqrt{d}), z_{22}, z_{23}, z_{31}/(i\sqrt{d})$, and z_{33} all in \mathcal{O}_d . That is, in the case of $d = 3 \pmod{4}$

- (a) $z_{13} = x_{13}/2 + iy_{13}/2\sqrt{d}$, where x_{13} and y_{13} are integers of the same parity;
- (b) $z_{jk} = x_{jk}/2 + i\sqrt{d}y_{jk}/2$ for all other jk , where x_{jk} and y_{jk} are integers of the same parity;
- (c) x_{21}, x_{31}, x_{32} are all divisible by d
and in the case of $d = 2 \pmod{4}$
- (a) $z_{13} = x_{13} + iy_{13}/\sqrt{2}$, where x_{13} and y_{13} are integers;
- (b) x_{21}, x_{31}, x_{32} are all divisible by 2.

It is simple to check that $\Gamma_s^{(d)}$ is a group. It is also discrete as \mathcal{O}_d is discrete in \mathbb{C} . We will show that the sister groups $\Gamma_s^{(d)}$ defined above commensurable with the Picard modular group $\Gamma^{(d)}$. Let $H^{(d)} = \Gamma_s^{(d)} \cap \Gamma^{(d)}$ be the intersection of $\Gamma_s^{(d)}$ and $\Gamma^{(d)}$. One will see that $H^{(d)}$ has the same index in $\Gamma_s^{(d)}$ and $\Gamma^{(d)}$. We will prove this for $d = 2, 7, 11$ case by case.

For the case $d = 2$, we have

Lemma 3.1. $H^{(2)}$ has index three in $\Gamma_s^{(2)}$ and $\Gamma^{(2)}$.

Proof. First, we note that $H^{(2)}$ consists of all matrices in $\mathbf{PU}(2, 1)$, which written in the form (3), have $z_{jk} = x_{jk} + i\sqrt{2}y_{jk}$, where x_{jk} and y_{jk} are integers and also x_{21}, x_{31} , and x_{32} are all divisible by 2.

We decompose $\Gamma_s^{(2)}$ and $\Gamma^{(2)}$ into three $H^{(2)}$ -cosets as follows. We claim that

$$\Gamma^{(2)} = H^{(2)} \cup g_1 H^{(2)} \cup g_2 H^{(2)}$$

where

$$g_1 = \begin{bmatrix} 0 & 0 & 1 \\ 0 & -1 & 0 \\ 1 & 0 & 0 \end{bmatrix}, g_2 = \begin{bmatrix} 1 & 0 & 0 \\ -i\sqrt{2} & -1 & 0 \\ -1 & i\sqrt{2} & 1 \end{bmatrix}.$$

Let $g \in \Gamma^{(2)}$ be written in the form (3). As $g \in \mathbf{PU}(2, 1)$, we have

$$(4) \quad \overline{z_{11}}z_{31} + z_{11}\overline{z_{31}} + |z_{21}|^2 = 0$$

and

$$(5) \quad \overline{z_{31}}z_{33} + z_{31}\overline{z_{33}} + |z_{32}|^2 = 0.$$

Writing out z_{jk} in terms of real and imaginary parts in (5), (6) and considering congruence modulo 2, we obtain

$$(6) \quad x_{21}^2 = -x_{11}x_{31} \pmod{2}$$

and

$$(7) \quad x_{32}^2 = -x_{31}x_{33} \pmod{2}.$$

We need to show that for all $g = (z_{jk})$ in $\Gamma^{(2)}$ there is an $m \in \{0, 1, 2\}$ so that $g_m^{-1}g = (z'_{jk})$ is in $H^{(2)}$ (g_0 is the identity). In other words, x'_{21}, x'_{31} , and x'_{32} are all divisible by 2. We begin by finding $g_m^{-1}g$ so that $2 \mid x'_{21}, 2 \mid x'_{31}$. This is sufficient since from (8), we see that if $2 \mid x'_{31}$, then so is x'_{32} .

If $2 \mid x_{21}$, then from (8) we see that either x_{31} or x_{11} is also divisible by 2. In the first case g has $2 \mid x_{21}$ and $2 \mid x_{31}$ as required. Now $g_1^{-1}g$ has $x'_{21} = -x_{21}$ and $x'_{31} = x_{11}$. Thus if $2 \mid x_{21}$ and $2 \mid x_{11}$, then $g_1^{-1}g$ has $2 \mid x'_{21}$ and $2 \mid x'_{31}$.

If $2 \nmid x_{21}$, then from (7) we see that x_{11} and x_{31} can not be divisible by 2 either. In other words, $x_{11} \equiv x_{21} \equiv 1 \pmod{2}$. One see that $g_2^{-1}g$ has $x'_{31} = -x_{11} - 2y_{21} + x_{31}$ divisible by 2.

Now we consider $\Gamma_s^{(2)}$. We claim that

$$\Gamma_s^{(2)} = H^{(2)} \cup g'_1 H^{(2)} \cup g'_2 H^{(2)}$$

where

$$g'_1 = \begin{bmatrix} 0 & 0 & i/\sqrt{2} \\ 0 & 1 & 0 \\ i\sqrt{2} & 0 & 0 \end{bmatrix}, g'_2 = \begin{bmatrix} 1 & 0 & i/\sqrt{2} \\ 0 & 1 & 0 \\ 0 & 0 & 1 \end{bmatrix}.$$

Write a general element of $\Gamma_s^{(2)}$ in the form (3), where $z_{13} = x_{13} + iy_{13}/\sqrt{2}$ and the other entries are as before. In order to show that an element of $\Gamma_s^{(2)}$ is in $H^{(2)}$, we must show that $2 \mid y_{13}$. If $2 \mid y_{13}$, then g is in $H^{(2)}$. If $2 \mid x_{33}$, then $g_1^{-1}g$ has $y'_{13} = -x_{33}$ divisible by 2. So it is in $H^{(2)}$. If $y_{13} \equiv x_{33} \equiv 1 \pmod{2}$. One see that $g_2^{-1}g$ has $y'_{13} = y_{13} - x_{33}$ divisible by 2. \square

For the case $d = 7, 11$, we have

Lemma 3.2. $H^{(d)}$ has index $d + 1$ both in $\Gamma_s^{(d)}$ and $\Gamma^{(d)}$.

Proof. First, we note that $H^{(d)}$ consists of all matrices in $\mathbf{PU}(2, 1)$, which written in the form (6), have $z_{jk} = x_{jk}/2 + i\sqrt{d}y_{jk}/2$, where x_{jk} and y_{jk} are integers of the same parity, and also x_{21}, x_{31} , and x_{32} are all divisible by d .

We decompose $\Gamma_s^{(d)}$ and $\Gamma^{(d)}$ into $d + 1$ $H^{(d)}$ -cosets as follows. We claim that

$$\Gamma^{(d)} = H^{(d)} \bigcup_{i=1}^d g_i H^{(d)}$$

where

$$g_1 = \begin{bmatrix} 0 & 0 & 1 \\ 0 & -1 & 0 \\ 1 & 0 & 0 \end{bmatrix}, g_{2k} = \begin{bmatrix} 1 & 0 & 0 \\ k & 1 & 0 \\ -k^2\omega_d & -k & 1 \end{bmatrix}, g_{2k+1} = \begin{bmatrix} 1 & 0 & 0 \\ -k & 1 & 0 \\ -k^2\omega_d & k & 1 \end{bmatrix}$$

where $k = 1, 2, \dots, (d-1)/2$.

Let $g \in \Gamma^{(d)}$ be written in the form (3). As $g \in \mathbf{PU}(2, 1)$, we have

$$(8) \quad \overline{z_{11}}z_{31} + z_{11}\overline{z_{31}} + |z_{21}|^2 = 0$$

and

$$(9) \quad \overline{z_{31}}z_{33} + z_{31}\overline{z_{33}} + |z_{32}|^2 = 0.$$

Writing out z_{jk} in terms of real and imaginary parts in (9), (10) and considering congruence modulo 7, we obtain

$$(10) \quad x_{21}^2 = (d-1)x_{11}x_{31} \pmod{d}$$

and

$$(11) \quad x_{32}^2 = (d-1)x_{31}x_{33} \pmod{d}.$$

We need to show that for all $g = (z_{jk})$ in $\Gamma^{(d)}$ there is an $m \in \{0, 1, 2, \dots, d\}$ so that $g_m^{-1}g = (z'_{jk})$ is in $H^{(d)}$ (g_0 is the identity). In other words, x'_{21}, x'_{31} , and x'_{32} are all divisible by d . We begin by finding $g_m^{-1}g$ so that x'_{21}, x'_{31} are divisible by d . This is sufficient since from (12), we see that if $d \mid x'_{31}$, then so is x'_{32} .

If $d \mid x_{21}$, then from (11) we see that either $d \mid x_{31}$ or $d \mid x_{11}$. In the first case g has $d \mid x_{21}$ and $d \mid x_{31}$ as required. Now $g_1^{-1}g$ has $x'_{21} = -x_{21}$ and $x'_{31} = x_{11}$. Thus if $d \mid x_{21}$ and $d \mid x_{11}$, then $g_1^{-1}g$ has $d \mid x'_{21}$ and $d \mid x'_{31}$.

If x_{21} is not divisible by d , then from (11) we see that x_{11} and x_{31} can not be divisible by d either. There are some cases.

Case 1: If $kx_{11} \equiv x_{21} \equiv \pm 1, \pm 2, \dots, \pm(d-1)/2 \pmod{d}$, then $g_{2k}^{-1}g$ has $x'_{21} = x_{21} - kx_{11}$ divisible by d and $x'_{11} = x_{11}$ not divisible by d . From (11) we see that this means $g_{2k}^{-1}g$ has x'_{31} divisible by d as well.

Case 2: If $kx_{11} \equiv -x_{21} \equiv \pm 1, \pm 2, \dots, \pm(d-1)/2 \pmod{d}$, then $g_{2k+1}^{-1}g$ has $x'_{21} = x_{21} + kx_{11}$ divisible by d and $x'_{11} = x_{11}$ not divisible by d . From (11) we see that this means $g_{2k+1}^{-1}g$ has x'_{31} divisible by d as well.

Now we consider $\Gamma_s^{(d)}$. We claim that

$$\Gamma_s^{(d)} = H^{(d)} \bigcup_{i=1}^d g'_i H^{(d)}$$

where

$$g'_1 = \begin{bmatrix} 0 & 0 & i/\sqrt{d} \\ 0 & 1 & 0 \\ i\sqrt{d} & 0 & 0 \end{bmatrix}, g'_{2k} = \begin{bmatrix} 1 & 0 & ik/\sqrt{d} \\ 0 & 1 & 0 \\ 0 & 0 & 1 \end{bmatrix}, g'_{2k+1} = \begin{bmatrix} 1 & 0 & -ik/\sqrt{d} \\ 0 & 1 & 0 \\ 0 & 0 & 1 \end{bmatrix}$$

($k = 1, 2, \dots, (d-1)/2$).

Write a general element of $\Gamma_s^{(d)}$ in the form (3), where $z_{13} = x_{13}/2 + iy_{13}/2\sqrt{d}$ and the other entries are as before. In order to show that an element of $\Gamma_s^{(d)}$ is in $H^{(d)}$, we must show that $d \mid y_{13}$. If $d \mid y_{13}$, then g is in $H^{(d)}$. If $d \nmid y_{13}$, then $g_1^{-1}g$ has $y'_{13} = -x_{33}$ divisible by d . It is in $H^{(d)}$.

If $d \nmid y_{13}$ and $d \nmid x_{33}$. Then there are also some cases.

Case 1: If $y_{13} \equiv kx_{33} \pmod{7}$, then $g'_{2k} g$ has $y'_{13} = y_{13} - kx_{33}$ divisible by d .

Case 2: If $y_{13} \equiv -kx_{33} \pmod{7}$, then $g'_{2k+1} g$ has $y'_{13} = y_{13} + kx_{33}$ divisible by d .

□

Proposition 3.1. *The sister groups $\Gamma_s^{(d)}$ has only one cusp.*

Proof. We only give a proof for the case $d = 2$. The other cases are similar. Note that $\Gamma^{(d)}$ has only one cusp. Without loss of generality we can assume that D is the fundamental domain for $\Gamma^{(2)}$ with the cusp based at 0. Then the fundamental domain for $H^{(2)}$ is $D \cup g_1(D) \cup g_2(D)$ and the candidate cusps of $H^{(2)}$ are $\infty, g_1(0) = g_2(0) = 0$. In order to show that $\Gamma_s^{(2)}$ has only one cusp, it is sufficient to show that there is a transformations $h \in \Gamma_s^{(2)}$ satisfying $h(0) = \infty$. In fact, we can find such $h \in \Gamma_s^{(2)}$, where

$$h = \begin{bmatrix} 0 & 0 & i/\sqrt{2} \\ 0 & 1 & 0 \\ i\sqrt{2} & 0 & 0 \end{bmatrix}.$$

□

4. ON THE STRUCTURE OF THE STABILIZER

In this section we will obtain the generators and relations of the stabilizer of the sister of Picard modular groups by analysis of the fundamental domain in Heisenberg group.

4.1. The stabilizer of q_∞ . First we want to analyse $(\Gamma_s^{(d)})_\infty$ with $d = 2, 7, 11$, the stabilizer of q_∞ . Every element of $(\Gamma_s^{(d)})_\infty$ is upper triangular and its diagonal entries are units in \mathcal{O}_d . Recall that the units of \mathcal{O}_1 are $\pm 1, \pm i$, they are $\pm 1, \pm\omega, \pm\omega^2$ for \mathcal{O}_3 and they are ± 1 for others. Therefore $(\Gamma_s^{(d)})_\infty$ contains no dilations and so is a subgroup of $Isom(\mathfrak{R})$ and fits into the exact sequence as

$$0 \longrightarrow \mathbb{R} \cap (\Gamma_s^{(d)})_\infty \longrightarrow (\Gamma_s^{(d)})_\infty \xrightarrow{\Pi_*} \Pi_* \left((\Gamma_s^{(d)})_\infty \right) \longrightarrow 1.$$

We can write the isometry group of the integer lattice as

$$Isom(\mathcal{O}_d) = \left\{ \begin{bmatrix} \alpha & \beta \\ 0 & 1 \end{bmatrix} : \alpha, \beta \in \mathcal{O}_d, \alpha \text{ is a unit} \right\}.$$

We now find the image and kernel in this exact sequence.

Proposition 4.1. *The stabilizer $(\Gamma_s^{(d)})_\infty$ of q_∞ in $\Gamma_s^{(d)}$ satisfies*

$$0 \longrightarrow \frac{2}{\sqrt{d}}\mathbb{Z} \longrightarrow (\Gamma_s^{(d)})_\infty \xrightarrow{\Pi_*} \Delta^{(d)} \longrightarrow 1,$$

where $\Delta^{(d)} \subset Isom(\mathcal{O}_d)$ is of index 2 if $d \equiv 2 \pmod{4}$ and $\Delta^{(d)} = Isom(\mathcal{O}_d)$ if $d \equiv 3 \pmod{4}$.

Proof. From the explicit construction of Π_* , we see that for $A \in (\Gamma_s^{(d)})_\infty$, $\Pi_*(A)$ is not dependent on the entry z_{13} of A . As in the proof of [17], we obtain that $\Delta^{(d)} = \Pi_* \left((\Gamma_s^{(d)})_\infty \right)$ is $Isom(\mathcal{O}_d)$ if $d \equiv 3 \pmod{4}$ and $\Delta^{(d)} \subset Isom(\mathcal{O}_d)$ is of index 2 if $d \equiv 2 \pmod{4}$. Likewise, the kernel of Π_* is easily seen to consist of those

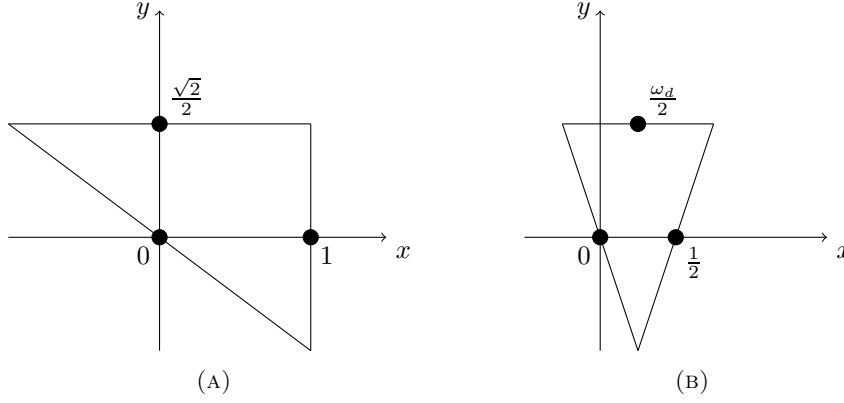

FIGURE 1. (A) Fundamental domain for $\Delta^{(d)}$ with $d \equiv 2 \pmod{4}$.
 (B). Fundamental domain for $\Delta^{(d)}$ with $d \equiv 3 \pmod{4}$.

vertical translation in $(\Gamma_d)_\infty$, that is, Heisenberg translation $(0, 2n/\sqrt{d}) \in \mathfrak{R}$ for $n \in \mathbb{Z}$. \square

4.2. Generators for the $\Delta^{(d)}$. The fundamental domain and the generators of $\Delta^{(d)} = \Pi_* \left((\Gamma_s^{(d)})_\infty \right)$ was described explicitly in [17].

A fundamental domain for $\Delta^{(2)} = \Pi_* \left((\Gamma_s^{(2)})_\infty \right)$ is the triangle in \mathbb{C} with vertices at $-1 + \sqrt{2}i/2$ and $1 \pm \sqrt{2}i/2$; see (a) in Figure 3.1. Side paring maps are given by

$$r_1^{(2)} = \begin{bmatrix} -1 & 0 \\ 0 & 1 \end{bmatrix}, r_2^{(2)} = \begin{bmatrix} -1 & 2 \\ 0 & 1 \end{bmatrix}, r_3^{(2)} = \begin{bmatrix} -1 & \sqrt{2}i \\ 0 & 1 \end{bmatrix}.$$

The first of these is a rotation of order 2 fixing origin, the second is a rotation of order 2 fixing $1/2$ and the third is a rotation of order 2 fixing $\sqrt{2}i/2$. One can see that these side paring maps are also the generators of $\Pi_* \left((\Gamma_s^{(2)})_\infty \right)$.

A fundamental domain for $\Delta^{(d)} = \text{Isom}(\mathcal{O}_d)$ with $d = 7$ or 11 is the triangle in \mathbb{C} with vertices at $(-1 + i\sqrt{d})/4$, $(1 - i\sqrt{d})/4$ and $(3 + i\sqrt{d})/4$; see (b) in Figure 3.1. Side paring maps are given by

$$r_1^{(d)} = \begin{bmatrix} -1 & 0 \\ 0 & 1 \end{bmatrix}, r_2^{(d)} = \begin{bmatrix} -1 & 1 \\ 0 & 1 \end{bmatrix}, r_3^{(d)} = \begin{bmatrix} -1 & (1 + i\sqrt{d})/2 \\ 0 & 1 \end{bmatrix}.$$

All these maps are rotations by π fixing $0, 1/2$ and $(1 + i\sqrt{d})/4$ respectively.

In order to produce a fundamental domain for $(\Gamma_s^{(d)})_\infty$ we look at all the preimages of the triangle (that is a fundamental domain of $\Pi_* \left((\Gamma_s^{(d)})_\infty \right)$) under vertical projection Π and we intersect this with a fundamental domain for $\ker(\Pi_*)$. The inverse of the image of the triangle under Π is an infinite prism. The kernel of Π_* is the infinite cyclic group generated by $T^{(d)}$, the vertical translation by $(0, 2/\sqrt{d})$.

Next, we will study the fundamental domain and the generators of stabilizer case by case.

Proposition 4.2. $(\Gamma_s^{(2)})_\infty$ is generated by

$$R_1^{(2)} = \begin{bmatrix} 1 & 0 & 0 \\ 0 & -1 & 0 \\ 0 & 0 & 1 \end{bmatrix}, R_2^{(2)} = \begin{bmatrix} 1 & 2 & -2 \\ 0 & -1 & 2 \\ 0 & 0 & 1 \end{bmatrix}, R_3^{(2)} = \begin{bmatrix} 1 & -i\sqrt{2} & -1 \\ 0 & -1 & i\sqrt{2} \\ 0 & 0 & 1 \end{bmatrix}$$

and

$$T^{(2)} = \begin{bmatrix} 1 & 0 & i/\sqrt{2} \\ 0 & 1 & 0 \\ 0 & 0 & 1 \end{bmatrix}.$$

A presentation is given by

$$\begin{aligned} (\Gamma_s^{(2)})_\infty &= \langle R_j^{(2)}, T^{(2)} | T^{(2)} R_1^{(2)} T^{(2)-1} R_1^{(2)} = R_1^{(2)2} = T^{(2)-1} R_2^{(2)} T^{(2)} R_2^{(2)} = R_2^{(2)2} \\ &= (R_1^{(2)-1} T^{(2)-2} R_3^{(2)-1} T^{(2)-2} R_1^{(2)})^2 = T^{(2)} R_3^{(2)-1} T^{(2)-1} R_3^{(2)} \rangle. \end{aligned}$$

Proof. Those matrices are constructed by lifting generators of the subgroup $\Delta^{(2)} \subset \text{Isom}(\mathcal{O}_2)$ of index 2 and also $T^{(2)}$ is a generator of the kernel of the map Π_* . A fundamental domain can be constructed with side pairings as Figure 2, where the vertices of the prism in horospherical coordinate are $v_1^+ = (1 - i\sqrt{2}/2, \sqrt{2}/2)$, $v_2^+ = (1 + i\sqrt{2}/2, \sqrt{2}/2)$, $v_3^+ = (-1 + i\sqrt{2}/2, \sqrt{2}/2)$, for the upper cap of the prism and $v_1^- = (1 - i\sqrt{2}/2, -\sqrt{2}/2)$, $v_2^- = (1 + i\sqrt{2}/2, -\sqrt{2}/2)$, $v_3^- = (-1 + i\sqrt{2}/2, -\sqrt{2}/2)$ for the base. In order to get the side-pairing maps, we need to introduce some points on the faces of the prism. See Table 1.

TABLE 1. Points introduced on the prism Σ_2

Points	Horospherical coordinate	Points	Horospherical coordinate
u_1^\pm	$(0, \pm\sqrt{2}/2)$	u_2^\pm	$(1 - i\sqrt{2}/4 \pm \sqrt{2}/2)$
u_3^\pm	$(1, \pm\sqrt{2}/2)$	u_4^\pm	$(1 + i\sqrt{2}/4, \pm\sqrt{2}/2)$
u_5^\pm	$(1/2 + i\sqrt{2}/2, \pm\sqrt{2}/2)$	u_6^\pm	$(i\sqrt{2}/2, \pm\sqrt{2}/2)$
u_7^\pm	$(-1/2 + i\sqrt{2}/2, \pm\sqrt{2}/2)$		

The actions of the side-pairing maps on \mathfrak{R} are given by

$$\begin{aligned} R_1^{(2)}(z, t) &= (-z, t), \\ R_2^{(2)}(z, t) &= (-z + 2, t + 4\Im mz), \\ R_3^{(2)}(z, t) &= (-z + i\sqrt{2}, t - 2\sqrt{2}\Re z), \\ T^{(2)}(\zeta, t) &= (\zeta, t + \sqrt{2}). \end{aligned}$$

We describe the side pairings in terms of their actions on the vertices:

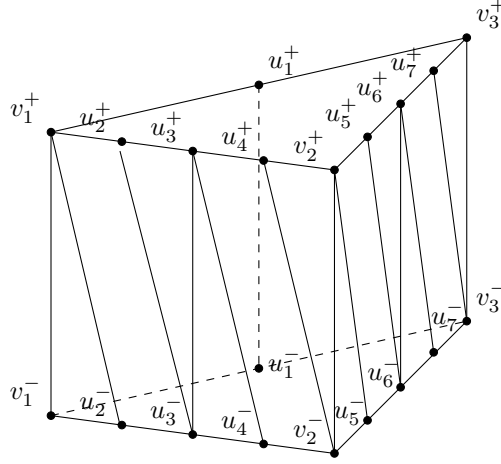
FIGURE 2. Fundamental domain for $(\Gamma_s^{(2)})_\infty$ in Heisenberg group

$$\begin{aligned}
R_1^{(2)} & : (u_1^+, u_1^-, v_1^+, v_1^-) \rightarrow (u_1^+, u_1^-, v_3^+, v_3^-) \\
R_2^{(2)} & : (u_2^+, u_3^+, u_3^-) \rightarrow (u_4^-, u_3^+, u_3^-) \\
T^{(2)}R_2^{(2)} & : (v_1^+, u_2^+, u_3^-, u_2^-) \rightarrow (v_2^-, u_4^+, u_3^+, u_4^-) \\
T^{(2)^2}R_2^{(2)} & : (v_1^+, v_1^-, u_2^-) \rightarrow (v_2^+, v_2^-, u_4^+) \\
R_3^{(2)} & : (u_5^+, u_6^+, u_6^-) \rightarrow (u_7^-, u_6^+, u_6^-) \\
T^{(2)}R_3^{(2)} & : (u_5^+, u_6^-, u_5^-, v_2^+) \rightarrow (u_7^+, u_6^+, u_7^-, v_3^-) \\
T^{(2)^2}R_3^{(2)} & : (v_2^+, v_2^-, u_5^-) \rightarrow (v_3^+, v_3^-, u_7^+) \\
T^{(2)} & : (v_1^-, v_2^-, v_3^-, u_1^-, u_2^-, u_3^-, u_4^-, u_5^-, u_6^-, u_7^-) \rightarrow \\
& (v_1^+, v_2^+, v_3^+, u_1^+, u_2^+, u_3^+, u_4^+, u_5^+, u_6^+, u_7^+)
\end{aligned}$$

The presentation can be obtained from the edge cycles of the fundamental domain. \square

Proposition 4.3. $(\Gamma_s^{(7)})_\infty$ is generated by

$$R_1^{(7)} = \begin{bmatrix} 1 & 0 & 0 \\ 0 & -1 & 0 \\ 0 & 0 & 1 \end{bmatrix}, R_2^{(7)} = \begin{bmatrix} 1 & 1 & i\omega_7/\sqrt{7} \\ 0 & -1 & 1 \\ 0 & 0 & 1 \end{bmatrix}, R_3^{(7)} = \begin{bmatrix} 1 & \bar{\omega}_7 & -1 \\ 0 & -1 & \omega_7 \\ 0 & 0 & 1 \end{bmatrix}$$

and

$$T^{(7)} = \begin{bmatrix} 1 & 0 & i/\sqrt{7} \\ 0 & 1 & 0 \\ 0 & 0 & 1 \end{bmatrix}.$$

A presentation is given by

$$\begin{aligned}
(\Gamma_7)_\infty &= \langle R_j^{(\tau)}, T^{(\tau)} | T^{(\tau)} R_1^{(\tau)} T^{(\tau)-1} R_1^{(\tau)} = R_1^{(\tau)2} = T^{(\tau)} R_2^{(\tau)-1} T^{(\tau)-1} R_2^{(\tau)} \\
&= (R_1^{(\tau)} T^{(\tau)} R_3^{(\tau)} T^{(\tau)2} R_2^{(\tau)})^2 = (R_1^{(\tau)} T^{(\tau)2} R_3^{(\tau)} T^{(\tau)} R_2^{(\tau)})^2 \\
&= R_2^{(\tau)-1} T^{(\tau)} R_2^{(\tau)-1} = T^{(\tau)} R_3^{(\tau)-1} T^{(\tau)-1} R_3^{(\tau)} = R_3^{(\tau)2} \rangle.
\end{aligned}$$

Proof. Those matrices are constructed by lifting generators of $Isom(\mathcal{O}_7)$ and also $T^{(\tau)}$ is a generator of the kernel of the map Π_* . A fundamental domain can be constructed with side pairings as Figure 3, where the vertices of the prism are $v_1^+ = (1/4 - i\sqrt{7}/4, \sqrt{7}/7)$, $v_2^+ = (3/4 + i\sqrt{7}/4, \sqrt{7}/7)$, $v_3^+ = (-1/4 + i\sqrt{7}/4, \sqrt{7}/7)$ for the upper cap of the prism and $v_1^- = (1/4 - i\sqrt{7}/4, -\sqrt{7}/7)$, $v_2^- = (3/4 + i\sqrt{7}/4, -\sqrt{7}/7)$, $v_3^- = (-1/4 + i\sqrt{7}/4, -\sqrt{7}/7)$, for the base. We also introduce more points on the faces of the prism which allow us to get the side-pairing maps. See Table 2.

TABLE 2. Points introduced on the prism Σ_7 .

Points	Horospherical coordinate	Points	Horospherical coordinate
u_1^\pm	$(0, \pm\sqrt{7}/7)$	u_2^\pm	$(2/7 - i3\sqrt{7}/14, \pm\sqrt{7}/7)$
u_3^\pm	$(3/7 - i\sqrt{7}/14, \pm\sqrt{7}/7)$	u_4^\pm	$(2/7 - i3\sqrt{7}/14, \pm\sqrt{7}/7)$
u_5^\pm	$(4/7 - i\sqrt{7}/14, \pm\sqrt{7}/7)$	u_6^\pm	$(5/7 + i3\sqrt{7}/14, \pm\sqrt{7}/7)$
u_7^\pm	$(15/28 + i\sqrt{7}/4, \pm\sqrt{7}/7)$	u_8^\pm	$(1/4 + i\sqrt{7}/4, \pm\sqrt{7}/7)$
u_9^\pm	$(-1/28 + i\sqrt{7}/4, \pm\sqrt{7}/7)$	w_1	$(1/4 - i\sqrt{7}/4, -\sqrt{7}/14)$
w_2	$(1/2, 0)$	w_3	$(3/4 + i\sqrt{7}/4, \sqrt{7}/14)$
w_4	$(-1/4 + i\sqrt{7}/4, -\sqrt{7}/14)$		

The actions of side-pairing maps on \mathfrak{R} are given by

$$\begin{aligned}
R_1^{(\tau)}(z, t) &= (-z, t), \\
R_2^{(\tau)}(z, t) &= \left(-z + 1, t + 2\Im(z) + \frac{1}{\sqrt{7}} \right), \\
R_3^{(\tau)}(z, t) &= (-z + \omega_7, t - 2\Im(\overline{\omega_7}z)), \\
T^{(\tau)}(z, t) &= (z, t + 2/\sqrt{7})
\end{aligned}$$

We describe the side pairings in terms of their actions on the vertices:

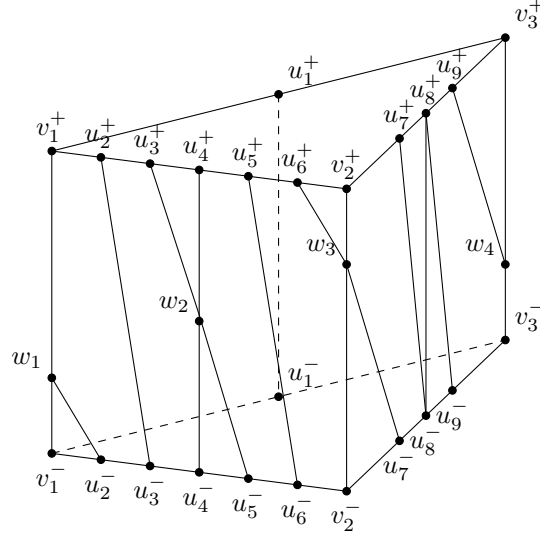
FIGURE 3. Fundamental domain for $(\Gamma_s^{(7)})_\infty$ in Heisenberg group

$$\begin{aligned}
R_1^{(7)} &: (u_1^+, u_1^-, v_1^+, v_1^-) \rightarrow (u_1^+, u_1^-, v_3^+, v_3^-), \\
R_2^{(7)} &: (u_2^+, u_3^-, u_4^-, w_2, u_3^+) \rightarrow (u_6^-, u_5^-, w_2, u_4^+, u_5^+), \\
T^{(7)} R_2^{(7)} &: (w_1, u_2^-, u_3^-, u_2^+, v_1^+) \rightarrow (v_2^-, u_6^-, u_5^+, u_6^+, w_3), \\
T^{(7)^2} R_2^{(7)} &: (w_1, v_1^-, u_2^-) \rightarrow (v_2^+, w_3, u_6^+), \\
T^{(7)^{-1}} R_2^{(7)} &: (u_3^+, w_2, u_4^+) \rightarrow (u_5^-, u_4^-, w_2), \\
T^{(7)^2} R_3^{(7)} &: (w_3, v_2^-, u_7^-) \rightarrow (v_3^+, w_4, u_9^+), \\
T^{(7)} R_3^{(7)} &: (v_2^+ w_3 u_7^- u_7^+ u_8^-) \rightarrow (w_4 v_3^- u_9^- u_9^+ u_8^+), \\
R_3^{(7)} &: (u_8^-, u_8^+, u_7^+) \rightarrow (u_8^-, u_8^+, u_9^-), \\
T^{(7)} &: (v_1^-, u_2^-, u_3^-, u_4^-, u_5^-, u_6^-, v_2^-, u_7^-, u_8^-, u_9^-, v_3^-) \rightarrow \\
& (v_1^+, u_2^+, u_3^+, u_4^+, u_5^+, u_6^+, v_2^+, u_7^+, u_8^+, u_9^+, v_3^+).
\end{aligned}$$

The presentation can be obtained from the edge cycles of the fundamental domain. □

Proposition 4.4. $(\Gamma_s^{(11)})_\infty$ is generated by

$$\begin{aligned}
R_1^{(11)} &= \begin{bmatrix} 1 & 0 & 0 \\ 0 & -1 & 0 \\ 0 & 0 & 1 \end{bmatrix}, R_2^{(11)} = \begin{bmatrix} 1 & 1 & i\omega_{11}/\sqrt{11} \\ 0 & -1 & 1 \\ 0 & 0 & 1 \end{bmatrix}, \\
R_3^{(11)} &= \begin{bmatrix} 1 & \bar{\omega}_{11} & i(-1 + 3\omega_{11})/\sqrt{11} \\ 0 & -1 & \omega_{11} \\ 0 & 0 & 1 \end{bmatrix} \quad \text{and} \quad T^{(11)} = \begin{bmatrix} 1 & 0 & i/\sqrt{11} \\ 0 & 1 & 0 \\ 0 & 0 & 1 \end{bmatrix}.
\end{aligned}$$

A presentation is given by

$$\begin{aligned}
(\Gamma_{11})_\infty &= \langle R_j^{(11)}, T^{(11)} | T^{(11)} R_3^{(11)-1} T^{(11)-1} R_3^{(11)} = T^{(11)} R_1^{(11)} T^{(11)-1} R_1^{(11)} \\
&= R_1^{(11)-1} T^{(11)3} R_3^{(11)} T^{(11)2} R_2^{(11)} R_1^{(11)-1} T^{(11)2} R_3^{(11)} T^{(11)2} R_2^{(11)} \\
&= R_1^{(11)-1} T^{(11)2} R_3^{(11)} T^{(11)3} R_2^{(11)} R_1^{(11)-1} T^{(11)2} R_3^{(11)} T^{(11)2} R_2^{(11)} \\
&= T^{(11)} R_2^{(11)-1} T^{(11)-1} R_2^{(11)} = R_1^{(11)2} \rangle.
\end{aligned}$$

Proof. Those matrices are constructed by lifting generators of $Isom(\mathcal{O}_{11})$ and also $T^{(11)}$ is a generator of the kernel of the map Π_* . A fundamental domain can be constructed with side pairings as Figure 4, where the vertices of the prism are $v_1^\pm = (1/4 - i\sqrt{11}/4, \pm\sqrt{11}/11)$, $v_2^\pm = (3/4 + i\sqrt{11}/4, \pm\sqrt{11}/11)$, $v_3^\pm = (-1/4 + i\sqrt{11}/4, \pm\sqrt{11}/11)$. In particular, we introduce more points on the faces of the prism. See Table 3.

TABLE 3. Points introduced on the prism Σ_{11}

Points	Horospherical coordinate	Points	Horospherical coordinate
u_1^\pm	$(0, \pm\sqrt{11}/11)$	u_2^\pm	$(3/11 - i5\sqrt{11}/22, \pm\sqrt{11}/11)$
u_3^\pm	$(8/22 - i3\sqrt{11}/22, \pm\sqrt{11}/11)$	u_4^\pm	$(10/22 - i\sqrt{11}/22, \pm\sqrt{11}/11)$
u_5^\pm	$(1/2, \pm\sqrt{11}/11)$	u_6^\pm	$(12/22 + i\sqrt{11}/22, \pm\sqrt{11}/11)$
u_7^\pm	$(14/22 + i3\sqrt{11}/22, \pm\sqrt{11}/11)$	u_8^\pm	$(8/11 + i5\sqrt{11}/22, \pm\sqrt{11}/11)$
u_9^\pm	$(31/44 + i\sqrt{11}/44, \pm\sqrt{11}/11)$	u_{10}^\pm	$(23/44 + i\sqrt{11}/4, \pm\sqrt{11}/11)$
u_{11}^\pm	$(15/44 - i\sqrt{11}/4, \pm\sqrt{11}/11)$	u_{12}^\pm	$(1/4 + i\sqrt{11}/4, \pm\sqrt{11}/11)$
u_{13}^\pm	$(7/44 + i\sqrt{11}/4, \pm\sqrt{11}/11)$	u_{14}^\pm	$(-1/44 + i\sqrt{11}/4, \pm\sqrt{11}/11)$
u_{15}^\pm	$(-9/44 + i\sqrt{11}/4, \pm\sqrt{11}/11)$	w_1	$(1/4 - i\sqrt{11}/4, -\sqrt{11}/22)$
w_2	$(1/2, 0)$	w_3	$(3/4 + i\sqrt{11}/4, \sqrt{11}/22)$
w_4	$(3/4 + i\sqrt{11}/4, -\sqrt{11}/22)$	w_5	$(1/4 + i\sqrt{11}/4, 0)$
w_6	$(-1/4 + i\sqrt{11}/4, \sqrt{11}/22)$	w_7	$(-1/4 + i\sqrt{11}/4, 0)$
w_8	$(-1/4 + i\sqrt{11}/4, -\sqrt{11}/22)$	w_9	$(3/4 + i\sqrt{11}/4, 0)$
w_{10}	$(1/4 - i\sqrt{11}/4, \sqrt{11}/22)$	w_{11}	$(1/4 - i\sqrt{11}/4, 0)$

The actions of side-pairing maps on \mathfrak{R} are given by

$$\begin{aligned}
R_1^{(11)}(z, t) &= (-z, t), \\
R_2^{(11)}(z, t) &= \left(-z + 1, t + 2\Im(z) + \frac{1}{\sqrt{11}} \right), \\
R_3^{(11)}(z, t) &= \left(-z + \omega_7, t + 2\Im(\overline{\omega_{11}}z) + \frac{1}{\sqrt{11}} \right), \\
T^{(11)}(z, t) &= (z, t + 2/\sqrt{11}).
\end{aligned}$$

We describe the side pairing in terms of the action on the vertice:

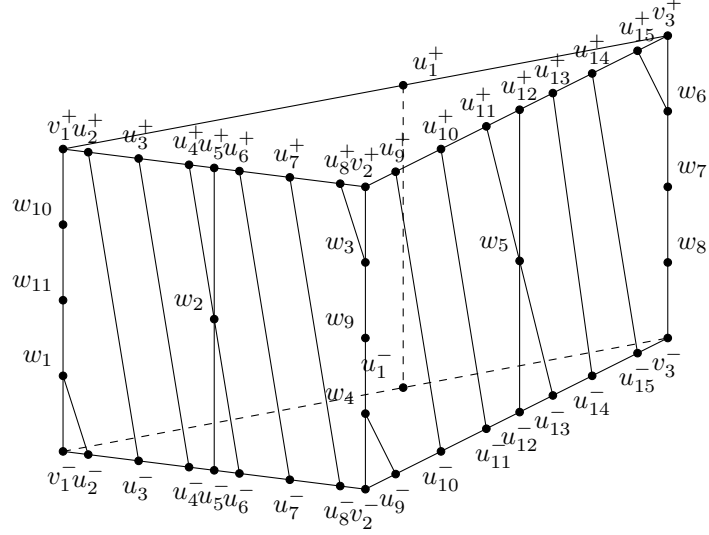
FIGURE 4. Fundamental domain for $(\Gamma_s^{(11)})_\infty$ in Heisenberg group

$$\begin{aligned}
R_1^{(11)} &: (u_1^+, u_1^-, v_1^-, w_1, w_{11}, w_{10}, v_1^+) \rightarrow (u_1^+, u_1^-, v_3^-, w_8, w_7, w_6, v_3^+), \\
R_2^{(11)} &: (u_3^+, u_4^-, u_4^+, w_2, u_5^-) \rightarrow (u_7^-, u_6^-, u_6^+, u_5^+, w_2), \\
T^{(11)} R_2^{(11)} &: (u_2^+, u_3^-, u_3^+, u_4^-) \rightarrow (u_8^-, u_7^-, u_7^+, u_6^+), \\
T^{(11)3} R_2^{(11)} &: (w_1, v_1^-, u_2^-) \rightarrow (v_2^+, w_3, u_8^+), \\
T^{(11)2} R_2^{(11)} &: (w_1, u_2^-, u_3^-, u_2^+, v_1^+, w_{10}, w_{11}) \rightarrow (v_2^-, u_8^-, u_7^+, u_8^+, w_3, w_9, w_4) \\
T^{(11)-1} R_2^{(11)} &: (u_4^+, w_2, u_5^+) \rightarrow (u_6^-, u_5^-, w_2), \\
T^{(11)3} R_3^{(11)} &: (w_4, v_2^-, u_9^-) \rightarrow (v_3^+, w_6, u_{15}^+), \\
T^{(11)2} R_3^{(11)} &: (w_3, w_9, w_4, u_9^-, u_{10}^-, u_9^+, v_2^+) \rightarrow (w_7, w_8, v_3^-, u_{15}^-, u_{14}^+, u_{15}^+, w_6), \\
T^{(11)} R_3^{(11)} &: (u_9^+, u_{10}^-, u_{11}^-, u_{10}^+) \rightarrow (u_{15}^-, u_{14}^-, u_{13}^+, u_{14}^+), \\
R_3^{(11)} &: (u_{10}^+, u_{11}^-, u_{12}^-, w_5, u_{11}^+) \rightarrow (u_{14}^-, u_{13}^-, w_5, u_{12}^+, u_{13}^+), \\
T^{(11)-1} R_3^{(11)} &: (u_{11}^+, w_5, u_{12}^+) \rightarrow (u_{13}^-, u_{12}^-, w_5), \\
T^{(11)} &: (v_1^-, u_2^-, u_3^-, u_4^-, u_5^-, u_6^-, u_7^-, u_8^-, v_2^-, u_9^-, u_{10}^-, u_{11}^-, u_{12}^-, u_{13}^-, u_{14}^-, u_{15}^-, v_3^-) \rightarrow \\
&\quad (v_1^+, u_2^+, u_3^+, u_4^+, u_5^+, u_6^+, u_7^+, u_8^+, v_2^+, u_9^+, u_{10}^+, u_{11}^+, u_{12}^+, u_{13}^+, u_{14}^+, u_{15}^+, v_3^+).
\end{aligned}$$

The presentation can be obtained following from the edge cycles of the fundamental domain. \square

5. TO FIND THE SPINAL SPHERES THAT COVER THE PRISM

In this section, we will determine the generators of the sister of Euclidean Picard groups. Our method is based on the special feature that the orbifold $\mathbf{H}_{\mathbb{C}}^2/\Gamma_s^{(d)}$ has

only one cusp for $d = 2, 7, 11$. In the previous section, we found suitable generators of the stabiliser and constructed a fundamental domain. We will show that adjoining a reflection $I_0^{(d)}$ to $(\Gamma_s^{(d)})_\infty$ gives the generators of the sister of the Euclidean Picard modular groups $\Gamma_s^{(d)}$. As in the proof of Theorem 3.5 of [3], it is sufficient to show that $\langle R_1^{(d)}, R_2^{(d)}, R_3^{(d)}, T^{(d)}, I_0^{(d)} \rangle$ has only one cusp. The key step is to show the union of the boundaries of these isometric spheres in Heisenberg group contains the fundamental domains for the stabilizers. In order to achieve this goal, the fundamental domains for the stabilizers will be decomposed into several pieces as polyhedra such that each polyhedron lies inside a spinal sphere.

Given the map

$$I_0^{(d)} = \begin{bmatrix} 0 & 0 & i/\sqrt{d} \\ 0 & 1 & 0 \\ i\sqrt{d} & 0 & 0 \end{bmatrix}.$$

The isometric sphere $\mathcal{B}_0^{(d)}$ of $I_0^{(d)}$ is a Cygan sphere centered at $o = (0, 0, 0)$ with radius $\frac{2}{\sqrt{d}}$. Observe that $I_0^{(d)}$ maps $\mathcal{B}_0^{(d)}$ to itself and swaps the inside and the outside of $\mathcal{B}_0^{(d)}$. The boundary of $\mathcal{B}_0^{(d)}$ is a spinal sphere denoted by

$$(12) \quad \mathcal{S}_0^{(d)} = \left\{ (\zeta, t) : \left| |\zeta|^2 + it \right| = 2/\sqrt{d} \right\}.$$

Indeed we only need to consider the boundaries of isometric spheres in Heisenberg group because two isometric spheres have a non-empty interior intersection if and only if the boundaries have a non-empty interior intersection.

5.1. The proof of Theorem 5.1. In this case, it is easy to see that the six vertices of the prism Σ_2 lie outside of $\mathcal{S}_0^{(2)}$. Therefore, we need to find more isometric spheres whose boundaries together with $\mathcal{S}_0^{(2)}$ contain the prism Σ_2 .

We consider the map

$$I_0^{(2)} R_3^{(2)} I_0^{(2)} = \begin{pmatrix} -1 & 0 & 0 \\ -2 & -1 & 0 \\ 2 & 2 & -1 \end{pmatrix}.$$

$\mathcal{B}_1^{(2)}$ denotes its isometric sphere which is a Cygan sphere centered at the point $(1, 0)$ with radius 1. The boundary of $\mathcal{B}_1^{(2)}$ is given by

$$(13) \quad \mathcal{S}_1^{(2)} = \left\{ (z, t) : \left| |z - 1|^2 + it + 2i\Im z \right| = 1 \right\}.$$

We need to consider $\mathcal{S}_0^{(2)}$ and several images of $\mathcal{S}_1^{(2)}$ under some suitable elements in $(\Gamma_s^{(2)})_\infty$. In Heisenberg coordinates these are given by

$$\begin{aligned} T^{(2)}(\mathcal{S}_1^{(2)}) &= \left\{ (z, t) : \left| |z - 1|^2 + it - i\sqrt{2} + 2i\Im z \right| = 1 \right\}, \\ T^{(2)-1}(\mathcal{S}_1^{(2)}) &= \left\{ (z, t) : \left| |z - 1|^2 + it + i\sqrt{2} + 2i\Im z \right| = 1 \right\}, \\ T^{(2)-1} R_1^{(2)}(\mathcal{S}_1^{(2)}) &= \left\{ (z, t) : \left| |z + 1|^2 + it + i\sqrt{2} - 2i\Im z \right| = 1 \right\}, \end{aligned}$$

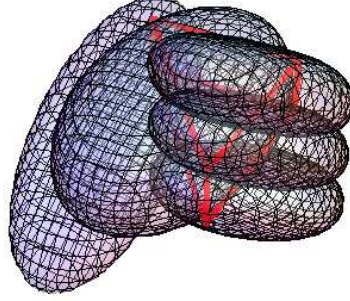

FIGURE 5. The view of neighboring spinal spheres containing the fundamental domain for $(\Gamma_s^{(2)})_\infty$.

We claim that the prism Σ_2 lies inside the union of

$$\mathcal{S}_0^{(2)}, \mathcal{S}_1^{(2)}, T^{(2)}(\mathcal{S}_1^{(2)}), T^{(2)^{-1}}(\mathcal{S}_1^{(2)}), T^{(2)^{-1}}R_1^{(2)}(\mathcal{S}_1^{(2)});$$

see Figure 5. for viewing these spinal spheres.

Proposition 5.1. *The prism Σ_2 is contained in the union of the interiors of the spinal spheres $\mathcal{S}_0^{(2)}, \mathcal{S}_1^{(2)}, T^{(2)}(\mathcal{S}_1^{(2)}), T^{(2)^{-1}}(\mathcal{S}_1^{(2)}), T^{(2)^{-1}}R_1^{(2)}(\mathcal{S}_1^{(2)})$.*

Proof. It suffices to show that the prism Σ_2 can be decomposed into several pieces as polyhedra such that each polyhedron lies inside a spinal sphere which is described in the proposition and the common face of two adjacent polyhedra lie in the intersection of the interior of two spinal spheres which contain these two polyhedra.

We need to add fifteen points on the faces of the prism Σ_2 in order to decompose the prism into five polyhedra, in Heisenberg coordinates. See Figure 6 for the decomposition of the prism. These are given by

$$\begin{aligned} p_1 &= (4/5 - i2\sqrt{2}/5, \sqrt{2}/2), & p_2 &= (1 - i3\sqrt{2}/10, \sqrt{2}/2), \\ p_3 &= (4/5 - i2\sqrt{2}/5, -\sqrt{2}/2), & p_4 &= (1 - i3\sqrt{2}/10, -\sqrt{2}/2), \\ p_5 &= (4/5 - i2\sqrt{2}/5, 2\sqrt{2}/5), & p_6 &= (1 - i3\sqrt{2}/10, \sqrt{2}/5), \\ p_7 &= (4/5 + i\sqrt{2}/2, \sqrt{2}/2), & p_8 &= (1 + i3\sqrt{2}/10, -\sqrt{2}/2), \\ p_9 &= (4/5 + i\sqrt{2}/2, -\sqrt{2}/2), & p_{10} &= (1 + i3\sqrt{2}/10, -\sqrt{2}/2), \\ p_{11} &= (1 + i\sqrt{2}/2, -2\sqrt{2}/5), & p_{12} &= (-4/5 + i\sqrt{2}/2, \sqrt{2}/2), \\ p_{13} &= (-9/10 + i9\sqrt{2}/20, \sqrt{2}/2), & p_{14} &= (-4/5 + i\sqrt{2}/2, -\sqrt{2}/2), \\ p_{15} &= (-9/10 + i9\sqrt{2}/20, -\sqrt{2}/2). \end{aligned}$$

We verify the location of all these points as follows

- the points p_1, p_2 are in the intersection of the interiors of $\mathcal{S}_0^{(2)}$ and $\mathcal{S}_1^{(2)}$;

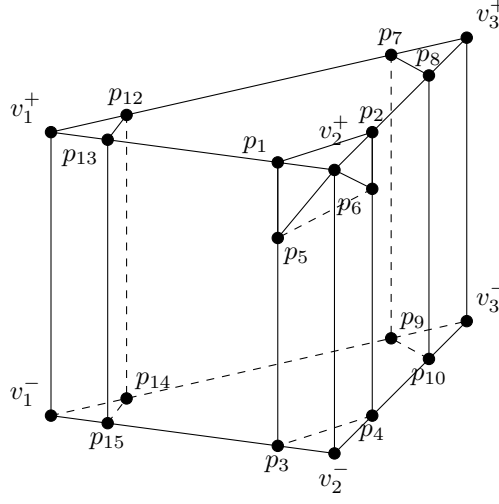

FIGURE 6. The decomposition of the fundamental domain for $(\Gamma_s^{(2)})_\infty$ into several polyhedra.

- the points p_5, p_6 are in the intersection of the interiors of $\mathcal{S}_0^{(2)}, \mathcal{S}_1^{(2)}$ and $T^{(2)-1}(\mathcal{S}_1^{(2)})$;
- the points p_3, p_4 are in the intersection of the interiors of $\mathcal{S}_0^{(2)}$ and $T^{(2)-1}(\mathcal{S}_1^{(2)})$;
- the point v_2^+ is in the intersection of the interiors of $\mathcal{S}_1^{(2)}$ and $T^{(2)-1}(\mathcal{S}_1^{(2)})$;
- the point v_2^- is in the interior of $T^{(2)-1}(\mathcal{S}_1^{(2)})$;
- the point v_3^+ is in the interior of $T^{(2)}(\mathcal{S}_1^{(2)})$;
- the point v_3^- is in the intersection of the interiors of $T^{(2)}(\mathcal{S}_1^{(2)})$ and $\mathcal{S}_1^{(2)}$;
- the points p_7, p_8 are in the intersection of the interiors of $\mathcal{S}_0^{(2)}$ and $T^{(2)}(\mathcal{S}_1^{(2)})$;
- the points p_9, p_{10} are in the intersection of the interiors of $\mathcal{S}_0^{(2)}, T^{(2)}(\mathcal{S}_1^{(2)})$ and $\mathcal{S}_1^{(2)}$;
- the point p_{11} is in the intersection of the interiors of $\mathcal{S}_1^{(2)}$ and $T^{(2)}(\mathcal{S}_1^{(2)})$;
- the points v_1^-, v_1^+ are in the interiors of $T^{(2)-1}R_1^{(2)}(\mathcal{S}_1^{(2)})$;
- the points $p_{12}, p_{13}, p_{14}, p_{15}$ are in the intersection of the interiors of $\mathcal{S}_0^{(2)}$ and $T^{(2)-1}R_1^{(2)}(\mathcal{S}_1^{(2)})$.

We describe these polyhedra as follows

- the first polyhedra $\mathbb{P}_1^{(2)}$ with vertices $v_1^+, p_{12}, p_{13}, v_1^-, p_{14}, p_{15}$;
- the second polyhedra $\mathbb{P}_2^{(2)}$ with vertices $v_3^+, p_7, p_8, v_3^-, p_9, p_{10}$;
- the third polyhedra $\mathbb{P}_3^{(2)}$ with vertices $p_{12}, p_{13}, p_2, p_8, p_7, p_{14}, p_{15}, p_3, p_4, p_{10}, p_9$;
- the fourth polyhedra $\mathbb{P}_4^{(2)}$ with vertices $v_2^+, p_1, p_2, p_6, p_5$;
- the fifth polyhedra $\mathbb{P}_5^{(2)}$ with vertices $v_2^+, p_5, p_6, v_2^-, p_3, p_4$.

As the spinal sphere is convex, we conclude that the polyhedra $\mathbb{P}_1^{(2)}$ is inside the spinal sphere $T^{(2)-1}R_1^{(2)}(\mathcal{S}_1^{(2)})$; the polyhedra $\mathbb{P}_2^{(2)}$ is inside the spinal sphere $T^{(2)}(\mathcal{S}_1^{(2)})$; the polyhedra $\mathbb{P}_3^{(2)}$ is inside the spinal sphere $\mathcal{S}_0^{(2)}$; the polyhedra $\mathbb{P}_4^{(2)}$ is inside the spinal sphere $\mathcal{S}_1^{(2)}$; the polyhedra $\mathbb{P}_5^{(2)}$ is inside the spinal sphere $T^{(2)-1}(\mathcal{S}_1^{(2)})$. \square

5.2. **The proof of Theorem 1.2.** As in the case of Σ_2 , the fundamental domain Σ_7 for the stabilizer $(\Gamma_s^{(7)})_\infty$ also can not be contained inside $\mathcal{S}_0^{(7)}$ completely. Therefore we consider the maps

$$Q_1 = I_0^{(7)} R_3^{(7)} I_0^{(7)} = \begin{pmatrix} -1 & 0 & 1 \\ -7/2 + \sqrt{7}i/2 & -1 & 0 \\ 7 & 7/2 + \sqrt{7}i/2 & -1 \end{pmatrix},$$

and

$$Q_2 = R_2^{(7)-1} I_0^{(7)} R_2^{(7)} = \begin{pmatrix} 1/2 - \sqrt{7}i/2 & -1/2 - \sqrt{7}i/2 & 1 + 3i/\sqrt{7} \\ i\sqrt{7} & 1 + i\sqrt{7} & -3/2 - \sqrt{7}i/2 \\ i\sqrt{7} & i\sqrt{7} & -1/2 - \sqrt{7}i/2 \end{pmatrix}.$$

Consider the isometric spheres of Q_1 and Q_2 , which are denoted by $\mathcal{B}_1^{(7)}$ and $\mathcal{B}_2^{(7)}$, respectively. The center of $\mathcal{B}_1^{(7)}$ is $Q_1^{-1}(\infty)$, which is point with horospherical coordinate $(1/2, -1/2\sqrt{7}, 0)$ and the centre of $\mathcal{B}_2^{(7)}$, is $Q_2^{-1}(\infty)$ which has horospherical coordinate $(1, 0, -1/\sqrt{7})$. The Cygan radius of $\mathcal{B}_1^{(7)}$ and $\mathcal{B}_2^{(7)}$ are $\sqrt{2}/\sqrt{7}$ and $\sqrt{2}/\sqrt[4]{7}$ respectively. The boundaries of these isometric spheres $\mathcal{B}_1^{(7)}$ and $\mathcal{B}_2^{(7)}$ are in Heisenberg coordinates given by

$$\begin{aligned} \mathcal{S}_1^{(7)} &= \left\{ (z, t) : \left| |z + i\omega_7/\sqrt{7}|^2 + it + 2i\Im(iz\bar{\omega}_7/\sqrt{7}) \right| = 2/7 \right\}, \\ \mathcal{S}_2^{(7)} &= \left\{ (z, t) : \left| |z - 1|^2 + it + i/\sqrt{7} + 2i\Im z \right| = 2/\sqrt{7} \right\} \end{aligned}$$

In order to cover the prism Σ_7 , we consider $\mathcal{S}_0^{(7)}$ and the images of $\mathcal{S}_1^{(7)}$ and $\mathcal{S}_2^{(7)}$ under some elements in $(\Gamma_s^{(7)})_\infty$. These spinal spheres are points with Heisenberg coordinates given by

$$\begin{aligned} T^{(7)} R_2^{(7)} (\mathcal{S}_1^{(7)}) &= \left\{ (z, t) : \left| |z - i\bar{\omega}_7/\sqrt{7}|^2 + it - i2/\sqrt{7} + 2i\Im(-iz\omega_7/\sqrt{7}) \right| = 2/7 \right\}, \\ T^{(7)^2} (\mathcal{S}_2^{(7)}) &= \left\{ (z, t) : \left| |z - 1|^2 + it - i3/\sqrt{7} + 2i\Im z \right| = 2/\sqrt{7} \right\}, \\ T^{(7)^3} (\mathcal{S}_2^{(7)}) &= \left\{ (z, t) : \left| |z - 1|^2 + it - i5/\sqrt{7} - 2i\Im z \right| = 2/\sqrt{7} \right\}. \end{aligned}$$

We claim that the prism Σ_7 lies inside the union of

$$\mathcal{S}_0^{(7)}, \mathcal{S}_1^{(7)}, \mathcal{S}_2^{(7)}, T^{(7)} R_2^{(7)} (\mathcal{S}_1^{(7)}), T^{(7)^2} (\mathcal{S}_2^{(7)}), T^{(7)^3} (\mathcal{S}_2^{(7)}).$$

See Figure 7 for viewing these spinal spheres.

Proposition 5.2. *The prism Σ_7 is contained in the union of the interiors of the spinal spheres $\mathcal{S}_0^{(7)}, \mathcal{S}_1^{(7)}, \mathcal{S}_2^{(7)}, T^{(7)} R_2^{(7)} (\mathcal{S}_1^{(7)}), T^{(7)^2} (\mathcal{S}_2^{(7)}), T^{(7)^3} (\mathcal{S}_2^{(7)})$.*

Proof. We need to add sixteen points on the faces of the prism Σ_7 in order to decompose the prism into seven polyhedra, in Heisenberg coordinates, these are

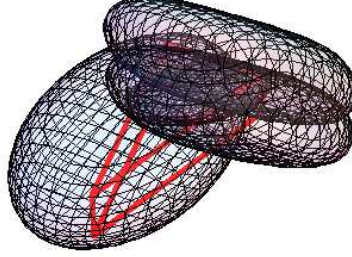

FIGURE 7. The view of neighboring spinal spheres containing the fundamental domain for $(\Gamma_s^{(7)})_\infty$

given by

$$\begin{aligned}
 p_1 &= (0.67, 0.17 \times \sqrt{17}, \sqrt{7}/7), & p_2 &= (0.46, \sqrt{7}/4, \sqrt{7}/7), \\
 p_3 &= (0.67, 0.17 \times \sqrt{17}, -\sqrt{7}/7), & p_4 &= (0.46, \sqrt{7}/4, \sqrt{7}/7), \\
 p_5 &= (3/4, \sqrt{7}/4, \sqrt{7}/8), & p_6 &= (0.46, \sqrt{7}/4, 0), \\
 p_7 &= (0.55, \sqrt{7}/4, \sqrt{7}/20), & p_8 &= (0.55, \sqrt{7}/4, \sqrt{7}/7), \\
 p_9 &= (0.6, 0.2 \times \sqrt{7}, \sqrt{7}/7), & p_{10} &= (0.65, \sqrt{7}/4, 7\sqrt{7}/80), \\
 p_{11} &= (0.6, 0.2 \times \sqrt{7}, -\sqrt{7}/7).
 \end{aligned}$$

We verify the location of all these points as follows

- the points $p_1, p_3, p_4, p_5, p_6, p_9, p_{11}, v_2^-$ are in the intersection of the interiors of $\mathcal{S}_0^{(7)}$ and $T^{(7)2}(\mathcal{S}_2^{(7)})$;
- the points p_1, p_5, p_9, v_2^+ are in the interior of $T^{(7)3}(\mathcal{S}_2^{(7)})$;
- the point p_9 is in the interior of $T^{(7)}R_2^{(7)}(\mathcal{S}_1^{(7)})$;
- the point p_2 is in the intersection of the interiors of $\mathcal{S}_0^{(7)}$ and $T^{(7)}R_2^{(7)}(\mathcal{S}_1^{(7)})$;
- the point p_8 is in the intersection of the interiors of $T^{(7)3}(\mathcal{S}_2^{(7)})$ and $T^{(7)}R_2^{(7)}(\mathcal{S}_1^{(7)})$;
- the point p_{10} is in the intersection of the interiors of $T^{(7)}R_2^{(7)}(\mathcal{S}_1^{(7)})$, $T^{(7)2}(\mathcal{S}_2^{(7)})$ and $T^{(7)3}(\mathcal{S}_2^{(7)})$;
- the point p_7 is in the intersection of the interiors of $T^{(7)}R_2^{(7)}(\mathcal{S}_1^{(7)})$, $T^{(7)2}(\mathcal{S}_2^{(7)})$ and $\mathcal{S}_0^{(7)}$.

We describe these polyhedra as follows:

- the polyhedra $\mathbb{P}_1^{(7)}$ with vertices $v_1^+, p_1, p_9, p_2, v_3^+, v_1^-, p_3, p_{11}, p_4, v_3^-$;
- the polyhedra $\mathbb{P}_2^{(7)}$ with vertices $p_1, p_5, p_9, p_3, v_2^-, p_{11}$;
- the polyhedra $\mathbb{P}_3^{(7)}$ with vertices p_1, p_5, v_2^+, p_9 ;

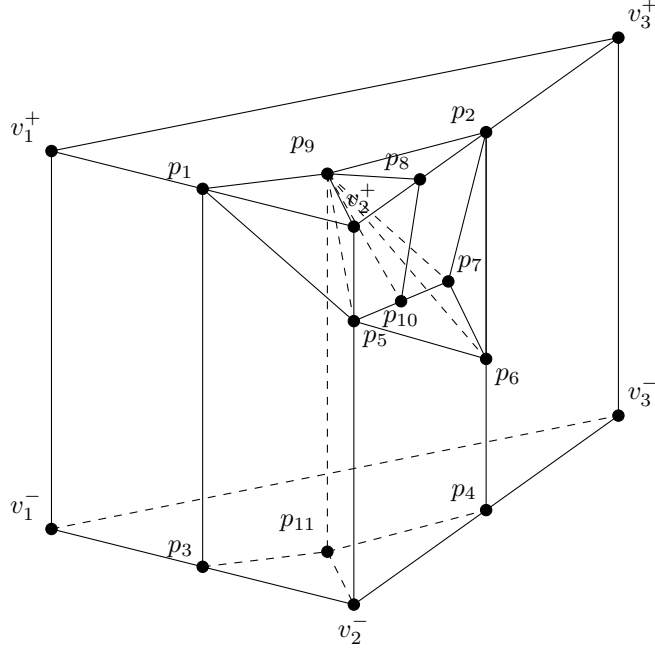

FIGURE 8. The decomposition of the fundamental domain for $(\Gamma_s^{(7)})_\infty$ in Heisenberg group

- the polyhedra $\mathbb{P}_4^{(7)}$ with vertices $p_5, p_9, p_6, v_2^-, p_{11}, p_4$;
- the polyhedra $\mathbb{P}_5^{(7)}$ with vertices $p_9, p_5, p_{10}, p_8, v_2^+$;
- the polyhedra $\mathbb{P}_6^{(7)}$ with vertices $p_9, p_5, p_{10}, p_7, p_6$;
- the polyhedra $\mathbb{P}_7^{(7)}$ with vertices p_9, p_2, p_7, p_6 ;
- the polyhedra $\mathbb{P}_8^{(7)}$ with vertices $p_9, p_{10}, p_7, p_2, p_8$.

By examining the location of the points and applying the spinal sphere is convex, we conclude that the polyhedra $\mathbb{P}_1^{(7)}$ is inside the spinal sphere $\mathcal{S}_0^{(7)}$; the polyhedra $\mathbb{P}_2^{(7)}$ is inside the spinal sphere $T^{(\tau)^2}(\mathcal{S}_2^{(7)})$; the polyhedra $\mathbb{P}_3^{(7)}$ is inside the spinal sphere $T^{(\tau)^3}(\mathcal{S}_2^{(7)})$; the polyhedra $\mathbb{P}_4^{(7)}$ is inside the spinal sphere $T^{(\tau)^2}(\mathcal{S}_2^{(7)})$; the polyhedra $\mathbb{P}_5^{(7)}$ is inside the spinal sphere $T^{(\tau)^3}(\mathcal{S}_2^{(7)})$; the polyhedra $\mathbb{P}_6^{(7)}$ is inside the spinal sphere $T^{(\tau)^2}(\mathcal{S}_2^{(7)})$; the polyhedra $\mathbb{P}_7^{(7)}$ is inside the spinal sphere $\mathcal{S}_0^{(7)}$; the polyhedra $\mathbb{P}_8^{(7)}$ is inside the spinal sphere $T^{(\tau)}R_2^{(7)}(\mathcal{S}_1^{(7)})$.

□

5.3. The case \mathcal{O}_{11} . In this case, it is also easy to know that the fundamental domain for the stabilizer $(\Gamma_s^{(11)})_\infty$ can not be inside $\mathcal{S}_0^{(11)}$ completely. Moreover, the intersection of the intersection of the spinal spheres is more complicated than the above two cases. So it is difficult to decompose Σ_{11} into several polyhedral as before. We will apply the similar method in [17]. Σ_{11} will be decomposed into several polyhedra cells. Observe that a union of intersection of several spinal spheres is a star-convex set if they have a non-empty interior intersection. Thus we

show that the collection of some spinal spheres can be separated into several parts such that each part contains certain polyhedral cell. All of these polyhedral cells are defined by the cone-polygon as its boundary. The concept of cone-polygon was introduced in [17].

First we consider the maps

$$A_1 = (I_0^{(11)} R_2^{(11)} I_0^{(11)})^{-1} \begin{pmatrix} -1 & 0 & 0 \\ -i\sqrt{11} & -1 & 0 \\ 11/2 + i\sqrt{11}/2 & -\sqrt{11}i & -1 \end{pmatrix}$$

and

$$A_2 = (R_2^{(11)} I_0^{(11)})^2 = \begin{pmatrix} -7/2 + 3\sqrt{11}i/2 & -3/2 - \sqrt{11}i/2 & 1/2 - i/2\sqrt{11} \\ 11/2 - 3\sqrt{11}i/2 & 1 + \sqrt{11}i & -1 \\ 11/2 - \sqrt{11}i/2 & \sqrt{11}i & -1 \end{pmatrix}.$$

The boundaries of the isometric spheres of A_1, A_2 are in Heisenberg coordinates given by

$$\begin{aligned} \mathcal{S}_1^{(11)} &= \left\{ (z, t) : \left| |z + \overline{\omega_{11}}/3|^2 + it + i/3\sqrt{11} + 2i\Im(-z\omega_{11}/3) \right| = \frac{2}{\sqrt{33}} \right\}, \\ \mathcal{S}_2^{(11)} &= \left\{ (z, t) : \left| |z + \omega_{11}/3|^2 + it - i/3\sqrt{11} + 2i\Im(-z\overline{\omega_{11}}/3) \right| = \frac{2}{\sqrt{33}} \right\}. \end{aligned}$$

In order to determine a union of the spinal spheres which covers the prism Σ_{11} , we need to consider $\mathcal{S}_0^{(11)}$ and the images of $\mathcal{S}_1^{(11)}$ and $\mathcal{S}_2^{(11)}$ under some elements in $(\Gamma_s^{(11)})_\infty$. We will show that the prism Σ_{11} lies inside the union of ten spinal spheres. See Figure 9 for viewing these spinal spheres.

Proposition 5.3. *The prism Σ_{11} is contained in the union of the interiors of the spinal spheres*

$$\begin{aligned} &\mathcal{S}_0^{(11)}, \mathcal{S}_1^{(11)}, T^{(11)}(\mathcal{S}_1^{(11)}), R_1^{(11)}T^{(11)}(\mathcal{S}_1^{(11)}), T^{(11)3}R_2^{(11)}R_1^{(11)}(\mathcal{S}_1^{(11)}) \\ &R_1^{(11)}(\mathcal{S}_1^{(11)}), T^{(11)2}R_2^{(11)}R_1^{(11)}(\mathcal{S}_1^{(11)}), T^{(11)}R_2^{(11)}R_1^{(11)}(\mathcal{S}_1^{(11)}), \\ &(R_1^{(11)}R_3^{(11)})^{-1}(\mathcal{S}_2^{(11)}), T^{(11)}(R_1^{(11)}R_3^{(11)})^{-1}(\mathcal{S}_2^{(11)}). \end{aligned}$$

Proof. We will use another fundamental domain of the stabilizer. That is, a prism has vertices $v_1^{\pm 1} = (1/4 - i\sqrt{11}/4, \pm\sqrt{11}/11)$, $v_2^{\pm 1} = (3/4 + i\sqrt{11}/4, \pm\sqrt{11}/11)$, $v_3^{\pm 1} = (-1/4 + i\sqrt{11}/4, \pm\sqrt{11}/11)$. This can be achieved by using cut-and-paste technique. This makes determining the spinal spheres relatively easy for the us.

We need to add sixteen points on the faces of the prism Σ_{11} in order to decompose the prism into nine polyhedra cells, in Heisenberg coordinates, these are given by

$$\begin{aligned}
p_1 &= (0.2, 0.2 \times \sqrt{11}, 0.33166), & p_2 &= (0.2, 0.2 \times \sqrt{11}, -0.27136), \\
p_3 &= (0.31, -0.630159, 0.3196), & p_4 &= (0.31, -0.630159, 0.3196, -0.283421), \\
p_5 &= (0.2, -0.663325, 0.180907), & p_6 &= (1/4, -\sqrt{11}/4, 2\sqrt{11}/33), \\
p_7 &= (0.31, -0.630159, 0.0783929), & p_8 &= (-0.14, 0.464327, 0.53669), \\
p_9 &= (0.1, 0.549808, 0.512165), & p_{10} &= (0.41, 0.469386, 0.454464), \\
p_{11} &= (0.59, 0.298496, 0.404025), & p_{12} &= (-0.23, 0.729657, -0.0180907), \\
p_{13} &= (0.1, 0.759809, -0.0622211), & p_{14} &= (0.62, 0.397995, -0.01809), \\
p_{15} &= (-0.1824, 0.604952, 0.242656), & p_{16} &= (-1/4, \sqrt{11}/4, 78\sqrt{11}/1100), \\
p_{17} &= (0.6716, 0.569133, 0.428629), & p_{18} &= (0.75, 0.829156, 0.063023), \\
p_{19} &= (0.4676, 0.414701, 0.438324), & p_{20} &= (0.578, 0.829156, 0.478197), \\
p_{21} &= (0.35, \sqrt{11}/4, 0.512569), & p_{22} &= (0.08, \sqrt{11}/4, 0.553273), \\
p_{23} &= (0.5825, 0.829156, -0.125504), & p_{24} &= (0.3346, 0.829156, -0.0881318), \\
p_{25} &= (0.08, \sqrt{11}/4, -0.0497494), & p_{26} &= (0.3, 0.709156, -0.0992793), \\
p_{27} &= (0.378801, 0.656463, 0.484678), & p_{28} &= (0.2519, 0.617501, 0.190955), \\
p_{29} &= (0.6179, 0.507112, -0.148374), & p_{30} &= (0.6733, 0.574771, -0.173882), \\
p_{31} &= (0.5264, 0.463121, -0.166961), & p_{32} &= (0.334, 0.596992, -0.1197), \\
p_{33} &= (0.4412, 0.829156, 0.49882), & p_{34} &= (0.18184, 0.829156, -0.0651023), \\
p_{33} &= (0.15, 0.747145, -0.0714856).
\end{aligned}$$

We focus on describing other polyhedral cells in the decomposition of the prism Σ_{11} . Let \mathcal{U}_1 denote the union of $\mathcal{S}_0^{(11)}$, $T^{(11)3}R_2^{(11)}R_1^{(11)}(\mathcal{S}_1^{(11)})$, $T^{(11)2}R_2^{(11)}R_1^{(11)}(\mathcal{S}_1^{(11)})$. We verify that p_{19} is in the intersection of the interiors of these three spinal spheres, which implies that \mathcal{U}_1 is a star-convex set about p_{19} . Analogously, we know \mathcal{U}_2 , denoted by the union of $\mathcal{S}_1^{(11)}$, $(R_1^{(11)}R_3^{(11)})^{-1}(\mathcal{S}_2^{(11)})$, $T^{(11)}(R_1^{(11)}R_3^{(11)})^{-1}(\mathcal{S}_2^{(11)})$, is a star-convex set about the point $(0.3719, 0.7475, 0.4459)$.

We describe the nine polyhedra cells as follows:

- $\mathbb{P}_1^{(11)}$ with vertices v_1^+ , p_1, p_3, p_5, p_6, p_7 ;
- $\mathbb{P}_2^{(11)}$ with vertices v_1^- , p_2, p_4, p_5, p_6, p_7 ;
- $\mathbb{P}_3^{(11)}$ with vertices $p_1, p_3, p_{11}, p_{19}, p_{10}, p_9, p_8, p_2, p_4, p_{14}, p_{31}, p_{32}, p_{13}, p_{12}$;
- $\mathbb{P}_4^{(11)}$ with vertices v_3^+ , $p_8, p_9, p_{15}, p_{16}, p_{22}$;
- $\mathbb{P}_5^{(11)}$ with vertices $p_{10}, p_{27}, p_{21}, p_{25}, p_{13}, p_{28}, p_9, p_{22}, p_{12}, v_3^-, p_{15}, p_{16}$;
- $\mathbb{P}_6^{(11)}$ with vertices $p_{14}, p_{29}, p_{31}, p_{30}$;
- $\mathbb{P}_7^{(11)}$ with vertices $p_{11}, p_{17}, p_{19}, p_{31}, p_{30}, p_{32}, v_2^-, p_{23}, p_{18}$;
- $\mathbb{P}_8^{(11)}$ with vertices $p_{19}, p_{17}, v_2^+, p_{20}, p_{27}, p_{10}, p_{28}, p_{13}, p_{26}, p_{24}, p_{23}, p_{13}, p_{32}$;
- $\mathbb{P}_9^{(11)}$ with vertices $p_{20}, p_{33}, p_{21}, p_{27}, p_{28}, p_{13}, p_{26}, p_{24}, p_{34}, p_{25}$;

By examining the location of the points, we conclude that $\mathbb{P}_1^{(11)}$ is inside the spinal sphere $R_1^{(11)}T^{(11)}(\mathcal{S}_1^{(11)})$; $\mathbb{P}_2^{(11)}$ is inside the spinal sphere $R_1^{(11)}(\mathcal{S}_1^{(11)})$; $\mathbb{P}_3^{(11)}$ is inside the spinal sphere $\mathcal{S}_0^{(11)}$; $\mathbb{P}_4^{(11)}$ is inside the spinal sphere $T^{(11)}(\mathcal{S}_1^{(11)})$; $\mathbb{P}_5^{(11)}$ is inside the spinal sphere $\mathcal{S}_1^{(11)}$; $\mathbb{P}_6^{(11)}$ is inside the spinal sphere $T^{(11)}R_2^{(11)}R_1^{(11)}(\mathcal{S}_1^{(11)})$; $\mathbb{P}_7^{(11)}$ is inside the spinal sphere $T^{(11)2}R_2^{(11)}R_1^{(11)}(\mathcal{S}_1^{(11)})$; $\mathbb{P}_8^{(11)}$ is inside the star-convex set \mathcal{U}_1 ; $\mathbb{P}_9^{(11)}$ is inside the star-convex set \mathcal{U}_2 .

□

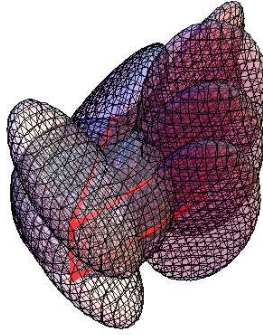

FIGURE 9. The view of neighboring spinal spheres containing the fundamental domain for $(\Gamma_s^{(11)})_\infty$

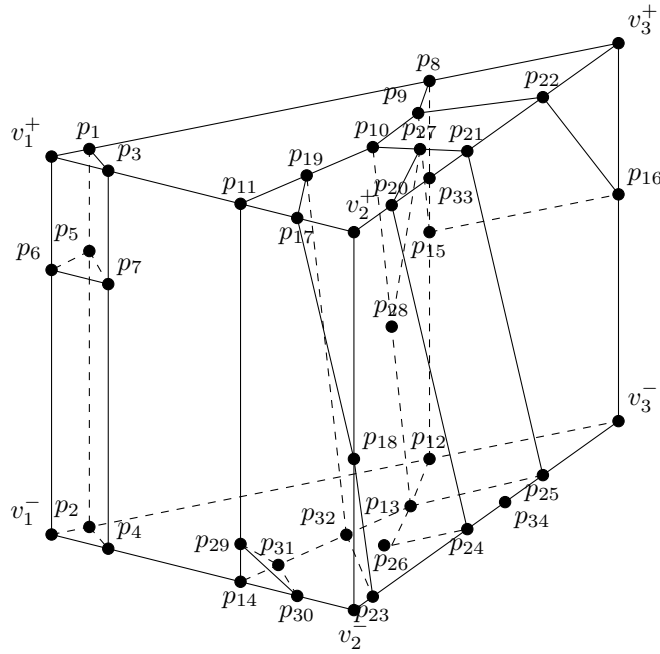

FIGURE 10. The decomposition of the fundamental domain for $(\Gamma_s^{(11)})_\infty$ in Heisenberg group

ACKNOWLEDGEMENTS

The author would like to thank Professor E. Falbel for useful discussions during his visit to Pierre and Marie Curie University. I also thank Jieyan Wang for discussion on this paper. This work was supported by NSF(No.11201134 and No. 11071059).

REFERENCES

- [1] M. Deraux, E. Falbel, and J. Paupert, *New constructions of fundamental polyhedra in complex hyperbolic space*. Acta Math., **194**(2005),155–201.
- [2] M. Deraux, J. R. Parker, and J. Paupert, *New non-arithmetic complex hyperbolic lattices*. arXiv:1401.0308, to appear in Inventiones Mathematicae.
- [3] E. Falbel, J. R. Parker, *The geometry of the Eisenstein-Picard modular group*, Duke Math. J. **131**(2006), 249–289.
- [4] E. Falbel, G. Francsics, J.R. Parker, *The geometry of Gauss-Picard modular group*, Math. Ann. **349**(2011), 459–508.
- [5] E. Falbel, G. Francsics, P.D. Lax, J.R. Parker, *Generators of a Picard modular group in two complex dimensions*, Proc. Amer. Math. Soc. **139**(2011), 2439–2447.
- [6] W. M. Goldman, *Complex Hyperbolic Geometry* (Clarendon, Oxford, 1999).
- [7] G. D. Mostow. *On a remarkable class of polyhedra in complex hyperbolic space*. Pacific J. Mathematics. **86**(1980), 171-276.
- [8] J. R. Parker, *On the volumes of cusped, complex hyperbolic manifolds and orbifolds*. Duke Math. J. **94**:3(1998), 433-464.
- [9] J. R. Parker, *Cone metrics on the sphere and Livné’s lattices*. Acta Math., 196(2006), 1–64.
- [10] J. R. Parker, *Complex hyperbolic lattices*, pp. 1–42 in Discrete groups and geometric structures, edited by K. Dekimpe et al., Contemp. Math. 501, Amer. Math. Soc., Providence, RI, 2009.
- [11] E. Picard, *Sur une extension aux fonctions de deux variables indépendentes analogues aux fonctions modulaires*. Acta. Math. **2**(1883), 114-135.
- [12] E. Picard, *Sur des formes quadratiques ternaires indéfinies indéterminées conjuguées et sur les fonctions hyperfuchsiennes correspondantes*. Acta. Math. **5**(1884), 121-182.
- [13] J. Wang, Y. Xiao and B. Xie, *Generators of the Eisenstein-Picard modular groups*, J. Aust. Math. Soc. **91**(2011), 421–429.
- [14] B. Xie, J. Wang and Y. Jiang, *Generators of the Eisenstein-Picard modular groups in three complex dimensions*, Glasgow. Math. J. **55**(2013), 645–654.
- [15] B. Xie, J. Wang and Y. Jiang, *Generators of the Gauss-Picard modular groups in three complex dimensions*, Pac. J. Math. **273**:1(2015), 197–211.
- [16] T. Zhao, *A minimal volume arithmetic cusped complex hyperbolic orbifold*, Math. Proc. Cambridge Philos. Soc. **150**:2 (2011), 313–342.
- [17] T. Zhao, *Generators for the Euclidean Picard modular groups*, Tran. Amer. Math. Soc. **364**(2012), 3241–3263.

COLLEGE OF MATHEMATICS AND ECONOMETRICS, HUNAN UNIVERSITY, CHANGSHA, 410082, P.R.CHINA

E-mail address: xiexbh@hnu.edu.cn