

Asymptotic solvers for ordinary differential equations with multiple frequencies

Marissa CONDON

School of Electronic Engineering, Dublin City University

E-mail: marissa.condon@dcu.ie

Alfredo DEAÑO

Depto.de Matemáticas, Universidad Carlos III de Madrid

E-mail: alfredo.deanho@uc3m.es

Jing GAO *

School of Mathematics and Statistics, Xi'an Jiaotong University

E-mail: jgao@mail.xjtu.edu.cn

Arieh ISERLES

DAMTP, Centre for Mathematical Sciences, University of Cambridge

E-mail: A.Iserles@damtp.cam.ac.uk

Abstract

We construct asymptotic expansions for ordinary differential equations with highly oscillatory forcing terms, focussing on the case of multiple, non-commensurate frequencies. We derive an asymptotic expansion in inverse powers of the oscillatory parameter and use its truncation as an exceedingly effective means to discretize the differential equation in question. Numerical examples illustrate the effectiveness of the method.

Mathematics Subject Classification: 65L05,65D30,42B20,42A10

*Communicating author

1 Introduction

Our concern in this paper is with the numerical solution of highly oscillatory ordinary differential equations of the form

$$\mathbf{y}'(t) = \mathbf{f}(\mathbf{y}(t)) + \sum_{m=1}^M \mathbf{a}_m(t)e^{i\omega_m t}, \quad t \geq 0, \quad \mathbf{y}(0) = \mathbf{y}_0 \in \mathbb{C}^d, \quad (1.1)$$

where $\mathbf{f} : \mathbb{C}^d \rightarrow \mathbb{C}^d$ and $\mathbf{a}_1, \dots, \mathbf{a}_M : \mathbb{R}_+ \rightarrow \mathbb{C}^d$ are analytic and $\omega_1, \omega_2, \dots, \omega_M \in \mathbb{R} \setminus \{0\}$ are given frequencies. We assume that at least some of these frequencies are large, thereby causing the solution to oscillate and rendering numerical discretization of (1.1) by classical methods expensive and inefficient. Many phenomena in engineer and physics are described by the oscillatory differential equations (Chedjou2001, Fodjouong2007, Slight2008 and so on).

A special case of (1.1) with $\omega_{2m-1} = m\omega, \omega_{2m} = -m\omega, m = 0, 1, \dots, \lfloor M/2 \rfloor$, where $\omega \gg 1$, is a special case of

$$\mathbf{y}'(t) = \mathbf{f}(\mathbf{y}(t)) + G(\mathbf{y}) \sum_{k=-\infty}^{\infty} \mathbf{b}_k(t)e^{ik\omega t}, \quad t \geq 0, \quad \mathbf{y}(0) = \mathbf{y}_0 \in \mathbb{C}^d, \quad (1.2)$$

where $G : \mathbb{C}^d \times \mathbb{C}^d \rightarrow \mathbb{C}^d$ is smooth, which has been already analysed at some length in (Condon, Deaño and Iserles 2010). It has been proved that the solution of (1.2) can be expanded asymptotically in ω^{-1} ,

$$\mathbf{y}(t) \sim \mathbf{p}_{0,0}(t) + \sum_{r=1}^{\infty} \frac{1}{\omega^r} \sum_{m=-\infty}^{\infty} \mathbf{p}_{r,m}(t)e^{im\omega t}, \quad t \geq 0, \quad (1.3)$$

where the functions $\mathbf{p}_{r,m}$, which are independent of ω , can be derived recursively: $\mathbf{p}_{r,0}$ by solving a non-oscillatory ODE and $\mathbf{p}_{r,m}, m \neq 0$, by recursion.

An alternative approach, based upon the Heterogeneous Multiscale Method (E and Engquist 2003), is due to Sanz-Serna (2009). Although the theory in (Sanz-Serna 2009) is presented for a specific equation, it can be extended in a fairly transparent manner to (1.2) and, indeed, to (1.1). It produces the solution in the form

$$\mathbf{y}(t) \sim \sum_{m=-\infty}^{\infty} \boldsymbol{\kappa}_m(t)e^{im\omega t}, \quad (1.4)$$

where $\kappa_m(t) = O(\omega^{-1})$, $m \in \mathbb{Z}$.¹ Formally, (1.3) and (1.4) are linked by

$$\kappa_m(t) = \begin{cases} \sum_{r=0}^{\infty} \frac{1}{\omega^r} \mathbf{p}_{r,0}(t), & m = 0, \\ \sum_{r=1}^{\infty} \frac{1}{\omega^r} \mathbf{p}_{r,m}(t), & m \neq 0. \end{cases}$$

We adopt here the approach of (Condon et al. 2010), because it allows us to derive the expansion in a more explicit form.

The highly oscillatory term in (1.2) is periodic in $t\omega$: the main difference with our model (1.1) is that we allow the more general setting of almost periodic terms (Besicovitch 1932). It is justified by important applications, not least in the modelling of nonlinear circuits (Giannini and Leuzzi 2004, Ramírez, Suárez, Lizarraga and Collantes 2010).

Another difference is that we allow in (1.1) only a finite number of distinct frequencies in the forcing term. This is intended to prevent the occurrence of small denominators, familiar from asymptotic theory (Verhulst 1990). Note that (Chartier, Murua and Sanz-Serna 2012) (cf. also (Chartier, Murua and Sanz-Serna 2010)) employs similar formalism - a finite number of multiple, noncommensurate frequencies - except that it does so within the ‘body’ of the differential operator, rather than in the forcing term.

We commence our analysis by letting $\mathcal{U}_0 = \{1, 2, \dots, M\}$ and $\omega_j = \kappa_j \omega$, $j = 1, \dots, M$, where ω is a large number which will serve as our asymptotic parameter. Consequently, we can rewrite (1.1) in a form that emphasises the similarities and identifies the differences with (1.2),

$$\mathbf{y}'(t) = \mathbf{f}(\mathbf{y}(t)) + \sum_{m \in \mathcal{U}_0} \mathbf{a}_m(t) e^{i\kappa_m \omega t}, \quad t \geq 0, \quad \mathbf{y}(0) = \mathbf{y}_0 \in \mathbb{C}^d, \quad (1.5)$$

Section 2 is devoted to a ‘warm up exercise’, an asymptotic expansion of a linear version of (1.5), namely

$$\mathbf{y}'(t) = \mathbf{A}\mathbf{y}(t) + \sum_{m \in \mathcal{U}_0} \mathbf{a}_m(t) e^{i\kappa_m \omega t}, \quad t \geq 0, \quad \mathbf{y}(0) = \mathbf{y}_0 \in \mathbb{C}^d, \quad (1.6)$$

where \mathbf{A} is a $d \times d$ matrix. Of course, the solution of (1.5) can be written explicitly, but this provides little insight into the real size of different components. The asymptotic expansion is considerably more illuminating, as

¹In the special case considered in (Sanz-Serna 2009) it is true that $\kappa_m(t) = O(\omega^{-|m|})$, $m \in \mathbb{Z}$, but this does not generalise to (1.2).

well as hinting at the general pattern which we might expect once we turn our gaze to the nonlinear equation (1.5).

For the ODE with the highly oscillatory forcing terms with multiple frequencies, the asymptotic method is superior to the standard numerical methods. With less computational expense, this asymptotic method can obtain the higher accuracy. Especially, the asymptotic expansion with a fixed number of terms becomes more accurate when increasing the oscillator parameter ω .

In Section 3 we will demonstrate the existence of sets

$$\mathcal{U}_0 \subseteq \mathcal{U}_1 \subseteq \mathcal{U}_2 \subseteq \cdots$$

and of a mapping

$$\sigma : \bigcup_{r=0}^{\infty} \mathcal{U}_r \rightarrow \mathbb{R}$$

such that the solution of (1.5) can be written in the form

$$\mathbf{y}(t) \sim \mathbf{p}_{0,0}(t) + \sum_{r=1}^{\infty} \frac{1}{\omega^r} \sum_{m \in \mathcal{U}_r} \mathbf{p}_{r,m}(t) e^{i\sigma_m \omega t}, \quad t \geq 0. \quad (1.7)$$

As can be expected, the original parameters $\{\kappa_1, \kappa_2, \dots, \kappa_M\}$ form a subset of \mathcal{U}_r . However, we will see in the sequel that the set $\sigma(\mathcal{U}_r)$ is substantially larger for $r \geq 3$. In the sequel we refer to elements of $\sigma(\mathcal{U}_r)$ as $\{\sigma_m : m \in \mathcal{U}_r\}$.

The functions $\mathbf{p}_{r,m}$, which are all independent of ω , are constructed explicitly in a recursive manner. We will demonstrate that the sets \mathcal{U}_r are composed of n -tuples of nonnegative integers.

In Section 4 we accompany our narrative by a number of computational results. Setting the error functions are represented as

$$\boldsymbol{\epsilon}_s(t, \omega) = \mathbf{y}(t) - \mathbf{p}_{0,0}(t) - \sum_{r=1}^s \frac{1}{\omega^r} \sum_{m \in \mathcal{U}_r} \mathbf{p}_{r,m}(t) e^{i\sigma_m \omega t},$$

we plot the error functions in the figures to illustrate the theoretical analysis. The expansion solvers are convergent asymptotically. That is, for every $\varepsilon > 0$, fixed s , the bounded interval for t , there exists $\omega_0 > 0$ such that for $\omega > \omega_0$, the error function $|\boldsymbol{\epsilon}_s(t, \omega)| < \varepsilon$. However, for increasing s , fixed t and ω , we will come to the convergence of the expansion in future paper.

2 The linear case

Our concern in this section is with the linear highly oscillatory ODE (1.6), which we recall for convenience,

$$\mathbf{y}' = \mathbf{A}\mathbf{y} + \sum_{m \in \mathcal{U}_0} \mathbf{a}_m(t) e^{i\kappa_m \omega t}, \quad t \geq 0, \quad \mathbf{y}(0) = \mathbf{y}_0 \in \mathbb{C}^d, \quad (2.1)$$

Its closed-form solution can be derived at once from standard variation of constants,

$$\mathbf{y}(t) = e^{tA} \mathbf{y}_0 + e^{tA} \sum_{m \in \mathcal{U}_0} \int_0^t e^{-xA} \mathbf{a}_m(x) e^{i\kappa_m \omega x} dx. \quad (2.2)$$

However, the finer structure of the solution is not apparent from (2.2) without some extra work. Each of the integrals hides an entire hierarchy of scales, and this becomes apparent once we expand them asymptotically.

The asymptotic expansion of integrals with simple exponential operators is well known: given $g \in C^\infty[0, t]$ and $|\eta| \gg 1$,

$$\int_0^t g(x) e^{i\eta x} dx \sim - \sum_{r=1}^{\infty} \frac{1}{(-i\eta)^r} \left[g^{(r-1)}(t) e^{i\eta t} - g^{(r-1)}(0) \right]$$

(Iserles, Nørsett and Olver 2006). For any $m \in \mathcal{U}_0$ we thus take $\mathbf{g}(x) = e^{-xA} \mathbf{a}_m(x)$ and $\eta = \kappa_m \omega$ (recall that $\kappa_m \neq 0$), therefore

$$\begin{aligned} \mathbf{y}(t) &\sim e^{tA} \mathbf{y}_0 \\ &- \sum_{m \in \mathcal{U}_0} \sum_{r=1}^{\infty} \frac{1}{(-i\kappa_m \omega)^r} \left[e^{i\kappa_m \omega t} \sum_{\ell=0}^{r-1} (-1)^{r-1-\ell} \binom{r-1}{\ell} A^{r-1-\ell} \mathbf{a}_m^{(\ell)}(t) \right. \\ &\quad \left. - e^{tA} \sum_{\ell=0}^{r-1} (-1)^{r-1-\ell} \binom{r-1}{\ell} A^{r-1-\ell} \mathbf{a}_m^{(\ell)}(0) \right] \\ &= e^{tA} \mathbf{y}_0 + \sum_{r=1}^{\infty} \frac{1}{\omega^r} \sum_{m \in \mathcal{U}_0} \left[\frac{e^{i\kappa_m \omega t}}{(i\kappa_m)^r} \sum_{\ell=0}^{r-1} (-1)^\ell \binom{r-1}{\ell} A^{r-1-\ell} \mathbf{a}_m^{(\ell)}(t) \right. \\ &\quad \left. - \frac{1}{(i\kappa_m)^r} e^{tA} \sum_{\ell=0}^{r-1} (-1)^\ell \binom{r-1}{\ell} A^{r-1-\ell} \mathbf{a}_m^{(\ell)}(0) \right]. \end{aligned}$$

We deduce the expansion (1.7), with $\mathcal{U}_m = \{0\} \cup \mathcal{U}_0 = \{0, 1, \dots, M\}$, $m \in \mathbb{N}$, and the coefficients

$$\mathbf{p}_{0,0}(t) = e^{tA} \mathbf{y}_0,$$

$$\begin{aligned}\mathbf{p}_{r,0}(t) &= -e^{tA} \sum_{\ell=0}^{r-1} (-1)^\ell \binom{r-1}{\ell} A^{r-1-\ell} \sum_{m \in \mathcal{U}_0} \frac{\mathbf{a}_m^{(\ell)}(0)}{(i\kappa_m)^r}, \quad r \in \mathbb{N}, \\ \mathbf{p}_{r,m}(t) &= \frac{1}{(i\kappa_m)^r} \sum_{\ell=0}^{r-1} (-1)^\ell \binom{r-1}{\ell} A^{r-1-\ell} \mathbf{a}_m^{(\ell)}(t), \quad r \in \mathbb{N}, \quad m \in \mathcal{U}_0.\end{aligned}$$

We thus recover an expansion of the form (1.7), where $\sigma_0 = 0$ and $\sigma_m = \kappa_m$, $m \in \mathcal{U}_0$. Note that linearity ‘locks’ frequencies: each $\mathbf{p}_{r,m}$ depends just on \mathbf{a}_m , $m \in \mathcal{U}_0$. This is no longer true in a nonlinear setting.

3 The asymptotic expansion

3.1 The recurrence relations

We are concerned with expanding asymptotically the solution of

$$\mathbf{y}' = \mathbf{f}(\mathbf{y}) + \sum_{m \in \mathcal{U}_0} \mathbf{a}_m(t) e^{i\kappa_m \omega t}, \quad t \geq 0, \quad \mathbf{y}(0) = \mathbf{y}_0 \in \mathbb{C}^d, \quad (3.1)$$

The function f is analytic, thus for every $n \in \mathbb{N}$ there exists the n th differential of \mathbf{f} , a function $\mathbf{f}_n : \overbrace{\mathbb{C}^d \times \mathbb{C}^d \times \mathbb{C}^d}^{n \text{ times}} \rightarrow \mathbb{C}^d$ such that for every sufficiently small $|\varepsilon| > 0$

$$\mathbf{f}(\mathbf{y}_0 + t\varepsilon) = \mathbf{f}(\mathbf{y}_0) + \sum_{n=1}^{\infty} \frac{t^n}{n!} \mathbf{f}_n(\mathbf{y}_0)[\varepsilon, \dots, \varepsilon].$$

Note that \mathbf{f}_n is linear in all its arguments in the square brackets.

We substitute (1.7) in both sides of (3.1) and expand about $\mathbf{p}_{0,0}(t)$,

$$\begin{aligned}\mathbf{y}' &= \mathbf{p}'_{0,0} + \sum_{m \in \mathcal{U}_1} i\sigma_m \mathbf{p}_{1,m} e^{i\sigma_m \omega t} \\ &\quad + \sum_{r=1}^{\infty} \frac{1}{\omega^r} \left[\sum_{m \in \mathcal{U}_r} \mathbf{p}'_{r,m} e^{i\sigma_m \omega t} + i\sigma_m \sum_{m \in \mathcal{U}_{r+1}} \mathbf{p}_{r+1,m} e^{i\sigma_m \omega t} \right] \\ &= \mathbf{f} \left(\mathbf{p}_{0,0} + \sum_{r=1}^{\infty} \frac{1}{\omega^r} \sum_{m \in \mathcal{U}_r} \mathbf{p}_{r,m} e^{i\sigma_m \omega t} \right) + \sum_{m \in \mathcal{U}_0} \mathbf{a}_m e^{i\kappa_m \omega t} \\ &= \mathbf{f}(\mathbf{p}_{0,0}) + \sum_{n=1}^{\infty} \frac{1}{n!} \mathbf{f}_n(\mathbf{p}_{0,0}) \left[\sum_{\ell_1=1}^{\infty} \frac{1}{\omega^{\ell_1}} \sum_{k_1 \in \mathcal{U}_{\ell_1}} \mathbf{p}_{\ell_1, k_1} e^{i\sigma_{k_1} \omega t}, \dots, \right.\end{aligned}$$

$$\begin{aligned}
& \left. \sum_{\ell_n=1}^{\infty} \frac{1}{\omega^{\ell_n}} \sum_{k_n \in \mathcal{U}_{\ell_n}} \mathbf{p}_{\ell_n, k_n} e^{i\sigma_{k_n} \omega t} \right] + \sum_{m \in \mathcal{U}_0} \mathbf{a}_m e^{i\kappa_m \omega t} \\
= & \mathbf{f}(\mathbf{p}_{0,0}) + \sum_{n=1}^{\infty} \frac{1}{n!} \sum_{\ell_1=1}^{\infty} \cdots \sum_{\ell_n=1}^{\infty} \frac{1}{\omega^{\ell_1 + \ell_2 + \cdots + \ell_n}} \sum_{k_1 \in \mathcal{U}_{\ell_1}} \cdots \sum_{k_n \in \mathcal{U}_{\ell_n}} \mathbf{f}_n(\mathbf{p}_{0,0}) [\mathbf{p}_{\ell_1, k_1}, \\
& \cdots, \mathbf{p}_{\ell_n, k_n}] e^{i(\sigma_{k_1} + \cdots + \sigma_{k_n}) \omega t} + \sum_{m \in \mathcal{U}_0} \mathbf{a}_m e^{i\kappa_m \omega t} \\
= & \mathbf{f}(\mathbf{p}_{0,0}) + \sum_{n=1}^{\infty} \frac{1}{n!} \sum_{r=n}^{\infty} \frac{1}{\omega^r} \sum_{\ell \in \mathbb{I}_{n,r}^o} \sum_{k_1 \in \mathcal{U}_{\ell_1}} \cdots \sum_{k_n \in \mathcal{U}_{\ell_n}} \mathbf{f}_n(\mathbf{p}_{0,0}) [\mathbf{p}_{\ell_1, k_1}, \cdots, \mathbf{p}_{\ell_n, k_n}] \\
& \times e^{i(\sigma_{k_1} + \cdots + \sigma_{k_n}) \omega t} + \sum_{m \in \mathcal{U}_0} \mathbf{a}_m e^{i\kappa_m \omega t} \\
= & \mathbf{f}(\mathbf{p}_{0,0}) + \sum_{r=1}^{\infty} \frac{1}{\omega^r} \sum_{n=1}^r \frac{1}{n!} \sum_{\ell \in \mathbb{I}_{n,r}^o} \sum_{k_1 \in \mathcal{U}_{\ell_1}} \cdots \sum_{k_n \in \mathcal{U}_{\ell_n}} \mathbf{f}_n(\mathbf{p}_{0,0}) [\mathbf{p}_{\ell_1, k_1}, \cdots, \mathbf{p}_{\ell_n, k_n}] \\
& \times e^{i(\sigma_{k_1} + \cdots + \sigma_{k_n}) \omega t} + \sum_{m \in \mathcal{U}_0} \mathbf{a}_m e^{i\kappa_m \omega t}
\end{aligned}$$

where

$$\mathbb{I}_{n,r}^o = \{\ell \in \mathbb{N}^n : \ell^T \mathbf{1} = r\}, \quad 1 \leq n \leq r.$$

There is a measure of redundancy in the last expression: for example there are two terms in $\mathbb{I}_{2,3}^o$, namely (1,2) and (2,1), but they produce identical expressions. Consequently, we may lump them together, paying careful attention to their multiplicity. More formally, we let

$$\mathbb{I}_{n,r} = \{\ell \in \mathbb{N}^n : \ell^T \mathbf{1} = r, \ell_1 \leq \ell_2 \leq \cdots \leq \ell_n\}, \quad 1 \leq n \leq r,$$

the set of ordered partitions of r into n natural numbers and allow θ_{ℓ} stand for the *multiplicity* of ℓ , i.e. the number of terms in $\mathbb{I}_{n,r}^o$ that can be brought to it by permutations. For example, $\theta_{1,2} = 2$, while for $r = 4$ there are five terms,

$$\theta_4 = 1, \quad \theta_{1,3} = 2, \quad \theta_{2,2} = 1, \quad \theta_{1,1,2} = 3, \quad \theta_{1,1,1,1} = 1.$$

We introduce the multiplicity and obtain a more compact form for the equation

$$\mathbf{p}'_{0,0} + \sum_{m \in \mathcal{U}_1} i\sigma_m \mathbf{p}_{1,m} e^{i\sigma_m \omega t} \tag{3.2}$$

$$\begin{aligned}
& + \sum_{r=1}^{\infty} \frac{1}{\omega^r} \left[\sum_{m \in \mathcal{U}_r} \mathbf{p}'_{r,m} e^{i\sigma_m \omega t} + \sum_{m \in \mathcal{U}_{r+1}} i\sigma_m \mathbf{p}_{r+1,m} e^{i\sigma_m \omega t} \right] \\
= & \mathbf{f}(\mathbf{p}_{0,0}) + \sum_{r=1}^{\infty} \frac{1}{\omega^r} \sum_{n=1}^r \frac{1}{n!} \sum_{\ell \in \mathbb{I}_{n,r}} \theta_{\ell} \sum_{k_1 \in \mathcal{U}_{\ell_1}} \cdots \sum_{k_n \in \mathcal{U}_{\ell_n}} \mathbf{f}_n(\mathbf{p}_{0,0}) [\mathbf{p}_{\ell_1, k_1}, \dots, \mathbf{p}_{\ell_n, k_n}] \\
& \times e^{i(\sigma_{k_1} + \dots + \sigma_{k_n}) \omega t} + \sum_{m \in \mathcal{U}_0} \mathbf{a}_m e^{i\kappa_m \omega t}.
\end{aligned}$$

We separate different powers of ω in (3.2). The outcome is

$$\mathbf{p}'_{0,0} + \sum_{m \in \mathcal{U}_1} i\sigma_m \mathbf{p}_{1,m} e^{i\sigma_m \omega t} = \mathbf{f}(\mathbf{p}_{0,0}) + \sum_{m \in \mathcal{U}_0} \mathbf{a}_m e^{i\kappa_m \omega t}. \quad (3.3)$$

for $r = 0$ and

$$\begin{aligned}
& \sum_{m \in \mathcal{U}_r} \mathbf{p}'_{r,m} e^{i\sigma_m \omega t} + \sum_{m \in \mathcal{U}_{r+1}} i\sigma_m \mathbf{p}_{r+1,m} e^{i\sigma_m \omega t} \\
= & \sum_{n=1}^r \frac{1}{n!} \sum_{\ell \in \mathbb{I}_{n,r}} \theta_{\ell} \sum_{k_1 \in \mathcal{U}_{\ell_1}} \cdots \sum_{k_n \in \mathcal{U}_{\ell_n}} \mathbf{f}_n(\mathbf{p}_{0,0}) [\mathbf{p}_{\ell_1, k_1}, \dots, \mathbf{p}_{\ell_n, k_n}] e^{i(\sigma_{k_1} + \dots + \sigma_{k_n}) \omega t}
\end{aligned} \quad (3.4)$$

for $r \in \mathbb{N}$.

Before we embark on detailed examination of the cases $r = 0, 1, 2$, followed by the general case, we must impose an additional set of conditions on the coefficients $\mathbf{p}_{r,m}$. Similarly to the expansion of (1.2) in (Condon et al. 2010), we obtain non-oscillatory differential equations for the coefficients $\mathbf{p}_{r,0}$, $r \in \mathbb{Z}_+$, which require initial conditions. We do so by imposing the original initial condition from (3.1) on $\mathbf{p}_{0,0}$ and requiring that the terms at origin sum to zero at every ω scale. In other words,

$$\mathbf{p}_{0,0}(0) = \mathbf{y}_0, \quad \mathbf{p}_{r,0}(0) = - \sum_{m \in \mathcal{U}_r \setminus \{0\}} \mathbf{p}_{r,m}(0), \quad r \in \mathbb{N}. \quad (3.5)$$

3.2 The first few values of r

The expansion (1.7) exhibits two distinct hierarchies of scales: both *amplitudes* ω^{-r} for $r \in \mathbb{Z}_+$ and, for each $r \in \mathbb{N}$, *frequencies* $e^{i\sigma_m \omega t}$. In (3.3) and (3.4) we have already separated amplitudes. Next we separate frequencies.

For $r = 0$ (3.3) and (3.5) yield the original ODE (3.1) without a forcing term,

$$\mathbf{p}'_{0,0} = \mathbf{f}(\mathbf{p}_{0,0}), \quad t \geq 0, \quad \mathbf{p}_{0,0}(0) = \mathbf{y}_0,$$

as well as the recursions

$$\mathbf{p}_{1,m} = \frac{\mathbf{a}_m}{i\kappa_m}, \quad m = 1, \dots, M$$

(recall that $\kappa_m \neq 0$). Therefore $\sigma_m = \kappa_m$, $m = 1, \dots, M$. We set, for reasons that will become apparent in the sequel,

$$\mathcal{U}_1 = \{0\} \cup \mathcal{U}_0 = \{0, 1, \dots, M\},$$

with $\sigma_0 = 0$.

For $r = 1$ we have $\mathbb{I}_{1,1} = \{1\}$, $\theta_1 = 1$, and (3.4) yields

$$\sum_{m \in \mathcal{U}_1} \mathbf{p}'_{1,m} e^{i\sigma_m \omega t} + \sum_{m \in \mathcal{U}_2} i\sigma_m \mathbf{p}_{2,m} e^{i\sigma_m \omega t} = \sum_{m \in \mathcal{U}_1} \mathbf{f}_1(\mathbf{p}_{0,0}) [\mathbf{p}_{1,m}] e^{i\sigma_m \omega t}.$$

We set

$$\mathcal{U}_2 = \mathcal{U}_1 = \{0, 1, \dots, M\}$$

and (recalling that $\mathbf{p}_{1,m}$ are already known for $m \neq 0$)

$$\begin{aligned} \mathbf{p}'_{1,0} &= \mathbf{f}_1(\mathbf{p}_{0,0})[\mathbf{p}_{1,0}], \quad t \geq 0, \quad \mathbf{p}_{1,0}(0) = - \sum_{m \in \mathcal{U}_1 \setminus \{0\}} \mathbf{p}_{1,m}(0), \\ \mathbf{p}_{2,m} &= \frac{1}{i\kappa_m} \{ \mathbf{f}_1(\mathbf{p}_{0,0})[\mathbf{p}_{1,m}] - \mathbf{p}'_{1,m} \}, \quad m \in \mathcal{U}_2 \setminus \{0\}. \end{aligned}$$

An explanation is in order with regard to our imposition of $0 \in \mathcal{U}_1$. We could have accounted for all the $r = 1$ terms in (3.4) without any need of the $\mathbf{p}_{1,0}$ term. However, in that case the outcome would not have been consistent with the initial condition (3.5) and this is the rationale for the addition of this term.

Our next case is $r = 2$. The case is not so straightforward to deduce. Since $\mathbb{I}_{1,2} = \{2\}$ and $\mathbb{I}_{2,2} = \{(1, 1)\}$, we have from (3.4)

$$\begin{aligned} \sum_{m \in \mathcal{U}_2} \mathbf{p}'_{2,m} e^{i\sigma_m \omega t} + \sum_{m \in \mathcal{U}_3} i\sigma_m \mathbf{p}_{3,m} e^{i\sigma_m \omega t} &= \sum_{m \in \mathcal{U}_2} \mathbf{f}_1(\mathbf{p}_{0,0}) [\mathbf{p}_{2,m}] e^{i\sigma_m \omega t} \\ + \frac{1}{2} \sum_{m_1 \in \mathcal{U}_1} \sum_{m_2 \in \mathcal{U}_1} \mathbf{f}_2(\mathbf{p}_{0,0}) [\mathbf{p}_{1,m_1}, \mathbf{p}_{1,m_2}] e^{i(\sigma_{m_1} + \sigma_{m_2}) \omega t}. \end{aligned} \quad (3.6)$$

We need to choose \mathcal{U}_3 to match frequencies in the above formula. The set \mathcal{U}_2 accounts for the frequencies $0, \kappa_1, \kappa_2, \dots, \kappa_M$ but we must also account for $\kappa_i + \kappa_j$ for $i, j = 1, 2, \dots, M$. Therefore we let

$$\mathcal{U}_3 = \mathcal{U}_2 \cup \{(m_1, m_2) : 0 \leq m_1 \leq m_2 \leq M\}.$$

We note two important points. Firstly, for $i \neq j$, $\kappa_i + \kappa_j$ can be obtained for (j, i) , as well as for (i, j) . Secondly, it might well happen that there exist $i, j, k \in \{1, \dots, M\}$, $i \leq j$, such that $\kappa_i + \kappa_j = \kappa_k$ - in that case we do not include (i, j) in \mathcal{U}_3 . This motivates the definition of the *multiplicity* of $m \in \mathcal{U}_3 \setminus \mathcal{U}_2$ (which we will generalise in the sequel to all sets \mathcal{U}_r). Thus, for every $0 \leq \ell_1 \leq \ell_2 \leq M$ we let ρ_{ℓ_1, ℓ_2}^m equal the number of cases when $\kappa_{\pi(\ell_1)} + \kappa_{\pi(\ell_2)} = \kappa_m$, where $\pi(\ell)$ is a permutation of ℓ . Likewise, we let $\rho_{\ell_1, \ell_2}^{m_1, m_2}$, where $0 \leq \ell_1 \leq \ell_2 \leq M$ and $1 \leq m_1 \leq m_2 \leq M$, be the number of permutations such that $\kappa_{\pi(\ell_1)} + \kappa_{\pi(\ell_2)} = \kappa_{m_1} + \kappa_{m_2}$.

We can now separate frequencies. Firstly, the non-oscillatory term, corresponding to $\sigma_0 = 0$. It yields the non-oscillatory ODE

$$\mathbf{p}'_{2,0} = \mathbf{f}_1(\mathbf{p}_{0,0})[\mathbf{p}_{2,0}] + \frac{1}{2} \sum_{\substack{\kappa_{\ell_1} + \kappa_{\ell_2} = 0 \\ \ell_1 \leq \ell_2}} \rho_{\ell_1, \ell_2}^0 \mathbf{f}_2(\mathbf{p}_{0,0})[\mathbf{p}_{1, \ell_1}, \mathbf{p}_{1, \ell_2}],$$

whose initial condition, according to (3.5), is

$$\mathbf{p}_{2,0}(0) = - \sum_{m \in \mathcal{U}_2 \setminus \{0\}} \mathbf{p}_{2,m}(0).$$

Secondly, we match all the terms in $\mathcal{U}_2 \setminus \{0\}$, and this results in the recurrence

$$i\kappa_m \mathbf{p}_{3,m} = \mathbf{f}_1(\mathbf{p}_{0,0})[\mathbf{p}_{2,m}] - \mathbf{p}'_{2,m} + \frac{1}{2} \sum_{\substack{\kappa_{\ell_1} + \kappa_{\ell_2} = \kappa_m \\ \ell_1 \leq \ell_2}} \rho_{\ell_1, \ell_2}^m \mathbf{f}_2(\mathbf{p}_{0,0})[\mathbf{p}_{1, \ell_1}, \mathbf{p}_{1, \ell_2}].$$

Finally, we match the terms in $\mathcal{U}_3 \setminus \mathcal{U}_2$. Recall that these are pairs (m_1, m_2) such that $m_1 \leq m_2$ and $\kappa_{m_1} + \kappa_{m_2} \neq \sigma_j$ for $j = 0, 1, \dots, M$. We obtain the recurrence

$$i(\kappa_{m_1} + \kappa_{m_2}) \mathbf{p}_{3, (m_1, m_2)} = \frac{1}{2} \sum_{\substack{\kappa_{\ell_1} + \kappa_{\ell_2} = \kappa_{m_1} + \kappa_{m_2} \\ \ell_1 \leq \ell_2}} \rho_{\ell_1, \ell_2}^{m_1, m_2} \mathbf{f}_2(\mathbf{p}_{0,0})[\mathbf{p}_{1, \ell_1}, \mathbf{p}_{1, \ell_2}].$$

(There is no danger of dividing by zero since we have ensured that $\kappa_{m_1} + \kappa_{m_2} \neq \sigma_0 = 0$.) This accounts for all the terms in (3.6).

3.3 The general case $r \geq 1$

We consider the ‘level r ’ equations (3.4) noting that, by induction, the sets \mathcal{U}_ℓ are known for $\ell = 1, 2, \dots, r$ and $0 \in \mathcal{U}_r$. Moreover, we have already constructed all the functions $\mathbf{p}_{\ell, m}$ s for $m \in \mathcal{U}_\ell \setminus \{0\}$, $\ell = 1, 2, \dots, r$, and all the $\mathbf{p}_{\ell, 0}$ s for $\ell = 0, 1, \dots, r-1$. The current task is to construct the set \mathcal{U}_{r+1} , the functions $\mathbf{p}_{r+1, m}$ for $m \in \mathcal{U}_{r+1} \setminus \{0\}$ and the function $\mathbf{p}_{r, 0}$.

It will follow soon that all the terms in \mathcal{U}_{r+1} are of the form $\kappa_{j_1} + \kappa_{j_2} + \dots + \kappa_{j_q}$, where $q \leq r$ and $j_1 \leq j_2 \leq \dots \leq j_q$. We commence by setting $\rho_{\ell_1, \ell_2, \dots, \ell_p}^{m_1, m_2, \dots, m_q}$ as the number of distinct p -tuples $(\ell_1, \ell_2, \dots, \ell_p)$, where

$$\ell_1, \ell_2, \dots, \ell_p, m_1, m_2, \dots, m_q \in \{0, 1, \dots, M\}, \quad m_1 \leq m_2 \leq \dots \leq m_q,$$

such that

$$\sum_{i=1}^p \kappa_{\ell_i} = \sum_{i=1}^q \kappa_{m_i}.$$

Examining the formula (3.4) we observe that the terms on the right hand side have exponents of the form $e^{i\eta\omega t}$, where

$$\eta = \sigma_{k_1} + \sigma_{k_2} + \dots + \sigma_{k_n}, \quad \sigma_{k_i} \in \mathcal{U}_{\ell_i}, \quad i = 1, \dots, n, \quad \ell \in \mathbb{I}_{r, n}$$

for some $n \in \{1, 2, \dots, r\}$. It follows at once by induction on r that there exist $q \in \{1, 2, \dots, r\}$ and $0 \leq m_1 \leq m_2 \leq \dots \leq m_q \leq M$ such that

$$\eta = \sum_{i=1}^q \kappa_{m_i}.$$

It might well be that such η can be already accounted by \mathcal{U}_r , in other words that there exists $m \in \mathcal{U}_r$ such that $\eta = \sigma_m$. Otherwise we add to \mathcal{U}_r the ordered q -tuple (m_1, m_2, \dots, m_q) . This process, applied to all the terms on the right of (3.4), produces the index set \mathcal{U}_{r+1}

$$\mathcal{U}_{r+1} = \mathcal{U}_r \cup \{(m_1, \dots, m_q) : 0 \leq m_1 \leq m_2 \leq \dots \leq m_q \leq M, q \in 1, 2, \dots, r\}.$$

We impose natural partial ordering on \mathcal{U}_r : first the singletons in lexicographic ordering, then the pairs in lexicographic ordering, then the triplets etc. This defines a relation $m_1 \preceq m_2$ for all $m_1, m_2 \in \mathcal{U}_r$. We let

$$\mathcal{W}_{r, m}^n = \left\{ (\ell, \mathbf{k}) : k_i \in \mathcal{U}_{\ell_i}, \ell \in \mathbb{I}_{n, r}, \sum_{i=1}^n \sigma_{k_i} = \sum_{i=1}^q \sigma_{m_i}, k_1 \preceq \dots \preceq k_n, m_1 \leq \dots \leq m_q \right\},$$

where $m \in \mathcal{U}_r$ and $n \in \{1, 2, \dots, r\}$.

Let us commence our construction of recurrence relations by considering $m \in \mathcal{U}_r \setminus \{0\}$. In that case we have

$$\begin{aligned} i\sigma_m \mathbf{p}_{r+1,m} &= -\mathbf{p}'_{r,m} \\ &+ \sum_{n=1}^r \frac{1}{n!} \sum_{\ell \in \mathbb{I}_{n,r}} \theta_\ell \sum_{(\ell, \mathbf{k}) \in \mathcal{W}_{r,m}^n} \rho_{\mathbf{k}}^m \mathbf{f}_n(\mathbf{p}_{0,0}) [\mathbf{p}_{\ell_1, k_1}, \dots, \mathbf{p}_{\ell_n, k_n}]. \end{aligned} \quad (3.7)$$

Next we consider $m \in \mathcal{U}_{r+1} \setminus \mathcal{U}_r$. Now the first sum on the left of (3.4) disappears and the outcome is

$$i\sigma_m \mathbf{p}_{r+1,m} = \sum_{n=1}^r \frac{1}{n!} \sum_{\ell \in \mathbb{I}_{n,r}} \theta_\ell \sum_{(\ell, \mathbf{k}) \in \mathcal{W}_{r,m}^n} \rho_{\mathbf{k}}^m \mathbf{f}_n(\mathbf{p}_{0,0}) [\mathbf{p}_{\ell_1, k_1}, \dots, \mathbf{p}_{\ell_n, k_n}]. \quad (3.8)$$

Finally we cater for the case $m = 0$: now the recurrence is a non-oscillatory ODE,

$$\mathbf{p}'_{r,0} = \sum_{n=1}^r \frac{1}{n!} \sum_{\ell \in \mathbb{I}_{n,r}} \theta_\ell \sum_{(\ell, \mathbf{k}) \in \mathcal{W}_{r,0}^n} \rho_{\mathbf{k}}^0 \mathbf{f}_n(\mathbf{p}_{0,0}) [\mathbf{p}_{\ell_1, k_1}, \dots, \mathbf{p}_{\ell_n, k_n}], \quad t \geq 0, \quad (3.9)$$

$$\mathbf{p}_{r,0}(0) = - \sum_{m \in \mathcal{U}_r \setminus \{0\}} \mathbf{p}_{r,m}(0).$$

For example, in the case $r = 3$ we have

$$\mathbb{I}_{1,3} = \{3\}, \quad \mathbb{I}_{2,3} = \{(1, 2)\}, \quad \mathbb{I}_{3,3} = \{(1, 1, 1)\}, \quad \theta_3 = \theta_{1,1,1} = 1, \quad \theta_{1,2} = 2,$$

while

$$\mathcal{U}_3 = \{0, 1, \dots, M\} \cup \{(m_1, m_2) : m_1 \leq m_2, \kappa_{m_1} + \kappa_{m_2} \neq \kappa_m, \quad \forall m = 0, \dots, M\}.$$

We thus deduce from (3.7) that

$$\begin{aligned} i\kappa_m \mathbf{p}_{4,m} &= -\mathbf{p}'_{3,m} + \mathbf{f}_1(\mathbf{p}_{0,0})[\mathbf{p}_{3,m}] + \sum_{\substack{\kappa_{j_1} + \kappa_{j_2} = \kappa_m \\ j_1 \leq j_2}} \rho_{j_1, j_2}^m \mathbf{f}_2(\mathbf{p}_{0,0})[\mathbf{p}_{1, j_1}, \mathbf{p}_{2, j_2}] \\ &+ \frac{1}{6} \sum_{\substack{\kappa_{j_1} + \kappa_{j_2} + \kappa_{j_3} = \kappa_m \\ j_1 \leq j_2 \leq j_3}} \rho_{j_1, j_2, j_3}^m \mathbf{f}_3(\mathbf{p}_{0,0})[\mathbf{p}_{1, j_1}, \mathbf{p}_{1, j_2}, \mathbf{p}_{1, j_3}] \end{aligned}$$

for all $m \in \mathcal{U}_2 \setminus \{0\}$ and

$$\begin{aligned}
i(\kappa_{m_1} + \kappa_{m_2})\mathbf{p}_{4,(m_1,m_2)} &= -\mathbf{p}'_{3,(m_1,m_2)} + \mathbf{f}_1(\mathbf{p}_{0,0})[\mathbf{p}_{3,(m_1,m_2)}] \\
&+ \sum_{\substack{\kappa_{j_1} + \kappa_{j_2} = \kappa_{m_1} + \kappa_{m_2} \\ j_1 \leq j_2}} \rho_{j_1,j_2}^{m_1,m_2} \mathbf{f}_2(\mathbf{p}_{0,0})[\mathbf{p}_{1,j_1}, \mathbf{p}_{2,j_2}] \\
&+ \frac{1}{6} \sum_{\substack{\kappa_{j_1} + \kappa_{j_2} + \kappa_{j_3} = \kappa_{m_1} + \kappa_{m_2} \\ j_1 \leq j_2 \leq j_3}} \rho_{j_1,j_2,j_3}^{m_1,m_2} \mathbf{f}_3(\mathbf{p}_{0,0})[\mathbf{p}_{1,j_1}, \mathbf{p}_{1,j_2}, \mathbf{p}_{1,j_3}]
\end{aligned}$$

for $(m_1, m_2) \in \mathcal{U}_3 \setminus \mathcal{U}_2$. Next we use (3.8):

$$\begin{aligned}
&i(\kappa_{m_1} + \kappa_{m_2} + \kappa_{m_3})\mathbf{p}_{4,(m_1,m_2,m_3)} \\
&= \frac{1}{6} \sum_{\substack{\kappa_{j_1} + \kappa_{j_2} + \kappa_{j_3} = \kappa_{m_1} + \kappa_{m_2} + \kappa_{m_3} \\ j_1 \leq j_2 \leq j_3}} \rho_{j_1,j_2,j_3}^{m_1,m_2,m_3} \mathbf{f}_3(\mathbf{p}_{0,0})[\mathbf{p}_{1,j_1}, \mathbf{p}_{1,j_2}, \mathbf{p}_{1,j_3}]
\end{aligned}$$

for all $1 \leq m_1 \leq m_2 \leq m_3 \leq M$ such that $\kappa_{m_1} + \kappa_{m_2} + \kappa_{m_3} \neq \sigma_m$ for $m \in \mathcal{U}_3$.

Finally, we invoke (3.9) to derive a non-oscillatory ODE for $\mathbf{p}_{3,0}$, namely

$$\begin{aligned}
\mathbf{p}'_{3,0} &= \mathbf{f}_1(\mathbf{p}_{0,0})[\mathbf{p}_{3,0}] + \sum_{\kappa_{j_1} + \kappa_{j_2} = 0} \rho_{j_1,j_2}^0 \mathbf{f}_2(\mathbf{p}_{0,0})[\mathbf{p}_{1,j_1}, \mathbf{p}_{1,j_2}] \\
&+ \frac{1}{6} \sum_{\substack{\kappa_{j_1} + \kappa_{j_2} + \kappa_{j_3} = 0 \\ j_1 \leq j_2 \leq j_3}} \rho_{j_1,j_2,j_3}^0 \mathbf{f}_3(\mathbf{p}_{0,0})[\mathbf{p}_{1,j_1}, \mathbf{p}_{1,j_2}, \mathbf{p}_{1,j_3}], \\
\mathbf{p}_{3,0}(0) &= - \sum_{m \in \mathcal{U}_3 \setminus \{0\}} \mathbf{p}_{3,m}(0).
\end{aligned}$$

3.4 A worked-out example

Let $M = 3$ and

$$\kappa_1 = 1, \quad \kappa_2 = \sqrt{2}, \quad \kappa_3 = -1 - \sqrt{2}.$$

Therefore $\mathcal{U}_1 = \mathcal{U}_2 = \{0, 1, 2, 3\}$,

$$\sigma_0 = 0, \quad \sigma_1 = 1, \quad \sigma_2 = \sqrt{2}, \quad \sigma_3 = -1 - \sqrt{2}$$

and

$$\rho_k^m = \delta_{k,m}, \quad k, m = 0, 1, 2, 3.$$

Consequently, $\mathbf{p}'_{0,0} = \mathbf{f}(\mathbf{p}_{0,0})$, $\mathbf{p}_{0,0}(0) = \mathbf{y}(0)$ and

$$\mathbf{p}_{1,1} = \frac{\mathbf{a}_1}{i}, \quad \mathbf{p}_{1,2} = \frac{\mathbf{a}_2}{\sqrt{2}i}, \quad \mathbf{p}_{1,3} = -\frac{\mathbf{a}_3}{(1 + \sqrt{2})i}.$$

We commence with $r = 1$. The ODE is now

$$\mathbf{p}'_{1,0} = \mathbf{f}_1(\mathbf{p}_{0,0})[\mathbf{p}_{1,0}], \quad t \geq 0, \quad \mathbf{p}_{1,0}(0) = -\mathbf{p}_{1,1}(0) - \mathbf{p}_{1,2}(0) - \mathbf{p}_{1,3}(0),$$

while the recurrences are

$$\begin{aligned} \mathbf{p}_{2,1} &= \frac{1}{i} \{ \mathbf{f}_1(\mathbf{p}_{0,0})[\mathbf{p}_{1,1}] - \mathbf{p}'_{1,1} \}, & \mathbf{p}_{2,2} &= \frac{1}{\sqrt{2}i} \{ \mathbf{f}_1(\mathbf{p}_{0,0})[\mathbf{p}_{1,2}] - \mathbf{p}'_{1,2} \} \\ \mathbf{p}_{2,3} &= -\frac{1}{(1 + \sqrt{2})i} \{ \mathbf{f}_1(\mathbf{p}_{0,0})[\mathbf{p}_{1,3}] - \mathbf{p}'_{1,3} \}. \end{aligned}$$

Note that the first two "levels" of the expansion are

$$\mathbf{y}(t) \approx \mathbf{p}_{0,0} + \frac{1}{\omega} \left[\mathbf{p}_{1,0} + \mathbf{p}_{1,1}e^{i\omega t} + \mathbf{p}_{1,2}e^{i\sqrt{2}\omega t} + \mathbf{p}_{1,3}e^{-i(1+\sqrt{2})\omega t} \right].$$

Next to $\mathcal{U}_3 = \{0, 1, 2, 3, (1, 1), (1, 2), (1, 3), (2, 2), (2, 3), (3, 3)\}$, with $\sigma_{1,1} = 2$, $\sigma_{1,2} = 1 + \sqrt{2}$, $\sigma_{1,3} = -\sqrt{2}$, $\sigma_{2,2} = 2\sqrt{2}$, $\sigma_{2,3} = -1$ and $\sigma_{3,3} = -2 - 2\sqrt{2}$.

The only way to obtain $\sigma_0 = 0$ using two terms from \mathcal{U}_1 is $0+0$, therefore $\rho_{0,0}^0 = 1$, otherwise $\rho_{\ell_1, \ell_2}^0 = 0$. However, to obtain σ_m for $m = 1, 2, 3$ we have two options: $0+m$ and $m+0$. Therefore $\rho_{0,m}^m = 2$, otherwise $\rho_{\ell_1, \ell_2}^m = 0$. For $\rho_{\ell_1, \ell_2}^{m_1, m_2}$ we note that $\rho_{1,1}^{1,1} = \rho_{2,2}^{2,2} = \rho_{3,3}^{3,3} = 1$, $\rho_{1,2}^{1,2} = \rho_{1,3}^{1,3} = \rho_{2,3}^{2,3} = 2$, otherwise the coefficient is zero. Therefore

$$\begin{aligned} \mathbf{p}'_{2,0} &= \mathbf{f}_1(\mathbf{p}_{0,0})[\mathbf{p}_{2,0}] + \frac{1}{2} \mathbf{f}_2(\mathbf{p}_{0,0})[\mathbf{p}_{1,0}, \mathbf{p}_{1,0}], \\ \mathbf{p}_{2,0}(0) &= -\mathbf{p}_{2,1}(0) - \mathbf{p}_{2,2}(0) - \mathbf{p}_{2,3}(0), \end{aligned}$$

and the $O(\omega^{-2})$ terms are

$$\frac{1}{\omega^2} [\mathbf{p}_{2,0} + \mathbf{p}_{2,1}e^{i\omega t} + \mathbf{p}_{2,2}e^{i\sqrt{2}\omega t} + \mathbf{p}_{2,3}e^{-i(1+\sqrt{2})\omega t}].$$

Moreover,

$$\begin{aligned} \mathbf{p}_{3,1} &= \frac{1}{i} \{ \mathbf{f}_1(\mathbf{p}_{0,0})[\mathbf{p}_{2,1}] - \mathbf{p}'_{2,1} + \mathbf{f}_2(\mathbf{p}_{0,0})[\mathbf{p}_{1,0}, \mathbf{p}_{1,1}] \}, \\ \mathbf{p}_{3,2} &= \frac{1}{\sqrt{2}i} \{ \mathbf{f}_1(\mathbf{p}_{0,0})[\mathbf{p}_{2,2}] - \mathbf{p}'_{2,2} + \mathbf{f}_2(\mathbf{p}_{0,0})[\mathbf{p}_{1,0}, \mathbf{p}_{1,2}] \}, \end{aligned}$$

$$\begin{aligned}
\mathbf{p}_{3,3} &= -\frac{1}{(1+\sqrt{2})i} \{ \mathbf{f}_1(\mathbf{p}_{0,0})[\mathbf{p}_{2,3}] - \mathbf{p}'_{2,3} + \mathbf{f}_2(\mathbf{p}_{0,0})[\mathbf{p}_{1,0}, \mathbf{p}_{1,3}] \}, \\
\mathbf{p}_{3,(1,1)} &= \frac{1}{4i} \mathbf{f}_2(\mathbf{p}_{0,0})[\mathbf{p}_{1,1}, \mathbf{p}_{1,1}], \\
\mathbf{p}_{3,(1,2)} &= \frac{1}{(1+\sqrt{2})i} \mathbf{f}_2(\mathbf{p}_{0,0})[\mathbf{p}_{1,1}, \mathbf{p}_{1,2}], \\
\mathbf{p}_{3,(1,3)} &= -\frac{1}{\sqrt{2}i} \mathbf{f}_2(\mathbf{p}_{0,0})[\mathbf{p}_{1,1}, \mathbf{p}_{1,3}], \\
\mathbf{p}_{3,(2,2)} &= \frac{1}{4\sqrt{2}i} \mathbf{f}_2(\mathbf{p}_{0,0})[\mathbf{p}_{1,2}, \mathbf{p}_{1,2}], \\
\mathbf{p}_{3,(2,3)} &= -\frac{1}{i} \mathbf{f}_2(\mathbf{p}_{0,0})[\mathbf{p}_{1,2}, \mathbf{p}_{1,3}], \\
\mathbf{p}_{3,(3,3)} &= -\frac{1}{4(1+\sqrt{2})i} \mathbf{f}_2(\mathbf{p}_{0,0})[\mathbf{p}_{1,3}, \mathbf{p}_{1,3}].
\end{aligned}$$

The number of terms in \mathcal{U}_4 is significantly larger: we need to add to \mathcal{U}_3 a further nine terms - altogether we have 19 terms, which are displayed in Table 1. All the nonzero $\rho_{\ell_1, \ell_2, \ell_3}^m$ are displayed there as well. Note that there is no (1, 2, 3) term, because $\kappa_1 + \kappa_2 + \kappa_3 = 0$, hence it is counted together with zero.

In particular,

$$\begin{aligned}
\mathbf{p}'_{3,0} &= \mathbf{f}(\mathbf{p}_{0,0})[\mathbf{p}_{3,0}] + \mathbf{f}_2(\mathbf{p}_{0,0})[\mathbf{p}_{1,0}, \mathbf{p}_{2,0}] + \frac{1}{6} \mathbf{f}_3(\mathbf{p}_{0,0})[\mathbf{p}_{1,0}, \mathbf{p}_{1,0}, \mathbf{p}_{1,0}], \\
\mathbf{p}_{3,0}(0) &= -\sum_{j=1}^3 \mathbf{p}_{3,j}(0) - \sum_{j=1}^3 \sum_{\ell=j}^3 \mathbf{p}_{3,(j,\ell)}(0).
\end{aligned}$$

We conclude that the $O(\omega^{-3})$ terms in the asymptotic expansion of \mathbf{y} are

$$\begin{aligned}
&\frac{1}{\omega^3} \left[\mathbf{p}_{3,0} + \mathbf{p}_{3,1} e^{i\omega t} + \mathbf{p}_{3,2} e^{i\sqrt{2}\omega t} + \mathbf{p}_{3,3} e^{-i(1+\sqrt{2})\omega t} + \mathbf{p}_{3,(1,1)} e^{i2\omega t} \right. \\
&+ \mathbf{p}_{3,(1,2)} e^{i(1+\sqrt{2})\omega t} + \mathbf{p}_{3,(1,3)} e^{-i\sqrt{2}\omega t} + \mathbf{p}_{3,(2,2)} e^{i2\sqrt{2}\omega t} + \mathbf{p}_{3,(2,3)} e^{-i\omega t} \\
&\left. + \mathbf{p}_{3,(3,3)} e^{-i(2+2\sqrt{2})\omega t} \right].
\end{aligned}$$

All this can, of course, be carried forward to larger values of r .

3.5 Two non-commensurate frequencies

An interesting special case is $M = 2$, where, without loss of generality, $\kappa_1 \neq 0$ is rational and κ_2 irrational: this means that the only integer solution

Table 1: Ordered elements of \mathcal{U}_4

m	σ_m	ρ_ℓ^m
0	$\sigma_0 = 0$	$\rho_{0,0,0}^0 = 1, \rho_{1,2,3}^0 = 2, \rho_{2,1,3}^0 = 2, \rho_{3,1,2}^0 = 2,$
1	$\sigma_1 = 1$	$\rho_{0,0,1}^1 = 3,$
2	$\sigma_2 = \sqrt{2}$	$\rho_{0,0,2}^2 = 3,$
3	$\sigma_3 = -1 - \sqrt{2}$	$\rho_{0,0,3}^3 = 3,$
(1, 1)	$\sigma_{1,1} = 2$	$\rho_{0,1,1}^{1,1} = 3,$
(1, 2)	$\sigma_{1,2} = 1 + \sqrt{2}$	$\rho_{0,1,2}^{1,2} = 6,$
(1, 3)	$\sigma_{1,3} = -\sqrt{2}$	$\rho_{0,1,3}^{1,3} = 6,$
(2, 2)	$\sigma_{2,2} = 2\sqrt{2}$	$\rho_{0,2,2}^{2,2} = 3,$
(2, 3)	$\sigma_{2,3} = -1$	$\rho_{0,2,3}^{2,3} = 6,$
(3, 3)	$\sigma_{3,3} = -2 - 2\sqrt{2}$	$\rho_{0,3,3}^{3,3} = 3,$
(1, 1, 1)	$\sigma_{1,1,1} = 3$	$\rho_{1,1,1}^{1,1,1} = 1,$
(1, 1, 2)	$\sigma_{1,1,2} = 2 + \sqrt{2}$	$\rho_{1,1,2}^{1,1,2} = 3,$
(1, 1, 3)	$\sigma_{1,1,3} = 1 - \sqrt{2}$	$\rho_{1,1,3}^{1,1,3} = 3,$
(1, 2, 2)	$\sigma_{1,2,2} = 1 + 2\sqrt{2}$	$\rho_{1,2,2}^{1,2,2} = 3,$
(1, 3, 3)	$\sigma_{1,3,3} = -1 - 2\sqrt{2}$	$\rho_{1,3,3}^{1,3,3} = 3,$
(2, 2, 2)	$\sigma_{2,2,2} = 3\sqrt{2}$	$\rho_{2,2,2}^{2,2,2} = 1,$
(2, 2, 3)	$\sigma_{2,2,3} = -1 + \sqrt{2}$	$\rho_{2,2,3}^{2,2,3} = 3,$
(2, 3, 3)	$\sigma_{2,3,3} = -2 - \sqrt{2}$	$\rho_{2,3,3}^{2,3,3} = 3,$
(3, 3, 3)	$\sigma_{3,3,3} = -3 - 3\sqrt{2}$	$\rho_{3,3,3}^{3,3,3} = 1,$

to $m_1\kappa_1 + m_2\kappa_2 = 0$ is $m_1 = m_2 = 0$. This simplifies the argument a great deal.

Simple calculation now confirms that

$$\begin{aligned}
\mathbf{p}'_{0,0} &= \mathbf{f}(\mathbf{p}_{0,0}), \quad \mathbf{p}_{0,0}(0) = \mathbf{y}_0, \\
\mathbf{p}_{1,m} &= \frac{\mathbf{a}_m}{i\kappa_m}, \quad m = 1, 2, \\
\mathbf{p}'_{1,0} &= \mathbf{f}_1(\mathbf{p}_{0,0})[\mathbf{p}_{1,0}], \quad t \geq 0, \quad \mathbf{p}_{1,0}(0) = -\mathbf{p}_{1,1}(0) - \mathbf{p}_{1,2}(0), \\
\mathbf{p}_{2,m} &= \frac{1}{i\kappa_m} \{ \mathbf{f}_1(\mathbf{p}_{0,0})[\mathbf{p}_{1,m}] - \mathbf{p}'_{1,m} \}, \quad m = 1, 2, \\
\mathbf{p}'_{2,0} &= \mathbf{f}_1(\mathbf{p}_{0,0})[\mathbf{p}_{2,0}] + \frac{1}{2} \mathbf{f}_2(\mathbf{p}_{0,0})[\mathbf{p}_{1,0}, \mathbf{p}_{1,0}], \quad \mathbf{p}_{2,0}(0) = -\mathbf{p}_{2,1}(0) - \mathbf{p}_{2,2}(0), \\
\mathbf{p}_{3,m} &= \frac{1}{i\kappa_m} \{ \mathbf{f}_1(\mathbf{p}_{0,0})[\mathbf{p}_{2,m}] - \mathbf{p}'_{2,m} + \mathbf{f}_2(\mathbf{p}_{0,0})[\mathbf{p}_{1,0}, \mathbf{p}_{1,m}] \}, \quad m = 1, 2,
\end{aligned}$$

$$\begin{aligned}
\mathbf{p}_{3,(m,m)} &= \frac{1}{4i\kappa_m} \mathbf{f}_2(\mathbf{p}_{0,0})[\mathbf{p}_{1,m}, \mathbf{p}_{1,m}], \quad m = 1, 2, \\
\mathbf{p}_{3,(1,2)} &= \frac{1}{i(\kappa_1 + \kappa_2)} \mathbf{f}_2(\mathbf{p}_{0,0})[\mathbf{p}_{1,1}, \mathbf{p}_{1,2}], \\
\mathbf{p}'_{3,0} &= \mathbf{f}_1(\mathbf{p}_{0,0})[\mathbf{p}_{3,0}] + \mathbf{f}_2(\mathbf{p}_{0,0})[\mathbf{p}_{1,0}, \mathbf{p}_{2,0}] + \frac{1}{6} \mathbf{f}_3(\mathbf{p}_{0,0})[\mathbf{p}_{1,0}, \mathbf{p}_{1,0}, \mathbf{p}_{1,0}], \\
\mathbf{p}_{3,0}(0) &= -\mathbf{p}_{3,1}(0) - \mathbf{p}_{3,2}(0) - \mathbf{p}_{3,(1,1)}(0) - \mathbf{p}_{3,(1,2)}(0) - \mathbf{p}_{3,(2,2)}(0).
\end{aligned}$$

The next ‘generation’ is

$$\begin{aligned}
\mathbf{p}_{4,m} &= \frac{1}{i\kappa_m} \left\{ \mathbf{f}_1(\mathbf{p}_{0,0})[\mathbf{p}_{3,m}] - \mathbf{p}'_{3,m} + \mathbf{f}_2(\mathbf{p}_{0,0})[\mathbf{p}_{1,0}, \mathbf{p}_{2,m}] \right. \\
&\quad \left. + \mathbf{f}_2(\mathbf{p}_{0,0})[\mathbf{p}_{1,m}, \mathbf{p}_{2,0}] + \frac{1}{6} \mathbf{f}_3(\mathbf{p}_{0,0})[\mathbf{p}_{1,0}, \mathbf{p}_{1,0}, \mathbf{p}_{1,0}] \right\}, \quad m = 1, 2, \\
\mathbf{p}_{4,(m,m)} &= \frac{1}{2i\kappa_m} \left\{ \mathbf{f}_1(\mathbf{p}_{0,0})[\mathbf{p}_{3,(m,m)}] + \mathbf{f}_2(\mathbf{p}_{0,0})[\mathbf{p}_{1,m}, \mathbf{p}_{2,m}] \right. \\
&\quad \left. + \frac{1}{2} \mathbf{f}_3(\mathbf{p}_{0,0})[\mathbf{p}_{1,0}, \mathbf{p}_{1,m}, \mathbf{p}_{1,m}] \right\}, \quad m = 1, 2, \\
\mathbf{p}_{4,(1,2)} &= \frac{1}{i(\kappa_1 + \kappa_2)} \left\{ \mathbf{f}_1(\mathbf{p}_{0,0})[\mathbf{p}_{3,(1,2)}] + \mathbf{f}_2(\mathbf{p}_{0,0})[\mathbf{p}_{1,1}, \mathbf{p}_{2,2}] \right. \\
&\quad \left. + \mathbf{f}_2(\mathbf{p}_{0,0})[\mathbf{p}_{1,2}, \mathbf{p}_{2,1}] + \mathbf{f}_3(\mathbf{p}_{0,0})[\mathbf{p}_{1,0}, \mathbf{p}_{1,1}, \mathbf{p}_{1,2}] \right\}, \\
\mathbf{p}_{4,(m,m,m)} &= \frac{1}{18i\kappa_m} \mathbf{f}_3(\mathbf{p}_{0,0})[\mathbf{p}_{1,m}, \mathbf{p}_{1,m}, \mathbf{p}_{1,m}], \quad m = 1, 2, \\
\mathbf{p}_{4,(1,1,2)} &= \frac{1}{2i(2\kappa_1 + \kappa_2)} \mathbf{f}_3(\mathbf{p}_{0,0})[\mathbf{p}_{1,1}, \mathbf{p}_{1,1}, \mathbf{p}_{1,2}], \\
\mathbf{p}_{4,(1,2,2)} &= \frac{1}{2i(\kappa_1 + 2\kappa_2)} \mathbf{f}_3(\mathbf{p}_{0,0})[\mathbf{p}_{1,1}, \mathbf{p}_{1,2}, \mathbf{p}_{1,2}]
\end{aligned}$$

and

$$\begin{aligned}
\mathbf{p}'_{4,0} &= \mathbf{f}_1(\mathbf{p}_{0,0})[\mathbf{p}_{4,0}] + \mathbf{f}_2(\mathbf{p}_{0,0})[\mathbf{p}_{1,0}, \mathbf{p}_{3,0}] + \frac{1}{2} \mathbf{f}_2(\mathbf{p}_{0,0})[\mathbf{p}_{2,0}, \mathbf{p}_{2,0}] \\
&\quad + \frac{1}{2} \mathbf{f}_3(\mathbf{p}_{0,0})[\mathbf{p}_{1,0}, \mathbf{p}_{1,0}, \mathbf{p}_{2,0}] + \frac{1}{24} \mathbf{f}_4(\mathbf{p}_{0,0})[\mathbf{p}_{1,0}, \mathbf{p}_{1,0}, \mathbf{p}_{1,0}, \mathbf{p}_{1,0}], \\
\mathbf{p}_{4,0}(0) &= -\mathbf{p}_{4,1}(0) - \mathbf{p}_{4,2}(0) - \mathbf{p}_{4,(1,1)}(0) - \mathbf{p}_{4,(1,2)}(0) - \mathbf{p}_{4,(2,2)}(0) \\
&\quad - \mathbf{p}_{4,(1,1,1)}(0) - \mathbf{p}_{4,(1,1,2)}(0) - \mathbf{p}_{4,(1,2,2)}(0) - \mathbf{p}_{4,(2,2,2)}(0).
\end{aligned}$$

Greater, but not insurmountable effort is required to develop a general asymptotic expansion in this case. However, to all intents and purposes, expanding up to $r = 4$ is sufficient to derive an exceedingly accurate solution.

3.6 Comments

Comment 1: As we increase levels r , we are increasingly likely to encounter the well-known phenomenon of small denominators (Verhulst 1990): unless $\kappa_m = c\psi_m$, $m = 1, \dots, M$, where all the ψ_m s are rational (in which case, replacing ω by its product with the least common denominator of the ψ_m s, we are back to the case (1.2) of frequencies being integer multiples of ω) and positive, the set of all finite-length linear combinations of the κ_m s is dense in \mathbb{R} (Besicovitch 1932). In particular, we can approach 0 arbitrarily close by such linear combinations. This is different from κ_m s summing up exactly to zero: as demonstrated in Subsection 3.4, we can deal with the latter problem but not with the denominators in (3.7) or (3.8) becoming arbitrarily small in magnitude. Like with other averaging techniques, there is no simple remedy to this phenomenon. This restricts the range of r at which the asymptotic expansion is effective. Having said so, and bearing in mind that the truncation of (1.7) to $r \leq R$ yields an error of $O(\omega^{-R-1})$ and, $|\omega|$ being large, we are likely to obtain very high accuracy before small denominators kick in. Hence, this phenomenon has little practical implications.

Incidentally, this is precisely the reason for the requirement that, unlike in (1.2), the number of initial frequencies is finite. Otherwise, we could have encountered small denominators already for $r = 3$ and this would have definitely placed genuine restrictions on the applicability of our approach.

Comment 2: There is an alternative to our expansion. We may decide that the κ_m s are symbols, rather than specific numbers. Not being assigned specific values, it is meaningless to talk about sets $\mathcal{W}_{r,m}^n$ because $\kappa_{\ell_1} + \kappa_{\ell_2} = \kappa_m$, say, has no meaning (except when $\ell_1 = 0$, $\ell_2 = m$). Of course, in that case we may have several distinct terms which correspond to the same frequency, once we allocate specific values to the κ_m s, but the *quid pro quo* is considerable simplification and no multiplicities (which depend on specific values of κ_m s, hence need be re-evaluated each time we have new frequencies). Unfortunately, this approach has another, more critical, shortcoming. We must identify all linear combinations of κ_m s that sum up to zero, because they require an altogether different treatment.

It would have been possible to proceed differently, by separating all the terms in of the form $\sum_{j=1}^s \kappa_{\ell_j}$ into two subsets: those that sum to zero and

those that are nonzero. We do not need to specify which is which - this becomes apparent only once values are allocated - just to remember that the nonzero sums give rise to new frequencies, with coefficients derived by recursion, while zero sums are lumped into a differential equation for a non-oscillatory term. While this is certainly feasible, it seems that the current approach is probably simpler and more transparent.

4 Numerical experiments

In the current section we present two examples that illustrate the construction of our expansions and demonstrate the effectiveness of our approach. In each case we compare the pointwise error incurred by a truncated expansion (1.7) with either the exact solution or the Maple routine `rkf45` with exceedingly high error tolerance, using 20 significant decimal digits. Specifically, we measure the components of

$$\mathbf{y}(t) - \mathbf{p}_{0,0}(t) - \sum_{r=1}^s \frac{1}{\omega^r} \sum_{m \in \mathcal{U}_r} \mathbf{p}_{r,m}(t) e^{i\sigma_m \omega t}$$

for different values of s .

4.1 A linear example

We consider the equation

$$\ddot{x} + \frac{3}{5}\dot{x} + \frac{21}{5}x = te^{\sqrt{2}i\omega t} + t^2e^{-(1+\sqrt{2})i\omega t}, \quad t \geq 0, \quad x(0) = \dot{x}(0) = 0.5. \quad (4.1)$$

Letting $\mathbf{y} = [x, \dot{x}]^T$, we reformulate (4.1) as the system

$$\mathbf{y}' = \begin{pmatrix} 0 & 1 \\ -\frac{21}{5} & -\frac{3}{5} \end{pmatrix} \mathbf{y} + \begin{pmatrix} 0 \\ 1 \end{pmatrix} \left(te^{\sqrt{2}i\omega t} + t^2e^{-(1+\sqrt{2})i\omega t} \right), \quad t \geq 0, \quad \mathbf{y}(0) = \begin{bmatrix} \frac{1}{2} \\ \frac{1}{2} \end{bmatrix}.$$

This being a linear equation, the exact solution and its asymptotic expansion are available explicitly using the theory from Section 2.

Figures 4.1 and 4.2 display the real part of the error functions in computing x and \dot{x} , respectively, for s between 0 and 4 within $t \in [0, 5]$. It is clear that each time we increase s , the error indeed decreases substantially, in line with our theory. ²

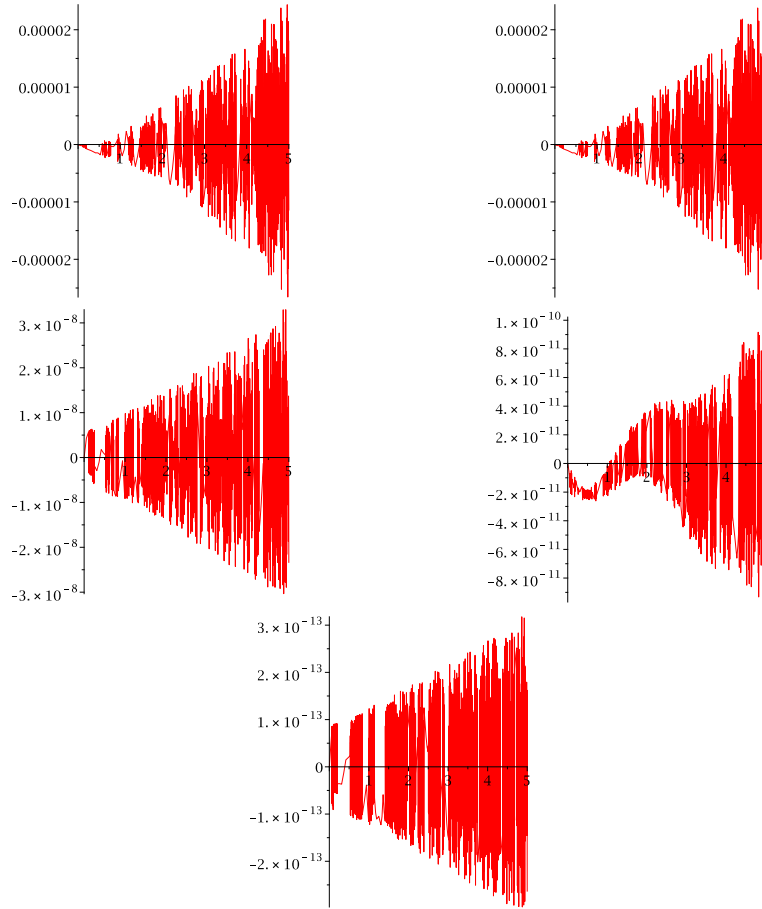

Figure 4.1: The real part of the error in x committed by the asymptotic expansion, as applied to the linear system (4.1) with $\omega = 500$ for $s = 0, 1, 2, 3, 4$ (from top left onwards).

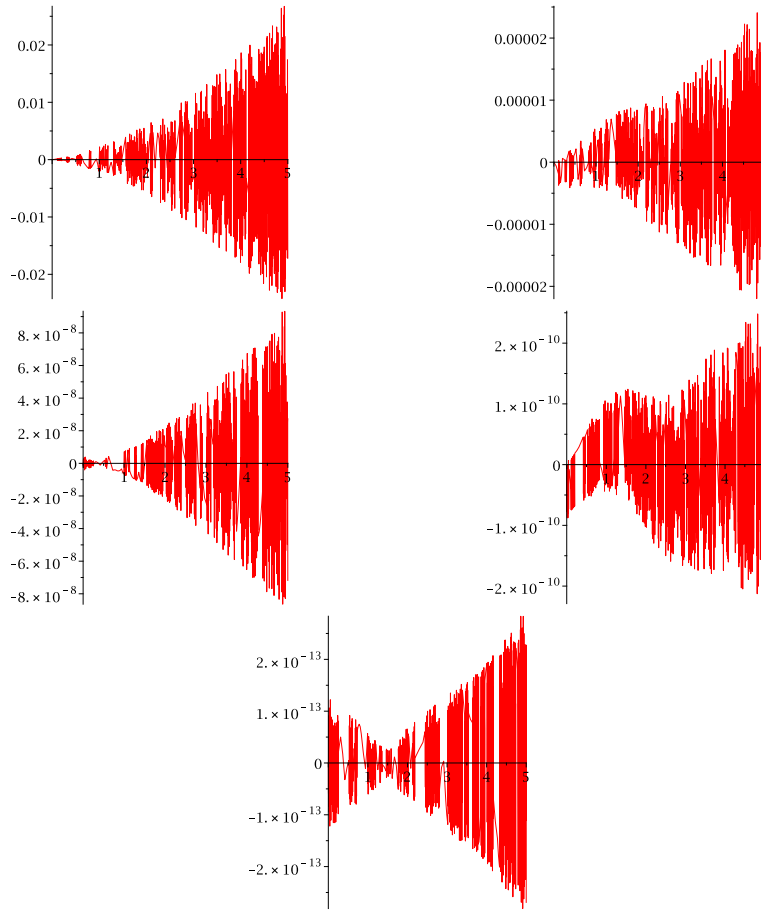

Figure 4.2: The real part of the error in \dot{x} committed by the asymptotic expansion, as applied to the linear system (4.1) with $\omega = 500$ for $s = 0, 1, 2, 3, 4$ (from top left onwards). It is shown that the error decreases once s is increased from 0 to 1.

Identical information is reported in Figs 4.3 and 4.4 for frequency $\omega = 5000$ within $t \in [0, 5]$. A comparison with the two previous figures emphasises the important point that the efficiency of the asymptotic - numerical method grows with ω , while the cost is to all intents and purposes identical. Indeed, wishing to produce similar error to our method with $s = 4$, the Maple routine `rkf45` needs be applied with absolute and relative error tolerances of 10^{-13} and 10^{-18} respectively.³ Although the method is robust enough to produce correct magnitude of global errors, this comes at a steep price. Thus, while our method takes less than one second to compute the solution and requires ≈ 17.5 kbytes of storage, `rkf45` takes ≈ 2740 seconds to compute the solution for $\omega = 500$ and requires $\approx 10^7$ kbytes. This increases to ≈ 4533 seconds and $\approx 1.6 \times 10^7$ kbytes for $\omega = 5000$.

4.2 A nonlinear example in Memristor circuits

In this subsection, the method in this paper is developed for Memristor circuits subject to high-frequency signals. Consider the following differential equation governing a circuit with two memristors similar to that given in BoCheng2011,

$$\begin{cases} y_1'(t) = y_3(t) \\ y_2'(t) = \frac{y_4(t) - y_3(t)}{1 + e(1 + 3y_2^2(t))} \\ y_3'(t) = ay_3(t)(d - (1 + 3y_1^2(t))) - \frac{a(y_3(t) - y_4(t))(1 + 3y_2^2(t))}{1 + e(1 + 3y_2^2(t))} \\ y_4'(t) = \frac{(y_3(t) - y_4(t))(1 + 3y_2^2(t))}{1 + e(1 + 3y_2^2(t))} + y_5(t) \\ y_5'(t) = -by_4(t) - cy_5(t) + s(t), \quad t \geq 0 \end{cases} \quad (4.2)$$

with the initial conditions

$$(y_1(0), y_2(0), y_3(0), y_4(0), y_5(0))^T = (c_1, c_2, 0, 10^{-4}, 0)^T = y_0$$

where $a = 8$, $b = 10$, $c = 0$, $d = 2$, $e = 0.1$, $c_1 = -0.8$, $c_2 = -0.4$. The unknown functions are $y_1(t), y_2(t), y_3(t), y_4(t), y_5(t)$. The forcing term is $s(t) = \frac{Ab}{2i}e^{i\kappa_1\omega t} - \frac{Ab}{2i}e^{i\kappa_2\omega t} + \frac{Ab}{2i}e^{i\kappa_3\omega t} - \frac{Ab}{2i}e^{i\kappa_4\omega t}$, in which $A = 0.1$, $\kappa_1 = 1$, $\kappa_2 = -1$, $\kappa_3 = \sqrt{2}$, $\kappa_4 = -\sqrt{2}$ and ω is our oscillatory parameter. The circuit

²The fact that Figs 4.1a and 4.1b are identical is a fluke-anyway, it is evident from the results on Page 5.

³Such error tolerances are impossible in Matlab, which explains our use of Maple.

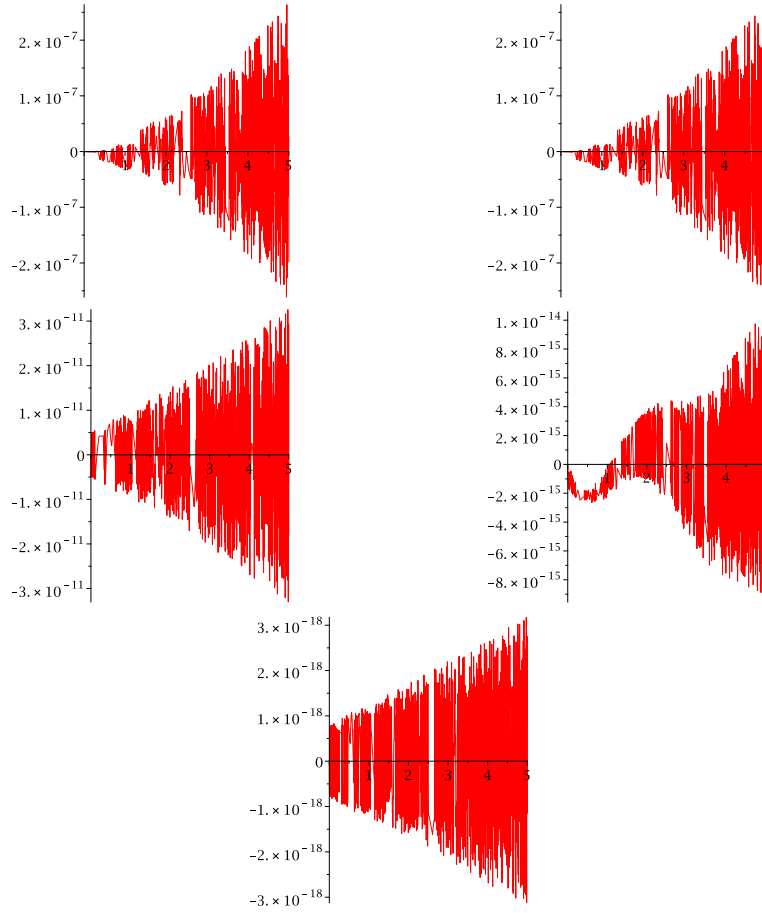

Figure 4.3: The real part of the error in x committed by the asymptotic expansion, as applied to the linear system (4.1) with $\omega = 5000$ for $s = 0, 1, 2, 3, 4$ (from top left onwards).

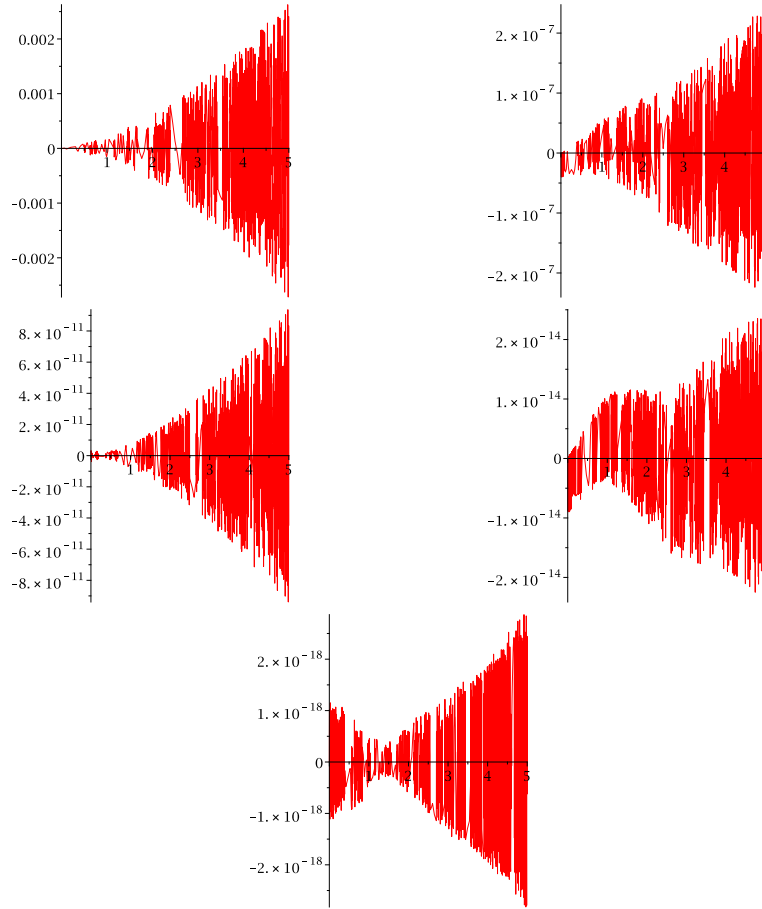

Figure 4.4: The real part of the error in \dot{x} committed by the asymptotic expansion, as applied to the linear system (4.1) with $\omega = 5000$ for $s = 0, 1, 2, 3, 4$ (from top left onwards).

figure is shown in Fig. 4.5 where the corresponding parameter relationship between Fig. 4.5 and the equation (4.2) are

$$\phi_1 = y_1, \quad \phi_2 = y_2, \quad v_3 = y_3, \quad v_4 = y_4, \quad i_5 = y_5, \quad C_2 = 1, \quad a = 1/C_1, \\ W_1 = 1 + 3y_1^2, \quad W_2 = 1 + 3y_2^2, \quad b = 1/L, \quad c = r/L, \quad d = G, \quad e = R.$$

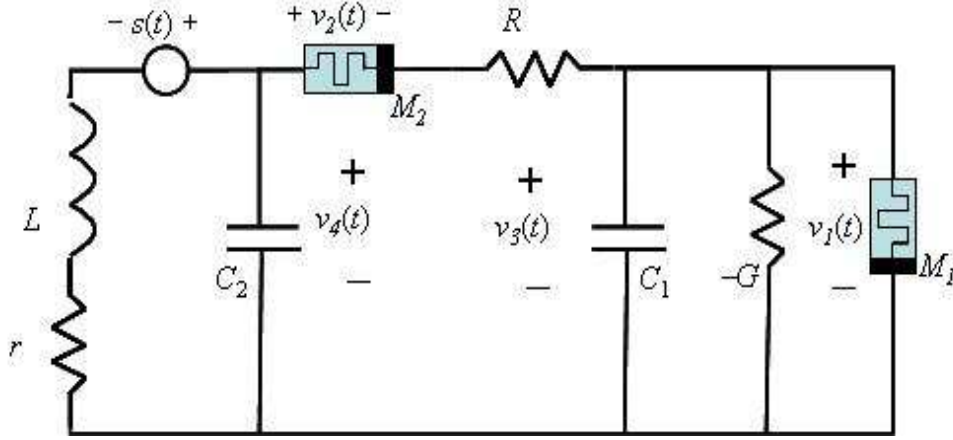

Figure 4.5: The Memristor circuits.

This circuit equation can be written in vector form

$$\mathbf{y}'(t) = \mathbf{f}(\mathbf{y}) + \mathbf{a}_1(t)e^{i\kappa_1\omega t} + \mathbf{a}_2(t)e^{i\kappa_2\omega t} + \mathbf{a}_3(t)e^{i\kappa_3\omega t} + \mathbf{a}_4(t)e^{i\kappa_4\omega t}, \quad t \geq 0,$$

where $\mathbf{y}(t) = (y_1(t), y_2(t), y_3(t), y_4(t), y_5(t))^T$,

$$\mathbf{f}(\mathbf{y}) = \begin{pmatrix} y_3 \\ \frac{y_4 - y_3}{1 + e(1 + 3y_2^2)} \\ ay_3(d - (1 + 3y_1^2)) - \frac{a(y_3 - y_4)(1 + 3y_2^2)}{1 + e(1 + 3y_2^2)} \\ \frac{(y_3 - y_4)(1 + 3y_2^2)}{1 + e(1 + 3y_2^2)} + y_5 \\ -by_4 - cy_5 \end{pmatrix}$$

and

$$\mathbf{a}_1(t) = \begin{pmatrix} 0 \\ 0 \\ 0 \\ 0 \\ \frac{Ab}{2i} \end{pmatrix}, \quad \mathbf{a}_2(t) = \begin{pmatrix} 0 \\ 0 \\ 0 \\ 0 \\ -\frac{Ab}{2i} \end{pmatrix}, \quad \mathbf{a}_3(t) = \begin{pmatrix} 0 \\ 0 \\ 0 \\ 0 \\ \frac{Ab}{2i} \end{pmatrix}, \quad \mathbf{a}_4(t) = \begin{pmatrix} 0 \\ 0 \\ 0 \\ 0 \\ -\frac{Ab}{2i} \end{pmatrix},$$

or in a more compact form as

$$\mathbf{y}'(t) + \mathbf{f}(\mathbf{y}(t)) = \sum_{m=1}^4 \mathbf{a}_m(t) e^{i\kappa_m \omega t} = \sum_{m \in \mathcal{U}_0} \mathbf{a}_m(t) e^{i\kappa_m \omega t}, \quad t \geq 0. \quad (4.3)$$

where $\mathcal{U}_0 = \{1, 2, \dots, 4\}$ is an initial set and $\omega_j = \kappa_j \omega$, $j = 1, 2, \dots$.

Then the asymptotic method is developed for this type of equation.

The formation of the terms in the asymptotic method for the given memristor system shall now be described.

4.2.1 The zeroth terms

Denote $(\mathbf{p})_j$ as the j -th element of the vector \mathbf{p} . When $r = 0$, set $\mathcal{U}_1 = \{0, 1, 2, 3, 4\}$. Then the zeroth term $\mathbf{p}_{0,0}(t)$ obeys

$$\mathbf{p}'_{0,0} = \mathbf{f}(\mathbf{p}_{0,0}), \quad t \geq 0, \quad \mathbf{p}_{0,0}(0) = \mathbf{y}_0 = (c_1, c_2, 0, 10^{-4}, 0)^T,$$

where

$$\mathbf{f}(\mathbf{p}_{0,0}) = \begin{pmatrix} (\mathbf{p}_{0,0})_3 \\ \frac{(\mathbf{p}_{0,0})_4 - (\mathbf{p}_{0,0})_3}{1 + e(1 + 3(\mathbf{p}_{0,0})_2^2)} \\ a(\mathbf{p}_{0,0})_3(d - (1 + 3(\mathbf{p}_{0,0})_1^2)) - \frac{a((\mathbf{p}_{0,0})_3 - (\mathbf{p}_{0,0})_4)(1 + 3(\mathbf{p}_{0,0})_2^2)}{1 + e(1 + 3(\mathbf{p}_{0,0})_2^2)} \\ \frac{((\mathbf{p}_{0,0})_3 - (\mathbf{p}_{0,0})_4)(1 + 3(\mathbf{p}_{0,0})_2^2)}{1 + e(1 + 3(\mathbf{p}_{0,0})_2^2)} + (\mathbf{p}_{0,0})_5 \\ -b(\mathbf{p}_{0,0})_4 - c(\mathbf{p}_{0,0})_5 \end{pmatrix}$$

In addition, the recursions enable the determination of $\mathbf{p}_{1,m}(t)$, $m \neq 0$,

$$\mathbf{p}_{1,1}(t) = \frac{1}{i\kappa_1} \begin{pmatrix} 0 \\ 0 \\ 0 \\ 0 \\ \frac{Ab}{2i} \end{pmatrix}, \quad \mathbf{p}_{1,2}(t) = \frac{1}{i\kappa_2} \begin{pmatrix} 0 \\ 0 \\ 0 \\ 0 \\ -\frac{Ab}{2i} \end{pmatrix},$$

$$\mathbf{p}_{1,3}(t) = \frac{1}{i\kappa_3} \begin{pmatrix} 0 \\ 0 \\ 0 \\ 0 \\ \frac{Ab}{2i} \end{pmatrix}, \quad \mathbf{p}_{1,4}(t) = \frac{1}{i\kappa_4} \begin{pmatrix} 0 \\ 0 \\ 0 \\ 0 \\ -\frac{Ab}{2i} \end{pmatrix}.$$

The corresponding derivatives are $\mathbf{p}'_{1,1}(t) = \mathbf{p}'_{1,2}(t) = \mathbf{p}'_{1,3}(t) = \mathbf{p}'_{1,4}(t) = \mathbf{0}$.

4.2.2 The $r = 1$ terms

For $r = 1$, set $\mathcal{U}_2 = \mathcal{U}_1 = \{0, 1, 2, 3, 4\}$. This yields

$$\mathbf{p}'_{1,0} = \mathbf{f}_1(\mathbf{p}_{0,0})[\mathbf{p}_{1,0}], \quad t \geq 0,$$

$$\mathbf{p}_{1,0}(0) = - \sum_{m \in \mathcal{U}_1 \setminus \{0\}} \mathbf{p}_{1,m}(0) = \begin{pmatrix} 0 \\ 0 \\ 0 \\ 0 \\ \frac{Ab}{2}(2 + \sqrt{2}) \end{pmatrix},$$

$$\mathbf{p}_{2,m} = \frac{1}{i\kappa_m} \{ \mathbf{f}_1(\mathbf{p}_{0,0})[\mathbf{p}_{1,m}] - \mathbf{p}'_{1,m} \} = \frac{1}{i\kappa_m} \mathbf{f}_1(\mathbf{p}_{0,0})[\mathbf{p}_{1,m}], \quad m \in \mathcal{U}_2 \setminus \{0\},$$

where

$$\mathbf{p}_{2,1}(t) = \frac{1}{(i\kappa_1)^2} \begin{pmatrix} 0 \\ 0 \\ 0 \\ \frac{Ab}{2i} \\ \frac{-cAb}{2i} \end{pmatrix}, \quad \mathbf{p}_{2,2}(t) = \frac{1}{(i\kappa_2)^2} \begin{pmatrix} 0 \\ 0 \\ 0 \\ -\frac{Ab}{2i} \\ \frac{cAb}{2i} \end{pmatrix},$$

$$\mathbf{p}_{2,3}(t) = \frac{1}{(i\kappa_3)^2} \begin{pmatrix} 0 \\ 0 \\ 0 \\ \frac{Ab}{2i} \\ \frac{-cAb}{2i} \end{pmatrix}, \quad \mathbf{p}_{2,4}(t) = \frac{1}{(i\kappa_4)^2} \begin{pmatrix} 0 \\ 0 \\ 0 \\ -\frac{Ab}{2i} \\ \frac{cAb}{2i} \end{pmatrix}.$$

4.2.3 when $r = 2$

The $r = 2$ layer is the first layer in which additional frequencies must be considered and we set

$$\mathcal{U}_3 = \{0, 1, 2, 3, 4, (1, 1), (1, 3), (1, 4), (2, 2), (2, 3), (2, 4), (3, 3), (4, 4)\}.$$

Note that the (1,2) term and (3,4) terms are not present as addition of these frequencies would result in zero which is present in the set.

We will first consider the $\mathbf{p}_{2,0}(t)$ term. Since $\rho_{1,1}^0 = 1$, $\rho_{1,2}^0 = 2$ and $\rho_{3,4}^0 = 2$, the term $\mathbf{p}_{2,0}$ satisfies

$$\mathbf{p}'_{2,0} = \mathbf{f}_1(\mathbf{p}_{0,0})[\mathbf{p}_{2,0}] + \frac{1}{2} \sum_{\substack{\kappa_{\ell_1} + \kappa_{\ell_2} = 0 \\ \ell_1 \leq \ell_2}} \rho_{\ell_1, \ell_2}^0 \mathbf{f}_2(\mathbf{p}_{0,0})[\mathbf{p}_{1, \ell_1}, \mathbf{p}_{1, \ell_2}]$$

$$\begin{aligned}
&= \mathbf{f}_1(\mathbf{p}_{0,0})[\mathbf{p}_{2,0}] + \frac{1}{2}\mathbf{f}_2(\mathbf{p}_{0,0})[\mathbf{p}_{1,0}, \mathbf{p}_{1,0}] \\
&\quad + \mathbf{f}_2(\mathbf{p}_{0,0})[\mathbf{p}_{1,1}, \mathbf{p}_{1,2}] + \mathbf{f}_2(\mathbf{p}_{0,0})[\mathbf{p}_{1,3}, \mathbf{p}_{1,4}]
\end{aligned}$$

with the initial condition

$$\mathbf{p}_{2,0}(0) = - \sum_{m \in \mathcal{U}_2 \setminus \{0\}} \mathbf{p}_{2,m}(0) = \mathbf{0},$$

where

$$\mathbf{f}_2(\mathbf{p}_{0,0})[\mathbf{p}_{1,m}, \mathbf{p}_{1,k}] = \begin{pmatrix} \mathbf{p}_{1,m}^T M_1(\mathbf{p}_{0,0}) \mathbf{p}_{1,k} \\ \mathbf{p}_{1,m}^T M_2(\mathbf{p}_{0,0}) \mathbf{p}_{1,k} \\ \mathbf{p}_{1,m}^T M_3(\mathbf{p}_{0,0}) \mathbf{p}_{1,k} \\ \mathbf{p}_{1,m}^T M_4(\mathbf{p}_{0,0}) \mathbf{p}_{1,k} \\ \mathbf{p}_{1,m}^T M_5(\mathbf{p}_{0,0}) \mathbf{p}_{1,k} \end{pmatrix}$$

and $M_j(\mathbf{y})$ is the 5×5 dimensional Jacobian matrix evaluated at the vector function $\mathbf{p}_{0,0}(t)$

$$M_j(\mathbf{p}_{0,0}) = \begin{pmatrix} \frac{\partial^2 f_j}{\partial y_1 \partial y_1} & \frac{\partial^2 f_j}{\partial y_1 \partial y_2} & \frac{\partial^2 f_j}{\partial y_1 \partial y_3} & \frac{\partial^2 f_j}{\partial y_1 \partial y_4} & \frac{\partial^2 f_j}{\partial y_1 \partial y_5} \\ \frac{\partial^2 f_j}{\partial y_2 \partial y_1} & \frac{\partial^2 f_j}{\partial y_2 \partial y_2} & \frac{\partial^2 f_j}{\partial y_2 \partial y_3} & \frac{\partial^2 f_j}{\partial y_2 \partial y_4} & \frac{\partial^2 f_j}{\partial y_2 \partial y_5} \\ \frac{\partial^2 f_j}{\partial y_3 \partial y_1} & \frac{\partial^2 f_j}{\partial y_3 \partial y_2} & \frac{\partial^2 f_j}{\partial y_3 \partial y_3} & \frac{\partial^2 f_j}{\partial y_3 \partial y_4} & \frac{\partial^2 f_j}{\partial y_3 \partial y_5} \\ \frac{\partial^2 f_j}{\partial y_4 \partial y_1} & \frac{\partial^2 f_j}{\partial y_4 \partial y_2} & \frac{\partial^2 f_j}{\partial y_4 \partial y_3} & \frac{\partial^2 f_j}{\partial y_4 \partial y_4} & \frac{\partial^2 f_j}{\partial y_4 \partial y_5} \\ \frac{\partial^2 f_j}{\partial y_5 \partial y_1} & \frac{\partial^2 f_j}{\partial y_5 \partial y_2} & \frac{\partial^2 f_j}{\partial y_5 \partial y_3} & \frac{\partial^2 f_j}{\partial y_5 \partial y_4} & \frac{\partial^2 f_j}{\partial y_5 \partial y_5} \end{pmatrix}_{\mathbf{y}=\mathbf{p}_{0,0}(t)}.$$

Furthermore, due to the fact that the first four elements of $\mathbf{p}_{1,m}(t)$, $m \neq 0$, are zero, the nonoscillatory equation for $\mathbf{p}_{2,0}(t)$ simplifies to

$$\mathbf{p}'_{2,0} = \mathbf{f}_1(\mathbf{p}_{0,0})[\mathbf{p}_{2,0}] + \frac{1}{2}\mathbf{f}_2(\mathbf{p}_{0,0})[\mathbf{p}_{1,0}, \mathbf{p}_{1,0}], \quad \mathbf{p}_{2,0}(0) = \mathbf{0}, \quad t \geq 0.$$

Now consider the set \mathcal{U}_3 and the recursions for $\mathbf{p}_{3,m}$. First, we match all of the terms in $\mathcal{U}_2 \setminus \{0\}$ as these are also in \mathcal{U}_3 ,

$$\begin{aligned}
i\kappa_m \mathbf{p}_{3,m} &= \mathbf{f}_1(\mathbf{p}_{0,0})[\mathbf{p}_{2,m}] - \mathbf{p}'_{2,m} + \frac{1}{2} \sum_{\substack{\kappa_{\ell_1} + \kappa_{\ell_2} = \kappa_m \\ \ell_1 \leq \ell_2}} \rho_{\ell_1, \ell_2}^m \mathbf{f}_2(\mathbf{p}_{0,0})[\mathbf{p}_{1, \ell_1}, \mathbf{p}_{1, \ell_2}] \\
&= \mathbf{f}_1(\mathbf{p}_{0,0})[\mathbf{p}_{2,m}].
\end{aligned}$$

We then match to the remainder of the elements in \mathcal{U}_3 .

$$i(\kappa_{m_1} + \kappa_{m_2})\mathbf{p}_{3,(m_1,m_2)} = \frac{1}{2} \sum_{\substack{\kappa_{\ell_1} + \kappa_{\ell_2} = \kappa_{m_1} + \kappa_{m_2} \\ \ell_1 \leq \ell_2}} \rho_{\ell_1, \ell_2}^{m_1, m_2} \mathbf{f}_2(\mathbf{p}_{0,0})[\mathbf{p}_{1,\ell_1}, \mathbf{p}_{1,\ell_2}] = 0.$$

Because of the nature of the elements of $\mathbf{p}_{1,m}$ and $\mathbf{p}_{2,m}$, the non-zero terms of $\mathbf{p}_{3,m}(t)$, $m \neq 0$, are

$$\begin{aligned} \mathbf{p}_{3,1}(t) &= \frac{1}{(i\kappa_1)^3} \begin{pmatrix} 0 \\ \frac{1}{1+e(1+3(\mathbf{p}_{0,0})_2^2)} \frac{Ab}{2i} \\ \frac{a(1+3(\mathbf{p}_{0,0})_2^2)}{1+e(1+3(\mathbf{p}_{0,0})_2^2)} \frac{Ab}{2i} \\ -\frac{(1+3(\mathbf{p}_{0,0})_2^2)}{1+e(1+3(\mathbf{p}_{0,0})_2^2)} \frac{Ab}{2i} + \frac{-cAb}{2i} \\ -\frac{Ab^2}{2i} + \frac{c^2Ab}{2i} \end{pmatrix}, \\ \mathbf{p}_{3,2}(t) &= \frac{1}{(i\kappa_2)^3} \begin{pmatrix} 0 \\ \frac{1}{1+e(1+3(\mathbf{p}_{0,0})_2^2)} \frac{-Ab}{2i} \\ \frac{a(1+3(\mathbf{p}_{0,0})_2^2)}{1+e(1+3(\mathbf{p}_{0,0})_2^2)} \frac{-Ab}{2i} \\ -\frac{(1+3(\mathbf{p}_{0,0})_2^2)}{1+e(1+3(\mathbf{p}_{0,0})_2^2)} \frac{-Ab}{2i} + \frac{cAb}{2i} \\ \frac{Ab^2}{2i} - \frac{c^2Ab}{2i} \end{pmatrix}, \\ \mathbf{p}_{3,3}(t) &= \frac{1}{(i\kappa_3)^3} \begin{pmatrix} 0 \\ \frac{1}{1+e(1+3(\mathbf{p}_{0,0})_2^2)} \frac{Ab}{2i} \\ \frac{a(1+3(\mathbf{p}_{0,0})_2^2)}{1+e(1+3(\mathbf{p}_{0,0})_2^2)} \frac{Ab}{2i} \\ -\frac{(1+3(\mathbf{p}_{0,0})_2^2)}{1+e(1+3(\mathbf{p}_{0,0})_2^2)} \frac{Ab}{2i} + \frac{-cAb}{2i} \\ -\frac{Ab^2}{2i} + \frac{c^2Ab}{2i} \end{pmatrix}, \\ \mathbf{p}_{3,4}(t) &= \frac{1}{(i\kappa_4)^3} \begin{pmatrix} 0 \\ \frac{1}{1+e(1+3(\mathbf{p}_{0,0})_2^2)} \frac{-Ab}{2i} \\ \frac{a(1+3(\mathbf{p}_{0,0})_2^2)}{1+e(1+3(\mathbf{p}_{0,0})_2^2)} \frac{-Ab}{2i} \\ -\frac{(1+3(\mathbf{p}_{0,0})_2^2)}{1+e(1+3(\mathbf{p}_{0,0})_2^2)} \frac{-Ab}{2i} + \frac{cAb}{2i} \\ \frac{Ab^2}{2i} - \frac{c^2Ab}{2i} \end{pmatrix}. \end{aligned}$$

4.2.4 The $r = 3$ terms

When $r = 3$, we note that $\rho_{0,0}^0 = 1$, $\rho_{1,2}^0 = 2$, $\rho_{3,4}^0 = 2$, $\rho_{0,0,0}^0 = 1$, $\rho_{0,1,2}^0 = 6$, $\rho_{0,3,4}^0 = 6$. Hence, the equation for $\mathbf{p}_{3,0}$ is

$$\begin{aligned}
\mathbf{p}'_{3,0} &= \mathbf{f}_1(\mathbf{p}_{0,0})[\mathbf{p}_{3,0}] + \sum_{\substack{\kappa_{\ell_1} + \kappa_{\ell_2} = 0 \\ \ell_1 \leq \ell_2}} \rho_{\ell_1, \ell_2}^0 \mathbf{f}_2(\mathbf{p}_{0,0})[\mathbf{p}_{1, \ell_1}, \mathbf{p}_{2, \ell_2}] \\
&+ \frac{1}{6} \sum_{\substack{\kappa_{\ell_1} + \kappa_{\ell_2} + \kappa_{\ell_3} = 0 \\ \ell_1 \leq \ell_2 \leq \ell_3}} \rho_{\ell_1, \ell_2, \ell_3}^0 \mathbf{f}_3(\mathbf{p}_{0,0})[\mathbf{p}_{1, \ell_1}, \mathbf{p}_{1, \ell_2}, \mathbf{p}_{1, \ell_3}] \\
&= \mathbf{f}_1(\mathbf{p}_{0,0})[\mathbf{p}_{3,0}] + \mathbf{f}_2(\mathbf{p}_{0,0})[\mathbf{p}_{1,0}, \mathbf{p}_{2,0}] + 2\mathbf{f}_2(\mathbf{p}_{0,0})[\mathbf{p}_{1,1}, \mathbf{p}_{2,2}] \\
&+ 2\mathbf{f}_2(\mathbf{p}_{0,0})[\mathbf{p}_{1,3}, \mathbf{p}_{2,4}] + \frac{1}{6} \mathbf{f}_3(\mathbf{p}_{0,0})[\mathbf{p}_{1,0}, \mathbf{p}_{1,0}, \mathbf{p}_{1,0}] \\
&+ \mathbf{f}_3(\mathbf{p}_{0,0})[\mathbf{p}_{1,0}, \mathbf{p}_{1,1}, \mathbf{p}_{1,2}] + \mathbf{f}_3(\mathbf{p}_{0,0})[\mathbf{p}_{1,0}, \mathbf{p}_{1,3}, \mathbf{p}_{1,4}] \\
&= \mathbf{f}_1(\mathbf{p}_{0,0})[\mathbf{p}_{3,0}] + \mathbf{f}_2(\mathbf{p}_{0,0})[\mathbf{p}_{1,0}, \mathbf{p}_{2,0}] + \frac{1}{6} \mathbf{f}_3(\mathbf{p}_{0,0})[\mathbf{p}_{1,0}, \mathbf{p}_{1,0}, \mathbf{p}_{1,0}] \\
&+ \mathbf{f}_3(\mathbf{p}_{0,0})[\mathbf{p}_{1,0}, \mathbf{p}_{1,1}, \mathbf{p}_{1,2}] + \mathbf{f}_3(\mathbf{p}_{0,0})[\mathbf{p}_{1,0}, \mathbf{p}_{1,3}, \mathbf{p}_{1,4}].
\end{aligned}$$

with

$$\mathbf{p}_{3,0}(0) = - \sum_{m \in \mathcal{U}_3 \setminus \{0\}} \mathbf{p}_{3,m}(0) = \begin{pmatrix} 0 \\ -\frac{Ab}{1+e(1+3c_2^2)} \left(1 + \frac{1}{2\sqrt{2}}\right) \\ -\frac{Aba(1+3c_2^2)}{1+e(1+3c_2^2)} \left(1 + \frac{1}{2\sqrt{2}}\right) \\ \left[cAb + \frac{Ab(1+3c_2^2)}{1+e(1+3c_2^2)} \right] \left(1 + \frac{1}{2\sqrt{2}}\right) \\ (Ab^2 - c^2Ab) \left(1 + \frac{1}{2\sqrt{2}}\right) \end{pmatrix},$$

where

$$\begin{aligned}
&(\mathbf{f}_3(\mathbf{p}_{0,0}))_j[\mathbf{p}_{1,m_1}, \mathbf{p}_{1,m_2}, \mathbf{p}_{1,m_3}] \\
&= \sum_{k_1=1}^5 \sum_{k_2=1}^5 \sum_{k_3=1}^5 \frac{\partial^3 \mathbf{f}_j}{\partial y_{k_1} \partial y_{k_2} \partial y_{k_3}} \Big|_{\mathbf{p}_{0,0}} (\mathbf{p}_{1,m_1})_{k_1} (\mathbf{p}_{1,m_2})_{k_2} (\mathbf{p}_{1,m_3})_{k_3}.
\end{aligned}$$

Therefore, the asymptotic expansion including terms up to $r = 3$ is

$$\mathbf{y}(t) \sim \mathbf{p}_{0,0}(t) + \frac{1}{\omega} [\mathbf{p}_{1,0}(t) + \mathbf{p}_{1,1}(t)e^{i\kappa_1\omega t} + \mathbf{p}_{1,2}(t)e^{i\kappa_2\omega t}$$

$$\begin{aligned}
& + \mathbf{p}_{1,3}(t)e^{i\kappa_3\omega t} + \mathbf{p}_{1,4}(t)e^{i\kappa_4\omega t} \\
& + \frac{1}{\omega^2} [\mathbf{p}_{2,0}(t) + \mathbf{p}_{2,1}(t)e^{i\kappa_1\omega t} + \mathbf{p}_{2,2}(t)e^{i\kappa_2\omega t} + \mathbf{p}_{2,3}(t)e^{i\kappa_3\omega t} + \mathbf{p}_{2,4}(t)e^{i\kappa_4\omega t}] \\
& + \frac{1}{\omega^3} [\mathbf{p}_{3,0}(t) + \mathbf{p}_{3,1}(t)e^{i\kappa_1\omega t} + \mathbf{p}_{3,2}(t)e^{i\kappa_2\omega t} + \mathbf{p}_{3,3}(t)e^{i\kappa_3\omega t} + \mathbf{p}_{3,4}(t)e^{i\kappa_4\omega t}].
\end{aligned}$$

4.2.5 Numerical experiments

The nonlinear Memristor circuits do not have a known analytical solution, we come to a reference solution, the Maple routine *rkf45* with the accuracy tolerance $AbsErr = 10^{-10}$ and $RelErr = 10^{-10}$. The terms $\mathbf{p}_{1,0}$, $\mathbf{p}_{2,0}$ and $\mathbf{p}_{3,0}$ satisfy the non-oscillatory ODEs which is solved by the Maple routine *rkf45* with $AbsErr = 10^{-10}$ and $RelErr = 10^{-10}$.

Figures 4.6 to 4.10 show the error functions for y_1 , y_2 , y_3 , y_4 and y_5 for the truncated parameter $s = 0, 1, 2, 3$ within $t \in [0, 3]$ when the oscillatory parameter is $\omega = 100$ and $\omega = 1000$. The error is seen to greatly reduce with an increasing number of r levels. Furthermore, with increasing the oscillatory parameter, the error of the asymptotic method decreases rapidly, a very important virtue of the method.

In addition, the CPU time is compared to the Runge-Kutta method (*rkf45*) whose tolerance equals to 10^{-10} . It takes 275 seconds for $\omega = 500$ and about 2992 seconds for $\omega = 5000$, respectively. The CPU time for the asymptotic method is about 11 seconds for $\omega = 500$ and 13 seconds for $\omega = 5000$. As evident from our previous theoretical analysis, the computational cost is about the same for the asymptotic method regardless of the value of the oscillatory parameter.

References

- [1] Besicovitch, A. S. (1932), *Almost Periodic Functions*, Cambridge Univ. Press, Cambridge.
- [2] Bao B. C., Shi G. D., Xu J. P., Liu Z. and Pan S. H. (2011). Dynamic analysis of chaotic circuit with two memristors. *Science China*, 54, 2180-2187.
- [3] Chartier, P., Murua, A. and Sanz-Serna, J. M. (2010), Higher-order averaging, formal series and numerical integration I: B-series, *Found. Comp. Maths.* 10, 695-727.

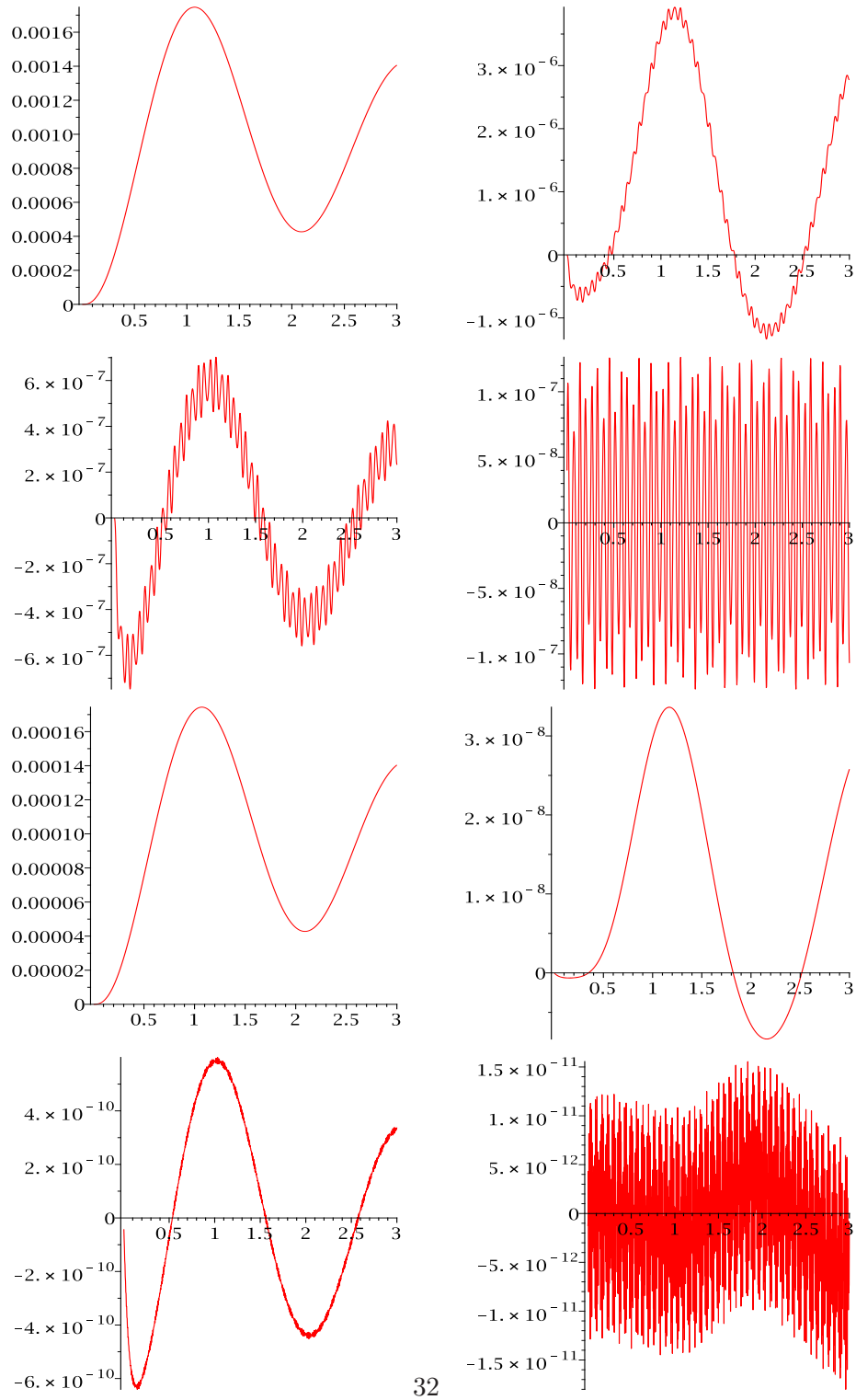

Figure 4.6: The top row: the real parts of error function with $s = 0$ (the left) and $s = 1$ (the right) for y_1 with $\omega = 100$. The middle row: the real parts of error function with $s = 2$ (the left) and $s = 3$ (the right) for y_1 with $\omega = 100$. The third row: the real parts of error function with $s = 0$ (the left) and $s = 1$ (the right) for y_1 with $\omega = 1000$. The fourth row: the real parts of error function with $s = 2$ (the left) and $s = 3$ (the right) for y_1 with

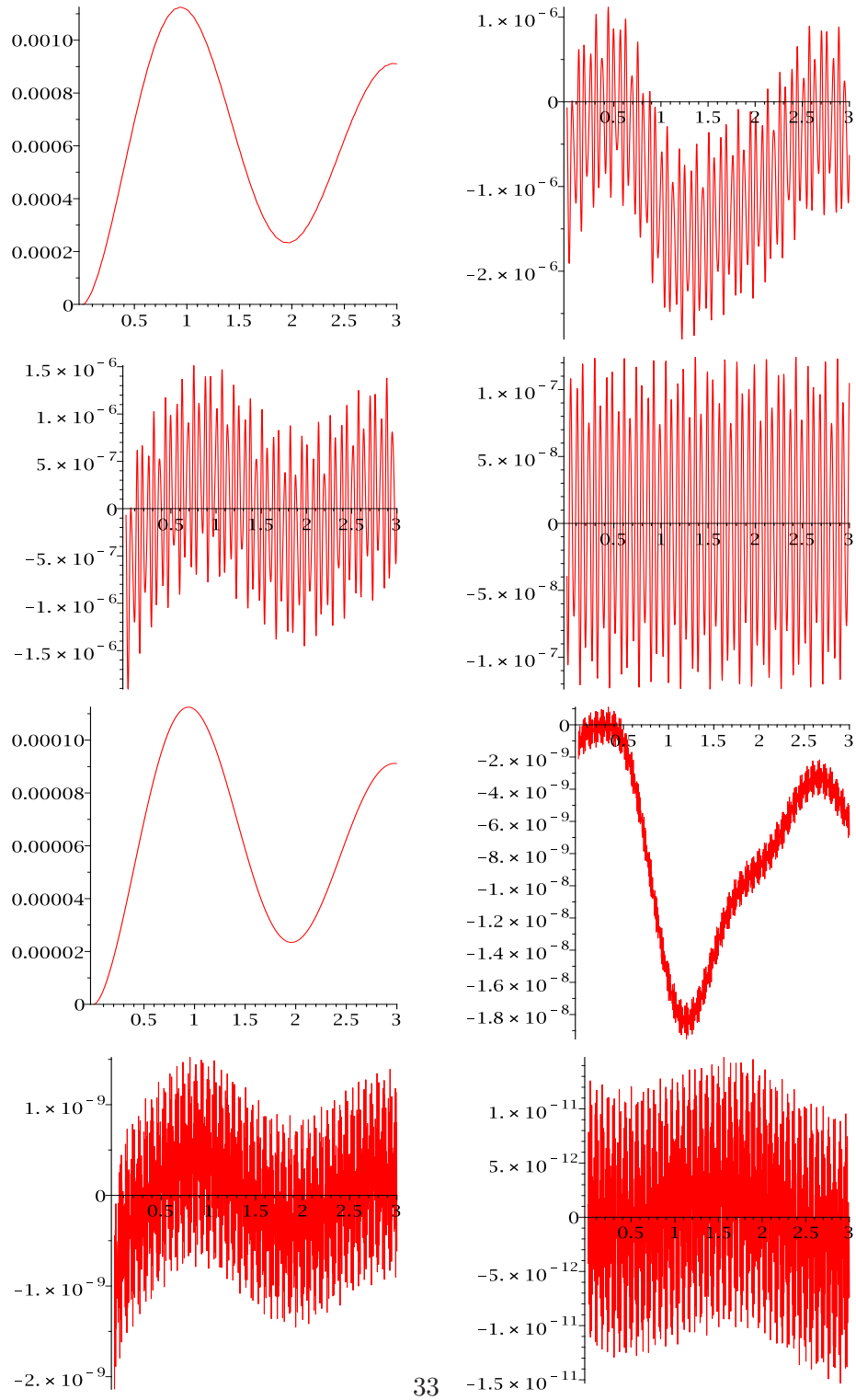

Figure 4.7: The top row: the real parts of error function with $s = 0$ (the left) and $s = 1$ (the right) for y_2 with $\omega = 100$. The middle row: the real parts of error function with $s = 2$ (the left) and $s = 3$ (the right) for y_2 with $\omega = 100$. The third row: the real parts of error function with $s = 0$ (the left) and $s = 1$ (the right) for y_2 with $\omega = 1000$. The fourth row: the real parts of error function with $s = 2$ (the left) and $s = 3$ (the right) for y_2 with

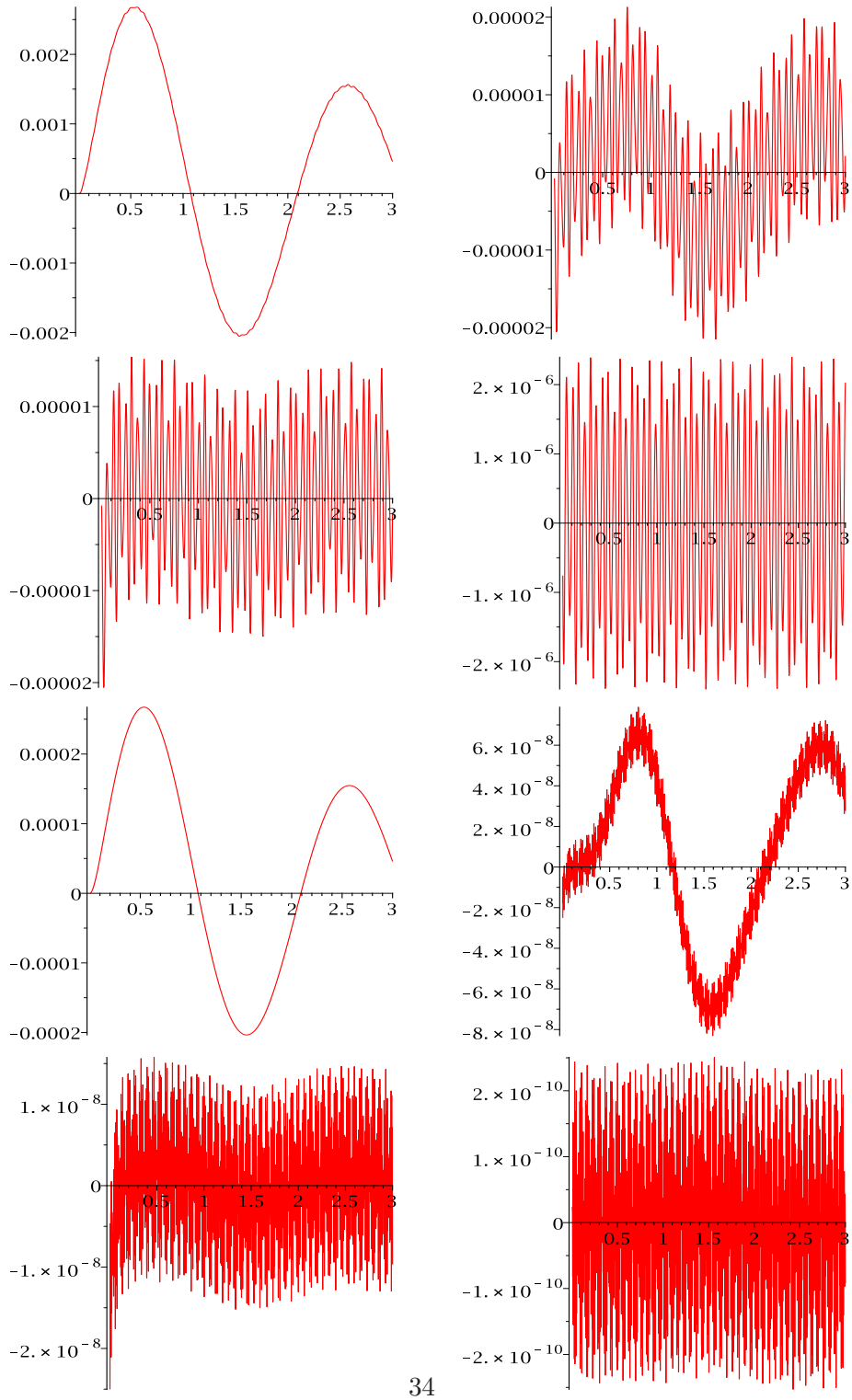

Figure 4.8: The top row: the real parts of error function with $s = 0$ (the left) and $s = 1$ (the right) for y_3 with $\omega = 100$. The middle row: the real parts of error function with $s = 2$ (the left) and $s = 3$ (the right) for y_3 with $\omega = 100$. The third row: the real parts of error function with $s = 0$ (the left) and $s = 1$ (the right) for y_3 with $\omega = 1000$. The fourth row: the real parts of error function with $s = 2$ (the left) and $s = 3$ (the right) for y_3 with

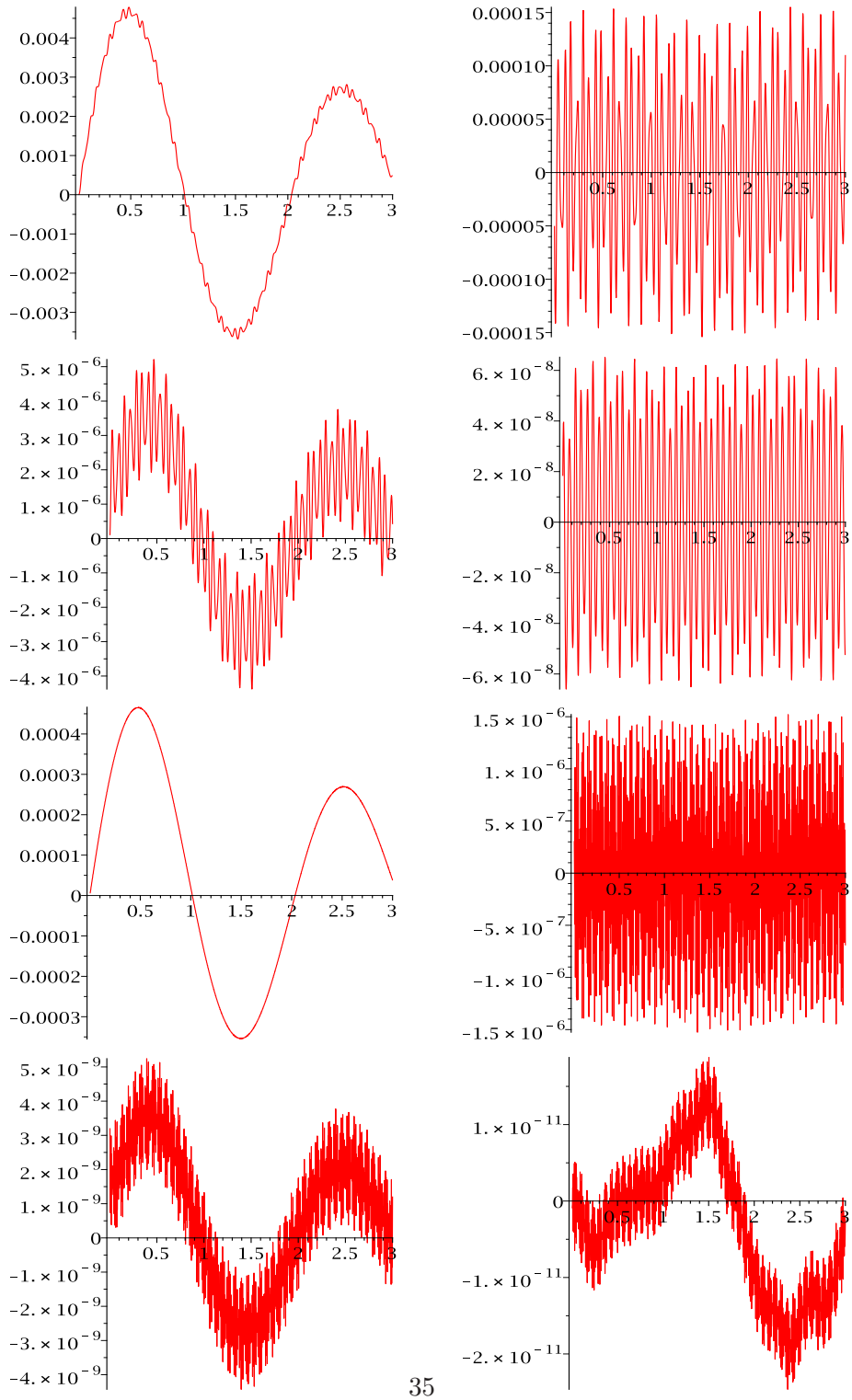

Figure 4.9: The top row: the real parts of error function with $s = 0$ (the left) and $s = 1$ (the right) for y_4 with $\omega = 100$. The middle row: the real parts of error function with $s = 2$ (the left) and $s = 3$ (the right) for y_4 with $\omega = 100$. The third row: the real parts of error function with $s = 0$ (the left) and $s = 1$ (the right) for y_4 with $\omega = 1000$. The fourth row: the real parts of error function with $s = 2$ (the left) and $s = 3$ (the right) for y_4 with

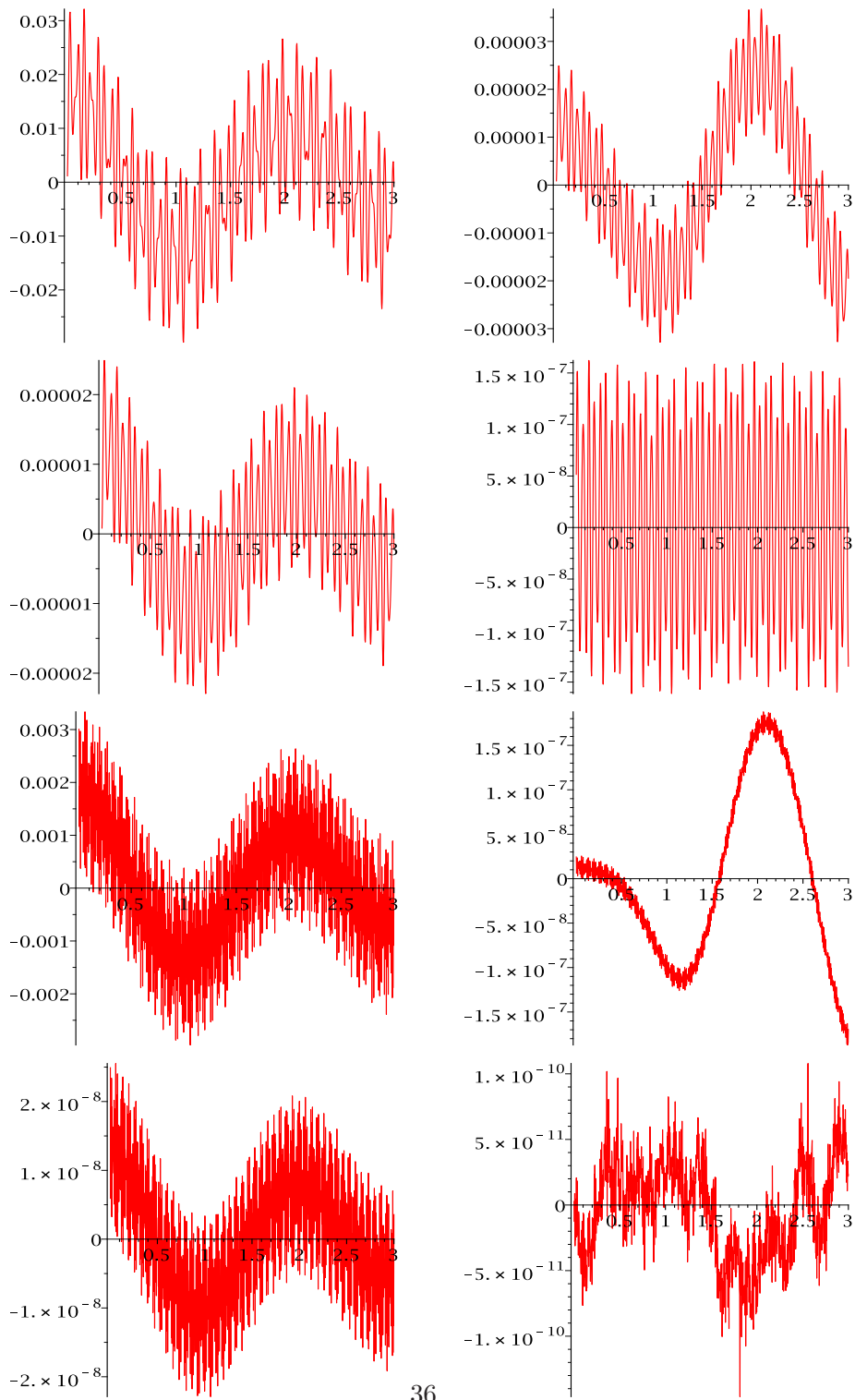

Figure 4.10: The top row: the real parts of error function with $s = 0$ (the left) and $s = 1$ (the right) for y_5 with $\omega = 100$. The middle row: the real parts of error function with $s = 2$ (the left) and $s = 3$ (the right) for y_5 with $\omega = 100$. The third row: the real parts of error function with $s = 0$ (the left) and $s = 1$ (the right) for y_5 with $\omega = 1000$. The fourth row: the real parts of error function with $s = 2$ (the left) and $s = 3$ (the right) for y_5 with

- [4] Chartier, P., Murua, A. and Sanz-Serna, J. M. (2012), Higher-order averaging, formal series and numerical integration II: the quasi-periodic case, *Found. Comp. Maths.* to appear.
- [5] Chedjou, J.C., Fotsin, H.B., Wofo, P., Domngang, S.(2001), Analog simulation of the dynamics of a Van der Pol oscillator coupled to a Duffing oscillator, *IEEE Trans. Circ. Syst. I: Fundam. Theory Appl.* 48, 748C757.
- [6] Condon, M., Deaño, A. and Iserles, A. (2010), On systems of differential equations with extrinsic oscillation, *Discr. and Cont. Dynamical Sys.* 28, 1345-1367.
- [7] E, W. and Engquist, B. (2003), The heterogeneous multiscale methods, *Commun. Math. Sci.* 1, 87-132.
- [8] Fodjouong, G.J., Fotsin, H.B., Wofo, P.(2007), Synchronizing modified van der Pol-Duffing oscillators with offset terms using observer design: application to secure communications, *Phys. Scr.* 75, 638C644.
- [9] Giannini, F. and Leuzzi, G. (2004), *Nonlinear Microwave Circuit Design*, Wiley, Chichester.
- [10] Iserles, A., Nørsett, S. P. and Olver, S. (2006), Highly oscillatory quadrature: The story so far, in A. Bermudez, ed., ‘Proceedings of ENuMath’, Springer Verlag, Berlin, pp. 97-118.
- [11] Ramírez, F., Suárez, A., Lizarraga, I. and Collantes, J.-M. (2010), Stability analysis of nonlinear circuits driven with modulated signals, *IEEE Trans. Microwave Theory Tech.*, 58, 929-940.
- [12] Sanz-Serna, J. M. (2009), Modulated Fourier expansions and heterogeneous multiscale methods, *IMA J. Numer. Anal.*, 29, 595-605.
- [13] Slight, T.J., et al.(2008), A Lienard oscillator resonant tunnelling diode-laser diode hybrid integrated circuit: model and experiment, *IEEE J. Quantum Electron.*, 44, 1158C1163.
- [14] Verhulst, F. (1990), *Nonlinear Differential Equations and Dynamical Systems*, Springer Verlag, Heidelberg.