

Low volume-fraction microstructures in martensites and crystal plasticity

Sergio Conti and Barbara Zwicknagl

Institut für Angewandte Mathematik, Universität Bonn, 53115 Bonn

July 16, 2015

Abstract

We study microstructure formation in two nonconvex singularly-perturbed variational problems from materials science, one modeling austenite-martensite interfaces in shape-memory alloys, the other one slip structures in the plastic deformation of crystals. For both functionals we determine the scaling of the optimal energy in terms of the parameters of the problem, leading to a characterization of the mesoscopic phase diagram. Our results identify the presence of a new phase, which is intermediate between the classical laminar microstructures and branching patterns. The new phase, characterized by partial branching, appears for both problems in the limit of small volume fraction, that is, if one of the variants (or of the slip systems) dominates the picture and the volume fraction of the other one is small.

1 Introduction

The study of spontaneous pattern formation in materials constitutes an important application of the calculus of variations to materials science. From a variational viewpoint, the origin of microstructure is related to a nonconvexity of the energy density, and to boundary conditions which favour states which correspond to a mixture of different minima of the energy density. In continuum mechanics typically the independent variable is the gradient of a vector field, which obeys the zero-curl differential condition, leading to strong constraints on the admissible microstructures. The theory of relaxation studies the effective behavior of nonconvex variational problems which lack lower semicontinuity and possibly existence of minimizers, but does not give detailed information on the type of microstructure expected [BJ87, Mül99, Dac07].

A finer analysis can be done if a regularization is included, in the form of a convex higher-order term, which physically may represent interfacial energies. An exact determination of the minimizers and the minimal energy is, for these more complex problems, typically impossible. Already a study of the optimal scaling of the energy with respect to the parameters of the problem may, however, give very valuable information. Starting with the works of Landau [Lan38, Lan43] on micromagnetism, branching-type patterns have been predicted and observed. They are characterized by coarse oscillations in the interior, which refine close to the boundary, as illustrated in Figure 1. At a heuristic level, the transition between coarse and fine oscillations can be understood as the result of the competition between the minimization of the total length of the interfaces, the energetic cost of bending the domains, and the boundary conditions.

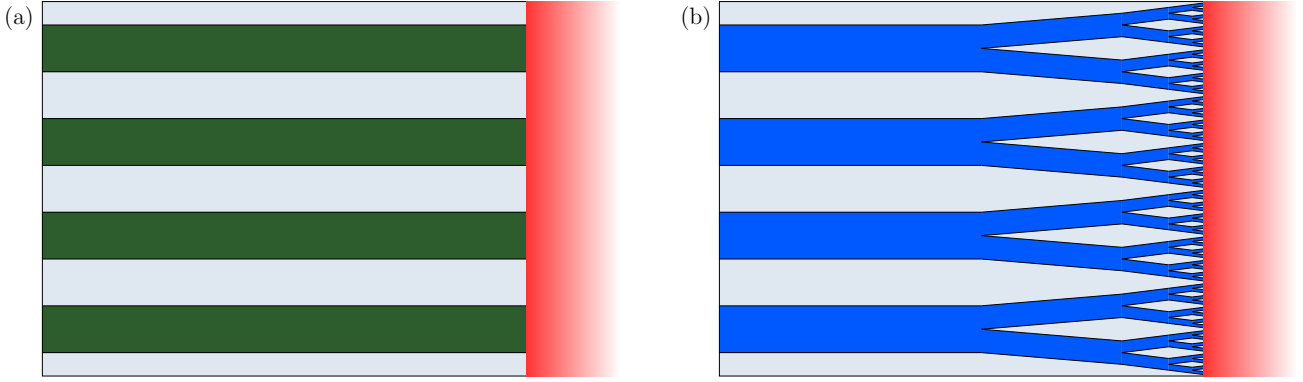

Figure 1: Left: sketch of a laminate construction. Right: sketch of the branching construction, both for volume fraction $1/2$ as in the original Kohn-Müller model. In both cases the interface to austenite is on the right.

The mathematical study of the subject began with the work of Kohn and Müller in the 90s [KM92, KM94], who proposed a simple scalar model for martensitic microstructures close to an interface with austenite, see Section 2 below for details. Their basic finding was the presence of a transition between a regime in which the energy scales proportional to $\varepsilon^{1/2}\mu^{1/2}$, with ε being the surface energy density and μ the ratio between the austenite and the martensite elastic coefficients, and a regime in which the energy scales proportional to $\varepsilon^{2/3}$. The first regime corresponds to a one-dimensional laminar pattern, the second one to a branching-type pattern, as illustrated in Figure 1.

Their results have been refined in specific regimes [Con00, GM12], extended to related scalar-valued models in different parameter regimes [Sch94, Zwi14] and to vector-valued models [CO09, KK11, CO12, KKO13, Die13, CC14, CC15, BG]. Similar results have been obtained in other variational models, including the magnetic structures in ferromagnets originally studied by Landau [CK98, CKO98, OV10, KM11], flux-domain patterns in type-I superconductors [CCKO08, COS15], diblock copolymers [Cho01, ACO09], blistering of thin compressed films [BCDM00, JS01, JS02, BBCDM02], wrinkling of stretched thin films [BK14], dislocation patterns in crystal plasticity [CO05], and compliance minimization [KW14, KW].

In this paper we specifically focus on two problems in this class where the expected microstructure is essentially two-dimensional. The first one, and the simpler one, is the Kohn-Müller functional. The second one is the scalar, but three-dimensional, model of crystal plasticity from [CO05]. We present the first model, its physical interpretation and the main results on this functional in Section 2, the other one in Section 3. After mentioning some notation in Section 4, we give the proofs for the scaling laws for the two models in Sections 5 and 6 respectively.

2 The model for martensitic microstructures

We now introduce our model for martensitic microstructures. Following Kohn and Müller [KM92, KM94] we work for simplicity in two dimensions, in antiplane shear geometry, with the scalar field u representing a deformation in the out-of-plane direction. We consider one interface between austenite

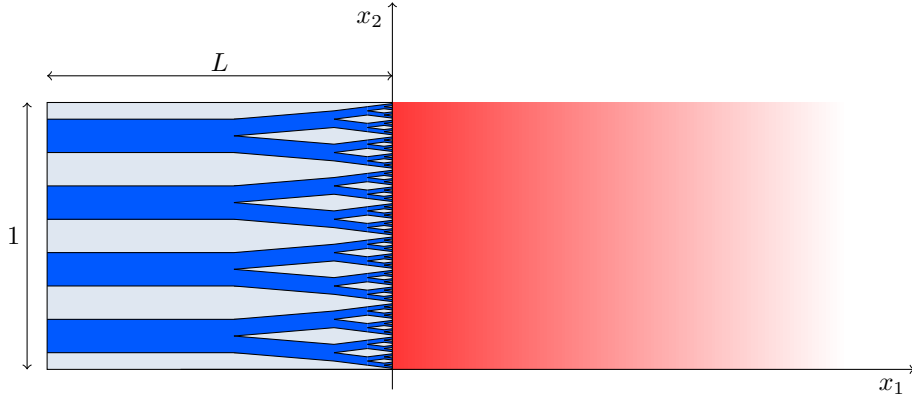

Figure 2: Sketch of the geometry in the Kohn-Müller model. The shaded area on the right represents the austenite, which extends to infinity.

and martensite, located at $\{0\} \times (0, 1)$, with austenite on the right and martensite on the left, as sketched in Figure 2. In the austenite, which for simplicity is assumed to extend to infinity, the minimum of the elastic energy is attained at $\nabla u = 0$. The coefficient $\mu > 0$ represents the ratio of the elastic coefficients of austenite and martensite, respectively (this parameter is often denoted by β in the literature). In the martensite, which we assume to cover the domain $(-L, 0) \times (0, 1)$, there are two minima of the elastic energy density. After scaling, we can write the energy as

$$J(u) := \mu \int_0^\infty \int_0^1 |\nabla u(x)|^2 dx + \int_{-L}^0 \int_0^1 (\partial_1 u(x))^2 dx + \varepsilon \int_{-L}^0 \int_0^1 |\partial_2 \partial_2 u| \quad (2.1)$$

where admissible functions $u \in W_{\text{loc}}^{1,2}(((-L, \infty) \times (0, 1))$ satisfy $\partial_2 u \in \{\theta, -1 + \theta\}$ almost everywhere in $(-L, 0) \times (0, 1)$, for some $\theta \in (0, 1/2]$. We denote by $\partial_i u := \frac{\partial}{\partial x_i} u$ the distributional derivative, in the last term $\partial_2 \partial_2 u$ is assumed to be a measure and the term has to be understood distributionally. The partial derivative $\partial_2 u$ represents the order parameter of the martensitic phase transition, and its preferred values are dictated by crystallography. The first two terms in (2.1) model the elastic energy contributions of the austenite and the martensite part, respectively. The last term in (2.1) is a regularization term which penalizes changes in the order parameter, and prevents arbitrarily fine microstructures. It can thus be interpreted as a surface energy term, ε being a typical surface energy constant per unit length. The energy functional is normalized to set the elastic modulus of martensite to one.

Mathematically, the parameter θ represents a compatibility condition. For $\theta = 0$, there exist trivial configurations with vanishing energy, while for $\theta > 0$, the minimal energy is strictly positive, and we expect the formation of microstructures. By swapping the two variants of microstructure one can assume without loss of generality that $0 < \theta \leq 1/2$. Experimental findings suggest that the size of θ is closely linked to the width of the thermal hysteresis loop in the austenite-martensite phase transition [JZ05, CCF⁺06, Zha07, ZTY⁺10, LKBH10, SCJ10, BCLdMQ12], and such low-hysteresis alloys have been found to exhibit peculiar microstructures, see e.g. [DSZJ09, DKZ⁺10, SDS⁺14].

For the symmetric case $\theta = \frac{1}{2}$, the scaling law for the minimal energy (2.1) has been studied

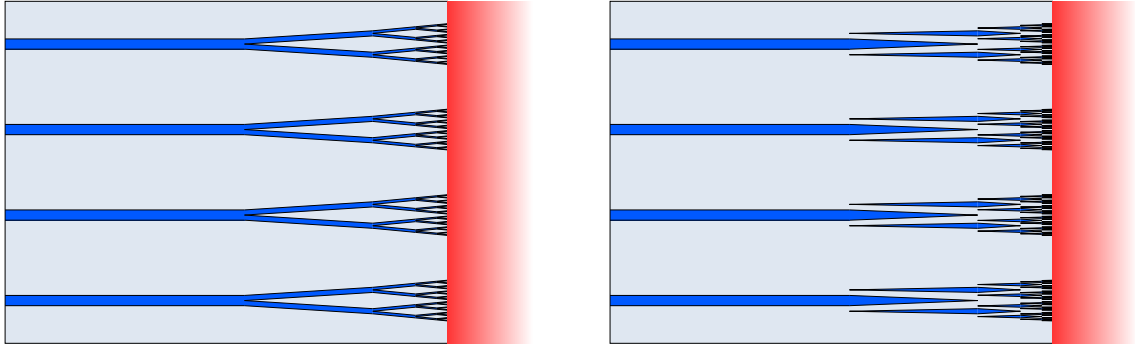

Figure 3: Sketch of the new two-scale-branching regime. Left: geometry in which the minority phase is connected. Right: geometry in which the majority phase is connected.

in [KM92, KM94, Con06]. We point out that the same scaling law for (2.1) holds if one restricts to periodic functions u , i.e., $u(x, 0) = u(x, 1)$, and if $\mu \geq 1$, then the scaling results for $\theta = \frac{1}{2}$ can be generalized to the case $\theta < \frac{1}{2}$ with the obvious modifications in the lower bound, and the same kinds of test functions to prove the upper bound (see [Zwi14]). In all cases, one observes only scaling regimes that correspond to uniform structures, to laminated structures or to geometrically refining branching patterns (see [KM94, Zwi14, Die10]). We shall show in this paper that for $\mu \ll 1$ there is an intermediate regime between laminates and branching, with the geometry sketched in Figure 3. A related intermediate regime between the branching constructions and the laminates in case of highly unequal volume fractions has been observed in a three-dimensional model of type-I superconductors [CKO98, CCKO08, COS15]. The scaling of the energy was different, and also the geometry was not the same as here. Indeed, in the superconducting case the conservation of flux forces the minority (normal) phase to be connected, as in the left panel of Figure 3. Here a second construction is possible, in which the majority phase is connected, as in the right panel of Figure 3, which has a smaller surface energy, as will become clear in Lemma 5.2 below. For the dislocation problem only the second construction gives the optimal energy scaling.

We consider the case of general μ , in particular $\mu \ll 1$. It turns out that in this case the choice of boundary conditions at the top and bottom boundaries matter. Precisely, we consider two natural classes of admissible functions, the first one with Neumann boundary conditions on the horizontal sides,

$$\mathcal{A}_N := \{u \in W_{\text{loc}}^{1,2}((-\infty, \infty) \times (0, 1)) : \partial_2 u \in \{\theta, 1 - \theta\} \text{ a.e. in } (-L, 0) \times (0, 1) \text{ and } \partial_2 \partial_2 u \text{ finite signed Radon measure}\}, \quad (2.2)$$

and the one with periodic boundary conditions on the horizontal sides,

$$\mathcal{A}_P := \{u \in \mathcal{A}_N : u(\cdot, 0) = u(\cdot, 1)\}. \quad (2.3)$$

We prove the following scaling laws for J (see Propositions 5.4 and 5.6).

Theorem 2.1 For all $\varepsilon, \mu, L > 0$ and all $0 < \theta \leq \frac{1}{2}$, we have with $\hat{\varepsilon} := \varepsilon/\theta^2$,

$$\min_{u \in \mathcal{A}_N} J(u) \sim \theta^2 \min \left\{ \hat{\varepsilon}^{2/3} L^{1/3}, \hat{\varepsilon}^{1/2}, (\hat{\varepsilon} L \mu)^{1/2} \ln^{1/2} \left(3 + \frac{\hat{\varepsilon}}{\mu^3 L} \right), (\hat{\varepsilon} L \mu)^{1/2} \ln^{1/2} \left(\frac{1}{\theta} \right), \mu \right\}, \quad (2.4)$$

and

$$\min_{u \in \mathcal{A}_P} J(u) \sim \theta^2 \max \left\{ \hat{\varepsilon} L, \min \left\{ \hat{\varepsilon}^{2/3} L^{1/3}, (\hat{\varepsilon} L \mu)^{1/2} \ln^{1/2} \left(3 + \frac{\hat{\varepsilon}}{\mu^3 L} \right), (\hat{\varepsilon} L \mu)^{1/2} \ln^{1/2} \left(\frac{1}{\theta} \right) \right\} \right\}. \quad (2.5)$$

Here and in the rest of the paper $a \sim b$ means that there is a universal constant $c > 0$ such that $\frac{1}{c}a \leq b \leq ca$. The resulting phase diagrams are, for $L = 1$, illustrated in Figure 4.

Remark 2.2 If $\theta \ll 1$, the choice of boundary conditions affects the scaling behavior in a non-trivial way. Precisely, for periodic boundary conditions we always have, by the constraint on $\partial_2 u$, the lower bound $\min_{u \in \mathcal{A}_P} J(u) \geq \varepsilon L$. Then, for $\theta \approx \frac{1}{2}$, by Theorem 2.1,

$$\begin{aligned} \min_{u \in \mathcal{A}_P} J(u) &\sim \max \left\{ \varepsilon L, \min \left\{ \varepsilon^{2/3} L^{1/3}, (\varepsilon L \mu)^{1/2} \right\} \right\} = \max \left\{ \varepsilon L, \min \left\{ \varepsilon^{2/3} L^{1/3}, (\varepsilon L \mu)^{1/2}, \mu \right\} \right\} \\ &\sim \max \left\{ \varepsilon L, \min_{u \in \mathcal{A}_N} J(u) \right\}, \end{aligned}$$

while for $\theta \ll \frac{1}{2}$, we have the different behavior

$$\begin{aligned} \min_{u \in \mathcal{A}_P} J(u) &\sim \theta^2 \max \left\{ \hat{\varepsilon} L, \min \left\{ \hat{\varepsilon}^{2/3} L^{1/3}, (\hat{\varepsilon} L \mu)^{1/2} \ln^{1/2} \left(3 + \frac{\hat{\varepsilon}}{\mu^3 L} \right), (\hat{\varepsilon} L \mu)^{1/2} \ln^{1/2} \left(\frac{1}{\theta} \right) \right\} \right\} \\ &= \theta^2 \max \left\{ \hat{\varepsilon} L, \min \left\{ \hat{\varepsilon}^{2/3} L^{1/3}, (\hat{\varepsilon} L \mu)^{1/2} \ln^{1/2} \left(3 + \frac{\hat{\varepsilon}}{\mu^3 L} \right), (\hat{\varepsilon} L \mu)^{1/2} \ln^{1/2} \left(\frac{1}{\theta} \right), \mu \ln \frac{1}{\theta} \right\} \right\} \\ &\not\sim \theta^2 \max \left\{ \hat{\varepsilon} L, \min \left\{ \hat{\varepsilon}^{2/3} L^{1/3}, (\hat{\varepsilon} L \mu)^{1/2} \ln^{1/2} \left(3 + \frac{\hat{\varepsilon}}{\mu^3 L} \right), (\hat{\varepsilon} L \mu)^{1/2} \ln^{1/2} \left(\frac{1}{\theta} \right), \mu \right\} \right\} \\ &\sim \max \left\{ \varepsilon L, \min_{u \in \mathcal{A}_N} J(u) \right\}. \end{aligned}$$

The origin of the logarithmic correction in case of periodic boundary conditions will be outlined in Remark 5.1.

3 The model for plastic microstructure

The second functional we study is a model for microstructures in crystal plasticity with large latent hardening that was proposed in [CO05]. Let $\Omega := (0, L)^3$ describe a grain of a plastic crystal, in which two slip systems are active. In a similar spirit as in the Kohn-Müller model of Section 2 we focus on a scalar u , which represents a component of the deformation, and assume that it is affected by two slip systems, with slip plane normals $e_\xi := (e_1 + e_2)/\sqrt{2}$ and $e_\eta := (e_1 - e_2)/\sqrt{2}$. In the limit of large latent hardening the two slip systems cannot be both activated at the same point in space, therefore

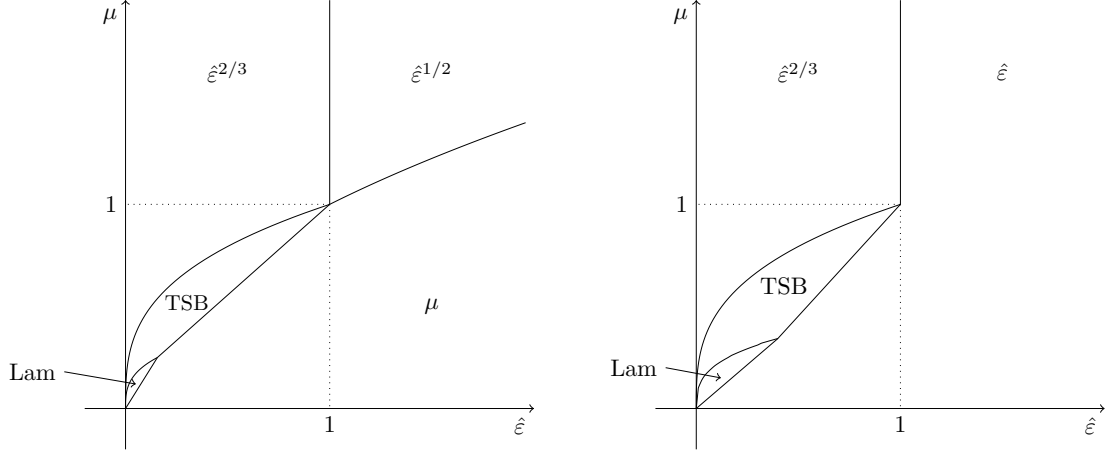

Figure 4: Phase diagrams as given in (2.4) (left) and (2.5) (right) with $L = 1$. The regions with energy proportional to $\hat{\varepsilon}^{2/3}$ corresponds to the branching patterns of Figure 1(b), the region marked “TSB” is where the new two-scale-branching regime illustrated in Figure 3 is optimal, the region marked “Lam” (very small in the left panel) is where the laminate pattern illustrated in 1(a) is optimal.

the plastic strain β is pointwise parallel to either e_ξ or e_η . We further assume that each slip system is only active with one orientation. The class of admissible deformations and plastic strains therefore takes the form

$$\mathcal{A} := \{(u, \beta) \in L^1(\Omega) \times L^1(\Omega; \mathbb{R}^3) : \beta_3 = 0, \beta_\xi \beta_\eta = 0 \text{ and } \beta_\eta, \beta_\xi \geq 0 \text{ a.e.}\}. \quad (3.1)$$

Here and in the rest of the paper, given a vector $v \in \mathbb{R}^3$ we denote the components along ξ and η by $v_\xi := v \cdot e_\xi$ and $v_\eta := v \cdot e_\eta$, and the Cartesian ones by $v_i := v \cdot e_i$, $i = 1, 2, 3$.

The energy is given by the sum of the elastic energy and the line-tension energy of the geometrically necessary dislocations. Dislocations are topological defects in crystals which are responsible for plastic deformation processes, they are necessarily present whenever the plastic part of the deformation gradient is not a gradient field itself. Geometrically necessary dislocations are the dislocations whose presence can be inferred from the fact that the plastic strain β is not a gradient field. Starting from a variety of microscopic models it has been proven that the energetic contribution of such dislocations is linear in the curl of β , with a coefficient which depends on the local Burgers vector and slip-plane normal, see for example [GM06, GLP10, CGM11, MSZ14, CGO15].

Working in the coordinates (e_ξ, e_η, e_3) it is easy to see that the relevant terms are $\partial_\xi \beta_\eta$ and $\partial_\eta \beta_\xi$. A detailed analysis of the latent-hardening condition from a relaxation viewpoint leads to the interpretation of $|\text{curl } \beta|$ as $|\partial_\xi \beta_\eta| + |\partial_\eta \beta_\xi|$, where both derivatives are interpreted distributionally, see [CO05] for a motivation. In the present setting there is only one Burgers vector, since u is a scalar. In order to study the scaling of the energy we can neglect the dependence on orientation and consider an isotropic penalization of $\text{curl } \beta$. It is however important that not all components of the gradient $D\beta$ enter the energy.

The elastic energy can be computed from the elastic strain, which is $Du - \beta$ in Ω and Du outside.

Denoting by $\varepsilon > 0$ the line-tension energy of a dislocation, the functional takes the form

$$E(u, \beta) := \int_{\Omega} [|Du(x) - \beta(x)|^2 dx + \varepsilon (|\partial_{\xi}\beta_{\eta}| + |\partial_3\beta_{\eta}| + |\partial_{\eta}\beta_{\xi}| + |\partial_3\beta_{\xi}|)] + \mu \int_{\mathbb{R}^3 \setminus \Omega} |D(u - u_0)(x)|^2 dx. \quad (3.2)$$

As in (2.1), the terms $\partial_i\beta_j$ are interpreted distributionally. The relative activity of the two slip systems is fixed by the far-field deformation u_0 , which will be taken affine. We refer to [CO05] for a more detailed physical motivation of the model and to [AD14, AD15] for a discussion of the relaxation of E .

The energy scaling for the case of the far-field deformation $u_0(x) = x_1$, corresponding to a half-half mixture of the two slip directions e_{ξ} and e_{η} , was studied in [CO05]. The key result was that the optimal energy scales, for small ε , as the minimum of $\varepsilon^{1/2}\mu^{1/2}$ and $\varepsilon^{2/3}$, similarly to the Kohn-Müller model. The first scaling regime corresponds to the experimentally known Hall-Petch law, which states that the critical stress for plastic deformation in a polycrystal scales as the grain size to the power $-1/2$.

Here we consider a situation in which the boundary data favor states in which one of the two slip systems dominates, corresponding to a macroscopic forcing of the type

$$u_0(x) := (1 - \theta)x_{\xi} + \theta x_{\eta} \quad (3.3)$$

where $\theta \in (0, 1/2)$. We derive the following scaling law for E as defined in (3.2) (see Propositions 6.1 and 6.6).

Theorem 3.1 *For all $\varepsilon, L, \mu > 0$ and all $\theta \leq \frac{1}{2}$, we have with $\hat{\varepsilon} := \varepsilon/(L\theta^2)$,*

$$\inf_{\mathcal{A}} E(u, \beta) \sim L^3 \theta^2 \min \left\{ \hat{\varepsilon}^{2/3}, (\hat{\varepsilon}\mu)^{1/2} \ln^{1/2} \left(3 + \frac{\hat{\varepsilon}}{\mu^3} \right), (\hat{\varepsilon}\mu)^{1/2} \ln^{1/2} \left(\frac{1}{\theta} \right), \mu, 1 \right\}.$$

Similarly to the martensite case, we recover all regimes from the case of equal volume fraction, and show that there is an additional intermediate scaling regime, which is achieved by a two-scale branching construction. The proof of this result is given in Section 6 below.

4 Preliminaries and notation

Throughout the text, we denote by c positive constants that do not depend on any of the parameters ε, L, θ or μ but that may change from expression to expression. For $A, B > 0$, we use the notation $A \lesssim B$ if there is $c > 0$ such that $A \leq cB$, and similarly for \gtrsim and \sim . For a measurable set $M \subset \mathbb{R}^n$, we denote by $|M|$ its n -dimensional Lebesgue measure. For $f \in L^1(M)$, $\int_M |\partial_i f| = |\partial_i f|(M)$ denotes the total variation of the distributional derivative along e_i . For the Kohn-Müller model (2.1), the elastic energy of the austenite part can be expressed as trace norm at the interface, i.e., with $u_0(\cdot) := u(0, \cdot)$,

$$[u_0]_{H_N^{1/2}((0,1))}^2 := \inf \left\{ \int_0^{\infty} \int_0^1 |\nabla v(x)|^2 dx : v(0, x_2) = u_0(x_2), v \in W_{\text{loc}}^{1,2}((0, \infty) \times (0, 1)) \right\} \text{ for } u \in \mathcal{A}_N,$$

and for $u \in \mathcal{A}_P$

$$[u_0]_{H_P^{1/2}((0,1))}^2 := \inf \left\{ \int_0^\infty \int_0^1 |\nabla v(x)|^2 dx : v(0, x_2) = u_0(x_2), v \in W_{\text{loc}}^{1,2}((0, \infty) \times (0, 1)), v(\cdot, 0) = v(\cdot, 1) \right\}.$$

We denote by $H_P^{1/2}((0, 1))$ and $H_N^{1/2}((0, 1))$ the spaces of functions in $L^2((0, 1))$ for which the respective seminorms are finite. Note that the above are two different seminorms, and the choice of boundary conditions affects the value of the trace norm, hence we use two different symbols for $H_N^{1/2}$ and $H_P^{1/2}$. Indeed, functions with jump discontinuities are not contained in $H^{1/2}$, hence no jump discontinuity between the two boundary points is permitted in $H_P^{1/2}$, at variance with $H_N^{1/2}$ (see Remark 5.1). For later reference, we recall equivalent representations of the norms. First (see, for example, [GM12]),

$$[u_0]_{H_P^{1/2}((0,1))}^2 = \int_0^1 \int_{-\infty}^{+\infty} \frac{|u_0(z_1) - u_0(z_2)|^2}{|z_1 - z_2|^2} dz \quad \text{for all } u \in \mathcal{A}_P, \quad (4.1)$$

where we identify u_0 with its 1-periodic extension; on the other hand, by Gagliardo's inequality (see, e.g., [Leo09, Chapter 15.3]),

$$[u_0]_{H_N^{1/2}((0,1))}^2 \sim \int_0^1 \int_0^1 \frac{|u_0(z_1) - u_0(z_2)|^2}{|z_1 - z_2|^2} dz \quad \text{for all } u \in \mathcal{A}_N. \quad (4.2)$$

Further, for $u \in H_P^{1/2}((0, 1))$, the $H_P^{1/2}$ -seminorm can be equivalently characterized in terms of the Fourier series. Precisely, if $u(x) = \sum_{k \in \mathbb{Z}} u_k e^{2\pi i k x}$, then

$$[u]_{H_P^{1/2}((0,1))}^2 \sim \sum_{k \in \mathbb{Z}} |k| |u_k|^2. \quad (4.3)$$

We note the following interpolation result.

Lemma 4.1 *There is a constant $c > 0$ such that for all $v \in H_N^{1/2}((0, 1))$ and $\psi \in H_P^{1/2}((0, 1)) \cap H^1((0, 1))$,*

$$\int_0^1 v(x) \psi'(x) dx \leq c [v]_{H_N^{1/2}((0,1))} [\psi]_{H_P^{1/2}((0,1))}. \quad (4.4)$$

Proof: We first assume additionally that $u \in H_P^{1/2}((0, 1))$. Let $u(x) = \sum_{k \in \mathbb{Z}} u_k e^{2\pi i k x}$ and $\psi(x) = \sum_{k \in \mathbb{Z}} \psi_k e^{2\pi i k x}$ be the Fourier series. Then by Cauchy-Schwarz and (4.3)

$$\left| \int_0^1 u(x) \psi'(x) dx \right| \lesssim \left| \sum_{k \in \mathbb{Z}} k u_k \psi_k \right| \lesssim [u]_{H_P^{1/2}((0,1))} [\psi]_{H_P^{1/2}((0,1))}.$$

We turn to the general case. Without loss of generality, we may assume that $\psi(0) = \psi(1) = 0$. We extend v and ψ to $(0, 2)$ by setting $v(1+x) := v(1-x)$ and $\psi(1+x) := -\psi(1-x)$ for $x \in (0, 1)$. Then $v, \psi \in H_P^{1/2}((0, 2))$ and by (i),

$$\int_0^1 v(x) \psi'(x) dx = \frac{1}{2} \int_0^2 v(x) \psi'(x) dx \leq c [v]_{H_P^{1/2}((0,2))} [\psi]_{H_P^{1/2}((0,2))} \sim [v]_{H_N^{1/2}((0,1))} [\psi]_{H_N^{1/2}((0,1))},$$

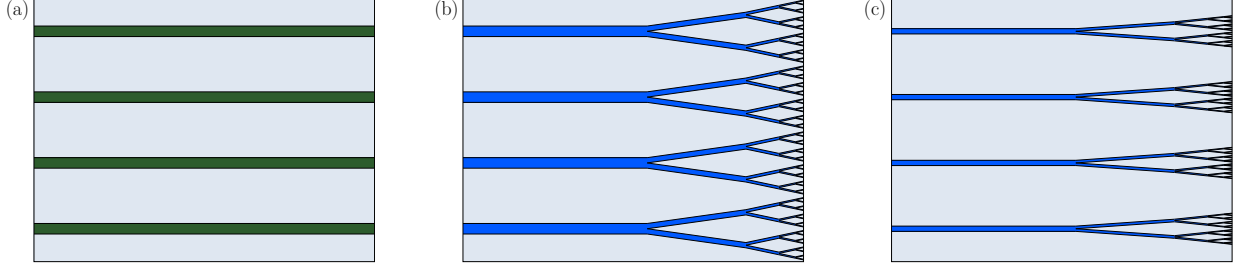

Figure 5: Sketch of the constructions used in the upper bound.

where the last step follows directly from the definition by extending test functions for v and ψ on the smaller strip $(0, \infty) \times (0, 1)$ (anti-)symmetrically to $(0, \infty) \times (0, 2)$, and on the other hand restricting test functions on $(0, \infty) \times (0, 2)$ to the smaller strip. \square

Similarly, we define the $H_N^{1/2}$ -seminorm for functions on rectangles $R \subset \mathbb{R}^2$ via

$$[v]_{H_N^{1/2}(R)}^2 := \inf \left\{ \int_R \int_0^\infty |\nabla V(x)|^2 dx : V(x_1, x_2, 0) = v(x_1, x_2), V \in W_{\text{loc}}^{1,2}(R \times (0, \infty)) \right\},$$

and for the boundary of a cube $\Omega = (0, L)^3$, we set

$$[v]_{H^{1/2}(\partial\Omega)}^2 := [v]_{H_N^{1/2}(\partial\Omega)}^2 := \inf \left\{ \int_{\mathbb{R}^3 \setminus \Omega} |\nabla V(x)|^2 dx : V = v \text{ on } \partial\Omega, V \in W_{\text{loc}}^{1,2}(\mathbb{R}^3 \setminus \Omega) \right\}.$$

We will use the following lemma.

Lemma 4.2 *Set $R := (0, a) \times (0, b) \subset \mathbb{R}^2$. Let $H : R \rightarrow \mathbb{R}$ and set $h : (0, b) \rightarrow \mathbb{R}$, $h(x_2) := \frac{1}{a} \int_0^a H(x_1, x_2) dx_1$. Then $[h]_{H_N^{1/2}((0,b))} \lesssim a^{-1/2} [H]_{H_N^{1/2}(R)}$.*

Proof: Let $\delta > 0$ be arbitrary, and let $\tilde{H} : R \times (0, \infty) \rightarrow \mathbb{R}$ be such that $\tilde{H}(x_1, x_2, 0) = H(x_1, x_2)$ and $\int_{R \times (0, \infty)} |\nabla \tilde{H}|^2 dx \leq [H]_{H_N^{1/2}(R)}^2 + \delta$. Define an extension \tilde{h} for h via $\tilde{h}(x_2, x_3) := \frac{1}{a} \int_0^a \tilde{H}(x_1, x_2, x_3) dx_1$. Then the assertion follows by Jensen's inequality and arbitrariness of $\delta > 0$. \square

5 Proof of the scaling laws for the Kohn-Müller model

5.1 Upper bound

We use the following construction for the proof of the upper bounds in (2.4) and, with slight modifications also in (2.5). Our main new contribution in this section is the two-scale branching construction sketched in Figure 5(c). An important building block for all constructions are the following two functions which also show the main difference between the two kinds of boundary conditions.

Uniform configuration/Single laminate.

- (i) For Neumann boundary conditions, we consider a uniform configuration in the martensite part and set

$$u_U(x_1, x_2) := \begin{cases} \theta x_2 & \text{if } (x_1, x_2) \in [-L, 0] \times [0, 1], \\ (1 - x_1)\theta x_2 & \text{if } (x_1, x_2) \in [0, 1] \times [0, 1], \\ 0 & \text{otherwise.} \end{cases}$$

Then $u_U \in \mathcal{A}_N$ and

$$J(u_U) = \mu\theta^2 \int_0^1 \int_0^1 (x_2^2 + (1 - x_1)^2) \, dx = \frac{2}{3}\mu\theta^2.$$

- (ii) For periodic boundary conditions, we consider a single laminate in the martensite part and set

$$u_{SL}(x_1, x_2) := \begin{cases} (-1 + \theta)x_2 & \text{if } (x_1, x_2) \in [-L, 0] \times [0, \theta], \\ \theta(x_2 - 1) & \text{if } -L \leq x_1 \leq 1, \max\{\theta, (1 - \theta)x_1 + \theta\} \leq x_2 \leq 1, \\ \theta x_2 \left(1 - \frac{1}{(1 - \theta)x_1 + \theta}\right) & \text{if } 0 \leq x_1 \leq 1, 0 \leq x_2 \leq (1 - \theta)x_1 + \theta, \\ 0 & \text{if } x_1 \geq 1. \end{cases} \quad (5.1)$$

Then $u_{SL} \in \mathcal{A}_P$, and

$$J(u_{SL}) \lesssim \varepsilon L + \mu\theta^2 \ln \frac{1}{\theta} = \theta^2(\hat{\varepsilon}L + \mu \ln \frac{1}{\theta}).$$

Remark 5.1 *We note that, given the single laminate construction in the martensite part, the extension to the austenite part given in (5.1) yields the optimal scaling for the elastic energy. Precisely,*

$$[u_{SL}(0, \cdot)]_{H_P^{1/2}((0,1))}^2 \sim \theta^2 \ln \frac{1}{\theta}. \quad (5.2)$$

The logarithmic correction term is due to the periodicity assumption. In contrast, we have

$$[u_{SL}(0, \cdot)]_{H_N^{1/2}((0,1))}^2 \sim [u_U(0, \cdot)]_{H_N^{1/2}((0,1))}^2 \sim \theta^2. \quad (5.3)$$

Proof: To prove (5.2) it remains to show a lower bound on the seminorm. For that, we use the equivalent form (4.1), we identify $u_{SL}(0, \cdot)$ with its 1-periodic extension and estimate

$$\begin{aligned} [u_{SL}(0, \cdot)]_{H_P^{1/2}((0,1))}^2 &\geq \int_{7/8}^1 \int_{1+\theta}^{1+\theta+1/8} \frac{|u_{SL}(0, z_1) - u_{SL}(0, z_2)|^2}{|z_1 - z_2|^2} \, dz \\ &\geq \left(\frac{\theta}{4}\right)^2 \int_{7/8}^1 \int_{1+\theta}^{1+\theta+1/8} \frac{1}{|z_1 - z_2|^2} \, dz \gtrsim \theta^2 \ln \frac{1}{\theta}. \end{aligned}$$

To show (5.3), we first extend $u_{SL}(0, \cdot)$ to $[0, \theta] \times [0, 1]$ by

$$u(x_1, x_2) := \begin{cases} (-1 + \theta)x_2 - x_1 & \text{if } 0 \leq x_2 \leq \theta - x_1, \\ \theta(x_2 - 1) & \text{if } \theta - x_1 \leq x_2 \leq 1. \end{cases}$$

Then $u(\theta, x_2) = u_U(0, x_2) - \theta$, and consequently, since $\int_0^\theta \int_0^1 |\nabla u(x)|^2 dx \lesssim \theta^2$, we have $[u_{SL}]_{H_P^{1/2}(0,1)}^2 \lesssim [u_U]_{H_N^{1/2}(0,1)}^2 + \theta^2$ and $[u_U]_{H_N^{1/2}(0,1)}^2 \lesssim [u_{SL}]_{H_P^{1/2}(0,1)}^2 + \theta^2$, which concludes the proof since $[u_U]_{H_N^{1/2}(0,1)}^2 \sim \theta^2$ as shown in (i) above. \square

All remaining constructions are special cases of a two-scale branching construction, which relies on the following lemma. The latter is a straight-forward generalization of a construction from [KM94, Lemma 2.3].

Lemma 5.2 *Suppose that $0 < \theta \leq \frac{1}{2}$, and let $h, \eta, \ell > 0$ be such that $\theta h \leq \eta \leq h$. Then there is a function $b := b^{(h, \eta, \ell)} : (-\ell, 0) \times (0, h) \rightarrow \mathbb{R}$ with the following properties:*

(i) $b(x_1, 0) = 0, b(x_1, h) = h\theta - \eta,$

$$b(-\ell, x_2) = \begin{cases} \theta x_2 & \text{if } 0 \leq x_2 \leq (h - \eta)/2, \\ (-1 + \theta)x_2 + (h - \eta)/2 & \text{if } (h - \eta)/2 \leq x_2 \leq (h + \eta)/2, \\ \theta x_2 - \eta & \text{if } (h + \eta)/2 \leq x_2 \leq h, \end{cases}$$

and $b(-\ell, x_2) = N(h\theta - \eta) + b(-\ell, \tilde{x}_2)$ if $x_2 = Nh + \tilde{x}_2$ with $N \in \mathbb{N}$ and $\tilde{x}_2 \in [0, h),$

(ii) $b(0, x_2) = \frac{1}{2}b(-\ell, 2x_2)$ if $0 \leq x_2 \leq h/2$ and $\partial_2 b(0, x_2)$ is $h/2$ -periodic,

(iii) $\partial_2 b \in \{\theta, -1 + \theta\}$ almost everywhere,

(iv) $\|\partial_1 b\|_{L^2((-\ell, 0) \times (0, h))}^2 \leq C\eta^2(h - \eta)/\ell$, where C does not depend on h, ℓ, θ or η ,

(v) $\int_{(-\ell, 0) \times (0, h)} |\partial_2 \partial_2 b| \leq 4\ell$

(vi) $\int_{(-\ell, 0) \times (0, h)} |\partial_1 \partial_2 b| \leq 4\eta.$

Proof: The function b is sketched in Figure 6 (right). By (ii), it suffices to construct b for $x_2 \leq h/2$, namely

$$b(x_1, x_2) := \begin{cases} \theta x_2 & \text{if } 0 \leq x_2 \leq \frac{h-\eta}{4}, \\ (\theta - 1)x_2 + \frac{h-\eta}{4} & \text{if } \frac{h-\eta}{4} \leq x_2 \leq \frac{h+\eta}{4} + \frac{\eta x_1}{2\ell}, \\ \theta x_2 - \frac{\eta x_1}{2\ell} - \frac{\eta}{2} & \text{if } \frac{h+\eta}{4} + \frac{\eta x_1}{2\ell} \leq x_2 \leq \frac{h}{2} + \frac{\eta x_1}{2\ell}, \\ (\theta - 1)x_2 + \frac{h-\eta}{4} & \text{if } \frac{h}{2} + \frac{\eta x_1}{2\ell} \leq x_2 \leq h/2. \end{cases}$$

and to evaluate all integrals. We remark that all conditions except the last one would also be satisfied by the construction with a connected minority phase. The last one is not important for the Kohn-Müller model, but will become relevant for the dislocation model.

$$\hat{b}(x_1, x_2) := \begin{cases} \theta x_2 & \text{if } 0 \leq x_2 \leq \frac{h-\eta}{4}(1 - \frac{x_1}{\ell}), \\ (\theta - 1)x_2 + \frac{h-\eta}{4}(1 - \frac{x_1}{\ell}) & \text{if } \frac{h-\eta}{4}(1 - \frac{x_1}{\ell}) \leq x_2 \leq \frac{h-\eta}{4}(1 - \frac{x_1}{\ell}) + \frac{\eta}{2}, \\ \theta x_2 - \frac{\eta}{2} & \text{if } \frac{h-\eta}{4}(1 - \frac{x_1}{\ell}) + \frac{\eta}{2} \leq x_2 \leq \frac{h}{2}, \end{cases}$$

extended so that $\partial_2 \hat{b}$ is $h/2$ -periodic in x_2 . \square

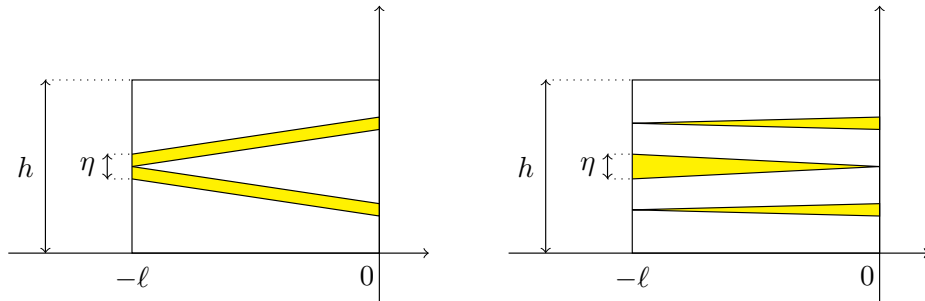

Figure 6: Sketch of the construction of Lemma 5.2. Left: the connected pattern described by \hat{b} , which has a longer vertical component of the interface and does not satisfy (vi). Right: the disconnected pattern of b , which fulfills all stated properties.

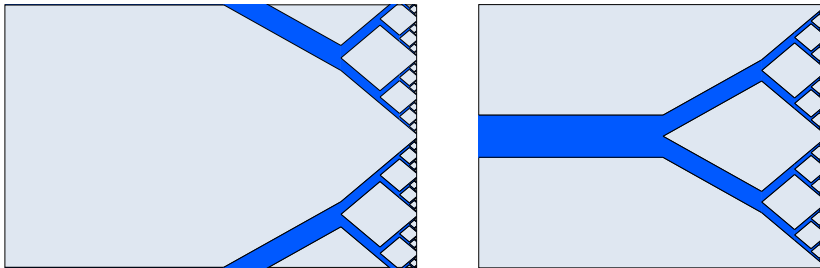

Figure 7: Sketch of the truncated branching construction for Neumann boundary data (left) and periodic boundary data (right).

Two-scale branching. We present a new construction which as special cases comprises test functions from the literature, in particular laminated structures, the single laminate and branched patterns (see below). Let $N \in \mathbb{N}$, $0 < \ell \leq L$ and $\theta \leq h \leq 1$ be such that $\ell = L$ if $N > 1$. We construct a deformation u_{TSB} in three steps:

Step 1: Construction for $-\ell \leq x_1 \leq 0$: We construct an admissible function u_{TSB} that is periodic in x_2 -direction with period $1/N$, and describe the construction on $[-\ell, 0] \times [0, 1/N]$. We set

$$u_{TSB}(x_1, x_2) := \begin{cases} \theta x_2 & \text{if } x_2 \in [0, \frac{1-h}{2N}], \\ \theta(x_2 - \frac{1}{N}) & \text{if } x_2 \in [\frac{1+h}{2N}, \frac{1}{N}], \end{cases}$$

and construct a branching function on the rectangle $R_1 := [-\ell, 0] \times [\frac{1-h}{2N}, \frac{1+h}{2N}]$ as follows: Subdivide R_1 into rectangles

$$R_{ij} := [-3^{-i}\ell, -3^{-(i+1)}\ell] \times [\frac{1-h}{2N} + \frac{jh}{2^i N}, \frac{1-h}{2N} + \frac{(j+1)h}{2^i N}], \quad i = 0, 1, \dots, \quad \text{and } j = 0, \dots, 2^i - 1,$$

and consider the bottom rectangles R_{i0} first. On level $i = 0, 1, \dots$ choose $\ell_i := \frac{2}{3}3^{-i}\ell$, $h_i := \frac{h}{2^i N}$ and $\eta_i := \frac{\theta}{2^i N}$ and note that the assumptions of Lemma 5.2 are satisfied. We use the function $b^{(h_i, \eta_i, \ell_i)}$ from Lemma 5.2 and set

$$u_{TSB}(x_1, x_2) := b^{(h_i, \eta_i, \ell_i)}(x_1 + (3^{-i}\ell - \ell_i), x_2 - \frac{1-h}{2N}) + \frac{1-h}{2N}\theta.$$

The function u_{TSB} is then extended to a continuous function on $\cup_j R_{ij}$ such that $\partial_2 u_{TSB}$ is $h/(2^i N)$ -periodic in x_2 -direction. By Lemma 5.2 this yields a continuous function u_{TSB} on $(-\ell, 0) \times (0, 1)$ with $\partial_2 u_{TSB} \in \{\theta, -1 + \theta\}$ almost everywhere, and

$$\int_{-\ell}^0 \int_0^1 |\partial_1 u_{TSB}|^2 dx + \varepsilon |\partial_2 \partial_2 u_{TSB}| \lesssim \sum_{i=0}^{\infty} \left\{ \left(\frac{3}{4}\right)^i \frac{(h-\theta)\theta^2}{\ell N^2} + \left(\frac{2}{3}\right)^i \varepsilon \ell N \right\} \lesssim \frac{(h-\theta)\theta^2}{\ell N^2} + \varepsilon \ell N. \quad (5.4)$$

Step 2: Construction for $x_1 \geq 0$: For $0 \leq x_1 \leq \frac{1-h}{2N}$ and $0 \leq x_2 \leq \frac{1}{N}$, we set $u_{TSB}(x_1, x_2) := \frac{1}{N}u(Nx_1, Nx_2)$ with

$$u(x_1, x_2) := \begin{cases} \theta x_2 & \text{if } 0 \leq x_2 \leq -x_1 + \frac{1-h}{2}, \\ \theta(1 - \frac{1}{2x_1+h})(x_2 - \frac{1}{2}) & \text{if } -x_1 + \frac{1-h}{2} \leq x_2 \leq x_1 + \frac{1+h}{2}, \\ \theta(x_2 - 1) & \text{if } x_1 + \frac{1+h}{2} \leq x_2 \leq 1, \end{cases}$$

set $u_{TSB}(x_1, x_2) := 0$ if $x_1 \geq \frac{1-h}{2N}$, and extend it periodically in x_2 -direction with period $\frac{1}{N}$. Note that for $h = 1$, we have $u(x_1, x_2) = 0$ if $x_1 \geq 0$. We obtain

$$\mu \int_0^{\infty} \int_0^1 |\nabla u_{TSB}(x)|^2 dx \lesssim \mu \frac{\theta^2}{N} \ln \frac{1}{h}. \quad (5.5)$$

Summarizing, if $\ell = L$, we have constructed a function $u_{TSB} \in \mathcal{A}_D \subset \mathcal{A}_N$ such that (see (5.4) and (5.5))

$$J(u_{TSB}) \lesssim \theta^2 \left(\frac{(h-\theta)}{L} \frac{1}{N^2} + \varepsilon \ell N + \frac{\mu}{N} \ln \frac{1}{h} \right). \quad (5.6)$$

We remark that the term proportional to μ disappears for $h = 1$.

Step 3: Construction for $-L \leq x_1 \leq \ell$: It remains to consider the case $\ell < L$. Recall that we allow $\ell \leq L$ only if $N = 1$ (this will be needed in case of Neumann boundary conditions below). We distinguish between Dirichlet and Neumann boundary conditions. To construct a periodic function $u_{TSB}^{(P)} \in \mathcal{A}_P$, we extend u_{TSB} constantly in x_1 , i.e.,

$$u_{TSB}^{(P)}(x_1, x_2) := u_{TSB}(-\ell, x_2) \quad \text{for all } -L \leq x_1 \leq -\ell.$$

We obtain an additional energy contribution

$$\varepsilon \int_{(-L, -\ell) \times (0, 1)} |\partial_2 \partial_2 u_{TSB}^{(P)}| \lesssim (L - \ell) \varepsilon N. \quad (5.7)$$

In case of Neumann boundary conditions, we introduce an interpolation layer analogously to the truncated branching construction from [Zwi14, Theorem 1]. Precisely, we set (if $L \leq 2\ell$, we use the restriction of the function)

$$u_{TSB}^{(N)}(x_1, x_2) := \begin{cases} (-1 + \theta)x_2 & \text{if } 0 \leq x_2 \leq \frac{\theta}{2\ell}x_1 + \theta, \\ \theta x_2 - \frac{\theta}{2\ell}x_1 - \theta & \text{if } \frac{\theta}{2\ell}x_1 + \theta \leq x_2 \leq -\frac{\theta}{2\ell}x_1 + 1 - \theta, \\ (-1 + \theta)x_2 - \frac{\theta}{\ell}x_1 + 1 - 2\theta & \text{if } -\frac{\theta}{2\ell}x_1 + 1 - \theta \leq x_2 \leq 1, \end{cases}$$

and extend $u_{TSB}^{(N)}$ constantly in x_1 for $x_1 \leq -2\ell$, i.e.,

$$u_{TSB}^{(N)}(x_1, x_2) := u_{TSB}^{(N)}(-2\ell, x_2) = \theta x_2 \quad \text{if } -L \leq x_1 \leq -2\ell.$$

Therefore, the additional energy contribution is estimated above by

$$\int_{(-L, -\ell) \times (0, 1)} |\partial_1 u_{TSB}^{(N)}(x)|^2 dx + \varepsilon |\partial_2 \partial_2 u_{TSB}^{(N)}| \lesssim \theta^2 \left(\frac{1}{\ell} + \hat{\varepsilon} \ell \right). \quad (5.8)$$

Summarizing, if $\ell < L$ and $N = 1$, we have constructed functions $u_{TSB}^{(P/N)}$ with (see (5.4), (5.5) and (5.7) respectively (5.8))

$$J(u_{TSB}^{(P)}) \lesssim \theta^2 \left(\frac{(h - \theta)}{\ell} + \hat{\varepsilon} L + \mu \ln \frac{1}{h} \right), \quad (5.9)$$

and

$$J(u_{TSB}^{(N)}) \lesssim \theta^2 \left(\frac{(h - \theta)}{\ell} + \mu \ln \frac{1}{h} + \hat{\varepsilon} \ell + \frac{1}{\ell} \right). \quad (5.10)$$

As above, the term proportional to μ disappears for $h = 1$. We note for later reference that optimizing the upper bounds for the total energies (see (5.6), (5.9) and (5.10)) in h subject to the constraint $\theta \leq h \leq 1$ yields

$$h = \min\{1, \max\{\theta, \mu L N\}\}. \quad (5.11)$$

Remark 5.3 *In order to reuse this construction in the upper bound for the dislocations, we will need a slight modification of Step 1, similarly to constructions from [Sch94, CO05, Zwi14, CC15, KW14], i.e., we stop at some finite level $I \in \mathbb{N}$ such that the slopes of the interfaces remain bounded by a constant, i.e., $\eta_I/\ell_I \sim 1$, which is equivalent to*

$$\left(\frac{3}{2}\right)^I \sim \frac{N\ell}{\theta}. \quad (5.12)$$

We note that if such an $I \in \mathbb{N}$ exists, then

$$\varepsilon \int_{-\ell}^{3^{-(I+1)}\ell} |D\partial_2 u_{TSB}| \lesssim \varepsilon \int_{-\ell}^{3^{-(I+1)}\ell} |\partial_2 \partial_2 u_{TSB}| \lesssim \varepsilon \ell N. \quad (5.13)$$

We are now in the position to prove the upper bound of Theorem 2.1. We point out that $\ln^{1/2} \frac{1}{\theta} \sim \ln^{1/2} \frac{1}{\theta^2}$, and thus, we may replace $\ln^{1/2} \frac{1}{\theta}$ by $\ln^{1/2} \frac{1}{\theta^2}$ in the scaling law.

Proposition 5.4 *There are constants $c_N, c_P > 0$ such that for all $\varepsilon, \mu, L > 0$ and all $\theta \in (0, \frac{1}{2}]$, we have with $\hat{\varepsilon} := \varepsilon/\theta^2$,*

$$\min_{u \in \mathcal{A}_N} J(u) \leq c_N \theta^2 \min \left\{ \mu, \hat{\varepsilon}^{1/2}, \hat{\varepsilon}^{2/3} L^{1/3}, (\hat{\varepsilon} L \mu)^{1/2} \ln^{1/2} \left(\frac{1}{\theta^2} \right), (\hat{\varepsilon} L \mu)^{1/2} \ln^{1/2} \left(3 + \frac{\hat{\varepsilon}}{\mu^3 L} \right) \right\} \quad (5.14)$$

and

$$\min_{u \in \mathcal{A}_P} J(u) \leq c_P \theta^2 \max \left\{ \hat{\varepsilon} L, \min \left\{ \hat{\varepsilon}^{2/3} L^{1/3}, (\hat{\varepsilon} L \mu)^{1/2} \ln^{1/2} \left(\frac{1}{\theta^2} \right), (\hat{\varepsilon} L \mu)^{1/2} \ln^{1/2} \left(3 + \frac{\hat{\varepsilon}}{\mu^3 L} \right) \right\} \right\} \quad (5.15)$$

Proof: We prove (5.14) first. We use mostly variants of the two-scale-branching construction (TSB) and provide appropriate choices for the parameters ℓ, h and N in the various regimes.

- (i) The uniform function u_U is always admissible, and thus, $\min_{u \in \mathcal{A}_N} J(u) \leq c_1 \theta^2 \mu$.
- (ii) For any given parameters we obtain an admissible function as restriction to $(-L, \infty) \times (0, 1)$ of the TSB with $N = 1, h = 1$ and $\ell = \hat{\varepsilon}^{-1/2}$. This yields the truncated branching construction from [Zwi14, Theorem 1], which is sketched in Figure 7 (left). Thus (see also (5.10)), we have $\min_{u \in \mathcal{A}_N} J(u) \leq c_1 \theta^2 \hat{\varepsilon}^{1/2}$.
- (iii) In the regime in which the minimum in (5.14) is attained by $\hat{\varepsilon}^{2/3} L^{1/3}$, we in particular have $\hat{\varepsilon}^{2/3} L^{1/3} \leq \hat{\varepsilon}^{1/2}$. Thus, we may choose $N \sim (\hat{\varepsilon} L^2)^{-1/3}, h = 1$ and $\ell = L$ in TSB. This is the variant of the Kohn-Müller branching construction [KM94, Lemma 2.3] for unequal volume fractions as given in [Die10, Zwi14]. This yields a function u_B such that (see (5.6)) $J(u_B) \lesssim \theta^2 \hat{\varepsilon}^{2/3} L^{1/3}$. The deformation is sketched in Figure 5(b).
- (iv) If the minimum in (5.14) is attained by $(\hat{\varepsilon} L \mu)^{1/2} \ln^{1/2} \left(\frac{1}{\theta^2} \right)$, then in particular $(\hat{\varepsilon} L \mu)^{1/2} \ln^{1/2} \left(\frac{1}{\theta^2} \right) \leq \mu$, and hence, we may choose $N \sim \frac{\mu^{1/2} \ln^{1/2} \frac{1}{\theta^2}}{\hat{\varepsilon}^{1/2} L^{1/2}}, \ell = L$ and $h = \theta$. This yields the classical laminate construction u_{Lam} , for which $J(u_{Lam}) \lesssim \theta^2 (\hat{\varepsilon} L \mu)^{1/2} \ln^{1/2} \frac{1}{\theta^2}$, where we used that $\ln^{1/2} \frac{1}{\theta} \sim \ln^{1/2} \frac{1}{\theta^2}$. The function is sketched in Figure 5(a).

(v) Finally, in the regime in which the minimum in (5.14) is attained by $(\hat{\varepsilon}L\mu)^{1/2} \ln^{1/2} \left(3 + \frac{\hat{\varepsilon}}{\mu^3 L}\right)$, we use TSB with $N \sim \frac{\mu^{1/2} \ln^{1/2} \left(3 + \frac{\hat{\varepsilon}}{\mu^3 L}\right)}{\hat{\varepsilon}^{1/2} L^{1/2}}$, $\ell = L$ and $h = \frac{L^{1/2} \mu^{3/2} \ln^{1/2} \left(3 + \frac{\hat{\varepsilon}}{\mu^3 L}\right)}{\hat{\varepsilon}^{1/2}}$. Note that $h \sim N\mu L$ as motivated by (5.11). This choice is indeed admissible: First, $N \gtrsim 1$ follows from $(\hat{\varepsilon}L\mu)^{1/2} \ln^{1/2} \left(3 + \frac{\hat{\varepsilon}}{\mu^3 L}\right) \leq \mu$. Second, $\theta \leq h$ since $(\hat{\varepsilon}L\mu)^{1/2} \ln^{1/2} \left(3 + \frac{\hat{\varepsilon}}{\mu^3 L}\right) \leq (\hat{\varepsilon}L\mu)^{1/2} \ln^{1/2} \frac{1}{\theta^2}$ implies that $h \geq \frac{\mu^{3/2} L^{1/2}}{\hat{\varepsilon}^{1/2}} \geq \theta$. Finally, $h \leq 1$ since $(\hat{\varepsilon}L\mu)^{1/2} \ln^{1/2} \left(3 + \frac{\hat{\varepsilon}}{\mu^3 L}\right) \leq \hat{\varepsilon}^{2/3} L^{1/3}$ implies that $h \leq h \ln \left(3 + \frac{\hat{\varepsilon}}{\mu^3 L}\right) \leq 1$. Thus, we obtain a function u_{TSB} for which (see (5.6))

$$\begin{aligned} J(u_{TSB}) &\lesssim \theta^2 (\hat{\varepsilon}L\mu)^{1/2} \left(\ln^{-1/2} \left(3 + \frac{\hat{\varepsilon}}{\mu^3 L}\right) + \ln^{1/2} \left(3 + \frac{\hat{\varepsilon}}{\mu^3 L}\right) + \frac{\ln \left(\frac{\hat{\varepsilon}}{\mu^3 L \ln \left(3 + \frac{\hat{\varepsilon}}{\mu^3 L}\right)} \right)}{\ln^{1/2} \left(3 + \frac{\hat{\varepsilon}}{\mu^3 L}\right)} \right) \\ &\lesssim \theta^2 (\hat{\varepsilon}L\mu)^{1/2} \ln^{1/2} \left(3 + \frac{\hat{\varepsilon}}{\mu^3 L}\right). \end{aligned}$$

This function is sketched in Figure 5(c).

We proceed similarly to prove (5.15).

- (i) Suppose that the minimum in (5.15) is attained by $\hat{\varepsilon}^{2/3} L^{1/3}$. There are two possibilities. If $\hat{\varepsilon}^{2/3} L^{1/3} \geq \hat{\varepsilon}L$, then the branching construction u_B is admissible (see (iii) above). Otherwise, we have $\hat{\varepsilon}^{1/2} \leq \hat{\varepsilon}L$. Then we choose $N = 1$, $h = 1$ and $\ell = \hat{\varepsilon}^{-1/2}$ in TSB. This yields a periodic variant $u_{TB}^{(P)}$ of the truncated branching construction from [Zwi14, Theorem 1] with (see (5.9)) $J(u_{TB}^{(P)}) \lesssim \theta^2 (\hat{\varepsilon}^{1/2} + L\hat{\varepsilon}) \lesssim \theta^2 \hat{\varepsilon}L$. This function is sketched in Figure 7 (right).
- (ii) Suppose that the minimum in (5.15) is attained by $(\hat{\varepsilon}L\mu)^{1/2} \ln^{1/2} \left(\frac{1}{\theta^2}\right)$. Again, there are two possibilities: If $(\hat{\varepsilon}L\mu)^{1/2} \ln^{1/2} \left(\frac{1}{\theta^2}\right) \geq \hat{\varepsilon}L$, then the laminate construction u_{Lam} (see (iv) above) is admissible, for which $J(u_{Lam}) \lesssim (\hat{\varepsilon}L\mu)^{1/2} \ln^{1/2} \left(\frac{1}{\theta^2}\right)$. Otherwise, we use the single laminate u_{SL} (which corresponds to the choice $N = 1$, $h = \theta$ and $\ell = L$ in TSB), for which $J(u_{SL}) \lesssim \theta^2 (\hat{\varepsilon}L + \mu \ln \frac{1}{\theta^2}) \lesssim \theta^2 \hat{\varepsilon}L$.
- (iii) Finally, suppose that the minimum in (5.15) is attained by $(\hat{\varepsilon}L\mu)^{1/2} \ln^{1/2} \left(3 + \frac{\hat{\varepsilon}}{\mu^3 L}\right)$, and consider again the two possibilities separately. If $(\hat{\varepsilon}L\mu)^{1/2} \ln^{1/2} \left(3 + \frac{\hat{\varepsilon}}{\mu^3 L}\right) \geq \hat{\varepsilon}L$, we use TSB as in (v) above, i.e., with $N \sim \frac{\mu^{1/2} \ln^{1/2} \left(3 + \frac{\hat{\varepsilon}}{\mu^3 L}\right)}{\hat{\varepsilon}^{1/2} L^{1/2}}$, $\ell = L$ and $h = \frac{L^{1/2} \mu^{3/2} \ln^{1/2} \left(3 + \frac{\hat{\varepsilon}}{\mu^3 L}\right)}{\hat{\varepsilon}^{1/2}}$, which yields a function u_{TSB} with $J(u_{TSB}) \lesssim (\hat{\varepsilon}L\mu)^{1/2} \ln^{1/2} \left(3 + \frac{\hat{\varepsilon}}{\mu^3 L}\right)$. Note that admissibility of h follows verbatim as in the case of Neumann boundary conditions. Otherwise, we have $(\hat{\varepsilon}L\mu)^{1/2} \ln^{1/2} \left(3 + \frac{\hat{\varepsilon}}{\mu^3 L}\right) \leq \hat{\varepsilon}L$, and we use TSB with $N = 1$, $\ell = \frac{\mu \ln \left(3 + \frac{\hat{\varepsilon}}{\mu^3 L}\right)}{\hat{\varepsilon}}$ and h as before. Note that ℓ is chosen to make $N = 1$. In the regime under consideration, we indeed have $\ell \leq L$. Then by (5.9), this yields a function $u_{TSB}^{(P)}$ with $J(u_{TSB}^{(P)}) \lesssim \theta^2 \left((\hat{\varepsilon}L\mu)^{1/2} + \hat{\varepsilon}L + \mu \ln \frac{\hat{\varepsilon}}{\mu^3 L} \right) \lesssim \theta^2 \hat{\varepsilon}L$.

We remark that in the case \mathcal{A}_P all functions obey $u(x_1, 0) = 0$ for all x_1 . \square

5.2 Lower bound

We now turn to the proof of the lower bounds of Theorem 2.1. Our main new contribution is the proof in the case $\theta \ll 1$, in particular Step 2 of the proof of Lemma 5.5 below. We proceed in two steps.

Lemma 5.5 *There exist $m_0 \in (0, 1/2]$ and $c > 0$ with the following properties: For all $\mu, \varepsilon > 0$, $\theta \in (0, 1/2]$, $\lambda \in (0, 1]$, $\ell \in (0, L]$, $m \in (0, m_0]$ such that*

$$\text{at least one of } \quad \theta \leq m \leq m_0 \quad \text{or} \quad m_0 = m \leq \theta \quad (5.16)$$

holds, one has with $\hat{\varepsilon} = \varepsilon/\theta^2$

$$J(u) \geq c\theta^2 \min \left\{ \frac{\hat{\varepsilon}\ell}{\lambda}, \mu, \mu\lambda \ln \frac{1}{m}, \frac{\lambda^2 m}{\ell} \left(\ln \frac{1}{m} \right)^2 \right\} \quad \text{for all } u \in \mathcal{A}_N, \quad (5.17)$$

and

$$J(u) \geq c\theta^2 \min \left\{ \frac{\hat{\varepsilon}\ell}{\lambda}, \mu\lambda \ln \frac{1}{m}, \frac{\lambda^2 m}{\ell} \left(\ln \frac{1}{m} \right)^2 \right\} \quad \text{for all } u \in \mathcal{A}_P. \quad (5.18)$$

Proof: *Step 1. General setting and localization.* We start with the assertion (5.17). Let $\mu, \varepsilon, \theta, \lambda, \ell$ and m be given such that the assumptions of the lemma are satisfied (without m_0 which will be chosen at the end of the proof), and let $u \in \mathcal{A}_N$. For ease of notation we shall work for most of the proof with the function $v : (-L, \infty) \times (0, 1) \rightarrow \mathbb{R}$ given by $v(x_1, x_2) := -u(x_1, x_2) + \theta x_2$. Then $\partial_2 v \in \{0, 1\}$ almost everywhere in $(-L, 0) \times (0, 1)$ and

$$J(u) = \mu \int_{(0, \infty) \times (0, 1)} |Dv(x) - \theta e_2|^2 dx + \int_{-L}^0 \int_0^1 (\partial_1 v(x))^2 dx + \varepsilon |\partial_2 \partial_2 v| =: F(v). \quad (5.19)$$

For any $x_1^* \in (-\ell, 0)$ we estimate

$$\min_{\alpha \in \mathbb{R}} \|v(x_1^*, x_2) - \theta x_2 - \alpha\|_{L^1((0, 1))} \leq \|v(x_1^*, x_2) - v(0, x_2)\|_{L^1((0, 1))} + \min_{\alpha \in \mathbb{R}} \|v(0, x_2) - \theta x_2 - \alpha\|_{L^1((0, 1))}$$

(with the functions $v(x_1, \cdot)$ understood as traces). The first term is controlled by

$$\|v(x_1^*, \cdot) - v(0, \cdot)\|_{L^1((0, 1))} \leq \ell^{1/2} \left(\int_0^1 \int_{-\ell}^0 |\partial_1 v(x_1, x_2)|^2 dx \right)^{1/2} \leq \ell^{1/2} (F(v))^{1/2},$$

and the second one by

$$\begin{aligned} \min_{\alpha \in \mathbb{R}} \|v(0, x_2) - \theta x_2 - \alpha\|_{L^1((0, 1))} &\leq \min_{\alpha \in \mathbb{R}} \|v(0, x_2) - \theta x_2 - \alpha\|_{L^2((0, 1))} \\ &\leq c \|Dv - \theta e_2\|_{L^2((0, 1)^2)} \leq \frac{c}{\mu^{1/2}} (F(v))^{1/2}, \end{aligned}$$

where we used Hölder's inequality and the trace theorem. Therefore

$$\min_{\alpha \in \mathbb{R}} \|v(x_1^*, x_2) - \theta x_2 - \alpha\|_{L^1((0,1))} \leq \ell^{1/2}(F(v))^{1/2} + \frac{c}{\mu^{1/2}}(F(v))^{1/2}. \quad (5.20)$$

Choose $x_1^* \in [-\ell, 0]$ which minimizes $|\partial_2 \partial_2 v|(\{x_1\} \times (0, 1))$. Such a point x_1^* exists since $|\partial_2 \partial_2 v|(\{x_1\} \times (0, 1))$ is discrete (by [GM12, Section 4] we also know that we can assume without loss of generality that $x_1^* = -\ell$, this is however not needed here). Consider the central interval $I := (1/3, 2/3)$. Let $I_* := \{x_1^*\} \times I$ and $n := |\partial_2 \partial_2 v|(I_*)$. If $n\lambda \geq 1$ then

$$F(v) \geq \frac{\ell \varepsilon}{\lambda}, \quad (5.21)$$

and the assertion is proven. Otherwise, consider $\omega := \{x_2 \in I : \partial_2 v(x_1^*, x_2) = 1\}$. Note that ω consists of at most $1/\lambda$ intervals. We claim that we only need to treat the case $|\omega| \sim \theta$. Indeed, for every $\beta \in \mathbb{R}$,

$$c\theta \leq \min_{\alpha \in \mathbb{R}} \|\theta x_2 - \alpha\|_{L^1(I)} \leq \|v(x_1^*, x_2) - \theta x_2 - \beta\|_{L^1(I)} + \min_{\alpha \in \mathbb{R}} \|v(x_1^*, \cdot) - \alpha\|_{L^1(I)}.$$

Since $\partial_2 v \in \{0, 1\}$ almost everywhere, we have $\|v(x_1^*, \cdot) - \alpha\|_{L^\infty(I)} \leq \frac{1}{2}|\omega|$ for some $\alpha \in \mathbb{R}$. Recalling (5.20) we get

$$c\theta \leq \ell^{1/2}(F(v))^{1/2} + \frac{c}{\mu^{1/2}}(F(v))^{1/2} + |\omega|,$$

therefore either $|\omega| \gtrsim \theta$ or at least one of

$$F(v) \gtrsim \frac{\theta^2}{\ell} \quad \text{or} \quad F(v) \gtrsim \mu\theta^2 \quad (5.22)$$

must hold. If (5.22) holds, the assertion is established, since $\lambda^2 m \ln^2 \frac{1}{m} \leq 1$ for all $\lambda, m \in (0, 1)$. We thus can focus on the case $|\omega| \gtrsim \theta$ and observe that if $|\omega| \geq 2\theta$ then $v(x_1^*, x_2) \geq v(x_1^*, x'_2) + 2\theta$ for all $x_2 \in (2/3, 1)$ and all $x'_2 \in (0, 1/3)$, leading to (recall (5.20))

$$c\theta \leq \min_{\alpha \in \mathbb{R}} \|v(x_1^*, x_2) - \theta x_2 - \alpha\|_{L^1((0,1))} \leq \ell^{1/2}(F(v))^{1/2} + \frac{c}{\mu^{1/2}}(F(v))^{1/2}.$$

Again, either one of the possibilities in (5.22) holds and the assertion is proven, or $|\omega| < 2\theta$. In the rest we hence consider the case $c\theta \leq |\omega| \leq 2\theta$.

Step 2: Construction of the test function and proof of (5.17) for small $\theta \leq m \leq m_0$. The set $B_{\lambda m}(\omega)$, which is the λm -neighbourhood of ω , is the union of at most $n < 1/\lambda$ intervals $(y_i - g_i, y_i + g_i)$, where y_i are the midpoints of the connected components of ω . Then $\lambda m \leq g_i \leq \lambda m + \frac{|\omega|}{2} \leq \lambda m + \theta$ for every i , and $\sum_{i=1}^n 2g_i \leq |\omega| + 2n\lambda m \leq 2\theta + 2m \leq 4m$. We define

$$\psi(t) := \max_i \psi_i(t - y_i), \quad \psi_i(t) := \left[\ln \frac{1}{6m} - \left(\ln \frac{|t|}{g_i} \right)_+ \right]_+. \quad (5.23)$$

Then $\psi_i = \ln \frac{1}{6m}$ in $(-g_i, g_i)$, and $\psi_i = 0$ outside $(-g_i/(6m), g_i/(6m))$. Hence, since $g_i/(6m) \leq (\lambda m + \theta)/(6m) \leq 1/3$ and $y_i \in \omega \subset (1/3, 2/3)$, we deduce that $\text{supp } \psi \subset [0, 1]$. Note that $\|\psi_i\|_{L^1(\mathbb{R})} \leq c g_i/m$ and therefore

$$\|\psi\|_{L^1((0,1))} \leq \sum_{i=1}^n \|\psi_i\|_{L^1(\mathbb{R})} \leq \frac{c}{m} \sum_{i=1}^n g_i \leq c. \quad (5.24)$$

Further,

$$\|\psi'\|_{L^2((0,1))} \leq \left(\sum_{i=1}^n \int_0^1 |\psi'_i(t)|^2 dt \right)^{1/2} \leq c \left(\sum_{i=1}^n \frac{1}{g_i} \right)^{1/2} \leq c \left(\frac{n}{\lambda m} \right)^{1/2} \leq \frac{c}{m^{1/2} \lambda}. \quad (5.25)$$

We next estimate $[\psi]_{H_P^{1/2}((0,1))}$. For every $i = 1, \dots, n$ let Ψ_i be the radially symmetric extension of ψ_i to \mathbb{R}^2 . Then

$$\int_0^\infty \int_{-1/3}^{1/3} |D\Psi_i(x)|^2 dx \sim \int_{g_i}^{g_i/(6m)} r \frac{1}{r^2} dr \sim \ln \frac{1}{m},$$

and hence,

$$[\psi]_{H_P^{1/2}((0,1))}^2 \leq \sum_{i=1}^n \int_0^\infty \int_0^1 |D\Psi_i(x_1, x_2 - y_i)|^2 dx \lesssim n \ln \frac{1}{m} \leq \frac{1}{\lambda} \ln \frac{1}{m}. \quad (5.26)$$

Since $\partial_2 v(x_1^*, \cdot)\psi = \ln \frac{1}{6m}$ on ω , and $\partial_2 v(x_1^*, \cdot)\psi \geq 0$ everywhere, we have by (4.4) and with $u_R(x_2) := \theta x_2$,

$$\begin{aligned} |\omega| \ln \frac{1}{6m} &\leq \int_0^1 \partial_2 v(x_1^*, x_2)\psi(x_2) dx_2 \\ &= - \int_0^1 (v(x_1^*, x_2) - v_0(x_2))\psi'(x_2) dx_2 - \int_0^1 (v_0(x_2) - \theta x_2)\psi'(x_2) dx_2 + \int_0^1 \theta\psi(x_2) dx_2 \\ &\leq \int_{x_1^*}^0 \int_0^1 \partial_1 v(x_1, x_2)\psi'(x_2) dx + c[v_0 - u_R]_{H_N^{1/2}((0,1))}[\psi]_{H_P^{1/2}((0,1))} + \theta\|\psi\|_{L^1((0,1))} \\ &\leq \frac{c}{m^{1/2}\lambda} |x_1^*|^{1/2} F^{1/2}(v) + \frac{cF^{1/2}(v)}{(\lambda\mu)^{1/2}} \ln^{1/2} \frac{1}{m} + c\theta, \end{aligned} \quad (5.27)$$

where in the last step we used (5.24), (5.25) and (5.26). Since $|\omega| \gtrsim \theta$, there is $m_0 \in (0, 1/2]$ such that for $m \leq m_0$ the last term of the right-hand side can be absorbed in the left-hand side and $\ln \frac{1}{6m} \gtrsim \ln \frac{1}{m}$ (this defines m_0). We deduce that

$$(F(v))^{1/2} \geq c\theta \min \left\{ \frac{\lambda m^{1/2}}{\ell^{1/2}} \ln \frac{1}{m}, \lambda^{1/2} \mu^{1/2} (\ln \frac{1}{m})^{1/2} \right\}, \quad (5.28)$$

which, combined with (5.21) and (5.22), concludes the proof of (5.17) if the first option in (5.16) holds.

Step 3: Construction of the test function and proof of (5.17) for large $\theta \geq m_0 = m$. Note that if the second option in (5.16) holds then $m \sim \theta \sim 1$. In this case, the argument from [Con06] can be applied to obtain the lower bound but we present here an alternative proof in the spirit of *Step 2*. At variance with what was done in *Step 2*, in this case the test function is supported inside ω . The set ω is the union of $n \leq 1/\lambda$ intervals, $(y_i - g_i, y_i + g_i)$, and $|\omega| = \sum_i 2g_i \sim 1$. Note that the points y_i are as in *Step 2* chosen to be the midpoints of the connected components of ω , but the radii g_i are different. We set

$$\psi(t) := \max_i (g_i - |t - y_i|)_+ = \begin{cases} \text{dist}(t, \partial\omega) & \text{if } t \in \omega, \\ 0 & \text{otherwise.} \end{cases}$$

We compute

$$\int_0^1 \psi(t) dt = \sum_{i=1}^n 2 \int_0^{g_i} s ds = \sum_{i=1}^n g_i^2 \geq \frac{1}{n} \left(\sum_{i=1}^n g_i \right)^2 \gtrsim \lambda$$

and

$$\int_0^1 |\psi'(t)|^2 dt = \sum_{i=1}^n 2g_i = |\omega| \leq 1.$$

Extending ψ to $(0, \infty) \times (0, 1)$ by $\Psi(x) := \max_i (g_i - |x - (0, y_i)|)_+$, we obtain

$$[\psi]_{H_P^{1/2}((0,1))}^2 \leq \int_{(0,\infty) \times (0,1)} |D\Psi(x)|^2 dx = \sum_{i=1}^n \frac{1}{2} |B(0, g_i)| = \frac{\pi}{2} \sum_{i=1}^n g_i^2.$$

As in (5.27), we use ψ to test $\partial_2 v$, integrate by parts and use (4.4),

$$\begin{aligned} \sum_{i=1}^n g_i^2 &= \int_0^1 \psi(x_2) dx_2 = \int_0^1 \partial_2 v(x_1^*, x_2) \psi(x_2) dx_2 \\ &= - \int_0^1 (v(x_1^*, x_2) - v_0(x_2)) \psi'(x_2) dx_2 - \int_0^1 (v_0(x_2) - \theta x_2) \psi'(x_2) dx_2 + \int_0^1 \theta \psi(x_2) dx_2 \\ &\leq \int_{x_1^*}^0 \int_0^1 \partial_1 v(x_1, x_2) \psi'(x_2) dx + c[v_0 - u_R]_{H_N^{1/2}((0,1))} [\psi]_{H_P^{1/2}((0,1))} + \theta \sum_{i=1}^n g_i^2. \end{aligned}$$

Since $\theta \leq 1/2$,

$$\sum_{i=1}^n g_i^2 \leq c|x_1^*|^{1/2} F^{1/2}(v) + \frac{cF^{1/2}(v)}{\mu^{1/2}} \left(\sum_{i=1}^n g_i^2 \right)^{1/2}.$$

Therefore at least one of

$$F(v) \gtrsim \frac{1}{\ell} \left(\sum_{i=1}^n g_i^2 \right)^2 \gtrsim \frac{\lambda^2}{\ell} \quad \text{and} \quad F(v) \gtrsim \mu \sum_{i=1}^n g_i^2 \gtrsim \mu \lambda$$

must hold and the proof of (5.17) is concluded.

Step 4: Proof of (5.18) Let $u \in \mathcal{A}_P$ and choose v and x_1^* as in *Step 1*. By the periodicity assumption, we have $|\{x_2 \in (0, 1) : \partial v(x_1^*, x_2) = 1\}| = \theta$. Hence, possibly choosing a different cell of periodicity, we may assume that $\theta/3 \leq |\omega| \leq \theta$, where ω is defined as in *Step 1*, i.e., $\omega := \{x_2 \in (1/3, 2/3) : \partial_2 v(x_1^*, x_2) = 1\}$. The rest of the proof is the same as for \mathcal{A}_N . We remark that deriving the condition $|\omega| \sim \theta$ directly from the periodicity allowed us to avoid using (5.22), and therefore the option $F(v) \gtrsim \mu \theta^2$ does not appear in the conclusion. \square

We now conclude the proof of the lower bounds of Theorem 2.1.

Proposition 5.6 *There is a constant $c > 0$ such that for all $\mu, \varepsilon, L > 0$ and all $\theta \in (0, 1/2]$, we have with $\hat{\varepsilon} = \varepsilon/\theta^2$,*

$$\min_{u \in \mathcal{A}_N} J(u) \geq c\theta^2 \min \left\{ \hat{\varepsilon}^{2/3} L^{1/3}, (\hat{\varepsilon}\mu L)^{1/2} \ln^{1/2} \left(3 + \frac{\hat{\varepsilon}}{\mu^3 L} \right), (\hat{\varepsilon}\mu L)^{1/2} \ln^{1/2} \frac{1}{\theta}, \mu, \hat{\varepsilon}^{1/2} \right\}, \quad (5.29)$$

and

$$\min_{u \in \mathcal{A}_P} J(u) \geq c\theta^2 \max \left\{ \hat{\varepsilon} L, \min \left\{ \hat{\varepsilon}^{2/3} L^{1/3}, (\hat{\varepsilon} L \mu)^{1/2} \ln^{1/2} \left(3 + \frac{\hat{\varepsilon}}{\mu^3 L} \right), (\hat{\varepsilon} L \mu)^{1/2} \ln^{1/2} \frac{1}{\theta} \right\} \right\}. \quad (5.30)$$

Proof: To prove (5.29), we use (5.17) with appropriate choices for the parameters λ, m and ℓ . We start fixing $u \in \mathcal{A}_N$, and distinguish several cases.

- (i) If $\hat{\varepsilon} \leq \min\{1/L^2, \mu^3 L\}$, we choose $m := m_0, \lambda := \hat{\varepsilon}^{1/3} L^{2/3}$, and $\ell := L$. Then (5.16) holds for all θ , and by (5.17) we obtain $J(u) \gtrsim \theta^2 \min\{\hat{\varepsilon}^{2/3} L^{1/3}, \mu\}$.
- (ii) If $1/L^2 \leq \hat{\varepsilon} \leq \mu^3 L$, we choose $m := m_0, \lambda := 1$ and $\ell := \hat{\varepsilon}^{-1/2}$. As above, (5.17) implies $J(u) \gtrsim \theta^2 \min\{\mu, \hat{\varepsilon}^{1/2}\}$.
- (iii) It remains to consider $\hat{\varepsilon} > \mu^3 L$. We set

$$m := \max \left\{ \min\{m_0, \theta\}, \frac{\mu^{3/2} L^{1/2}}{\hat{\varepsilon}^{1/2}} m_0 \right\}. \quad (5.31)$$

If $\theta \geq m_0$ this gives $m = m_0$; if $\theta \leq m_0$ instead $\theta \leq m \leq m_0$. Therefore we can use (5.17). Note that $\ln \frac{1}{m} \geq \min\{\ln \frac{1}{\theta}, \ln \frac{\hat{\varepsilon}^{1/2} m_0}{\mu^{3/2} L^{1/2}}\} \gtrsim \min\{\ln \frac{1}{\theta^2}, \ln(3 + \frac{\hat{\varepsilon}}{\mu^3 L})\}$. We distinguish two subcases:

- (a) If $\hat{\varepsilon} \leq \frac{\mu}{L} \ln \frac{1}{m}$, we choose $\ell := L$ and $\lambda := \left(\frac{\hat{\varepsilon} L}{\mu \ln \frac{1}{m}} \right)^{1/2}$. Then (since $m \gtrsim \frac{\mu^{3/2} L^{1/2}}{\hat{\varepsilon}^{1/2}}$ and $\ln \frac{1}{m} \gtrsim 1$), we have $J(u) \gtrsim \theta^2 \min\{(\hat{\varepsilon} L \mu)^{1/2} \ln^{1/2} \frac{1}{m}, \mu\}$.
- (b) If $\hat{\varepsilon} > \frac{\mu}{L} \ln \frac{1}{m}$, we choose $\lambda := 1$ and $\ell := \frac{\mu^{3/4} L^{1/4}}{\hat{\varepsilon}^{3/4}}$. Then $J(u) \gtrsim \mu \theta^2$.

We finally prove (5.30) using (5.18). We fix $u \in \mathcal{A}_P$. By the periodicity assumption we have $J(u) \gtrsim \theta^2 \hat{\varepsilon} L$. As above, we distinguish several cases.

- (i) If $\hat{\varepsilon} \leq \min\{1/L^2, \mu^3 L\}$ we choose $m := m_0, \lambda := \hat{\varepsilon}^{1/3} L^{2/3}$, and $\ell := L$ as in (i) above and obtain $J(u) \gtrsim \theta^2 \hat{\varepsilon}^{2/3} L^{1/3}$.
- (ii) If $\hat{\varepsilon} \geq L^{-2}$ then $J(u) \gtrsim \theta^2 \hat{\varepsilon} L \gtrsim \theta^2 (\hat{\varepsilon} L + \hat{\varepsilon}^{2/3} L^{1/3})$ and the assertion is proven.
- (iii) It remains to consider $\hat{\varepsilon} > \mu^3 L$. We define m as in (5.31) and distinguish the same two subcases as above.
 - (a) If $\hat{\varepsilon} \leq \frac{\mu}{L} \ln \frac{1}{m}$, we choose the same parameters as in (iii)(a) above and obtain $J(u) \gtrsim \theta^2 (\hat{\varepsilon} L \mu)^{1/2} \ln^{1/2} \frac{1}{m}$.
 - (b) If $\hat{\varepsilon} > \frac{\mu}{L} \ln \frac{1}{m}$, then as in (ii) we obtain $J(u) \gtrsim \theta^2 \hat{\varepsilon} L \gtrsim \theta^2 (\hat{\varepsilon} \mu L)^{1/2} \ln^{1/2} \frac{1}{m}$.

□

6 Proof of the scaling law for plastic microstructures

We now turn to the model for plastic microstructures described in Section 3, and aim to prove Theorem 3.1. We note that it suffices to prove Theorem 3.1 for $L = 1$. The result for general cubes $\Omega := (0, L)^3$ then follows by rescaling $\tilde{u}(x) := \frac{1}{L}u(Lx)$ and $\tilde{\beta}(x) := \beta(Lx)$ (see [CO05, Section 4]).

6.1 Upper bound

We start with the upper bound.

Proposition 6.1 *There is a constant $c > 0$ such that for all $\theta \in (0, \frac{1}{2}]$, and all $\mu, \varepsilon > 0$, we have*

$$\inf E(u, \beta) \leq c\theta^2 \min \left\{ \hat{\varepsilon}^{2/3}, (\hat{\varepsilon}\mu)^{1/2} \ln^{1/2} \left(3 + \frac{\hat{\varepsilon}}{\mu^3} \right), (\hat{\varepsilon}\mu)^{1/2} \ln^{1/2} \left(\frac{1}{\theta^2} \right), \mu, 1 \right\}. \quad (6.1)$$

Proof: Following [CO05, Section 4.1], test functions for the Kohn-Müller model with appropriate modifications can be used to construct test functions for the energy given in (3.2). We treat the regimes $\mu\theta^2$ and θ^2 separately, and afterwards outline the general construction and then consider the various regimes. Set

$$f(\varepsilon, \mu, \theta) := \theta^2 \min \left\{ \hat{\varepsilon}^{2/3}, (\hat{\varepsilon}\mu)^{1/2} \ln^{1/2} \left(3 + \frac{\hat{\varepsilon}}{\mu^3} \right), (\hat{\varepsilon}\mu)^{1/2} \ln^{1/2} \left(\frac{1}{\theta^2} \right), \mu, 1 \right\}.$$

Step 0: The regimes $\mu\theta^2$ and θ^2 . Choosing $u(x) := (1-\theta)x_\xi + \theta x_\eta \min\{1, \text{dist}(x, \Omega)\}$ and $\beta := (1-\theta)e_\xi$, we find that $\inf E(u, \beta) \lesssim \mu\theta^2$. Choosing $u := u_0$ and $\beta := e_\xi$ we get $\inf E(u, \beta) \leq 2\theta^2$.

Step 1: The general setting. Suppose that there are $T \leq 0$ and a function $v_{\text{KM}} : (-1, \infty) \times (0, 1) \rightarrow \mathbb{R}$ such that

$$\partial_2 v_{\text{KM}}(x) \in \{0, 1\} \quad \text{for } x_1 \leq T, \quad v_{\text{KM}}(x_1, 0) = 0, \quad v_{\text{KM}}(x_1, 1) = \theta \quad \text{for all } x_1 \in (-1, \infty), \quad (6.2)$$

and

$$\begin{aligned} & \int_{(-1, T) \times (0, 1)} (|\partial_1 v_{\text{KM}}(x)|^2 dx + \varepsilon |D\partial_2 v_{\text{KM}}|) \\ & + \int_{(T, 0) \times (0, 1)} |Dv_{\text{KM}}(x)|^2 dx + \int_{(0, \infty) \times (0, 1)} |Dv_{\text{KM}}(x) - \theta e_2|^2 dx \leq cf(\varepsilon, \theta, \mu). \end{aligned} \quad (6.3)$$

We use the signed distance

$$d(x) := \begin{cases} -\text{dist}((x_1, x_3), \partial(0, 1)^2) & \text{if } (x_1, x_3) \in (0, 1)^2, \\ \text{dist}((x_1, x_3), (0, 1)^2) & \text{if } (x_1, x_3) \notin (0, 1)^2 \end{cases} \quad (6.4)$$

to define

$$u(x) := \begin{cases} x_\xi - \sqrt{2}v_{\text{KM}}(d(x), x_2) & \text{if } x_2 \in (0, 1), \\ u_0(x) & \text{if } x_2 \notin (0, 1) \end{cases} \quad (6.5)$$

and

$$\beta(x) := e_\xi - (\sqrt{2}\partial_2 v_{\text{KM}}(d(x), x_2))\chi_{\{d(x) \leq T\}}e_2. \quad (6.6)$$

We collect some properties of these functions: Since $u_0(x) = x_\xi - \sqrt{2}\theta x_2$, the function u is continuous at $x_2 \in \{0, 1\}$. For the rest we only need to consider the stripe $x_2 \in (0, 1)$. Further, $\beta \in \{e_\xi, e_\eta\}$,

$$|Du - \beta|(x) = \begin{cases} \sqrt{2}|\partial_1 v_{\text{KM}}(d(x), x_2)| & \text{if } d(x) \leq T, \\ \sqrt{2}|Dv_{\text{KM}}(d(x), x_2)| & \text{if } T \leq d(x) \leq 0, \end{cases}$$

$|Du - Du_0| = \sqrt{2}|Dv_{\text{KM}}(d(x), x_2) - \theta e_2|$ outside Ω . Finally, $|D\beta| \leq \sqrt{2}|D\partial_2 v_{\text{KM}}|(d(x), x_2)$ on $\{d(x) < T\}$, $|D\beta| = 0$ on $\{d(x) > T\}$, and $|D\beta|(\{d(x) = T\}) \lesssim \theta$. Therefore, by (6.3) (for the ease of notation we suppress the constraint $x_2 \in (0, 1)$ in all domains of integration)

$$\begin{aligned} E(u, \beta) &\lesssim \int_{\{d(x) \leq T\}} |\partial_1 v_{\text{KM}}(d(x), x_2)|^2 dx + \int_{\{T \leq d(x) \leq 0\}} |Dv_{\text{KM}}(d(x), x_2)|^2 dx + \\ &+ \int_{\{d(x) \leq T\}} \varepsilon |D\partial_2 v_{\text{KM}}(d(x), x_2)| + \mu \int_{\{d(x) > 0\}} |Dv_{\text{KM}} - \theta e_2|^2 dx + \theta^3 \hat{\varepsilon} \lesssim f(\varepsilon, \theta, \mu) + \theta^3 \hat{\varepsilon}. \end{aligned}$$

Step 2: Construction of v_{KM} . It remains to find v_{KM} and T such that (6.2) and (6.3) hold. We consider the various regimes separately and provide functions v_{KM} and parameters $T \leq 0$ that satisfy (6.2) and (6.3). For that, we build on the functions from Section 5 and in particular the proof of Proposition 5.4 with $L = \ell = 1$. In each case it is easy to see that the $\theta^3 \hat{\varepsilon}$ term is irrelevant.

- (i) If $f(\varepsilon, \theta, \mu) = \theta^2 (\hat{\varepsilon}\mu)^{1/2} \ln^{1/2}(\frac{1}{\theta^2})$ we choose $v_{\text{KM}}(x) := -u_{\text{Lam}}(x) + \theta x_2$ and $T := 0$.
- (ii) If $f(\varepsilon, \theta, \mu) = \theta^2 \hat{\varepsilon}^{2/3}$, we use a modification of the classical branching construction u_B , which is a variant of the branching construction given in [CO05, Section 4.1] with unequal volume fractions and corresponds to the finite branching construction given in [Zwi14, Pf. of Theorem 2]. We use the notation of Section 5 and set $\ell := 1$, $N \sim \hat{\varepsilon}^{-1/3}$, $h := 1$ and $T := -3^{-I}$ with I given in Remark 5.3. Note that for $\ell = 1$, we always find an admissible $I \in \mathbb{N}$ since $N \geq 1$ and $\theta \leq 1/2$. We define v_{KM} via

$$v_{\text{KM}}(x) := \begin{cases} -u_B(x) + \theta x_2 & \text{if } x_1 \leq T, \\ \theta x_2 - \frac{x_1}{T} u_B(T, x_2) & \text{if } T \leq x_1 \leq 0, \\ \theta x_2 & \text{if } x_1 \geq 0. \end{cases}$$

By the computations of Section 5, in particular (5.13), it remains to show

$$\int_{(T,0) \times (0,1)} |Dv_{\text{KM}}|^2 dx = \int_{(T,0) \times (0,1)} \left| \frac{u_B(T, x_2)}{T} \right|^2 + \left| \theta - \frac{x_1}{T} \partial_2 u_B(T, x_2) \right|^2 dx \lesssim \theta^2 \hat{\varepsilon}^{2/3}.$$

First, since $|u_B(T, x_2)| \lesssim \theta/(2^I N)$, we have

$$\int_{(T,0) \times (0,1)} \left| \frac{u_B(T, x_2)}{T} \right|^2 \lesssim |T| \left(\frac{\theta}{2^I N T} \right)^2 dx \leq \frac{\theta^2}{N^2} \sim \theta^2 \hat{\varepsilon}^{2/3}.$$

Second, since $|\partial_2 u_B(T, x_2)| \leq 1 - \theta$,

$$\int_{(T,0) \times (0,1)} \left| \theta - \frac{x_1}{T} \partial_2 u_B(T, x_2) \right|^2 dx \leq |T| = 3^{-I} \leq \left(\frac{2}{3} \right)^{2I} \sim \theta^2 \hat{\varepsilon}^{2/3},$$

using $1/3 \leq 4/9$ and (5.12).

(iii) Consider now the regime in which $f(\varepsilon, \theta, \mu) = (\hat{\varepsilon}\mu)^{1/2} \ln^{1/2} \left(3 + \frac{\hat{\varepsilon}}{\mu^3} \right)$. Set $\ell = 1$, $N \sim \left(\frac{\mu \ln(3 + \frac{\hat{\varepsilon}}{\mu^3})}{\hat{\varepsilon}} \right)^{1/2}$ and $h \sim N\mu$. Admissibility of these choices follows as in the case of Neumann boundary conditions in the proof of Proposition 5.4. Choose $I \in \mathbb{N}$ such that (5.12) holds and set $T := 3^{-I}$. We define

$$v_{KM}(x) := \begin{cases} -u_{TSB}(x) + \theta x_2 & \text{if } x_1 \notin (T, 0), \\ -\frac{x_1}{T} u_{TSB}(T, x_2) - (1 - \frac{x_1}{T}) u_{TSB}(0, x_2) + \theta x_2 & \text{if } x_1 \in (T, 0). \end{cases}$$

Again, in view of Section 5, it suffices to consider $\int_{(T,0) \times (0,1)} |Dv_{KM}|^2 dx$. Using that $|\{x_2 \in (0, 1) : u_{TSB}(T, x_2) \neq u_{TSB}(0, x_2)\}| \leq h$ and $|\partial_2 u_{TSB}| \leq 1$, we have

$$\begin{aligned} & \int_{(T,0) \times (0,1)} |Dv_{KM}|^2 dx = \\ &= \int_{(T,0) \times (0,1)} \left\{ \left| \frac{u_{TSB}(T, x_2) - u_{TSB}(0, x_2)}{T} \right|^2 + \left| \theta - \frac{x_1}{T} \partial_2 u_{TSB}(T, x_2) - (1 - \frac{x_1}{T}) \partial_2 u_{TSB}(0, x_2) \right|^2 \right\} dx \\ &\leq \frac{|T|h}{T^2} \left(\frac{\theta}{2IN} \right)^2 + |T|h \leq \left(\frac{3}{4} \right)^I \mu \frac{\theta^2}{N} + N\mu 3^{-I} \leq \mu \frac{\theta^2}{N} + \left(\frac{2}{3} \right)^{2I} N\mu \leq 2\mu \frac{\theta^2}{N} \lesssim (\mu\hat{\varepsilon})^{1/2} \theta^2, \end{aligned}$$

where we again used that $1/3 \leq 4/9$ and (5.12). □

6.2 Lower bound

We split the proof of the lower bound in several lemmas. We start with the local structure of β .

Lemma 6.2 *Let $a, b > 0$, $0 < \theta \leq 1/2$, and $N \in \mathbb{N}$, and set $R := (0, a)e_\xi \times (0, b)e_\eta$. Suppose that $v, w \in L^1(R)$ with $vw = 0$ almost everywhere. Assume further that*

$$\int_R v(x) dx \geq \frac{1}{4} \theta |R|, \quad (6.7)$$

and also

$$\int_R |\partial_\xi v| \leq \frac{1}{16} \theta b, \quad \text{and} \quad \int_R |\partial_\eta w| \leq aN. \quad (6.8)$$

Then there are $8N$ pairwise disjoint, possibly degenerate intervals $I_1, \dots, I_{8N} \subset (0, b)$ such that

$$\sum_{i=1}^{8N} \int_0^a \int_{I_i} v(se_\xi + te_\eta) ds dt \geq \frac{1}{16} \theta |R|, \quad \text{and} \quad \sum_{i=1}^{8N} \int_0^a \int_{I_i} w(se_\xi + te_\eta) ds dt \leq \frac{a}{4} \sum_{i=1}^{8N} |I_i|. \quad (6.9)$$

Proof: For ease of notation we change coordinates for the proof, and assume $e_\xi = e_1$, $e_\eta = e_2$. By (6.7) and Fubini, there exists $x_\xi^* \in (0, a)$ such that

$$\int_0^b v(x_\xi^*, x_\eta) dx_\eta \geq \frac{1}{4}\theta b. \quad (6.10)$$

Define $M := \{x_\eta \in (0, b) : v(x_\xi^*, x_\eta) > 2 \int_{(0,a) \times \{x_\eta\}} |\partial_\xi v|\}$. Then by (6.8)

$$\int_{(0,b) \setminus M} v(x_\xi^*, x_\eta) dx_\eta \leq 2 \int_R |\partial_\xi v| \leq \frac{1}{8}\theta b,$$

and therefore by (6.10)

$$\int_M v(x_\xi^*, x_\eta) dx_\eta \geq \frac{1}{8}\theta b. \quad (6.11)$$

Further, for $x_\eta \in M$ one has

$$v(x_\xi, x_\eta) \geq v(x_\xi^*, x_\eta) - \int_{(0,a) \times \{x_\eta\}} |\partial_\xi v| \geq \frac{1}{2}v(x_\xi^*, x_\eta) > 0 \quad \text{for almost every } x_\xi, \quad (6.12)$$

and therefore by (6.11)

$$\int_{(0,a) \times M} v(x_\xi, x_\eta) dx \geq \frac{1}{2}a \int_M v(x_\xi^*, x_\eta) dx_\eta \geq \frac{1}{16}\theta ab.$$

Set $\bar{w}(x_\eta) := \int_0^a w(x_\xi, x_\eta) dx_\xi$. Then by the assumption $wv = 0$ and (6.12), we have $\bar{w} = 0$ in M , and by (6.8)

$$\int_0^b |\bar{w}'| \leq aN.$$

By the coarea formula, $\int_{a/8}^{a/4} \mathcal{H}^0(\partial\{\bar{w} \leq t\}) dt \leq aN$, and therefore there is $t \in (a/8, a/4)$ such that the set $\{\bar{w} < t\}$ is the union of at most $8N$ intervals I_1, \dots, I_{8N} . For these intervals (6.9) holds since they cover M and $\bar{w} \leq a/4$ on all I_i . \square

For $R \subset (0, 1)^2$ and $(u, \beta) \in \mathcal{A}$, we set

$$E_R(u, \beta) := \int_{R \times (0,1)} [|Du(x) - \beta(x)|^2 dx + \varepsilon |\partial_\xi \beta_\eta| + \varepsilon |\partial_\eta \beta_\xi|] + \mu \int_{R \times [(-\infty, 0) \cup (1, \infty)]} |Du(x) - Du_0(x)|^2 dx.$$

We fix a function $\varphi_1 \in C_c^1((0, 1); [0, 1])$ such that $\varphi_1 \equiv 1$ on $(\frac{1}{16}, \frac{15}{16})$ and $\varphi_1(1-t) = \varphi_1(t)$. For $a > 0$ and $x \in (0, 1)$ set $\varphi_{x,a}(t) := \varphi_1((t-x)/a)$.

Lemma 6.3 *There exists a constant $c > 0$ with the following property: For every $(u, \beta) \in \mathcal{A}$, and every $a, b, x_a, x_b \in (0, 1)$ for which $R := (x_a, x_a + a)e_\xi \times (x_b, x_b + b)e_\eta \subset (0, 1)^2$ there exists $\ell \in (0, 1)$ such that for all $f \in L^2((x_b, x_b + b))$ and all $g \in L^2((x_a, x_a + a))$, setting $R_\ell = R \times \{\ell\}$,*

$$\left| \int_{R_\ell} (\beta_\xi(x) - (1-\theta))f(x_\eta)\varphi_{x_a,a}(x_\xi) dx \right| \leq cE_R^{1/2}(u, \beta) \|f\|_{L^2((x_b, x_b + b))} \left[\frac{1}{\mu^{1/2}} + \frac{1}{a^{1/2}} \right] \quad (6.13)$$

and

$$\left| \int_{R_\ell} (\beta_\eta(x) - \theta)g(x_\xi)\varphi_{x_b,b}(x_\eta) dx \right| \leq cE_R^{1/2}(u, \beta)\|g\|_{L^2((x_a, x_a+a))} \left[\frac{1}{\mu^{1/2}} + \frac{1}{b^{1/2}} \right]. \quad (6.14)$$

Proof: Let $(u, \beta) \in \mathcal{A}$. Choose $\ell \in (0, 1)$ such that $E_{R,\ell} \leq E_R$, where

$$E_{R,\ell}(u, \beta) := \int_{R \times \{\ell\}} [|Du(x) - \beta(x)|^2 dx + \varepsilon|\partial_\xi\beta_\eta| + \varepsilon|\partial_\eta\beta_\xi|].$$

Since $\partial_\xi u_0 = 1 - \theta$, we have, integrating by parts,

$$\begin{aligned} & \int_{R_\ell} (\beta_\xi(x) - (1 - \theta))\varphi_{x_a,a}(x_\xi)f(x_\eta) dx \\ &= \int_{R_\ell} (\partial_\xi u(x) - \partial_\xi u_0(x))\varphi_{x_a,a}(x_\xi)f(x_\eta) dx + \int_{R_\ell} (\beta_\xi(x) - \partial_\xi u(x))\varphi_{x_a,a}(x_\xi)f(x_\eta) dx \\ &= - \int_{R_\ell} (u(x) - u_0(x))\partial_\xi\varphi_{x_a,a}(x_\xi)f(x_\eta) dx + \int_{R_\ell} (\beta_\xi(x) - \partial_\xi u(x))\varphi_{x_a,a}(x_\xi)f(x_\eta) dx \\ &= - \int_{R_0} (u(x) - u_0(x))\partial_\xi\varphi_{x_a,a}(x_\xi)f(x_\eta) dx - \int_{R \times (0,\ell)} (\partial_3 u(x))(\partial_\xi\varphi_{x_a,a}(x_\xi))f(x_\eta) dx \\ & \quad + \int_{R_\ell} (\beta_\xi(x) - \partial_\xi u(x))\varphi_{x_a,a}(x_\xi)f(x_\eta) dx \\ &\leq - \int_{R_0} (u(x) - u_0(x))\partial_\xi\varphi_{x_a,a}(x_\xi)f(x_\eta) dx + (E_R)^{1/2}\|\partial_\xi\varphi_{x_a,a}f\|_{L^2(R)} + E_R^{1/2}\|\varphi_{x_a,a}f\|_{L^2(R)}. \end{aligned}$$

By definition of $\varphi_{x_a,a}$, we have the estimates $\|\varphi'_{x_a,a}f\|_{L^2(R)} \leq ca^{-1/2}\|f\|_{L^2((x_b, x_b+b))}$ and $\|\varphi_{x_a,a}f\|_{L^2(R)} \leq ca^{1/2}\|f\|_{L^2((x_b, x_b+b))}$. It remains to estimate the first term of the right-hand side. Since $|\partial_\xi\varphi_{x_a,a}| \leq c/a$, and since by symmetry of $\varphi_{x_a,a}$ we have $\partial_\xi\varphi_{x_a,a}(x_\xi) = -\partial_\xi\varphi_{x_a,a}(2x_a + a - x_\xi)$ for all $x_\xi \in (x_a, x_a + a)$, we obtain (writing for brevity (x_ξ, x_η) instead of $x_\xi e_\xi + x_\eta e_\eta$)

$$\begin{aligned} \int_{R_0} f(x_\eta)\partial_\xi\varphi_{x_a,a}(x_\xi)(u - u_0)(x_\xi, x_\eta) dx &\leq \int_{R_0} |f|\frac{c}{a} |(u - u_0)(x_\xi, x_\eta) - (u - u_0)(2x_a + a - x_\xi, x_\eta)| dx \\ &\leq \frac{c}{a} \int_{R_0} |f| \int_{\{y: |y_3| + |y_\xi - x_a - a/2| = |x_\xi - x_a - a/2|, y_\eta = x_\eta, y_3 \leq 0\}} |D(u - u_0)(y)| d\mathcal{H}^1(y) dx \\ &\leq \frac{c}{a} \|f\|_{L^2(R \times (-a, 0))} \|D(u - u_0)\|_{L^2(R \times (-a, 0))}, \end{aligned}$$

which implies that (recall that f depends only on x_η)

$$\int_{R_0} f(x_\eta)\partial_\xi\varphi_{x_a,a}(x_\xi)(u - u_0)(x_\xi, x_\eta) dx \leq \frac{c}{\mu^{1/2}} \|f\|_{L^2((x_b, x_b+b))} E_R^{1/2}. \quad (6.15)$$

Putting things together and using that $a < 1$, we obtain the first assertion (6.13). The second one follows similarly by performing the same computation in the other direction and using that $\partial_\eta u_0 = \theta$.

□

Corollary 6.4 *Under the assumptions of Lemma 6.3, if $E_R(u, \beta) \leq c|R|E(u, \beta)$, then at least one of*

$$E(u, \beta) \gtrsim \theta^2 \min \{b\mu, b^2\} \quad (6.16)$$

and

$$\int_{R_\ell} \beta_\eta(x) \varphi_{x_b, b}(x_\eta) dx \geq \frac{1}{4} \theta |R| \quad (6.17)$$

holds.

Proof: Set $g := 1$. Then $\|g\|_{L^2((x_a, x_a+a))} = a^{1/2}$ and $\int_{R_\ell} g(x_\xi) \varphi_{x_b, b}(x_\xi) dx > \frac{7}{8} ab$. Thus we have $\int_{R_\ell} \beta_\eta(x) \varphi_{x_b, b}(x_\eta) dx \geq \frac{1}{4} \theta ab$, or by (6.14)

$$\theta ab \lesssim E_R^{1/2}(u, \beta) a^{1/2} \left[\frac{1}{\mu^{1/2}} + \frac{1}{b^{1/2}} \right]. \quad (6.18)$$

Rearranging terms and using the assumption $E_R(u, \beta) \leq c|R|E(u, \beta)$ yields (6.16). \square

We now use the previous estimates to obtain a lower bound on E similarly to Lemma 5.5 in the martensite case.

Lemma 6.5 *There are $m_0 \in (0, 1)$ and $c > 0$ with the following property: For all $\varepsilon, \mu > 0$, all $\theta \in (0, 1/2]$ and all $m \in (0, 1)$ such that*

$$\text{at least one of} \quad \theta \leq m \leq m_0 \quad \text{or} \quad m_0 = m \leq \theta \quad (6.19)$$

holds, and for all $\lambda \in (0, 1]$, one has

$$\inf E(u, \beta) \geq c\theta^2 \min \left\{ \mu, \frac{\hat{\varepsilon}}{\lambda}, \lambda^2 m, \mu \lambda \ln \frac{1}{m}, \frac{\lambda m \mu}{\theta} \right\}. \quad (6.20)$$

Proof: *Step 1. Preliminaries.* Let $\varepsilon, \mu, \theta, m$, and λ be given with the properties stated in the lemma. It suffices to consider an arbitrary pair $(u, \beta) \in \mathcal{A}$. We use the short-hand notation $E := E(u, \beta)$, and similarly for E_R and $E_{R, \ell}$. We introduce auxiliary parameters a, b and N . Precisely, fix $b \sim 1$, $b \in (0, 1/3]$ ($b = 1/3$ will do), let $N \in \mathbb{N}$ be such that $\lambda \sim b/N$, and set $a := \lambda\theta/4$. Choose $x_a, x_b \in (0, 1)$ such that $\tilde{R} := (x_a, x_a + a)e_\xi \times (x_b - b, x_b + 2b)e_\eta \subset (0, 1)^2$ and $E_{\tilde{R}} \lesssim |\tilde{R}|E \lesssim abE$ (see Figure 8). Let $R := (x_a, x_a + a)e_\xi \times (x_b, x_b + b)e_\eta \subset \tilde{R}$. Finally pick $\ell \in (0, 1)$ as in Lemma 6.3, i.e., such that $E_{\tilde{R}, \ell} \leq E_{\tilde{R}}$.

We apply Corollary 6.4 to R which shows that if (6.16) does not hold then (6.7) holds with $v := \beta_\eta \varphi_{x_b, b}$ on R_ℓ . Since

$$\int_{R_\ell} |\partial_\xi \beta_\eta \varphi_{x_b, b}| \leq \int_{R_\ell} |\partial_\xi \beta_\eta| \leq \frac{1}{\varepsilon} E_{R, \ell} \quad \text{and} \quad \int_{R_\ell} |\partial_\eta \beta_\xi| \leq \frac{1}{\varepsilon} E_{R, \ell},$$

we deduce from Lemma 6.2, with $w := \beta_\xi$, that we have

$$E \gtrsim \min \left\{ \theta^2 b \mu, \theta^2 b^2, \frac{\varepsilon \theta}{a}, \frac{\varepsilon N}{b} \right\} \quad (6.21)$$

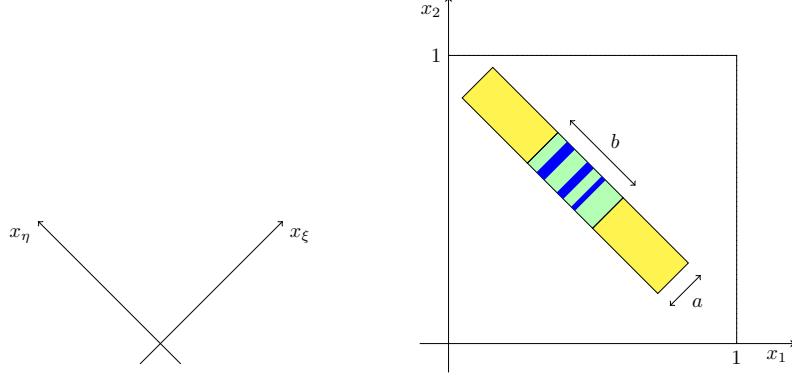

Figure 8: Left: sketch of the geometry in the proof of Lemma 6.5. The marked rectangle is \tilde{R} , the inner, light green rectangle is R . The blue region is $\omega \times (x_a, x_a + a)$ where β_η concentrates.

or there are disjoint intervals $I_1, \dots, I_{8N} \subset (x_b, x_b + b)$ such that (6.9) holds with the above choices. If (6.21) holds, the proof is concluded. Suppose now that the other option holds, and set $\omega := \cup I_i \subset \mathbb{R}$ and $f := \chi_\omega$. Then the second estimate of (6.9) yields, since $0 \leq \varphi_{x_a, a} \leq 1$,

$$\int_{R_\ell} \beta_\xi(x) f(x_\eta) \varphi_{x_a, a}(x_\xi) dx \leq \frac{1}{4} a |\omega|.$$

By Lemma 6.3, since $(1 - \theta) \int_{R_\ell} f(x_\eta) \varphi_{x_a, a}(x_\xi) dx \geq \frac{1}{2} |\omega| \frac{7}{8} a$,

$$a |\omega| \lesssim |\omega|^{1/2} (E_R)^{1/2} \left[\frac{1}{\mu^{1/2}} + \frac{1}{a^{1/2}} \right].$$

Therefore, if $|\omega| > mb$ then

$$E \gtrsim \min\{am\mu, a^2m\}. \quad (6.22)$$

If (6.22) holds, then the proof is concluded (in proving $\theta^2 \ell \lesssim m \ell$ we use that (6.19) implies $\theta \lesssim m$). If instead $|\omega| \leq mb$, we proceed along the lines of the proof of Lemma 5.5.

Step 2. Construction of the test function and conclusion of the proof. Let $\hat{I}_i := B_{mb/N}(I_i) = (y_i - g_i, y_i + g_i)$, and set for $i = 1, \dots, 8N$,

$$\psi(x_\eta) := \max_i \psi_i(x_\eta - y_i), \quad \psi_i(t) := \left[\ln \frac{1}{6m} - \left(\ln \frac{|t|}{g_i} \right)_+ \right]_+. \quad (6.23)$$

Note that ψ has compact support in $(x_b - b, x_b + 2b)$, $\psi = \ln \frac{1}{6m}$ in ω , $g_i \geq (mb)/N$, and $\sum_i g_i \leq mb + |\omega| \leq 2mb$. Then by the first of (6.9) and since β_η , ψ and φ_1 are non-negative, we have, using $\partial_\eta u_0 = \theta$,

$$\begin{aligned} \theta |R| \ln \frac{1}{6m} &\lesssim \int_{\tilde{R}_\ell} \beta_\eta(x) \varphi_{x_b, b}(x_\eta) \psi(x_\eta) dx \leq \int_{\tilde{R}_\ell} \beta_\eta(x) \psi(x_\eta) dx \\ &= \int_{\tilde{R}_\ell} \psi(x_\eta) (\beta_\eta(x) - \partial_\eta u(x)) dx - \int_{\tilde{R}_0} \psi'(x_\eta) (u(x) - u_0(x)) dx - \int_{\tilde{R} \times (0, \ell)} \partial_3 u(x) \psi'(x_\eta) dx + \int_{\tilde{R}} \psi(x_\eta) \theta dx \\ &\lesssim E_R^{1/2} \|\psi\|_{L^2(\tilde{R})} + \int_{\tilde{R}_0} (u_0(x) - u(x)) \psi'(x_\eta) dx + E_R^{1/2} \|\psi'\|_{L^2(\tilde{R} \times (0, 1))} + \theta \|\psi\|_{L^1(\tilde{R})}. \end{aligned}$$

By Lemma 4.1 and Lemma 4.2, we have

$$\begin{aligned} \int_{\tilde{R}_0} (u_0(x) - u(x))\psi'(x_\eta) dx &\lesssim [\psi]_{H_N^{1/2}((x_b-b, x_b+2b))} \left[\int_{x_a}^{x_a+a} (u_0 - u)(x_\xi, \cdot) dx_\xi \right]_{H_N^{1/2}((x_b-b, x_b+2b))} \\ &\lesssim a^{1/2} [\psi]_{H_N^{1/2}((x_b-b, x_b+2b))} [u_0 - u]_{H_N^{1/2}(\tilde{R})}. \end{aligned}$$

We use that (cf. Step 2 in the proof of Lemma 5.5) $\|\psi\|_{L^2} \lesssim b^{1/2}$, $[\psi]_{H_N^{1/2}} \lesssim N^{1/2} \ln^{1/2} \frac{1}{6m}$, $\|\psi'\|_{L^2} \lesssim N/(mb)^{1/2}$ and $\|\psi\|_{L^1} \lesssim b$, where the norms are taken on $(x_b - b, x_b + 2b)$. Hence,

$$\theta ab \ln \frac{1}{6m} \leq cE_R^{1/2} \left((ab)^{1/2} + \left(\frac{aN \ln \frac{1}{6m}}{\mu} \right)^{1/2} + N \left(\frac{a}{mb} \right)^{1/2} \right) + c\theta ab.$$

If m_0 is small enough, then the last term can be absorbed into the left-hand side and $\ln \frac{1}{6m} \gtrsim \ln \frac{1}{m}$. Hence,

$$E \gtrsim \theta^2 \min \left\{ \ln^2 \frac{1}{m}, \frac{\mu b \ln \frac{1}{m}}{N}, \frac{mb^2 \ln^2 \frac{1}{m}}{N^2} \right\} = \theta^2 \min \left\{ \frac{\mu b \ln \frac{1}{m}}{N}, \frac{mb^2 \ln^2 \frac{1}{m}}{N^2} \right\}. \quad (6.24)$$

Recalling $b \sim 1$, $N \sim 1/\lambda$, $m/\theta \gtrsim 1$, and $\ln 1/m \gtrsim 1$ the proof is concluded. \square

Proceeding along the lines of the proof of Proposition 5.6, we now conclude the proof of the lower bound.

Proposition 6.6 *There is a constant $c > 0$ such that for all $\varepsilon, \mu > 0$, and all $0 < \theta \leq 1/2$, we have*

$$\inf E(u, \beta) \geq c\theta^2 \min \left\{ \hat{\varepsilon}^{2/3}, (\hat{\varepsilon}\mu)^{1/2} \ln^{1/2} \left(3 + \frac{\hat{\varepsilon}}{\mu^3} \right), (\hat{\varepsilon}\mu)^{1/2} \ln^{1/2} \left(\frac{1}{\theta} \right), \mu, 1 \right\}.$$

Proof: We start fixing $(u, \beta) \in \mathcal{A}$, $\varepsilon, \mu > 0$ and $\theta \in (0, 1/2]$, and use Lemma 6.5 with different choices of parameters in different regimes.

- (i) If $\hat{\varepsilon} \leq \min\{1, \mu^3\}$, we choose $m := m_0$ and $\lambda := \hat{\varepsilon}^{1/3}$. Then we obtain $E(u, \beta) \gtrsim \theta^2 \min\{\hat{\varepsilon}^{2/3}, \mu\}$.
- (ii) If $1 \leq \hat{\varepsilon} \leq \mu^3$, we choose $m := m_0$ and $\lambda := 1$. Then by (6.20), $E(u, \beta) \geq c\theta^2 \min\{\mu, 1\}$.
- (iii) It remains to consider $\hat{\varepsilon} > \mu^3$. We set

$$m := \max \left\{ \min \left\{ m_0, \theta \ln \frac{2}{\theta} \right\}, \left(\frac{\mu^3}{\hat{\varepsilon}} \right)^{1/4} m_0 \right\}. \quad (6.25)$$

Since $\theta \leq 1/2$ we have $\ln \frac{2}{\theta} \geq 1$, therefore (6.19) holds. We distinguish two subcases:

- (a) If $\hat{\varepsilon} \leq \mu \ln \frac{1}{m}$, we choose $\lambda := \left(\frac{\hat{\varepsilon}}{\mu \ln \frac{1}{m}} \right)^{1/2}$. Using $m \geq m^2 (\ln \frac{1}{m})^{3/2}$ in the $\lambda^2 m$ term, and $m \gtrsim \theta \ln \frac{1}{\theta} \gtrsim \theta \ln \frac{1}{m}$ in the $\lambda m \mu / \theta$ term, we conclude $E(u, \beta) \gtrsim \theta^2 \min\{\mu, 1, (\hat{\varepsilon}\mu)^{1/2} \ln^{1/2} \frac{1}{m}\}$. Since $\ln 1/(\theta \ln 2/\theta) \sim \ln 1/\theta$, the proof is concluded in this case.
- (b) If $\hat{\varepsilon} > \mu \ln \frac{1}{m}$, we choose $\lambda := 1$ and $m := m_0$. Then $E(u, \beta) \gtrsim \theta^2 \min\{1, \mu\}$.

\square

Acknowledgements

We thank Michael Goldman and Stefan Müller for several interesting discussions. This work was partially supported by the Deutsche Forschungsgemeinschaft through the Sonderforschungsbereich 1060 “*The mathematics of emergent effects*”, projects A5 and A6.

References

- [ACO09] G. Alberti, R. Choksi, and F. Otto. Uniform energy distribution for an isoperimetric problem with long-range interactions. *J. Amer. Math. Soc.*, 22:569–605, 2009.
- [AD14] K. Anguige and P. Dondl. Relaxation of the single-slip condition in strain-gradient plasticity. *R. Soc. Lond. Proc. Ser. A Math. Phys. Eng. Sci.*, 470, 2014.
- [AD15] K. Anguige and P. Dondl. Energy estimates, relaxation, and existence for strain-gradient plasticity with cross-hardening. In S. Conti and K. Hackl, editors, *Analysis and computation of microstructure in finite plasticity*, volume 78, pages 157–173. Springer, 2015.
- [BBCDM02] H. Ben Belgacem, S. Conti, A. DeSimone, and S. Müller. Energy scaling of compressed elastic films. *Arch. Rat. Mech. Anal.*, 164:1–37, 2002.
- [BCDM00] H. Ben Belgacem, S. Conti, A. DeSimone, and S. Müller. Rigorous bounds for the Föppl-von Kármán theory of isotropically compressed plates. *J. Nonlinear Sci.*, 10:661–683, 2000.
- [BCLdMQ12] C. Bechtold, C. Chluba, R. Lima de Miranda, and E. Quandt. High cyclic stability of the elastocaloric effect in sputtered tinicu shape memory films. *Applied Physics Letters*, 101, 2012.
- [BG] P. Bella and M. Goldman. Nucleation barriers at corners for cubic-to-tetragonal phase transformation. to appear in *Proc. Roy. Soc. Edinburgh A*.
- [BJ87] J. Ball and R. James. Fine phase mixtures as minimizers of energy. *Arch. Rat. Mech. Anal.*, 100:13–52, 1987.
- [BK14] P. Bella and R. V. Kohn. Wrinkles as the result of compressive stresses in an annular thin film. *Communications on Pure and Applied Mathematics*, 67:693–747, 2014.
- [CC14] A. Chan and S. Conti. Energy scaling and domain branching in solid-solid phase transitions. In M. Griebel, editor, *Singular Phenomena and Scaling in Mathematical Models*, pages 243–260. Springer International Publishing, 2014.
- [CC15] A. Chan and S. Conti. Energy scaling and branched microstructures in a model for shape-memory alloys with $SO(2)$ invariance. *Math. Models Methods App. Sci.*, 25:1091–1124, 2015.

- [CCF⁺06] J. Cui, Y. Chu, O. Famodu, Y. Furuya, J. Hattrick-Simpers, R. James, A. Ludwig, S. Thienhaus, M. Wuttig, Z. Zhang, and I. Takeuchi. Combinatorial search of thermoelectric shape-memory alloys with extremely small hysteresis width. *Nature materials*, 5:286–290, 2006.
- [CCKO08] R. Choksi, S. Conti, R. Kohn, and F. Otto. Ground state energy scaling laws during the onset and destruction of the intermediate state in a type I superconductor. *Comm. Pure Appl. Math.*, 61(5):595–626, 2008.
- [CGM11] S. Conti, A. Garroni, and S. Müller. Singular kernels, multiscale decomposition of microstructure, and dislocation models. *Arch. Rat. Mech. Anal.*, 199:779–819, 2011.
- [CGO15] S. Conti, A. Garroni, and M. Ortiz. The line-tension approximation as the dilute limit of linear-elastic dislocations. *Arch. Rat. Mech. Anal.*, 2015. to appear.
- [Cho01] R. Choksi. Scaling laws in microphase separation of diblock copolymers. *J. Nonlinear Sci.*, 11:223–236, 2001.
- [CK98] R. Choksi and R. V. Kohn. Bounds on the micromagnetic energy of a uniaxial ferromagnet. *Comm. Pure Appl. Math.*, 51:259–289, 1998.
- [CKO98] R. Choksi, R. Kohn, and F. Otto. Domain branching in uniaxial ferromagnets: a scaling law for the minimum energy. *Comm. Math. Phys.*, 201(1):61–79, 1998.
- [CO05] S. Conti and M. Ortiz. Dislocation microstructures and the effective behavior of single crystals. *Arch. Rat. Mech. Anal.*, 176:103–147, 2005.
- [CO09] A. Capella and F. Otto. A rigidity result for a perturbation of the geometrically linear three-well problem. *Comm. Pure Appl. Math.*, 62:1632–1669, 2009.
- [CO12] A. Capella and F. Otto. A quantitative rigidity result for the cubic-to-tetragonal phase transition in the geometrically linear theory with interfacial energy. *Proc. Roy. Soc. Edinburgh Sect. A*, 142:273–327, 2012.
- [Con00] S. Conti. Branched microstructures: scaling and asymptotic self-similarity. *Comm. Pure Appl. Math.*, 53:1448–1474, 2000.
- [Con06] S. Conti. A lower bound for a variational model for pattern formation in shape-memory alloys. *Cont. Mech. Thermodyn.*, 17 (6):469–476, 2006.
- [COS15] S. Conti, F. Otto, and S. Serfaty. Branched microstructures in the Ginzburg-Landau model of type-I-superconductors. arXiv:1507.00836v1, 2015.
- [Dac07] B. Dacorogna. *Direct methods in the calculus of variations*, volume 78. Springer, 2007.
- [Die10] J. Diermeier. Nichtkonvexe Variationsprobleme und Mikrostrukturen. Bachelor’s thesis, Universität Bonn, 2010.
- [Die13] J. Diermeier. Domain branching in linear elasticity. Master’s thesis, Universität Bonn, 2013.

- [DKZ⁺10] R. Delville, S. Kasinathan, Z. Zhang, J. Van Humbeeck, R. James, and D. Schryvers. Transmission electron microscopy study of phase compatibility in low hysteresis shape memory alloys. *Philosophical Magazine*, 90:177–195, 2010.
- [DSZJ09] R. Delville, D. Schryvers, Z. Zhang, and R. James. Transmission electron microscopy investigation of microstructures in low-hysteresis alloys with special lattice parameters. *Scripta Materialia*, 60:293–296, 2009.
- [GLP10] A. Garroni, G. Leoni, and M. Ponsiglione. Gradient theory for plasticity via homogenization of discrete dislocations. *J. Eur. Math. Soc. (JEMS)*, 12:1231–1266, 2010.
- [GM06] A. Garroni and S. Müller. A variational model for dislocations in the line tension limit. *Arch. Ration. Mech. Anal.*, 181:535–578, 2006.
- [GM12] A. Giuliani and S. Müller. Striped periodic minimizers of a two-dimensional model for martensitic phase transitions. *Comm. Math. Phys.*, 309:313–339, 2012.
- [JS01] W. Jin and P. Sternberg. Energy estimates of the von Kármán model of thin-film blistering. *J. Math. Phys.*, 42:192–199, 2001.
- [JS02] W. Jin and P. Sternberg. In-plane displacements in thin-film blistering. *Proc. R. Soc. Edin. A*, 132A:911–930, 2002.
- [JZ05] R. James and Z. Zhang. A way to search for multiferroic materials with “unlikely” combinations of physical properties. In L. Manosa, A. Planes, and A. Saxena, editors, *The Interplay of Magnetism and Structure in Functional Materials*, volume 79. Springer, 2005.
- [KK11] H. Knüpfer and R. V. Kohn. Minimal energy for elastic inclusions. *Proc. R. Soc. Lond. Ser. A Math. Phys. Eng. Sci.*, 467:695–717, 2011.
- [KKO13] H. Knüpfer, R. V. Kohn, and F. Otto. Nucleation barriers for the cubic-to-tetragonal phase transformation. *Comm. Pure Appl. Math.*, 66:867–904, 2013.
- [KM92] R. Kohn and S. Müller. Branching of twins near an austenite-twinned martensite interface. *Phil. Mag. A*, 66:697–715, 1992.
- [KM94] R. Kohn and S. Müller. Surface energy and microstructure in coherent phase transitions. *Comm. Pure Appl. Math.*, XLVII:405–435, 1994.
- [KM11] H. Knüpfer and C. Muratov. Domain structure of bulk ferromagnetic crystals in applied fields near saturation. *J. Nonlinear Sc.*, pages 1–42, 2011.
- [KW] R. Kohn and B. Wirth. Optimal fine-scale structures in compliance minimization for a shear load. *Communications in Pure and Applied Mathematics*. accepted.
- [KW14] R. Kohn and B. Wirth. Optimal fine-scale structures in compliance minimization for a uniaxial load. *Proceedings of the Royal Society A*, 470:20140432–20140448, 2014.

- [Lan38] L. Landau. The intermediate state of superconductors. *Nature*, 141:688, 1938.
- [Lan43] L. Landau. On the theory of the intermediate state of superconductors. *J. Phys. USSR*, 7:99, 1943.
- [Leo09] G. Leoni. *A first course in Sobolev Spaces*. Graduate Studies in Mathematics. AMS, 2009.
- [LKBH10] M. Louie, M. Kislitsyn, K. Bhattacharya, and S. Haile. Phase transformation and hysteresis behavior in $\text{Cs}_{1-x}\text{Rb}_x\text{H}_2\text{PO}_4$. *Solid state ionics*, 181:173–179, 2010.
- [MSZ14] S. Müller, L. Scardia, and C. I. Zeppieri. Geometric rigidity for incompatible fields and an application to strain-gradient plasticity. *Indiana Univ. Math. J.*, 63:1365–1396, 2014.
- [Mül99] S. Müller. Variational models for microstructure and phase transitions. In F. Bethuel et al., editors, *Calculus of variations and geometric evolution problems*, Springer Lecture Notes in Math. 1713, pages 85–210. Springer-Verlag, 1999.
- [OV10] F. Otto and T. Viehmann. Domain branching in uniaxial ferromagnets: asymptotic behavior of the energy. *Calc. Var. PDE*, 38:135–181, 2010.
- [Sch94] C. Schreiber. Rapport de stage, d.e.a. Freiburg, 1994.
- [SCJ10] V. Srivastava, X. Chen, and R. James. Hysteresis and unusual magnetic properties in the singular Heusler alloy $\text{Ni}_{45}\text{Co}_5\text{Mn}_{40}\text{Sn}_{10}$. *Appl. Phys. Lett.*, 97:014101, 2010.
- [SDS⁺14] H. Shi, R. Delville, V. Srivastava, R. James, and D. Schryvers. Microstructural dependence on middle eigenvalue in ti–ni–au. *Journal of Alloys and Compounds*, 582:703 – 707, 2014.
- [Zha07] Z. Zhang. *Special lattice parameters and the design of low hysteresis materials*. PhD thesis, University of Minnesota, 2007.
- [ZTY⁺10] R. Zarnetta, R. Takahashi, M. Young, A. Savan, Y. Furuya, S. Thienhaus, B. Maaß, M. Rahim, J. Frenzel, H. Brunken, Y. Chu, V. Srivastava, R. James, I. Takeuchi, G. Eggeler, and A. Ludwig. Identification of quaternary shape memory alloys with near-zero thermal hysteresis and unprecedented functional stability. *Advanced Functional Materials*, 20(12):1917–1923, 2010.
- [Zwi14] B. Zwicknagl. Microstructures in low-hysteresis shape memory alloys: Scaling regimes and optimal needle shapes. *Arch. Rat. Mech. Anal.*, 213:355–421, 2014.