

**ON THE NUMBER OF ERGODIC MEASURES FOR MINIMAL
SHIFTS WITH EVENTUALLY CONSTANT COMPLEXITY
GROWTH**

MICHAEL DAMRON AND JON FICKENSCHER

ABSTRACT. In 1985, Boshernitzan showed that a minimal (sub)shift satisfying a *linear block growth* condition must have a bounded number of ergodic probability measures. Recently, this bound was shown to be sharp through examples constructed by Cyr and Kra. In this paper, we show that under the stronger assumption of *eventually constant growth*, an improved bound exists. To this end, we introduce *special Rauzy graphs*. Variants of the well-known Rauzy graphs from symbolic dynamics, these graphs provide an explicit description of how a Rauzy graph for words of length n relates to the one for words of length $n + 1$ for each $n = 1, 2, 3, \dots$

1. INTRODUCTION

1.1. **Motivation and Main Result.** For a finite alphabet \mathcal{A} of symbols, the set

$$\mathcal{A}^{\mathbb{N}} = \{x = x_1x_2x_3 \cdots : x_n \in \mathcal{A} \text{ for all } n \in \mathbb{N}\}$$

is endowed with the natural product topology and may be realized as a compact metric space. In this paper, $\mathbb{N} = \{1, 2, \dots\}$ is the set of positive integers and $\mathbb{N}_0 = \{0\} \cup \mathbb{N}$. The (left) shift $T : \mathcal{A}^{\mathbb{N}} \rightarrow \mathcal{A}^{\mathbb{N}}$ is defined by

$$(Tx)_n = x_{n+1} \text{ for all } n \in \mathbb{N}$$

and is continuous. A *shift*¹ $\Omega \subseteq \mathcal{A}^{\mathbb{N}}$ is any closed and T -invariant subset of $\mathcal{A}^{\mathbb{N}}$. We will restrict our discussion to *minimal* shifts, meaning that every T -orbit is dense in Ω , or equivalently that there are no non-trivial shifts $\Omega' \subsetneq \Omega$.

The set $\mathcal{A}^* = \bigcup_{n \in \mathbb{N}_0} \mathcal{A}^n$ is the collection of all finite *words* on \mathcal{A} , including the empty word ϵ . The *language* of a shift Ω is the collection of all words that occur in any $x \in \Omega$, or

$$\mathcal{L}_\Omega = \{w \in \mathcal{A}^* : x_{[j, j+|w|-1]} = w \text{ for some } j \in \mathbb{N} \text{ and } x \in \Omega\}.$$

Here $x_{[i, j]} = x_i x_{i+1} \dots x_{j-1} x_j$ represents the word in x that begins at position i and ends at position j and $|w|$ is the *length* of w ; that is, $|w| = n$ where $w = w_1 w_2 \dots w_n$. We may then define $\mathcal{L}_\Omega(n)$ for $n \in \mathbb{N}_0$ as the set of all $w \in \mathcal{L}_\Omega$ such that $|w| = n$.

One object that has been used to describe shifts is the *complexity function* p_Ω , defined as

$$p_\Omega(n) = \#\mathcal{L}_\Omega(n).$$

Date: October 7, 2018.

The research of M. D. is supported by NSF grant DMS-0901534.

¹Many texts call $\mathcal{A}^{\mathbb{N}}$ a *shift* and regard what we define here as a *subshift*. We follow the convention of calling these objects *full shifts* and *shifts* respectively.

For example, the Morse-Hedlund Theorem shows that any minimal Ω whose complexity function satisfies $p_\Omega(n_0) \leq n_0$ for some n_0 must actually have bounded complexity for all n and must therefore be a finite and periodic system. As a result, $p_\Omega(n) \geq n + 1$ for all n if Ω is aperiodic, and the class of well-studied Ω such that equality holds for all n is known as *Sturmian*.

When considering the Borel σ -algebra for minimal Ω , the system may be viewed as a measure-theoretic dynamical system. Boshernitzan in [1] wanted to describe the set of T -invariant probability measures $\mathcal{M}(\Omega)$ by bounding the size of the set of ergodic measures $\mathcal{E}(\Omega) \subseteq \mathcal{M}(\Omega)$ for Ω 's such that p_Ω satisfies some linear upper bounds. In particular, he showed the following results.

Theorem (Boshernitzan). *Let Ω be an aperiodic minimal shift on a finite alphabet \mathcal{A} .*

- (i) [1, Corollary 1.3]
If $\liminf_{n \rightarrow \infty} \frac{p_\Omega(n)}{n} = \alpha$, then $\#\mathcal{E}(\Omega) \leq \lfloor \alpha \rfloor$.
- (ii) [1, Theorem 1.5 & Theorem 8.1]
If $\limsup_{n \rightarrow \infty} \frac{p_\Omega(n)}{n} < K$ for some integer $K \geq 3$, then $\#\mathcal{E}(\Omega) \leq K - 2$.
- (iii) If $\limsup_{n \rightarrow \infty} \frac{p_\Omega(n)}{n} = \alpha$ for real $\alpha \geq 2$, then $\#\mathcal{E}(\Omega) \leq \lfloor \alpha \rfloor - 1$.

Note that (iii) is implied by (ii) by choosing $K = \lfloor \alpha \rfloor + 1$.

For any integer $d \geq 3$, V. Cyr and B. Kra [3] recently constructed minimal shifts Ω such that

$$\liminf_{n \rightarrow \infty} \frac{p_\Omega(n)}{n} = d, \quad \limsup_{n \rightarrow \infty} \frac{p_\Omega(n)}{n} = d + 1 \quad \text{and} \quad \#\mathcal{E}(\Omega) = d.$$

These demonstrate that Boshernitzan's results are sharp. They also strengthened the results in Boshernitzan's paper by allowing non-minimal Ω and achieving the same bound for the larger class of *generic measures*. A measure μ on Ω is generic if there exists $x \in \Omega$ so that

$$\lim_{N \rightarrow \infty} \frac{1}{N} \sum_{n=0}^{N-1} f(T^n x) = \int_{\Omega} f d\mu$$

for all continuous $f : \Omega \rightarrow \mathbb{C}$. Note that any such f is bounded due to compactness of Ω .

In this paper, we improve Boshernitzan's results under stronger assumptions on Ω . We are motivated by the class of shifts associated to *interval exchange transformations*. See [9] for a survey of these dynamical systems and [4] regarding their associated shifts. The following facts hold in generality²: if Ω is a shift associated to a minimal interval exchange on d intervals then

$$p_\Omega(n) = (d - 1)n + 1 \quad \text{for all } n$$

while $\#\mathcal{E}(\Omega) \leq \lfloor d/2 \rfloor$, as proved by [5] and later, with a different method, by [8]. The $\lfloor d/2 \rfloor$ bound was verified to be sharp on 4 intervals in [7] and then for all $d \geq 4$ in [11]. For $d \leq 4$, this bound and Boshernitzan's bound agree. However, for $d \geq 5$ Boshernitzan's bound, $\#\mathcal{E}(\Omega) \leq d - 2$, is strictly weaker.

²Meaning for all interval exchange transformations that satisfy the *infinite distinct orbit condition*, a generic condition introduced in [6].

We will consider minimal Ω whose complexity function satisfies an *eventually constant growth condition*: $p_\Omega(n+1) - p_\Omega(n) = K$ for a fixed $K \in \mathbb{N}$ and all $n \geq n_0$ for some n_0 . Equivalently, $p_\Omega(n)$ has eventually constant growth if and only if

$$(1) \quad p_\Omega(n) = Kn + C \text{ for all } n \geq n_0,$$

where $K, n_0 \in \mathbb{N}$ and $C \in \mathbb{N}_0$ are constants.

We now present our main result.

Theorem 1.1. *If a minimal shift Ω on a finite \mathcal{A} satisfies equation (1) with $K \geq 4$, then $\#\mathcal{E}(\Omega) \leq K - 2$.*

Note that for such a space Ω , Boshernitzan's result gives $\#\mathcal{E}(\Omega) \leq K - 1$. This is also the bound given by Kra and Cyr [3], though their results apply to more general systems. So our bound of $K - 2$ is a strict improvement over the previous ones for ergodic measures, in our setting of eventually constant growth.

1.2. Outline of paper. In Section 2, we establish the notations and definitions used in this paper. While most of the ideas presented are well-known, we do introduce two concepts vital to our work. In Section 2.3 we define *special Rauzy graphs*, variants on Rauzy graphs from symbolic dynamics. We then define the *binary extension condition* for a language/shift in Section 2.4.

We define and prove results for a notion of *disjoint density*, motivated by ideas from [1], in Section 3. Loosely speaking, a measure μ has *disjoint density* $\beta > 0$ in a measure ν if a fixed sequence of words generating μ occurs with a frequency at least β in a generic sequence x for ν . We primarily use disjoint density for ergodic ν , and in this case if μ has positive disjoint density in ν , then $\mu = \nu$ (see Corollary 3.6).

A *coloring function* on special Rauzy graphs is introduced in Section 4. We show that any such coloring function must satisfy a set of rules (Proposition 4.6) and the number of colors for such a function bounds the number of ergodic measures (Definition 4.4).

There is a special Rauzy graph for each $n \in \mathbb{N}$ and the graph for n is related to the graph for $n + 1$ by *bispecial moves*. Defined in Section 5, such moves explicitly describe all possible changes as n increases. We describe the effects of such moves on coloring functions in Lemma 5.8 for different graphs and end this section by considering *loops* in special Rauzy graphs. These are pairs of vertices that form a cycle in the graph and represent the smallest set of vertices that may share a color. In our main proofs, we look at such loops to force measures (i.e., colors) to “spread” in graphs with too many loops. To achieve this, we establish necessary results in Section 5.6.

The proof of the main theorem is provided in Section 6. We first show our result for very specific graphs (Lemmas 6.2 and 6.3). These graphs are composed of many consecutive loops, allowing for freedom in only a few vertices. We then provide a proof of our main theorem under the binary extension condition as defined in Section 2.4. The section ends with a proof for all shifts that satisfy equation (1).

We end with Section 7 by listing further uses for the tools developed in this work. In particular, if we make stronger assumptions on our shift then we may achieve a better bound for $\#\mathcal{E}(\Omega)$ than in Theorem 1.1.

2. DEFINITIONS

When considering a minimal shift Ω on finite alphabet \mathcal{A} , we will typically suppress the subscript Ω when referring to the complexity function $p = p_\Omega$ and language $\mathcal{L} = \mathcal{L}_\Omega$.

2.1. Ergodic Theory. The topology on $\mathcal{A}^\mathbb{N}$, and therefore on any shift $\Omega \subseteq \mathcal{A}^\mathbb{N}$, is generated by *cylinder sets* $[w]$ for words $w \in \mathcal{A}^*$, where

$$[w] = \{x \in \mathcal{A}^\mathbb{N} : x_{[1,n]} = w\}, \quad n = |w|.$$

In other words, $[w]$ is the collection of all x such that $x_1 \dots x_n = w$. Cylinders are *clopen*; that is, closed and open, and the indicator functions $\chi_{[w]}$ form a countable basis for $\mathcal{C}(\mathcal{A}^\mathbb{N})$, the space of continuous functions $\mathcal{A}^\mathbb{N} \rightarrow \mathbb{C}$. The metric

$$d(x, y) = \begin{cases} 2^{-\min\{n \in \mathbb{N} : x_n \neq y_n\}}, & x \neq y, \\ 0, & x = y, \end{cases}$$

also generates the same topology, and it follows that any shift is a compact metric space. Any measure $\mu \in \mathcal{M}(\Omega)$ on a shift $\Omega \subseteq \mathcal{A}^\mathbb{N}$ naturally extends to $\mathcal{A}^\mathbb{N}$ by defining $\mu(\mathcal{A}^\mathbb{N} \setminus \Omega) = 0$. By the Riesz Representation Theorem, $\mu \in \mathcal{M}(\Omega)$ is then uniquely determined by the values

$$\mu([u]) \text{ for } u \in \mathcal{A}^\mathbb{N}$$

and for minimal Ω , $\mu([u]) > 0$ if and only if $u \in \mathcal{L}$. The reader should refer to Sections 6.1–6.2 in [10] for more background on invariant measures for compact metric spaces. If $\mu, \mu' \in \mathcal{M}(\Omega)$ and $\beta \in (0, 1)$, we say that

$$\mu \geq \beta\mu'$$

when $\mu([u]) \geq \beta\mu'([u])$ for all $u \in \mathcal{A}^*$.

Remark 2.1. *By the extremality of $\mathcal{E}(\Omega)$ in $\mathcal{M}(\Omega)$, for any $\nu \in \mathcal{E}(\Omega)$, $\mu \in \mathcal{M}(\Omega)$ and $\beta \in (0, 1)$, $\nu \geq \beta\mu$ implies $\nu = \mu$.*

For $u, w \in \mathcal{A}^*$, let

$$\#_u(w) = \#\{1 \leq j \leq |w| - |u| + 1 : w_{[j, j+|u|-1]} = u\}$$

denote the number of occurrences of u in w . If $\nu \in \mathcal{E}(\Omega)$, then ν -almost every $x \in \Omega$ is *generic* for ν by Birkhoff's Pointwise Ergodic Theorem, meaning

$$\lim_{n \rightarrow \infty} \frac{\#_u(x_{[1,n]})}{n} = \nu([u]) \text{ for every } u \in \mathcal{A}^*.$$

Definition 2.2. For each $\nu \in \mathcal{E}(\Omega)$, we fix $x^{(\nu)} \in \Omega$ that is generic for ν .

Let $(w^{(n)})_{n \in \mathbb{N}}$ be a sequence of words $w^{(n)} \in \mathcal{A}^*$ such that $|w^{(n)}| \rightarrow \infty$ as $n \rightarrow \infty$. If for each $u \in \mathcal{A}^*$ the limit

$$(2) \quad \phi(u) = \lim_{n \rightarrow \infty} \frac{\#_u(w^{(n)})}{|w^{(n)}|}$$

exists, then there is a unique T -invariant measure $\mu \in \mathcal{M}(\mathcal{A}^\mathbb{N})$ such that $\mu([u]) = \phi(u)$ for all $u \in \mathcal{A}^*$. Furthermore, if $w^{(n)} \in \mathcal{L}$ for all n , then $\mu \in \mathcal{M}(\Omega)$.

Definition 2.3. If equation (2) holds for all $u \in \mathcal{A}^*$ for a sequence of words $(w^{(n)})_{n \in \mathbb{N}}$ where $w^{(n)} \in \mathcal{L}$ for all n as above and μ is the associated measure, we say that $(w^{(n)})_{n \in \mathbb{N}}$ *generates* μ or $w^{(n)} \rightarrow \mu$ as $n \rightarrow \infty$.

Remark 2.4. Given a sequence $(w^{(n)})_{n \in \mathbb{N}}$ in \mathcal{L} such that $|w^{(n)}| \rightarrow \infty$, the limit in equation (2) might not exist for all $u \in \mathcal{L}$. However, by diagonalization, we may choose a subsequence $(n_k)_{k \in \mathbb{N}}$ so that

$$\lim_{k \rightarrow \infty} \frac{\#_u(w^{(n_k)})}{|w^{(n_k)}|}$$

exists for all $u \in \mathcal{A}^*$. In this case, we still obtain $\mu \in \mathcal{M}(\Omega)$ and write $w^{(n)} \rightarrow \mu$ for $\mathcal{J} \ni n \rightarrow \infty$ where $\mathcal{J} = \{n_k : k \in \mathbb{N}\}$.

2.2. Special Words. For a minimal Ω , the language \mathcal{L} has the following properties:

- \mathcal{L} contains all of its subwords, meaning that if $w \in \mathcal{L}$ then $w_{[i,j]} \in \mathcal{L}$ for any i, j with $1 \leq i \leq j \leq |w|$.
- Every word $w \in \mathcal{L}$ is *extendable*, meaning there exist $a, b \in \mathcal{A}$ so that the concatenation awb is an element of \mathcal{L} .

For any $w \in \mathcal{L}(n)$, we define the *left extensions* and *right extensions* respectively by

$$\text{Ext}_\ell(w) = \{w' \in \mathcal{L}(n+1) : w'_{[2, n+1]} = w\}$$

and

$$\text{Ext}_r(w) = \{w' \in \mathcal{L}(n+1) : w'_{[1, n]} = w\}.$$

Likewise, let

$$\text{Ext}_{\ell r}(w) = \{w'' \in \mathcal{L}(n+2) : w''_{[2, n+1]} = w\}$$

denote the *two-sided extensions* of w . Because \mathcal{L} is extendable, these sets are all non-empty for each w . A word $w \in \mathcal{L}$ is *left special* if $\#\text{Ext}_\ell(w) \geq 2$ and *right special* if $\#\text{Ext}_r(w) \geq 2$. A *bispecial word* is one that is both left and right special. Let \mathcal{L}_ℓ and \mathcal{L}_r denote the left special and right special words in \mathcal{L} respectively. For convenience, we will sometimes call w \mathfrak{s} -special for $\mathfrak{s} \in \{\ell, r\}$ to indicate that $w \in \mathcal{L}_\mathfrak{s}$.

For any $n \in \mathbb{N}$ and $\mathfrak{s} \in \{\ell, r\}$, the sets $\text{Ext}_\mathfrak{s}(w)$, $w \in \mathcal{L}(n)$, partition $\mathcal{L}(n+1)$. Also, $\#\text{Ext}_\mathfrak{s}(w) = 1$ if and only if w is not \mathfrak{s} -special. Therefore

$$(3) \quad \sum_{w \in \mathcal{L}_\mathfrak{s}(n)} (\#\text{Ext}_\mathfrak{s}(w) - 1) = \sum_{w \in \mathcal{L}(n)} (\#\text{Ext}_\mathfrak{s}(w) - 1) = p(n+1) - p(n),$$

where $\mathcal{L}_\mathfrak{s}(n) = \mathcal{L}_\mathfrak{s} \cap \mathcal{L}(n)$. We therefore have the following relationships between special words and growth of the complexity function for aperiodic Ω . First, by using equation (3) and the fact that $\#\text{Ext}_\mathfrak{s}(w) \geq 2$ for all $w \in \mathcal{L}_\mathfrak{s}(n)$,

$$1 \leq \#\mathcal{L}_\mathfrak{s}(n) \leq p(n+1) - p(n) \text{ for all } n \in \mathbb{N}, \mathfrak{s} \in \{\ell, r\}.$$

Furthermore,

$$(4) \quad \#\mathcal{L}_\mathfrak{s}(n) = p(n+1) - p(n)$$

holds for some $n \in \mathbb{N}$ and $\mathfrak{s} \in \{\ell, r\}$ if and only if $\#\text{Ext}_\mathfrak{s}(w) = 2$ for all $w \in \mathcal{L}_\mathfrak{s}(n)$, or equivalently

$$(5) \quad \max\{\#\text{Ext}_\mathfrak{s}(w) : w \in \mathcal{L}(n)\} \leq 2.$$

Lemma 2.5. For $\mathfrak{s} \in \{\ell, r\}$, let $\psi_\mathfrak{s} : \mathbb{N}_0 \rightarrow \mathbb{N}$ be defined as

$$\psi_\mathfrak{s}(n) = \max\{\#\text{Ext}_\mathfrak{s}(w) : w \in \mathcal{L}(n)\}.$$

The function $\psi_\mathfrak{s}$ is non-increasing in n and therefore is eventually constant.

Proof. We provide the proof when $\mathfrak{s} = \ell$, as the $\mathfrak{s} = r$ case is similar. Consider any $w \in \mathcal{L}(n+1)$ and its length n prefix $\tilde{w} = w_{[1,n]}$. We claim that the map

$$w' \mapsto w'_{[1,n+1]}$$

is a well-defined injection from $\text{Ext}_\ell(w)$ to $\text{Ext}_\ell(\tilde{w})$.

For any $w' \in \text{Ext}_\ell(w)$, $w'_{[2,n+1]} = \tilde{w}$, so the image is a left-extension of \tilde{w} . Each word in $\text{Ext}_\ell(w)$ is distinguished uniquely by its first letter. It follows that $w'_{[1,n+1]} \neq w''_{[1,n+1]}$ for distinct $w', w'' \in \text{Ext}_\ell(w)$, proving injectivity. Therefore $\psi_\ell(n+1) = \max_{w \in \mathcal{L}(n+1)} \#\text{Ext}_\ell(w) \leq \psi_\ell(n)$. \square

We end this section by relating $\psi_\mathfrak{s}(n)$ as defined above to $p(n+1) - p(n)$ and $\#\mathcal{L}_\mathfrak{s}(n)$. For each $w \in \mathcal{L}_\mathfrak{s}(n)$, $\#\text{Ext}_\mathfrak{s}(w) \geq 2$ by definition. Also, there exists $\tilde{w} \in \mathcal{L}_\mathfrak{s}(n)$ such that $\#\text{Ext}_\mathfrak{s}(\tilde{w}) = \psi_\mathfrak{s}(n)$. Applying this to equation (3), we obtain $(\#\mathcal{L}_\mathfrak{s}(n) - 1) + (\psi_\mathfrak{s}(n) - 1) \leq p(n+1) - p(n)$, or

$$(6) \quad \#\mathcal{L}_\mathfrak{s}(n) + \psi_\mathfrak{s}(n) \leq p(n+1) - p(n) + 2,$$

by bounding $\#\text{Ext}_\mathfrak{s}(w)$ from below by 2 for all \mathfrak{s} -special $w \neq \tilde{w}$.

2.3. Special Rauzy Graphs. We first recall the definition of the *Rauzy graphs* $\Gamma(n)$ for $n \in \mathbb{N}$ associated to a language \mathcal{L} . Each $\Gamma(n)$ is a directed graph with vertex set $\mathcal{L}(n)$ and a directed edge from u to v , written $u \rightarrow v$, if and only if there exists $w \in \mathcal{L}(n+1)$ such that $w_{[1,n]} = u$ and $w_{[2,n+1]} = v$.

We now define the *special Rauzy graphs* $\Gamma^{\text{Spec}}(n)$. If $w \in \mathcal{L}(n)$ is *unispecial* (that is, left special or right special but not both), then w is a vertex in $\Gamma^{\text{Spec}}(n)$. If $w \in \mathcal{L}(n)$ is *bispecial*, then we associate to it two distinct vertices w_ℓ and w_r in $\Gamma^{\text{Spec}}(n)$. An edge from unispecial w to unispecial w' exists, written $w \rightarrow w'$, when there is a path in $\Gamma(n)$ from w to w' that visits only non-special words in between. All paths that end at a bispecial word w in $\Gamma(n)$ will have their corresponding edges in $\Gamma^{\text{Spec}}(n)$ end at w_ℓ , while all paths that begin at w in $\Gamma(n)$ will have their corresponding edges in $\Gamma^{\text{Spec}}(n)$ begin at w_r . We also include the edge $w_\ell \rightarrow w_r$ for each bispecial word w . The *weight* of edge $w \rightarrow w'$ in $\Gamma^{\text{Spec}}(n)$, denoted $\rho_n(w \rightarrow w')$, is the length of the corresponding path in $\Gamma(n)$, with the convention that $\rho_n(w_\ell \rightarrow w_r) = 0$ for any bispecial $w \in \mathcal{L}(n)$.

Definition 2.6. Given a special Rauzy graph $\Gamma^{\text{Spec}}(n)$, $w \in \Gamma^{\text{Spec}}(n)$ denotes that w is a vertex in the graph while $w \rightarrow w' \in \Gamma^{\text{Spec}}(n)$ means that the directed edge from vertex w to vertex w' exists in the graph.

We inherit the definitions from the language and refer to a vertex in $\Gamma^{\text{Spec}}(n)$ with more than one outgoing edge as *right special* and a vertex with more than one incoming edge as *left special*. Note that every vertex in $\Gamma^{\text{Spec}}(n)$ is either left or right special but not both. We call an edge $u \rightarrow v$ such that u is left special and v is right special a *bispecial edge*.

Definition 2.7. Given a special Rauzy graph $\Gamma^{\text{Spec}}(n)$ and $\mathfrak{s} \in \{\ell, r\}$ we let

$$K_\mathfrak{s}(n) = \#\mathcal{L}_\mathfrak{s}(n)$$

denote the number of \mathfrak{s} -special vertices in the graph.

2.4. Binary Extension Condition. The condition used in this paper on \mathcal{L} may now be defined.

Definition 2.8. A language \mathcal{L} satisfies the *binary \mathfrak{s} -extension condition* for N_0 , $\mathfrak{s} \in \{\ell, r\}$, if equation (5) holds for all $n \geq N_0$. If \mathcal{L} satisfies both the binary ℓ -extension condition and the binary r -extension condition for N_0 , then \mathcal{L} satisfies the *binary extension condition* for N_0 .

Remark 2.9. If $\mathcal{A} = \{0, 1\}$, then $\#\text{Ext}_\ell(w) \leq 2$ and $\#\text{Ext}_r(w) \leq 2$ for all w . Therefore any Ω on $\mathcal{A} = \{0, 1\}$ will have a language that satisfies the binary extension condition for all n . The results in this paper that follow will usually assume $\mathcal{A} = \{0, 1\}$ for convenience but may be extended to any language with the binary extension condition after ignoring finitely many n .

If Ω on \mathcal{A} has language \mathcal{L} that satisfies the binary extension condition for N_0 and has constant complexity growth K as in equation (1) for $n \geq N_0$ as well, then for each special Rauzy graph $\Gamma^{\text{Spec}}(n)$ where $n \geq N_0$,

$$K_\ell(n) = K_r(n) = K,$$

or each special graph has exactly $2K$ vertices.

The following natural consequence of Lemma 2.5 will help to classify different languages in the proof of Theorem 1.1. Essentially, a language will either satisfy the binary extension condition or will always have at least one \mathfrak{s} -special vertex with more than two branches in each special Rauzy graph $\Gamma^{\text{Spec}}(n)$.

Corollary 2.10. Let Ω be a minimal shift on finite \mathcal{A} with language \mathcal{L} . If (4) holds for some N_0 and $\mathfrak{s} \in \{\ell, r\}$, then \mathcal{L} satisfies the binary \mathfrak{s} -extension condition for N_0 .

Proof. If equation (4) holds for N_0 , then $\psi_\mathfrak{s}(N_0) = 2$, where $\psi_\mathfrak{s}$ is from Lemma 2.5. By that lemma, $\psi_\mathfrak{s}(n) \leq 2$ for all $n \geq N_0$. \square

If \mathcal{L} satisfies the binary extension condition, then for all large n

$$\#\text{Ext}_{\ell r}(w) \in \{2, 3, 4\}$$

for a bispecial word w . We may classify w according to the number of two-way extensions, using the terminology from [2].

- If $\#\text{Ext}_{\ell r}(w) = 2$, then w is *weak bispecial*. In this case, an extension of w on one side uniquely determines the extension on the other.
- If $\#\text{Ext}_{\ell r}(w) = 3$, then w is *regular bispecial*. Here exactly one right extension is left special and exactly one left extension is right special.
- If $\#\text{Ext}_{\ell r}(w) = 4$, then w is *strong bispecial*. All one-sided extensions of w are special on the opposite side.

Unless we assume the binary extension condition, bispecial words may not be as easily classified because the possible number of two way extensions for a given bispecial word may take on many more values.

3. DISJOINT DENSITY

3.1. Definition. Let w be a word on \mathcal{A} of length n , $L \in \mathbb{N}$ and $x \in \mathcal{A}^{\mathbb{N}}$. We define $r_L(w, x, j)$ for $j \in \mathbb{N}$ by

$$r_L(w, x, j) = \begin{cases} 1, & x_{[i, i+n-1]} = w \text{ for some } (j-1)Ln < i \leq jLn, \\ 0, & \text{otherwise.} \end{cases}$$

So $r_L(w, x, j)$ indicates whether or not w begins anywhere in the j^{th} block of length Ln in x . We then define the *sum function* and *average function* as

$$\mathcal{S}_{L,N}(w, x) = \sum_{j=1}^N r_L(w, x, j) \text{ and } \mathcal{D}_{L,N}(w, x) = \frac{1}{N} \mathcal{S}_{L,N}(w, x)$$

respectively.

Definition 3.1. The *disjoint (upper) density* of w in x by L -blocks is

$$\mathcal{D}_L(w, x) = \limsup_{N \rightarrow \infty} \mathcal{D}_{L,N}(w, x).$$

Remark 3.2. It is a direct exercise to show that

$$\mathcal{D}_L(w, x) = \limsup_{N \rightarrow \infty} \mathcal{D}_{L,MN}(w, x)$$

for any $M \in \mathbb{N}$.

Remark 3.3. This concept of density is similar in spirit to that in [1]. However, we are counting occurrences of w that begin in one Ln -block, including w 's that end in the next block, while the analogous count in Boshernitzan's paper only allows for w that are contained in an Ln -block. This difference will be needed to prove Lemma 3.8, but may be regarded as technical on first reading.

3.2. Disjoint Density of Measures. Consider an infinite $\mathcal{J} \subseteq \mathbb{N}$ and corresponding sequence of words $(w^{(n)})_{n \in \mathcal{J}}$ where $|w^{(n)}| = n$ for each $n \in \mathcal{J}$. Suppose $w^{(n)} \rightarrow \mu$ as $\mathcal{J} \ni n \rightarrow \infty$ in the sense of Definition 2.3 and Remark 2.4. For $\nu \in \mathcal{E}(\Omega)$, let $x = x^{(\nu)}$ be the fixed generic point for ν from Definition 2.2.

Definition 3.4. For \mathcal{J} , $(w^{(n)})_{n \in \mathcal{J}}$, μ , x and ν above, the *disjoint (upper) L -density* of μ in ν is

$$\mathcal{D}_L(\mu, \nu) = \limsup_{\mathcal{J} \ni n \rightarrow \infty} \mathcal{D}_L(w^{(n)}, x).$$

Up to our change in definition from the original work, the proof of the next lemma is the same as for [1, Lemma 4.5].

Lemma 3.5. If for the notations in this section, $\beta := \mathcal{D}_L(\mu, \nu) > 0$ for some $L \in \mathbb{N}$ then

$$\nu \geq \frac{\beta}{2L} \mu.$$

Proof. It suffices to show that

$$\nu([u]) \geq \frac{\beta}{2L} \mu([u])$$

for an arbitrary fixed $u \in \mathcal{A}^*$ such that $\mu([u]) > 0$. Fix $\varepsilon > 0$ such that $\varepsilon < \min\{\mu([u]), \beta/2\}$, and choose M_0 so that

$$\nu([u]) \geq \frac{1}{M} \#_u(x_{[1,M]}) - \varepsilon$$

for all $M \geq M_0$. Choose $n \in \mathcal{J}$ so that

$$\frac{\#_u(w^{(n)})}{n} \geq \mu([u]) - \varepsilon.$$

Finally, choose N so that $NLn > M_0$, $N\varepsilon \geq 1$ and

$$\mathcal{D}_{L,N}(w^{(n)}, x) = \frac{1}{N} \mathcal{S}_{L,N}(w^{(n)}, x) \geq \beta - \varepsilon.$$

It is possible that u may occur in an overlap of at most two occurrences of $w^{(n)}$ beginning in adjacent nL blocks in x . Therefore by excluding the possible occurrence of $w^{(n)}$ in the final nL block,

$$\#_u(x_{[1, nLn]}) \geq \frac{1}{2}(\mathcal{S}_{L,N}(w^{(n)}, x) - 1) \cdot \#_u(w^{(n)}).$$

It follows that

$$\begin{aligned} \nu([u]) &\geq \frac{1}{nLn} \#_u(x_{[1, nLn]}) - \varepsilon \\ &\geq \frac{\#_u(w^{(n)})}{2nLn} (\mathcal{S}_{L,N}(w^{(n)}, x) - 1) - \varepsilon \\ &\geq \frac{1}{2L} \frac{\#_u(w^{(n)})}{n} \left(\frac{\mathcal{S}_{L,N}(w^{(n)}, x)}{N} - \frac{1}{N} \right) - \varepsilon \\ &\geq \frac{1}{2L} (\mu([u]) - \varepsilon) (\beta - 2\varepsilon) - \varepsilon. \end{aligned}$$

By letting $\varepsilon \rightarrow 0$, we arrive at the desired inequality. \square

The following is a direct consequence of the previous lemma and Remark 2.1.

Corollary 3.6. *If the conditions of Lemma 3.5 hold and ν is ergodic, then $\nu = \mu$.*

3.3. Relationships Between Densities. In this section, we derive some counting tools to work with densities. The main one is Lemma 3.8, which implies that if a word u appears with a positive frequency in a sequence x , and each occurrence of u is associated with an occurrence of a word w (and the distance between u and w is not too large), then w also occurs in x with a positive frequency. We note that the simpler result in Lemma 3.7 is a special case of Lemma 3.8 and can be replaced without ultimately affecting any results in this work. However, Lemma 3.7 has a better lower bound when it applies. Furthermore, the statement and proof of Lemma 3.7 are both easier to read and so we include the result to aid in the understanding of the more technical result that follows.

Lemma 3.7. *If u is a subword of w , then*

$$\mathcal{D}_L(u, x) \geq \frac{|u|}{2|w|} \mathcal{D}_L(w, x).$$

Proof. Let $\mathcal{S}_N = \mathcal{S}_{L,N}(w, x)$, $\mathcal{S}'_N = \mathcal{S}_{L,N}(u, x)$, $m = |u|$ and $n = |w|$. It follows from Remark 3.2 that

$$\mathcal{D}_L(w, x) = \limsup_{N \rightarrow \infty} \frac{1}{mN} \mathcal{S}_{mN} \text{ and } \mathcal{D}_L(u, x) = \limsup_{N \rightarrow \infty} \frac{1}{nN} \mathcal{S}'_{nN}.$$

It then suffices to show that for any N ,

$$\mathcal{S}'_{nN} \geq \frac{1}{2}(\mathcal{S}_{mN} - 1).$$

For any N , fix the prefix block $y = x_{[1, mnLN]}$ of length $mnLN$ in x . If w begins at position p in y , then u must begin at position $p + q - 1$, where u begins at position q in w . For simplicity, only consider the first occurrence of u in w if necessary. If an occurrence of w begins in the last nL block, it is possible that the related occurrence of u does not begin in y . However, for any other occurrence of w , the associated occurrence of u must begin in y . Also, it is possible for w to begin in two consecutive nL blocks in y , while their corresponding beginnings of u occur in the same mL block. Therefore, it is possible to have at most two occurrences of w in nL blocks produce at least one occurrence of u in a mL block.

In the prefix block y , we are considering mN blocks of size nL and nN blocks of size mL . We conclude the claim and therefore the proof, as \mathcal{S}_{mN} counts the nL blocks in which w begins and \mathcal{S}'_{nN} counts the mL blocks in which u begins. \square

Lemma 3.8. *Let $w, u \in \mathcal{A}^*$, $x \in \mathcal{A}^{\mathbb{N}}$ and $p_0, c \in \mathbb{N}$. If for every occurrence of w beginning at position $p > p_0$ in x there exists an occurrence of u beginning at position p' in x where $|p - p'| \leq c$, then for any $L \in \mathbb{N}$*

$$\mathcal{D}_L(u, x) \geq C(u, w, c, L)\mathcal{D}_L(w, x),$$

where

$$C(u, w, c, L) = \begin{cases} \frac{|u|}{3|w|+3c/L}, & \text{if } |u| \leq |w|, \\ \frac{L}{3} \frac{1}{3L+6\frac{c}{|u|}}, & \text{if } |u| > |w| \end{cases}.$$

Remark 3.9. *In the case that $c = \alpha|w|$ for a real constant α , then when $|u| \leq |w|$, $\mathcal{D}_L(u, x) \geq C' \frac{|u|}{|w|} \mathcal{D}_L(w, x)$ for some constant $C' = C'(\alpha, L)$. What is more interesting is that $\mathcal{D}_L(u, x) \geq C'' \mathcal{D}_L(w, x)$ for $C'' = C''(\alpha, L)$ when $|u| > |w|$, even when u is significantly longer than w .*

Proof of Lemma 3.8. Fix L , and let $\mathcal{S}_N = \mathcal{S}_{L,N}(w, x)$, $\mathcal{S}'_N = \mathcal{S}'_{L,N}(u, x)$, $m = |u|$ and $n = |w|$ as in the last proof. Let $\hat{c} = 3\lceil \frac{c}{Ln} \rceil$ and $\hat{L} = \hat{c}mnL$, noting that these are each positive as $c, n, m, L \geq 1$. We consider two cases: $m \leq n$ and $m > n$.

If $m \leq n$, consider the prefix block $y = x_{[1, N\hat{L}]}$. For $1 \leq d \leq \hat{c}$, let

$$\mathcal{S}_{\hat{c}mN}(d) = \sum_{\substack{j=1 \\ j \equiv d \pmod{\hat{c}}}}^{\hat{c}mN} r_L(w, x, j),$$

noting that $\mathcal{S}_{\hat{c}mN} = \sum_{d=0}^{\hat{c}-1} \mathcal{S}_{\hat{c}mN}(d)$. Pick a d such that

$$\mathcal{S}_{\hat{c}mN}(d) \geq \frac{1}{\hat{c}} \mathcal{S}_{\hat{c}mN}.$$

For the occurrences of w that contribute to $\mathcal{S}_{\hat{c}mN}(d)$, at most one may fail to contribute an occurrence of u in an mL block due to truncation³ and $\lceil \frac{p_0}{nL\hat{c}} \rceil$ initial occurrences may not have an associated occurrence of u . Note that this quantity is at least one as $p_0 \geq 1$. However, by our choices, all other occurrences must uniquely associate to an occurrence of u beginning in a block of length mL in y . Therefore

$$\mathcal{S}'_{\hat{c}nN} \geq \mathcal{S}_{\hat{c}mN}(d) - \left\lceil \frac{p_0}{\hat{c}nL} \right\rceil - 1 \geq \frac{1}{\hat{c}} \mathcal{S}_{\hat{c}mN} - 2 \left\lceil \frac{p_0}{\hat{c}nL} \right\rceil.$$

In this case, $\mathcal{D}_L(u, x) \geq \frac{m}{\hat{c}n} \mathcal{D}_L(w, x)$ by Remark 3.2, as the subtracted term above is constant with respect to $N \rightarrow \infty$. Furthermore, $\frac{m}{\hat{c}n} > \frac{m}{3n+3c/L}$.

If instead $m > n$, let $\hat{b} = \lceil \frac{2Lm}{Ln(1+2\hat{c})} \rceil$, where we leave L in the expression for future calculations. We consider prefix word y in x of length $\hat{b}\hat{c}nmLN$ for $N \in \mathbb{N}$. By dividing $\mathcal{S}_{\hat{b}\hat{c}mN}$ into $\hat{b}\hat{c}$ sums, we arrive at

$$\mathcal{S}'_{\hat{b}\hat{c}nN} \geq \frac{1}{\hat{b}\hat{c}} \mathcal{S}_{\hat{b}\hat{c}mN} - 2 \left\lceil \frac{p_0}{\hat{b}\hat{c}nL} \right\rceil$$

³If $d = \hat{c}$, an occurrence of w in the last nL -block may fail to produce an occurrence of u in y .

through a similar argument to the $m \leq n$ case. So $\mathcal{D}_L(u, x) \geq \frac{m}{n\hat{c}}\mathcal{D}_L(w, x)$. Note

$$\frac{3c}{Ln} \leq \hat{c} \Rightarrow \hat{b} \leq \frac{2Lm}{Ln(1+2\hat{c})} + 1 \leq \frac{2Lm}{Ln+6c} + 1 = \frac{2Lm+Ln+6c}{Ln+6c}.$$

Combining this with the bound $\hat{c} \leq \frac{3c}{Ln} + 3 = \frac{3c+3Ln}{Ln}$, we see that

$$\begin{aligned} \frac{m}{n\hat{c}} &\geq \frac{m}{n} \cdot \frac{Ln+6c}{2Lm+Ln+6c} \cdot \frac{Ln}{3c+3Ln} \\ &= \frac{Ln}{n} \cdot \frac{Ln+6c}{3Ln+3c} \cdot \frac{m}{2Lm+Ln+6c} \\ &\geq \frac{L}{1} \cdot \frac{1}{3} \cdot \frac{1}{2L+L\frac{1}{m}+6\frac{c}{m}} \\ &\geq \frac{L}{3} \frac{1}{3L+6\frac{c}{m}}. \end{aligned}$$

We have proven the result in both cases. \square

Lemma 3.10. *Suppose for $v, \tilde{v} \in \mathcal{A}^*$ the following relationships hold for $a, b \in \mathbb{N}$:*

- (1) $|\tilde{v}| = |v| + ab$,
- (2) for each $j = 0, \dots, b$, v begins at position $1 + ja$ in \tilde{v} , and
- (3) each occurrence of v in x is contained in an occurrence of \tilde{v} .

Then

$$\mathcal{D}_L(v, x) \geq \frac{1}{4L + 8\frac{a}{|v|}}\mathcal{D}_L(\tilde{v}, x) \text{ and } \mathcal{D}_L(\tilde{v}, x) \geq \frac{1}{27}\mathcal{D}_L(v, x).$$

Proof. If we let $w = v$ and $u = \tilde{v}$, then

$$\mathcal{D}_L(\tilde{v}, x) \geq \frac{1}{27}\mathcal{D}_L(v, x)$$

with $c = L|\tilde{v}|$, from Lemma 3.8.

If $|\tilde{v}| \leq 2|v|$, then

$$\mathcal{D}_L(v, x) \geq \frac{1}{4}\mathcal{D}_L(\tilde{v}, x)$$

from Lemma 3.7 with $u = v$ and $w = \tilde{v}$.

Now suppose $|\tilde{v}| > 2|v|$. For fixed N , consider the first $NLmn$ block of x , $y = x_{[1, NLmn]}$ where $m = |v|$ and $n = |\tilde{v}|$. If \tilde{v} occurs in any Ln block but the last, then at least $\lfloor b/\hat{a} \rfloor$ occurrences of v begin in disjoint Lm blocks in y , where

$$\hat{a} = \left\lceil \frac{Lm}{a} \right\rceil + 1.$$

As in the last two lemmas, occurrences in Ln blocks of \tilde{v} can overlap at most in pairs. Therefore

$$\mathcal{S}_{Nn} \geq \frac{b}{2\hat{a}}(\tilde{\mathcal{S}}_{Nn} - 1)$$

where $\mathcal{S}_{Nn} = \mathcal{S}_{L, Nn}(v, x)$ and $\tilde{\mathcal{S}}_{Nn} = \mathcal{S}_{L, Nn}(\tilde{v}, x)$. We see that $\mathcal{D}_L(v, x) \geq \frac{bm}{2\hat{a}n}\mathcal{D}_L(\tilde{v}, x)$. Noting that

$$\hat{a} \leq \frac{Lm+2a}{a}, \quad \frac{m}{n} < \frac{1}{2}, \quad \text{and } ab = n - m,$$

we conclude that

$$\begin{aligned} \frac{bm}{2\hat{a}n} &\geq \frac{abm}{2Lmn+4an} \\ &= \frac{nm-m^2}{2Lmn+4an} \\ &= \frac{1-\frac{m}{n}}{2L+4\frac{a}{m}} \\ &> \frac{1}{4L+8\frac{a}{m}} \end{aligned}$$

leaving the proof to end in a similar fashion to those in this section. \square

Corollary 3.11. *Under the conditions of Lemma 3.10 with $a < \alpha|v|$ for $\alpha > 0$,*

$$\mathcal{D}_L(v, x) \geq \frac{1}{4L+8\alpha} \mathcal{D}_L(\tilde{v}, x) \text{ and } \mathcal{D}_L(\tilde{v}, x) \geq \frac{1}{27} \mathcal{D}_L(v, x).$$

4. COLORING SPECIAL RAUZY GRAPHS

4.1. Choosing $\mathcal{J} \subseteq \mathbb{N}$. For minimal aperiodic Ω on finite \mathcal{A} , consider the special Rauzy graphs $\Gamma^{\text{Spec}}(n)$ for all $n \in \mathbb{N}$ with $K_{\mathfrak{s}}(n)$ the number of \mathfrak{s} -special vertices in each $\Gamma^{\text{Spec}}(n)$. For Ω satisfying (1), we choose an infinite subset $\mathcal{J}_0 \subseteq \mathbb{N}$ so that for $\mathfrak{s} \in \{\ell, r\}$, $K_{\mathfrak{s}} \equiv K_{\mathfrak{s}}(n)$ is constant for all $n \in \mathcal{J}_0$. As there is a finite number of special Rauzy graphs for a given (K_{ℓ}, K_r) , we choose infinite $\mathcal{J}'_0 \subset \mathcal{J}_0$ so that each (unweighted) $\Gamma^{\text{Spec}}(n)$ is equivalent for all $n \in \mathcal{J}'_0$. Call this common graph Λ . Fix a naming of the vertices in Λ and let $w^{(n)}$ denote the vertex in $\Gamma^{\text{Spec}}(n)$ associated to w in Λ for all $n \in \mathcal{J}'_0$. We then arrive at infinite $\mathcal{J} \subset \mathcal{J}'_0$ with $w^{(n)} \rightarrow \mu_w$ as $\mathcal{J} \ni n \rightarrow \infty$, as described in Section 3.2, for each $w \in \Lambda$. As such a \mathcal{J} may always be realized, we will state the desired properties as a standing assumption.

Assumption 4.1. Consider aperiodic minimal Ω with constant complexity growth K as in (1) for all $n \geq N_0$. We fix an infinite $\mathcal{J} \subseteq \mathbb{N}$, integers $K_{\ell}, K_r \leq K$, an unweighted special Rauzy graph Λ , and measures μ_w , $w \in \Lambda$, so that

- (a) $K_{\mathfrak{s}}(n) = K_{\mathfrak{s}}$ for all $n \in \mathcal{J}$, $\mathfrak{s} \in \{\ell, r\}$,
- (b) $\Gamma^{\text{Spec}}(n) \equiv \Lambda$ for all $n \in \mathcal{J}$, and
- (c) $w^{(n)} \rightarrow \mu_w$ as $\mathcal{J} \ni n \rightarrow \infty$, for each $w \in \Lambda$.

4.2. Marking Λ with $\mathcal{E}(\Omega)$. We use the following result from [1], which we apply to our current work.

Lemma 4.2. *Assume 4.1 with corresponding notation. Let $\nu \in \mathcal{E}(\Omega)$ and set $L = K + 1$. For each $\mathfrak{s} \in \{\ell, r\}$ there exists an \mathfrak{s} -special vertex $w \in \Lambda$ such that*

$$\mathcal{D}_L(\mu_w, \nu) \geq \frac{1}{K_{\mathfrak{s}}}.$$

Corollary 4.3. *If Ω satisfies Assumption 4.1, then $\#\mathcal{E}(\Omega) \leq \min\{K_{\ell}, K_r\}$.*

Proof. By Corollary 3.6, for each $\nu \in \mathcal{E}(\Omega)$ there are left special $u \in \Lambda$ and right special $v \in \Lambda$ with $\nu = \mu_u = \mu_v$. Thus $\#\mathcal{E}(\Omega)$ is bounded above by the number of left special vertices and by the number of right special vertices. \square

Definition 4.4. Under Assumption 4.1, we *mark* (or “*color*”) a vertex $w \in \Lambda$ with $\nu \in \mathcal{E}(\Omega)$ if and only if

$$\mathcal{D}_L(\mu_w, \nu) > 0.$$

The notation $\mathcal{C}(w) = \nu$ means “ w in Λ is marked by ν ” and $\mathcal{C}(w) = \mathbf{0}$ if we do not mark w .

By Corollary 3.6, $\mathcal{C}(w) = \nu$ implies $\nu = \mu_w$. So for each $w \in \Lambda$ there may be at most one $\nu \in \mathcal{E}(\Omega)$ that colors it and the above function is well-defined.

Remark 4.5. *For the remainder of the paper, whenever Assumption 4.1 holds we will always set $L = K + 1$ and therefore will suppress it in notation for \mathcal{D} .*

Proposition 4.6. *Let \mathcal{J} satisfy Assumption 4.1 with graph Λ for Ω . Our coloring relation \mathcal{C} must satisfy the following rules:*

- (i) *For each $\nu \in \mathcal{E}(\Omega)$, there must exist a left special vertex u and right special vertex v of Λ so that $\mathcal{C}(u) = \mathcal{C}(v) = \nu$.*
- (ii) *If v is a right special vertex in Λ and $\mathcal{C}(v) = \nu$ then $\mathcal{C}(w) = \mathcal{C}(v)$ for the unique w with $w \rightarrow v$ in Λ . There is a vertex w' with $v \rightarrow w'$ in Λ and $\mathcal{C}(w') = \mathcal{C}(v)$.*
- (iii) *If u is a left special vertex in Λ and $\mathcal{C}(u) = \nu$ then $\mathcal{C}(w) = \mathcal{C}(u)$ for the unique w with $u \rightarrow w$ in Λ . There is a vertex w' with $w' \rightarrow u$ in Λ and $\mathcal{C}(w') = \mathcal{C}(u)$.*

Proof. (i) is simply a restatement of Lemma 4.2 using the notation here. We will prove (ii) as (iii) has a similar proof.

Recall the fixed $x = x^{(\nu)} \in \Omega$ that is generic for ν from Definition 2.2. For each $n \in \mathcal{J}$, $w^{(n)}$ occurs at most distance Ln to the left of $v^{(n)}$. By Lemma 3.8, $\mathcal{D}(w^{(n)}, x) \geq \frac{1}{6}\mathcal{D}(v^{(n)}, x)$. As we assume that $\limsup_{\mathcal{J} \ni n \rightarrow \infty} \mathcal{D}(v^{(n)}, x) > 0$, it follows that

$$\mathcal{D}(\mu_w, \nu) \geq \frac{1}{6}\mathcal{D}(\mu_v, \nu) > 0,$$

giving $\mathcal{C}(w) = \nu$.

Let $y^{(1)}, y^{(2)}, \dots, y^{(m)}$ be the vertices such that $v \rightarrow y^{(j)}$ in Λ for each $1 \leq j \leq m$, where m is the total number of edges emanating from v in Λ . By equation (6), $m \leq K + 1$. Choose an infinite subset $\mathcal{J}' \subseteq \mathcal{J}$ so that

$$\lim_{\mathcal{J}' \ni n \rightarrow \infty} \mathcal{D}(v^{(n)}, x) = \mathcal{D}(\mu_v, \nu).$$

Fix $n \in \mathcal{J}'$. For each occurrence of $v^{(n)}$ in x , a word $y^{(j,n)}$ for some $j \in \{1, \dots, m\}$ must occur at most Ln distance to the right of $v^{(n)}$. By similar reasoning to the proof of Lemma 3.8,

$$\sum_{j=1}^m \mathcal{D}(y^{(j,n)}, x) \geq \frac{1}{2}\mathcal{D}(v^{(n)}, x).$$

Therefore, there exists $j_n \in \{1, \dots, m\}$ with

$$\mathcal{D}(y^{(j_n,n)}, x) \geq \frac{1}{2m}\mathcal{D}(v^{(n)}, x).$$

Choose an infinite $\mathcal{J}'' \subseteq \mathcal{J}'$ so that for some $j \in \{1, \dots, m\}$, $j_n = j$ for all $n \in \mathcal{J}''$. If $w' = y^{(j)}$, then

$$\begin{aligned} \mathcal{D}(\mu_{w'}, \nu) &\geq \limsup_{\mathcal{J}'' \ni n \rightarrow \infty} \mathcal{D}(y^{(j,n)}, x) \\ &\geq \frac{1}{2m} \lim_{\mathcal{J}'' \ni n \rightarrow \infty} \mathcal{D}(v^{(n)}, x) \\ &\geq \frac{1}{2(K+1)} \mathcal{D}(\mu_v, \nu) \\ &> 0, \end{aligned}$$

or $\mathcal{C}(w') = \nu$. □

Corollary 4.7. *For each $\nu \in \mathcal{E}(\Omega)$ and Λ from Assumption 4.1, the set $\mathfrak{C}(\nu)$ must contain a bispecial edge $u \rightarrow v$, meaning u is left special and v is right special. In particular, $\#\mathcal{E}(\Omega)$ is bounded by the number of bispecial edges.*

Definition 4.8. Under Assumption 4.1 with coloring function \mathcal{C} on Λ , let

$$\mathfrak{C}(\nu) = \mathcal{C}^{-1}(\nu)$$

be the *preimage* of \mathcal{C} for $\nu \in \mathcal{E}(\Omega)$; that is, the set of vertices $w \in \Lambda$ such that $\mathcal{C}(w) = \nu$. Likewise, let $\mathfrak{C}(\mathbf{0})$ denote all vertices in Λ that are not colored by \mathcal{C} .

Corollary 4.9. *If Ω satisfies Assumption 4.1, has constant complexity growth K as in equation (1) and either of the following hold:*

- (i) *there exists $\nu \in \mathcal{E}(\Omega)$ so that $\#\mathfrak{C}(\nu) > 4$, or*
- (ii) *$\#\mathfrak{C}(\mathbf{0}) \geq 3$,*

then $\#\mathcal{E}(\Omega) \leq K - 2$.

Proof. By definition, the sets $\mathfrak{C}(\mathbf{0})$ and $\mathfrak{C}(\nu)$ for $\nu \in \mathcal{E}(\Omega)$ partition vertices of Λ , and the number of vertices is bounded by $2K$. Let $E = \#\mathcal{E}(\Omega)$.

We first assume (i). By Proposition 4.6, $\#\mathfrak{C}(\nu) \geq 2$ for each $\nu \in \mathcal{E}(\Omega)$. If $\nu_0 \in \mathcal{E}(\Omega)$ has $\#\mathfrak{C}(\nu_0) \geq 5$, then

$$2(E - 1) \leq \sum_{\mathcal{E}(\Omega) \ni \nu \neq \nu_0} \#\mathfrak{C}(\nu) \leq 2K - \#\mathfrak{C}(\nu_0) \leq 2K - 5.$$

Thus $E \leq K - 2$ since E is an integer.

We now assume (ii). Recall that $K_{\mathfrak{s}}$, the number of \mathfrak{s} -special vertices in Λ , is bounded by K . Also, if $\mathfrak{C}_{\mathfrak{s}}$ represents \mathfrak{C} restricted to only \mathfrak{s} -special vertices, then by Proposition 4.6, $\#\mathfrak{C}_{\mathfrak{s}}(\nu) \geq 1$ for all $\nu \in \mathcal{E}(\Omega)$. Because $\#\mathfrak{C}(\mathbf{0}) \geq 3$ by assumption, there exists $\mathfrak{s} \in \{\ell, r\}$ so that $\#\mathfrak{C}_{\mathfrak{s}}(\mathbf{0}) \geq 2$. For this \mathfrak{s} ,

$$E \leq \sum_{\nu \in \mathcal{E}(\Omega)} \#\mathfrak{C}_{\mathfrak{s}}(\nu) \leq K - \#\mathfrak{C}_{\mathfrak{s}}(\mathbf{0}) \leq K - 2,$$

as desired. □

5. BISPECIAL MOVES

5.1. Bispecial Words from $\Gamma(n)$ to $\Gamma(n + 1)$. For a language \mathcal{L} satisfying the binary extension condition, we now consider the types of bispecial words described in Section 2.4 and explore the appropriate transition from Rauzy graph $\Gamma(n)$ to Rauzy graph $\Gamma(n + 1)$. For a bispecial $w \in \mathcal{L}(n)$, let $a, a', b, b' \in \mathcal{A}$, $a \neq a'$ and $b \neq b'$, be the letters such that $aw, a'w, wb, wb' \in \mathcal{L}(n + 1)$.

- If w is *weak bispecial*, the set of two-way extensions $\text{Ext}_{\ell r}(w)$ consists of exactly two words, awb and $a'wb'$, up to appropriate naming of a, a', b, b' . The transition about w from $\Gamma(n)$ to $\Gamma(n + 1)$ is given in Figure 1(a).
- If w is *strong bispecial*, then $awb, awb', a'wb, a'wb' \in \mathcal{L}$. In particular, both aw and $a'w$ are right special while both wb and wb' are left special. The transition from n to $n + 1$ is given in Figure 1(c).
- If w is *regular bispecial*, then $awb, awb', a'wb \in \mathcal{L}$ and $a'wb' \notin \mathcal{L}$, up to renaming the letters. See Figure 1(b) for the transition.

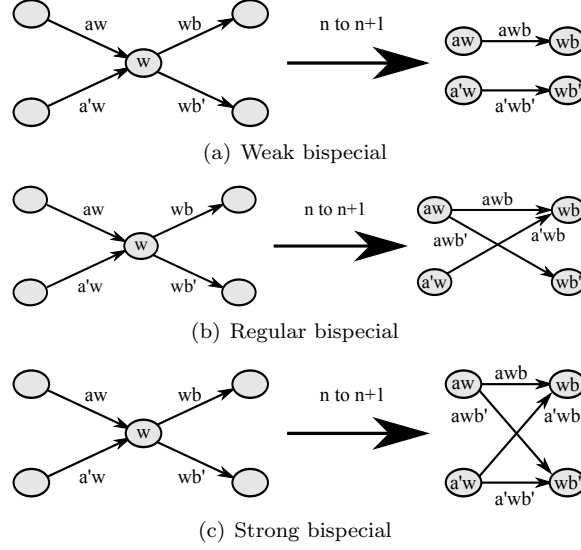

FIGURE 1. The three types of bispecial moves on w from Rauzy graph $\Gamma(n)$ to Rauzy graph $\Gamma(n+1)$.

Naturally, we would like to describe the transition for the other words in $\mathcal{L}(n)$. If v is right (and not left) special, then its unique left extension av is also right special. Likewise if u is left (and not right) special, then its unique right extension ub is also left special. If w is not special, then its left extension aw is not right special and its right extension wb is not left special. We conclude that a unispecial word in $\mathcal{L}(n)$ associates uniquely to a unispecial word in $\mathcal{L}(n+1)$. However, a bispecial word in $\mathcal{L}(n)$ may associate to zero, one or two special words of each type in $\mathcal{L}(n+1)$, depending on the nature of the bispecial word. Furthermore, all special words in $\mathcal{L}(n+1)$ must be associated to special words in $\mathcal{L}(n)$ as described here.

Remark 5.1. *If \mathcal{L} does not satisfy the binary extension condition, then most of the observations in this section still hold. In particular, there remains a well-defined association between special words in $\mathcal{L}(n+1)$ and those in $\mathcal{L}(n)$. The behavior of a bispecial word w will vary depending on the nature of $\text{Ext}_{\ell_r}(w)$. However, there are many possible outcomes. For example, if $w \in \mathcal{L}$ is bispecial such that $aw, wb \in \mathcal{L}$ for all $a, b \in \mathcal{A}$, where $\#\mathcal{A} > 2$, then*

$$\#\mathcal{A} \leq \#\text{Ext}_{\ell_r}(w) \leq (\#\mathcal{A})^2.$$

To further complicate matters, the local transition from $\Gamma(n)$ to $\Gamma(n+1)$ is no longer uniquely determined by the value $\#\text{Ext}_{\ell_r}(w)$. This is why we typically consider \mathcal{L} with the binary extension condition in detail for the rest of the paper and end with discussions for more general languages.

5.2. From $\Gamma^{\text{Spec}}(n)$ to $\Gamma^{\text{Spec}}(n+1)$. Now consider the transition from special Rauzy graph $\Gamma^{\text{Spec}}(n)$ to special Rauzy graph $\Gamma^{\text{Spec}}(n+1)$. If w is a unispecial vertex in $\Gamma^{\text{Spec}}(n)$, then we name w in $\Gamma^{\text{Spec}}(n+1)$ its unique special extension. We see that we only need to consider bispecial words of length n in order to determine the structure of $\Gamma^{\text{Spec}}(n+1)$ given $\Gamma^{\text{Spec}}(n)$. Before we do so, we will briefly note

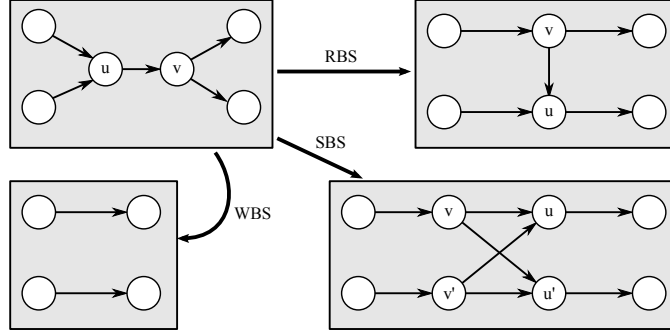

FIGURE 2. The three types of bispecial moves from $\Gamma^{\text{Spec}}(n)$ to $\Gamma^{\text{Spec}}(n+1)$ about bispecial word $u = v$. The outer four vertices represent the attached vertices in the respective special graphs.

the relationship between $\rho_n(w \rightarrow w')$, the weight of edge $w \rightarrow w'$ in $\Gamma^{\text{Spec}}(n)$, and $\rho_{n+1}(w \rightarrow w')$ when both w and w' are unispecial.

- If w and w' are either both left special or both right special, then

$$\rho_{n+1}(w \rightarrow w') = \rho_n(w \rightarrow w').$$

- If w is right special and w' is left special, then

$$\rho_{n+1}(w \rightarrow w') = \rho_n(w \rightarrow w') + 1.$$

- If w is left special and w' is right special; that is, $w \rightarrow w'$ is a bispecial edge, then

$$\rho_{n+1}(w \rightarrow w') = \rho_n(w \rightarrow w') - 1.$$

It follows that if $\Gamma^{\text{Spec}}(n)$ has no edges of weight 0 (or equivalently, there are no bispecial words in $\mathcal{L}(n)$), then $\Gamma^{\text{Spec}}(n+1) \equiv \Gamma^{\text{Spec}}(n)$, and only the bispecial edges decrease in weight. In fact, the special graphs will remain equivalent until a bispecial edge decreases to weight 0 and is associated to a bispecial word in \mathcal{L} .

We begin by assuming that \mathcal{L} has the binary extension condition for N_0 and $n \geq N_0$. For now, assume that w is the only bispecial word of length n . Recall that w is actually represented by two vertices u and v in $\Gamma^{\text{Spec}}(n)$, where u is left special while v is right special.

If w is strong bispecial, then there are four vertices in $\Gamma^{\text{Spec}}(n+1)$ associated to w . We denote the left extensions (which are *right special*) as v and v' , where the choice between the two will be made when needed. Likewise, we name the right extensions by u and u' , as they are the resulting left special vertices from the transition. We call this change a *strong bispecial (SBS) move* on edge $u \rightarrow v$.

If instead w is regular bispecial, then we name the unique right extension that is left special u in $\Gamma^{\text{Spec}}(n+1)$ and we name the unique left extension that is right special v . Note in this case that the other extensions are not vertices in $\Gamma^{\text{Spec}}(n+1)$. We call this change a *regular bispecial (RBS) move* on edge $u \rightarrow v$.

If w is weak bispecial, then no extensions will be vertices in $\Gamma^{\text{Spec}}(n+1)$. In this case, the surrounding associated special words will be connected by edges directly. We call this change a *weak bispecial (WBS) move* on edge $u \rightarrow v$.

Each possible move is given in Figure 2. These moves are all illustrated in Figures 1(a)– 1(c). Often, multiple bispecial words exist of a given length n . The following

lemma tells us that we may realize the transition from $\Gamma^{\text{Spec}}(n)$ to $\Gamma^{\text{Spec}}(n+1)$ (as unweighted graphs) by applying each individual bispecial move one at a time, in any order we choose. While the weights are not claimed to be given by this realization (see Remark 5.3), the difference will not affect the coloring from one graph to the next as discussed in the next section.

Lemma 5.2. *If $u^{(j)} \rightarrow v^{(j)}$, $1 \leq j \leq m$, are the edges in $\Gamma^{\text{Spec}}(n)$ representing the bispecial words $w^{(1)}, \dots, w^{(m)}$ of length n , then the (unweighted) graph $\Gamma^{\text{Spec}}(n+1)$ is obtained by applying the associated bispecial move on each edge $u^{(j)} \rightarrow v^{(j)}$ one at a time in the order $j = 1, \dots, m$.*

Proof. Let $\mathcal{A}_1 = \mathcal{L}(n)$ and $\pi_n : \mathcal{A}^* \rightarrow \mathcal{A}_1^*$ be given by $\pi_n(w) = \epsilon$ (the empty word) if $|w| < n$ and

$$(\pi_n(w))_i = w_{[i, i+n-1]} \text{ for } 1 \leq i \leq |w| - n + 1$$

if $|w| \geq n$. Then $\mathcal{L}_1 = \pi_n(\mathcal{L})$ is well-defined and π_n is an isomorphism from $\Gamma(k+n-1)$ to $\Gamma_1(k)$ (the Rauzy graph given by \mathcal{L}_1) for each $k \geq 1$. This implies that $\Gamma_1^{\text{Spec}}(k) \equiv \Gamma^{\text{Spec}}(k+n-1)$ for all $k \geq 1$, with equal edge weights.

Let $m_{\mathfrak{s}} \geq m$, $\mathfrak{s} \in \{\ell, r\}$, be the number of \mathfrak{s} -special elements in $\mathcal{L}_1(1)$. Order the left special words of $\mathcal{L}_1(1)$ as $U^{(1)}, \dots, U^{(m_{\ell})}$ and the right special words as $V^{(1)}, \dots, V^{(m_r)}$ so that $W^{(j)} := U^{(j)} = V^{(j)}$ is the image of $w^{(j)}$ by π_n , $1 \leq j \leq m$. If

$$f(j) = \begin{cases} 2m + j, & 1 \leq j \leq m, \\ 7m, & m < j, \end{cases}$$

for $1 \leq j \leq m_{\ell}$ and $1 \leq i \leq f(j)$, let x_j^i be distinct letters that do not belong to \mathcal{A}_1 . Likewise, for $1 \leq j \leq m_r$ and $1 \leq i \leq f(j)$ let y_j^i be distinct letters that do not belong to \mathcal{A}_1 or equal to any of the x_j^i 's. Then let

$$\mathcal{A}_2 = \mathcal{A}_1 \cup \{x_j^i : 1 \leq j \leq m_{\ell}, 1 \leq i \leq f(j)\} \cup \{y_j^i : 1 \leq j \leq m_r, 1 \leq i \leq f(j)\}.$$

Define the substitution $\sigma : \mathcal{A}_1^* \rightarrow \mathcal{A}_2^*$ by the rule

$$\sigma(W) = \begin{cases} x_j^1 \dots x_j^{f(j)} W y_j^1 \dots y_j^{f(j)}, & W = W^{(j)}, 1 \leq j \leq m, \\ x_j^1 \dots x_j^{f(j)} W, & W = U^{(j)}, m < j \leq m_{\ell}, \\ W y_j^1 \dots y_j^{f(j)}, & W = V^{(j)}, m < j \leq m_r, \\ W, & \text{otherwise,} \end{cases}$$

for each $W \in \mathcal{L}_1(1)$ and extend by concatenation. Let \mathcal{L}_2 be the language generated by the image of \mathcal{L}_1 under σ , meaning $W' \in \mathcal{L}_2$ iff it is a subword of $\sigma(W)$ for some $W \in \mathcal{L}_1$.

Let $\Pi : \mathcal{L}_2 \rightarrow \mathcal{L}_1$ be defined as follows: $\Pi(W) = Y$ where Y is the unique word of minimal length so that W is a subword of $\sigma(Y)$. Therefore, for any proper subword Y' of $Y = \Pi(W)$,

$$|\sigma(Y')| < |W| \leq |\sigma(Y)|.$$

We make the following claims for W and $Y = \Pi(W)$:

- $W \in \mathcal{L}_2$ is left special iff W is a prefix of left special Y ,
- $W \in \mathcal{L}_2$ is right special iff W is a suffix of right special Y ,
- $W \in \mathcal{L}_2$ is bispecial iff $W = \sigma(Y)$ and Y is bispecial,
- for $1 \leq k \leq 6m + 1$, $W \in \mathcal{L}_2(k)$ is bispecial iff $Y = W^{(j)}$, $1 \leq j \leq m$ and $|W| = 4m + 2j + 1$.

It follows that $\Gamma_2^{\text{Spec}}(1) \equiv \Gamma_1^{\text{Spec}}(1) \equiv \Gamma^{\text{Spec}}(n)$ and for each $1 \leq j \leq m$, the change from $\Gamma_2^{\text{Spec}}(4m + 2j + 1)$ to $\Gamma_2^{\text{Spec}}(4m + 2j + 2)$ is realized by exactly one bispecial move and the move is by the to the one given by the edge $u^{(j)} \rightarrow v^{(j)}$ from the original special graph $\Gamma^{\text{Spec}}(n)$ to $\Gamma^{\text{Spec}}(n + 1)$.

We finish with the claim $\Gamma_2^{\text{Spec}}(6m + 2) \equiv \Gamma_1^{\text{Spec}}(2)$ as unweighted graphs. To do so, we define bijections $\Xi_{\mathfrak{s}}$, $\mathfrak{s} \in \{\ell, r\}$ that assigns to each \mathfrak{s} -special word in $\mathcal{L}_2(6m + 2)$ an \mathfrak{s} -special word in $\mathcal{L}_1(2)$. We fully and define Ξ_{ℓ} and prove its bijectivity, as the case for Ξ_r follows by analogy.

For left special $\tilde{U} \in \mathcal{L}_2(6m + 2)$, let $Y = Y_1 \dots Y_k = \Pi(\tilde{U})$. If $|Y| \geq 2$, let $\Xi_{\ell}(\tilde{U}) = Y_1 Y_2$. If $|Y| = 1$, then $Y = Y_1 = U^{(j)}$, $m < j \leq m_{\ell}$, as $|Y_1| \geq 6m + 2$. In particular, Y_1 is not right special and must admit a unique right extension $Y_1 Z_1$ that is also left special. In this case $\Xi_{\ell}(\tilde{U}) = Y_1 Z_1$.

We claim Ξ_{ℓ} is injective. Suppose $\Xi_{\ell}(\tilde{U}) = \Xi_{\ell}(\hat{U})$. If $|\Pi(\tilde{U})| \leq 2$, then it follows that $\Pi(\hat{U}) = \Pi(\tilde{U})$ and therefore $\tilde{U} = \hat{U}$. Suppose by contradiction that $\tilde{U} \neq \hat{U}$ and $\Pi(\tilde{U}) \neq \Pi(\hat{U})$ with $|\Pi(\tilde{U})|, |\Pi(\hat{U})| \geq 3$. If

$$\Pi(\tilde{U}) = Y_1 \dots Y_k \text{ and } \Pi(\hat{U}) = Y'_1 \dots Y'_{k'}$$

then there exists $2 \leq k_1 < k, k'$ so that $Y_1 \dots Y_{k_1} = Y'_1 \dots Y'_{k_1}$. However this implies that $Y_1 \dots Y_{k_1}$ is bispecial and in particular Y_{k_1} is right special. In this case

$$|\sigma(Y_1 \dots Y_{k_1})| = |\sigma(Y_1)| + |\sigma(Y_{k_1})| \geq 2[4m + 3] > 6m + 3,$$

contradicting the definition of $\Pi(\tilde{U})$.

We now show that Ξ_{ℓ} is surjective. Let $Y \in \mathcal{L}_1(2)$ be left special and consider its maximal unique right extension YZ . Because either Y is itself bispecial (and so $Z = \epsilon$, the empty word) or YZ is bispecial, it follows that YZ ends with a right special word. Therefore $|\sigma(YZ)| \geq 2[4m + 3] > 6m + 3$. If $U = \sigma(YZ)_{[1, 6m+2]}$, $\Pi(U)$ is a prefix of YZ and so $\Xi_{\ell}(U) = Y$.

The maps Ξ_{ℓ} and Ξ_r imply a bijection from edge words $W \rightarrow W' \in \Gamma_2^{\text{Spec}}(6m+2)$ to edge words $\Xi_{\mathfrak{s}}(W) \rightarrow \Xi_{\mathfrak{s}'} \in \Gamma_1^{\text{Spec}}(2)$, where W and W' are \mathfrak{s} -special and \mathfrak{s}' -special vertices respectively. \square

Remark 5.3. *While separating m simultaneous bispecial moves into m steps does not yield a graphs with equal edge weights, it may be shown that*

$$|\rho_2(W \rightarrow W') - \rho_1(\Xi_{\mathfrak{s}}(W) - \Xi_{\mathfrak{s}}(W'))| \leq 7m^2,$$

where these objects are defined in the previous proof. Here ρ_1 gives the edge weights for $\Gamma_1^{\text{Spec}}(2)$ and ρ_2 gives the edge weights for $\Gamma_2^{\text{Spec}}(6m + 2)$. For example, if $W \rightarrow W'$ is a bispecial edge, then $\rho_1(\Xi_{\ell}(W) \rightarrow \Xi_r(W'))$ is equal to $\rho_2(W \rightarrow W')$ minus the appearances of x_j^i 's and y_j^i 's in the edge word $W \rightarrow W'$. Because K bounds m , this difference is small for large n . Therefore, we may extend results such as Lemma 5.8 below, which addresses one bispecial move from $\Gamma^{\text{Spec}}(n)$ to $\Gamma^{\text{Spec}}(n + 1)$, to the case of simultaneous bispecial moves.

If \mathcal{L} does not satisfy the binary extension condition, the principles in this section still apply. For example, the special graphs $\Gamma^{\text{Spec}}(n)$ remain the same as n changes unless a bispecial edge's weight decreases to 0.

5.3. **Finding Λ' from Λ .** As indicated in the previous section,

$$\Gamma^{\text{Spec}}(n) \equiv \Gamma^{\text{Spec}}(n+1)$$

if no bispecial words of length n exist in $\mathcal{L}(n)$.

Definition 5.4. For fixed \mathcal{L} and any $n \in \mathbb{N}$, let the *next bispecial value* for n be

$$B_n^{\text{Sp}} := \min\{n' \geq n : \mathcal{L}(n') \text{ contains a bispecial word}\}.$$

We call the set of *bispecial values* for \mathcal{L}

$$B^{\text{Sp}} = \{B_n^{\text{Sp}} : n \in \mathbb{N}\}.$$

The number of *bispecial steps* from m to $m' > m$ is given by

$$\#(B^{\text{Sp}} \cap [m, m')).$$

Suppose we have \mathcal{J} with Λ from Assumption 4.1. For each $n \in \mathcal{J}$, let $n' = B_n^{\text{Sp}} + 1$. Then $\Gamma^{\text{Spec}}(\tilde{n}) \equiv \Lambda$ for $n \leq \tilde{n} < n'$ and $K_\ell(n'), K_r(n') \leq K$. We may therefore choose an infinite set \mathcal{J}' of such n' values and a special graph Λ' so that $\Gamma^{\text{Spec}}(n') \equiv \Lambda'$. Therefore \mathcal{J}' and Λ' satisfy Assumption 4.1 parts (a) and (b). By passing to another infinite subsequence, \mathcal{J}' will satisfy (c) as well. We will define a coloring function \mathcal{C}' on Λ' . Because we will want to relate \mathcal{C} on Λ to \mathcal{C}' on Λ' , we then reduce \mathcal{J} so that the map $n \mapsto B_n^{\text{Sp}} + 1$ is a bijection from \mathcal{J} to \mathcal{J}' .

Because we are replacing \mathcal{J} with a subset, it is possible that $\mathcal{C}(w)$ will now be $\mathbf{0}$ when it was initially $\nu \in \mathcal{E}(\Omega)$, as \mathcal{C} depends on \mathcal{J} . To prevent the loss of color when producing new subsequences, we amend Assumption 4.1 so that \mathcal{C} will be preserved when reducing \mathcal{J} .

Assumption 5.5. Consider Ω , \mathcal{J} , Λ , K_ℓ , K_r that satisfy Assumption 4.1. By replacing \mathcal{J} with a subsequence, the original conditions (a)–(c) from Assumption 4.1 hold and furthermore

- (d) For each $w \in \Lambda$ with representative $w^{(n)} \in \Gamma^{\text{Spec}}(n)$ for all $n \in \mathcal{J}$ and for each $\nu \in \mathcal{E}(\Omega)$,

$$\lim_{n \rightarrow \infty} \mathcal{D}(w^{(n)}, x) = \mathcal{D}(\mu_w, \nu)$$

where x is the generic point for ν from Definition 2.2.

In other words, because $\mathcal{D}(\mu_w, \nu) := \mathcal{D}_L(\mu_w, \mu)$ is defined via a limsup, it may now be realized as a limit. Under this new assumption, \mathcal{C} will not change if \mathcal{J} is ever restricted to a subset. Note that $\#\mathcal{E}(\Omega) < \infty$ under Assumption 4.1 by Corollary 4.7. Therefore, Assumption 5.5 may be used whenever Assumption 4.1 holds.

Definition 5.6. The new set \mathcal{J}' with corresponding data is the result of *one bispecial step* from \mathcal{J} . For any $M \in \mathbb{N}$, we may analogously define $\mathcal{J}^{(M)}$ that satisfies Assumption 5.5 and is the result of M *bispecial steps* from \mathcal{J} by choosing each $\mathcal{J}^{(m+1)}$ to be one bispecial step from $\mathcal{J}^{(m)}$ for each $m < M$.

Remark 5.7. As we shall see soon, it is possible to have $\Lambda' = \Lambda$ or even $\Lambda^{(M)} = \Lambda^{(M-1)} = \dots = \Lambda' = \Lambda$.

Lemma 5.8. Consider Ω with language \mathcal{L} satisfying the binary extension condition for N_0 . Suppose Λ is from Assumption 5.5 and Λ' is the result of one bispecial step. Let \mathcal{C} denote the marking function on Λ and \mathcal{C}' denote the marking function on Λ' .

- (i) If $w \in \Lambda$ is not an endpoint of an edge participating in a bispecial move, then $w \in \Lambda'$ and $\mathcal{C}(w) = \mathcal{C}'(w)$.
- (ii) Suppose $u \rightarrow v$ in Λ is changed by an SBS move with corresponding left special vertices u, u' and right special vertices v, v' in Λ' . Then

$$\{\mathcal{C}(u)\} \subseteq \{\mathcal{C}'(u), \mathcal{C}'(u')\} \subseteq \{\mathcal{C}(u), \mathbf{0}\}$$

and

$$\{\mathcal{C}(v)\} \subseteq \{\mathcal{C}'(v), \mathcal{C}'(v')\} \subseteq \{\mathcal{C}(v), \mathbf{0}\},$$

where we recall that $\mathcal{C}(v) = \mathcal{C}(u)$.

- (iii) Suppose $u \rightarrow v$ in Λ is changed by an RBS move to get u and v in Λ' . Then

$$\{\mathcal{C}(u)\} \subseteq \{\mathcal{C}'(u), \mathcal{C}'(v)\} \subseteq \{\mathcal{C}(u), \mathbf{0}\}.$$

- (iv) Suppose $u \rightarrow v$ in Λ is changed by a WBS move to Λ' . Then for the four vertices w_1, \dots, w_4 in Λ' that are connected by the edges made by $u \rightarrow v$ from Λ ,

$$\{\mathcal{C}(u)\} \subseteq \{\mathcal{C}'(w_1), \mathcal{C}'(w_2), \mathcal{C}'(w_3), \mathcal{C}'(w_4)\} \subseteq \{\mathcal{C}(u), \mathbf{0}\}.$$

Proof. Note that for any Ω satisfying equation (1) for $n \geq N_0$,

$$B_n^{\text{Sp}} - n < (K + 1)n$$

for all large enough n , as any bispecial edge in $\Gamma^{\text{Spec}}(n)$ has weight at most $p(n+1)$, the number of edges in Rauzy graph $\Gamma(n)$. Consider for a vertex $w \in \Lambda$ or $w \in \Lambda'$ the associated words $w^{(n)} \in \mathcal{L}(n)$ for $n \in \mathcal{J}$ and $w^{(n')} \in \mathcal{L}(n')$ for $n' \in \mathcal{J}$ as appropriate.

We will first prove (i). For large $n \in \mathcal{J}$ with $n' = (B_n^{\text{Sp}} + 1) \in \mathcal{J}'$ we apply Lemma 3.7 to see that because $w^{(n)}$ is a subword of $w^{(n')}$,

$$\mathcal{D}(\mu_w, \nu) \geq \frac{1}{2(K+1)} \mathcal{D}(\mu'_w, \nu),$$

where μ'_w is the measure associated to $w \in \Lambda'$ from Assumption 4.1. Likewise if we apply Lemma 3.8⁴ noting that $|w^{(n)}| < |w^{(n')}|$ with $c = Ln$ we have

$$\mathcal{D}(\mu'_w, \nu) \geq \frac{1}{27} \mathcal{D}(\mu_w, \nu).$$

Therefore $\mathcal{D}(\mu_w, \nu) > 0$ if and only if $\mathcal{D}(\mu'_w, \nu) > 0$ and so $\mathcal{C}(w) = \mathcal{C}'(w)$.

We show (ii) for the vertices u and u' , as the other relationship has a very similar proof. Furthermore, the proofs of (iii) and (iv) are similar so we omit them. We may again apply Lemma 3.7 to see that if $\mathcal{C}'(u) = \nu$ then $\mathcal{C}(u) = \nu$, as $u^{(n)}$ is a subword of $u^{(n')}$. Likewise, if $\mathcal{C}'(u') = \nu'$ then $\mathcal{C}(u) = \nu'$. Therefore, $\mathcal{C}'(u)$ and $\mathcal{C}'(u')$ may only take values in the set $\{\mathcal{C}(u), \mathbf{0}\}$.

Now suppose $\mathcal{C}(u) = \mathcal{C}(v) = \nu$. For each large n , let $w^{(1,n+1)}, w^{(2,n+1)} \in \mathcal{L}(n+1)$ be the right extensions of $v^{(n)}$. These may be uniquely extended to the left until length n' , and these are precisely the right extensions of bispecial word $u^{(n'-1)} = v^{(n'-1)}$; that is, the words in $\mathcal{L}(n')$ that relate to $u, u' \in \Lambda'$. Following the proof of Proposition 4.6, there exists $j \in \{1, 2\}$ so that

$$\mathcal{D}(w^{(j,n+1)}, x) \geq \frac{n}{2(n+1)} \mathcal{D}(v^{(n)}, x).$$

⁴While the bounding constant $1/27$ seen here matches that in Corollary 3.11, that result cannot be applied as w' is not of the required form.

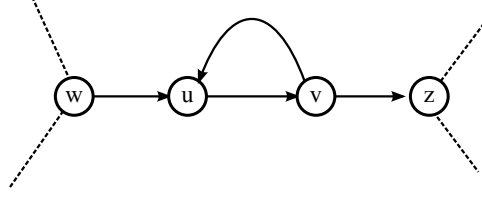

FIGURE 3. The loop that must occur if $\#\mathfrak{C}(\nu)$ is minimal. The dotted edges do not assume a direction.

By Lemma 3.8, there exists $\tilde{w} \in \Lambda'$ such that

$$\mathcal{D}(\mu'_{\tilde{w}}, \nu) \geq \frac{1}{2(K+2)} \mathcal{D}(\mu_v, \nu),$$

where \tilde{w} is either u or u' depending on which k satisfies the previous inequality for infinitely many n . Therefore either $\mathcal{C}'(u) = \nu$ or $\mathcal{C}'(u') = \nu$, and the remaining containment has been shown. \square

Remark 5.9. *If the language \mathcal{L} does not satisfy the binary extension condition, then Lemma 5.8 will still follow by a similar proof. However, the wording will become more complicated.*

Remark 5.10. *If $\Lambda, \Lambda', \dots, \Lambda^{(M)}$ are increments of M bispecial steps, then coloring $\mathcal{C}^{(M)}$ on $\Lambda^{(M)}$ will be related to the coloring \mathcal{C} on Λ by iteratively applying Lemma 5.8.*

5.4. Minimal preimages of \mathcal{C} . Consider a shift Ω with language \mathcal{L} that satisfies the binary extension condition. From Proposition 4.6, for each $\nu \in \mathcal{E}(\Omega)$, the preimage set $\mathfrak{C}(\nu) = \mathcal{C}^{-1}(\nu)$, contains a right special and a left special vertex in Λ . Here, we consider the case $\#\mathfrak{C}(\nu) = 2$. $\mathfrak{C}(\nu)$ must equal $\{u, v\}$, where u is left special and v is right special. It must also be that $u \rightarrow v$ and $v \rightarrow u$; otherwise, $\mathfrak{C}(\nu)$ would contain more than two vertices. We conclude that u and v form a loop in Λ as in Figure 3, where $w, z \in \Lambda$ represent the adjacent vertices with $w \rightarrow u, v \rightarrow z$.

For $n \in \mathcal{J}$, let $W^{(w,u,n)}$ be the word in \mathcal{L} that represents the edge $w \rightarrow u$ in $\Gamma^{\text{Spec}}(n)$, meaning $W^{(w,u,n)}$ begins with $w^{(n)}$, ends with $u^{(n)}$ and each subword of length n follows in order the simple path from $w^{(n)}$ to $u^{(n)}$ in $\Gamma(n)$. Define the prefix and suffix by $W^{(w,u,n)} = P^{(w,u,n)}u^{(n)}$ and $W^{(w,u,n)} = w^{(n)}S^{(w,u,n)}$ respectively. Define similarly the path words W , suffixes S and prefixes P for the other three edges. We state the following lemma without proof, as it follows from the definition. A *minimal return word* $W \in \mathcal{L}$ from Y to Z is a word so that⁵ $W_{[1,|Y|]} = Y$, $W_{[-|Z|+1,0]} = Z$ and $\#_Y(W) = \#_Z(W) = 1$. In other words, W begins with Y , ends with Z and no proper subword of W begins with Y and ends with Z .

Lemma 5.11. *Let \mathcal{J} satisfy Assumption 5.5 with $u, v, w, z \in \Lambda$ as in Figure 3. For any $n \in \mathcal{J}$, the each minimal return word in \mathcal{L} from $W_{[1,n+1]}^{(w,u,n)}$ to $W_{[-n,0]}^{(v,z,n)}$ must be of the form*

$$R_{u \rightarrow v, n}(m) := W^{(w,u,n)} [S^{(u,v,n)} S^{(v,u,n)}]^m S^{(u,v,n)} S^{(v,z,n)}$$

⁵For non-positive index values, we count from the right, i.e. $W_{[i,j]} = W_{[|W|+i, |W|+j]}$ for $-|W| < i \leq j \leq 0$.

for some $m \geq 0$.

Definition 5.12. For each $n \in \mathcal{J}$ and loop $u \rightarrow v$ in Λ as in Figure 3, let

$$\mathcal{W}_{u \rightarrow v}(n) = \{m \geq 0 : R_{u \rightarrow v, n}(m) \in \mathcal{L}\}.$$

When the edge $u \rightarrow v$ is assumed, we will suppress this notation in $\mathcal{W}(n)$.

Because we are considering a minimal aperiodic Ω , for every loop $u \rightarrow v \in \Lambda$, every $\mathcal{W}_{u \rightarrow v}(n)$ is finite, although the sizes may tend to infinity as $n \rightarrow \infty$.

5.5. Bispecial moves on loops. We consider u, v, w, z for Λ as in Figure 3. Fix $n \in \mathcal{J}$ and let $n'' = |\mathcal{W}^{(u, v, n)}|$. The loop will remain in $\Gamma^{\text{Spec}}(n'')$ although bispecial moves may have occurred from n to n'' elsewhere. At step n'' , the bispecial edge $u \rightarrow v$ now corresponds to bispecial word $u^{(n'')} = v^{(n'')} = W^{(u, v, n'')} = W^{(u, v, n)}$. The remaining words and prefixes are related in the following:

$$\begin{aligned} W^{(v, u, n'')} &= P^{(u, v, n)} W^{(v, u, n)} S^{(u, v, n)}, \\ P^{(v, u, n'')} &= P^{(u, v, n)} P^{(v, u, n)}, \\ S^{(v, u, n'')} &= S^{(v, u, n)} S^{(u, v, n)}, \text{ and} \\ P^{(u, v, n'')} = S^{(u, v, n'')} &= \epsilon, \end{aligned}$$

where ϵ is the empty word. The vertices $w^{(n'')}$ and $z^{(n'')}$ will be appropriately defined depending on the vertex types and bispecial moves on other edges that involve w and z .

We will see potentially new local pictures in $\Gamma^{\text{Spec}}(n'' + 1)$ depending on the finite set $\mathcal{W}(n'') = \mathcal{W}(n)$. We now classify these possibilities. First, for Figure 3 to occur (to have a loop at all), we must have $\max \mathcal{W}(n'') \geq 1$; that is, the loop must be traversable at least once. Let

$$u' = W_{[1, n''+1]}^{(u, v, u, n)}, u'' = W_{[1, n''+1]}^{(u, v, z, n)}, v' = W_{[-n'', 0]}^{(u, v, u, n)} \text{ and } v'' = W_{[-n'', 0]}^{(w, u, v, n)}.$$

Here,

$$W^{(u, v, u, n)} = W^{(u, v, n)} S^{(v, u, n)}$$

represents the path in $\Gamma^{\text{Spec}}(n)$ moving from u to v and then from v to u , with similar definitions for $W^{(u, v, z, n)}$ and $W^{(w, u, v, n)}$. Let w' be the unique special word in $\mathcal{L}(n'' + 1)$ with special-avoiding path to v'' and similarly for z' . Then by definition the following paths must occur in $\Gamma(n'' + 1)$:

$$w' \rightsquigarrow v'', u'' \rightsquigarrow z' \text{ and } u' \rightsquigarrow v'.$$

The following cases arise at the bispecial word $u^{(n'')} = v^{(n'')}$ as we move from $\Gamma^{\text{Spec}}(n'')$ to $\Gamma^{\text{Spec}}(n'' + 1)$:

- (1) If $\mathcal{W}(n'') = \{1\}$, then the move is weak bispecial and the loop becomes an edge. In Figure 4(a), the corresponding words w' and z' are the only relevant vertices in $\Gamma^{\text{Spec}}(n'' + 1)$, as no other words are special.
- (2) If $\mathcal{W}(n'') = \{0, 1\}$, the move is RBS and then there are now two edges of the form $v'' \rightarrow u''$ as in Figure 4(b). The words u' and v' are not special.
- (3) If $0 \notin \mathcal{W}(n'')$ and $\max \mathcal{W}(n'') > 1$, the move on $u \rightarrow v$ is RBS and results in another loop about u' and v' as in Figure 4(c). The words u'' and v'' are not special. Note that

$$\mathcal{W}_{u' \rightarrow v'}(n'' + 1) = \{m - 1 : m \in \mathcal{W}(n'')\}.$$

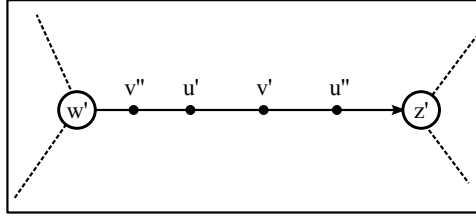

(a) Weak bispecial move.

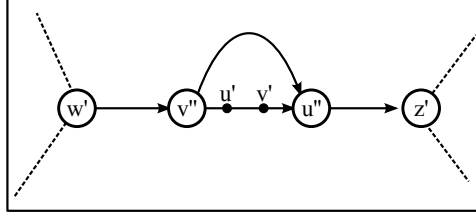

(b) Regular bispecial move, removing the loop.

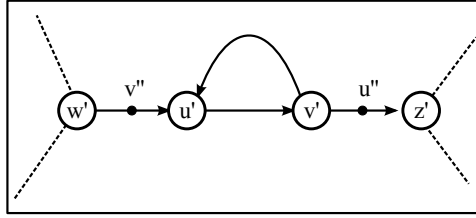

(c) Regular bispecial move, maintaining the loop.

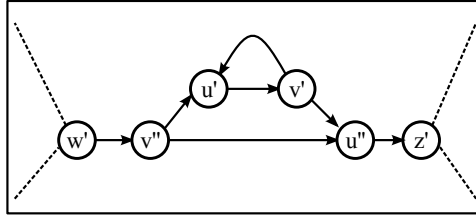

(d) Strong bispecial move. The new shape is a loop atop a "tower."

FIGURE 4. The types of bispecial moves on $u \rightarrow v$ from $\Gamma^{\text{Spec}}(n')$ in Figure 3 to $\Gamma^{\text{Spec}}(n' + 1)$. Circled nodes are vertices, while dot nodes are not.

- (4) If $0 \in \mathcal{W}(n'')$ and $\max \mathcal{W}(n'') > 1$, then the loop $u' \rightarrow v' \rightarrow u'$ is still present, while the other vertices form edges $w' \rightarrow v''$, $v'' \rightarrow u'$, $v' \rightarrow u''$, $v'' \rightarrow u''$ and $u'' \rightarrow z'$ as indicated in Figure 4(d). Similarly,

$$\mathcal{W}_{u' \rightarrow v'}(n'' + 1) = \{m - 1 : m \in \mathcal{W}(n''), m \neq 0\}.$$

5.6. **Coloring for loops.** We will now discuss how the changes in the previous section affect colorings. The first result says the following: if $\mathcal{C}(\nu)$ has only two

elements, then the maximum number of windings about the corresponding loop must grow to infinity as $n \in \mathcal{J}$ goes to infinity.

Lemma 5.13. *If for $\nu \in \mathcal{E}(\Omega)$, $\mathfrak{C}(\nu) = \{u, v\}$ with u and v as in Figure 3, then $\lim_{\mathcal{J} \ni n \rightarrow \infty} \max \mathcal{W}(n) = \infty$.*

Proof. Suppose by contradiction that for some n_0 and M ,

$$m \leq M \text{ for all } m \in \mathcal{W}(n) \text{ and } n \geq n_0, n \in \mathcal{J}.$$

Fix $n \geq N_0$ and recall the generic x for ν . Because the paths $u \rightarrow v \rightarrow u$ and $w \rightarrow u \rightarrow v$ in $\Gamma^{\text{Spec}}(n)$ have total length at most Ln , if $u^{(n)}$ occurs in position p in x , then $w^{(n)}$ must occur in position $p' < p$ with $p - p' < (M + 1)Ln$. By Lemma 3.8, this implies that $\mathcal{D}(\mu_w, \nu) \geq \frac{1}{3(M+2)}\mathcal{D}(\mu_u, \nu) > 0$. But this is a contradiction because then $w \in \mathfrak{C}(\nu)$. We may likewise show by contradiction that $z \in \mathfrak{C}(\nu)$. \square

The preceding proof yields the following natural converse.

Corollary 5.14. *If for $\nu \in \mathcal{E}(\Omega)$, $u, v \in \mathfrak{C}(\nu)$ with u and v as in Figure 3 and $\limsup_{\mathcal{J} \ni n \rightarrow \infty} \max \mathcal{W}(n) < \infty$, then*

$$u, v, w, z \in \mathfrak{C}(\nu),$$

where w and z are the neighboring vertices to the loop.

In the rest of the paper, when we transition from a special graph at stage n'' to $n'' + 1$, we would like ensure that $\Gamma^{\text{Spec}}(n'' + 1) \not\equiv \Gamma^{\text{Spec}}(n'')$. Suppose $\Gamma^{\text{Spec}}(n'')$ contains at least one loop as in Figure 3 that will undergo a bispecial move. If $\Gamma^{\text{Spec}}(n'' + 1) \equiv \Gamma^{\text{Spec}}(n'')$, then all such loops must have experienced an RBS move as in Figure 4(c). Thus, $\min \mathcal{W}(n'') > 0$ and $\max \mathcal{W}(n'') > 1$ for all such loops. However, note that after the move, the new set $\mathcal{W}(n'' + 1)$ satisfies

$$\min \mathcal{W}(n'' + 1) = \min \mathcal{W}(n'') - 1 \text{ and } \max \mathcal{W}(n'' + 1) = \max \mathcal{W}(n'') - 1.$$

Therefore, we can for a fixed loop choose $n''' = n'' + m_0 a$ where a is the total weight of the loop $u \rightarrow v \rightarrow u$; that is, $a = |S^{(u,v,n'')}| + |S^{(v,u,n'')}|$, and $m_0 = \min \mathcal{W}(n'')$. Then $\min \mathcal{W}(n''') = 0$. If $\mathcal{W}(n''') = \{0\}$, then we no longer have a loop in $\Gamma^{\text{Spec}}(n''')$, as the bispecial move before n''' was weak bispecial. If $\mathcal{W}(n''') = \{0, 1\}$, then the move at $\text{B}^{\text{Sp}}(n''')$ will be the regular bispecial move that removes the loop as in Figure 4(b). Otherwise the move will be the strong bispecial move as in Figure 4(d). For all $n'' \leq \tilde{n} \leq n'''$, the loop will persist.

For the next lemma, recall that $L = K + 1$.

Lemma 5.15. *Let n'' be so that $\Gamma^{\text{Spec}}(n'')$ has loop about $u^{(n'')} = v^{(n'')}$ as in Figure 3, meaning in particular that $u^{(n'')} = v^{(n'')}$ is bispecial. If $n''' = n'' + ab$, where a is the length of the loop $u^{(n'')} \rightarrow v^{(n'')} \rightarrow u^{(n'')}$ and $b \leq \min \mathcal{W}(n'')$, then*

$$\mathcal{D}(u^{(n'')}, x) \geq \frac{1}{12(K+1)}\mathcal{D}(u^{(n''')}, x) \text{ and } \mathcal{D}(u^{(n''')}, x) \geq \frac{1}{27}\mathcal{D}(u^{(n'')}, x)$$

for any x .

Proof. Because $b \leq \min \mathcal{W}(n'')$, each occurrence of $u^{(n'')}$ is contained in an occurrence of $u^{(n''')}$. So we apply Corollary 3.11 with $\alpha = K + 1$. \square

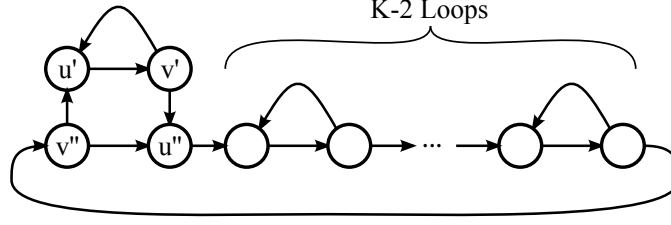

FIGURE 5. The graph Λ^{Tower} .

For a loop in $\Gamma^{\text{Spec}}(n)$, let $n'' \geq n$ be the minimum value such that $u^{(n'')} = v^{(n'')}$. Furthermore, let $n''' = n'' + ab$ as in the lemma with b taken to be the maximum such value so that the loop remains in $\Gamma^{\text{Spec}}(n''')$; that is, b is the minimum of $\min \mathcal{W}(n'')$ and $\max \mathcal{W}(n'') - 1$. If there are multiple loops, then let n''' be the minimum of all such values. We now choose \mathcal{J}'' from n''' for each $n \in \mathcal{J}$ so that $\Gamma^{\text{Spec}}(n''') \equiv \Lambda''$, $\Gamma^{\text{Spec}}(n''' + 1) \equiv \Lambda'''$, and \mathcal{J}'' with Λ'' satisfies Assumption 5.5. We then reduce \mathcal{J} so that $\mathcal{J} = \{n_1, n_2, \dots\}$ and $\mathcal{J}'' = \{n_1''', n_2''', \dots\}$ satisfy

$$n_1 < n_1''' < n_2 < n_2''' < n_3 < n_3''' < \dots$$

Note that $\Lambda'' \neq \Lambda'''$. The next result tells us that colors of loops in Λ persist to Λ'' .

Corollary 5.16. *With Λ and Λ'' as above, for each u and v associated to a loop*

$$\mathcal{C}(u) = \mathcal{C}(v) = \mathcal{C}''(u) = \mathcal{C}''(v)$$

where \mathcal{C} is the coloring relation for Λ and \mathcal{C}'' is the coloring relation for Λ'' .

6. PROOF OF MAIN THEOREM

We will first prove Theorem 1.1 under the binary extension condition.

Proposition 6.1. *If minimal shift Ω on finite \mathcal{A} satisfies equation (1) with $K \geq 4$ and its language satisfies the binary extension condition, then $\#\mathcal{E}(\Omega) \leq K - 2$.*

6.1. Binary Extension Condition: Special Cases. Given K , consider a special (unweighted) graph Λ^{Tower} defined by the conditions:

- there are exactly $K - 1$ bispecial edges,
- all $K - 1$ bispecial edges are in loops as in Figure 3,
- there is one loop $u' \rightarrow v'$ and vertices u'', v'' so that these four vertices form a “tower” resulting from a SBS move on loop $u' \rightarrow v'$ as in Figure 4(d).

The graph Λ^{Tower} is represented in Figure 5. In the proof of the next result, we will require that the base vertices $u'', v'' \in \Lambda^{\text{Tower}}$ connect to distinct loops outside of the tower u', v', u'', v'' . This occurs only for $K \geq 4$.

Lemma 6.2. *If Ω satisfies equation (1) with Λ and $K \geq 4$ from Assumption 5.5 where $\Lambda \equiv \Lambda^{\text{Tower}}$, then $\#\mathcal{E}(\Omega) \leq K - 2$.*

Proof. Note that Corollary 2.10 implies that the language satisfies the binary extension condition and so every special Rauzy graph $\Gamma^{\text{Spec}}(n)$ for sufficiently large n has exactly $2K$ vertices. Let $E = \#\mathcal{E}(\Omega)$. For \mathcal{J} , accelerate to \mathcal{J}'' with Λ'' as discussed before Corollary 5.16 on the $K - 1$ loops. Because there are no bispecial edges except these loops, then necessarily $\Lambda'' \equiv \Lambda \equiv \Lambda^{\text{Tower}}$. If either of the base vertices u'' or v'' of the tower are colored by some $\nu_0 \in \mathcal{E}(\Omega)$ then we may see by

Proposition 4.6 that there are at least two loops in the graph that are colored by the same measure. Because $\#\mathfrak{C}(\nu_0) \geq 5$, $E \leq K - 2$ by Corollary 4.9. We must have then that $\mathcal{C}(u'') = \mathcal{C}(v'') = \mathbf{0}$ and if any loop is also uncolored, we have $\#\mathfrak{C}(\mathbf{0}) \geq 4$ and again Corollary 4.9 yields $E \leq K - 2$.

So assume that each loop is colored and the extra two vertices u'' and v'' are not. Consider the next move from $\Lambda'' \equiv \Lambda^{\text{Tower}}$ to Λ''' also mentioned before Corollary 5.16. At least one loop must undergo an RBS or WBS change, as at least one loop must undergo one of the three bispecial changes in Figure 4; that is, not the move in Figure 4(c) that preserves the loop. If a loop undergoes a SBS change then another loop must undergo a WBS change to preserve the total number of vertices.

Fix a loop $u \rightarrow v$ that undergoes an RBS or WBS change and write ν_1 for the measure with $u, v \in \mathfrak{C}(\nu_1)$. For this loop, $\mathcal{W}(n''') = \{0, 1\}$ or $\{1\}$ for each $n''' \in \mathcal{J}''$. By Corollary 5.14, the vertices in Λ'' adjacent to the loop $u \rightarrow v$ must share its color. If this loop is either $u' \rightarrow v'$ (the top of the “tower”) or adjacent to u'' or v'' (the base vertices of the “tower”), we have a contradiction as either u'' or v'' must belong to $\mathfrak{C}(\nu_1)$. Otherwise, this loop then shares its color with its two neighboring loops, and so $\#\mathfrak{C}(\nu_1) \geq 6$ and so $E \leq K - 2$ by Corollary 4.9. \square

Lemma 6.3. *Suppose Ω satisfies equation (1) with Λ and $K \geq 4$ from Assumption 5.5. If Λ contains at least $K - 2$ consecutive loops that are colored, meaning that there are vertices $u^{(k)}, v^{(k)} \in \Lambda$, $1 \leq k \leq K - 2$ so that*

- (i) *for each $1 \leq k \leq K - 2$, $u^{(k)} \rightarrow v^{(k)}$ forms a loop as in Figure 3,*
- (ii) *for each $1 \leq k < K - 2$, the edge $v^{(k)} \rightarrow u^{(k+1)}$ exists in Λ and connects the k^{th} loop to the $(k + 1)^{\text{st}}$ and*
- (iii) *for each $1 \leq k \leq K - 2$, $\mathcal{C}(u^{(k)}) = \mathcal{C}(v^{(k)}) \neq \mathbf{0}$,*

then $\#\mathcal{E}(\Omega) \leq K - 2$.

Proof. Let $E = \#\mathcal{E}(\Omega)$. Recalling Corollary 4.9, we will show by cases that either: there is a measure ν_0 so that at least 5 vertices are colored by ν_0 or there are at least 3 uncolored vertices.

We will consider a number $\mathcal{K} \geq K - 2$ of consecutive colored loops. If $\mathcal{K} = K$, then Λ is just a cycle of K colored loops. In this case, consider $\mathcal{J}'', \Lambda'', \mathcal{J}''', \Lambda'''$ from the discussion before Corollary 5.16. Just as in the previous proof, $\Lambda'' \equiv \Lambda$ and all loops are still colored by relation $\mathcal{C}'' = \mathcal{C}$ on Λ'' . Also, at least one loop will undergo either an RBS or WBS change from Λ'' to Λ''' and so by Corollary 5.14, its color will be shared by the neighboring loops. Therefore if ν_0 is the coloring for that loop, then $\#\mathfrak{C}(\nu_0) \geq 6$.

If $\mathcal{K} = K - 1$, then either:

- (A) there are exactly $K - 1$ loops and the remaining two vertices $u^{(K)}, v^{(K)}$ are connected by the edges $v^{(K-1)} \rightarrow v^{(K)}$, $u^{(K)} \rightarrow u^{(1)}$ and two edges $v^{(K)} \rightarrow u^{(K)}$, or
- (B) there are K loops in a cycle, but one is not colored. Call the vertices of this loop $u^{(K)} \rightarrow v^{(K)}$.

If (A) holds, construct $\mathcal{J}'', \Lambda'', \mathcal{J}''', \Lambda'''$ as before. Then $\Lambda'' = \Lambda$ (the only bispecial edges exist in the $K - 1$ loops) and from Λ'' to Λ''' there must exist a loop colored by some ν_0 that undergoes either an RBS or WBS change. By Corollary 5.14, the vertices adjacent to this loop must also be colored by ν_0 . Such an adjacent vertex is either an element of another loop or of the set $\{u^{(K)}, v^{(K)}\}$. In either case,

the color ν_0 on these vertices implies that at least two vertices on each side of the original loop are colored by ν_0 as well. Therefore again $\#\mathfrak{C}''(\nu_0) \geq 6$.

If (B) holds, construct $\mathcal{J}'', \Lambda'', \mathcal{J}''', \Lambda'''$ as before but focus on all K loops. If a colored loop in $\Lambda'' \equiv \Lambda$ undergoes an RBS or WBS change, then just as in the previous case $\#\mathfrak{C}''(\nu_0) \geq 6$ for ν_0 coloring that loop. If not, then either

- (B.1) no colored loop changes from Λ'' to Λ''' and so the loop $u^{(K)} \rightarrow v^{(K)}$ undergoes an RBS change, or
- (B.2) exactly one colored loop undergoes an SBS change and the loop $u^{(K)} \rightarrow v^{(K)}$ undergoes a WBS change.

If (B.1) occurs, then Λ''' is of the form in (A). We apply that argument to \mathcal{J}''' and Λ''' to conclude that $E \leq K - 2$. If (B.2) occurs, then $\Lambda''' \equiv \Lambda^{\text{Tower}}$ and so $E \leq K - 2$ by Lemma 6.2.

For the last case, suppose $\mathcal{K} = K - 2$. Find $\mathcal{J}'', \Lambda'', \mathcal{J}''', \Lambda'''$ by considering only the $K - 2$ loops. That is, the $K - 2$ loops persist to Λ'' but a bispecial change will affect at least one of them from Λ'' to Λ''' . Again, if a colored loop experiences an RBS or WBS change from Λ'' to Λ''' , then $\#\mathcal{E}(\Omega) \leq K - 2$. If not, then either:

- (C) two colored loops undergo SBS moves, or
- (D) one colored loop undergoes an SBS move.

Here, we have used that three SBS moves are impossible by a counting argument. In either case, the remaining colored loops do not change. If (C) occurs, then the remaining four vertices in Λ'' not in a colored loop will form two bispecial edges that will undergo WBS moves from Λ'' to Λ''' . Therefore, Λ''' will have exactly $K - 2$ loops and two ‘‘towers’’ from SBS moves, each tower composed of a loop and two base vertices. If any of the four base vertices in Λ''' is colored by some measure ν_0 , then by Proposition 4.6 it follows that $\#\mathfrak{C}'''(\nu_0) \geq 5$. This is because if the base vertices of a tower are colored, then all four vertices in the tower have the same color. If none of the base vertices are colored, then $\#\mathfrak{C}'''(\mathbf{0}) \geq 4$.

If (D) occurs, then two of the four remaining vertices in Λ'' will belong to a bispecial edge that will undergo a WBS move. Therefore, Λ''' will contain a loop tower and at least $K - 3$ loops, all inheriting colors from the $K - 2$ loops in Λ'' by Lemma 5.8. The two extra vertices are either both colored or both not by considering the graph structure. If the two vertices are not colored or share a color with one of the loops, then by excluding these two vertices as well as the four for the tower we have that $2(E - 1) \leq 2K - 6$ and again $E \leq K - 2$. If the two vertices are colored by a different measure, then they must form a loop as in Figure 3. In this case $\Lambda''' = \Lambda^{\text{Tower}}$ and by Lemma 6.2, $E \leq K - 2$. We have concluded the proof as all cases have been exhausted. \square

6.2. Binary Extension Condition: Main Proof.

Proof of Proposition 6.1. Construct \mathcal{J} and Λ that satisfy Assumption 5.5 for Ω . Suppose first by contradiction that $E = K$, where $E = \#\mathcal{E}(\Omega)$. Then Λ must be K colored loops all in a cycle. However, by Lemma 6.3 it must be that $E \leq K - 2$ and we have contradicted our assumption.

Now suppose by contradiction that $E = K - 1$. Because

$$2(K - 1) \leq \sum_{\nu} \#\mathfrak{C}(\nu) \leq 2K$$

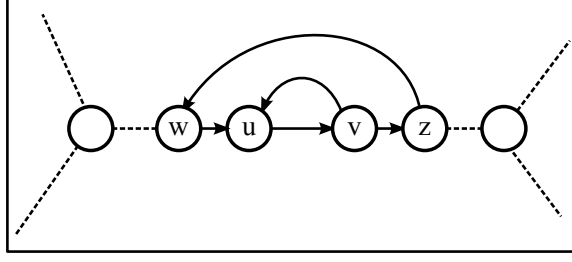

FIGURE 6. Loop $u \rightarrow v$ is “nested” in larger loop $w \rightarrow u \rightarrow v \rightarrow z$. Note that the dotted edges incident to w and z do not have an orientation. This is because either w is left special and z is right special, or w is right special and z is left special.

we must have

$$\#\mathfrak{C}(\nu_1) = \cdots = \#\mathfrak{C}(\nu_{K-3}) = 2 \leq \#\mathfrak{C}(\nu_{K-2}) \leq \#\mathfrak{C}(\nu_{K-1})$$

for some choice of ordering $\nu_1, \dots, \nu_{K-1} \in \mathcal{E}(\Omega)$. By focusing on the $K - 3$ colored loops, choose $\mathcal{J}'', \Lambda'', \mathcal{J}''', \Lambda'''$ as discussed before Corollary 5.16. First suppose that one of the colored loops undergoes a WBS or RBS move from Λ'' to Λ''' , then for its measure ν_{k_0} we have $\#\mathfrak{C}''(\nu_{k_0}) \geq 4$ by Corollary 5.14. Note that if $\#\mathfrak{C}(\nu_{k_0}) \geq 5$, then $E \leq K - 2$ by Corollary 4.9, a contradiction.

If we name this loop $u \rightarrow v$ with adjacent vertices w and z as in Figure 3, then $\#\mathfrak{C}''(\nu_{k_0}) = 4$ if and only if $z \rightarrow w$ forms an “outer” loop that nests loop $u \rightarrow v$ as in Figure 6. Note that exactly one vertex w or z is left special and the other is right. By counting the remaining measures and using the assumption $E = K - 1$,

$$(7) \quad 2(K - 2) = 2(E - 1) \leq \sum_{\nu \neq \nu_{k_0}} \#\mathfrak{C}''(\nu) \leq 2K - 4,$$

so the remaining measures all color distinct loops in Λ'' . In this case Λ'' is the nested loop connected in a cycle to the remaining (and consecutive) $K - 2$ colored loops. Again we have a contradiction that $E \leq K - 2$ by Lemma 6.3.

Now suppose that no colored loop in Λ'' will undergo an RBS or WBS change to Λ''' . Then at least one of the $K - 3$ loops will undergo an SBS change while the remaining loops do not change. Each SBS change will result in a tower that must share its color with its corresponding loop in Λ . If M such towers are created, then

$$2(K - 1 - M) = 2(E - M) \leq 2K - 4M \Rightarrow M \leq 1.$$

Therefore exactly one SBS tower will be created in Λ''' and the remaining loops will persist from Λ to this Λ''' . If ν_{k_0} is the measure related this new tower, then the inequality (7) holds but by summing for \mathfrak{C}''' instead. We again conclude that $\Lambda''' \equiv \Lambda^{\text{Tower}}$ and so we reach our contradiction as $E \leq K - 2$. \square

6.3. General Languages: Main Proof. Now suppose Ω has eventually constant complexity growth K as in equation (1) but does not satisfy the binary extension condition. For $\mathfrak{s} \in \{\ell, r\}$, let

$$\Psi_{\mathfrak{s}} = \lim_{n \rightarrow \infty} \psi_{\mathfrak{s}}(n)$$

where $\psi_{\mathfrak{s}}(n) = \max\{\#\text{Ext}_{\mathfrak{s}}(w) : w \in \mathcal{L}(n)\}$ from Lemma 2.5. Because the language \mathcal{L} does not satisfy the binary extension condition, $\Psi_{\mathfrak{s}} > 2$ for some $\mathfrak{s} \in \{\ell, r\}$. By equation (6) and Corollary 4.3, if $\Psi_{\mathfrak{s}} \geq 4$ for some \mathfrak{s} , then $\#\mathcal{E}(\Omega) \leq K-2$. Items (I)-(III) of the following lemma are consequences of this fact; the remaining statement follows from equation (3).

Lemma 6.4. *If Ω satisfies the conditions above with \mathcal{J}, Λ satisfying Assumption 5.5 and $K_{\mathfrak{s}} \geq K-1$ for each $\mathfrak{s} \in \{\ell, r\}$, then exactly one of the following must hold:*

- (I) $\Psi_{\ell} = 2$ and $\Psi_r = 3$,
- (II) $\Psi_{\ell} = 3$ and $\Psi_r = 2$, or
- (III) $\Psi_{\ell} = \Psi_r = 3$.

Furthermore, if $\Psi_{\mathfrak{s}} = 3$ then for all large n there exists a unique $\tilde{w} \in \mathcal{L}_{\mathfrak{s}}(n)$ so that $\#\text{Ext}_{\mathfrak{s}}(\tilde{w}) = 3$ and for all $w \in \mathcal{L}_{\mathfrak{s}}(n)$, $w \neq \tilde{w}$, $\#\text{Ext}_{\mathfrak{s}}(w) = 2$.

Proof of Theorem 1.1. If Ω has language \mathcal{L} that satisfies the binary extension condition, then Proposition 6.1 implies that $E \leq K-2$, where $E = \#\mathcal{E}(\Omega)$. Otherwise, one of the cases in Lemma 6.4 holds. Note in any of these cases, $K_{\mathfrak{s}} = K-1$ for some $\mathfrak{s} \in \{\ell, r\}$, so $E = K$ is not possible by Corollary 4.3. We will therefore assume for a contradiction that $E = K-1$, and argue by cases. Construct $\mathcal{J}, \Lambda, K_{\ell}$ and K_r that satisfy Assumption 5.5. For each $\mathfrak{s} \in \{\ell, r\}$, let $\mathfrak{C}_{\mathfrak{s}}$ denote the elements of \mathfrak{C} that are \mathfrak{s} -special.

If case (I) holds, then $K_r = K-1$ and $K_{\ell} = K$. So $\#\mathfrak{C}_r(\nu) = 1$ for all $\nu \in \mathcal{E}(\Omega)$ and $\mathfrak{C}_r(\mathbf{0}) = \emptyset$. Furthermore, either $\#\mathfrak{C}_{\ell}(\nu) = 1$ for all $K-1$ measures ν and $\#\mathfrak{C}_{\ell}(\mathbf{0}) = 1$, or $\#\mathfrak{C}_{\ell}(\nu) = 1$ for $K-2$ measures ν and $\#\mathfrak{C}_{\ell}(\nu) = 2$ for one measure ν . In either case, if ν_0 is the measure such that $\mathfrak{C}_r(\nu_0)$ contains the vertex of out-degree three, there must be at least $K-3$ measures $\nu \neq \nu_0$ such that $\#\mathfrak{C}_r(\nu) = \#\mathfrak{C}_{\ell}(\nu) = 1$.

Construct \mathcal{J}'' , Λ'' , \mathcal{J}''' , Λ''' as before Corollary 5.16 so that the $K-3$ binary loops are preserved from Λ to Λ'' and at least one changes from Λ'' to Λ''' . Let \mathcal{C}'' and \mathcal{C}''' be the coloring functions on Λ'' and Λ''' respectively. By Corollary 5.16, $\mathcal{C}'' = \mathcal{C}$ on each binary loop. We claim that at least one binary loop will undergo an RBS or WBS change from Λ'' to Λ''' . Otherwise, at least one binary loop must undergo an SBS change from Λ'' to Λ''' . However, then the created tower has two right special vertices of the same color, and this contradicts $\#\mathfrak{C}_r(\nu) = 1$ for all $\nu \in \mathcal{E}(\Omega)$. Therefore a binary loop $u \rightarrow v$ undergoes an RBS or WBS change and must share its color with the next vertex a on the path from v leading away from u . Since $\#\mathfrak{C}_r(\nu) = 1$ for all $\nu \in \mathcal{E}(\Omega)$, a cannot be right special, so it is left special. Following the path from a , we must eventually hit a right special vertex, and each left special vertex shares the same color as the loop $u \rightarrow v$. So the first right special vertex we hit must be v , and this contradicts minimality.

The case (II) may be handled as above by interchanging the roles of “left special” and “right special.” If (III) holds, then $K_{\ell} = K_r = K-1$ and necessarily $\#\mathfrak{C}(\nu) = 2$ for all ν . A similar argument to the above works here as well. Namely, there must be at least $K-3$ colored binary loops, and if we wait for one of them to change, it cannot perform an SBS move. If it performs an RBS or WBS move, then the right special vertex in the loop must share its color with the vertex a on the path away from the left special vertex. But since $\#\mathfrak{C}(\nu) = 2$ for all ν , we immediately contradict minimality. \square

7. FURTHER WORK

For large K , the statement “ $\#\mathcal{E}(\Omega) = K - 2$ ” for Ω satisfying (1) already seems problematic. We plan to expand the results presented here to explore improvements to Theorem 1.1.

As discussed in the introduction, an interesting class of shifts satisfying (1) are generated by interval exchange transformations. By [4, Lemma 8] these shifts satisfy the binary extension condition. Furthermore, they enjoy a *regular bispecial condition*, meaning the bispecial words of length n are regular bispecial for all large n . Using the additional assumption that Ω satisfies the regular bispecial condition, we have already achieved a bound $\#\mathcal{E}(\Omega) \leq C \cdot K$ for a constant $C < 1$. These results will be produced in a future paper.

We aim to sharpen the bounds for shifts with either the binary extension condition or regular bispecial condition and compare these bounds with those for interval exchange transformations, $\#\mathcal{E}(\Omega) \leq (K + 1)/2$.

REFERENCES

- [1] M. Boshernitzan. A unique ergodicity of minimal symbolic flows with linear block growth. *Journal d'Analyse Mathématique*, 44:77–96, 1985.
- [2] J. Cassaigne. Special factors of sequences with linear subword complexity. In *In Developments in Language Theory*, pages 25–34. World Scientific, 1996.
- [3] V. Cyr and B. Kra. Counting generic measures for a subshift of linear growth. *ArXiv*, May 2015.
- [4] S. Ferenczi and L. Q. Zamboni. Languages of k -interval exchange transformations. *Bulletin of the London Mathematical Society*, 40(4):705–714, 2008.
- [5] A. Katok. Invariant measures of flows on oriented surfaces. *Soviet Math. Dokl.*, 14(4):1104–1108, 1973.
- [6] M. Keane. Interval exchange transformations. *Mathematische Zeitschrift*, 141(1):25–31, 1975.
- [7] M. Keane. Non-ergodic interval exchange transformations. *Israel Journal of Mathematics*, 26:188–196, 1977. 10.1007/BF03007668.
- [8] W. A. Veech. Moduli spaces of quadratic differentials. *J. Analyse Math.*, 55:117–171, 1990.
- [9] M. Viana. Ergodic theory of interval exchange maps. *Rev. Mat. Complut.*, 19(1):7–100, 2006.
- [10] P. Walters. *An Introduction to Ergodic Theory*. Graduate Texts in Mathematics. Springer New York, 2000.
- [11] J.-C. Yoccoz. Interval exchange maps and translation surfaces. In *Homogeneous Flows, Moduli Spaces and Arithmetic*, 2007.

E-mail address: mdamron@gatech.edu

E-mail address: jonfick@princeton.edu