

Controlling properties of a hybrid Cooper pair box interacting with a nanomechanical resonator in the presence of Kerr nonlinearities and losses.

C. Valverde,^{1,2,3,*} A. N. Castro,² and B. Baseia^{4,5}

¹*Câmpus Henrique Santillo, Universidade Estadual de Goiás - 75.132-903, Anápolis, Goiás, Brazil*

²*Universidade Paulista (UNIP) - 74.845-090, Goiânia, Goiás, Brazil*

³*Escola Superior de Negócios (ESUP) - 74.840-090, Goiânia, Goiás, Brazil*

⁴*Instituto de Física, Universidade Federal de Goiás, 74001-970 Goiânia, GO, Brazil*

⁵*Departamento de Física, Universidade Federal da Paraíba - 58.051-970, João Pessoa, Paraíba, Brazil*

(Dated: October 1, 2018)

We consider the Jaynes-Cummings model describing the interaction of a Cooper pair box (*CPB*) and a nanoresonator (*NR*) in the presence of a Kerr medium and losses. The evolution of the entropy of both subsystems and the *CPB* population inversion were calculated numerically. It is found that these properties increase when the *NR* frequency is time-dependent, even in the presence of losses; the effect is very sensitive to detuning and disappears in the resonant regime. The roles played by the losses affecting the *CPB* and the *NR* are also compared.

PACS numbers: 42.65.Yj; 03.65.Yz; 42.50.Nn

I. INTRODUCTION

The implementation of the quantum computer is considered as a big challenge in the recent years due to the failure of classical computers ability to simulate and compute the large scale data. The interaction of the single photon field with superconducting circuit to generate quantum bits is studied experimentally [1, 2] and theoretically [3–5]. Wallraff et al. have observed a strong coupling between the superconducting two-level system and a single microwave photon which prove the generation of qubits. Recently, the construction of the first quantum computer by Canadian company (D-Wave) using the system of the superconducting qubits was shown. This quantum computer succeeds to solve famous problem in mathematics, the Ramsey numbers [6].

The study of the interaction between a two-level atom and a radiation field is very important in quantum mechanics, as its applications in laser physics and quantum optics. This system has similarities with others, e.g., the interaction between a Cooper pair box (*CPB*) and a nanomechanical resonator (*NR*). There are many works in the literature dealing with these systems [7, 8], but only few of them treat these systems in the situation where one of the frequencies [9, 10], or the amplitude [11], varies with time. In the *CPB-NR* system these variations change the subsystems coupling and modify their dynamic properties, e.g., showing amplification of the excitation transition rate in subsystems [12].

An important focus of quantum optics is concerned with the atom-field coupled system. Inspired by various tests applied to this system, and its limitations, the researchers have passed from the light domain to the microwave domain of superconducting cavities coupled to Rydberg atoms, or to the quantum electrodynamics cir-

cuit coupled to nanoresonators. After being extended to broader context the system was used to investigate Landau-Zener transitions [13]; atomic physics and quantum optics [14]; mechanisms for photon generation from quantum vacuum [15]; quantum simulation, challenges, and promises of fast-growing field [16]. Here we will assume the laboratory substituting the atom (field) by the *CPB* (*NR*) [17]. This system have been analyzed in several works, e.g.: quantum network [18]; phonon blockade [19]; squeezed states and entangled states [20]; cooling mechanical oscillators [21]; Bell inequality violations [22].

In this report we will employ the Jaynes-Cummings model to treat a *CPB-NR* system with losses; a nonlinear Kerr medium is also added to include influences of nonlinearities. We investigate the time evolution of the *CPB* population inversion ($I(t)$), as well as the statistical properties of both subsystems. We consider the *NR* initially in a coherent state and the *CPB* in its excited state. The influence caused by the time-dependent *NR* frequency upon the properties of both subsystems is studied. We consider the combined effects of nonlinearity and losses upon the dynamics of the *CPB* population inversion and upon the *NR* entropy, the latter being used as a measure for the degree of entanglement. We compare the results obtained in the resonant case ($\omega_{NR} = \omega_{CPB}$) with those obtained for small detunings between the *CPB* and *NR*. The influences of losses from the *NR* and *CPB* upon the mentioned properties are also compared.

II. THE HAMILTONIAN SYSTEM

A superconductor *CPB* charge qubit is adjusted to the input voltage V_g of the system through a capacitor with an input capacitance C_1 . Observing the configuration shown in Fig. (1) we see three loops: a small loop in the left, another in the right, and a great loop in the center. The control of the external parameters of the system can be implemented via the input voltage V_g and

* valverde@ueg.br

the three external fluxes Φ_L , Φ_r and Φ_e . The control of these parameters allows us to make the coupling between the *CPB* and the *NR*. In this way one can induce small neighboring loops. The great loop contains the *NR* and its effective area in the center of the apparatus changes as the *NR* oscillates, which creates an external flux $\Phi_e(t)$ that provides the coupling between the *CPB* and the *NR*.

$$\hat{H} = \omega_0 \hat{a}^\dagger \hat{a} + 4E_c \left(N_g - \frac{1}{2} \right) \hat{\sigma}_z - 4E_J^0 \cos \left(\frac{\pi \Phi_x}{\Phi_0} \right) \cos \left(\frac{\pi \Phi_e}{\Phi_0} \right) \hat{\sigma}_x, \quad (1)$$

where $\hat{a}^\dagger(\hat{a})$ is the creation (annihilation) operator for the *NR* excitations, corresponding to the frequency ω and mass m ; E_J^0 and E_c are respectively the energy of each Josephson junction and the charge energy of a single electron; C_1 and C_J^0 stand for the input capacitance and the capacitance of each Josephson tunnel, respectively; $\Phi_0 = \frac{\pi}{e}$ is the quantum flux and $N_g = \frac{C_1 V_g}{2e}$ is the charge number in the input with the input voltage V_g . We have used the Pauli matrices to describe our system operators, where the states $|0\rangle$ and $|1\rangle$ represent the number of extra Cooper pairs in the superconducting island. So we have, $\hat{\sigma}_z = |1\rangle\langle 1| - |0\rangle\langle 0|$ and $E_c = \frac{e^2}{C_1 + 4C_J^0}$.

The magnetic flux can be written as the sum of two

We will consider $\hbar = 1$ and assume as identical the four Josephson junctions, with the same Josephson energy E_J^0 , the same being assumed for the external fluxes Φ_L and Φ_r , i.e., with same magnitude, but opposite sign: $\Phi_L = -\Phi_r = \Phi_x$. In this way we can write the Hamiltonian describing the entire system as

terms,

$$\Phi_e = \Phi_b + B\ell x, \quad (2)$$

where the term Φ_b is the induced flux, corresponding to the equilibrium position of the *NR* and the second term describes the contribution due to the *NR* vibration; B represents the magnetic field created in the loop and ℓ is the length of the *NR*. We write the displacement \hat{x} as $\hat{x} = x_0(\hat{a}^\dagger + \hat{a})$, where x_0 represents the *NR* amplitude oscillation. Substituting the Eq.(2) in Eq.(1) and controlling the flux Φ_b we can adjust $\cos \left(\frac{\pi \Phi_b}{\Phi_0} \right) = 0$ to obtain

$$\hat{H} = \omega_0 \hat{a}^\dagger \hat{a} + 4E_c \left(N_g - \frac{1}{2} \right) \hat{\sigma}_z - 4E_J^0 \cos \left(\frac{\pi \Phi_x}{\Phi_0} \right) \sin \left(\frac{\pi B \ell \hat{x}}{\Phi_0} \right) \hat{\sigma}_x \quad (3)$$

and making the approximation $\frac{\pi B \ell x}{\Phi_0} \ll 1$ we find the Hamiltonian in the form, $\hat{H} = \omega_0 \hat{a}^\dagger \hat{a} + \frac{1}{2} \omega_c \hat{\sigma}_z + \lambda_0 (\hat{a}^\dagger + \hat{a}) \hat{\sigma}_x$, where the constant coupling λ_0 and the effective energy ω_c are given by $\lambda_0 = -4E_J^0 \cos \left(\frac{\pi \Phi_x}{\Phi_0} \right) \left(\frac{\pi B \ell x_0}{\Phi_0} \right)$, $\omega_c = 8E_c \left(N_g - \frac{1}{2} \right)$. In the rotating wave approximation the above Hamiltonian results in the form,

$$\hat{H}_{eff} = \omega_0 \hat{a}^\dagger \hat{a} + \frac{1}{2} \omega_c \hat{\sigma}_z + \lambda_0 (\hat{\sigma}_+ \hat{a} + \hat{a}^\dagger \hat{\sigma}_-). \quad (4)$$

Next, we consider a more general scenario, substituting $\omega \rightarrow \omega(t) = \omega_0 + f(t)$, $\lambda_0 \rightarrow \lambda(t) = \lambda_0(1 + f(t)/\omega_0)^{1/2}$ and $\chi(t) = \chi_0 + \varepsilon f(t)$ [23, 24]. In addition we consider the presence of the term $\kappa(t)$ standing for the time-dependent loss affecting the *CPB*, the term $\delta(t)$ being the same for the *NR*, and $\chi(t)$ is the response time of the Kerr medium. This extended and somewhat realistic scenario requires the substitution of the Hamiltonian \hat{H}_{eff} by the Hamiltonian $\hat{\mathcal{H}}$ given by

$$\hat{\mathcal{H}} = \omega(t) \hat{a}^\dagger \hat{a} + \frac{1}{2} \omega_c(t) \hat{\sigma}_z + \lambda(t) (\hat{a} \hat{\sigma}_+ + \hat{a}^\dagger \hat{\sigma}_-) + \chi(t) \hat{a}^{\dagger 2} \hat{a}^2 - \frac{i}{2} \kappa(t) |1\rangle\langle 1| - \frac{i}{2} \delta(t) \hat{a}^\dagger \hat{a}. \quad (5)$$

In the Eq. (5) the first (second) term describes the *NR* (*CPB*) subsystem, the third term represents the *CPB-NR* coupling, the fourth term stands for the time dependence of the Kerr medium, the fifth and the sixth terms, $\kappa(t)$ and $\delta(t)$, were mentioned above. The operators $\sigma_\pm = \sigma_x \pm i\sigma_y$ leads to $\hat{\sigma}_+ = |1\rangle\langle 0|$, $\hat{\sigma}_- = |0\rangle\langle 1|$;

$\kappa(t)$ is the *CPB* decay coefficient from the excited level $|1\rangle$ to the fundamental state $|0\rangle$, $\delta(t)$ is the same for the *NR* and $\lambda(t)$ is the time-dependent coupling between the *CPB* and *NR*. Actually, the inclusion of loss in the system turns its treatment somewhat more realistic since dissipation is ubiquitous in the real world; as consequence

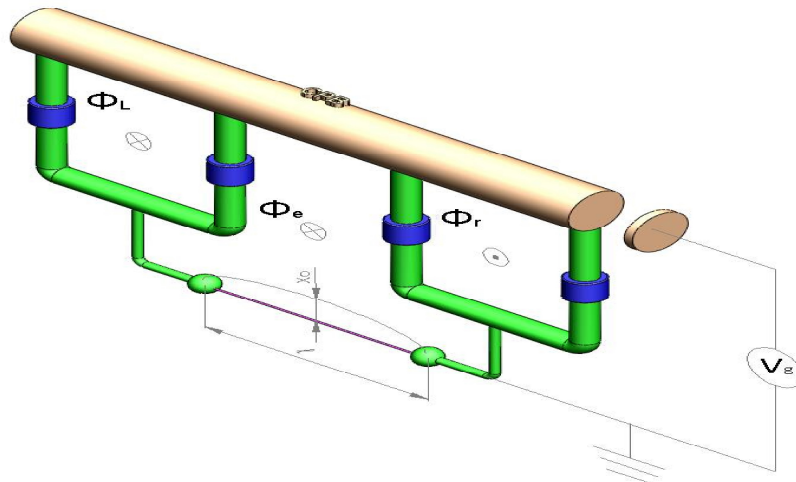

FIG. 1. Model for the CPB-NR coupling.

the Eq. (5) corresponds to the evolution of a system described by a non-Hermitian Hamiltonian [25–29]. On the other hand, as the response time of the Kerr medium is assumed so fast the medium follows the NR adiabatically and the third-order nonlinear susceptibility can be modulated by the NR frequency $\omega(t)$.

The wave function that describes our system can be written as,

$$|\Psi(t)\rangle = \sum_n [C_{1,n}(t)|1,n\rangle + C_{0,n}(t)|0,n\rangle], \quad (6)$$

where $C_{1,n}(t)$ and $C_{0,n}(t)$ are respectively the probability amplitudes of the states $|1,n\rangle$ and $|0,n\rangle$, namely, the CPB in its excited state $|1\rangle$ or ground state $|0\rangle$ with elementary excitations n in the NR. As mentioned before, at $t = 0$ the system is decoupled, the CPB initially in its excited state $|1\rangle$ and the NR in a coherent state $|\alpha\rangle$,

given by

$$|\alpha\rangle = \sum_{n=0}^{\infty} F_n |n\rangle. \quad (7)$$

The total wave function in the initial state can be written as $|\Psi(0)\rangle = \sum_n F_n |1,n\rangle$, with the initial amplitudes $C_{0,n}(0) = 0$ and $\sum_{n=0}^{\infty} |C_{1,n}(0)|^2 = 1$. The Schrödinger equation for the present system, described by non-Hermitian and time-dependent Hamiltonian in the Eq. (5) is,

$$\frac{d|\Psi(t)\rangle}{dt} = -i\hat{\mathcal{H}}|\Psi(t)\rangle. \quad (8)$$

We obtain the following set of coupled equations of motion for the amplitude probabilities $C_{1,n}(t)$ and $C_{0,n+1}(t)$:

$$\frac{\partial C_{1,n}(t)}{\partial t} = \left(-in\omega(t) - i\frac{\omega_c(t)}{2} - i\chi(t)(n^2 - n) - \frac{1}{2}(\kappa(t) + n\delta(t)) \right) C_{1,n}(t) - i\lambda(t)\sqrt{(n+1)}C_{0,n+1}(t), \quad (9)$$

$$\frac{\partial C_{0,n+1}(t)}{\partial t} = \left(-i(n+1)\omega(t) + i\frac{\omega_c(t)}{2} - i\chi(t)(n^2 + n) - \frac{1}{2}(n+1)\delta(t) \right) C_{0,n+1}(t) - i\lambda(t)\sqrt{(n+1)}C_{1,n}(t), \quad (10)$$

whose solutions allow us to calculate the entropy of the NR subsystem and the population inversion of the CPB.

III. TIME EVOLUTION OF THE POPULATION INVERSION

The present approach also allows us to investigate the CPB dynamics in a non perturbative way. A convenient

way to characterize the response to the NR influence is given by the CPB population inversion. This parameter is defined as

$$I(t) = \sum_{n=0}^{\infty} \left[|C_{1,n}(t)|^2 - |C_{0,n+1}(t)|^2 \right]. \quad (11)$$

To calculate this property $I(t)$ we will assume the NR frequency varying with time as $\omega(t) = \omega_0 + f(t)$. The third order nonlinear susceptibility is modulated as $\chi(t) = \chi_0 + \varepsilon f(t)$ and we also assume the NR initially in a coherent state with the mean excitation number $\bar{n} = 25$ and $\frac{\omega_a}{\lambda_0} = \frac{\omega_0}{\lambda_0} = 20k$. We consider the time evolution of the population inversion for different values of the decay coefficients $\kappa(t)$ and $\delta(t)$.

A. Resonant case: $f(t) = 0$

If the model is restricted to the usual case, with the NR frequency constant, the Eqs. (9 and 10) can be solved numerically. In Figure (2 a) we plotted the inversion $I(t)$ as a function of time. In absence of losses the average inversion, defined by its value during the collapse, is greater than zero, close to 0.5, when we consider the value $\frac{\chi_0}{\lambda_0} = 0.2$. However, as well known, neglecting the presence of the Kerr medium ($\frac{\chi_0}{\lambda_0} = 0$), the value of the average inversion vanishes.

Here the third-order nonlinear susceptibility represents the coupling of the NR and the Kerr medium. The higher the value of χ the stronger the coupling of the NR with the Kerr medium, and reversely. Considering the case $\frac{\chi_0}{\lambda_0} = 0.2$ and the system with no loss ($\kappa(t) = \delta(t) = 0$) we observe the collapse-revival effect (see Fig.(2 a)). In this figure, the horizontal line crossing the value $I(t) = 0.5$ of the average inversion is due to the presence of nonlinearity, whose absence turns the average inversion null. We note in this figure the amplitude of oscillation decreasing with time, due to the presence of the Kerr medium. However, when considering only the CPB loss ($\kappa(t) \neq 0$, $\delta(t) = 0$) the collapse-revival effect reappears, with subsequent oscillations that smoothly vanish (see Fig. (2 b)). Contrarily, when considering only loss in the NR ($\kappa(t) = 0$, $\delta(t) \neq 0$) these oscillations rapidly vanish. So the spoiling effect caused by the NR loss dominates that coming from the CPB loss, see Fig. (2 c) and (2 b).

B. Off-resonant case: $f(t) = \tau \sin(\omega t)$

When the system is non resonant, with $\frac{\tau}{\lambda_0} = 10$ and $\frac{\omega'}{\lambda_0} = 1$, and assuming only CPB loss ($\kappa(t) \neq 0$, $\delta(t) = 0$), we observe periodical behavior of the population inversion, its amplitude decaying over time - see Fig.(3 a); in this case the collapse-revival effect is not observed. However, this behavior is modified when the loss comes from the NR : in this case the inversion and the oscillations are destroyed. Considering ω' increasing and only the

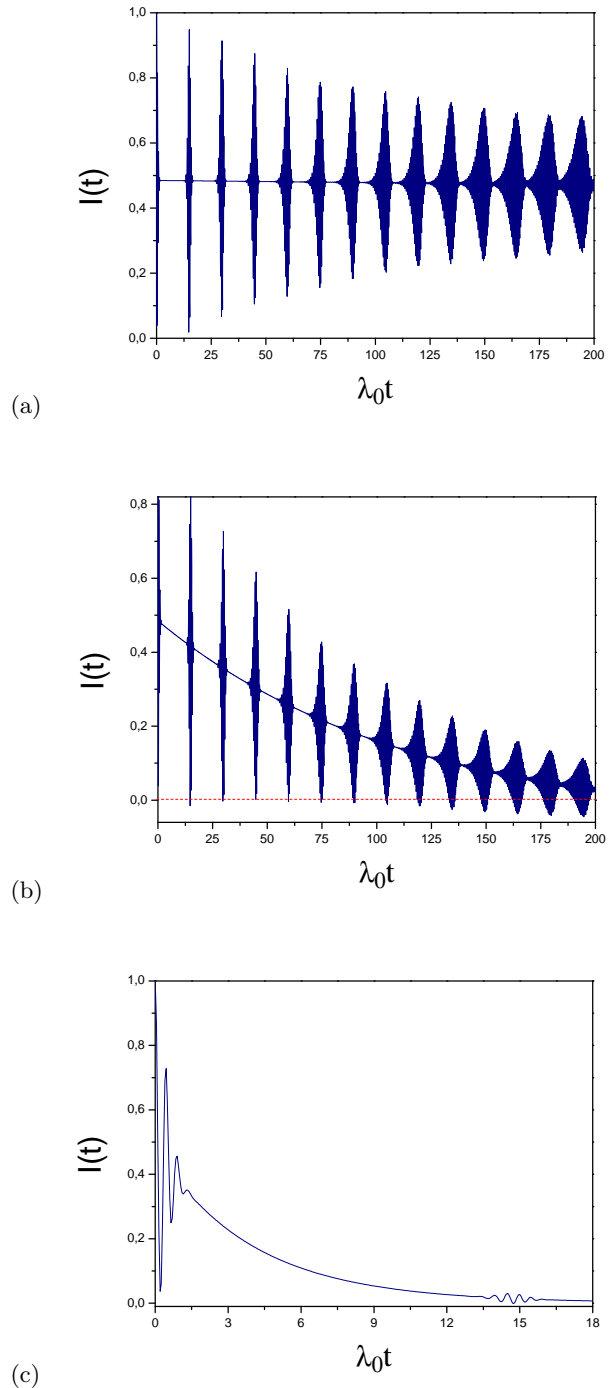

FIG. 2. Time evolution of the population inversion for different values of the parameters $\kappa(t)$ and $\delta(t)$ for: $\langle n \rangle = 25$, $\omega_0/\lambda_0 = \omega_c/\lambda_0 = 20k$, $f(t) = 0$; $\chi_0/\lambda_0 = 0.2$; (a) $\kappa/\lambda_0 = 0.0$ and $\delta/\lambda_0 = 0.0$; (b) $\kappa/\lambda_0 = 0.01$ and $\delta/\lambda_0 = 0.0$; (c) $\kappa/\lambda_0 = 0.0$ and $\delta/\lambda_0 = 0.01$.

CPB loss - see Fig.(3 b), the system continues displaying the population inversion and oscillations, the latter exhibiting small periods, an effect not shown when the loss

comes only from the NR - see Fig.(3 c).

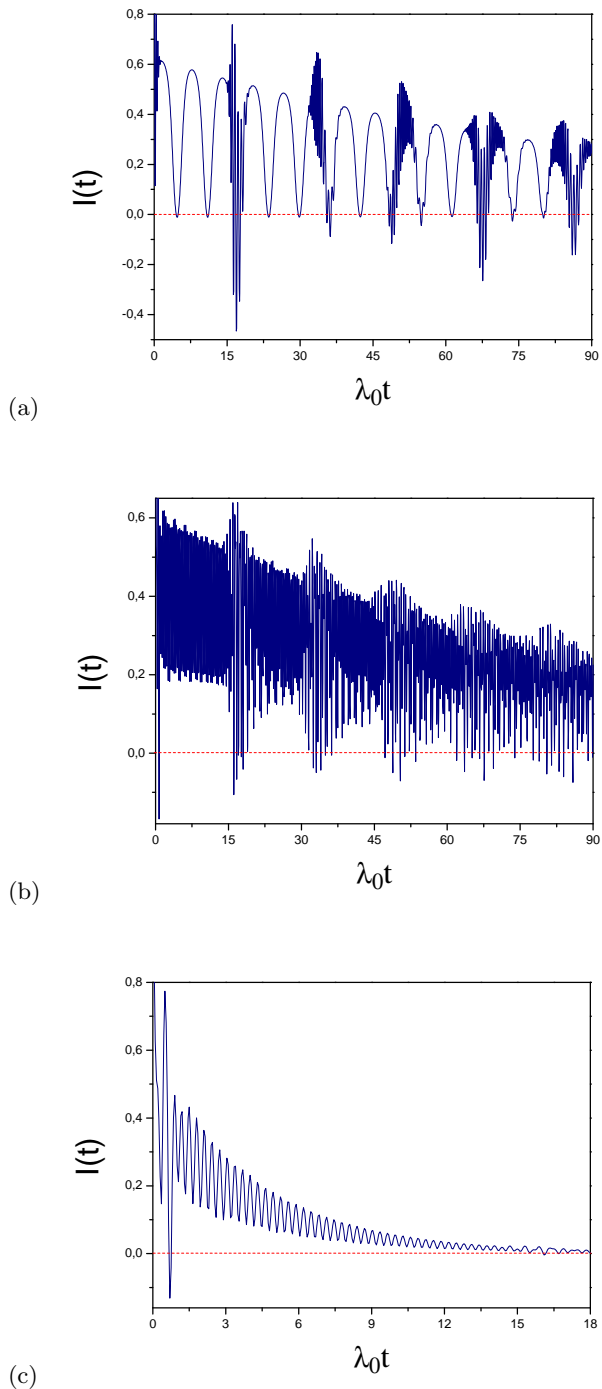

FIG. 3. Time evolution of the population inversion for different values of the parameters $\kappa(t)$ and $\delta(t)$ for: $\langle n \rangle = 25$, $\omega_0/\lambda_0 = \omega_c/\lambda_0 = 20k$, $\varepsilon/\lambda_0 = 0.001$; $\tau/\lambda_0 = 10$; $f(t) = \tau \sin(\omega t)$; $\chi_0/\lambda_0 = 0.2$; (a) $\kappa/\lambda_0 = 0.01$; $\delta/\lambda_0 = 0.0$ and $\omega'/\lambda_0 = 1$; (b) $\kappa/\lambda_0 = 0.01$; $\delta/\lambda_0 = 0.0$ and $\omega'/\lambda_0 = 20$; (c) $\kappa/\lambda_0 = 0.0$; $\delta/\lambda_0 = 0.01$ and $\omega'/\lambda_0 = 20$.

IV. TIME EVOLUTION OF THE ENTROPY

Nowadays some devices are based on quantum mechanical phenomena, and this holds also for information transmission. For example, in optical communication a polarized photon can carry information. Now, the entropy of entanglement is defined for pure states as the von Neumann entropy of one of the reduced states, e.g., the NR entropy,

$$S_{NR}(t) = - \{ \pi_{NR}^+(t) \ln \pi_{NR}^+(t) + \pi_{NR}^-(t) \ln \pi_{NR}^-(t) \}, \quad (12)$$

where $\pi_{NR}^\pm(t) = \frac{1}{2}(\langle C|C \rangle + \langle S|S \rangle \pm \frac{1}{2}[(\langle C|C \rangle - \langle S|S \rangle)^2 + 4|\langle C|S \rangle|^2]^{1/2})$ with $\langle C|C \rangle = \sum_{n=0}^{\infty} |C_{1,n}(t)|^2$, $\langle S|S \rangle = \sum_{n=0}^{\infty} |C_{0,n+1}(t)|^2$, and $\langle C|S \rangle = \langle S|C \rangle^* = \sum_{n=0}^{\infty} C_{1,n+1}^*(t)C_{0,n+1}(t)$.

In our calculations using the Eq. (12) we will assume the NR frequency varying in the form $\omega(t) = \omega_0 + f(t)$. The third order nonlinear susceptibility is modulated in the form $\chi(t) = \chi_0 + \varepsilon f(t)$ and we also assume the initial NR in a coherent state with the mean number of photon $\bar{n} = 25$ and $\frac{\omega_c}{\lambda_0} = \frac{\omega_0}{\lambda_0} = 20k$. Next we will consider the time evolution of the entropy for different values of the decay coefficients $\kappa(t)$ and $\delta(t)$.

A. Resonant case: $f(t) = 0$

We will use the values of parameters in Fig. (4). In an ideal system the parameters $\kappa(t)$ and $\delta(t)$ are null, as assumed in Fig. (4 a): in this figure the maximum of the NR entropy is close to $\ln 2$; after the start of the interaction the NR entropy gradually tends to its minimum, then returns to its maximum and remains oscillating regularly.

For small values of decay in the CPB , as $\frac{\kappa}{\lambda_0} = 0.01$, and ideal NR ($\delta = 0$) for the case $\frac{\chi_0}{\lambda_0} = 0.2$, the maximum value of the entropy shows no significant changes for small times - see Fig. (4 b). For larger values of time the amplitude of the entropy oscillations decreases, maintaining the periodicity. If instead we add a small loss only in the NR , say $\frac{\delta}{\lambda_0} = 0.01$, the entropy oscillations vanishes rapidly (cf. Fig. (4 c)), showing the entropy being more sensitive to the loss in the NR than that in the CPB . For larger value of $\delta(t)$ and $\kappa(t)$ the entropy movies rapidly to zero, as expected, due to the passage of both subsystems to their respective ground states.

B. Off-resonant case: $f(t) = \tau \sin(\omega t)$

Let us now consider the variation in the detuning parameter, where τ and ω' are parameters that modulates the NR frequency. Our discussion is limited to the condition $\tau \ll \omega_c$, ω_0 and also assuming that ω' is small to avoid interaction of the CPB with other modes of the NR . We have chosen various values τ of amplitude modulations to verify the entanglement properties between the

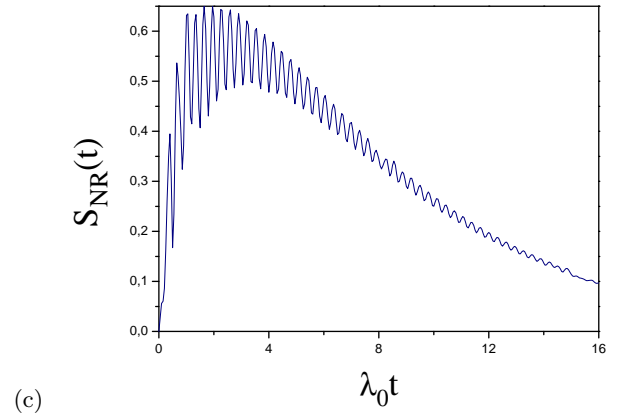
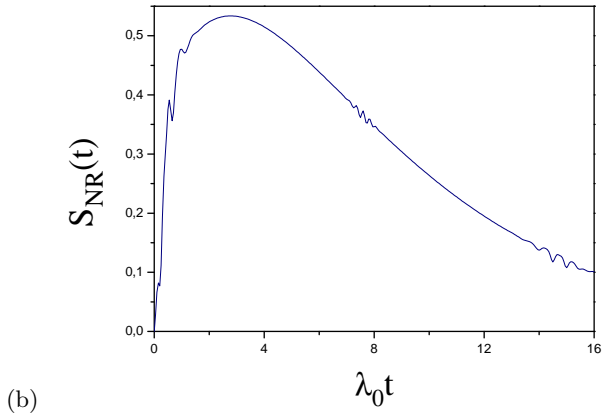
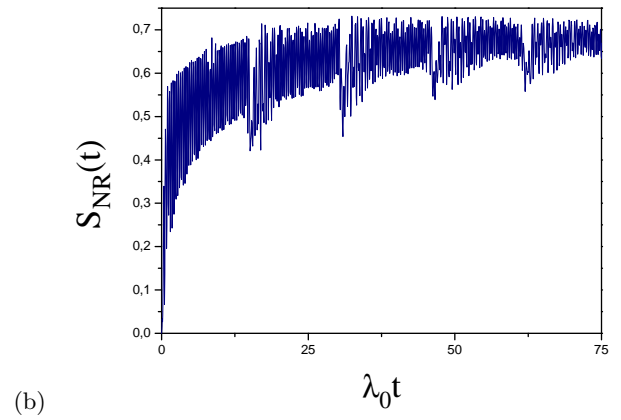
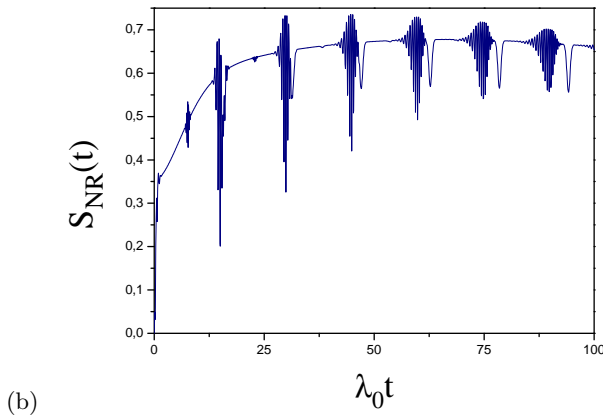
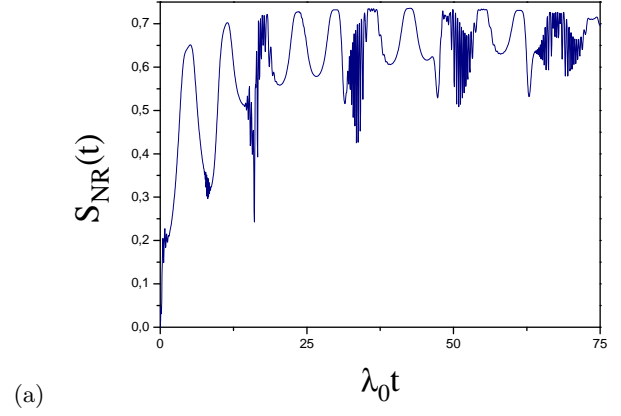
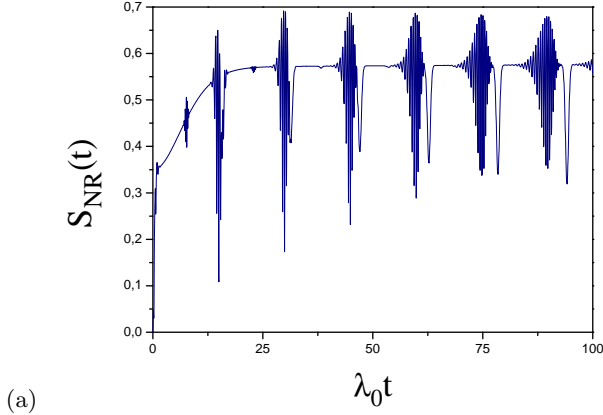

FIG. 4. Time evolution of the entropy for different values of the parameters $\kappa(t)$ and $\delta(t)$ for: $\langle n \rangle = 25$, $\omega_c/\lambda_0 = \omega_0/\lambda_0 = 20k$, $\chi_0/\lambda_0 = 0.2$, $f(t) = 0$. (a) $\kappa/\lambda_0 = 0, 0\lambda_0$ and $\delta/\lambda_0 = 0.0$; (b) $\kappa/\lambda_0 = 0.01$ and $\delta/\lambda_0 = 0.0$; (c) $\kappa/\lambda_0 = 0.0$ and $\delta/\lambda_0 = 0.01$.

FIG. 5. Time evolution of the entropy for different values of the parameters $\kappa(t)$ and $\delta(t)$ for: $\langle n \rangle = 25$, $\omega_c/\lambda_0 = \omega_0/\lambda_0 = 20k$, $\chi_0/\lambda_0 = 0.2$, $\tau/\lambda_0 = 10$, and $\varepsilon/\lambda_0 = 0.001$. (a) $\kappa/\lambda_0 = 0.01$, $\delta/\lambda_0 = 0.0$, and $\omega'/\lambda_0 = 1$; (b) $\kappa/\lambda_0 = 0.01$, $\delta/\lambda_0 = 0.0$, and $\omega'/\lambda_0 = 20$; (c) $\kappa/\lambda_0 = 0.0$, $\delta/\lambda_0 = 0.01$, and $\omega'/\lambda_0 = 20$.

CPB and *NR*. We also use various values ω' of frequency modulation to see its influence upon the *CPB-NR* entanglement - see Figs. (5). Comparing the Fig. (4 a) with

the Fig. (5 a), we note that the entropy loses its periodic oscillations, and when ω' increases this behavior

becomes more evident - see Fig. (5 b). Now, comparing the entropy in Fig. (4 c) with that in Fig. (5 c), keeping the same parameters, we see the entropy going to zero in both cases, but the Fig. (5 c) displays an interesting effect: even in presence losses, the maximum value of the entropy grows, reaching the value $\ln 2$, after which it oscillates downward. This effect came from the sinusoidal modulation of the NR frequency

V. CONCLUSION

In the present work we have considered the interaction of a CPB and an NR in the presence of a Kerr medium and losses affecting both subsystems. Concerning the influence of the loss affecting the entropy of both subsystems and the population inversion of the CPB we have observed the dominant role played by the NR upon that played by the CPB . The dissipation causes deterioration of the CPB excited level whereas convenient modulations favors the control of certain properties of the system. It

was also shown that certain choice of the time-dependent frequency makes higher the maximum value of the entropy, even in the presence of dissipation (see Figs. (4 c) and Fig. (5 c)) the same occurring for the CPB population inversion - see Figs. (2 c) and Fig. (3 c). Concerning the entropy, this result is very important for information transmission since the transmission of maximum information through a quantum channel is exactly the von Neumann entropy [30, 31]. These effects are very sensitive to detuning ($\approx 0.04\%$) and disappear in resonant regime. The results suggest that it is possible to perform a dynamic control of certain properties of this system, via convenient manipulation of the parameters. We hope that these results might shed light in this scenario, furnishing new insights for researchers in this area.

VI. ACKNOWLEDGMENTS

We thank the CNPq and FAPEG for the partial supports.

-
- [1] Y. Nakamura, Y. A. Pashkin, and J. Tsai, *Coherent control of macroscopic quantum states in a single-cooper-pair box*, Nature **398**, 798 (1999).
- [2] A. Wallraff, D. Schuster, A. Blais, L. Frunzio, R.-S. Huang, J. Majer, S. Kumar, S. Girvin, and R. Schoelkopf, *Strong coupling of a single photon to a superconducting qubit using circuit quantum electrodynamics*, Nature **431**, 162 (2004).
- [3] M. Zhang, J. Zou, and B. Shao, *Quantum dynamics of a single cooperpair box with a single-mode cavity field*, Int. J. Mod. Phys. B **16**, 4767, 2002.
- [4] A.-S. Obada, N. Metwally, D. M. Abo-kahla, and M. Abdel Aty, *The quantum computational speed of a single cooper pair box*, Physica E **43**, 1792 (2011).
- [5] A.-H. M. Ahmed, L. Y. Cheong, N. Zakaria, and N. Metwally, *Dynamics of information coded in a single cooper pair box*, Int. J. Theor. Phys. **52**, 1979 (2013).
- [6] Z. Bian, F. Chudak, W. G. Macready, L. Clark, and F. Gaitan, *Experimental determination of ramsey numbers*, Phys. Rev. Lett. **111**, 130505 (2013).
- [7] C. Valverde and B. Baseia, *Engineering information in states of a nanomechanical resonator coupled to a Cooper pair box*, Quantum Inf. Process. **12**, 2019 (2013).
- [8] C. Valverde, A. T. Avelar, and B. Baseia, *Quantum communication via controlled holes in the statistical distribution of excitations in a nanoresonator coupled to a Cooper pair box*, Chin. Phys. B **21**, 030308 (2012).
- [9] C. K. Law, S. Y. Zhu, and M. S. Zubairy, *Modification of a vacuum Rabi splitting via a frequency modulated cavity mode*, Phys. Rev. A **52**, 4095 (1995).
- [10] M. Janowicz, *Evolution of wave fields and atom-field interactions in a cavity with one oscillating mirror*, Phys. Rev. A **57**, 4784 (1998).
- [11] M. S. Abdalla, M. Abdel-Aty, and A. S. F. OBADA, *Entropy and entanglement of time dependent two-mode Jaynes-Cummings model*, Physica A **326**, 203 (2003).
- [12] Y. P. Yang, J. P. Xu, LI, G. X. e CHEN, H., *Interactions of a two-level atom and a field with a time-varying frequency*, Phys. Rev. A **69**, 053406 (2004).
- [13] S.N. Shevchenko, S. Ashhab and F. Nori, *Landau-Zener-Stückelberg interferometry*, Physics Reports **492**, 1 (2010).
- [14] J. Q. You and F. Nori, *Atomic physics and quantum optics using superconducting circuits*, Nature **474**, 589 (2011).
- [15] P.D. Nation, J.R. Johansson, M.P. Blencowe, and F. Nori, *Colloquium: Stimulating uncertainty: Amplifying the quantum vacuum with superconducting circuits*, Rev. Mod. Phys. **84**, 1 (2012).
- [16] I. M. Georgescu, S. Ashhab and F. Nori, *Quantum simulation*, Rev. Mod. Phys. **86**, 153 (2014).
- [17] I. Buluta, S. Ashhab and F. Nori, *Natural and artificial atoms for quantum computation*, Reports on Progress in Physics **74**, 104401 (2011).
- [18] C. P. Sun, L. F. Wei, Yu-xi Liu, and F. Nori, *Quantum transducers: Integrating transmission lines and nanomechanical resonators via charge qubits*, Phys. Rev. A **73**, 022318 (2006).
- [19] Yu-xi Liu, A. Miranowicz, Y. B. Gao, J. Bajer, C. P. Sun and F. Nori, *Qubit-induced phonon blockade as a signature of quantum behavior in nanomechanical resonators*, Phys. Rev. A **82**, 032101 (2010).
- [20] Fei Xue, Yu-xi Liu, C. P. Sun and F. Nori, *Two-mode squeezed states and entangled states of two mechanical resonators*, Phys. Rev. B **76**, 064305 (2007).
- [21] M. Grajcar, S. Ashhab, J. R. Johansson and F. Nori, *Lower limit on the achievable temperature in resonator-based sideband cooling*, Phys. Rev. B **78**, 035406 (2008).
- [22] J. R. Johansson, N. Lambert, I. Mahboob, H. Yamaguchi and F. Nori, *Entangled-state generation and Bell inequality violations in nanomechanical resonators*, Phys. Rev. B **90**, 174307 (2014).

- [23] C. Valverde, A.T. Avelar, and B. Baseia, *Controlling statistical properties of a Cooper pair box interacting with a nanomechanical resonator*, Physica A **390**, 4045 (2011).
- [24] C. Valverde, H. C. B. de Oliveira, A. T. Avelar, and B. Baseia, *Controlling Excitation Inversion of a Cooper Pair Box Interacting with a Nanomechanical Resonator*, Chin. Phys. Lett. **29**, 080303 (2012).
- [25] F. Bagarello, M. Lattuca, R. Passante, L. Rizzuto and S. Spagnolo, *Non-Hermitian Hamiltonian for a modulated Jaynes-Cummings model with PT symmetry*, Phys. Rev. A **91**, 042134 (2015).
- [26] B. Peng, S. K. Ozdemir, F. Lei, F. Monifi, M. Gianfreda, G. L. Long, S. Fan, F. Nori, C. M. Bender, and L. Yang, *Parity-timesymmetric whispering-gallery micro-cavities*, Nat. Phys. **10**, 394 (2014).
- [27] C. M. Bender and S. Boettcher, *Real spectra of non-hermitian hamiltonian having PT symmetry*, Phys. Rev. Lett. **80**, 5243(1998).
- [28] C. M. Bender, D. C. Brody, and H. F. Jones, *Complex extension of quantum mechanics*, Phys. Rev. Lett. **89**, 270401 (2002).
- [29] C. M. Bender, *Making sense of non-Hermitian hamiltonians*, Rep. Prog. Phys. **70**, 947 (2007).
- [30] A. Peres, *Quantum Theory: Concepts and Methods*, Kluwer (1993).
- [31] D. Petz, *Properties of quantum entropy*, in *Quantum Probability and Related Topics VII*, 275–297, World Sci. Publishing (1992).