

Categorified trace for module tensor categories over braided tensor categories

André Henriques, David Penneys, and James Tener

September 11, 2015

Abstract

Given a braided pivotal category \mathcal{C} and a pivotal module tensor category \mathcal{M} , we define a functor $\mathrm{Tr}_{\mathcal{C}} : \mathcal{M} \rightarrow \mathcal{C}$, called the associated categorified trace. By a result of Bezrukavnikov, Finkelberg and Ostrik, the functor $\mathrm{Tr}_{\mathcal{C}}$ comes equipped with natural isomorphisms $\tau_{x,y} : \mathrm{Tr}_{\mathcal{C}}(x \otimes y) \rightarrow \mathrm{Tr}_{\mathcal{C}}(y \otimes x)$, which we call the traciators. This situation lends itself to a diagrammatic calculus of ‘strings on cylinders’, where the traciator corresponds to wrapping a string around the back of a cylinder. We show that $\mathrm{Tr}_{\mathcal{C}}$ in fact has a much richer graphical calculus in which the tubes are allowed to branch and braid. Given algebra objects A and B , we prove that $\mathrm{Tr}_{\mathcal{C}}(A)$ and $\mathrm{Tr}_{\mathcal{C}}(A \otimes B)$ are again algebra objects. Moreover, provided certain mild assumptions are satisfied, $\mathrm{Tr}_{\mathcal{C}}(A)$ and $\mathrm{Tr}_{\mathcal{C}}(A \otimes B)$ are semisimple whenever A and B are semisimple.

Contents

1	Introduction	2
2	Background	6
2.1	Tensor categories	6
2.2	The Drinfel’d center	9
2.3	Synoptic chart of tensor categories	10
2.4	Algebra objects	11
3	Categorified traces for module tensor categories	13
3.1	Categorified traces	13
3.2	Module tensor categories	15
3.3	The categorified trace associated to a module tensor category	17
4	Properties of the trace functor	19
4.1	The attaching map	20
4.2	The multiplication map	21
4.3	The unit of the adjunction	23
4.4	Construction of the traciator	25
4.5	Interaction between traciator and braiding	28

5	Traces of algebras and semisimplicity	32
5.1	The algebra $\mathrm{Tr}_{\mathcal{C}}(A)$	32
5.2	The algebra $\mathrm{Tr}_{\mathcal{C}}(A \otimes B)$	36
A	Appendix	41
A.1	Commutative algebras in braided tensor categories	41
A.2	Braided pivotal categories	43

1 Introduction

A *tensor category* is a linear category \mathcal{M} , equipped with a functor $\otimes : \mathcal{M} \times \mathcal{M} \rightarrow \mathcal{M}$ along with extra data encoding the ideas of associativity and unitality. If x is an object of \mathcal{M} , then its dual x^* is characterized, assuming it exists, by adjunctions $\mathrm{Hom}(y, x \otimes z) \cong \mathrm{Hom}(x^* \otimes y, z)$ and $\mathrm{Hom}(y \otimes x, z) \cong \mathrm{Hom}(y, z \otimes x^*)$. The category \mathcal{M} is *pivotal* if it comes equipped with certain isomorphisms $\varphi_x : x \rightarrow x^{**}$ from every object to its double dual. It is interesting to note that, in a pivotal category, the functor $x \mapsto \mathrm{Hom}(1, x)$ satisfies the following cyclic invariance property:

$$\begin{aligned} \mathrm{Hom}(1, x \otimes y) &\cong \mathrm{Hom}(x^* \otimes 1, y) \cong \mathrm{Hom}(1 \otimes x^*, y) \\ &\cong \mathrm{Hom}(1, y \otimes x^{**}) \cong \mathrm{Hom}(1, y \otimes x). \end{aligned}$$

We think of $\mathrm{Hom}(1, -)$ as a vector space valued trace $\mathrm{Tr} : \mathcal{M} \rightarrow \mathbf{Vec}$. This is our prototypic example of a *categorified trace*.

Given a tensor category \mathcal{C} , and two objects x, y of some module category \mathcal{M} , the internal hom $\underline{\mathrm{Hom}}(x, y)$ is the object of \mathcal{C} that represents the exact functor $c \mapsto \mathcal{M}(c \cdot x, y)$ [Ost03, Def. 3.4]. If in addition to being a module category \mathcal{M} is also a tensor category in its own right, then we may consider the functor

$$\mathrm{Tr}_{\mathcal{C}} := \underline{\mathrm{Hom}}(1_{\mathcal{M}}, -) : \mathcal{M} \rightarrow \mathcal{C},$$

and ask whether it has a similar cyclic invariance property.

The appropriate compatibility between the \mathcal{C} -module structure and the tensor structure of \mathcal{M} can only be formulated when \mathcal{C} is braided, and the resulting notion is what we call a *module tensor category* (Definition 3.5). We write $\Phi : \mathcal{C} \rightarrow \mathcal{M}$ for the functor that sends $c \in \mathcal{C}$ to $c \cdot 1_{\mathcal{M}} \in \mathcal{M}$. By definition, equipping \mathcal{M} with the structure of a module tensor category over \mathcal{C} is the same thing as equipping the functor Φ with a factorization

$$\mathcal{C} \xrightarrow{\Phi^{\mathcal{Z}}} \mathcal{Z}(\mathcal{M}) \longrightarrow \mathcal{M},$$

where $\Phi^{\mathcal{Z}}$ is a braided functor to the Drinfel'd center of \mathcal{M} [Bez04, Def. 1] [DMNO13, Def. 2.4]. The trace functor can be alternatively described as the right adjoint of Φ :

$$\begin{array}{ccc} & \mathcal{Z}(\mathcal{M}) & \\ \Phi^{\mathcal{Z}} \nearrow & & \searrow \\ \mathcal{C} & \xrightarrow{\Phi} & \mathcal{M} \\ & \xleftarrow{\mathrm{Tr}_{\mathcal{C}}} & \end{array}$$

A *categorified trace* (Definition 3.1), also known as a commutator functor [BFO09, §6], [Ost14, Def. 2.1], is a functor $\text{Tr} : \mathcal{M} \rightarrow \mathcal{C}$ equipped with natural isomorphisms

$$\tau_{x,y} : \text{Tr}(x \otimes y) \rightarrow \text{Tr}(y \otimes x),$$

which we call the *traciators*, subject to the axiom $\tau_{x,y \otimes z} = \tau_{z \otimes x,y} \circ \tau_{x \otimes y,z}$. We denote a categorified trace graphically by lifting objects and morphisms up from the plane (corresponding to \mathcal{M}) onto a cylinder in 3-space (corresponding to \mathcal{C})

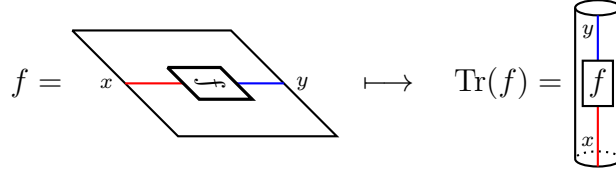

Following [PS13]¹, the traciator is represented graphically by a strand wrapping around the cylinder:

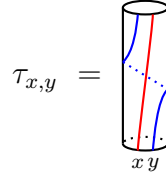

When \mathcal{C} and \mathcal{M} are pivotal and Φ^z is a pivotal functor, then $\text{Tr}_{\mathcal{C}}$ is a categorified trace. In fact, this only depends on Φ factoring through the Drinfel'd center, and not on it being a tensor functor, as proven in [BFO09, Prop. 5] and [Ost14, Prop. 2.5].

The fact that Φ is a tensor functor contributes to the structure of $\text{Tr}_{\mathcal{C}}$ in a different way. Adjoints of tensor functors are lax monoidal [Kel74], and so we have unit and multiplication maps $i : 1_{\mathcal{C}} \rightarrow \text{Tr}_{\mathcal{C}}(1_{\mathcal{M}})$ and $\mu_{x,y} : \text{Tr}_{\mathcal{C}}(x) \otimes \text{Tr}_{\mathcal{C}}(y) \rightarrow \text{Tr}_{\mathcal{C}}(x \otimes y)$ which we represent graphically as follows:

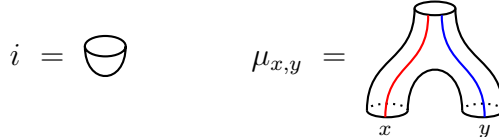

The novelty of this paper is the rich interplay between the above two structures. Using everything we have, we can assign a morphism to any picture of strands on tubes. These, in turn, can be used to formulate a number of non-trivial identities, such as

$$\begin{array}{ccc} \text{Tr}_{\mathcal{C}}(x) \otimes \text{Tr}_{\mathcal{C}}(y) & \xrightarrow{\mu} & \text{Tr}_{\mathcal{C}}(x \otimes y) \\ \beta \circ (\text{id} \otimes \theta) \downarrow & & \downarrow \tau \\ \text{Tr}_{\mathcal{C}}(y) \otimes \text{Tr}_{\mathcal{C}}(x) & \xrightarrow{\mu} & \text{Tr}_{\mathcal{C}}(y \otimes x) \end{array}$$

¹See Remark 3.2 for a subtle difference between our notion of categorified trace and the one used in [PS13].

and

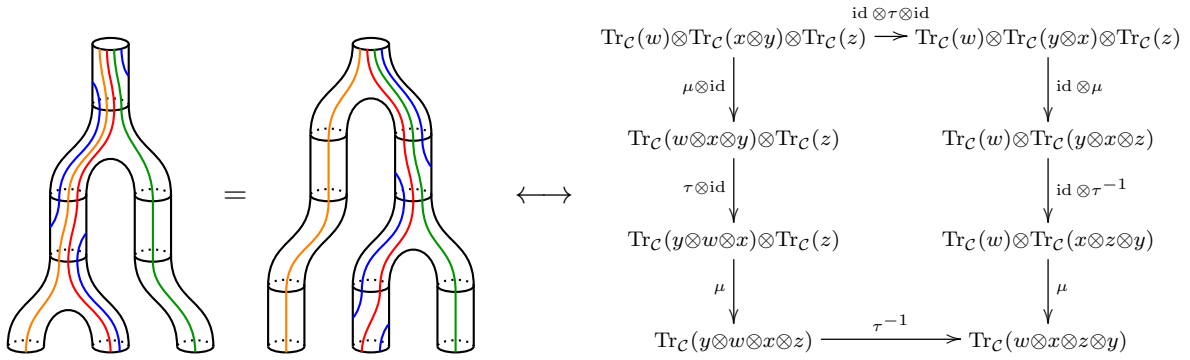

which combine the traciator and multiplication maps with the braiding and the twist of \mathcal{C} (see Lemmas 4.26 and 4.19). We summarize the situation in Figure 1.

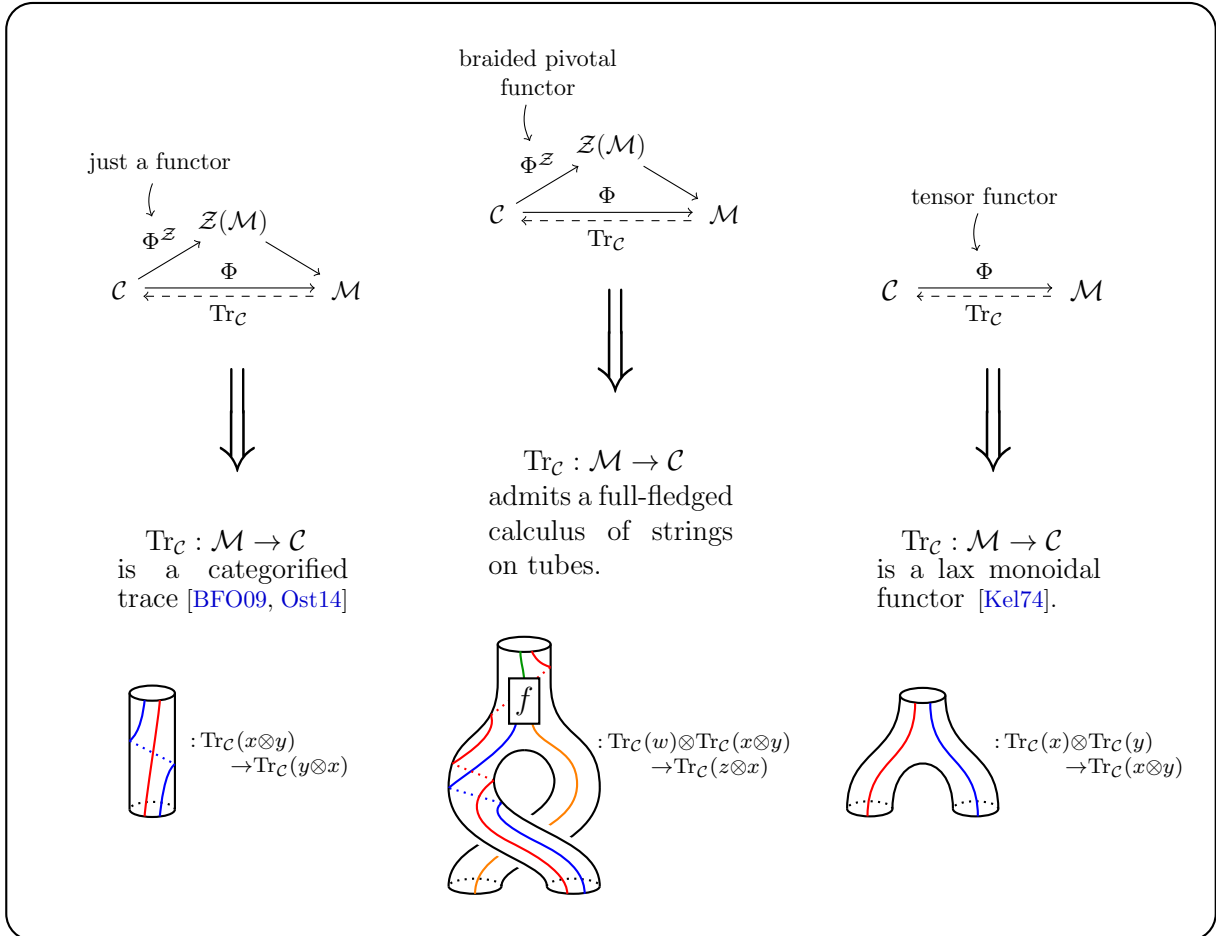

Figure 1: Our setup (in the middle), in comparison to previously studied situations.

In our sequel paper [HPT15], we will prove that the relations established in this paper imply that the morphism assigned to a diagram is invariant under *all* isotopies. This

verification will be performed in the language of planar algebras internal to braided tensor categories. In our forthcoming paper, we will later classify planar algebras internal to \mathcal{C} in terms of module tensor categories for \mathcal{C} .

It is well known that lax tensor functors send algebras to algebras. As a result, if A is an algebra object in \mathcal{M} , then $\mathrm{Tr}_{\mathcal{C}}(A)$ is an algebra object in \mathcal{C} . In our situation, more is true. If A and B are two algebra objects, then $\mathrm{Tr}_{\mathcal{C}}(A \otimes B)$ is again an algebra object (actually, this only requires \mathcal{C} and Φ^z to be monoidal, as opposed to braided). The structure maps are best illustrated by putting the strand corresponding to A on the front of the cylinders, and the one corresponding to B on the back of the cylinders:

$$m_{\mathrm{Tr}_{\mathcal{C}}(A \otimes B)} = \begin{array}{c} \text{Diagram: A cylinder with two strands on the front and two on the back. The front strands are red and the back strands are blue. They meet at the top and bottom.} \end{array} \qquad i_{\mathrm{Tr}_{\mathcal{C}}(A \otimes B)} = \begin{array}{c} \text{Diagram: A cylinder with one red strand on the front and one blue strand on the back.} \end{array}$$

Let us now assume that \mathcal{C} and \mathcal{M} are fusion categories over a field of characteristic zero. One of our main results is that if A and B are semisimple algebras then so is $\mathrm{Tr}_{\mathcal{C}}(A \otimes B)$ (Theorem 5.6 and Corollary 5.9):

Theorem A. *Let \mathcal{C} and \mathcal{M} be tensor categories subject to the above assumptions, and let $\Phi^z : \mathcal{C} \rightarrow \mathcal{Z}(\mathcal{M})$ be a tensor functor. If $A, B \in \mathcal{M}$ are semisimple algebras, then $\mathrm{Tr}_{\mathcal{C}}(A \otimes B)$ is also semisimple.*

Alternatively, we can trade the extra assumptions on \mathcal{C} and \mathcal{M} for the assumption that A and B are separable algebras (Theorem 5.6). We illustrate our construction by computing the algebra $\mathrm{Tr}_{\mathcal{C}}(A \otimes B)$ for certain algebra objects related to the Coxeter–Dynkin diagrams E_7 and D_{10} (Example 5.10).

In the special case in which we have only one algebra, our result holds in the greater generality of an arbitrary tensor functor $\Phi : \mathcal{C} \rightarrow \mathcal{M}$ between rigid semisimple tensor categories (Theorem 5.1 and Corollary 5.3):

Theorem B. *Let \mathcal{C} and \mathcal{M} be tensor categories subject to the above assumptions, and let $\Phi : \mathcal{C} \rightarrow \mathcal{M}$ be a tensor functor with right adjoint $\mathrm{Tr}_{\mathcal{C}}$. If $A \in \mathcal{M}$ is a semisimple algebra, then $\mathrm{Tr}_{\mathcal{C}}(A)$ is as well. In particular, if A is semisimple connected, and thus Frobenius, then so is $\mathrm{Tr}_{\mathcal{C}}(A)$.*

1.1 Acknowledgements

The authors would like to thank Bojko Bakalov, Bruce Bartlett, Alexandru Chirvasitu, Vaughan Jones, Scott Morrison, Richard Ng, Victor Ostrik, Ingo Runkel, Chris Schommer-Pries, Noah Snyder, and Kevin Walker for helpful discussions.

The authors would like to thank Mathematisches Forschungsinstitut Oberwolfach for their hospitality during the workshop on “Subfactors and conformal field theory.” André Henriques gratefully acknowledges the Leverhulme trust for financing his visiting position in Oxford, and the Hausdorff Institute for its hospitality while visiting James Tener. James Tener would like to thank the Max Planck Institute for its hospitality and support during the course of this work. David Penneys and James Tener were partially supported by NSF

DMS grant 0856316. David Penneys was partially supported by an AMS-Simons travel grant and NSF DMS grant 1500387.

2 Background

The natural setting to study the categorified trace is when \mathcal{C} is a braided pivotal category, \mathcal{M} is a pivotal category, and $\Phi^z : \mathcal{C} \rightarrow \mathcal{Z}(\mathcal{M})$ is a braided pivotal functor. This is perhaps an unfamiliar setting, since most readers are more likely to work with either braided tensor categories or ribbon categories, and braided pivotal categories are a strange intermediate (see Figure 2 in Section 2.3).

For these reasons, it is important to carefully understand what we can and cannot do in a braided pivotal category. Moreover, in the literature there are sometimes redundancies within definitions, as well as incorrect statements, so we begin with a short, comprehensive background on various flavours of tensor categories. Various technical lemmas about braided pivotal categories are deferred to Appendix A.2. Finally, we provide a short section on algebras in tensor categories.

2.1 Tensor categories

We will usually assume that all our categories are linear over some field k (the morphism spaces are finite dimensional vector spaces), and that all functors are linear. However, the large majority of our results do not require this linearity assumption. The only place where this is really required is for statements involving semisimplicity of certain algebra objects (Theorems 5.1 and 5.6).

Definition 2.1. A tensor category² consists of the data $(\mathcal{C}, 1, \otimes, \alpha, \lambda, \rho)$ where \mathcal{C} is a category, $1 \in \mathcal{C}$ is the distinguished unit object, $\otimes : \mathcal{C} \boxtimes \mathcal{C} \rightarrow \mathcal{C}$ is a bifunctor, the associator $\alpha : (a \otimes b) \otimes c \rightarrow a \otimes (b \otimes c)$ is a natural isomorphism, and the left and right unitors $\lambda : 1 \otimes a \rightarrow a$ and $\rho : a \otimes 1 \rightarrow a$ are natural isomorphisms. This data must satisfy the well known pentagon and triangle axioms.

A tensor category \mathcal{C} is called:³

- rigid (or has duals) if for every $a \in \mathcal{C}$ there is an object $a^* \in \mathcal{C}$, and there are maps $\text{coev}_a : 1 \rightarrow a \otimes a^*$ and $\text{ev}_a : a^* \otimes a \rightarrow 1$ satisfying the zig-zag axioms

$$\begin{aligned} (\text{id}_a \otimes \text{ev}_a) \circ (\text{coev}_a \otimes \text{id}_a) &= \text{id}_a \\ (\text{ev}_a \otimes \text{id}_{a^*}) \circ (\text{id}_{a^*} \otimes \text{coev}_a) &= \text{id}_{a^*}. \end{aligned}$$

Moreover, for every $a \in \mathcal{C}$, there should exist an object ${}^*a \in \mathcal{C}$ such that $({}^*a)^* \cong a$.

Note that being rigid is not data; it is just a property of the category.⁴ Given $f : a \rightarrow b$ in \mathcal{C} , we write $f^* : b^* \rightarrow a^*$ for $(\text{ev}_b \otimes \text{id}_{a^*}) \circ (\text{id}_{b^*} \otimes f \otimes \text{id}_{a^*}) \circ (\text{id}_{b^*} \otimes \text{coev}_a)$.

²The adjectives ‘tensor’ and ‘monoidal’ are essentially synonymous. The first one is usually only used when the category is linear; the second one is used regardless of whether the category is linear or not.

³Alternative terminologies include [Sel11]: rigid = autonomous, pivotal = sovereign, ribbon = tortile.

⁴In any category, an object a is said to *have a dual* if there exist solutions of the zig-zag equations. The dual object a^* is then unique up to canonical isomorphism, and may thus be referred to as *the* dual of a .

- fusion if \mathcal{C} is rigid, semisimple, $\mathcal{C}(1, 1) \cong k$, and there are only finitely many isomorphism classes of simple objects.
- pivotal if \mathcal{C} is rigid, and there is a monoidal natural isomorphism φ from the identity functor to the double dual functor.⁵ The left and right pivotal traces of a morphism $f : a \rightarrow a$ are then defined by

$$\begin{aligned} \mathrm{tr}_L(f) &= \mathrm{ev}_a \circ (\mathrm{id}_{a^*} \otimes f) \circ (\mathrm{id}_{a^*} \otimes \varphi_a^{-1}) \circ \mathrm{coev}_{a^*} \\ \mathrm{tr}_R(f) &= \mathrm{ev}_{a^*} \circ (\varphi_a \otimes \mathrm{id}_{a^*}) \circ (f \otimes \mathrm{id}_{a^*}) \circ \mathrm{coev}_a. \end{aligned}$$

- spherical if \mathcal{C} is pivotal and for every $c \in \mathcal{C}$ and $f \in \mathcal{C}(c, c)$, we have $\mathrm{tr}_L(f) = \mathrm{tr}_R(f)$.
- braided if there is a family of natural isomorphisms $\beta_{a,b} : a \otimes b \rightarrow b \otimes a$ satisfying the two well known hexagon axioms. We also write $\beta_{a,b}^+$ for $\beta_{a,b}$ and $\beta_{a,b}^-$ for $\beta_{b,a}^{-1}$.
- balanced if \mathcal{C} is braided and there are twist isomorphisms $\theta_a : a \rightarrow a$ for $a \in \mathcal{C}$, natural in a , satisfying $\theta_{a \otimes b} = \beta_{b,a} \circ \beta_{a,b} \circ (\theta_a \otimes \theta_b)$ for all $a, b \in \mathcal{C}$.
- ribbon⁶ if \mathcal{C} is balanced and rigid, and the twist maps satisfy $\theta_{a^*} = \theta_a^*$ for all $a \in \mathcal{C}$.

There exist graphical calculi for morphisms in various kinds of monoidal or tensor categories. We may draw different types of diagrams and perform different types of isotopies based on the properties and structures of our category. We give a helpful guide below (see [Sel11] for a comprehensive survey). If \mathcal{C} is...

- monoidal (Joyal–Street [JS91a]), we may draw our string diagrams so that strands only go up and down. We read the diagram from bottom to top.

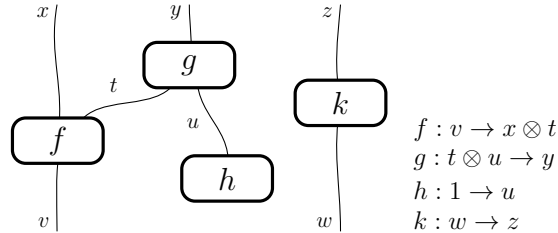

- rigid, then we can draw any planar diagram. Strings may bend up and down, however coupons are not allowed to rotate.

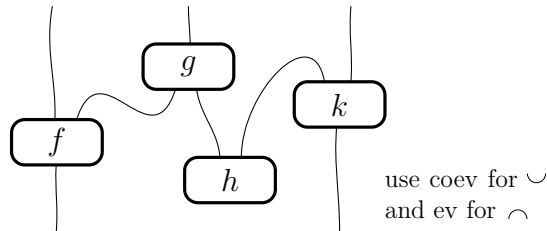

⁵The original definition of Freyd and Yetter [FY92] contains the redundant axiom $\varphi_{a^*} = (\varphi_a^{-1})^*$, later reproduced by other authors. See [Sel11, Lem. 4.11] for a proof of that property.

⁶We warn the reader that [BK01, Def. 2.2.1] defines the notion of a braided pivotal category (equivalently, a balanced rigid category – see Appendix A.2), rather than that of a ribbon category. In a braided pivotal category, it is not necessarily the case that $\theta_{a^*} = \theta_a^*$. The same problem appears in [KO02, Eq. (1.6)].

- pivotal (Freyd–Yetter [FY92]), we may rotate coupons by 2π without changing the morphism. In defining the right hand side below, we must use the pivotal structure:

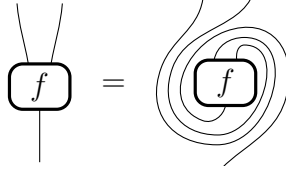

- spherical, then the value of a closed diagram is invariant under spherical isotopy. In particular:

$$\mathrm{tr}_R(f) = \left(\begin{array}{c} \text{---} \\ \circlearrowleft \\ f \\ \circlearrowright \\ \text{---} \end{array} \right) = \left(\begin{array}{c} \text{---} \\ \circlearrowright \\ f \\ \circlearrowleft \\ \text{---} \end{array} \right) = \mathrm{tr}_L(f).$$

- braided (Joyal–Street [JS91a]), then our diagrams are now in three dimensions, and we draw them projected to the plane. If \mathcal{C} is not rigid, then coupons again may only travel up and down, and are not allowed to rotate.

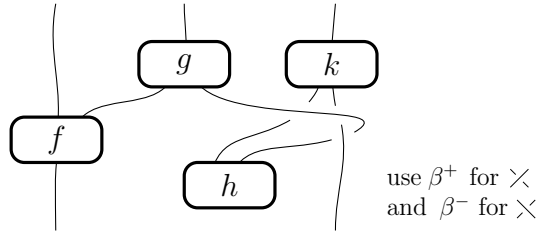

- balanced (Shum [Shu94]), then strands are replaced by ribbons, which can twirl on themselves, but cannot bend up and down. Coupons may rotate around the z -axis.

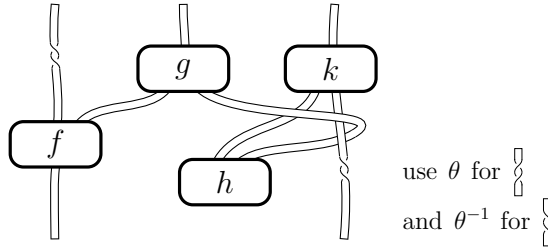

- braided pivotal (Freyd–Yetter [FY92]), then the second and third Reidemeister moves are allowed, but not the first. Strands behave like ribbons pressed flat against the plane.

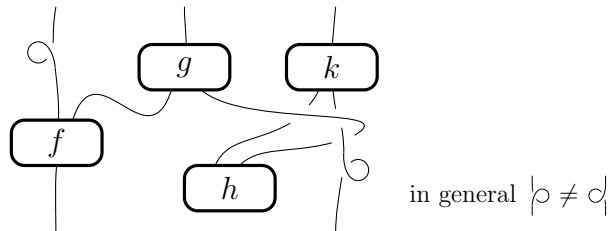

There are two ways of making such a category into a balanced one, by letting θ be either \wr or \wr (see Lemma A.2 in the appendix).

- ribbon (Shum [Shu94]), then the stands are replaced by ribbons, and all three dimensional isotopies are allowed.

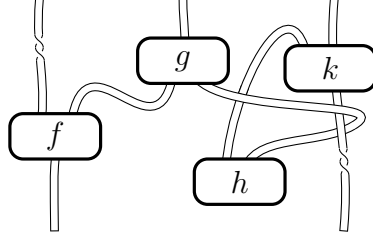

Given a functor between categories with extra structure, one can ask for the functor to be compatible with that structure. We list the relevant conditions for the notions mentioned above. Let \mathcal{C} and \mathcal{D} be tensor categories, and let $F : \mathcal{C} \rightarrow \mathcal{D}$ be a functor.

- We say that F is a tensor functor if it comes equipped with an invertible⁷ natural transformation $\nu_{x,y} : F(x) \otimes F(y) \rightarrow F(x \otimes y)$ and an isomorphism $i : 1_{\mathcal{D}} \rightarrow F(1_{\mathcal{C}})$, subject to

$$\begin{aligned} \nu_{x,y \otimes z} \circ (1_{F(x)} \otimes \nu_{y,z}) \circ \alpha_{F(x),F(y),F(z)} &= F(\alpha_{x,y,z}) \circ \nu_{x \otimes y,z} \circ (\nu_{x,y} \otimes 1_{F(z)}), \\ F(\lambda_x) \circ \nu_{1,x} \circ (i \otimes 1_{F(x)}) &= \lambda_{F(x)}, \quad \text{and} \quad F(\rho_x) \circ \nu_{x,1} \circ (1_{F(x)} \otimes i) = \rho_{F(x)}. \end{aligned} \quad (1)$$

- If \mathcal{C} and \mathcal{D} are braided, then F is a braided functor if the condition $F(\beta) = \nu \circ \beta \circ \nu^{-1}$ is satisfied.
- If \mathcal{C} and \mathcal{D} are balanced, then F is a balanced functor if we also have $F(\theta) = \theta$.

If \mathcal{C} is rigid and $F : \mathcal{C} \rightarrow \mathcal{D}$ is a tensor functor, then every object in the essential image of F has a dual, and there is a canonical isomorphism $\delta_x : F(x^*) \rightarrow F(x)^*$, characterised by $F(\text{ev}_x) = i \circ \text{ev}_{F(x)} \circ (\delta_x \otimes \text{id}_{F(x)}) \circ \nu_{x^*,x}^{-1}$ (this requires no extra data).

- If \mathcal{C} and \mathcal{D} are pivotal, then a pivotal functor is a tensor functor satisfying the extra axiom $F(\varphi_x) = \delta_{x^*}^{-1} \circ \delta_x^* \circ \varphi_{F(x)}$.

2.2 The Drinfel'd center

The Drinfel'd center construction takes as input a tensor category and produces as output a braided tensor category [JS91b]. It is a categorification of the operation of taking the center of a ring.

Definition 2.2. Let \mathcal{C} be a tensor category. Its center $\mathcal{Z}(\mathcal{C})$ is the tensor category whose objects are pairs (a, e_a) where $e_a = e_{a,\bullet}$ is a half-braiding for $a \in \mathcal{C}$. A half-braiding for $a \in \mathcal{C}$ is a family of isomorphisms

$$e_{a,b} = \begin{array}{c} \diagup \\ a \quad \diagdown \\ \diagdown \\ b \end{array} : a \otimes b \rightarrow b \otimes a$$

⁷ If ν and i are not assumed invertible, then this is called a *lax tensor functor*. We warn the reader that some people use ‘strong tensor functor’ for tensor functors, and ‘tensor functor’ for lax tensor functors.

which is natural with respect to b , and satisfies the hexagon axiom

$$(\text{id}_b \otimes e_{a,c}) \circ \alpha \circ (e_{a,b} \otimes \text{id}_c) = \alpha \circ e_{a,b \otimes c} \circ \alpha. \quad (2)$$

The morphisms in $\mathcal{Z}(\mathcal{C})$ from (a, e_a) to (b, e_b) are all the $f \in \mathcal{C}(a, b)$ which “pass over all crossings”, i.e., such that for all $c \in \mathcal{C}$,

$$e_{b,c} \circ (f \otimes \text{id}_c) = (\text{id}_c \otimes f) \circ e_{a,c}.$$

Note that $\mathcal{Z}(\mathcal{C})$ is always braided by defining $\beta_{(a, e_a)(b, e_b)} = e_{a,b}$. In fact, $\mathcal{Z}(\mathcal{C})$ retains many of the properties and structures from \mathcal{C} . For example, if \mathcal{C} is rigid, fusion, pivotal, or spherical, then so is $\mathcal{Z}(\mathcal{C})$ (e.g., see [ENO05, Thm. 2.15] and [Müg03b, Prop. 3.9]).

The proof of pivotality of $\mathcal{Z}(\mathcal{C})$ in [Müg03b, Prop. 3.9] assumes \mathcal{C} to be a *strict* pivotal category. We are not aware of a reference that proves the result in full generality, so we provide a short argument of the most non-trivial part of the proof:

Proposition 2.3. *Let \mathcal{C} be a rigid tensor category. Then a pivotal structure on \mathcal{C} induces a pivotal structure on $\mathcal{Z}(\mathcal{C})$.*

Proof (communicated by Noah Snyder). The dual of an object $(a, e_a) \in \mathcal{Z}(\mathcal{C})$ is given by (a^*, e_{a^*}) , with $e_{a^*, b} := e_{a, b}^*$. The somewhat non-trivial claim is that the map $\varphi_a : a \rightarrow a^{**}$ provided by the pivotal structure of \mathcal{C} defines a morphism $(a, e_a) \rightarrow (a, e_a)^{**}$ in $\mathcal{Z}(\mathcal{C})$. We need to show that $(\text{id}_b \otimes \varphi_a) \circ e_{a,b} = e_{a^{**}, b} \circ (\varphi_a \otimes \text{id}_b)$ for every $b \in \mathcal{C}$. This is done as follows:

$$\begin{aligned} e_{a^{**}, b} \circ (\varphi_a \otimes \text{id}_b) &= e_{a^{**}, b}^* \circ \varphi_{a \otimes b} \circ (\text{id}_a \otimes \varphi_{b^{**}}^{-1}) \\ &= \varphi_{b \otimes a} \circ e_{a, b} \circ (\text{id}_a \otimes \varphi_{b^{**}}^{-1}) \\ &= \varphi_{b \otimes a} \circ (\varphi_{b^{**}}^{-1} \otimes \text{id}_a) \circ e_{a, b} = (\text{id}_b \otimes \varphi_a) \circ e_{a, b}. \quad \square \end{aligned}$$

2.3 Synoptic chart of tensor categories

We present here a chart (Figure 2) that summarizes the various notions of tensor category. The two ways of going between balanced rigid categories and braided pivotal categories will be discussed in Appendix A.2.

In Figure 2, we use the following notations:

- An arrow $\textcircled{A} \rightarrow \textcircled{B}$ indicates that notion B can be obtained from notion A by forgetting part of the data.
- An arrow $\textcircled{A} \hookrightarrow \textcircled{B}$ indicates that notion A can be obtained from notion B by imposing extra axioms.
- A dashed arrow $\textcircled{A} \xrightarrow{\mathcal{Z}} \textcircled{B}$ indicates that the Drinfel'd center construction goes from notion A to notion B.
- A double arrow $\textcircled{A} \xrightarrow{\cong} \textcircled{B}$ indicates an equivalence between notions A and B.

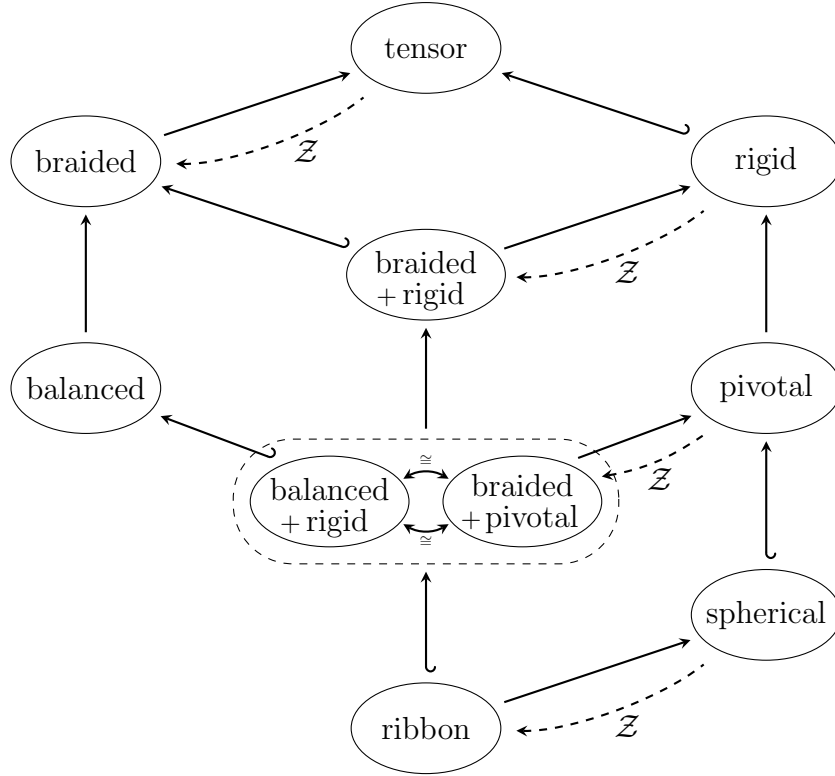

Figure 2: Synoptic chart of tensor categories

As mentioned above, there are *two* ways of going between balanced rigid categories and braided pivotal categories. To avoid any confusion, we will only use *one* of those two equivalences in the remainder of this paper. Specifically, given a braided pivotal category $(\mathcal{C}, \beta, \varphi)$, we will always equip it with the twists given by

$$\theta_a := (\text{id}_a \otimes \text{ev}_{a^*}) \circ (\beta_{a^{**}, a} \otimes \text{id}_{a^*}) \circ (\text{id}_{a^{**}} \otimes \text{coev}_a) \circ \varphi_a = \begin{array}{c} a \\ | \\ \text{---} \circlearrowleft \text{---} \\ | \\ \boxed{\varphi_a} \\ | \\ a \end{array} \quad (3)$$

See Appendix A.2 for more details.

2.4 Algebra objects

We now discuss algebra objects in tensor categories. General references include [KO02, §1], [DMNO13, §2.4], [Ost03, §3], and [Müg03a].

Definition 2.4. An algebra object in a tensor category \mathcal{C} is a triple $(A, m : A \otimes A \rightarrow A, i : 1 \rightarrow A)$ which satisfies the following axioms:

$$\begin{aligned} m(m \otimes \text{id}_A) &= m(\text{id}_A \otimes m) && \text{(Associativity)} \\ m(i \otimes \text{id}_A) &= \text{id}_A = m(\text{id}_A \otimes i) && \text{(Unitality)} \end{aligned}$$

Dually, a coalgebra is a triple $(A, \Delta : A \rightarrow A \otimes A, \epsilon : A \rightarrow 1)$ satisfying analogous coassociativity and counitality axioms.

We represent the multiplication m and unit i by a trivalent, respectively univalent, vertex

$$m_A = \begin{array}{c} |^A \\ \swarrow \searrow \\ A \quad A \end{array} \quad i_A = \begin{array}{c} |^A \\ \bullet \end{array} .$$

An algebra object is called *connected* if $\mathcal{C}(1, A)$ is one dimensional. If the ambient category \mathcal{C} is semisimple, then an algebra object is:

- *semisimple* if the category $\text{Mod}_{\mathcal{C}}(A)$ of A -modules in \mathcal{C} is semisimple,
- *separable* if $m_A : A \otimes A \rightarrow A$ splits as a morphism of A - A -bimodules.

At first glance, the notions of semisimple and separable algebras do not seem very related. However, a special case of the following proposition (namely setting $B = 1$) shows that separable always implies semisimple:

Proposition 2.5. *Let A and B be separable algebras in a semisimple tensor category \mathcal{C} . Then the category $\text{Bimod}_{\mathcal{C}}(A, B)$ of A - B -bimodules is semisimple.*

Proof (communicated by Victor Ostrik). Let $s_A : A \rightarrow A \otimes A$ and $s_B : B \rightarrow B \otimes B$ be bimodule maps that split m_A and m_B . Given $M \in \text{Bimod}_{\mathcal{C}}(A, B)$, the action map $A \otimes M \otimes B \rightarrow M$ admits a splitting

$$M \cong A \otimes_A M \otimes_B B \xrightarrow{s_A \otimes \text{id} \otimes s_B} (A \otimes A) \otimes_A M \otimes_B (B \otimes B) \cong A \otimes M \otimes B,$$

which is furthermore a bimodule map. M is therefore isomorphic to a direct summand of $A \otimes M \otimes B$. As the latter is projective, so is M . Every object of $\text{Bimod}_{\mathcal{C}}(A, B)$ is projective, every exact sequence splits, and the category is semisimple. \square

We also get the following well-known equivalent definition of separability:

Proposition 2.6 ([DMNO13, Prop. 2.7]). *An algebra object A in a semisimple tensor category \mathcal{C} is separable if and only if $\text{Bimod}_{\mathcal{C}}(A, A)$ is semisimple.*

Proof. The multiplication map $m_A : A \otimes A \rightarrow A$ admits a right inverse (given by $\text{id}_A \otimes i_A$) and is thus always an epimorphism. If $\text{Bimod}_{\mathcal{C}}(A, A)$ is semisimple, m_A therefore splits. The other direction follows from the previous proposition by setting $B = A$. \square

Remark 2.7. In positive characteristic there exist semisimple algebras which are not separable, e.g., the group algebra $\mathbb{F}_p[G]$ viewed as a G -graded vector space, for some p -group G .

However, if \mathcal{C} is a fusion category over a field of characteristic zero, then algebra objects in \mathcal{C} are semisimple if and only if they are separable. To see that, consider a semisimple algebra object A , which we assume without loss of generality to be simple (not a direct sum of smaller algebras). Then $\mathcal{M} := \text{Mod}_{\mathcal{C}}(A)$ is an indecomposable module category, and the category $\text{Func}_{\mathcal{C}}(\mathcal{M}, \mathcal{M}) = \text{Bimod}_{\mathcal{C}}(A, A)$ of \mathcal{C} -linear endofunctors of \mathcal{M} is semisimple by [ENO05, Lem. 2.15].

We now briefly introduce the notion of a Frobenius algebra object:

Definition 2.8. A Frobenius algebra in a tensor category \mathcal{C} is a quintuplet $(A, m, \Delta, i, \epsilon)$ such that (A, m, i) is an algebra, (A, Δ, ϵ) is a coalgebra, and the following compatibility condition is satisfied:

$$(m \otimes \text{id}_A) \circ (\text{id}_A \otimes \Delta) = \Delta \circ m = (\text{id}_A \otimes m) \circ (\Delta \otimes \text{id}_A) \quad (\text{Frobenius})$$

It is interesting to note that a Frobenius algebra is entirely determined by its underlying algebra (A, m, i) and counit ϵ . Moreover, for a given algebra $A = (A, m, i)$, a morphism $\epsilon : A \rightarrow 1$ is the counit of a Frobenius structure if and only if the pairing $\epsilon \circ m : A \otimes A \rightarrow 1$ is *non-degenerate* (a pairing $p : A \otimes B \rightarrow 1$ is non-degenerate if A and B are dualizable and $(p \otimes \text{id}_{B^*}) \circ (\text{id}_A \otimes \text{coev}_B) : A \rightarrow B^*$ is an isomorphism):

Proposition 2.9 ([FRS02, Lem. 3.7], [FS08, Prop. 8]). *Let \mathcal{C} be a tensor category, and let (A, m, i) be an algebra object in \mathcal{C} . Let $\epsilon : A \rightarrow 1$ be such that the pairing $\epsilon \circ m$ is non-degenerate. Then, there exists a unique comultiplication $\Delta : A \rightarrow A \otimes A$ making the quintuplet $(A, m, \Delta, i, \epsilon)$ into a Frobenius algebra.*

3 Categorized traces for module tensor categories

In this section, we explain the general notion of categorized trace, along with some basic properties thereof. We then explain how to construct a categorized trace $\text{Tr}_{\mathcal{C}} : \mathcal{M} \rightarrow \mathcal{C}$ from a module tensor category \mathcal{M} over a braided tensor category \mathcal{C} .

3.1 Categorized traces

Recall that a trace on an algebra is a linear map to the ground field satisfying $\text{tr}(xy) = \text{tr}(yx)$. The categorification of the notion of algebra is that of tensor category, where notably the associativity constraint gets replaced by the additional data of associators. The notion of a *categorized trace* (also known as a *commutator functor* [BFO09, §6], [Ost14, Def. 2.1]) is defined in the same spirit:

Definition 3.1. Let \mathcal{M} be a tensor category, and let \mathcal{C} be a category. A *categorized trace* is a functor $\text{Tr} : \mathcal{M} \rightarrow \mathcal{C}$ along with natural isomorphisms

$$\tau_{x,y} : \text{Tr}(x \otimes y) \rightarrow \text{Tr}(y \otimes x) \quad x, y \in \mathcal{M}$$

which we call the *traciators*, subject to the following axiom:

$$\tau_{x,y \otimes z} = \tau_{z \otimes x, y} \circ \tau_{x \otimes y, z}. \quad (4)$$

Here, we have suppressed the associators for readability. The axiom including the necessary associators reads as follows: $\text{Tr}(\alpha_{y,z,x}) \circ \tau_{x,y \otimes z} \circ \text{Tr}(\alpha_{x,y,z}) = \tau_{z \otimes x, y} \circ \text{Tr}(\alpha_{z,x,y})^{-1} \circ \tau_{x \otimes y, z}$.

We will sometimes write $\tau_{x,y}^+$ for $\tau_{x,y}$, and $\tau_{x,y}^-$ for $\tau_{y,x}^{-1}$. The latter is called the inverse traciator. We point out that τ^- does not in general satisfy equation (4), but instead a mirrored version of that axiom.

Remark 3.2. A slightly less general notion of categorified trace was studied in [PS13] under the name “shadow”. It differs from Definition 3.1 in that the authors also included the axioms⁸

$$\tau_{x,1} = \text{id} \quad \text{and} \quad \tau_{1,x} = \text{id}.$$

The first axiom above is redundant: see Lemma 3.3 below. The second axiom is not satisfied by the trace functors we will consider (see Remark 3.13), and we prefer not to include it in the general definition of a categorified trace.

Lemma 3.3 ([Ost14, Rem. 2.2.]). *Let (Tr, τ) be a categorified trace. Then $\tau_{x,1} = \text{id}_{\text{Tr}(x)}$.*

Proof. Omitting unitors and associators, we have $\tau_{x,1} = \tau_{x,1 \otimes 1} = \tau_{1 \otimes x,1} \circ \tau_{x \otimes 1,1} = \tau_{x,1} \circ \tau_{x,1}$, where the second equality holds by Equation (4). As $\tau_{x,1}$ is invertible, it follows that $\tau_{x,1} = \text{id}_{\text{Tr}(x)}$. \square

In Section 2.1 we have reviewed the classical string diagram notation for objects and morphisms in tensor categories. As explained in [PS13], a good graphical notation for categorified traces is to take the strands that represent the objects of \mathcal{M} , and place them on the surface of a cylinder. For example, if we denote $x \in \mathcal{M}$ as a strand on a horizontal plane, then we represent $\text{Tr}(x) \in \mathcal{C}$ as the same strand on the surface of a cylinder:

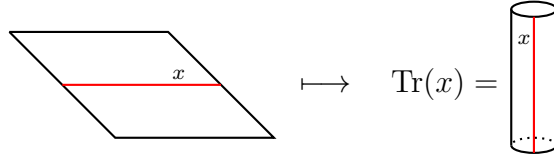

Morphisms $f \in \mathcal{M}(x, y)$ are denoted by coupons in the horizontal plane, and we represent $\text{Tr}(f) : \text{Tr}(x) \rightarrow \text{Tr}(y)$ as the same coupon, but now on a cylinder:

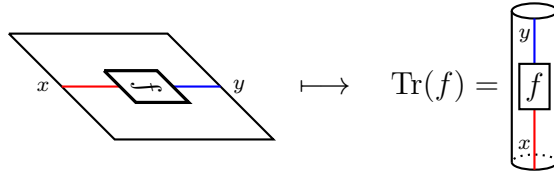

The traciators $\tau^\pm : \text{Tr}_{\mathcal{C}}(x \otimes y) \rightarrow \text{Tr}_{\mathcal{C}}(y \otimes x)$ are depicted

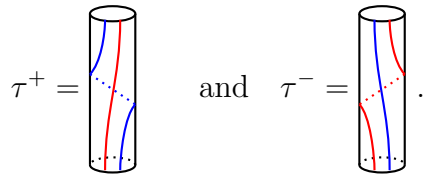

The naturality of the traciator and the traciator axiom (4) are given in diagrams by

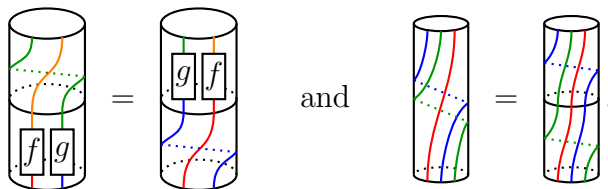

⁸We have again suppressed the coherences for readability. The actual axioms are $\text{Tr}(\lambda_x) \circ \tau_{x,1} = \text{Tr}(\rho_x)$ and $\text{Tr}(\rho_x) \circ \tau_{1,x} = \text{Tr}(\lambda_x)$.

To illustrate the graphical notation, we prove a general basic property of categorified traces.

Lemma 3.4. *Let $\text{Tr} : \mathcal{M} \rightarrow \mathcal{C}$ be a categorified trace. Then for any dualizable object $x \in \mathcal{M}$, the following equality holds:*

$$\tau_{y,x^*}^+ = \text{Tr}(\text{id}_{x^* \otimes y} \otimes \text{ev}_x) \circ \tau_{x,x^* \otimes y \otimes x^*}^- \circ \text{Tr}(\text{coev}_x \otimes \text{id}_{y \otimes x^*}).$$

In diagrams:

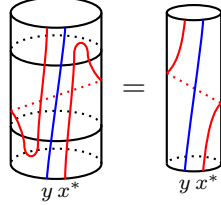

Proof. We prove this identity after composing with the inverse traciator $\tau_{x^*,y}^-$:

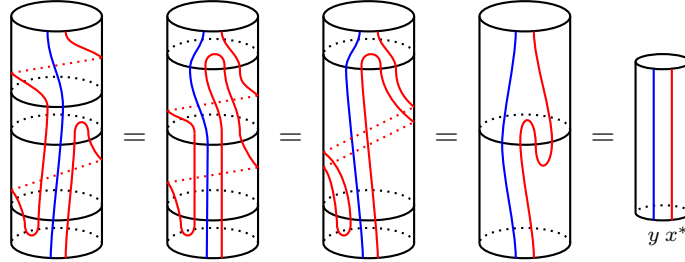

The first equality holds by naturality of τ^- . The second one is the analog of (4) for inverse traciators. Finally, the third equality follows from naturality, along with Lemma 3.3. \square

The main focus of this paper is the construction of a particular class of examples of categorical traces, which have the further property that the cylinders can branch and braid (see Figure 1). To obtain such a categorified trace $\text{Tr} : \mathcal{M} \rightarrow \mathcal{C}$, we must assume that \mathcal{M} is equipped with the structure of a pivotal module tensor category over \mathcal{C} , a notion we describe below.

3.2 Module tensor categories

If \mathcal{M} and \mathcal{C} are tensor categories, a functor $\Phi : \mathcal{C} \rightarrow \mathcal{M}$ equips \mathcal{M} with the structure of a left module category via $c \cdot m := \Phi(c) \otimes m$. If \mathcal{C} is braided, then Φ actually equips \mathcal{M} with *two* distinct left \mathcal{C} -module structures (one coming from the left action above, and one coming from the right action, twisted by the braiding). These two module structures are equivalent precisely when Φ is given the structure of a *braided central functor*:

Definition 3.5. Let \mathcal{C} be a category and \mathcal{M} a tensor category. A *central functor*⁹ from \mathcal{C} to \mathcal{M} is a functor $\Phi : \mathcal{C} \rightarrow \mathcal{M}$ equipped with a factorisation

$$\Phi : \mathcal{C} \xrightarrow{\Phi^Z} \mathcal{Z}(\mathcal{M}) \xrightarrow{F} \mathcal{M}$$

⁹ The reader is cautioned that our usage of the term ‘central functor’ agrees with [BFO09, Ost14], but differs from [Bez04, DMNO13] as these require that a central functor be braided.

where F is the forgetful functor [BFO09][Ost14, §2.1]. When \mathcal{C} is monoidal, a central functor $\Phi : \mathcal{C} \rightarrow \mathcal{M}$ is called monoidal if $\Phi^{\mathcal{Z}}$ is monoidal. When \mathcal{C} is braided, a central functor is called braided if the functor $\Phi^{\mathcal{Z}}$ is braided.

Equivalently, a functor Φ is a central functor if it is equipped with the additional data of half-braidings $e_{\Phi(c),x} : \Phi(c) \otimes x \rightarrow x \otimes \Phi(c)$, natural in c and x , satisfying

$$e_{\Phi(c),x \otimes y} = (\text{id}_x \otimes e_{\Phi(c),y}) \circ (e_{\Phi(c),x} \otimes \text{id}_y) \quad (\text{Central functor}).$$

To go from a central functor to a monoidal central functor, one imposes the additional axiom

$$e_{\Phi(c \otimes d),x} = (e_{\Phi(c),x} \otimes \text{id}_{\Phi(d)}) \circ (\text{id}_{\Phi(c)} \otimes e_{\Phi(d),x}) \quad (\text{Monoidal central functor}).$$

Finally, a braided central functor satisfies the further axiom

$$e_{\Phi(c),\Phi(d)} = \Phi(\beta_{c,d}) \quad (\text{Braided central functor}).$$

Note that in formulating the above axioms we have omitted the associators and the isomorphisms $\Phi(x) \otimes \Phi(y) \rightarrow \Phi(x \otimes y)$, for readability.

Let \mathcal{C} be a braided tensor category. A braided central functor $\Phi : \mathcal{C} \rightarrow \mathcal{M}$ makes the tensor category \mathcal{M} into a \mathcal{C} -module category in way that is compatible with the tensor structure of \mathcal{M} and the braiding of \mathcal{C} . We call such an \mathcal{M} a *module tensor category* over \mathcal{C} :

Definition 3.6. If \mathcal{M} is a tensor category and \mathcal{C} is a braided category, then \mathcal{M} is a *module tensor category* over \mathcal{C} if it is equipped with a braided central functor $\Phi : \mathcal{C} \rightarrow \mathcal{M}$.

If \mathcal{M} , \mathcal{C} and $\Phi^{\mathcal{Z}}$ are pivotal, then we say that \mathcal{M} is a pivotal module tensor category.

As module tensor categories might be an unfamiliar concept, we provide a couple of alternative viewpoints:

A tensor category can be thought of as a 2-category with a single object. Similarly, a pair consisting of a tensor category \mathcal{C} and module category \mathcal{M} can be encoded by a 2-category with exactly two objects 1 and $*$, and only non-trivial homs given by $\mathcal{C} := \text{Hom}(1, 1)$ and $\mathcal{M} := \text{Hom}(1, *)$.

On the other hand, a braided tensor category can be thought of as a 3-category with one object and one 1-morphism [BD95, ‘Periodic Table’, Fig. 21]. The pair consisting of a braided category \mathcal{C} and module tensor category \mathcal{M} can be encoded by a 3-category with exactly two objects 1 and $*$, and with only non-trivial homs given by the 2-categories $\text{Hom}(1, 1)$ and $\text{Hom}(1, *)$, which are furthermore required to have only one object. We recover the braided category and its module tensor category as $\mathcal{C} = \text{Hom}_{\text{Hom}(1,1)}(1_1, 1_1)$ and $\mathcal{M} = \text{Hom}_{\text{Hom}(1,*)}(\cdot, \cdot)$, respectively, where $\cdot : 1 \rightarrow *$ is the unique morphism.

Alternatively, for those who like to think of a braided tensor category as a category which is an algebra over the little discs operad, then a pair consisting of a braided tensor category \mathcal{C} and a module tensor category \mathcal{M} is the same thing as an algebra over Voronov’s Swiss-cheese operad [Vor99].

3.3 The categorified trace associated to a module tensor category

We now introduce the main construction of this paper, the categorified trace associated to a module tensor category.

Definition 3.7. Let \mathcal{C} be a braided pivotal category, and let \mathcal{M} be a pivotal module tensor category. The *associated categorified trace* $\mathrm{Tr}_{\mathcal{C}} : \mathcal{M} \rightarrow \mathcal{C}$ is the right adjoint of the action functor Φ .

The existence of a right adjoint is a mild assumption, which can be easily checked in many circumstances (see, e.g., [DSPS14, Cor. 1.9]):

Lemma 3.8. *If \mathcal{C} and \mathcal{M} are semisimple (linear over some field k) and \mathcal{C} has finitely many types of simple objects, then any linear functor $F : \mathcal{C} \rightarrow \mathcal{M}$ admits a right adjoint.*

Proof. Let $\{c_i\}$ be a basis of \mathcal{C} (representatives of the isomorphism classes of simple objects), and let $\{m_j\}$ be a basis of \mathcal{M} . Let $A = (A_{ij})$ be the matrix of finite dimensional vector spaces given by $A_{ij} := \mathcal{M}(m_j, F(c_i))$. Note that A has only finitely many non-zero entries.

We have canonical isomorphisms $F(c_i) \cong \bigoplus_j A_{ij} \otimes m_j$, and the functor F can be recovered by the formula

$$F\left(\bigoplus_i V_i \otimes c_i\right) \cong \bigoplus_{i,j} V_i \otimes A_{ij} \otimes m_j.$$

Let A^* be the ‘conjugate transpose’ matrix of vector spaces, given by $A_{ji}^* = \mathrm{Hom}_k(A_{ij}, k)$. It is then an easy exercise to check that the functor $G\left(\bigoplus_j W_j \otimes m_j\right) := \bigoplus_{i,j} W_j \otimes A_{ji}^* \otimes c_i$ is a right adjoint (also a left adjoint) of F . \square

Alternatively one can define $\mathrm{Tr}_{\mathcal{C}} := \underline{\mathrm{Hom}}(1_{\mathcal{M}}, -)$, where $\underline{\mathrm{Hom}}$ is the internal hom for module categories [Ost03]. By definition, $\underline{\mathrm{Hom}}(1_{\mathcal{M}}, x)$ represents the functor $c \mapsto \mathrm{Hom}(c \cdot 1_{\mathcal{M}}, x)$ and so, recalling that $\Phi(c) = c \cdot 1_{\mathcal{M}}$, we indeed have the adjunction $\mathrm{Hom}(\Phi(c), x) \cong \mathrm{Hom}(c, \underline{\mathrm{Hom}}(1_{\mathcal{M}}, x))$.

In Section 4.4 we will construct traciators for $\mathrm{Tr}_{\mathcal{C}}$ and prove that they satisfy the axioms of a categorified trace (Lemmas 4.16 and 4.17), a result which first appeared in [BFO09, Prop. 5] and [Ost14, Prop. 2.5].

We illustrate our construction by a couple of examples.

Example 3.9. Any pivotal category \mathcal{M} is naturally a pivotal module tensor category over Vec . For every $x \in \mathcal{M}$ we have $\mathcal{C}(1, \mathrm{Tr}_{\mathcal{C}}(x)) \cong \mathcal{M}(\Phi(1_{\mathcal{C}}), x) = \mathcal{M}(1_{\mathcal{M}}, x)$, the invariant vectors. This means that we can naturally identify $\mathrm{Tr}_{\mathcal{C}}(x)$ with the vector space $\mathcal{M}(1_{\mathcal{M}}, x)$.

Example 3.10. Let \mathcal{C} be a braided pivotal tensor category, let $a \in \mathcal{C}$ be a commutative algebra object, and let $\mathcal{M} = \mathrm{Mod}_{\mathcal{C}}(a)$ be the category of a -modules in \mathcal{C} . Then \mathcal{M} is both a tensor category [Par95], and a \mathcal{C} -module category [KO02, §1]. Moreover, it is a \mathcal{C} -module tensor category, as noted in [DMNO13, §3.4]. The functor $\Phi : \mathcal{C} \rightarrow \mathcal{M}$ is the *free module* functor $\Phi(x) := a \otimes x$, and the half-braidings are given by

$$e_{\Phi(x), y} : \Phi(x) \otimes_a y \cong x \otimes y \xrightarrow{\beta_{x,y}} y \otimes x \cong y \otimes_a \Phi(x).$$

The associated categorified trace $\mathrm{Tr}_{\mathcal{C}} : \mathrm{Mod}_{\mathcal{C}}(a) \rightarrow \mathcal{C}$ is given by the forgetful functor, so that $\mathrm{Tr}_{\mathcal{C}}(x) = x$ for all $x \in \mathcal{M}$. Indeed, using the adjunction, we have

$$\mathcal{C}(c, \mathrm{Tr}_{\mathcal{C}}(x)) \cong \mathcal{M}(\Phi(c), x) = \mathcal{M}(a \otimes c, x) := \mathcal{C}_a(a \otimes c, x) \cong \mathcal{C}(c, x),$$

where $\mathcal{C}_a(-, -)$ denotes the a -module maps.

When a is furthermore separable and with trivial twist, then $\mathrm{Mod}_{\mathcal{C}}(a)$ is a pivotal module tensor category. For more details on this example, and in particular for the proof that Φ^z is a pivotal functor, we refer the reader to Appendix A.1.

Sub-Example 3.11. Take \mathcal{C} to be $SU(2)_k$ (the semi-simplification of the category of tilting modules for Lusztig's integral form of $U_q(\mathfrak{sl}(2))$, specialized at $q = \exp(\frac{2\pi i}{2(k+2)})$ ¹⁰ – see [Saw06] for details), which is an A_{k+1} modular tensor category. The commutative algebra objects $a \in \mathcal{C}$ are completely classified [Ocn02, KO02], and yield A_n , D_{2n} , E_6 , and E_8 fusion categories, whose simple objects are classified by the nodes of the corresponding Dynkin diagrams. Combining Example 3.10 with the computation at the end of [KO02, §6], we get the following explicit description of the trace functor:

Example: D_4 . This is a module tensor category over $SU(2)_4$ (with simple objects $\mathbf{1}, \dots, \mathbf{5}$). Its unit object is $1_{\mathcal{M}} = \bullet \circ \circ$, and the adjacency matrix of the Dynkin diagram encodes the operation of tensoring by $\Phi(\mathbf{2}) = \circ \circ \circ$. The trace functor is given (at the level of isomorphism classes of simple objects) by:

$x \in \mathcal{M}$				
$\mathrm{Tr}_{\mathcal{C}}(x) \in SU(2)_4$	$\mathbf{1} \oplus \mathbf{5}$	$\mathbf{2} \oplus \mathbf{4}$	$\mathbf{3}$	$\mathbf{3}$

Example: E_6 . This is a module tensor category over $SU(2)_{10}$ (with simple objects $\mathbf{1}, \dots, \mathbf{11}$). The unit object is $\bullet \circ \circ \circ$, and the adjacency matrix of the Dynkin diagram encodes the operation of tensoring by $\Phi(\mathbf{2}) = \circ \bullet \circ \circ$. The trace functor is:

$x \in \mathcal{M}$						
$\mathrm{Tr}_{\mathcal{C}}(x) \in SU(2)_{10}$	$\mathbf{1} \oplus \mathbf{7}$	$\mathbf{2} \oplus \mathbf{6} \oplus \mathbf{8}$	$\mathbf{3} \oplus \mathbf{5} \oplus \mathbf{7} \oplus \mathbf{9}$	$\mathbf{4} \oplus \mathbf{8}$	$\mathbf{4} \oplus \mathbf{6} \oplus \mathbf{10}$	$\mathbf{5} \oplus \mathbf{11}$

Example: E_8 . This is a module tensor category over $SU(2)_{28}$ (with simple objects $\mathbf{1}, \dots, \mathbf{29}$). The unit object is $\bullet \circ \circ \circ \circ$. Once again, the edges of the Dynkin diagram encode tensoring by $\Phi(\mathbf{2}) = \circ \bullet \circ \circ \circ$. The trace functor is given by:

x								
$\mathrm{Tr}_{\mathcal{C}}(x)$	$\mathbf{1} \oplus \mathbf{11} \oplus \mathbf{19} \oplus \mathbf{29}$	$\mathbf{2} \oplus \mathbf{10} \oplus \mathbf{12} \oplus \mathbf{18} \oplus \mathbf{20} \oplus \mathbf{28}$	$\mathbf{3} \oplus \mathbf{9} \oplus \mathbf{11} \oplus \mathbf{13} \oplus \mathbf{17} \oplus \mathbf{19} \oplus \mathbf{21} \oplus \mathbf{27}$	$\mathbf{4} \oplus \mathbf{8} \oplus \mathbf{10} \oplus \mathbf{12} \oplus \mathbf{14} \oplus \mathbf{16} \oplus \mathbf{18} \oplus \mathbf{20} \oplus \mathbf{22} \oplus \mathbf{26}$	$\mathbf{5} \oplus \mathbf{7} \oplus \mathbf{9} \oplus \mathbf{11} \oplus \mathbf{13} \oplus \mathbf{15} \oplus \mathbf{15} \oplus \mathbf{17} \oplus \mathbf{19} \oplus \mathbf{21} \oplus \mathbf{23} \oplus \mathbf{25}$	$\mathbf{6} \oplus \mathbf{10} \oplus \mathbf{14} \oplus \mathbf{16} \oplus \mathbf{20} \oplus \mathbf{24}$	$\mathbf{6} \oplus \mathbf{8} \oplus \mathbf{12} \oplus \mathbf{14} \oplus \mathbf{16} \oplus \mathbf{18} \oplus \mathbf{22} \oplus \mathbf{24}$	$\mathbf{7} \oplus \mathbf{13} \oplus \mathbf{17} \oplus \mathbf{23}$

Note that $\mathrm{Tr}_{\mathcal{C}}(1_{\mathcal{M}})$ (the first entry of the above tables) recovers the commutative algebra object a for which $\mathcal{M} = \mathrm{Mod}_{\mathcal{C}}(a)$ (see [KO02, Table 1]).

¹⁰We use the convention according to which $[2]_q = q + q^{-1}$.

Remark 3.12. The category $SU(2)_k$ is closely related to the Temperley-Lieb A_{k+1} ribbon category with $q = \exp(\frac{2\pi i}{2(k+2)})$ and braiding

$$\begin{array}{c} \diagup \diagdown \\ \diagdown \diagup \end{array} = iq^{1/2} \begin{array}{|c|} \hline \square \\ \hline \end{array} - iq^{-1/2} \begin{array}{|c|} \hline \square \\ \hline \end{array}, \quad (5)$$

familiar from the definition of the Jones polynomial [MPS11, §1.1.3]. The classification of commutative algebra objects in Temperley-Lieb is very similar to that of $SU(2)_k$. We again have A_n , D_{2n} , E_6 , and E_8 , but now we also have commutative algebras coming from the tadpole diagrams T_n (compare [EO04, Thm. 3.12]). Interestingly, for the braiding (5), only the T_{2n} arise from commutative algebras, while if we negate (5), only the T_{2n+1} arise from commutative algebras.

The skein theory for the D_{2n} planar algebras was computed in [MPS10], and the skein theory for the E_6 and E_8 planar algebras was computed in [Big10]. To give evaluation algorithms for these planar algebras, the authors used the existence of overbraiding relations of the form

where the crossing is the braiding (5) in the appropriate A_k category. The reason this overbraiding exists is that the D_{2n} , E_6 and E_8 fusion categories arise as module tensor categories of the form $\text{Mod}_{\mathcal{C}}(a)$ for a a separable commutative algebra with trivial twist, as explained above.

Remark 3.13. The calculations in Example 3.11 show that our trace functor is typically not a shadow in the sense of [PS13], as it may fail to satisfy $\tau_{1,x} = \text{id}$. Indeed, $\tau_{1,x}$ is equal to the twist by Proposition 4.23, and the latter is almost always nontrivial (see [FKST95, §8.2], [Kac90, (12.8.11)] for explicit formulas).

4 Properties of the trace functor

In this section we establish all the basic properties of the categorified trace $\text{Tr}_{\mathcal{C}}$ associated to a pivotal module tensor category (Definition 3.7). In Sections 4.1–4.3, we discuss the properties of $\text{Tr}_{\mathcal{C}}$ which follow from the fact that it is the right adjoint of a tensor functor, notably the existence of the multiplication map $\mu_{x,y} : \text{Tr}_{\mathcal{C}}(x) \otimes \text{Tr}_{\mathcal{C}}(y) \rightarrow \text{Tr}_{\mathcal{C}}(x \otimes y)$. The construction of the traciator $\tau_{x,y} : \text{Tr}_{\mathcal{C}}(x \otimes y) \rightarrow \text{Tr}_{\mathcal{C}}(y \otimes x)$ is done in Section 4.4. This only depends on the fact that \mathcal{M} is pivotal and that Φ factors through $\mathcal{Z}(\mathcal{M})$. Finally, in Section 4.5 we assume our full set of hypothesis: that \mathcal{M} is a pivotal module tensor category over \mathcal{C} . In this context we establish various compatibility relations which combine the traciator and multiplication maps with the braiding and the twist of \mathcal{C} .

In terms of Figure 1 from the introduction, Sections 4.1–4.3 deal with the right column, Section 4.4 deals with the left column, and Section 4.5 deals with the middle column.

4.1 The attaching map

Adjoints of tensor functors have been studied systematically [Kel74] and arise in many contexts (e.g. [BN11], [DMNO13]). We will reprove several known properties as a way of introducing our graphical notation for $\mathrm{Tr}_{\mathcal{C}}$. For Sections 4.1-4.3, we fix the following notation:

Notation 4.1.

- \mathcal{C}, \mathcal{M} are tensor categories,
- $\Phi : \mathcal{C} \rightarrow \mathcal{M}$ is a tensor functor, and
- $\mathrm{Tr}_{\mathcal{C}} : \mathcal{M} \rightarrow \mathcal{C}$ is the right adjoint of Φ .

The reader is cautioned that under these limited assumptions (compare Notation 4.12) the functor $\mathrm{Tr}_{\mathcal{C}}$ may fail to be a categorified trace. Nevertheless, we shall use the notation $\mathrm{Tr}_{\mathcal{C}}$ for notational consistency.

Recall from Section 3.1 that we depict an object $x \in \mathcal{M}$ by a strand in the plane, and $\mathrm{Tr}_{\mathcal{C}}(x)$ by a cylinder with an x -strand on its surface. Given an object $c \in \mathcal{C}$, the adjunction $\mathcal{C}(c, \mathrm{Tr}_{\mathcal{C}}(x)) \cong \mathcal{M}(\Phi(c), x)$ is represented diagrammatically by:

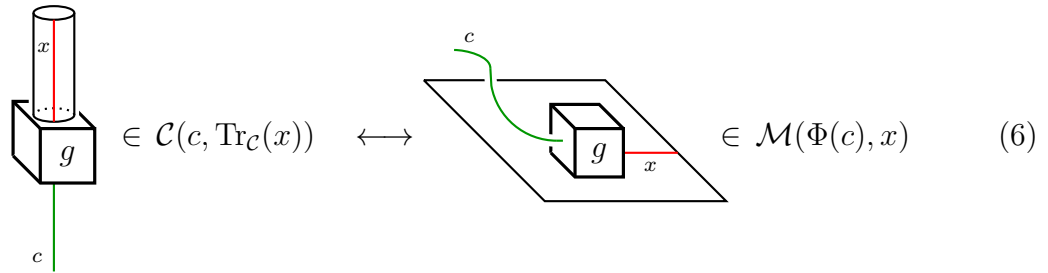

Visually, we can think of the above adjunction as the operation of opening the tube (like an umbrella) and then flattening it to a plane.

Definition 4.2 (the attaching map ε). Given $x \in \mathcal{M}$, we define $\varepsilon_x : \Phi(\mathrm{Tr}_{\mathcal{C}}(x)) \rightarrow x$ to be the image of $\mathrm{id}_{\mathrm{Tr}_{\mathcal{C}}(x)}$ under the correspondence (6). Equivalently, $\varepsilon : \Phi \circ \mathrm{Tr}_{\mathcal{C}} \rightarrow \mathrm{id}_{\mathcal{M}}$ is the counit of the adjunction $\Phi \dashv \mathrm{Tr}_{\mathcal{C}}$.

We represent the morphism ε_x as follows:

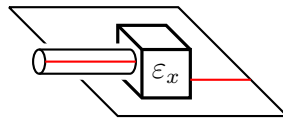

A possibly better graphical notation for ε_x is that of a tube coming out of the plane:

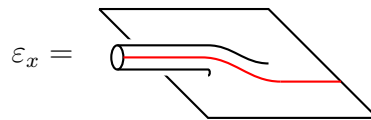

but in order to show that this graphical depiction of ε_x is valid, we would first need to prove properties such as (8), or (13). The next two lemmas are general results that hold for any adjunction.

Lemma 4.3. Let $a \in \mathcal{C}$ and $x \in \mathcal{M}$. Then, under the adjunction $\mathcal{C}(a, \text{Tr}_{\mathcal{C}}(x)) \cong \mathcal{M}(\Phi(a), x)$, a morphism $f \in \mathcal{C}(a, \text{Tr}_{\mathcal{C}}(x))$ corresponds to $\varepsilon_x \circ \Phi(f) \in \mathcal{M}(\Phi(a), x)$.

Proof. Since the adjunction is natural, the following diagram commutes:

$$\begin{array}{ccccc} \varepsilon_x & \in \mathcal{M}(\Phi(\text{Tr}_{\mathcal{C}}(x)), x) \cong \mathcal{C}(\text{Tr}_{\mathcal{C}}(x), \text{Tr}_{\mathcal{C}}(x)) \ni \text{id}_{\text{Tr}_{\mathcal{C}}(x)}, & & & \\ \downarrow & \Phi(f)^* \downarrow & & f^* \downarrow & \downarrow \\ \varepsilon_x \circ \Phi(f) & \in \mathcal{M}(\Phi(a), x) \cong \mathcal{C}(a, \text{Tr}_{\mathcal{C}}(x)) \ni f & & & \end{array}$$

where $f^*(g) = g \circ f$. □

Lemma 4.4. Suppose $f \in \mathcal{M}(x, y)$. Then $\varepsilon_y \circ \Phi(\text{Tr}_{\mathcal{C}}(f)) = f \circ \varepsilon_x$, i.e.,

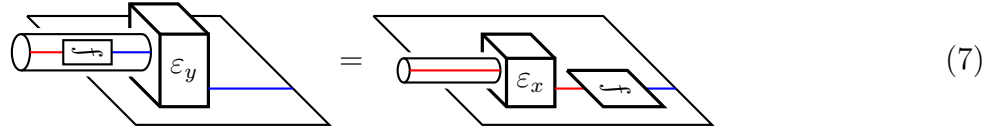
(7)

Proof. The counit of an adjunction is always a natural transformation [ML98, §IV.1]. □

4.2 The multiplication map

Definition 4.5. For $x, y \in \mathcal{M}$, there is a canonical map $\mu_{x,y} : \text{Tr}_{\mathcal{C}}(x) \otimes \text{Tr}_{\mathcal{C}}(y) \rightarrow \text{Tr}_{\mathcal{C}}(x \otimes y)$ given as the mate of

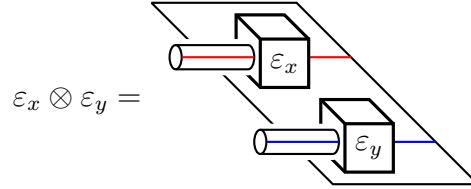

under the isomorphisms

$$\begin{aligned} \mathcal{M}(\Phi(\text{Tr}_{\mathcal{C}}(x)) \otimes \Phi(\text{Tr}_{\mathcal{C}}(y)), x \otimes y) &\cong \mathcal{M}(\Phi(\text{Tr}_{\mathcal{C}}(x) \otimes \text{Tr}_{\mathcal{C}}(y)), x \otimes y) \\ &\cong \mathcal{C}(\text{Tr}_{\mathcal{C}}(x) \otimes \text{Tr}_{\mathcal{C}}(y), \text{Tr}_{\mathcal{C}}(x \otimes y)), \end{aligned}$$

where we used that Φ is a tensor functor. Diagrammatically, we denote μ by a pair of pants:

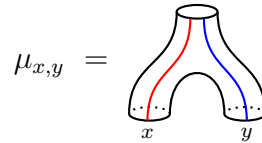

Our next task will be to show that μ is associative. We begin by showing that it is compatible with the attaching map ε :

Lemma 4.6. For any $x, y \in \mathcal{M}$, we have $\varepsilon_{x \otimes y} \circ \Phi(\mu_{x,y}) = \varepsilon_x \otimes \varepsilon_y$.

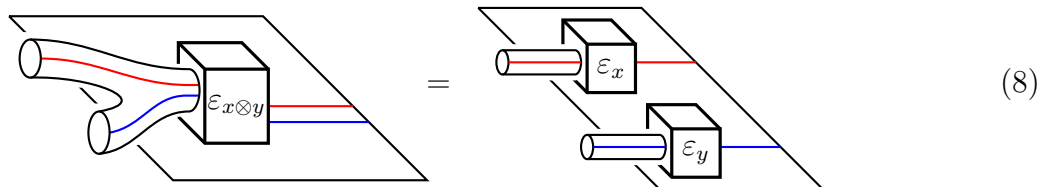
(8)

Proof. By definition, $\varepsilon_x \otimes \varepsilon_y$ is the mate of $\mu_{x,y}$ under the adjunction. Now apply Lemma 4.3 to see that $\mu_{x,y}$ is also the mate of $\varepsilon_{x \otimes y} \circ \Phi(\mu_{x,y})$. \square

As a corollary, we see $\mu_{x,y}$ that is natural in x and y :

Corollary 4.7. *For all $x, y, z \in \mathcal{M}$ and all $f : y \rightarrow z$ in \mathcal{M} , we have $\mu_{x,z} \circ (\text{id}_{\text{Tr}_C(x)} \otimes \text{Tr}_C(f)) = \text{Tr}_C(\text{id}_x \otimes f) \circ \mu_{x,y}$. In diagrams,*

$$(9)$$

Similarly, for $g : w \rightarrow x$, we have $\mu_{x,y} \circ (\text{Tr}_C(g) \otimes \text{id}_{\text{Tr}_C(y)}) = \text{Tr}_C(g \otimes \text{id}_y) \circ \mu_{w,y}$.

Proof. We only show the first statement; the other is similar. By taking mates, and using Lemma 4.3, Equation (9) becomes $\varepsilon \circ \Phi(\mu_{x,z} \circ (\text{id}_{\text{Tr}_C(x)} \otimes \text{Tr}_C(f))) = \varepsilon \circ \Phi(\text{Tr}_C(\text{id}_x \otimes f) \circ \mu_{x,y})$

$$=$$

which follows readily from Lemmas 4.6 and 4.4, along with the fact that Φ is a tensor functor. \square

Lemma 4.8. *The multiplication map μ is associative, i.e., the following diagram commutes:*

$$\begin{array}{ccc} \text{Tr}_C(x) \otimes \text{Tr}_C(y) \otimes \text{Tr}_C(z) & \xrightarrow{\text{id}_{\text{Tr}_C(x)} \otimes \mu} & \text{Tr}_C(x) \otimes \text{Tr}_C(y \otimes z) \\ \mu \otimes \text{id}_{\text{Tr}_C(z)} \downarrow & & \downarrow \mu \\ \text{Tr}_C(x \otimes y) \otimes \text{Tr}_C(z) & \xrightarrow{\mu} & \text{Tr}_C(x \otimes y \otimes z) \end{array}$$

In diagrams,

$$(10)$$

Proof. We claim that, under the adjunction, each map individually is the mate of

$$\in \mathcal{M}(\Phi(\text{Tr}_C(x) \otimes \text{Tr}_C(y) \otimes \text{Tr}_C(z)), x \otimes y \otimes z).$$

We only prove this for the right hand side of Equation (10) (the left hand side is similar). The mate of the right hand side is given by

$$\begin{aligned} \varepsilon_{x \otimes y \otimes z} \circ \Phi(\mu_{x,y \otimes z} \circ (\text{id}_{\text{Tr}_{\mathcal{C}}(x)} \otimes \mu_{y,z})) &= \varepsilon_{x \otimes y \otimes z} \circ \Phi(\mu_{x,y \otimes z}) \circ \Phi(\text{id}_{\text{Tr}_{\mathcal{C}}(x)} \otimes \mu_{y,z}) \\ &= (\varepsilon_x \otimes \varepsilon_{y \otimes z}) \circ (\Phi(\text{id}_{\text{Tr}_{\mathcal{C}}(x)}) \otimes \Phi(\mu_{y,z})) = \varepsilon_x \otimes (\varepsilon_{y \otimes z} \circ \Phi(\mu_{y,z})) = \varepsilon_x \otimes (\varepsilon_y \otimes \varepsilon_z), \end{aligned}$$

where the first equality is the functoriality of Φ , the second equality is Lemma 4.6 and the fact that Φ is a tensor functor, and the fourth equality is again Lemma 4.6. \square

4.3 The unit of the adjunction

In Section 4.1 we studied the attaching map ε , which is the counit of the adjunction $\Phi \dashv \text{Tr}_{\mathcal{C}}$. We now study the unit of the adjunction, which we denote η .

Thus, for any object $c \in \mathcal{C}$, we have a morphism $\eta_c : c \rightarrow \text{Tr}_{\mathcal{C}}(\Phi(c))$. We will also write $i : 1_{\mathcal{C}} \rightarrow \text{Tr}_{\mathcal{C}}(1_{\mathcal{M}})$ for the unit η evaluated on the unit object $1_{\mathcal{C}} \in \mathcal{C}$. We represent η and i by the following diagrams:

$$\eta_c = \text{[Diagram: A cylinder with a green loop on its side]} \quad i = \text{[Diagram: A simple cylinder]}$$

Since we have an adjunction $\Phi \dashv \text{Tr}_{\mathcal{C}}$, the counit ε and the unit η interact in the following way:

- (1) For $x \in \mathcal{M}$, the mate of ε_x is $\text{id}_{\text{Tr}_{\mathcal{C}}(x)}$. Hence $\text{Tr}_{\mathcal{C}}(\varepsilon_x) \circ \eta_{\text{Tr}_{\mathcal{C}}(x)} = \text{id}_{\text{Tr}_{\mathcal{C}}(x)}$. We represent this diagrammatically by the following relation.

$$\text{[Diagram: A cylinder with a box labeled } \varepsilon \text{ on its side and a green loop labeled } \eta_{\text{Tr}_{\mathcal{C}}(x)} \text{ on its bottom]} = \text{[Diagram: A simple cylinder]} \quad (11)$$

- (2) For $c \in \mathcal{C}$, the mate of η_c is $\text{id}_{\Phi(c)}$. So by Lemma 4.3, $\Phi(\eta_c) \circ \varepsilon_{\Phi(c)} = \text{id}_{\Phi(c)}$. We represent this diagrammatically by the following relation.

$$\text{[Diagram: A cylinder with a box labeled } \varepsilon \text{ on its side and a green loop labeled } \eta_c \text{ on its bottom]} = \text{[Diagram: A simple cylinder]} \quad (12)$$

The following lemmas demonstrate how η and i interact with the graphical calculus introduced so far.

Lemma 4.9. *The following diagram commutes:*

$$\begin{array}{ccccc} 1_{\mathcal{C}} \otimes \text{Tr}_{\mathcal{C}}(x) & \xrightarrow{\quad} & \text{Tr}_{\mathcal{C}}(x) & \xleftarrow{\quad} & \text{Tr}_{\mathcal{C}}(x) \otimes 1_{\mathcal{C}} \\ \downarrow i \otimes \text{id}_{\text{Tr}_{\mathcal{C}}(x)} & & \downarrow \text{id}_{\text{Tr}_{\mathcal{C}}(x)} & & \downarrow \text{id}_{\text{Tr}_{\mathcal{C}}(x)} \otimes i \\ \text{Tr}_{\mathcal{C}}(1) \otimes \text{Tr}_{\mathcal{C}}(x) & \xrightarrow{\mu} & \text{Tr}_{\mathcal{C}}(1 \otimes x) & \xrightarrow{\quad} & \text{Tr}_{\mathcal{C}}(x) \\ & & \downarrow & & \downarrow \\ & & \text{Tr}_{\mathcal{C}}(x) & \xleftarrow{\quad} & \text{Tr}_{\mathcal{C}}(x \otimes 1) \xleftarrow{\mu} \text{Tr}_{\mathcal{C}}(x) \otimes \text{Tr}_{\mathcal{C}}(1). \end{array}$$

In pictures, this is

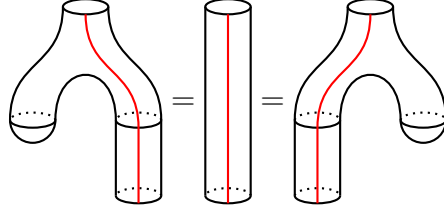

Proof. We check that the left square commutes upon taking mates (the right one is similar). Using Lemma 4.3, we compute:

$$\begin{aligned} \varepsilon_x \circ \Phi(\mu_{1,x} \circ (i \otimes \text{id}_{\text{Tr}_{\mathcal{C}}(x)})) &= \varepsilon_x \circ \Phi(\mu_{1,x}) \circ \Phi(i \otimes \text{id}_{\text{Tr}_{\mathcal{C}}(x)}) \\ &= (\varepsilon_1 \otimes \varepsilon_x) \circ (\Phi(i) \otimes \Phi(\text{id}_{\text{Tr}_{\mathcal{C}}(x)})) = (\varepsilon_1 \circ \Phi(i)) \otimes \varepsilon_x = \varepsilon_x. \end{aligned}$$

We have used Lemma 4.6 for the second equality, and Equation (12) for the last one. \square

Note that a lot of what we have done so far is to reprove in our special case the well known fact that the adjoint of a tensor functor is a lax tensor functor [Kel74]. The data is provided by the natural transformations μ and η , and the axioms are verified in Lemmas 4.8 and 4.9.

Lemma 4.10. *For $c, d \in \mathcal{C}$, we have $\eta_{c \otimes d} = \mu_{\Phi(c), \Phi(d)} \circ (\eta_c \otimes \eta_d)$. In diagrams:*

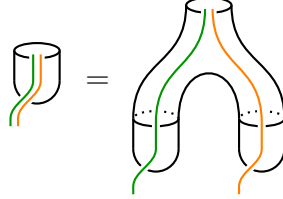

Proof. By Equation (12), we know that $\Phi(\eta_{c \otimes d}) \circ \varepsilon_{\Phi(c \otimes d)} = \text{id}_{\Phi(c \otimes d)}$, so it suffices to show that the mate of the right hand side is equal to $\text{id}_{\Phi(c \otimes d)}$. The result now follows from Lemma 4.6 together with two applications of the relation (12).

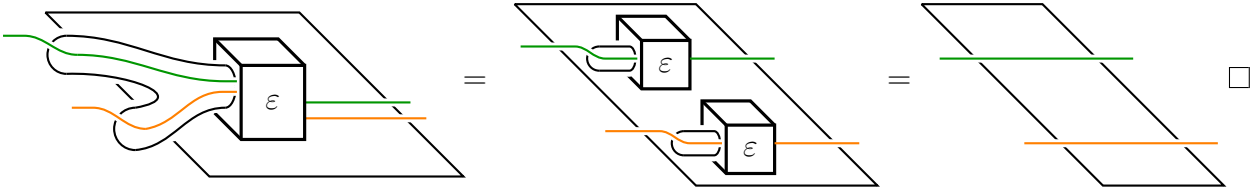

Lemma 4.11. *The following two maps $\text{Tr}_{\mathcal{C}}(x) \otimes c \rightarrow \text{Tr}_{\mathcal{C}}(x \otimes \Phi(c))$ are equal:*

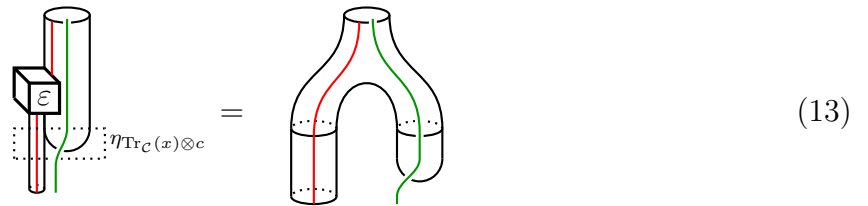

Moreover, when \mathcal{C} is rigid, the above map (13) is invertible.

Proof. To show that the two sides of (13) are equal, apply Lemma 4.10 to the left hand side and use Equation (11).

If we assume that c is dualizable, then we can write down an inverse to the above map:

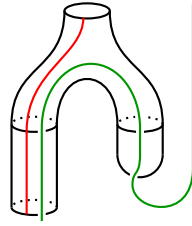

$$: \mathrm{Tr}_{\mathcal{C}}(x \otimes \Phi(c)) \rightarrow \mathrm{Tr}_{\mathcal{C}}(x) \otimes c$$

In formulas, this is:

$$[(\mathrm{Tr}_{\mathcal{C}}(\mathrm{ev}_{\Phi(*c)}) \circ \mu_{x \otimes \Phi(c), \Phi(*c)} \circ (\mathrm{id}_{\mathrm{Tr}_{\mathcal{C}}(x \otimes \Phi(c))} \otimes \eta_{*c})) \otimes \mathrm{id}_c] \circ (\mathrm{id}_{\mathrm{Tr}_{\mathcal{C}}(x \otimes \Phi(c))} \otimes \mathrm{coev}_{*c}),$$

where we have used the canonical identification $\Phi(*c) \cong *\Phi(c)$ provided by the fact that Φ is a tensor functor. The two maps compose to the identity by a straightforward application of Lemma 4.8 (the associativity of μ), Lemma 4.10, and the naturality of η . \square

4.4 Construction of the traciator

So far we have constructed the multiplication $\mu_{x,y} : \mathrm{Tr}_{\mathcal{C}}(x) \otimes \mathrm{Tr}_{\mathcal{C}}(y) \rightarrow \mathrm{Tr}_{\mathcal{C}}(x \otimes y)$ and the corresponding unit map under the assumption that \mathcal{C} and \mathcal{M} are tensor categories and that $\Phi : \mathcal{C} \rightarrow \mathcal{M}$ is a tensor functor. However, the construction of the traciator, along with the proof that it equips $\mathrm{Tr}_{\mathcal{C}}$ with the structure of a categorified trace, only depends on $\Phi : \mathcal{C} \rightarrow \mathcal{M}$ factoring through $\mathcal{Z}(\mathcal{M})$, and not on it being a tensor functor. The material of this section can be found in [BFO09, Prop. 5] and [Ost14, Prop. 2.5].

We fix the following notation for Section 4.4.

Notation 4.12.

- \mathcal{C} is a category
- \mathcal{M} is a pivotal category,
- $\Phi^z : \mathcal{C} \rightarrow \mathcal{Z}(\mathcal{M})$ is a functor,
- the trace functor $\mathrm{Tr}_{\mathcal{C}} : \mathcal{M} \rightarrow \mathcal{C}$ is the right adjoint of $\Phi := F \circ \Phi^z$.

Definition 4.13. For $x, y \in \mathcal{M}$, we define the traciator $\tau_{x,y} : \mathrm{Tr}_{\mathcal{C}}(x \otimes y) \rightarrow \mathrm{Tr}_{\mathcal{C}}(y \otimes x)$ in the following way. Let $c = \mathrm{Tr}_{\mathcal{C}}(x \otimes y)$, and let us write $\tilde{\mathrm{ev}}_y : y \otimes y^* \rightarrow 1$ for the composite $\mathrm{ev}_{y^*} \circ (\varphi_y \otimes \mathrm{id}_{y^*})$, with $\varphi_y : y \rightarrow y^{**}$ the pivotal structure. Then $\tau_{x,y}$ is the mate of

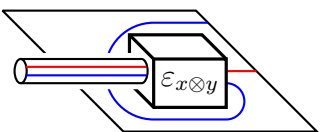
$$(\mathrm{id}_{y \otimes x} \otimes \tilde{\mathrm{ev}}_y) \circ (\mathrm{id}_y \otimes \varepsilon_{x \otimes y} \otimes \mathrm{id}_{y^*}) \circ (e_{\Phi(c), y} \otimes \mathrm{id}_{y^*}) \circ (\mathrm{id}_{\Phi(c)} \otimes \mathrm{coev}_y) =$$



under the adjunction $\mathcal{M}(\Phi(\mathrm{Tr}_{\mathcal{C}}(x \otimes y)), y \otimes x) \cong \mathcal{C}(\mathrm{Tr}_{\mathcal{C}}(x \otimes y), \mathrm{Tr}_{\mathcal{C}}(y \otimes x))$.

As we will see shortly, the traciator is always invertible. We will sometimes write $\tau_{x,y}^+$ for $\tau_{x,y}$, and $\tau_{x,y}^-$ for $\tau_{y,x}^{-1}$. In terms of 3-dimensional diagrams, the traciators $\tau^\pm : \text{Tr}_C(x \otimes y) \rightarrow \text{Tr}_C(y \otimes x)$ are depicted

$$\tau^+ = \text{cylinder with red and blue strands crossing} \quad \text{and} \quad \tau^- = \text{cylinder with red and blue strands crossing in reverse}$$

Lemma 4.14. *The traciator $\tau_{y,x}$ is invertible, and its inverse $\tau_{x,y}^-$ is the mate of*

$$\text{3D diagram of } \varepsilon_{x \otimes y} \text{ with red and blue strands} \in \mathcal{M}(\Phi(\text{Tr}_C(x \otimes y)), y \otimes x) \quad (14)$$

Proof. Let us define $\tilde{\tau}_{x,y}^-$ to be the mate of (14) and let us agree, for the purpose of this proof, to reserve the graphical notation  for $\tilde{\tau}_{x,y}^-$. We need to show that $\tilde{\tau}_{x,y}^- = \tau_{x,y}^-$. Equivalently, we need to show that the following two equations hold:

$$\tau_{y,x} \circ \tilde{\tau}_{x,y}^- = \text{id}_{\text{Tr}_C(x \otimes y)} = \tilde{\tau}_{y,x}^- \circ \tau_{x,y} \quad : \quad \text{cylinder} = \text{cylinder} = \text{cylinder}$$

We only treat the first one (the other is entirely similar): upon taking mates, we get

$$\begin{aligned} & \text{3D diagram of } \tilde{\tau}_{x,y}^- \text{ with } \varepsilon_{x \otimes y} \text{ box} = \text{3D diagram of } \tilde{\tau}_{x,y}^- \text{ with } \varepsilon_{y \otimes x} \text{ box} = \\ & = \text{3D diagram of } \tau_{x,y}^- \text{ with } \varepsilon_{x \otimes y} \text{ box} = \text{3D diagram of } \tau_{x,y}^- \text{ with } \varepsilon_{x \otimes y} \text{ box} \end{aligned}$$

where we have used Lemma 4.3 for the first two equalities. The last equal sign follows from the zig-zag equations satisfied by the (co)evaluation morphisms ev , $\tilde{\text{ev}}$, coev , and $\tilde{\text{coev}}$. \square

By Lemmas 4.14 and 4.3, the traciators satisfy

$$\text{3D diagram of } \varepsilon_{y \otimes x} \text{ with red and blue strands} = \text{3D diagram of } \varepsilon_{x \otimes y} \text{ with red and blue strands} \quad (15.a)$$

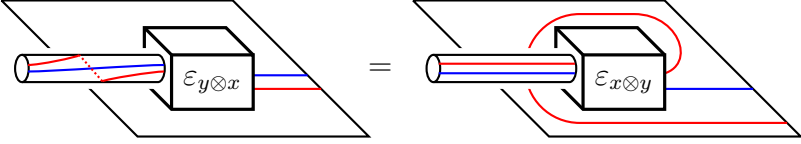
and  (15.b)

Remark 4.15. In the event that \mathcal{M} is rigid but not pivotal, we only get isomorphisms $\tau^+ : \text{Tr}_{\mathcal{C}}(x \otimes y) \rightarrow \text{Tr}_{\mathcal{C}}(**y \otimes x)$ and $\tau^- : \text{Tr}_{\mathcal{C}}(x \otimes y) \rightarrow \text{Tr}_{\mathcal{C}}(y \otimes x^{**})$. All of our theorems can be generalised to this more general situation, provided double duals are inserted in the appropriate places.

We now prove the naturality of the traciator, and that it satisfies the axiom of a categorified trace.

Lemma 4.16. *The two maps $\text{Tr}_{\mathcal{C}}(x \otimes y \otimes z) \rightarrow \text{Tr}_{\mathcal{C}}(y \otimes z \otimes x)$ given by $\tau_{x,y \otimes z}$ and by $\tau_{z \otimes x,y} \circ \tau_{x \otimes y,z}$ are equal. In diagrams:*

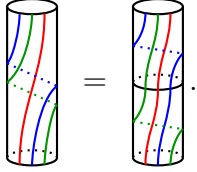

Similarly, we have $\tau_{x \otimes y,z}^- = \tau_{y,z \otimes x}^- \circ \tau_{x,y \otimes z}^-$.

Proof. The first statement is equivalent, upon taking mates, to the equation

$$\epsilon_{y \otimes z \otimes x} \circ \Phi(\tau_{z \otimes x,y} \circ \tau_{x \otimes y,z}) = \epsilon_{y \otimes z \otimes x} \circ \Phi(\tau_{x,y \otimes z}).$$

The argument is similar to the one in the previous lemma:

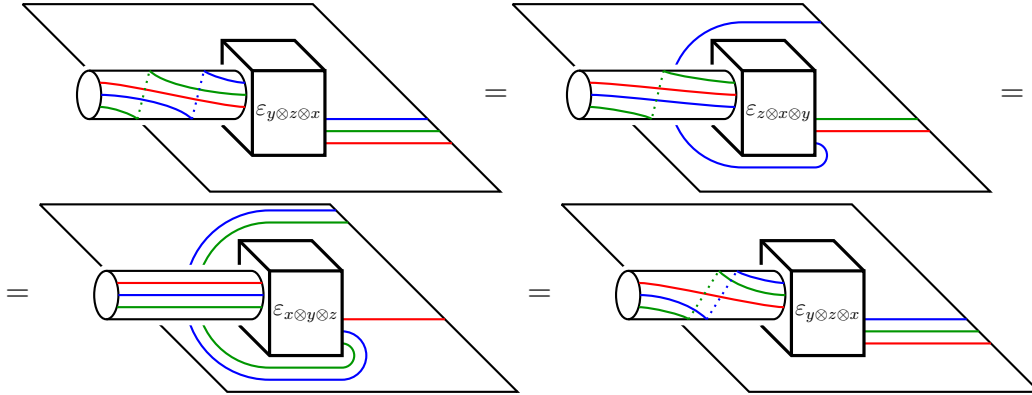

Here, we have used Equation (15.a) for the first two equalities, and we have used Equation (15.a) along with the identities

$$\begin{aligned} \tilde{e}v_{y \otimes z} &= \tilde{e}v_y \circ (\text{id}_y \otimes \tilde{e}v_z \otimes \text{id}_{y^*}) \\ \text{coe}v_{y \otimes z} &= (\text{id}_y \otimes \text{coe}v_z \otimes \text{id}_{y^*}) \circ \text{coe}v_y \end{aligned}$$

for the last equality. The second statement follows from the first one by taking inverses. \square

Naturality of the traciator is given by the following lemma.

Lemma 4.17. For $f \in \mathcal{M}(x, w)$ and $g \in \mathcal{M}(y, z)$, we have $\tau_{w,z} \circ \text{Tr}_{\mathcal{C}}(f \otimes g) = \text{Tr}_{\mathcal{C}}(g \otimes f) \circ \tau_{x,y}$, and similarly for τ^- . In diagrams:

(16)

Proof. By Equation (15.a) and Lemma 4.4, the two sides of (16) are mates of

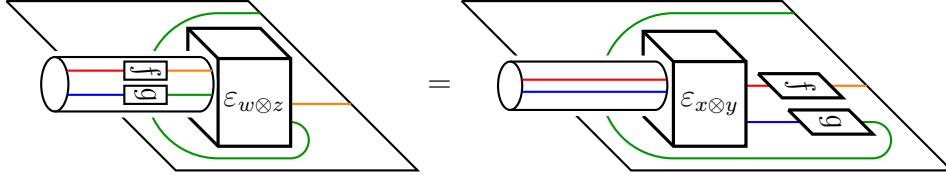

and

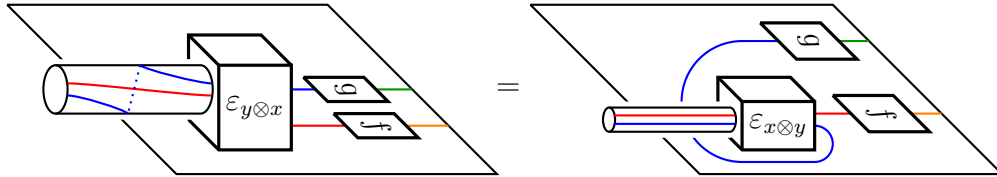

respectively. The latter are equal by pivotality in \mathcal{M} . □

4.5 Interaction between traciator and braiding

In Sections 4.1–4.3, we saw that when $\text{Tr}_{\mathcal{C}}$ is the adjoint of a tensor functor, it can be described by a graphical calculus of strings on tubes. The tubes are allowed to split, but the strings must remain on the fronts of the tubes. In Section 4.4, we also saw that when Φ is a central functor (not assumed monoidal) $\text{Tr}_{\mathcal{C}}$ admits a graphical calculus of strings winding around a single tube.

In this section, we start by assuming that Φ is a monoidal central functor. The tubes, with the strings on their surface are now allowed to branch, but they must remain in a single plane. Finally, we go on to assume our strongest hypothesis, namely that Φ is a braided central functor. The tubes can now braid freely in three dimensions (see Figure 1 in the introduction).

We begin with the following assumptions:



Notation 4.18.

- \mathcal{C} and \mathcal{M} are pivotal categories
- $\Phi^z : \mathcal{C} \rightarrow \mathcal{Z}(\mathcal{M})$ is a pivotal tensor functor,
- the trace functor $\text{Tr}_{\mathcal{C}} : \mathcal{M} \rightarrow \mathcal{C}$ is the right adjoint of $\Phi := F \circ \Phi^z$.

Under these assumptions, we can establish a generalization of the associativity of μ :

Lemma 4.19. *Given $w, x, y, z \in \mathcal{M}$, the following two morphisms in $\mathcal{C}(\mathrm{Tr}_{\mathcal{C}}(w) \otimes \mathrm{Tr}_{\mathcal{C}}(x \otimes y) \otimes \mathrm{Tr}_{\mathcal{C}}(z), \mathrm{Tr}_{\mathcal{C}}(w \otimes x \otimes z \otimes y))$ are equal:*

$$(17)$$

Remark 4.20. In the above equation, it is best to imagine the blue strands as running along the backs of the tubes: pre- and postcomposing by the “half-traciators”  and , Equation (17) becomes

Proof. We start from the left hand side, whose mate is given by

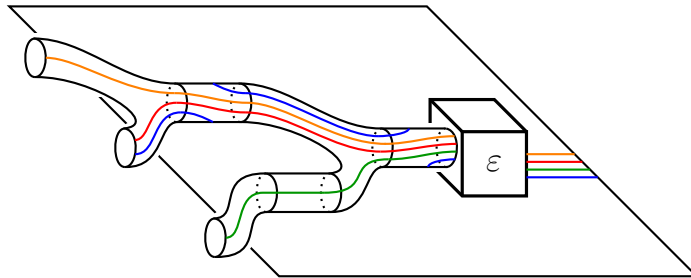

By successive application of Equations (15.b), (8), (15.a), and then once again (8), we can rewrite this as:

$$\in \mathcal{M}(\Phi(\mathrm{Tr}_{\mathcal{C}}(w) \otimes \mathrm{Tr}_{\mathcal{C}}(x \otimes y) \otimes \mathrm{Tr}_{\mathcal{C}}(z)), w \otimes x \otimes z \otimes y). \quad (18)$$

Starting instead from the right hand side of (17), if we take its mate as above, and apply (8), then (15.b), then (8), and finally (15.a), we obtain the same picture (18). \square

We now prove a compatibility between the traciator and the unit η .

Lemma 4.21. *For $x \in \mathcal{M}$ and $c \in \mathcal{C}$, the following diagram commutes:*

$$\begin{array}{ccccc}
 & & \mathcal{C} & & \\
 & \eta \swarrow & \downarrow \eta & \searrow \eta & \\
 \mathrm{Tr}_{\mathcal{C}}(\Phi(c)) & & \mathrm{Tr}_{\mathcal{C}}(\Phi(c)) & & \mathrm{Tr}_{\mathcal{C}}(\Phi(c)) \\
 \downarrow \mathrm{Tr}_{\mathcal{C}}(\mathrm{id} \otimes \mathrm{coev}_x) & & \downarrow \mathrm{Tr}_{\mathcal{C}}((e_{\Phi(c),x} \otimes \mathrm{id}) \circ (\mathrm{id} \otimes \mathrm{coev}_x)) & & \downarrow \mathrm{Tr}_{\mathcal{C}}(\mathrm{coev}_x \otimes \mathrm{id}) \\
 \mathrm{Tr}_{\mathcal{C}}(\Phi(c) \otimes x^* \otimes x) & \xrightarrow{\tau^+} & \mathrm{Tr}_{\mathcal{C}}(x \otimes \Phi(c) \otimes x^*) & \xleftarrow{\tau^-} & \mathrm{Tr}_{\mathcal{C}}(x^* \otimes x \otimes \Phi(c))
 \end{array}$$

In diagrams,

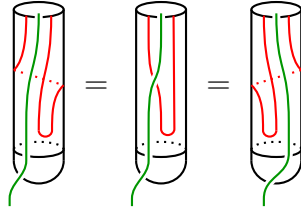

Proof. We only prove that the left hand diagram commutes (the other one is similar). The mate of the leftmost map can be simplified in the following way:

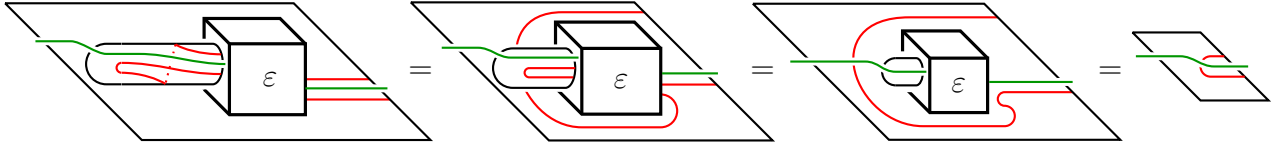

where we have used Equation (15.a), then Lemma 4.4 (naturality of ε), and finally Equation (12). It agrees with the mate of the middle map:

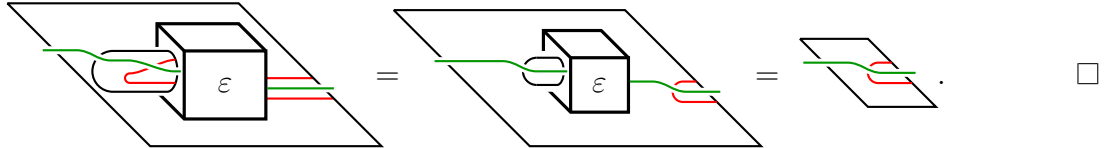

We now assume that \mathcal{C} and Φ^z are braided, so that $\mathrm{Tr}_{\mathcal{C}}$ is the categorified trace associated to a pivotal module tensor category. In this context, we establish certain relations between $\mathrm{Tr}_{\mathcal{C}}$ and the braiding and twist of \mathcal{C} . We begin by examining the traciator and the twist.

Lemma 4.22. *Let $c \in \mathcal{C}$ and $x \in \mathcal{M}$ be objects. Then for every $f \in \mathcal{M}(\Phi(c), x)$, we have*

$$f \circ \Phi(\theta_c) = (\mathrm{id}_x \otimes \tilde{e}_v_x) \circ (\mathrm{id}_x \otimes f \otimes \mathrm{id}_{x^*}) \circ (e_{\Phi(c),x} \otimes \mathrm{id}_{x^*}) \circ (\mathrm{id}_{\Phi(c)} \otimes \mathrm{coev}_x),$$

where $\tilde{e}_v_x : x \otimes x^* \rightarrow 1$ is as in Definition 4.13. In diagrams:

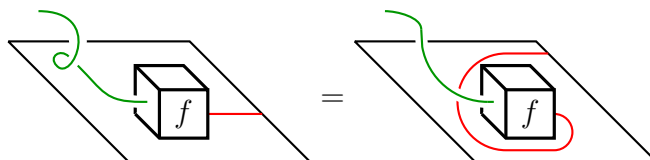

Lemma 4.26. *Given $x, y \in \mathcal{M}$, we have*

$$\tau_{x,y} \circ \mu_{x,y} = \mu_{y,x} \circ \beta_{\mathrm{Tr}_{\mathcal{C}}(x), \mathrm{Tr}_{\mathcal{C}}(y)} \circ (\mathrm{id}_{\mathrm{Tr}_{\mathcal{C}}(x)} \otimes \theta_{\mathrm{Tr}_{\mathcal{C}}(y)}).$$

In diagrams:

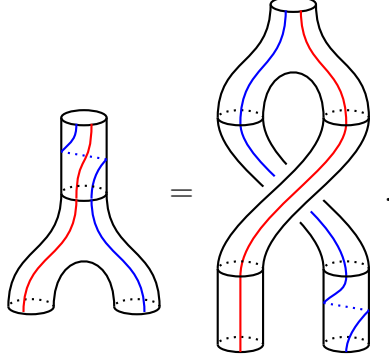

Similarly, we have $\tau_{x,y}^- \circ \mu_{x,y} = \mu_{y,x} \circ \beta_{\mathrm{Tr}_{\mathcal{C}}(x), \mathrm{Tr}_{\mathcal{C}}(y)}^- \circ (\theta_{\mathrm{Tr}_{\mathcal{C}}(x)}^{-1} \otimes \mathrm{id}_{\mathrm{Tr}_{\mathcal{C}}(y)})$.

Proof. We only prove the first claim. By taking mates, it is equivalent to the equation

where we have used (15.a) and Lemma 4.6 for the left hand side, and Lemma 4.6 for the right hand side. Equation (19) now follows from Proposition 4.23 and Lemma 4.25. \square

5 Traces of algebras and semisimplicity

We have seen in Section 4 that our categorified trace is a lax monoidal functor. As a result, it takes algebra objects to algebra objects. In fact, given two algebras A and B , we will see that $\mathrm{Tr}_{\mathcal{C}}(A \otimes B)$ is also naturally equipped with an algebra structure. What is more, under mild additional assumptions, we will see that $\mathrm{Tr}_{\mathcal{C}}(A \otimes B)$ is semisimple when both A and B are. We begin by investigating the semisimplicity of $\mathrm{Tr}_{\mathcal{C}}(A)$ under weaker assumptions than those necessary to study $\mathrm{Tr}_{\mathcal{C}}(A \otimes B)$.

5.1 The algebra $\mathrm{Tr}_{\mathcal{C}}(A)$

If $A = (A, m_A, i_A)$ is an algebra object in \mathcal{M} , then $\mathrm{Tr}_{\mathcal{C}}(A)$ is an algebra object in \mathcal{C} , where the multiplication and unit maps are given by:

$$m_{\mathrm{Tr}_{\mathcal{C}}(A)} := \mathrm{Tr}_{\mathcal{C}}(m_A) \circ \mu_{A,A} = \text{diagram of a Y-junction with red strands} \quad i_{\mathrm{Tr}_{\mathcal{C}}(A)} := \mathrm{Tr}_{\mathcal{C}}(i_A) \circ i = \text{diagram of a vertical strand with a red line inside a cylinder}.$$

Recall that an algebra object A in a semisimple tensor category \mathcal{M} is called semisimple if its category of A -modules $\mathrm{Mod}_{\mathcal{M}}(A)$ is semisimple. The following is the main result of this subsection:

Theorem 5.1. *Let \mathcal{C} and \mathcal{M} be rigid semisimple tensor categories. Let $\Phi : \mathcal{C} \rightarrow \mathcal{M}$ be a tensor functor, with right adjoint $\mathrm{Tr}_{\mathcal{C}}$. If A is a semisimple algebra object in \mathcal{M} , then $\mathrm{Tr}_{\mathcal{C}}(A)$ is a semisimple algebra object in \mathcal{C} .*

Proof. Let us write B for $\mathrm{Tr}_{\mathcal{C}}(A)$. We prove the theorem by finding an equivalent, manifestly semisimple, description of the category $\mathbf{Mod}_{\mathcal{C}}(B)$ of B -modules.

Let \mathcal{N}_0 be the essential image of the functor $\mathcal{C} \rightarrow \mathbf{Mod}_{\mathcal{M}}(A) : c \mapsto A \otimes \Phi(c)$, and let \mathcal{N} be the idempotent completion of \mathcal{N}_0 . The category \mathcal{N} can equivalently be described as the full subcategory of $\mathbf{Mod}_{\mathcal{M}}(A)$ generated by the simple objects that occur as summands of $A \otimes \Phi(c)$ for $c \in \mathcal{C}$. The trace functor induces a functor

$$\mathrm{Tr}_{\mathcal{C}}^{\mathbf{Mod}(A)} : \mathbf{Mod}_{\mathcal{M}}(A) \rightarrow \mathbf{Mod}_{\mathcal{C}}(B),$$

which in turn restricts to a functor

$$\mathcal{N} \hookrightarrow \mathbf{Mod}_{\mathcal{M}}(A) \xrightarrow{\mathrm{Tr}_{\mathcal{C}}^{\mathbf{Mod}(A)}} \mathbf{Mod}_{\mathcal{C}}(B).$$

We will prove that the latter is an equivalence of categories $\mathcal{N} \cong \mathbf{Mod}_{\mathcal{C}}(B)$. Since \mathcal{N} is semisimple, this will immediately imply the theorem.

• *The functor $\mathrm{Tr}_{\mathcal{C}}^{\mathbf{Mod}(A)}|_{\mathcal{N}}$ is fully faithful.* It suffices to show that the restriction of $\mathrm{Tr}_{\mathcal{C}}^{\mathbf{Mod}(A)}$ to \mathcal{N}_0 is fully faithful. By definition, any object of \mathcal{N}_0 is of the form $A \otimes \Phi(c)$ for some $c \in \mathcal{C}$. We must prove that the map

$$\mathrm{Tr}_{\mathcal{C}}^{\mathbf{Mod}(A)} : \mathcal{N}_0(A \otimes \Phi(c), A \otimes \Phi(d)) \rightarrow \mathcal{C}_B(\mathrm{Tr}_{\mathcal{C}}(A \otimes \Phi(c)), \mathrm{Tr}_{\mathcal{C}}(A \otimes \Phi(d)))$$

given by

$$\text{Diagram (20): } \text{A 3D box } f \text{ on a plane with inputs } c \text{ and } d \text{ and output } f \text{ is mapped to } \mathrm{Tr}_{\mathcal{C}} \left(\text{A 3D box } f \text{ on a plane with inputs } c \text{ and } d \text{ and output } f \right) = \text{A 2D cylinder with box } f \text{ and inputs } c, d \text{ and output } f.$$

is an isomorphism.

We claim that its inverse is provided by

$$\text{Diagram (21): } \text{A 2D cylinder with box } g \text{ and inputs } c, d \text{ and output } g \text{ is mapped to } \text{A 3D box } g \text{ on a plane with inputs } c \text{ and } d \text{ and output } g \text{ and } \epsilon.$$

$$g \mapsto (m_A \otimes \mathrm{id}_{\Phi(d)}) \circ (\mathrm{id}_A \otimes [\varepsilon_{A \otimes \Phi(d)} \circ \Phi(g \circ \mathrm{Tr}_{\mathcal{C}}(i_A \otimes \mathrm{id}_{\Phi(c)}) \circ \eta_c)])$$

We show that (20) and (21) compose both ways to the identity. One direction goes as follows:

$$\begin{aligned}
 ((21) \circ (20))(f) &= \text{Diagram 1} = \text{Diagram 2} \\
 &= \text{Diagram 3} = \text{Diagram 4} = f.
 \end{aligned}$$

The second equality holds by the naturality of ε , the third equality is Equation (12), and the fourth one follows from f being an A -module map.

For the other direction, it is convenient to precompose both sides of the equation by the isomorphism

$$\text{Diagram (22)} : B \otimes c \rightarrow \text{Tr}_c(A \otimes \Phi(c)) \quad (22)$$

provided by Lemma 4.11:

$$\begin{aligned}
 ((20) \circ (21))(g) \circ (22) &= \text{Diagram 1} = \text{Diagram 2} = \text{Diagram 3} \\
 &= \text{Diagram 4} = \text{Diagram 5} = \text{Diagram 6} = g \circ (22).
 \end{aligned}$$

Here, the second and third equations follows by the naturality of μ and η . The fourth equality is the content of Equation (11), and the fifth one holds because g is a B -module map.

• The functor $\mathrm{Tr}_{\mathcal{C}}^{\mathrm{Mod}(A)}|_{\mathcal{N}}$ is essentially surjective. Every B -module $c \in \mathcal{C}$ fits in a coequalizer diagram $B \otimes B \otimes c \rightrightarrows B \otimes c \rightarrow c$:

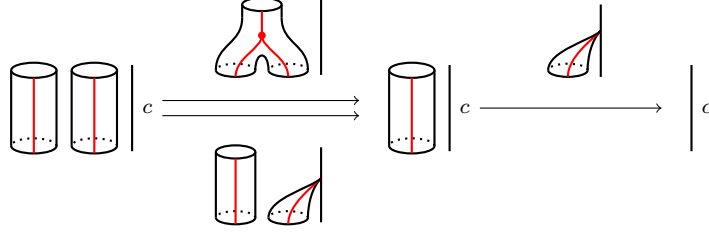

Using the isomorphism (22), we see that $B \otimes B \otimes c$ and $B \otimes c$ are in the essential image of \mathcal{N} . We are now finished by Lemma 5.2 below. \square

Lemma 5.2. *Suppose $\mathcal{N}_1, \mathcal{N}_2$ are linear categories with \mathcal{N}_1 semisimple. Let $T : \mathcal{N}_1 \rightarrow \mathcal{N}_2$ be a fully faithful linear functor. Assume that every $b \in \mathcal{N}_2$ sits in a coequalizer diagram $T(a_1) \rightrightarrows T(a_2) \rightarrow b$. Then T is essentially surjective (and thus an equivalence of categories).*

Proof. We may replace the coequalizer diagram by an exact sequence

$$T(a_1) \xrightarrow{f} T(a_2) \rightarrow b \rightarrow 0.$$

Let $g : a_1 \rightarrow a_2$ be the map such that $T(g) = f$. Using semisimplicity, the map g is isomorphic to one of the form

$$\begin{pmatrix} 1 & 0 \\ 0 & 0 \end{pmatrix} : a_0 \oplus a'_1 \rightarrow a_0 \oplus a'_2.$$

The same holds after applying the functor T , since linear functors preserve direct sums. But the cokernel of this map is clearly $T(a'_2)$, which is in the image of T . \square

Corollary 5.3. *Assume the hypotheses of Theorem 5.1. If $A \in \mathcal{M}$ is a connected (i.e., $\dim \mathcal{C}(1, A) = 1$) semisimple Frobenius algebra, then $\mathrm{Tr}_{\mathcal{C}}(A)$ is as well.*

Proof. Using that $\Phi(1_{\mathcal{C}}) = 1_{\mathcal{M}}$, it is easy to check that $\mathrm{Tr}_{\mathcal{C}}(A)$ is connected. It is semisimple by Theorem 5.1. Define the counit by

$$\epsilon_{\mathrm{Tr}_{\mathcal{C}}(A)} := \epsilon \circ \mathrm{Tr}_{\mathcal{C}}(\epsilon_A) : \mathrm{Tr}_{\mathcal{C}}(A) \rightarrow 1_{\mathcal{C}},$$

where $\epsilon : \mathrm{Tr}_{\mathcal{C}}(1_{\mathcal{M}}) \rightarrow 1_{\mathcal{C}}$ is the left inverse of i . The pairing $p_{\mathrm{Tr}_{\mathcal{C}}(A)} := \epsilon_{\mathrm{Tr}_{\mathcal{C}}(A)} \circ m_{\mathrm{Tr}_{\mathcal{C}}(A)}$ is nondegenerate by [Ost03, Prop. 3.1.ii], and so $\mathrm{Tr}_{\mathcal{C}}(A)$ has a natural Frobenius algebra structure by Proposition 2.9. \square

Remark 5.4. More generally, we would like to construct a comultiplication

$$\Delta_{x,y} = \begin{array}{c} \text{Y-shaped diagram with two red lines on the left and two blue lines on the right, meeting at a bottom point labeled } x \text{ and } y. \end{array} : \mathrm{Tr}_{\mathcal{C}}(x \otimes y) \rightarrow \mathrm{Tr}_{\mathcal{C}}(x) \otimes \mathrm{Tr}_{\mathcal{C}}(y)$$

We now prove our main theorem, about the semisimplicity of $\mathrm{Tr}_{\mathcal{C}}(A \otimes B)$. Recall that for an algebra object in a semisimple category, separability is a somewhat stronger condition than semisimplicity — see Section 2.4 for a discussion.

Theorem 5.6. *Let \mathcal{C} and \mathcal{M} be as in Proposition 5.5, and let us assume that they are both semisimple. Let $A, B \in \mathcal{M}$ be algebra objects such that the category $\mathrm{Bimod}_{\mathcal{M}}(A, B)$ of A - B -bimodules is semisimple. Then $\mathrm{Tr}_{\mathcal{C}}(A \otimes B)$ is semisimple.*

In particular, if A and B are separable algebras (see Proposition 2.5), then $\mathrm{Tr}_{\mathcal{C}}(A \otimes B)$ is semisimple.

Proof. The proof follows the same outline as that of Theorem 5.1. Let \mathcal{N}_0 be the essential image of the functor $\mathcal{C} \rightarrow \mathrm{Bimod}_{\mathcal{M}}(A, B)$ given by $c \mapsto A \otimes \Phi(c) \otimes B$, and let \mathcal{N} be the idempotent completion of \mathcal{N}_0 . Since $\mathrm{Bimod}_{\mathcal{M}}(A, B)$ is semisimple, \mathcal{N} is the full subcategory of $\mathrm{Bimod}_{\mathcal{M}}(A, B)$ generated by the simple objects that occur as direct summands of $A \otimes \Phi(c) \otimes B$ for $c \in \mathcal{C}$. The categorified trace induces a functor

$$\mathrm{Tr}_{\mathcal{C}}^{\mathrm{Bimod}(A,B)} : \mathrm{Bimod}_{\mathcal{M}}(A, B) \rightarrow \mathrm{Mod}_{\mathcal{C}}(\mathrm{Tr}_{\mathcal{C}}(A \otimes B)),$$

where the $\mathrm{Tr}_{\mathcal{C}}(A \otimes B)$ -module structure on $\mathrm{Tr}_{\mathcal{C}}(z)$ for $z \in \mathrm{Bimod}_{\mathcal{M}}(A, B)$ is given by

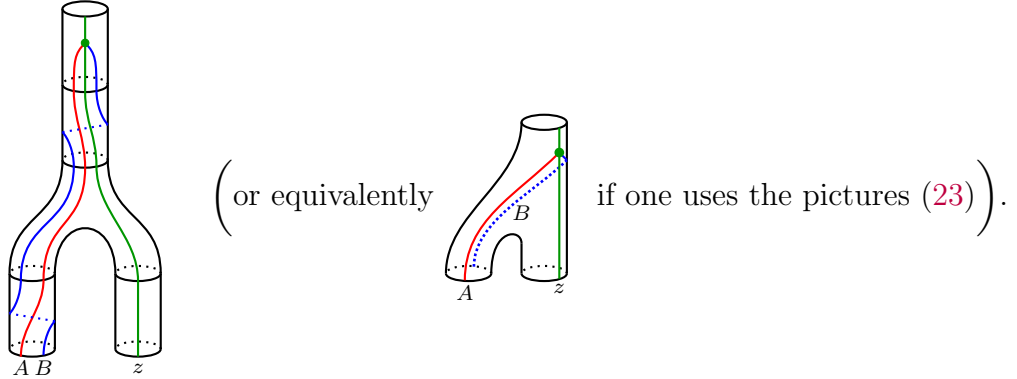

We will show that the composite

$$\mathcal{N} \hookrightarrow \mathrm{Bimod}_{\mathcal{M}}(A, B) \xrightarrow{\mathrm{Tr}_{\mathcal{C}}^{\mathrm{Bimod}(A,B)}} \mathrm{Mod}_{\mathcal{C}}(\mathrm{Tr}_{\mathcal{C}}(A \otimes B))$$

is an equivalence of categories. As \mathcal{N} is semisimple, this will complete the proof.

• *The functor $\mathrm{Tr}_{\mathcal{C}}^{\mathrm{Bimod}(A,B)}|_{\mathcal{N}}$ is fully faithful.* It is enough to show that the restriction to \mathcal{N}_0 is fully faithful, so we must show that the map

$$\mathcal{N}_0(A \otimes \Phi(c) \otimes B, A \otimes \Phi(d) \otimes B) \rightarrow \mathcal{C}_{\mathrm{Tr}_{\mathcal{C}}(A \otimes B)}(\mathrm{Tr}_{\mathcal{C}}(A \otimes \Phi(c) \otimes B), \mathrm{Tr}_{\mathcal{C}}(A \otimes \Phi(d) \otimes B))$$

is an isomorphism. The inverse of (24) is given by

One can check the equation (25)◦(24)= id directly as in the proof of Theorem 5.1. On the other hand, the equation (24)◦(25)= id is best checked after precomposition by the isomorphism

$$: \mathrm{Tr}_{\mathcal{C}}(A \otimes B) \otimes c \rightarrow \mathrm{Tr}_{\mathcal{C}}(A \otimes \Phi(c) \otimes B). \quad (26)$$

Overall, the argument is very similar to the one used in the proof of Theorem 5.1.

• *The functor $\mathrm{Tr}_{\mathcal{C}}^{\mathrm{Bimod}(A,B)}|_{\mathcal{N}}$ is essentially surjective.* Once again, the argument is completely parallel to the one in Theorem 5.1. Every $\mathrm{Tr}_{\mathcal{C}}(A \otimes B)$ -module c fits in a coequalizer diagram

$$\mathrm{Tr}_{\mathcal{C}}(A \otimes B) \otimes \mathrm{Tr}_{\mathcal{C}}(A \otimes B) \otimes c \rightrightarrows \mathrm{Tr}_{\mathcal{C}}(A \otimes B) \otimes c \rightarrow c.$$

Using the isomorphism (26), we see that $\mathrm{Tr}_{\mathcal{C}}(A \otimes B) \otimes \mathrm{Tr}_{\mathcal{C}}(A \otimes B) \otimes c$ and $\mathrm{Tr}_{\mathcal{C}}(A \otimes B) \otimes c$ are in the essential image of \mathcal{N} . We are finished by Lemma 5.2. \square

Remark 5.7. At this time, we do not know whether the algebra $\mathrm{Tr}(A \otimes B)$ is separable under the hypotheses of Theorem 5.6. The issues are similar to the ones encountered in Remark 5.4.

Remark 5.8. The proofs of 5.5 and 5.6 go through if we only assume \mathcal{C} and \mathcal{M} to be rigid, as opposed to pivotal. When we encounter a traciator (as for example in the definition of $m_{\mathrm{Tr}_{\mathcal{C}}(A \otimes B)}$, or in that of the $\mathrm{Tr}_{\mathcal{C}}(A \otimes B)$ -algebra structure on $\mathrm{Tr}_{\mathcal{C}}(z)$ for $z \in \mathrm{Bimod}_{\mathcal{M}}(A, B)$, or in the isomorphism (26)) we need to insert a double dual at the appropriate place, as explained in Remark 4.15. It so happens that every such double duals gets undone by an inverse traciator later on.

Combining Theorem 5.6 with Remarks 2.7 and 5.8, we get the following

Corollary 5.9. *Let \mathcal{C} and \mathcal{M} be fusion categories over a field of characteristic zero, and let $\Phi^z : \mathcal{C} \rightarrow \mathcal{Z}(\mathcal{M})$ be a tensor functor. If $A, B \in \mathcal{M}$ are semisimple algebras, then so is $\mathrm{Tr}_{\mathcal{C}}(A \otimes B)$.*

Example 5.10. Let $\mathcal{C} := \mathrm{SU}(2)_{16}$, with simple objects $\mathbf{1}, \dots, \mathbf{17}$. As explained in [Ost03] this tensor category has three indecomposable module categories, denoted A_{17} , D_{10} , and E_7 .

The structure morphisms can be drawn as in (23), with the A -strand on the front, the B -strand on the back, and the ‘protecting’ z -strands on the sides:

$$m_{\mathrm{Tr}_{\mathcal{C}}(z \otimes A \otimes z^* \otimes B)} = \begin{array}{c} \text{---} \\ \diagup \quad \diagdown \\ \text{---} \end{array} \quad \text{and} \quad i_{\mathrm{Tr}_{\mathcal{C}}(z \otimes A \otimes z^* \otimes B)} = \begin{array}{c} \text{---} \\ | \\ \text{---} \end{array}$$

The reader may wonder whether the two algebras $\mathrm{Tr}_{\mathcal{C}}(A \otimes B)$ and $\mathrm{Tr}_{\mathcal{C}}(B \otimes A)$ are related. We show that they are, under the assumption that \mathcal{C} is braided pivotal and $\Phi^z : \mathcal{C} \rightarrow \mathcal{Z}(\mathcal{M})$ is a braided pivotal functor. Let us define the *opposite algebra* of $A = (A, m, i)$ to be the algebra $A^{\mathrm{op}} := (A, m \circ \beta, i)$.

Proposition 5.12. *The traciator $\tau_{B,A} : \mathrm{Tr}_{\mathcal{C}}(B \otimes A) \rightarrow \mathrm{Tr}_{\mathcal{C}}(A \otimes B)$ induces an algebra isomorphism $\mathrm{Tr}_{\mathcal{C}}(B \otimes A) \cong \mathrm{Tr}_{\mathcal{C}}(A \otimes B)^{\mathrm{op}}$.*

Proof. We need to show that $m_{\mathrm{Tr}_{\mathcal{C}}(B \otimes A)} = \tau^- \circ m_{\mathrm{Tr}_{\mathcal{C}}(A \otimes B)} \circ \beta \circ (\tau^+ \otimes \tau^+)$. We rewrite $m_{\mathrm{Tr}_{\mathcal{C}}(A \otimes B)}$ as follows

$$m_{\mathrm{Tr}_{\mathcal{C}}(A \otimes B)} = \begin{array}{c} \text{---} \\ \diagup \quad \diagdown \\ \text{---} \end{array} = \begin{array}{c} \text{---} \\ | \\ \text{---} \end{array} = \begin{array}{c} \text{---} \\ \diagdown \quad \diagup \\ \text{---} \end{array}$$

and compute:

$$\tau_{A,B}^- \circ m_{\mathrm{Tr}_{\mathcal{C}}(A \otimes B)} \circ \beta \circ (\tau_{B,A}^+ \otimes \tau_{B,A}^+) = \begin{array}{c} \text{---} \\ | \\ \text{---} \end{array} = \begin{array}{c} \text{---} \\ \diagup \quad \diagdown \\ \text{---} \end{array} = m_{\mathrm{Tr}_{\mathcal{C}}(B \otimes A)}.$$

The remaining statement $i_{\mathrm{Tr}_C(B \otimes A)} = \tau^- \circ i_{\mathrm{Tr}_C(A \otimes B)}$ is straightforward, and left to the reader. \square

Remark 5.13. Unless \mathcal{C} is symmetric, there are actually two opposite algebras: $(A, m \circ \beta^+, i)$ and $(A, m \circ \beta^-, i)$, the (+)-opposite and the (-)-opposite algebras. However, if \mathcal{C} is balanced then the twist map $\theta_A : A \rightarrow A$ provides an isomorphism between (-)-opposite and the (+)-opposite algebras, so that there is, in fact, only one opposite algebra.

A Appendix

A.1 Commutative algebras in braided tensor categories

In this appendix, we expand on and fill in the details of Example 3.10.

To begin with, we introduce a convenient graphical notation for tensor products over algebra objects. Let a be an algebra object in a tensor category \mathcal{C} , and let $x, y \in \mathcal{C}$ be right and left a -modules. Denoting a by an orange strand and x, y by green and blue strands, the tensor product over a is the coequalizer $x \otimes_a y$ of the two morphisms

$$\left| \begin{array}{c} | \\ | \\ | \end{array} \right|, \left| \begin{array}{c} | \\ | \\ | \end{array} \right| : x \otimes a \otimes y \rightarrow x \otimes y.$$

(we assume that \mathcal{C} has all the necessary colimits). It is convenient to denote $x \otimes_a y$ by an orange ribbon bordered by green and blue edges:

$$\left| \begin{array}{c} | \\ | \\ | \end{array} \right| \\ x \otimes_a y$$

We draw the natural projection $\pi_{x,y} = \left| \begin{array}{c} | \\ | \\ | \end{array} \right| : x \otimes y \rightarrow x \otimes_a y$. It makes the equation

$$\left| \begin{array}{c} | \\ | \\ | \end{array} \right| = \left| \begin{array}{c} | \\ | \\ | \end{array} \right|$$

graphically motivated as the orange strand (which we might as well have represented by an orange ribbon) is allowed to slide along the orange edge of the surface. As in usual algebra, there are canonical isomorphisms $x \otimes_a a \cong x$ and $a \otimes_a y \cong y$.

When \mathcal{C} is a braided tensor category and $a \in \mathcal{C}$ is a commutative algebra object

$$\left| \begin{array}{c} | \\ | \\ | \end{array} \right| = \left| \begin{array}{c} | \\ | \\ | \end{array} \right| \quad (\text{Commutativity})$$

then it makes sense to tensor two left a -modules, and the result is again an a -module. Specifically, if x, y are left a -modules, then $x \otimes_a y$ is the coequalizer of the two morphisms

$$\left| \begin{array}{c} | \\ | \\ | \end{array} \right|, \left| \begin{array}{c} | \\ | \\ | \end{array} \right| : x \otimes a \otimes y \rightarrow x \otimes y$$

Instead of using a ribbon as above, it is preferable in this situation to represent $x \otimes_a y$ by a thick filled orange ‘rope’ with green and blue strands on its surface:

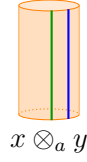

Extrapolating the notation, we can also denote a single a -module x by , where the presence of the orange rope is just an indication that x is an a -module.

Let us now assume that a is commutative and separable, also known as étale [DMNO13, §3] (such an algebra is automatically Frobenius – combine [DMNO13, Rem. 3.2.ii], [Ost03, Prop. 3.1.ii], and Proposition 2.9 for a proof). The dual of an a -module x is then naturally also an a -module. The evaluation $\text{ev}_x : x^* \otimes x \rightarrow 1$ induces a corresponding evaluation morphism $\bar{\text{ev}}_x : x^* \otimes_a x \rightarrow a$ in the category of a -modules, and the same holds for coevaluations [DMNO13, §3.3]. We write

$$\mathcal{M} := \text{Mod}_{\mathcal{C}}(a)$$

for the category of a -modules in \mathcal{C} . This is a rigid tensor category under the operation $x, y \mapsto x \otimes_a y$.

Let $\Phi : \mathcal{C} \rightarrow \mathcal{M}$ be the free module functor, given by $\Phi(x) := a \otimes x$ on objects and $\Phi(f : x \rightarrow y) = \text{id}_a \otimes f : a \otimes x \rightarrow a \otimes y$ on morphisms. We then have a functor $\Phi^{\mathcal{Z}} : \mathcal{C} \rightarrow \mathcal{Z}(\mathcal{M})$ given by $\Phi^{\mathcal{Z}}(x) := (\Phi(x), e_{\Phi(x)})$, where the half-braiding $e_{\Phi(x)}$ is given by

$$e_{\Phi(x), y} : \Phi(x) \otimes_a y \cong x \otimes y \xrightarrow{\beta_{x, y}} y \otimes x \cong y \otimes_a \Phi(x).$$

In diagrams, this is denoted

$$e_{\Phi(x), y} = \text{[Diagram of a rope with a blue strand on the surface and a green strand inside, crossing each other]} \quad (27)$$

The blue strand represents $y \in \mathcal{M}$, and lies on the surface of the rope. The green strand represents $x \in \mathcal{C}$, and doesn’t touch the surface. The above map is visibly invertible, and natural in y . The hexagon axiom (2) for the half-braiding is the equation

$$\text{[Diagram showing the hexagon axiom for the half-braiding: two ropes with three strands (blue, green, red) are shown to be equal after a strand swap]} \quad (28)$$

It holds as both sides of (28) fit into the same commutative diagram

$$\begin{array}{ccc} y \otimes z \otimes x & \xrightarrow{\pi_{yz} \otimes 1} & y \otimes_a z \otimes x \cong y \otimes_a z \otimes_a \Phi(x) \\ \uparrow (1 \otimes \beta_{x, z})(\beta_{x, y} \otimes 1) = \beta_{x, y \otimes z} & & \uparrow (28) \\ x \otimes y \otimes z & \xrightarrow{1 \otimes \pi_{yz}} & x \otimes y \otimes_a z \cong \Phi(x) \otimes_a y \otimes_a z \end{array}$$

with surjective horizontal maps. The isomorphism $(a \otimes x) \otimes_a (a \otimes y) \cong a \otimes x \otimes y$ endows Φ^z with the structure of a tensor functor. Indeed, the half braidings $e_{\Phi(x) \otimes_a \Phi(y)} = (e_{\Phi(x)} \otimes_a 1) \circ (1 \otimes_a e_{\Phi(y)})$ and $e_{\Phi(x \otimes y)}$ are naturally isomorphic, as required for Φ^z to be a tensor functor:

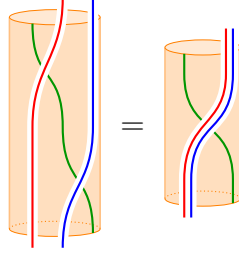

Finally, the functor Φ^z is braided because the morphism  is both the image of $\beta_{x,y}$ under Φ^z , and a special case of (27).

Let us now furthermore assume that \mathcal{C} is pivotal, and that $\theta_a = 1$, where the twist maps are given by (3). Then for any a -module x , the pivotal map $\varphi_x : x \rightarrow x^{**}$ is a map of a -modules [KO02, Thm. 1.17]¹². This equips the category $\text{Mod}_{\mathcal{C}}(a)$ of a -modules with the structure of a pivotal tensor category.

We wish to check that $\Phi^z : \mathcal{C} \rightarrow \mathcal{Z}(\mathcal{M})$ is a pivotal functor, i.e., that the equation $\delta_x^* \circ \varphi_{\Phi^z(x)} = \delta_{x^*} \circ \Phi^z(\varphi_x)$ holds. Let $\omega : a \rightarrow a^*$ be the isomorphism induced by the Frobenius pairing $\epsilon \circ \mu : a \otimes a \rightarrow 1$. The canonical isomorphism $\delta_x : \Phi^z(x^*) \rightarrow \Phi^z(x)^*$ is then given by

$$\Phi(x^*) = a \otimes x^* \xrightarrow{\beta_{a,x^*}^-} x^* \otimes a \xrightarrow{1 \otimes \omega} x^* \otimes a^* \cong (a \otimes x)^* = \Phi(x)^*.$$

We need to check that

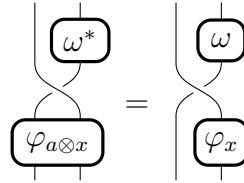

holds. By the monoidal property of φ , this is equivalent to the equation $\varphi_a = (\omega^*)^{-1} \circ \omega$, which is itself a consequence of $\theta_a = 1$ [KO02, Lem. 1.13]. This finishes the proof that Φ^z is a pivotal functor.

A.2 Braided pivotal categories

In this second appendix, we provide an overview of some basic properties of braided pivotal categories, since these have not received as much attention as many related notions. Some of these results can be found in the literature [Sel11, §4.6 and 4.7] [Yet92, Prop. 2.11] (see also [BK01, §2.2] and [DGNO10, §2.8.2]). We provide them here along with short proofs for the convenience of the reader.

Lemma A.1. *Let \mathcal{C} be balanced rigid category. Then there are two ways of identifying each object with its double dual, each one making \mathcal{C} into a pivotal category.*

¹²To match our conventions, one should replace all over-crossings by under-crossings in [KO02].

Proof. For $a \in \mathcal{C}$, define $\varphi_a^{(1)} : a \rightarrow a^{**}$ by

$$\varphi_a^{(1)} = (\text{ev}_a \otimes \text{id}_{a^{**}}) \circ (\text{id}_{a^*} \otimes \beta_{a^{**},a}^-) \circ (\text{coev}_{a^*} \otimes \text{id}_a) \circ \theta_a = \begin{array}{c} a^{**} \\ | \\ \text{---} \\ | \\ \boxed{\theta_a} \\ | \\ a \end{array}. \quad (29)$$

This is clearly invertible with inverse $\theta_a^{-1} \circ (\text{id}_a \otimes \text{ev}_{a^*}) \circ (\beta_{a^{**},a} \otimes \text{id}_{a^*}) \circ (\text{id}_{a^{**}} \otimes \text{coev}_a)$. The naturality of $\varphi_a^{(1)}$ is left as an exercise, and it is straightforward to show $\varphi_{a \otimes b}^{(1)} = \varphi_a^{(1)} \otimes \varphi_b^{(1)}$ using that $\theta_{a \otimes b} = \beta_{b,a} \circ \beta_{a,b} \circ (\theta_a \otimes \theta_b)$.

The other pivotal structure is given by

$$\varphi_a^{(2)} = (\text{ev}_a \otimes \text{id}_{a^{**}}) \circ (\text{id}_{a^*} \otimes \beta_{a^{**},a}^+) \circ (\text{coev}_{a^*} \otimes \text{id}_a) \circ \theta_a^{-1} = \begin{array}{c} a^{**} \\ | \\ \text{---} \\ | \\ \boxed{\theta_a^{-1}} \\ | \\ a \end{array}. \quad \square$$

The two pivotal structures are related by

$$\varphi_a^{(2)} = \begin{array}{c} a^{**} \\ | \\ \text{---} \\ | \\ \boxed{(\varphi_a^{(1)})^{-1}} \\ | \\ a^{**} \\ | \\ \text{---} \\ | \\ a \end{array} = \begin{array}{c} a^{**} \\ | \\ \text{---} \\ | \\ \boxed{(\varphi_a^{(1)})^{-1}} \\ | \\ a^{**} \\ | \\ \text{---} \\ | \\ a \end{array} \quad \text{and} \quad \varphi_a^{(1)} = \begin{array}{c} a^{**} \\ | \\ \text{---} \\ | \\ \boxed{(\varphi_a^{(2)})^{-1}} \\ | \\ a^{**} \\ | \\ \text{---} \\ | \\ a \end{array} = \begin{array}{c} a^{**} \\ | \\ \text{---} \\ | \\ \boxed{(\varphi_a^{(2)})^{-1}} \\ | \\ a^{**} \\ | \\ \text{---} \\ | \\ a \end{array}. \quad (30)$$

Lemma A.2. *A braided pivotal category has two sets of twists, each one making it a balanced category.*

Proof. For $a \in \mathcal{C}$, let $\varphi_a : a \rightarrow a^{**}$ be the natural isomorphism, and define

$$\theta_a^{(1)} = (\text{id}_a \otimes \text{ev}_{a^*}) \circ (\beta_{a^{**},a} \otimes \text{id}_{a^*}) \circ (\text{id}_{a^{**}} \otimes \text{coev}_a) \circ \varphi_a = \begin{array}{c} a \\ | \\ \text{---} \\ | \\ \boxed{\varphi_a} \\ | \\ a^{**} \\ | \\ \text{---} \\ | \\ a \end{array}. \quad (31)$$

The other alternative is

$$\theta_a^{(2)} = \varphi_a^{-1} \circ (\text{ev}_a \otimes \text{id}_{a^{**}}) \circ (\text{id}_{a^*} \otimes \beta_{a^{**},a}) \circ (\text{coev}_{a^*} \otimes \text{id}_a) = \begin{array}{c} a \\ | \\ \text{---} \\ | \\ \boxed{\varphi_a^{-1}} \\ | \\ a^{**} \\ | \\ \text{---} \\ | \\ a \end{array}. \quad (32)$$

The naturality of $\theta^{(1)}$ and $\theta^{(2)}$ follows from that of φ . Using the monoidal property of φ , respectively φ^{-1} , one verifies that the balance axiom holds between these twist maps and the braiding. \square

The two twists are related by

$$\theta_a^{(2)} = \left[\theta_{a^*}^{(1)} \right] = \left[\theta_{*a}^{(1)} \right] \quad \text{and} \quad \theta_a^{(1)} = \left[\theta_{a^*}^{(2)} \right] = \left[\theta_{*a}^{(2)} \right]. \quad (33)$$

Lemmas A.1 and A.2 now combine to give the following corollary:

Corollary A.3. *Let \mathcal{C} be a braided rigid category. Then there are two ways¹³ of establishing a one-to-one correspondence between pivotal structures on \mathcal{C} , and twists making \mathcal{C} into a balanced category (see Figure 2 in Section 2.3).*

Proposition A.4. *Let $(\mathcal{C}, \beta, \varphi^{(1)})$ be a braided pivotal category. Using $\varphi^{(1)}$, let us define $\varphi^{(2)}, \theta^{(1)}, \theta^{(2)}$ by means of Equations (30), (31), (32), respectively. Then the following three properties are equivalent*

- (1) $\theta^{(1)} = \theta^{(2)}$
- (2) $(\mathcal{C}, \beta, \theta^{(i)})$ is ribbon for either $i = 1, 2$
- (3) $\varphi^{(1)} = \varphi^{(2)}$

and imply this fourth one:

- (4) $(\mathcal{C}, \beta, \varphi^{(i)})$ is spherical for either $i = 1, 2$.

If moreover \mathcal{C} is semisimple, then the fourth property is equivalent to the first three.

Proof.

(1) \Leftrightarrow (2): By definition, $(\mathcal{C}, \beta, \theta^{(1)})$ is ribbon if and only if $(\theta_a^{(1)})^* = \theta_{a^*}^{(1)}$ holds for every $a \in \mathcal{C}$. By Equation (33), we have $(\theta_a^{(1)})^* = \theta_{a^*}^{(2)}$. Therefore $(\mathcal{C}, \beta, \theta^{(1)})$ is ribbon iff $\theta_{a^*}^{(1)} = \theta_{a^*}^{(2)}$ holds $\forall a$ iff $\theta_a^{(1)} = \theta_a^{(2)}$ holds $\forall a$. The same argument works with $(\mathcal{C}, \beta, \theta^{(2)})$ in place of $(\mathcal{C}, \beta, \theta^{(1)})$.

(2) \Leftrightarrow (3): Letting $\theta := \theta^{(1)}$, then for every $a \in \mathcal{C}$, we have

$$\left[\theta_{a^*}^* \right] = \left[\theta_a \right] = \left[\theta_a \right] = \left[\varphi_a^{(1)} \right]$$

and

$$\left[\theta_{a^*} \right] = \left[\theta_{a^*} \right] = \left[(\varphi_{a^*}^{(2)})^{-1} \right] = \left[\varphi_a^{(2)} \right].$$

¹³In [Sel11, Rem. 4.22], it is incorrectly stated that there are \mathbb{Z} many ways of establishing such a correspondence. In fact, the construction only produces $\mathbb{Z}/2\mathbb{Z}$ many distinct correspondences.

It follows that $(\theta_a^{(1)})^* = \theta_{a^*}^{(1)}$ holds if and only if $\varphi_a^{(1)} = \varphi_a^{(2)}$ holds. Using Equations (33), the former is also easily seen to be equivalent to $(\theta_a^{(2)})^* = \theta_{a^*}^{(2)}$.

(3) \Rightarrow (4): Assuming $\varphi := \varphi^{(1)} = \varphi^{(2)}$, we show that $(\mathcal{C}, \beta, \varphi)$ is spherical:

$$\mathrm{tr}_R(f) = \left(\begin{array}{c} \varphi \\ f \end{array} \right) = \left(\begin{array}{cc} f & \varphi^{-1} \end{array} \right) = \left(\begin{array}{cc} f & \varphi \end{array} \right) = \left(\begin{array}{cc} \varphi & f \end{array} \right) = \left(\begin{array}{c} f \\ \varphi^{-1} \end{array} \right) = \mathrm{tr}_L(f).$$

We have used Equation (30) for the third equality above.

Let now \mathcal{C} be semisimple.

(4) \Rightarrow (2): We again write $\varphi := \varphi^{(1)}$, and assume that $(\mathcal{C}, \beta, \varphi)$ is spherical. By naturality of the twist, it is enough to verify $\theta_a^* = \theta_{a^*}$ on simple objects. Let ϑ_a^* and ϑ_{a^*} be the scalars defined by $\theta_a^* = \vartheta_a^* \mathrm{id}_{a^*}$ and $\theta_{a^*} = \vartheta_{a^*} \mathrm{id}_{a^*}$. By Lemma A.5, the quantum dimension $\dim(a) := \mathrm{tr}_L(1_a)$ of a simple object is always non-zero. So we have $\theta_a^* = \theta_{a^*}$ if and only if $\mathrm{tr}_L(\theta_a^*) = \dim(a^*)\vartheta_a^*$ equals $\mathrm{tr}_L(\theta_{a^*}) = \dim(a^*)\vartheta_{a^*}$:

$$\mathrm{tr}_L(\theta_a^*) = \left(\begin{array}{c} \theta \\ \varphi^{-1} \end{array} \right) = \left(\begin{array}{c} \varphi \\ \theta \end{array} \right) = \left(\begin{array}{c} \varphi \\ \theta \end{array} \right) = \mathrm{tr}_R(\theta_{a^*}) = \mathrm{tr}_L(\theta_{a^*}). \quad \square$$

Lemma A.5. *Let \mathcal{C} be a rigid semisimple tensor category (linear over some field k). Then for every simple object a and non-zero morphisms $c : 1 \rightarrow a \otimes a^*$ and $e : a \otimes a^* \rightarrow 1$, we have $e \circ c \neq 0$.*

Proof. By the adjunction $\mathcal{C}(1, a \otimes a^*) \cong \mathcal{C}(a, a) \cong k$, any morphism $1 \rightarrow a \otimes a^*$ is a multiple of c . Decompose $a \otimes a^*$ as $u \oplus x$ with u the image of c , and decompose 1 as $1' \oplus 1''$ with $1'$ the coimage of c . We have $\mathcal{C}(1', x) = \mathcal{C}(1'', x) = \mathcal{C}(1'', u) = 0$, $\mathcal{C}(1', u) = k$, and c restricts to an isomorphism $1' \rightarrow u$.

By semisimplicity, we also have $\mathcal{C}(x, 1') = \mathcal{C}(x, 1'') = \mathcal{C}(u, 1'') = 0$, $\mathcal{C}(u, 1') = k$, and e restricts to an isomorphism $u \rightarrow 1'$. The composite $e \circ c$ is now visibly non-zero. \square

In Lemma A.2, we have discussed the two ways of equipping a braided pivotal category with a balanced structure. We provide the corresponding result at the level of functors:

Lemma A.6. *Let \mathcal{C}, \mathcal{D} be braided pivotal categories, equipped with the balanced structure (31). Then a braided pivotal functor $F : \mathcal{C} \rightarrow \mathcal{D}$ is automatically balanced. The same result holds using the other balanced structure (32).*

Proof. Recall from Section 2.1 that the isomorphism $\delta_a : F(a^*) \rightarrow F(a)^*$ is defined by requiring that

$$F(\mathrm{ev}_a) = i \circ \mathrm{ev}_{F(a)} \circ (\delta_a \otimes \mathrm{id}_{F(a)}) \circ \nu_{a^*, a}^{-1}.$$

It follows that $\text{ev}_{F(a)} = i^{-1} \circ F(\text{ev}_a) \circ \nu_{a^*,a} \circ (\delta_a^{-1} \otimes \text{id}_{F(a)})$. The map $\text{coev}_{F(a)}$ is characterised by the zig-zag equation $(\text{id} \otimes \text{ev}_{F(a)}) \circ (\text{coev}_{F(a)} \otimes \text{id}) = \text{id}_{F(a)}$. As the morphism $(\text{id}_{F(a)} \otimes \delta_a) \circ \nu_{a,a^*}^{-1} \circ F(\text{coev}_a) \circ i$ satisfies that equation, it must be equal to $\text{coev}_{F(a)}$. So we get that

$$F(\text{coev}_a) = \nu_{a,a^*} \circ (\text{id}_{F(a)} \otimes \delta_a^{-1}) \circ \text{coev}_{F(a)} \circ i^{-1}.$$

We can now prove that $F : (\mathcal{C}, \theta^{(1)}) \rightarrow (\mathcal{D}, \theta^{(1)})$ is a balanced functor:

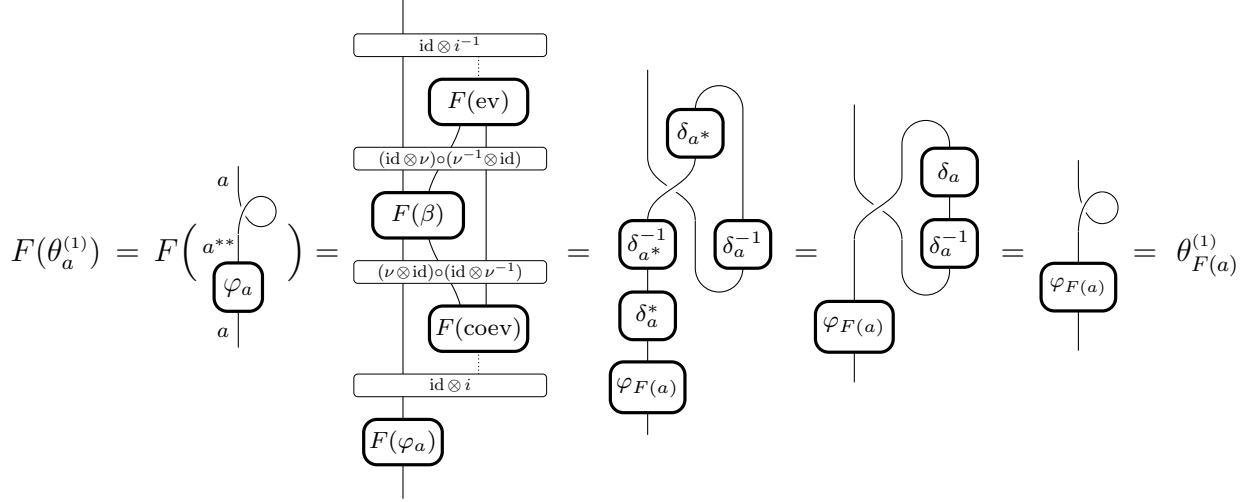

The proof that $F : (\mathcal{C}, \theta^{(2)}) \rightarrow (\mathcal{D}, \theta^{(2)})$ is a balanced functor is similar. □

References

- [BD95] John C. Baez and James Dolan, *Higher-dimensional algebra and topological quantum field theory*, J. Math. Phys. **36** (1995), no. 11, 6073–6105, [MR1355899](#) [arXiv:q-alg/9503002](#) [DOI:10.1063/1.531236](#).
- [Bez04] Roman Bezrukavnikov, *On tensor categories attached to cells in affine Weyl groups*, Representation theory of algebraic groups and quantum groups, Adv. Stud. Pure Math., vol. 40, Math. Soc. Japan, Tokyo, 2004, [MR2074589](#), pp. 69–90.
- [BFO09] Roman Bezrukavnikov, Michael Finkelberg, and Victor Ostrik, *On tensor categories attached to cells in affine Weyl groups. III*, Israel J. Math. **170** (2009), 207–234, [MR2506324](#) [DOI:10.1007/s11856-009-0026-9](#) [arXiv:math/0605628](#).
- [Big10] Stephen Bigelow, *Skein theory for the ADE planar algebras*, J. Pure Appl. Algebra **214** (2010), no. 5, 658–666, [arXiv:math.QA/0903.0144](#) [MR2577673](#) [DOI:10.1016/j.jpaa.2009.07.010](#).
- [BK01] Bojko Bakalov and Alexander Kirillov, Jr., *Lectures on tensor categories and modular functors*, University Lecture Series, vol. 21, American Mathematical Society, Providence, RI, 2001, [MR1797619](#).
- [BN11] Alain Bruguières and Sonia Natale, *Exact sequences of tensor categories*, Int. Math. Res. Not. IMRN (2011), no. 24, 5644–5705, [MR2863377](#) [DOI:10.1093/imrn/rnq294](#) [arXiv:1006.0569](#).
- [DGNO10] Vladimir Drinfeld, Shlomo Gelaki, Dmitri Nikshych, and Victor Ostrik, *On braided fusion categories. I*, Selecta Math. (N.S.) **16** (2010), no. 1, 1–119, [MR2609644](#) [DOI:10.1007/s00029-010-0017-z](#) [arXiv:0906.0620](#).

- [DMNO13] Alexei Davydov, Michael Müger, Dmitri Nikshych, and Victor Ostrik, *The Witt group of non-degenerate braided fusion categories*, J. Reine Angew. Math. **677** (2013), 135–177, [MR3039775](#) [arXiv:1009.2117](#).
- [DSPS14] Chris Douglas, Chris Schommer-Pries, and Noah Snyder, *The balanced tensor product of module categories*, 2014, [arXiv:1406.4204](#).
- [ENO05] Pavel Etingof, Dmitri Nikshych, and Viktor Ostrik, *On fusion categories*, Ann. of Math. (2) **162** (2005), no. 2, 581–642, [MR2183279](#) [DOI:10.4007/annals.2005.162.581](#) [arXiv:math.QA/0203060](#).
- [EO04] Pavel Etingof and Viktor Ostrik, *Module categories over representations of $SL_q(2)$ and graphs*, Math. Res. Lett. **11** (2004), no. 1, 103–114, [MR2046203](#) [arXiv:math.QA/0302130](#).
- [FKST95] Jürg Fröhlich, Thomas Kerler, Urban M. Studer, and Emmanuel Thiran, *Structuring the set of incompressible quantum Hall fluids*, Nuclear Phys. B **453** (1995), no. 3, 670–704, [MR1358783](#) [DOI:10.1016/0550-3213\(95\)00426-S](#) [arXiv:cond-mat/9505156](#).
- [FRS02] Jürgen Fuchs, Ingo Runkel, and Christoph Schweigert, *TFT construction of RCFT correlators. I. Partition functions*, Nuclear Phys. B **646** (2002), no. 3, 353–497, [MR1940282](#) [DOI:10.1016/S0550-3213\(02\)00744-7](#) [arXiv:hep-th/0204148](#).
- [FS08] Jürgen Fuchs and Carl Stigner, *On Frobenius algebras in rigid monoidal categories*, Arab. J. Sci. Eng. Sect. C Theme Issues **33** (2008), no. 2, 175–191, [MR2500035](#) [arXiv:0901.4886](#).
- [FY92] Peter Freyd and David N. Yetter, *Coherence theorems via knot theory*, J. Pure Appl. Algebra **78** (1992), no. 1, 49–76, [MR1154897](#) [DOI:10.1016/0022-4049\(92\)90018-B](#).
- [HPT15] André Henriques, David Penneys, and James E. Tener, *Planar algebras in braided tensor categories*, 2015, In preparation.
- [JS91a] André Joyal and Ross Street, *The geometry of tensor calculus. I*, Adv. Math. **88** (1991), no. 1, 55–112, [MR1113284](#).
- [JS91b] ———, *Tortile Yang-Baxter operators in tensor categories*, J. Pure Appl. Algebra **71** (1991), no. 1, 43–51, [MR1107651](#) [DOI:10.1016/0022-4049\(91\)90039-5](#).
- [Kac90] Victor G. Kac, *Infinite-dimensional Lie algebras*, third ed., Cambridge University Press, Cambridge, 1990, [MR1104219](#) [DOI:10.1017/CB09780511626234](#).
- [Kel74] G. M. Kelly, *Doctrinal adjunction*, Category Seminar (Proc. Sem., Sydney, 1972/1973), Springer, Berlin, 1974, [MR0360749](#), pp. 257–280. Lecture Notes in Math., Vol. 420.
- [KO02] Alexander Kirillov, Jr. and Viktor Ostrik, *On a q -analogue of the McKay correspondence and the ADE classification of \mathfrak{sl}_2 conformal field theories*, Adv. Math. **171** (2002), no. 2, 183–227, [MR1936496](#) [arXiv:math.QA/0101219](#) [DOI:10.1006/aima.2002.2072](#).
- [ML98] Saunders Mac Lane, *Categories for the working mathematician*, second ed., Graduate Texts in Mathematics, vol. 5, Springer-Verlag, New York, 1998, [MR1712872](#).
- [MPS10] Scott Morrison, Emily Peters, and Noah Snyder, *Skein theory for the D_{2n} planar algebras*, J. Pure Appl. Algebra **214** (2010), no. 2, 117–139, [arXiv:0808.0764](#) [MR2559686](#) [DOI:10.1016/j.jpaa.2009.04.010](#).
- [MPS11] ———, *Knot polynomial identities and quantum group coincidences*, Quantum Topol. **2** (2011), no. 2, 101–156, [MR2783128](#) [DOI:10.4171/QT/16](#) [arXiv:1003.0022](#).
- [MPS15] Scott Morrison, Emily Peters, and Noah Snyder, *Categories generated by a trivalent vertex*, 2015, [arXiv:1501.06869](#).
- [Müg03a] Michael Müger, *From subfactors to categories and topology. I. Frobenius algebras in and Morita equivalence of tensor categories*, J. Pure Appl. Algebra **180** (2003), no. 1-2, 81–157, [MR1966524](#) [DOI:10.1016/S0022-4049\(02\)00247-5](#) [arXiv:math.CT/0111204](#).

- [Müg03b] ———, *From subfactors to categories and topology. II. The quantum double of tensor categories and subfactors*, J. Pure Appl. Algebra **180** (2003), no. 1-2, 159–219, [MR1966525](#) [DOI:10.1016/S0022-4049\(02\)00248-7](#) [arXiv:math.CT/0111205](#).
- [Ocn02] Adrian Ocneanu, *The classification of subgroups of quantum $SU(N)$* , Quantum symmetries in theoretical physics and mathematics (Bariloche, 2000), Contemp. Math., vol. 294, Amer. Math. Soc., Providence, RI, 2002, [MR1907188](#), pp. 133–159.
- [Ost03] Victor Ostrik, *Module categories, weak Hopf algebras and modular invariants*, Transform. Groups **8** (2003), no. 2, 177–206, [MR1976459](#) [arXiv:math/0111139](#).
- [Ost14] ———, *Tensor categories attached to exceptional cells in Weyl groups*, Int. Math. Res. Not. IMRN (2014), no. 16, 4521–4533, [MR3250042](#) [arXiv:1108.3060](#).
- [Par95] Bodo Pareigis, *On braiding and dyslexia*, J. Algebra **171** (1995), no. 2, 413–425, [MR1315904](#) [DOI:10.1006/jabr.1995.1019](#).
- [PS13] Kate Ponto and Michael Shulman, *Shadows and traces in bicategories*, J. Homotopy Relat. Struct. **8** (2013), no. 2, 151–200, [MR3095324](#) [DOI:10.1007/s40062-012-0017-0](#) [arXiv:0910.1306](#).
- [Saw06] Stephen F. Sawin, *Quantum groups at roots of unity and modularity*, J. Knot Theory Ramifications **15** (2006), no. 10, 1245–1277, [MR2286123](#) [arXiv:math.QA/0308281](#).
- [Sel11] P. Selinger, *A survey of graphical languages for monoidal categories*, New structures for physics, Lecture Notes in Phys., vol. 813, Springer, Heidelberg, 2011, [MR2767048](#) [DOI:10.1007/978-3-642-12821-9_4](#), pp. 289–355.
- [Shu94] Mei Chee Shum, *Tortile tensor categories*, J. Pure Appl. Algebra **93** (1994), no. 1, 57–110, [MR1268782](#).
- [Vor99] Alexander A. Voronov, *The Swiss-cheese operad*, Homotopy invariant algebraic structures (Baltimore, MD, 1998), Contemp. Math., vol. 239, Amer. Math. Soc., Providence, RI, 1999, [MR1718089](#) [arXiv:math.QA/9807037](#), pp. 365–373.
- [Yet92] David N. Yetter, *Framed tangles and a theorem of Deligne on braided deformations of Tannakian categories*, Deformation theory and quantum groups with applications to mathematical physics (Amherst, MA, 1990), Contemp. Math., vol. 134, Amer. Math. Soc., Providence, RI, 1992, [MR1187296](#) [DOI:10.1090/conm/134/1187296](#), pp. 325–349.