

RAVELS ARISING FROM MONTESINOS TANGLES

ERICA FLAPAN AND ALLISON N. MILLER

ABSTRACT. A ravel is a spatial graph which is non-planar but contains no non-trivial knots or links. We characterize when a Montesinos tangle can become a ravel as the result of vertex closure with and without replacing some number of crossings by vertices.

1. INTRODUCTION

One of the earliest results in spatial graph theory was the discovery by Suzuki [11] in 1970 of an embedding of an abstractly planar graph which had the property that it was non-planar but every subgraph of the embedding was planar. Two years later, Kinoshita [5] found an embedding of a θ_3 graph which had this property. Many results about such embeddings have since been obtained, though several different terms are used to refer to them. In particular, we have the following definition.

Definition 1.1. *An embedding G of an abstractly planar graph in \mathbb{R}^3 is said to be almost unknotted (equivalently almost trivial, minimally knotted, or Brunnian) if G is non-planar but $G - \{e\}$ is planar for any edge e of G .*

One of the most significant results in the study of almost unknotted graphs is the result obtained by Kawauchi [4] and Wu [14] that every abstractly planar graph without valence one vertices has an almost unknotted embedding.

We are now interested in a larger class of embedded graphs defined below.

Definition 1.2. *An embedding G of an abstractly planar graph in \mathbb{R}^3 is said to be a ravel if G is non-planar but contains no non-trivial knots or links.*

Any almost unknotted graph G is a ravel, unless G is topologically a non-trivial knot or a Brunnian link. However, the converse is not true. For example, starting with an almost unknotted embedding of a graph G , add an additional edge e' parallel to an existing edge e to get a new embedded graph G' . Since G was almost unknotted, G' will contain no non-trivial knots or links. However, the removal of the edge e' will not make G' planar, and hence G' is a ravel that is not almost unknotted.

The term *ravel* was originally coined as a way to describe hypothetical molecular structures whose complexity results from “an entanglement of

1991 *Mathematics Subject Classification.* 57M25, 57M15, 05C10.

Key words and phrases. Spatial graphs, almost unknotted graphs, minimally knotted graphs, Brunnian graphs, tangles, ravel, Montesinos tangles.

edges around a vertex that contains no knots or links” [1]. The first molecular ravel to be identified was a metal-ligand complex synthesized by Feng Li et al in 2011 [6]. In order to formalize the notion of entanglement about a vertex, we require the “entanglement” to be properly embedded in a ball. If we bring the endpoints of the edges in the boundary sphere together into a single vertex, we obtain a spatial graph which is known as the *vertex closure* of the entanglement. In Figure 1.1, we illustrate an entanglement whose vertex closure is a ravel.

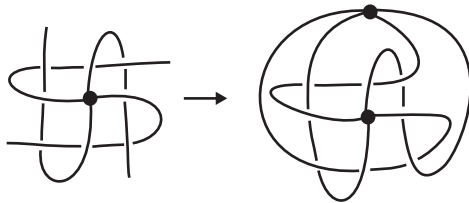

FIGURE 1.1. The entanglement on the left becomes a ravel when the endpoints are brought together on the right.

In this paper, we characterize when a Montesinos tangle can become a ravel as the result of vertex closure with and without replacing some number of crossings by vertices. In particular, our main results are the following.

Theorem 1.3. *Let $T = T_1 + \cdots + T_n$ be a Montesinos tangle such that n is minimal and not both T_1 and T_n are trivial vertical tangles. If T is rational, then $V(T)$ is planar. If T is not rational and some rational subangle T_i has ∞ -parity, then $V(T)$ contains a non-trivial knot or link. Otherwise, $V(T)$ is a ravel.*

Theorem 1.4. *Let $T = T_1 + \cdots + T_n$ be a projection of a Montesinos tangle in standard form, and let T' be obtained from T by replacing at least one crossing by a vertex. Then the vertex closure $V(T')$ is a ravel if and only if T' is an exceptional vertex insertion.*

While we postpone defining an exceptional vertex insertion until Section 4, Theorem 1.4 has the following more easily stated corollary.

Corollary 1.5. *Let $T = T_1 + \cdots + T_n$ be a projection of a Montesinos tangle in standard form, and let T' be obtained from T by replacing at least one crossing with a vertex. If the vertex closure $V(T')$ is a ravel, then precisely one T_i has ∞ -parity.*

2. BACKGROUND

For completeness we include some well-known definitions and results about knots, links, and tangles.

Definition 2.1. A 2-string tangle T in a ball B is said to be rational if there is an ambient isotopy of B setwise fixing ∂B that takes T to a trivial tangle.

Definition 2.2. The sum and product of tangles R and S are shown in Figure 2.1.



FIGURE 2.1. The sum and product of tangles R and S .

Definition 2.3. A tangle is said to be Montesinos if it can be written as the sum of finitely many rational tangles. A tangle is said to be algebraic or arborescent if it can be written in terms of sums and products of finitely many rational tangles.

Note that Montesinos tangles and algebraic tangles are not necessarily 2-string tangles since they may contain simple closed curves in addition to the two strings.

Definition 2.4. Let T be a 2-string tangle. The knot or link obtained by joining the NE and SE points together and the NW and SW points together is called the denominator closure of T , and denoted by $D(T)$. The knot or link obtained by joining the NW and NE points and the SW and SE points together is called the numerator closure of T , and denoted by $N(T)$.

Definition 2.5. A 2-string tangle is said to have ∞ -parity if the NW and SW boundary points are on the same strand, and 0-parity if the NW and NE boundary points are on the same strand.

We will use the following results repeatedly in our proofs.

Wolcott's Theorem. [13] Let T be a rational tangle. Then $D(T)$ is the unknot if and only if T is a horizontal tangle; and $D(T)$ is an unlink if and only if T is a trivial vertical tangle.

Schubert's Theorem. [9] Let L_1 and L_2 be knots or links. Then $L_1 \# L_2$ is trivial if and only if both L_1 and L_2 are trivial.

Thistlethwaite's Theorem. [12] A reduced alternating projection of a link has the minimum number of crossings.

3. VERTEX CLOSURE OF RATIONAL AND MONTESINOS TANGLES

Definition 3.1. *Let T be a 1-string or 2-string tangle (possibly with additional closed components) in a ball B . The embedded graph $V(T)$ obtained by identifying the endpoints of the arcs in T to a single vertex w in ∂B is called the vertex closure of T and w is called the closing vertex.*

We begin with the following observation about when the vertex closure of a tangle is planar.

Lemma 3.2. *Let T be a 2-string tangle with tangle ball B . Then the vertex closure $V(T)$ of T is planar if and only if T is rational.*

Proof. It follows from the definition of rational that T is rational if and only if it can be made planar by moving the endpoints of the arcs of T around in ∂B . However, moving the endpoints of the strands around in ∂B corresponds to moving the edges of $V(T)$ about the closing vertex. So T is rational if and only if $V(T)$ can be made planar by moving the edges of $V(T)$ about the vertex. \square

The following theorem characterizes when the vertex closure of a Montesinos tangle is a ravel.

Theorem 3.3. *Let $T = T_1 + \cdots + T_n$ be a Montesinos tangle such that n is minimal and not both T_1 and T_n are trivial vertical tangles. If T is rational, then $V(T)$ is planar. If T is not rational and some rational subtangle T_i has ∞ -parity, then $V(T)$ contains a non-trivial knot or link. Otherwise, $V(T)$ is a ravel.*

Proof. We know by Lemma 3.2 that if T is rational, then $V(T)$ is planar. So we assume that $n > 1$. Since n is minimal, none of the T_i is horizontal. Without loss of generality we can assume that T_n is not a trivial vertical tangle.

First suppose that at least one of the rational subtangles has ∞ -parity. Let T_i be the rightmost such tangle in the sum $T = T_1 + \cdots + T_n$. Thus both ends of the NE-SE strand of T_i can be extended to the right until they are joined together at the closing vertex w , giving us a loop L_1 (illustrated in grey on the left in Figure 3.1), though we may have $i = n$.

Suppose that $i < n$. Then the loop L_1 is a connected sum of the denominator closure $D(T_n)$ together with a (possibly trivial) knot to the left. Since T_n does not have ∞ -parity, $D(T_n)$ has a single component. Now by Wolcott's Theorem since T_n is not horizontal, $D(T_n)$ is a non-trivial knot, and hence by Schubert's Theorem, L_1 is a non-trivial knot.

Suppose that $i = n$ and T_n is the only T_j with ∞ -parity. Then we can extend both ends of the NW-SW strand of T_n to the left until they are joined together at the closing vertex w . We denote this loop by L_2 . Since $n > 1$, L_2 is the connected sum of $D(T_1)$ and another (possibly trivial) knot. Now as above we see that L_2 is a non-trivial knot.

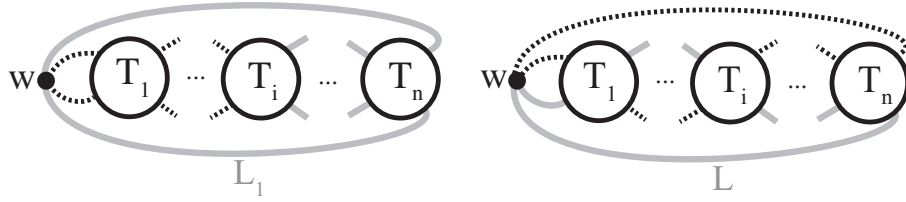

FIGURE 3.1. On the left T_i has ∞ -parity and on the right no subtangle has ∞ -parity.

Now suppose that some rational subtangle in addition to T_n has ∞ -parity. Let T_i be the tangle with ∞ -parity that is closest to T_n . Then both ends of the NE-SE strand of T_n can be extended rightward to w to obtain a loop L_1 ; and both ends of the NW-SW strand of T_n can be extended leftward until they are joined together in T_i , to obtain a loop L_2 . Then the link $L = L_1 \cup L_2$ is the connected sum of $D(T_n)$ with some possibly trivial knot. Now since T_n is not a trivial vertical tangle, by Wolcott's Theorem and Schubert's Theorem, L is a non-trivial link.

Finally, suppose that no T_i has ∞ -parity. Then $V(T)$ is an embedding of the wedge of two circles and hence $V(T)$ cannot contain a two component link. Let L denote the vertex closure of a single strand of T . Since no T_i has ∞ -parity, L passes through each T_i exactly once, as illustrated on the right side of Figure 3.1. Now since each T_i is rational, by Lemma 3.2, each $V(T_i)$ is planar. It follows that the vertex closure of each of the single strands $T_i \cap L$ is unknotted. Now the loop L is the connected sum of the loops $V(T_1 \cap L), \dots, V(T_n \cap L)$, each of which is unknotted. Hence L is a trivial knot. Thus $V(T)$ contains no non-trivial knots or links. However, since T is not rational, we know by Lemma 3.2 that $V(T)$ is non-planar. Hence in this case $V(T)$ is a ravel. \square

The tangle in Figure 3.2 illustrates why Theorem 3.3 has the hypothesis that not both T_1 and T_n are trivial vertical tangles. In this case, $V(T_1 + T_2)$ is planar even though $T_1 + T_2$ is a non-rational Montesinos tangle.

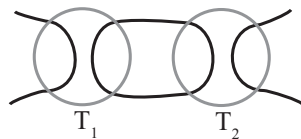

FIGURE 3.2. A Montesinos tangle where both T_1 and T_2 are trivial vertical tangles.

Corollary 3.4. *Let T be a non-rational algebraic tangle written as the sum and product of rational tangles T_1, \dots, T_n . If each strand of T passes through each T_i exactly once, then $V(T)$ is a ravel.*

Proof. Observe that since each strand of T passes through each T_i exactly once, $V(T)$ must be a wedge of two circles. Thus the argument is analogous to the last case in the proof of Theorem 3.3. \square

The algebraic tangle T in Figure 3.3 illustrates that the converse of Theorem 3.4 does not hold. In particular, the black strand passes through both

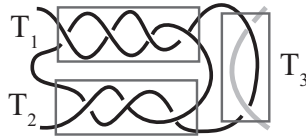

FIGURE 3.3. A counterexample to the converse of Theorem 3.4.

T_1 and T_2 twice. Observe that $V(T)$ contains no non-trivial knots or links. However, since T is non-rational, it follows from Lemma 3.2 that $V(T)$ is non-planar. Thus $V(T)$ is a ravel.

4. VERTEX CLOSURE WITH CROSSING REPLACEMENT

We are now interested in whether we can obtain a ravel from a projection of a Montesinos tangle by replacing some number of crossings by vertices and taking the vertex closure. In this case, we need to specify what types of projections we are considering.

Definition 4.1. *A projection of a rational tangle T is said to be in alternating 3-braid form if it is alternating and has the form of Figure 4.1, where each box A^i consists of some number of horizontal twists, and this number is non-zero for all $i > 1$.*

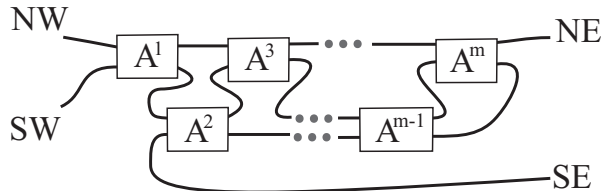

FIGURE 4.1. The 3-braid form of a rational tangle.

It follows from Schubert [10] and more recently Kauffman and Lambropoulou [3] that every rational tangle has a projection in alternating 3-braid form.

Definition 4.2. A projection of a Montesinos tangle T is said to be in standard form if it is expressed as $T = T_1 + \cdots + T_n$, where each T_i is a non-trivial rational tangle in alternating 3-braid form and n is minimal.

Note that every Montesinos tangle without a trivial vertical tangle as a summand has a projection in standard form, though this projection may not be alternating.

Definition 4.3. Let T be a projection of a knot, link, or tangle. The embedded graph obtained from T by replacing some number of crossings by vertices of valence 4 is denoted by T' and referred to as an insertion of vertices into T .

Note that if T is a tangle than T' is not technically an embedded graph, because its endpoints are not vertices. However, for convenience we will abuse notation and refer to T' as an embedded graph. Now let $T = T_1 + \cdots + T_n$ be a projection of a Montesinos tangle in standard form. Then T'_i denotes the subgraph of T' obtained from T_i by vertex insertion, and $(A_i^j)'$ denotes the subgraph obtained from the j th box of twists A_i^j in T_i by vertex insertion. If there are no vertices in T'_i or in $(A_i^j)'$, then we write $T'_i = T_i$ or $(A_i^j)' = A_i^j$, respectively.

The following result shows that a ravel cannot occur in the special case where a single crossing is replaced by a vertex and $V(T')$ is a θ_4 graph (i.e., the graph consisting of two vertices and four edges between them).

Theorem 4.4. (Farkas, Flapan, Sullivan [2]) Let $T = T_1 + \cdots + T_n$ be a projection of a Montesinos tangle in standard form with $n > 1$, and let T' be obtained from T by replacing a single crossing by a vertex such that $V(T')$ is a θ_4 graph. Then $V(T')$ contains a non-trivial knot and hence is not a ravel.

To see the necessity of the hypothesis that $V(T')$ is a θ_4 graph consider the Montesinos tangle in standard form illustrated on the left in Figure 4.2. By replacing a crossing with a vertex and taking the vertex closure as illustrated on the right, we obtain a ravel which is not θ_4 graph.

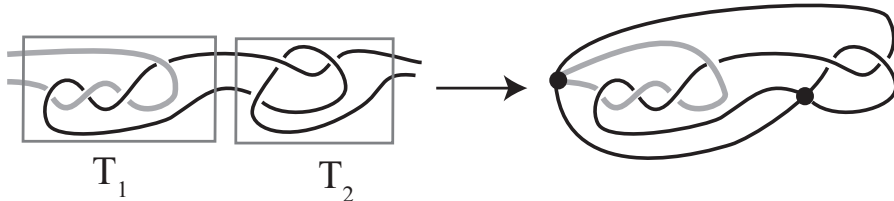

FIGURE 4.2. A Montesinos tangle which becomes a ravel by inserting one vertex and taking the vertex closure.

We will generalize Theorem 4.4 to the case of replacing any number of crossings of a Montesinos tangle in standard form by vertices. We begin with some technical definitions.

Definition 4.5. *Let T be a projection of a rational tangle in alternating 3-braid form with boxes A^1, \dots, A^m as illustrated in Figure 4.1. A vertex or crossing x of T' is said to be to the right of a vertex or crossing y if either x and y are in the same box $(A^i)'$ and y is to the right of x in $(A^i)'$ or x is in the box $(A^i)'$ and y is in the box $(A^j)'$ and $i > j$.*

Observe that given a rational tangle T in 3-braid form, a subtangle R of T containing consecutive boxes A^j, \dots, A^m (illustrated in Figure 4.3) is itself a rational tangle in 3-braid form.

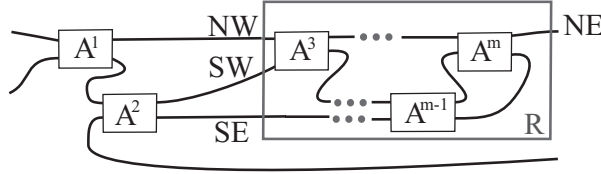

FIGURE 4.3. The subtangle R is itself a rational tangle in 3-braid form.

Definition 4.6. *Let $T = T_1 + \dots + T_n$ be a projection of a Montesinos tangle in standard form, and let T' be obtained by replacing some nonzero number of crossings by vertices. Then T' is said to be an exceptional vertex insertion if the following conditions hold.*

- (1) *There exists a unique T_j with ∞ -parity, and T_j' has no vertices.*
- (2) *For all $k \neq j$, T_k' contains exactly one vertex v_k , and v_k is in $(A_k^2)'$ or possibly in $(A_k^3)'$ in the case where A_k^2 has a single crossing.*
- (3) *For all $k \neq j$, the subtangle $R_k \subseteq T_k$ containing the boxes to the right of the vertex v_k has 0-parity and at least two crossings.*

We see as follows that the insertion of vertices illustrated for the tangle in Figure 4.2 is exceptional.

- (1) T_1 is the only T_i with ∞ -parity, and T_1' has no vertices.
- (2) T_2' contains exactly one vertex, and it is in the second box of T_2' . (Note that the first box of T_2' has zero crossings).
- (3) The subtangle $R_2 \subseteq T_2$ has 0-parity and two crossings.

Figure 4.4 illustrates a generalization of the exceptional vertex insertion illustrated in Figure 4.2. Here T_3 is any ∞ -parity tangle; for each $k \neq 3$, T_k' contains exactly one vertex and it replaces the only crossing in A^2 , and R_k is any rational tangle with 0-parity and at least two crossings. As in

Figure 4.2, we obtain a ravel by taking the vertex closure of this exceptional vertex insertion.

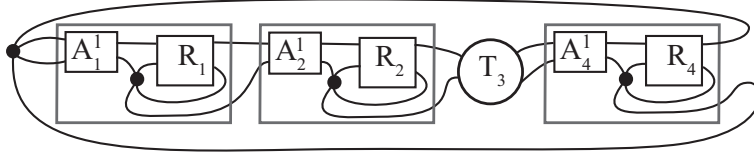

FIGURE 4.4. A ravel obtained by an exceptional vertex insertion together with vertex closure.

The remainder of the paper is devoted to proving the following generalization of Theorem 4.4.

Theorem 4.7. *Let $T = T_1 + \cdots + T_n$ be a projection of a Montesinos tangle in standard form, and let T' be obtained from T by replacing at least one crossing by a vertex. Then $V(T')$ is a ravel if and only if T' is an exceptional vertex insertion.*

Theorem 4.7 immediately implies the following more simply stated corollary.

Corollary 4.8. *Let $T = T_1 + \cdots + T_n$ be a projection of a Montesinos tangle in standard form, and let T' be obtained from T by replacing at least one crossing with a vertex. If $V(T')$ is a ravel, then precisely one T_i has ∞ -parity.*

Observe that if $T = T_1 + \cdots + T_n$ is a projection of a non-rational Montesinos tangle in standard form, then no T_i is horizontal since otherwise n would not be minimal. Also, by the definition of standard form, no T_i is a trivial tangle. Finally, because every vertex in $V(T')$ has valence 4, no arc in T' is forced to terminate at a vertex. This means that any arc in some T'_i can be extended to go from one of the points NE, SE, NW, SW to another. We will make use of these facts together with the following simplifying assumptions that allow us to remove unnecessary crossings in T'_i .

Simplifying Assumptions

- (1) If there are vertices in some box $(A_i^j)'$ of T'_i , then we can untwist about them to remove all of the crossings of $(A_i^j)'$. Thus we assume that there are no crossings in any box containing a vertex.
- (2) If there is a single crossing to the right of the rightmost vertex of some T'_i , then the crossing can be removed by untwisting about the vertex as illustrated in Figure 4.5. Thus we assume that there are either no crossings or at least two crossings to the right of the rightmost vertex in any T'_i .



FIGURE 4.5. A single crossing to the right of the rightmost vertex can be removed.

The rest of the paper is devoted to proving Theorem 4.7. In particular, in Section 5 we prove two Lemmas that we will use to prove the forward direction of Theorem 4.7. Then we prove the forward direction in Section 6, and finally we prove the backward direction of Theorem 4.7 in Section 7.

5. LEMMAS FOR THE FORWARD DIRECTION

Lemma 5.1. *Let T be a projection of a non-trivial rational tangle in 3-braid form. Suppose that T' has at least one vertex and there are no crossings to the right of its rightmost vertex v^R . Then for any pair of distinct points p_1 and p_2 in T' , there is a simple path between p_1 and p_2 in T' .*

Proof. Observe from Figure 4.1 that if a path P starts at the NE point of T and goes leftward, it will go through the rightmost box A^m precisely once. In particular, once a path exits from A^m , it cannot return to A^m . Thus both strands of T go through A^m .

Recall that for all $i \neq 1$, the box A^i contains a non-zero number of crossings. Since there are no crossings to the right of v^R , this means that v^R occurs in the rightmost box $(A^m)'$ of T' as illustrated in Figure 5.1. Thus both strands of T are part of the crossing that becomes v^R .

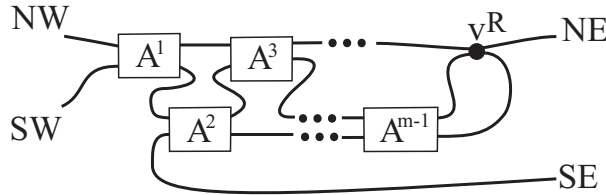

FIGURE 5.1. Both strands of T are part of the crossing that becomes v^R .

Now consider distinct points p_1 and p_2 in T' . Since both strands of T are part of the crossing that becomes v^R , there are paths P_1 and P_2 in T' joining both p_1 and p_2 to v^R . Thus $P = P_1 \cup P_2$ is a path in T' between p_1 and p_2 . By removing any loops in P we obtain a simple path joining p_1 and p_2 . \square

Now it follows from Lemma 5.1 that if there are no crossings to the right of the rightmost vertex of T' , then there is a simple path in T' between any pair of the NW, SW, NE, SE points of T' . We use Lemma 5.1 to prove our next lemma.

Lemma 5.2. *Let $T = T_1 + \cdots + T_n$ be a projection of a Montesinos tangle written in standard form, and let T' be obtained from T by replacing at least one crossing by a vertex. Suppose that every T'_i containing a vertex has at most one crossing to the right of its rightmost vertex v_i^R . Then $V(T')$ is not a ravel.*

Proof. We assume that $V(T')$ does not contain any non-trivial knots or links, and we will prove that $V(T')$ can be isotoped into the plane.

By Simplifying Assumption (2), we can assume that no T'_i has any crossings to the right of its rightmost vertex v_i^R . Thus any T'_i that contains a vertex must have v_i^R in its rightmost box $(A_i^m)'$. Now we see in Figure 5.2 that we can remove all of the crossings between v_i^R and the next vertex to its left in T'_i , or all of the crossings in T'_i if v_i^R is the only vertex in T'_i . Thus we assume there are no such crossings.



FIGURE 5.2. We remove all of the crossings between v_i^R and the next vertex to the left in T'_i .

We now prove the following sequential list of claims showing that we can remove all of the crossings of $V(T')$ to obtain a planar embedding.

- (1) Every T'_i contains a vertex.
- (2) $V(T')$ can be simplified so that there is at most one crossing between any pair of adjacent vertices in each T'_i .
- (3) All crossings to the left of the leftmost vertex in every T'_i can be removed.
- (4) All of the crossings of $V(T')$ can be removed.

Claim 1: Every T'_i contains a vertex.

Assume that some T'_i contains no vertices. Since there is at least one vertex in T' , there is an adjacent pair of subgraphs T'_i and T'_{i+1} , exactly one of which contains a vertex. Without loss of generality we assume that T'_{i+1} contains a vertex and T'_i does not. Let v_{i+1}^R be the rightmost vertex

of T'_{i+1} . Since there are no crossings in T_{i+1} to the right of v_{i+1}^R , we can apply Lemma 5.1 to obtain a simple path L_1 in T'_{i+1} between its NW and SW points. We now argue that there is a simple path between the NW and SW points of T_i whose interior is to the left of T_i .

Suppose no T'_k to the left of T'_i contains a vertex or has ∞ -parity. Then there are disjoint simple paths P_i and Q_i going leftwards from the NW and SW points of T_i to the closing vertex w . In this case, $L_2 = P_i \cup Q_i$ is a simple path between the NW and SW points of T_i whose interior is to the left of T_i .

Thus we assume that either some T'_k to the left of T'_i contains a vertex or some T'_k to the left of T'_i has ∞ -parity and contains no vertices.

Let T'_k be the closest such subgraph to the left of T_i . If T'_k contains a vertex, then there are no crossings to the right of its rightmost vertex, and hence by Lemma 5.1 there is a simple path in T'_k between its NE and SE points. If $T_k = T'_k$ has ∞ -parity, then the NE-SE strand is a simple path in T_k . Thus in either case T'_k contains a simple path between its NE and SE points. By combining this path in T'_k with the strands of all T_j with $k < j < i$ and the arcs between these T_j from T'_k to T'_i , we obtain a simple path L_2 between the SW and NW points of T_i whose interior is to the left of T_i . Figure 5.3 illustrates the paths L_1 and L_2 as dotted arcs.

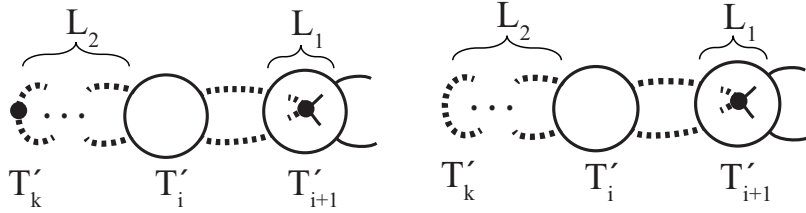

FIGURE 5.3. On the left, T'_k contains a vertex; and on the right, T'_k has ∞ -parity.

Now in any of the above cases, let L denote the arcs L_1 (in T'_{i+1}) and L_2 (to the left of T'_{i+1}), together with the strands of T_i and the arcs joining T'_i and T'_{i+1} . If T_i has ∞ -parity, then L has two components, and otherwise L has a single component. In either case, observe that L is the connected sum of some (possibly trivial) knot that lies to the left of T_i , together with the denominator closure $D(T_i)$, and some (possibly trivial) knot that lies to the right of T_i . Now, since T_i is not horizontal and not a trivial vertical tangle, we know by Wolcott's Theorem that $D(T_i)$ is a non-trivial knot or link. It now follows from Schubert's Theorem that L is a non-trivial knot or link. As this is contrary to our assumption, this proves Claim 1.

Hence from now on we assume that for every i , T'_i contains a vertex, and hence v_i^R is in the rightmost box of T'_i . Thus it follows from Lemma 5.1 that every pair of distinct points in any T'_i is joined by a simple path in T'_i .

Claim 2: $V(T')$ can be simplified so that there is at most one crossing between any pair of adjacent vertices in each T'_i .

Suppose that some T'_i has two or more crossings between a pair of adjacent vertices v_1 and v_2 . Let v_1 and v_2 be contained in boxes $(A_i^j)'$ and $(A_i^k)'$, respectively. Note that by Simplifying Assumption (1), we can assume that there are no crossings in any box containing a vertex. Thus the boxes $(A_i^j)'$ and $(A_i^k)'$ must be distinct. Hence without loss of generality $j < k$. Also, as we saw at the beginning of the proof, we can assume that there are no crossings between v_i^R and the next vertex to its left. Hence v_2 cannot be the rightmost vertex of T'_i .

Now let B be a ball containing v_1 and v_2 together with the portion of T'_i between v_1 and v_2 as illustrated in Figure 5.4; and let a and b be the points of $\partial B \cap T'_i$ which are separated from v_1 and v_2 by crossings, as indicated in the figure. Note that since v_1 and v_2 are adjacent vertices, there are no

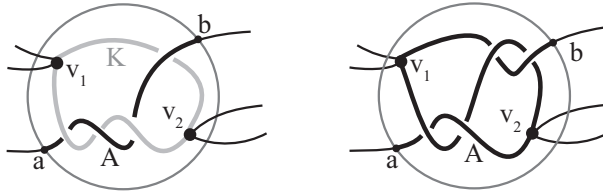

FIGURE 5.4. The ball B contains the portion of T'_i between v_1 and v_2 .

other vertices in B . Thus either $T'_i \cap B$ contains two edges which join v_1 and v_2 creating a simple closed curve K and a disjoint arc A going from a to b (illustrated on the left in Figure 5.4), or $T'_i \cap B$ contains a single arc A joining a and b which goes through v_1 and v_2 (illustrated on the right in Figure 5.4).

Now since v_1 is contained in the box $(A_i^j)'$, there is a path P_1 going leftward from a to the NW, SW, or SE point of T'_i which does not pass through any box $(A_i^t)'$ with $t \geq j$. Also, there is a path P_2 going rightward from b to the rightmost vertex v_i^R , and then to the NE point of T'_i which does not pass through any $(A_i^s)'$ with $s \leq k$. In particular, neither P_1 nor P_2 contains v_1 or v_2 .

We will now define a simple closed curve J that contains $P_1 \cup P_2 \cup A$. We first do this in the case where P_1 goes from a to the SE point of T'_i as illustrated by the dotted arc in Figure 5.5. In this case, if $i \neq n$, we extend P_1 and P_2 rightward to the SW and NW points of T'_{i+1} respectively. Then by Claim 1 and Lemma 5.1, we can join P_1 and P_2 by a simple path in T'_{i+1} . If $i = n$, then we can extend P_1 and P_2 rightward until they meet at w . Thus either way we can join P_1 and P_2 by a simple path. This gives us a simple path P from a to b whose interior is disjoint from B . Now let J

denote the simple closed curve $P \cup A$. Then J meets ∂B only in the points a and b .

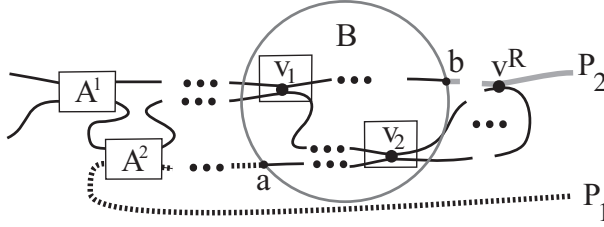

FIGURE 5.5. There is a simple path from a to b consisting of P_1 , P_2 , and an arc in T'_{i+1} .

Next suppose that P_1 does not go to the SE point of T'_i . Then without loss of generality we can assume P_1 goes from a to the SW point of T'_i as illustrated by the dotted arc in Figure 5.6. By Claim 1, we can now extend

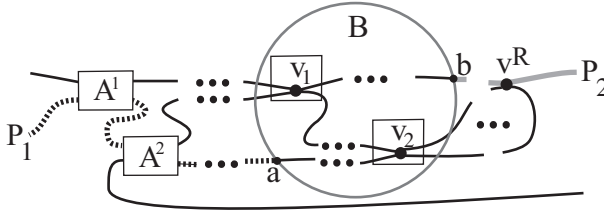

FIGURE 5.6. We extend P_1 leftward and P_2 rightward until they meet at the closing vertex w .

P_1 and P_2 leftward and rightward respectively until they meet at the closing vertex w giving us a simple path P from a to b whose interior is disjoint from B . Now let J denote the simple closed curve $P \cup A$. Again J meets ∂B only in the points a and b .

In either of the above cases, if A contains v_1 and v_2 let $L = J$, and otherwise let $L = J \cup K$. Now since T'_i has at least two crossings between v_1 and v_2 , the vertex closure $V(L \cap B)$ contains at least two crossings and is reduced and alternating. It follows from Thistlethwaite's Theorem and Schubert's Theorem that L is a non-trivial knot or link. As this is contrary to our assumption, we have proven Claim 2.

Hence from now on we assume that there is at most one crossing between any pair of adjacent vertices in every T'_i .

Claim 3: All crossings to the left of the leftmost vertex in every T'_i can be removed.

If T is rational, then we can remove all of the crossings to the left of the leftmost vertex v^L by untwisting about the closing vertex w from left to right, as illustrated in Figure 5.7. Thus for the rest of the proof of this claim we assume that T is not rational, and hence $n > 1$.

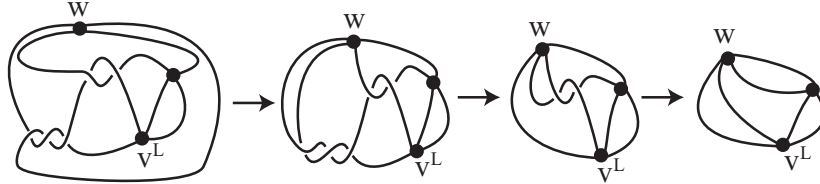

FIGURE 5.7. If T is rational, we can remove all of the crossings to the left of v^L .

Let T'_i be the leftmost subgraph of T' that contains at least one crossing to the left of its leftmost vertex v_i^L . By Simplifying Assumption (1), there are no crossings in the box with v_i^L . Thus $(A_i^1)'$ cannot contain any vertices, and hence $A_i^1 = (A_i^1)'$. Suppose that A_i^1 contains a crossing. Let c denote

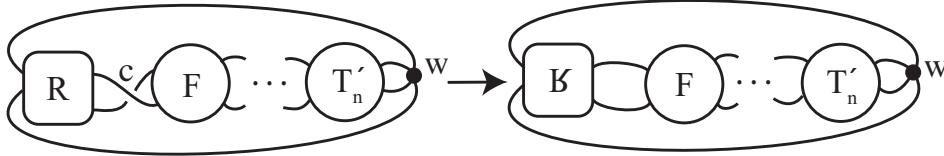

FIGURE 5.8. Removing the leftmost crossing of T'_i .

the leftmost crossing of A_i^1 ; let R denote a ball whose intersection with $V(T')$ is $(T_1 + \dots + T_{i-1})'$; and let F denote the part of T'_i to the right of c (see the left side of Figure 5.8).

We flip R over to remove the crossing c . This adds a crossing to the left of R which can be removed by untwisting the strands around the closing vertex w . Thus we get the illustration on the right of Figure 5.8.

We repeat this operation until we have removed all of the crossings in A_i^1 . This proves the claim in the case where v_i^L is in $(A_i^1)'$ or $(A_i^2)'$. Thus we assume that v_i^L is not in $(A_i^1)'$ or $(A_i^2)'$.

Next suppose there is only one crossing in T'_i to the left of v_i^L . Since every box $(A_i^k)'$ with $k > 1$ must either contain a crossing or a vertex, this means that $(A_i^2)'$ contains one crossing and v_i^L is in $(A_i^3)'$. Hence $(A_i^2)'$ has no vertices and $(A_i^3)'$ has no crossings. Thus we have the illustration on the left of Figure 5.9, where the ball R contains the subgraphs T'_1, \dots, T'_{i-1} and the ball F contains the boxes $(A_i^j)'$ with $j > 3$. We can now remove the

crossing in A_i^2 by flipping both R and F over and untwisting the strands around w as illustrated on the right side of Figure 5.9. Thus we assume there are at least two crossings in T'_i to the left of v_i^L .

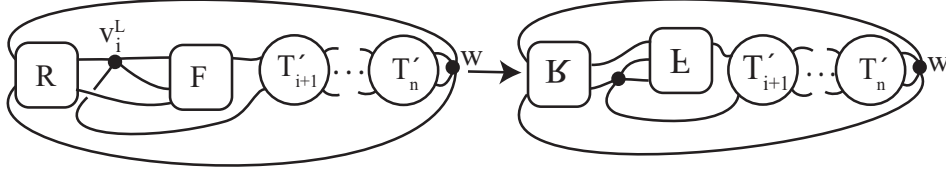

FIGURE 5.9. Removing a single crossing in A_2 when v^L is in A_3 .

Now let B be a ball containing v_i^L together with the part of T'_i that is to the left of v_i^L as illustrated in Figure 5.10. The arc marked x can be

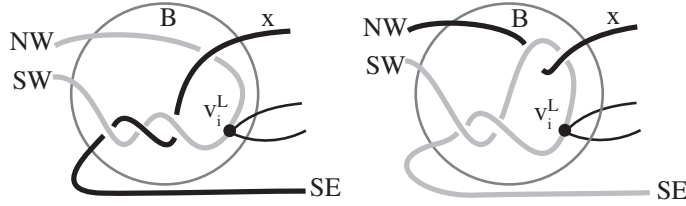

FIGURE 5.10. We can extend the bold black and grey arcs to get one or two simple closed curves.

extended by a simple path to the NE point of T'_i . Now the NW and SW points of T'_i are joined together either by an arc at v_{i-1}^R or at w if $i = 1$, and the NE and SE points of T'_i are joined together either by an arc at or before T'_{i+1} or at w if $i = n$. These arcs together with the bold black and grey arcs in Figure 5.10 give us one or two simple closed curves which we denote by L . Since $V(L \cap B)$ is reduced and alternating and has at least two crossings, it follows from Thistlethwaite's Theorem and Schubert's Theorem that L is a non-trivial knot or link. Thus we have proven Claim 3. Hence from now on we assume that there are no crossings to the left of the leftmost vertex in every T'_i .

It follows from our hypotheses together with Claims 1–3 that the only crossings remaining in $V(T')$ are isolated crossings between two adjacent vertices within a single T'_i .

Let x denote the leftmost crossing in $V(T')$. Then x is between a pair of vertices v_a and v_b in some T'_i . Since there is only one crossing between them, the vertices v_a and v_b are in boxes $(A_i^j)'$ and $(A_i^{j+2})'$ respectively, and the crossing x is in the box $(A_i^{j+1})' = A_i^{j+1}$. Let G denote a ball around

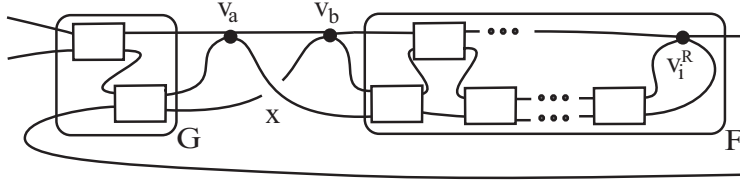

FIGURE 5.11. T'_i has a single crossing between v_a and v_b .

the boxes $(A_i^k)'$ with $k < j$ in T'_i , and let F denote a ball around the boxes $(A_i^k)'$ with $k > j + 2$ in T'_i (see Figure 5.11).

Let B denote a ball containing all of the T'_s such that $s < i$. Then $V(T')$ is the embedded graph illustrated on the top of Figure 5.12. Note that B and G contain no crossings. We now flip F over to remove the crossing x from $V(T')$. This gives us the picture illustrated on the bottom of Figure 5.12. We repeat the above argument to sequentially remove all of the remaining crossings in the projection of $V(T')$.

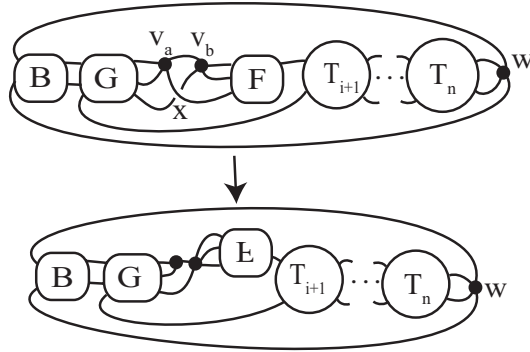

FIGURE 5.12. We can flip F over to remove the crossing between v_a and v_b .

This gives us a planar embedding of $V(T')$. Thus $V(T')$ is not a ravel. \square

6. PROOF OF THE FORWARD DIRECTION OF THEOREM 4.7

Proposition 6.1. *Let $T = T_1 + \dots + T_n$ be a projection of a Montesinos tangle in standard form, and let T' be obtained from T by replacing a non-zero number of crossings by vertices. Suppose that $V(T')$ is a ravel. Then T' is an exceptional vertex insertion.*

Proof. Given any k such that T'_k contains a vertex, let v_k^R denote the rightmost vertex of T'_k . Then T'_k has the form illustrated in Figure 6 where v_k^R may be in the top or the bottom row, and R_k is a ball containing all of the crossings of T'_k that are to the right of v_k^R .

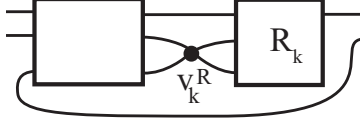

FIGURE 6.1. v_k^R is the rightmost vertex of T'_k , and R_k contains all of the crossings of T'_k that are to the right of v_k^R .

We now prove that T' is an exceptional vertex insertion by sequentially proving the following list of claims.

- (1) Some T_j has ∞ -parity, and T'_j has no vertices.
- (2) For all $k \neq j$, T_k does not have ∞ -parity, T'_k has at least one vertex, and R_k has at least two crossings.
- (3) For all $k \neq j$, T'_k contains exactly one vertex.
- (4) For all $k \neq j$, the vertex v_k is in $(A_k^2)'$ or possibly in $(A_k^3)'$ in the case where A_k^2 has a single crossing.
- (5) For all $k \neq j$, the tangle $R_k \subseteq T_k$ has 0-parity.

Claim 1: Some T_j has ∞ -parity, and T'_j has no vertices.

Since $V(T')$ is a ravel, we know by Lemma 5.2 and Simplifying Assumption (2) that some T'_k that contains a vertex has at least two crossings in R_k . We now prove the following.

Observation 1: If for some k , there are at least two crossings in R_k , then there is no path in T'_k between its NE and SE point. Hence T'_k contains paths from its NE and SE points to its NW and SW points.

To prove Observation 1, suppose that there are at least two crossings in R_k and there is a path in T'_k between its NE and SE point. Then we can extend this path rightward until its ends meet either at a vertex in some T'_j , in some T_j with ∞ -parity, or at the closing vertex w . This gives us a simple closed curve L_1 . If L_1 contains v_k^R , let $L = L_1$. Otherwise, as can be seen in Figure 6, there is a simple closed curve $L_2 \subseteq T'_k$ containing v_k^R such that all of the crossings in R_k are contained in $L_1 \cup L_2$. In this case, we let $L = L_1 \cup L_2$.

Now let B_k denote the tangle ball for T_k . Then L is the union of $L \cap B_k$ together with an arc outside of B_k . Since $L \cap B_k$ contains at least two

crossings and is reduced and alternating, L is a non-trivial knot or link. However, this contradicts the hypothesis that $V(T')$ is a ravel. Thus we have proven the observation.

Now let P_k be an arc in T'_k from its NE point to its SW or NW point, and suppose the endpoints of P_k can be extended rightward and leftward to w , so that we obtain a simple closed curve L_1 . If L_1 contains v_k^R , let $L = L_1$. Otherwise, there is another simple closed curve $L_2 \subseteq T'_k$ containing v_k^R such that all of the crossings in R_k are contained in $L_1 \cup L_2$. In this case, we let $L = L_1 \cup L_2$. Now as in the proof of Observation 1, this implies that L is a non-trivial knot or link contradicting the hypothesis that $V(T')$ is a ravel. Thus P_k cannot be extended so that it passes through every T'_j .

However, if no T_j has ∞ -parity, then P_k could be extended in this way. Thus there exists some j such that T_j has ∞ -parity. Now suppose that T'_j has at least one vertex. If there are less than two crossings to the right of the rightmost vertex v_j^R , then by Simplifying Assumption (2), we can assume there are no crossings in T'_j to the right of v_j^R . Hence by Lemma 5.1, we could again extend P_k through T'_j . On the other hand if there are at least two crossings to the right of v_j^R , then by Observation 1, there are paths from the NE and SE points of T'_j to the NW and SW points of T'_j . Thus we could again extend P_k through T'_j . Hence there must be some T_j which has ∞ -parity and T'_j has no vertices.

We now prove Observation 2, which will be used in the proof of Claim 2.

Observation 2: Neither strand of T_j can be extended to a simple closed curve in T' .

Suppose that some strand of T_j can be extended to a simple closed curve L_1 in T' . By extending the ends of the other strand of T_j until they meet at or before w , we obtain a disjoint simple closed curve L_2 . Then $L = L_1 \cup L_2$ is the connected sum of $D(T_j)$ and two (possibly trivial) knots. Since T_j has ∞ -parity, $D(T_j)$ is a link. Now because T_j is non-trivial, by Wolcott's Theorem $D(T_j)$ is non-trivial. Hence L is a non-trivial link. As this contradicts the hypothesis that $V(T')$ is a ravel, Observation 2 follows.

Claim 2: For all $k \neq j$, T_k does not have ∞ -parity, T'_k has at least one vertex, and R_k has at least two crossings.

Suppose that there is some $k \neq j$ such that T_k has ∞ -parity. Without loss of generality, $k > j$. Then we can extend one of the strands of T_j to the right so that the ends meet either in T_k or before. As this violates Observation 2, no T_k with $k \neq j$ can have ∞ -parity.

Suppose that some T'_k with $k \neq j$ has no vertices. Without loss of generality, $k > j$. Since T_j has ∞ -parity, we can extend the western endpoints of T_k leftward until they meet at or before T_j , and we can extend the eastern endpoints of T_k rightward until they meet at or before w . Let L be

the simple closed curve obtained as the union of T_k with these rightward and leftward extensions. Now L is the connected sum of $D(T_k)$ with (possibly trivial) knots on the right and left. Recall that since T is in standard form, T_k is not horizontal. Thus by Wolcott's Theorem L is a non-trivial knot. Thus T'_k must have at least one vertex.

Finally, suppose that some T'_k has at most one crossing in R_k . Then by Simplifying Assumption (2), T'_k has no crossings to the right of v_k^R . Hence by Lemma 5.1, there is a simple path in T'_k between its NW and SW point. Thus again we can extend one of the strands of T_j to a simple closed curve in T' . As this again violates Observation 2, R_k must have at least two crossings.

Claim 3: For all $k \neq j$, T'_k contains exactly one vertex.

Suppose that some T'_k contains at least two vertices. Without loss of generality $k > j$. Let v_k^L be the leftmost vertex in T'_k . Then we can illustrate T'_k by Figure 6.2, where all of the crossings of T'_k are in the balls Q_k , S_k , and R_k , and any other vertices of T'_k are contained in S_k . Note that in spite of the way we have illustrated them, v_k^L and v_k^R can each be in the top or bottom row.

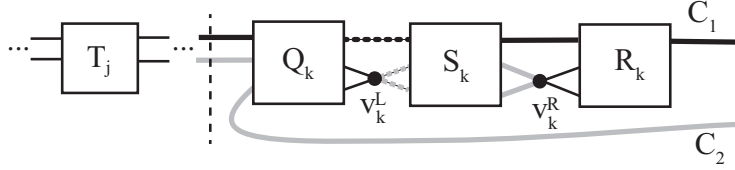

FIGURE 6.2. L_1 intersects T'_k in disjoint arcs C_1 and C_2 .

Now we extend the ends of the NE-SE strand of T_j rightward until they meet. This must occur at the closing vertex w or else it would violate Observation 2. After removing any loops, we obtain a simple closed curve L_1 . Then L_1 intersects T'_k in a pair of disjoint arcs C_1 and C_2 which go between the Eastern and Western points of T'_k . Without loss of generality, we assume the endpoints of C_1 are the NE and NW points of T'_k and the endpoints of C_2 are the SE and SW points of T'_k .

Suppose that v_k^R is contained in C_2 . Since C_1 does not contain v_k^R , it contains an arc between R_k and S_k . Since C_2 is disjoint from C_1 and does not have any loops, C_2 must contain the two arcs going leftward from v_k^R . Thus all three arcs entering S_k from the right are in L_1 . Also, since C_1 and C_2 do not contain any loops, all three arcs exiting S_k on the left must also be in L_1 . Now if the black dotted segment in Figure 6.2 is contained in C_1 , then the two dotted grey segments would be in C_2 , and hence C_2 would contain a loop between v_k^L and v_k^R . But if the black dotted segment is in C_2 , then C_1 and C_2 would intersect at v_k^L . Hence v_k^R cannot be in C_2 .

Thus either v_k^R is contained in C_1 , or v_k^R is contained in a loop $L_2 \subseteq T'_k$ which is disjoint from L_1 . In the first case, we let $L = L_1$, and in the second case we let $L = L_1 \cup L_2$. Now since R_k contains at least two crossings, $L_1 \cup L_2$ is a non-trivial link. As this is contrary to our hypothesis, T'_k cannot contain more than one vertex.

Claim 4: For all $k \neq j$, the vertex v_k is in $(A_k^2)'$ or possibly in $(A_k^3)'$ in the case where A_k^2 has a single crossing.

Suppose that some T'_k has its vertex in the first box, as illustrated in Figure 6.3. Then there would be a path in T'_k between its NE and SE points, which would violate Observation 1.

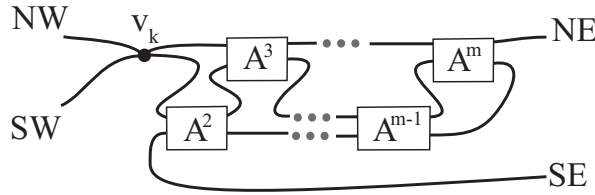

FIGURE 6.3. There are paths joining the NW and SW points and joining the NE and SE points.

Now suppose that some T'_k has its vertex v_k in a box $(A_k^p)'$ where either $p > 3$ or $p = 3$ and A_k^2 has more than one crossing. Let W_k be the tangle consisting of the part of T'_k to the left of v_k , as illustrated in Figure 6.4 (though v_k could be in a box to the right of A_k^3). Note that W_k does not include the grey arcs to the right of v_k . Then W_k is a rational tangle; and since there are at least two crossings in A_k^2, \dots, A_k^{p-1} , the tangle W_k is neither a horizontal tangle nor a trivial vertical tangle.

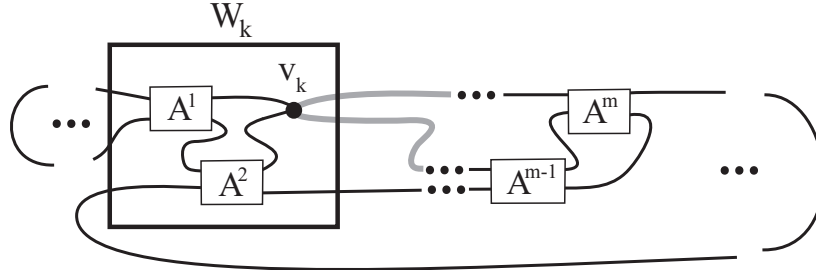

FIGURE 6.4. W_k is a rational tangle which is neither a horizontal tangle nor a trivial vertical tangle.

Now there is a path that goes from the NW and SW points of W_k leftward until its ends meet in T_j , at w , or at some other vertex. Also there is a path that goes rightward from the NE and SE points of W_k until the ends meet in T_j , at w , or at some other vertex. Note that at most one of these paths contains w . The union of the two strands of W_k together with these leftward and rightward paths is the connected sum of $D(W_k)$ with two (possibly trivial) knots. Since W_k is neither horizontal nor a trivial vertical tangle, this connected sum is a non-trivial knot or link. Thus the vertex v_k must either be in $(A_k^2)'$ or possibly in $(A_k^3)'$ if A_k^2 has only one crossing.

Claim 5: For all $k \neq j$, the tangle $R_k \subseteq T_k$ has 0-parity.

Now suppose that R_k does not have 0-parity. Then there is a path in R_k from its NE point to its SW or SE point. In either case, this means there is a path from the NE point of T'_k to v_k . But now we can extend this path from v_k to the SE point of T'_k . As the existence of a path between the NE and SE points of T'_k violates Observation 1, R_k must have 0-parity.

Now it follows from Claims 1 through 5 that T' is an exceptional vertex insertion. \square

7. THE PROOF OF THE BACKWARD DIRECTION OF THEOREM 4.7

In order to prove the backward direction of Theorem 4.7, we use of the following definition and theorem due to Sawollek [8].

Definition 7.1. *Let G be a 4-valent graph embedded in \mathbb{R}^3 . The set of associated links $S(G)$ consists of those knots or links can be obtained from G by replacing a neighborhood of each vertex of G by a rational tangle.*

Sawollek's Theorem. [8] *Let G be a 4-valent graph embedded in \mathbb{R}^3 . The set of associated links $S(G)$ is an isotopy invariant of G .*

Proposition 7.2. *Let $T = T_1 + \dots + T_n$ be a projection of a Montesinos tangle in standard form, and suppose that T' is obtained from T by an exceptional vertex insertion. Then $V(T')$ is a ravel.*

Proof. By the definition of an exceptional vertex insertion, there is a single T_j with ∞ -parity, and T'_j has no vertices. Without loss of generality we assume that $j > 1$. Also, for all $k \neq j$, T'_k has a single vertex v_k which is either in $(A_k^2)'$ or possibly in $(A_k^3)'$ when A_k^2 has only one crossing, and R_k is a rational tangle with at least two crossings. Now for each k such that v_k is in $(A_k^3)'$, we move v_k to $(A_k^2)'$ by flipping R_k as illustrated in Figure 7.1.

Next, for each sequential $k > 1$ such that $k \neq j$, we flip the part of the projection of $V(T')$ to the left of A_k^1 repeatedly to move the crossings of A_k^1 to A_1^1 . Then we move all of the accumulated crossings from A_1^1 by twisting the strands around w . In Figure 7.2, A_1^1 begins with zero crossings and A_2^1 begins with three crossings. This gives us a projection of $V(T')$ such that

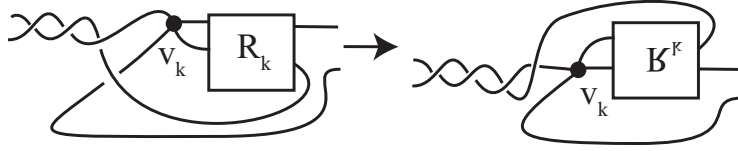

FIGURE 7.1. When v_k is in A_k^3 and A_k^2 has one crossing, we can move v_k to $(A_k^2)'$.

for each $k \neq j$, the vertex v_k is in $(A_k^2)'$ and all of the crossings of T'_k are in R_k .

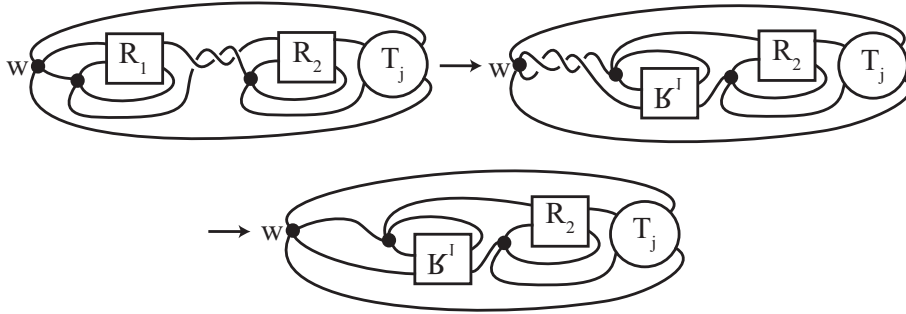

FIGURE 7.2. We can remove the crossings from the first box of each T'_k with $k \neq j$.

We now label the edges of $V(T')$ as illustrated in Figure 7.3. In particular, for all $k \neq j$, since R_k has 0-parity, T'_k has a loop c_k containing v_k . We label the edges which are not loops consecutively as follows. Let a_1 be the edge from w to v_1 , and let a_2 be the other edge with one endpoint at v_1 . We label the rest of the edges whose endpoints are to the left of T_j consecutively as a_3, \dots, a_j . Then a_j will have an endpoint at w , and hence $a = a_j \cup a_{j-1} \cup \dots \cup a_1$ will be a simple closed curve. Similarly, let b_n be the edge of $V(T')$ from w to the rightmost vertex v_n , and then consecutively label the edges whose endpoints are to the right of T_j by b_{n-1}, \dots, b_j . Then b_j will also have an endpoint at w , so $b = b_n \cup b_{n-1} \cup \dots \cup b_{j+1}$ will also be a simple closed curve.

Observe from Figure 7.3 that there are no crossings between the projections of any pair of grey loops c_k and c_i , and hence no pair of grey loops is linked. Also, each individual c_k is a single strand of the numerator closure of the rational tangle R_k , and so must be unknotted. In addition, the loops a and b are each connected sums of single strands of numerator closures of rational tangles. Hence a and b are each unknotted. Finally, a has no crossings with any c_k with $k > j$ and intersects every c_k with $k < j$ in the vertex v_k , and hence a cannot be linked with any c_k . Similarly, b cannot be

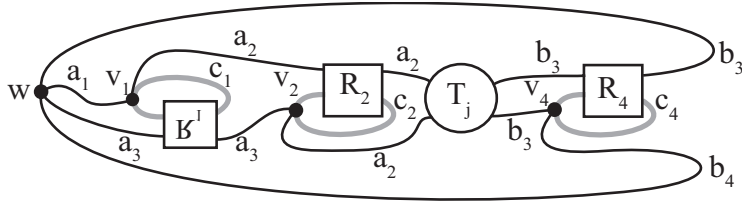

FIGURE 7.3. We label the edges of $V(T')$ in this way.

linked with any c_k . It follows that $V(T')$ contains no non-trivial knots or links.

In order to show that $V(T')$ is non-planar we will show that the subgraph G obtained by deleting the loops c_k and vertices v_k for all $k > 1$ with $k \neq j$ is non-planar (See Figure 7.4).

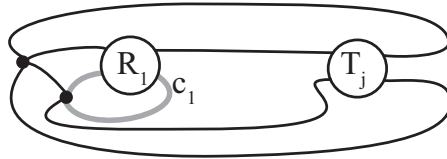

FIGURE 7.4. We will show that this subgraph G is non-planar.

In Figure 7.5 we see that as an abstract graph, G is isomorphic to the planar embedding G_0 illustrated on the right. The set of associated links $S(G_0)$ is obtained by replacing the vertices of G_0 by rational tangles. The denominator closure of a rational tangle is a 2-bridge knot or link. Thus all of the non-split links in $S(G_0)$ are either the connected sum of two 2-bridge knots or links, or a single 2-bridge knot or link when one of the summands is trivial. Hence, by Sawollek's Theorem 7, in order to show that G is non-planar it suffices to show that $S(G)$ contains some prime knot or link which is not 2-bridge.

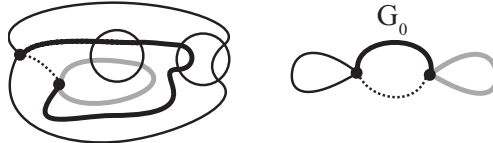

FIGURE 7.5. As an abstract graph G is isomorphic to the planar embedding G_0 .

The elements of $S(G)$ are illustrated in Figure 7.6, where P and Q are rational tangles. Also, since R_1 has 0-parity, R_1 cannot be vertical; and since T_j has ∞ -parity, T_j cannot be horizontal. Now we group R_1 and Q together to create a single tangle U as illustrated on the right. Then we choose a rational tangle Q so that U is a non-trivial rational tangle which is not horizontal. Thus for any rational tangle P , the knot or link $L = N(P + U + T_j)$ will be the numerator closure of a Montesinos tangle, where neither U nor T_j is horizontal.

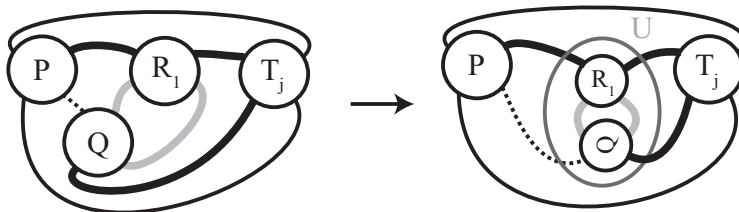

FIGURE 7.6. The elements of $S(G)$ have this form where P and Q are rational, R_1 has 0-parity, and T_j has ∞ -parity.

Thus the double branched cover $\Sigma(L)$ is a Seifert fibered space over S^2 , and as long as P is not horizontal or trivial, $\Sigma(L)$ has three exceptional fibers. Now by the classification of Seifert manifolds [7], we can choose a rational tangle P such that $\Sigma(L)$ is irreducible, not $S^1 \times S^2$, and has infinite fundamental group. For such a P we know that L will be prime but not 2-bridge. Thus $S(G)$ contains a link which is not in $S(G_0)$. It follows that G is non-planar, and hence $V(T')$ is a ravel. \square

Propositions 6.1 and 7.2 together prove Theorem 4.7.

REFERENCES

- [1] T. Castle, M. E. Evans, and S. T. Hyde, "Ravels: knot free but not free. Novel entanglements of graphs in 3-space." *New Journal of Chemistry*, **32:9**: 1457-1644, 2008.
- [2] C. Farkas, E. Flapan and W. Sullivan, "Unravelling tangled graphs." *Journal of Knot Theory and its Ramifications*, **20:7**, 2012.
- [3] L. Kauffman and S. Lambropoulou, "On the classification of rational tangles." *Advances in Applied Mathematics*, **33(2)**:199-237, 2004.
- [4] A. Kawachi, "Hyperbolic imitation of 3-manifolds." *Osaka Journal of Mathematics*, **26**: 447-464, 1989.
- [5] S. Kinoshita, "On Elementary Ideals of Polyhedra in the 3-sphere." *Pacific J. Math*, **42**: 89-98, 1972.
- [6] F. Li, J. Clegg, L. Lindoy, R. Macquart, and G. Meehan, "Metallosupramolecular self-assembly of a universal 3-ravel." *Nature Communications*, **2**: February 2011.
- [7] P. Orlik, E. Vogt, and H. Zieschang, "Zur Topologie gefaserner dreidimensionaler Mannigfaltigkeiten." *Topology*, **6** 49-64, 1967.

- [8] J. Sawollek, “Embeddings of 4-regular graphs into 3-space.” *Journal of Knot Theory and its Ramifications*, **6**: 727–749, 1997.
- [9] H. Schubert, “Die eindeutige Zerlegbarkeit eines knots in prime knoten.” *S. B. Heidelberger Akad. Wiss. Math. Natur. Kl.*, 57-104, 1949.
- [10] H. Schubert, “Knoten mit zwei brücken.” *Math. Z.*, **65**: 133-170, 1956.
- [11] S. Suzuki, “Almost Unknotted θ_n graphs in the 3-sphere.” *Kobe J. Math*, **1** 19-22, 1984.
- [12] M. Thistlethwaite, “A spanning tree expansion of the Jones polynomial.” *Topology*, **26:3** 297-309, 1987.
- [13] K. Wolcott. *The Knotting of Theta-Curves and Other Graphs in S^3* . PhD thesis, University of Iowa, May 1986.
- [14] Y. Q. Wu, “Minimally knotted embeddings of planar graphs.” *Math Z.*, **214** 653-658, 1993.

DEPARTMENT OF MATHEMATICS, POMONA COLLEGE, CLAREMONT, CA 91711, USA

DEPARTMENT OF MATHEMATICS, UNIVERSITY OF TEXAS, AUSTIN, TX 78712, USA