

The Interface of the FK-representation of the Quantum Ising Model Converges to the $SLE_{16/3}$

Jhih-Huang Li

Abstract

We study the interface in the FK-representation of the 1D quantum Ising model and show that in the limit, it converges to the $SLE_{16/3}$ curve.

Contents

1	Introduction	2
2	Preliminaries	6
2.1	Semi-discrete lattice	6
2.2	Semi-discretization of a continuous domain	8
2.3	Quantum Ising model and loop representation	9
2.4	Main result	12
3	Semi-discrete complex analysis	12
3.1	Basic definitions	13
3.1.1	Derivatives	13
3.1.2	Integration on primal and dual lattices	15
3.1.3	Integration of a pair of functions	17
3.2	Brownian motion, harmonic measure and Laplacian	18
3.3	Dirichlet boundary problem	23
3.4	Green's function	24
3.4.1	Construction and properties	24
3.4.2	Link with Brownian motion	29
3.5	Harnack Principle and convergence theorems	31
3.6	Convergence to the continuum Dirichlet problem	35
3.7	S-holomorphicity	35

4	Observable on semi-discrete lattice	37
4.1	Definition and illustration	37
4.2	Relations and holomorphicity	39
4.3	Primitive of \mathcal{F}_δ^2	42
5	Uniform convergence theorem	45
5.1	Boundary modification trick	45
5.2	Riemann-Hilbert boundary value problem	47
5.3	Convergence theorem	48
5.4	RSW property: random-current representation	50
5.5	Conclusion: proof of the main Theorem	55
A	Computation of residues	55
	References	58

1 Introduction

The quantum Ising model on \mathbb{Z} is an exactly solvable one-dimensional quantum model [Pfe70]. It can be represented as the space-time evolution of a spin configuration, first introduced in [AKN93]. Specifically, consider an initial configuration on the base graph \mathbb{Z} , and let it evolve according to the following quantum Hamiltonian,

$$H = -\mu \sum_{(x,y) \in E} \sigma_x^{(3)} \sigma_y^{(3)} - \lambda \sum_{x \in V} \sigma_x^{(1)}$$

where the Pauli matrices are denoted by

$$\sigma^{(1)} = \begin{pmatrix} 0 & 1 \\ 1 & 0 \end{pmatrix}, \quad \sigma^{(3)} = \begin{pmatrix} 1 & 0 \\ 0 & -1 \end{pmatrix}, \quad (1.1)$$

which act on the spin configuration at each coordinate, indicated by the subscript.

The quantum Hamiltonian acts on the Hilbert space $\otimes_{\mathbb{Z}} \mathbb{C}^2$ where a Hilbert space of spin configuration $\mathbb{C}^2 \cong \text{Vect}(|+\rangle, |-\rangle)$ is associated to each $x \in \mathbb{Z}$. We may represent $|+\rangle = (1, 0)$ and $|-\rangle = (0, 1)$ for example. In the Hamiltonian, λ and μ are two positive parameters where μ is the interaction term between particles at neighboring sites and λ is the intensity of the external field.

The model can also be seen as a space-time evolution, consisting in developing the exponential operator $e^{-\beta H}$ where β is interpreted as time [AKN93]. In particular, we obtain the FK-representation, loop representation and random-current (random-parity) representation. Readers may have a look at [Iof09] for a nice and complete exposition on this topic. These representations are useful in interpreting results from the classical Ising model [GOS08, BG09, Bjö13].

Let us briefly describe the FK-representation of the model, a bit more details being given in Section 2. In \mathbb{R}^2 , we consider the collection of vertical real lines indexed by \mathbb{Z} , which we denote by $\mathbb{Z} \times \mathbb{R}$. It is called (*primal*) *semi-discrete lattice*

below. We put independent Poisson point processes of parameter λ on each of these real lines whose points are called *death points*. Similarly, we consider the dual of $\mathbb{Z} \times \mathbb{R}$ which is $(\mathbb{Z} + \frac{1}{2}) \times \mathbb{R}$. It can also be seen as a collection of real lines, this time indexed by $\mathbb{Z} + \frac{1}{2}$. We also put independent Poisson point processes on each of the lines, but this time of parameter μ . These points are called *bridges* and we draw at the same level a horizontal segment connecting the two neighboring vertical (primal) lines. See Figure 1.1 for an example. Moreover, these two families of Poisson point processes are taken to be independent one of each other.

Consider a random configuration given by the above Poisson point processes and define the notion of *connectivity*. Two points x and y in the semi-discrete lattice are said to be connected if one can go from one to the other using only primal lines and horizontal bridges without crossing any death points. The *cluster* of a point x is the largest subgraph containing x which is connected in the sense mentioned above. See Figure 1.1 for an illustration.

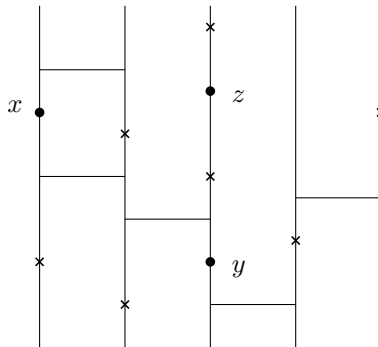

Figure 1.1: Only vertical lines are drawn, which are a part of the primal semi-discrete lattice. Horizontal segments are bridges and crosses are death points. Here, the points x and y are connected to each other but are disconnected from the point z .

Having this notion of connectivity, we can talk about the FK-representation and the loop representation of the quantum Ising model. The FK-representation is obtained by only looking at the clusters in the primal lattice. We are interested in how the points in the primal lattice are connected, and the property of primal clusters. The loop representation is obtained by looking at the clusters in both the primal and the dual lattices. We draw all the interfaces separating them and we get a collection of loops or interfaces, depending on the boundary conditions.

The measure of the quantum Ising model at criticality is given as follows,

$$d\mathbb{P}_{\lambda,\mu}^{\text{QI}}(D, B) \propto 2^{k(D,B)} d\mathbb{P}_{\lambda,\mu}(D, B) \propto \sqrt{2}^{l(D,B)} d\mathbb{P}_{\rho,\rho}(D, B)$$

where $\mathbb{P}_{\lambda,\mu}$ is the law of Poisson point processes described above and $\rho = \sqrt{\lambda\mu}$. Here, D and B are (random) sets of death points and bridges respectively. Given a configuration of Poisson points (D, B) , the quantity $k(D, B)$ denotes the number of clusters in the FK-representation (on the primal lattice) and $l(D, B)$ denotes the number of loops in the loop representation (on the mid-edge lattice).

The interface in the FK-representation of the classical Ising model has been shown to be conformally invariant [Smi06, Smi10, DCS12, CS12] and the limiting

curve can be identified with $\text{SLE}_{16/3}$ [CDCH⁺14]. Therefore, the same should also hold for the interface in the FK-representation / loop representation of the quantum Ising model.

In order to state the theorem, let us recall a few more important notions. We consider a Dobrushin domain (Ω, a, b) , *i.e.* an open, bounded and simply connected set with two marked points on the boundary a and b . For every positive δ , we can semi-discretize it by a subgraph $(\Omega_\delta, a_\delta, b_\delta)$ of the semi-discrete medial lattice $\frac{\delta}{2}\mathbb{Z} \times \mathbb{R}$. We shall look at the so-called *Dobrushin boundary condition*, consisting of wired boundary condition on the arc $(a_\delta b_\delta)$ and free boundary condition on the arc $(b_\delta a_\delta)$. In this case, the loop representation gives rise to a collection of loops and one interface connecting a_δ to b_δ , separating the (primal) cluster connected to the wired arc and the (dual) cluster connected to the free arc.

In this paper, we prove the conformal invariance of the quantum Ising model by showing that the limit of interfaces when δ goes to 0 is conformally invariant. This is the first quantum model proved to have such a property. Here is the informal statement of our main theorem, the more precised version will be given in Theorem 2.1.

Theorem. Let (Ω, a, b) be a Dobrushin domain. Let $(\Omega_\delta, a_\delta, b_\delta)$ be its semi-discretized counterparts. Define the FK-representation of the quantum Ising model on $(\Omega_\delta, a_\delta, b_\delta)$ and denote by γ_δ the interface separating the (primal) wired boundary and the (dual) free boundary. When δ goes to zero, the interface γ_δ converges to the chordal Schramm-Löwner Evolution of parameter 16/3 in (Ω, a, b) .

The proof is made possible by the similarity between the FK-representations of the quantum and the classical Ising models. The FK-representation and the loop representation of the quantum model can be interpreted as the same representations of the classical model living on a more and more flattened rectangular lattice. Thus, the proof almost comes from the same arguments as in the so-called isoradial case, except that some notions need to be adapted to the semi-discrete case.

Intuitively, using the universality of the classical Ising model [CS12] on isoradial graphs would require an inversion of limits:

- On one hand, the universality result says that the classical FK-Ising model on a ε -flattened (where ε is the flattened angle) isoradial rectangular lattice of meshsize δ has an interface which is conformally invariant in the limit $\delta \rightarrow 0$, provided that the angle ε is kept unchanged. In this first approach, the lattice “converges” to the whole plane uniformly in all directions.
- On the other hand, if we put the classical FK-Ising on a ε -flattened δ -isoradial rectangular lattice with flatter and flatter rectangles by making ε go to 0, we would get continuous lines in the vertical direction, which is exactly the FK-representation of the quantum Ising model. Therefore, to get the conformal invariance of the interface in the quantum FK-Ising, we would need to make δ go to 0, the distance between two neighboring vertical

lines. In this second approach, the lattice “converges” to the whole plane first in the vertical direction, then in the horizontal one.

The heuristic described above suggests strongly that the FK-representation of the quantum Ising model should also be conformally invariant in the limit, and that the interface in the limit should be the same as in the classical case. However, one should make this argument mathematically rigorous, and that is why we work directly in the semi-discrete case.

In this paper, some classical notions need to be generalized and new tools be constructed. We will define the Green’s function on the semi-discrete lattice, give the notion of s -holomorphicity, show that the fermionic observable is s -holomorphic and give a proof of RSW property by the second moment method. Everything is defined directly in the semi-discrete. Sometimes, it will be easy to see the parallel with the discrete isoradial case, but sometimes it will be a bit more tricky.

Other results concerning the conformal invariance from the classical Ising model are also expected to have their counterparts in the quantum case. For instance, the following results should be extendable. Using fermionic spinor, Hongler and Smirnov proved the conformal invariance of the energy density in the planar Ising model [HS13]. Chelkak, Hongler and Izyurov showed that the magnetization and multi-spin correlations are conformally invariant in the scaling limit [CHI15]. Recently, Hongler and Benoist gave a proof that the collection of critical Ising loops converges to CLE(3), Conformal Loop Ensemble [BH16].

In this paper, we work directly on the semi-discrete graph to establish the conformal invariance of the interface in the FK-representation of the quantum Ising model and identify it. This paper is divided as follows.

- In Section 2, we define the quantum Ising model properly and describe its geometrical representation in details.
- In Section 3, the semi-discrete complex analysis is introduced. In particular, we define a notion of s -holomorphicity, differential operators and integration which are analogous to the continuum ones. We also study counterparts of some classical objects and problems, *e.g.* Brownian motion and Dirichlet boundary problem. Moreover, we construct the Green’s function via auxiliary functions inspired by [Ken02], which is the main novel input of this part of the paper.
- In Section 4, we define the (para-)fermionic observable \mathcal{F}_δ in the FK-representation and show that it is s -holomorphic. This is the first step towards the conformal invariance of the interface.
- In Section 5, we show the convergence theorem and identify the interface in the limit with an SLE curve. We need to use the tools established in Section 3. In addition, we prove the *RSW property* by the second moment method inspired from [DCHN11].

Bibliographical remark. The content of Section 4 appeared recently in [Bjö16] where s-holomorphicity is defined for the semi-discrete lattice. The notion therein is formulated differently but is equivalent to the one we use in this paper. A global review of the quantum Ising model is also given along with different representations. It is also shown that in both the spin-representation and FK-representation, the fermionic observable satisfies the property of s-holomorphicity. A brief idea of the proof towards conformal invariance of the interface is mentioned but the formal proof is not given there.

Acknowledgements

This research is supported by the NCCR SwissMAP, the ERC AG COMPASP, and the Swiss NSF. The author is thankful to his advisors Hugo Duminil-Copin and Stanislav Smirnov for their help and constant support during his PhD.

2 Preliminaries

2.1 Semi-discrete lattice

The *semi-discrete lattice* is defined by the Cartesian product $\mathbb{Z} \times \mathbb{R}$. It can be seen as a collection of *vertical lines* \mathbb{R} indexed by \mathbb{Z} with *horizontal edges* connecting neighboring vertical lines with the same y -coordinate. In our graphical representation, horizontal edges are not drawn for simplicity.

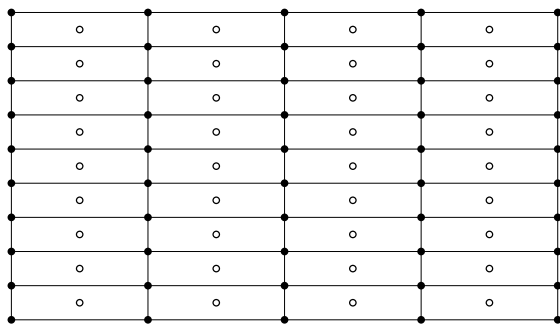

Figure 2.1: Black vertices and edges represent (a part of) a flattened rectangular lattice and white vertices its dual.

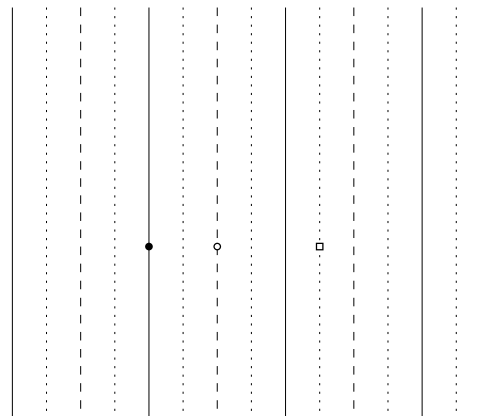

Figure 2.2: Solid lines represent \mathbb{L}_δ , dashed lines represent \mathbb{L}_δ^* and dotted lines represent \mathbb{L}_δ^b .

If we are given a discrete planar (isoradial) graph, it is easy to define its dual, medial and mid-edge graphs. This will be the same for $\mathbb{Z} \times \mathbb{R}$, using the fact that it can be seen as the “limit” of a more and more flattened rectangular lattice $\mathbb{Z} \times \varepsilon\mathbb{Z}$ as illustrated in Figure 2.1. The faces are crushed together so that vertically, the notion of being neighbors gets degenerated. We will only call neighbors two sites

whoses x -coordinates differ by 1. More details will be given below in a general setting.

Take $\delta > 0$. We will define here the following notions related to the *semi-discrete lattice with mesh size δ* : primal, dual, medial and mid-edge lattices. Formal definitions are given below and to visualize them, we refer to Figure 2.2.

Let \mathbb{L}_δ be the semi-discrete primal lattice $\delta\mathbb{Z} \times \mathbb{R}$. We denote by \mathbb{L}_δ^* , the lattice $\delta(\mathbb{Z} + \frac{1}{2}) \times \mathbb{R}$ with the same notion of connectivity as $\delta\mathbb{Z} \times \mathbb{R}$, the *dual* of \mathbb{L}_δ . We can notice that the dual lattice is isomorphic to the primal one, by translation of $\frac{1}{2}$ in the x -coordinate. As in the discrete setup, the dual lattice is given by the center of faces in the primal lattice, and edges by connecting two primal faces sharing a common edge. Since the faces of \mathbb{L}_δ are all crushed together vertically, the same happens to vertically-ordered dual vertices, giving us continuous lines isomorphic to \mathbb{R} .

The equivalent of the medial lattice from the discrete setup by taking the mid-points of neighboring primal-primal and dual-dual vertices gives us $\mathbb{L}_\delta^\diamond = \mathbb{L}_\delta \cup \mathbb{L}_\delta^*$. It is again isomorphic to the primal or dual lattice by scaling of factor $\frac{1}{2}$.

Finally, we take the middle of the two previous lattices to obtain the *mid-edge lattice* $\delta(\frac{1}{2}\mathbb{Z} + \frac{1}{4}) \times \mathbb{R}$, denoted by \mathbb{L}_δ^b . It is isomorphic to the medial lattice.

In the following graphical presentations, we will draw a filled black dot to represent a vertex on the primal lattice, a filled white dot a vertex on the dual lattice, and a filled white square when it is a mid-edge, or more precisely, the middle of the mid-edge. See Figure 2.2.

We need to define some more notions related to the semi-discrete lattice \mathbb{L}_δ , including segments, paths and domains.

A *primal vertical segment* is denoted by $[\delta k + i a, \delta k + i b] := \{\delta k\} \times [a, b]$, where $k \in \mathbb{Z}$ and $a < b$ are real numbers. A *primal horizontal segment* is denoted by $[\delta k + i a, \delta l + i a] := ([\delta k, \delta l] \times \{a\}) \cap \mathbb{L}_\delta = \{\delta j + i a, k \leq j \leq l\}$ where $k < l$ are integers and a is a real number. When a primal horizontal segment is of length δ , we call it a *primal segment*.

A sequence of points $(z_i)_{0 \leq i \leq n}$ on \mathbb{L}_δ forms a *path* if the consecutive points share the same y -coordinate (forming horizontal segments) or the same x -coordinate (forming vertical segments).

A *primal domain* is a finite region delimited by primal horizontal and dual segments. More precisely, it is given by a self-avoiding path consisting of $2n + 1$ points z_0, z_1, \dots, z_{2n} on \mathbb{L}_δ such that

1. $[z_{2i}, z_{2i+1}]$ are horizontal segments for $i \in \llbracket 0, n - 1 \rrbracket$;
2. $[z_{2i+1}, z_{2i+2}]$ are vertical segments for $i \in \llbracket 0, n - 1 \rrbracket$;
3. these points form a closed path, *i.e.* $z_0 = z_{2n}$.

The set consisting of segments $\partial = \{[z_{2i}z_{2i+1}], [z_{2i+1}, z_{2i+2}], i \in \llbracket 0, n - 1 \rrbracket\}$ separates the plane into two connected *open* components, a bounded one which is simply connected and an unbounded one. The first one is called the *domain* and is usually denoted by Ω_δ . And ∂ , or $\partial\Omega$, is called the *boundary* of Ω . Except otherwise mentioned, the points z_i are ordered counterclockwisely.

These same definitions apply to the dual lattice \mathbb{L}_δ^* to get a *dual domain*, usually denoted by Ω_δ^* , or to the medial lattice to get a *medial domain*, Ω_δ° .

The *interior* of a primal domain Ω_δ , denoted by $\text{Int}\Omega_\delta$, is the largest dual domain contained in Ω_δ . It can also be seen as the set of dual vertices in Ω_δ having both (primal) neighbors inside Ω_δ . Similarly, the *interior* of a dual domain Ω_δ^* or a medial domain Ω_δ° , denoted by $\text{Int}\Omega_\delta^*$ or $\text{Int}\Omega_\delta^\circ$, can also be defined in a similar way by replacing the word “primal” by “dual” or “medial”.

Now we define a *semi-discrete Dobrushin domain*, which is a medial domain with so-called *Dobrushin boundary condition*. Given $(a_w a_b)$ and $(b_b b_w)$ two horizontal edges, consider a primal path from a_b to b_b and a dual path from b_w to a_w , such that the concatenation of both (first primal then dual) forms a counter-clockwise boundary. We denote ∂_{ab} and ∂_{ba}^* the primal and dual parts. See Figure 2.3.

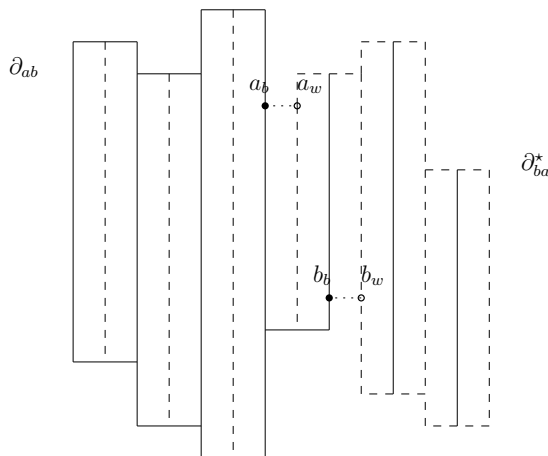

Figure 2.3: A Dobrushin domain.

2.2 Semi-discretization of a continuous domain

A set in \mathbb{R}^2 , or \mathbb{C}^2 , is called a *domain* if it is open, bounded and simply connected. A *Dobrushin domain* is a domain with two different marked points a, b on the boundary. It is often denoted by a triplet (Ω, a, b) where Ω is a domain and $a, b \in \partial\Omega$.

Here, we explain how to *semi-discretize* such a domain to get its semi-discrete counterpart, on which the FK-representation of the quantum Ising model will be defined. Consider (Ω, a, b) a Dobrushin domain in \mathbb{C} or \mathbb{R}^2 and $\delta > 0$. Let us denote by $[a_\delta^w a_\delta^b]$ and $[b_\delta^b b_\delta^w]$ two mid-edges with $a_\delta^b, b_\delta^b \in \mathbb{L}_\delta$, $a_\delta^w, b_\delta^w \in \mathbb{L}_\delta^*$ and mid-points a_δ^b and b_δ^b given by minimizing the distances between a and a_δ^b and between b and b_δ^b over all possible such mid-edge segments contained in Ω . Once we get these two distinguished edges $[a_\delta^w a_\delta^b]$ and $[b_\delta^b b_\delta^w]$, we complete the semi-discrete domain by making approximation with primal horizontal and vertical segments on the arc $(a_\delta b_\delta)$ then with dual horizontal and vertical segments on the arc $(b_\delta a_\delta)$. This domain is denoted by $(\Omega_\delta^\circ, a_\delta, b_\delta)$. It lies in $\text{Int}\Omega$. See Figure 2.4 for an example.

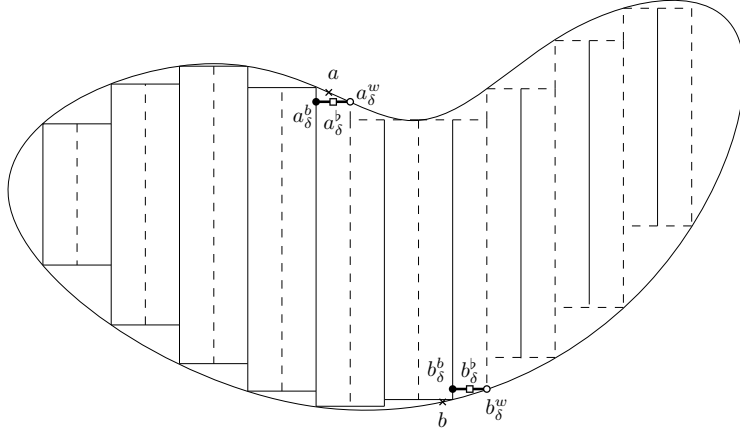

Figure 2.4: An example of approximation of a continuous Dobrushin domain by a semi-discrete one with mesh size δ .

We write $\partial\Omega_\delta^\diamond$ for the boundary of this Dobrushin domain. This consists of four components:

$$\begin{aligned}
 [a_\delta^w a_\delta^b] & \text{ an horizontal edge} \\
 (a_\delta b_\delta) & := (a_\delta^b b_\delta^b) \text{ the arc going from } a_\delta^b \text{ to } b_\delta^b \\
 [b_\delta^b a_\delta^w] & \text{ an horizontal edge} \\
 (b_\delta a_\delta) & := (b_\delta^w a_\delta^w) \text{ the arc going from } b_\delta^w \text{ to } a_\delta^w .
 \end{aligned}$$

They are ordered counterclockwise in Figure 2.4.

2.3 Quantum Ising model and loop representation

On the semi-discrete medial Dobrushin domain $(\Omega_\delta^\diamond, a_\delta, b_\delta)$, one can define the *continuum Bernoulli percolation with parameters* (λ, μ) for $\lambda, \mu > 0$.

Consider two families of open intervals by taking the intersection between the interior of the domain Ω^\diamond and vertical primal or dual segments,

$$\begin{aligned}
 \mathcal{I}_\delta & := \text{Int}\Omega_\delta^\diamond \cap \mathbb{L}_\delta, \\
 \mathcal{I}_\delta^* & := \text{Int}\Omega_\delta^\diamond \cap \mathbb{L}_\delta^*.
 \end{aligned}$$

We take two independent (one-dimensional) Poisson point processes of parameters λ and μ on \mathcal{I}_δ and \mathcal{I}_δ^* respectively. We denote by (D, B) such a configuration, where D contains the points in \mathcal{I}_δ and B the points in \mathcal{I}_δ^* . The points in D are called *death points*. They cut vertical lines into disjoint (primal) segments. The points in B are called *bridges*. They create horizontal connections between two neighboring vertical segments. See Figure 2.5 for an example.

Given a configuration of continuum Bernoulli percolation (D, B) , we can define the notions of *primal (or dual) connectivity* with respect to the points in these two sets.

Two points in the primal domain are said to have a *primal connection* if there is a primal path going from one to another by taking primal vertical segments and horizontal bridges without crossing any death points. The notion of having

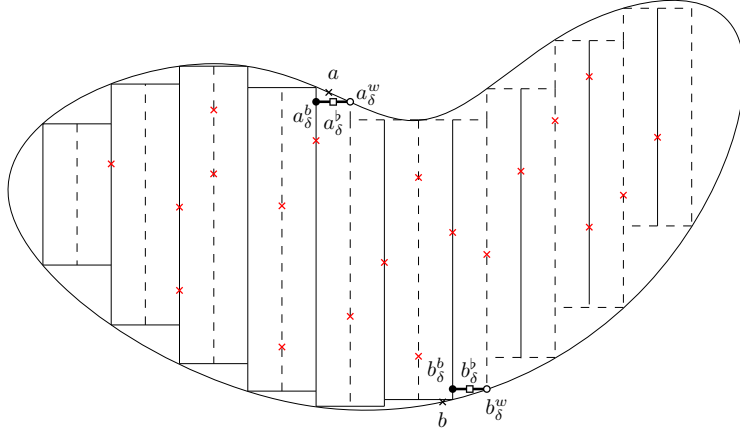

Figure 2.5: Example of a random configuration. Red crosses are points given by Poisson point processes.

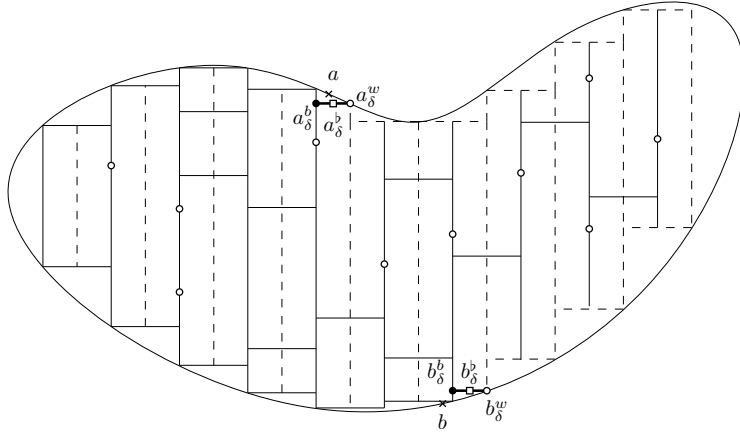

Figure 2.6: Representation with death points (red crosses on primal vertical lines) and bridges (red crosses on dual vertical lines) of the above configuration.

a *dual connection* is similar by taking the dual graph, inverting primal and dual segments and death points and bridges. More precisely, two points in the dual domain are said to have a *dual connection* if there is a path going from one to another by taking dual lines and death points without crossing any bridges.

In the following, except otherwise mentioned, the connectivity always refers to the primal domain. We call (*primal*) *connected component* of $v \in \mathbb{L}_\delta$ a maximal collection (in terms of set) in $\text{Int}\Omega_\delta^\circ$ containing connected (primal) segments and bridges. It is sometimes called *cluster* as well.

As in the discrete setup, this model has a *loop representation* too. A simple closed path living on the mid-edge lattice \mathbb{L}_δ^b is called a *loop*. To get this representation, we just need to go through a simple operation: replace the pieces of our domain according to the rules explained in Figure 2.7.

We notice that if we consider a Dobrushin domain, then we get a collection of loops surrounding either a primal or a dual connected component together with an interface connecting a^b to b^b . This is illustrated in Figure 2.8.

Let us denote by $\mathbb{P}_{\lambda,\mu}$ the law of the continuum Bernoulli percolation in the Dobrushin domain $(\Omega_\delta^\circ, a_\delta, b_\delta)$. We may also simply write \mathbb{P} if the omitted parameters

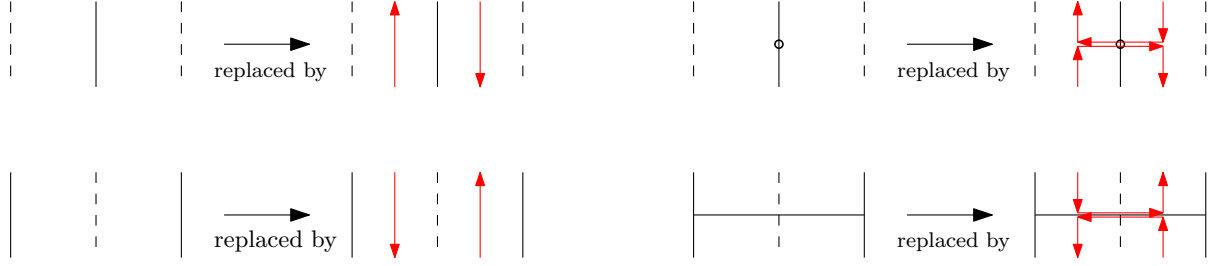

Figure 2.7: Transformation to get a loop representation from a continuum Bernoulli percolation.

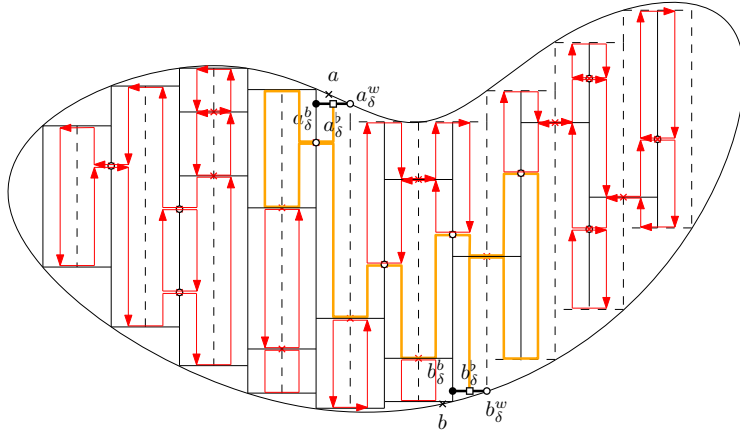

Figure 2.8: The loop representation corresponding to the configuration of Figure 2.5. Loops surrounding primal or dual clusters are in red where as the interface connecting a_δ^b to b_δ^b is in orange.

are clear.

Given $q \geq 1$, we will define the measure of the *continuum FK-representation of parameter q* , denoted by $d\mathbb{P}_{q,\lambda,\mu}$ by weighing configurations according to the number of connected components they have. More precisely, we have the following proportionality between probability densities:

$$d\mathbb{P}_{q,\lambda,\mu}(D, B) \propto q^{k(D,B)} d\mathbb{P}_{\lambda,\mu}(D, B)$$

where $k(D, B)$ denotes the number of primal connected components, or clusters, in a given configuration (D, B) . To make sense of this, we have to check that the partition function given below is finite:

$$Z_{\lambda,\mu,q} = \int q^{k(D,B)} d\mathbb{P}_{\lambda,\mu}(D, B).$$

In fact, a bridge only decreases the number of clusters whereas a death point increases it by at most one. So the number of clusters is bounded by the number of death points from above. As a consequence,

$$Z_{\lambda,\mu,q} \leq \int q^{|D|} d\mathbb{P}_{\lambda,\mu} = \sum_{n=0}^{\infty} q^n \frac{(\lambda C)^n}{n!} e^{-\lambda C} = e^{(q-1)\lambda C}$$

where C is the one-dimensional Lebesgue measure of Ω_δ . This quantity is finite (depending on δ) since the domain Ω_δ is bounded.

Thus, the measure $\mathbb{P}_{q,\lambda,\mu}$ is well-defined and it makes sense to work with the FK-representation. In this article, we will only be interested in the case where $q = 2$, a model that we now call the *FK-representation of the quantum Ising model*. Its measure $\mathbb{P}_{2,\lambda,\mu}$ can also be written as $d\mathbb{P}_{\lambda,\mu}^{\text{QI}}$. Its critical parameters are given by the relation $\mu/\lambda = 2$ [Pfe70, BG09].

We may also write the measure in terms of the loop representation introduced above. To do so, we consider both primal and dual clusters, each of whom gives rise to a loop. By a simple computation at criticality, we get the following relation:

$$d\mathbb{P}_{\lambda,\mu}^{\text{QI}}(D, B) \propto \sqrt{2}^{l(D,B)} d\mathbb{P}_{\rho,\rho}(D, B) \quad (2.1)$$

where $l(D, B)$ denotes the number of loops in a given configuration (D, B) and $\rho = \sqrt{\lambda\mu}$.

2.4 Main result

We are ready to give a formal statement of the main theorem.

Theorem 2.1. *Let (Ω, a, b) a Dobrushin domain. For $\delta > 0$, semi-discretize the domain to get a semi-discrete Dobrushin domain $(\Omega_\delta^\circ, a_\delta, b_\delta)$ and consider the FK-representation of the critical quantum Ising model on it. Consider the interface γ_δ going from a_δ to b_δ in $(\Omega_\delta^\circ, a_\delta, b_\delta)$. The law of γ_δ converges weakly to the chordal Schramm-Löwner Evolution $\text{SLE}_{16/3}$ running from a to b in Ω .*

3 Semi-discrete complex analysis

In this section, we establish the main tool of our study: the semi-discrete complex analysis. Most of the time, the notions in the classical case or isoradial case [BMS05, CS11, BG15] can be generalized easily, such as derivatives, holomorphicity and harmonicity (Section 3.1.1), Brownian motion (Section 3.2), Dirichlet boundary problem (Section 3.3) and other related objects. However, semi-discrete holomorphic functions require more care.

The integration on a primal or dual lattice of a semi-discrete function can also be defined similarly (Section 3.1.2). A minor difficulty could arise when it comes to integrating the product of two semi-discrete functions. We will explain in Section 3.1.3 how to define this so that to have expected properties as in the continuous setting.

We shall also construct the Green's function in the semi-discrete case (Section 3.4). This can be done by modifying the approach from [Ken02], which makes use of discrete exponential functions.

The notion of *s-holomorphicity* will also be introduced in Section 3.7, which is quite important in the rest of the paper to define the observable (Section 4) and show its convergence (Section 5).

3.1 Basic definitions

3.1.1 Derivatives

Let Ω_δ be a primal semi-discrete domain. A function f defined on Ω_δ is said to be *continuous* if $y \mapsto f(x, y)$ is continuous for all $x \in \{x, (x, y) \in \Omega_\delta\}$. The same definition applies to functions defined on a dual domain Ω_δ^* , a medial domain Ω_δ° or a mid-edge domain Ω_δ^b . We then define in the same way a differentiable function on these domains, or even \mathcal{C}^k functions, by demanding the property on all the vertical intervals.

Given a vertex $p \in \mathbb{L}_\delta^\circ$, we denote by p^\pm the right and left neighboring vertices in \mathbb{L}_δ° , *i.e.* $p^\pm := p \pm \frac{\delta}{2}$ in an algebraic way. Similarly, we may write $e^\pm := e \pm \frac{\delta}{2}$ for neighboring mid-edge vertices of $e \in \mathbb{L}_\delta^b$.

If $p \in \mathbb{L}_\delta^\circ$, we denote by e_p^\pm the right and the left neighboring mid-edges, or $e_p^\pm := p \pm \frac{\delta}{4}$. In the same way, given a mid-edge $e \in \mathbb{L}_\delta^b$, we denote by p_e^\pm the right and the left neighboring medial vertices, or $p_e^\pm := e \pm \frac{\delta}{4}$.

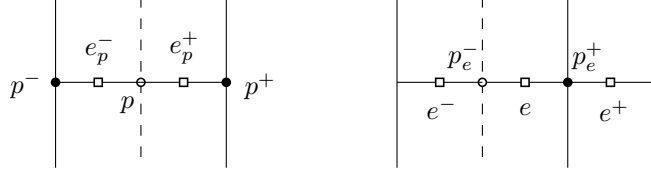

Figure 3.1: Illustration of the definitions above. *Left*: neighboring mid-edges and vertices of a vertex. *Right*: neighboring vertices and mid-edges of a mid-edge.

For $e \in \mathbb{L}_\delta^b$, we may also write u_e (*resp.* w_e) the neighboring primal (*resp.* dual) vertex. In other words,

$$\begin{aligned} \{u_e\} &= \{p_e^+, p_e^-\} \cap \mathbb{L}_\delta, \\ \{w_e\} &= \{p_e^+, p_e^-\} \cap \mathbb{L}_\delta^*. \end{aligned}$$

See Figure 3.2 for an illustration.



Figure 3.2: Illustration of the neighboring primal and dual vertices.

The derivative $D^{(\delta)}$ or the anti-derivative $\overline{D}^{(\delta)}$ of a differentiable function on \mathbb{L}_δ° or \mathbb{L}_δ^b can be defined by taking the “semi-discrete counterpart”. Thus, the notion of holomorphicity and harmonicity will be defined in the same way.

Definition 3.1. Let $f : \mathbb{L}_\delta^\circ \rightarrow \mathbb{C}$ be a complex function defined on the medial lattice. Let $p \in \mathbb{L}_\delta^\circ$. The *x-derivative* at p is given by

$$\Delta_x^{(\delta)} f(p) := \frac{f(p^+) - f(p^-)}{\delta}.$$

If $p \in \mathbb{L}_\delta^\diamond$, we define the *second x -derivative* at p by

$$\Delta_{xx}^{(\delta)} f(p) := \Delta_x^{(\delta)} \circ \Delta_x^{(\delta)} f(p) = \frac{f(p^{++}) + f(p^{--}) - 2f(p)}{\delta^2}$$

where $p^{++} = (p^+)^+$ and $p^{--} = (p^-)^-$.

Definition 3.2. Let $f : \mathbb{L}_\delta^\diamond \rightarrow \mathbb{C}$ be a differentiable complex function defined on a medial lattice $\mathbb{L}_\delta^\diamond$. Its *derivative* and *anti-derivative* at $p \in \mathbb{L}^\diamond$ are given by

$$D^{(\delta)} f(p) = \frac{1}{2} \left[\Delta_x^{(\delta)} f(p) + \frac{\partial_y f(p)}{i} \right] = \frac{1}{2} \left[\frac{f(p^+) - f(p^-)}{\delta} + \frac{\partial_y f(p)}{i} \right], \quad (3.1)$$

$$\overline{D}^{(\delta)} f(p) = \frac{1}{2} \left[\Delta_x^{(\delta)} f(p) - \frac{\partial_y f(p)}{i} \right] = \frac{1}{2} \left[\frac{f(p^+) - f(p^-)}{\delta} - \frac{\partial_y f(p)}{i} \right]. \quad (3.2)$$

A semi-discrete function f is said to be *holomorphic at* $p \in \mathbb{L}_\delta^\diamond$ if $\overline{D}^{(\delta)} f(p) = 0$, and is said to be *holomorphic in* Ω_δ^\diamond , where Ω_δ^\diamond is a medial domain, if $\overline{D}^{(\delta)} f(p) = 0$ for all $p \in \text{Int}\Omega_\delta^\diamond$.

The same definitions (3.1) and (3.2) could also be used for functions defined on mid-edge domains. Let $f : \mathbb{L}_\delta^\flat \rightarrow \mathbb{C}$ be a differentiable complex function defined on the mid-edge lattice, then

$$D^{(\delta)} f(e) = \frac{1}{2} \left[\frac{f(e^+) - f(e^-)}{\delta} + \frac{\partial_y f(e)}{i} \right], \quad (3.3)$$

$$\overline{D}^{(\delta)} f(e) = \frac{1}{2} \left[\frac{f(e^+) - f(e^-)}{\delta} - \frac{\partial_y f(e)}{i} \right]. \quad (3.4)$$

Consider a twice differentiable function f defined on a primal (or dual) lattice. We can define its *Laplacian* by

$$\Delta^{(\delta)} f := 4D^{(\delta)} \overline{D}^{(\delta)} f = 4\overline{D}^{(\delta)} D^{(\delta)} f = \Delta_{xx}^{(\delta)} f + \partial_{yy} f. \quad (3.5)$$

A twice differentiable function f defined on the primal domain Ω_δ is said to be

- *harmonic* if $\Delta^{(\delta)} f(p) = 0$, for all $p \in \text{Int}^2\Omega_\delta$;
- *subharmonic* if $\Delta^{(\delta)} f(p) \geq 0$, for all $p \in \text{Int}^2\Omega_\delta$;
- *superharmonic* if $\Delta^{(\delta)} f(p) \leq 0$, for all $p \in \text{Int}^2\Omega_\delta$.

Here, we take twice Int because in the definition of the Laplacian, the second x -derivative is involved. We extend these definitions to a twice differentiable function defined on a dual domain in the same way.

3.1.2 Integration on primal and dual lattices

We now define the notion of integral for a semi-discrete function f living on $\mathbb{L}_\delta^\diamond$. Let $\mathcal{P} = [k\delta + ia, k\delta + ib]$ be a vertical primal (*resp.* dual) segment, meaning that $k \in \mathbb{Z}$ (*resp.* $k \in \mathbb{Z} + \frac{1}{2}$) and $a < b$. If the segment \mathcal{P} is oriented upwards, we write

$$\int_{\mathcal{P}} f(z)dz := i \int_a^b f(\delta k + iy)dy = i \int_a^b f_k(y)dy \quad (3.6)$$

to be the integral along the vertical segment \mathcal{P} , where we define $f_k(\cdot) = f(\delta k + i\cdot)$. Both primal and dual vertical segments are called *medial vertical segments*.

Let $\mathcal{P} = \{\delta k + it, m \leq k \leq n, k \in \mathbb{Z}\}$ a horizontal primal segment for $m, n \in \mathbb{Z}$. We define

$$\int_{\mathcal{P}} f(z)dz := \delta \sum_{k=m}^{n-1} f\left(\delta\left(k + \frac{1}{2}\right) + it\right) = \delta \sum_{k=m}^{n-1} f_{k+\frac{1}{2}}(t) \quad (3.7)$$

the integral along the horizontal primal segment \mathcal{P} oriented to the right. If we have a horizontal dual segment $\mathcal{P} = \{\delta(k + \frac{1}{2}) + it, m \leq k \leq n, k \in \mathbb{Z}\}$, we define in a similar way

$$\int_{\mathcal{P}} f(z)dz := \delta \sum_{k=m+1}^n f(\delta k + it) = \delta \sum_{k=m+1}^n f_k(t) \quad (3.8)$$

the integral along the horizontal dual segment. Both primal and dual horizontal segments are called *medial horizontal segment*.

In both vertical and horizontal cases, we define the integral of a reversed path to be the opposite of the integral of the original path.

The integrals above should be seen as “semi-discrete complex” integrals. More precisely, we take into account the direction in which the segment goes, giving factors $\pm 1, \pm i$. We may also define integration against $|dz|$, removing thus these factors. Moreover, our integrals shall be defined additively.

Given a semi-discrete primal domain Ω_δ and a semi-discrete function f on it, we may write its integral on the domain by

$$\int_{\Omega_\delta} f(y)dy := \delta \sum_{\text{Int}\Omega_\delta} \int_{\alpha_k}^{\beta_k} f_k(y)dy$$

where the sum is taken over all the primal vertical axes in $\text{Int}\Omega_\delta$. Here, the integration against dy should be seen as classical real integration.

An *elementary primal* (*resp.* *dual*) *domain* is given by

$$B_k(\alpha, \beta) = \{x + iy, \delta k \leq x \leq \delta(k+1), \alpha \leq y \leq \beta\}$$

for $\alpha < \beta$ integers and $k \in \mathbb{Z}$ (*resp.* $k \in \mathbb{Z} + \frac{1}{2}$). Its boundary consists of four primal (*resp.* dual) segments, two vertical and two horizontal. By convention, we will always orient the boundary counterclockwise. An *elementary medial domain* is either a primal or a dual elementary domain. In the rest of the article, we denote it by $B_k^\diamond(\alpha, \beta)$.

From integrals along horizontal and vertical segments given by Equations (3.6), (3.7) and (3.8), we can define integrals along the boundary of any primal or dual domain. Let us consider an elementary primal or dual domain $B_k(\alpha, \beta)$ as an example. Denote by \mathcal{C} its boundary oriented counterclockwise. If f is a semi-discrete function which is piece-wise continuous, then its integral along the contour \mathcal{C} is given by

$$\oint_{\mathcal{C}} f(z)dz := \delta [f_{k+\frac{1}{2}}(\alpha) - f_{k+\frac{1}{2}}(\beta)] + i \int_{\alpha}^{\beta} [f_{k+1}(y) - f_k(y)]dy, \quad (3.9)$$

consisting of the four integrals coming from the four sides of the elementary domain. Moreover, if f is piece-wise differentiable, this can be rewritten as where in $\overline{D}^{(\delta)}f$, the term $\partial_y f$ is given in the sense of distributions.

Given a primal semi-discrete domain Ω_{δ} , we define the integral of a semi-discrete function f along its counterclockwise-oriented contour by decomposing its boundary into vertical and horizontal segments and adding them up.

The integral along the contour of a dual domain is defined in a similar way and the corresponding properties can be obtained as well. We notice that here we do not define the integral along the contour of a medial domain. We will see later an alternative definition for this.

Proposition 3.3 (Green's formula). *Consider a primal domain Ω_{δ} . Denote by \mathcal{C} its boundary oriented counterclockwise. Given a semi-discrete function f which is piece-wise differentiable, its integral along the contour \mathcal{C} satisfies the following relation*

$$\oint_{\mathcal{C}} f(z)dz = 2i \int_{\Omega_{\delta}} \overline{D}^{(\delta)} f_{k+\frac{1}{2}}(y)dy.$$

Proof. We decompose the primal or dual domain into elementary ones and sum up the Equation (3.9) corresponding to each of them. In the right hand side, the integrals on boundary parts of elementary domains that appear twice in the sum cancel out, and the only terms that remain sum up to the integral along the contour \mathcal{C} . \square

Define a vector operator $\nabla = (\Delta_x^{(\delta)}, \partial_y)$ called *nabla*. The following statement is similar to Green's formula.

Proposition 3.4 (Divergence theorem). *Let Ω_{δ} be a primal domain with contour \mathcal{C} which is oriented counterclockwise. Let $\vec{F} = (F_x, F_y)$ be a semi-discrete function which is continuous and takes values in \mathbb{R}^2 . We have the following equality,*

$$\int_{\Omega_{\delta}} \nabla \cdot \vec{F}(y)dy = \oint_{\mathcal{C}} \vec{F}(z) \cdot \vec{n}(z)|dz|, \quad (3.10)$$

where $\vec{n}(z)$ is the vector obtained by a rotation of $-\frac{\pi}{2}$ from the tangent vector to \mathcal{C} at z with norm 1.

Proof. As usual, it suffices to show this for an elementary domain, and then sum up over a decomposition of Ω_{δ} into elementary domains. Let $B_k(\alpha, \beta)$ be an

elementary domain. Write $F_{k,x}(\cdot) = F_x(\delta k + i \cdot)$ and $F_{k,y} = F_y(\delta k + i \cdot)$. The left-hand side of Equation (3.10) can be rewritten as

$$\begin{aligned} & \delta \int_{\alpha}^{\beta} (\Delta_x^{(\delta)} F_{k,x} + \partial_y F_{k,y})(y) dy \\ &= \int_{\alpha}^{\beta} (F_{k+\frac{1}{2},x} - F_{k-\frac{1}{2},x})(y) dy + \delta [F_{k,y}(\beta) - F_{k,y}(\alpha)] \end{aligned}$$

which is exactly the right-hand side of Equation (3.10). \square

We notice again that this proposition is still valid even if \vec{F} is only continuous by pieces and differentiable by pieces, as long as we interpret derivatives in the sense of distributions.

3.1.3 Integration of a pair of functions

Here, we define the integration of a pair of functions and establish the equivalent of Green's theorem in the semi-discrete case.

Let us start again with integration on elementary segments. Consider two functions defined on the semi-discrete lattice f and g , a vertical primal (*resp.* dual) segment $\mathcal{P} = [k\delta + ia, k\delta + ib]$ with $k \in \mathbb{Z}$ (*resp.* $k \in \mathbb{Z} + \frac{1}{2}$) and $a < b$. Recall that $f_k(\cdot) = f(k\delta + i \cdot)$. If the segment \mathcal{P} is oriented upwards, we write

$$\int_{\mathcal{P}} [f; g] dz := \int_a^b [f_{k-\frac{1}{2}}(y)g_{k+\frac{1}{2}}(y) - f_{k+\frac{1}{2}}(y)g_{k-\frac{1}{2}}(y)] dy \quad (3.11)$$

to be the integral along \mathcal{P} . If the segment is oriented downwards, we take the opposite of the above quantity.

For $m, n \in \mathbb{Z}$, let $\mathcal{P} = \{k\delta + it, m \leq k \leq n, k \in \mathbb{Z}\}$ be a horizontal primal segment. We define

$$\int_{\mathcal{P}} [f; g] dz := \delta^2 \sum_{k=m}^{n-1} (g_{k+\frac{1}{2}} \partial_y f_{k+\frac{1}{2}} - f_{k+\frac{1}{2}} \partial_y g_{k+\frac{1}{2}})(t) \quad (3.12)$$

the integral along the horizontal primal segment \mathcal{P} , oriented towards the right.

In the same way as integration of a semi-discrete function along the (counterclockwise-oriented) contour of a semi-discrete domain, we define the counterpart of a pair of functions by decomposing the contour into vertical and horizontal segments and adding them up.

Proposition 3.5 (Green's theorem). *Consider a primal (or dual) domain Ω_{δ} . Denote by \mathcal{C} its counterclockwise-oriented boundary. Given two semi-discrete functions f and g which are continuous by pieces and differentiable by pieces in Ω'_{δ} such that $\Omega_{\delta} \subset \text{Int}\Omega'_{\delta}$, we have*

$$\oint_{\mathcal{C}} [f; g] dz = \delta \int_{\Omega_{\delta}} [f_k \Delta^{(\delta)} g_k - g_k \Delta^{(\delta)} f_k](y) dy.$$

Proof. As usual, we start by showing this for an elementary domain since we can superpose these domains to obtain more general domains and the integration terms simplify. Consider $B_{k-\frac{1}{2}}(\alpha, \beta)$ a dual elementary domain and denote \mathcal{C} its contour with counterclockwise orientation. By definition, we have

$$\begin{aligned}
\oint_{\mathcal{C}} [f; g] dz &= \int_{\alpha}^{\beta} [f_k g_{k+1} - f_{k+1} g_k](y) dy - \int_{\alpha}^{\beta} [f_{k-1} g_k - f_k g_{k-1}](y) dy \\
&\quad + \delta^2 [(g_k \partial_y f_k - f_k \partial_y g_k)(t)]_{\beta}^{\alpha} \\
&= \int_{\alpha}^{\beta} [f_k (\delta^2 \Delta_{xx}^{(\delta)} g_k + 2g_k) - g_k (\delta^2 \Delta_{xx}^{(\delta)} f_k + 2f_k)](y) dy \\
&\quad + \delta^2 \int_{\alpha}^{\beta} \partial_y (f_k \partial_y g_k - g_k \partial_y f_k)(t) dt \\
&= \delta^2 \int_{\alpha}^{\beta} [f_k \Delta_{xx}^{(\delta)} g_k - g_k \Delta_{xx}^{(\delta)} f_k](y) dy + \delta^2 \int_{\alpha}^{\beta} (f_k \partial_{yy} g_k - g_k \partial_{yy} f_k)(t) dt \\
&= \delta^2 \int_{\alpha}^{\beta} (f_k \Delta^{(\delta)} g_k - g_k \Delta^{(\delta)} f_k)(y) dy.
\end{aligned}$$

□

3.2 Brownian motion, harmonic measure and Laplacian

Let $\delta > 0$. The standard Brownian motion on the semi-discrete lattice $\mathbb{L}_{\delta} = \delta\mathbb{Z} \times \mathbb{R}$ can be seen as a continuous-time random walk in the horizontal direction; and a standard Brownian motion on \mathbb{R} in the vertical direction. We give a more precise description below.

Definition 3.6. Let $(T_i)_{i \in \mathbb{N}}$ be a family of *i.i.d.* exponential random variables of rate 1 and $(D_i)_{i \in \mathbb{N}}$ be a family of *i.i.d.* uniform random variables taking value in $\{+1, -1\}$. We define

$$S_t = \sum_{i=1}^{N(t)} D_i$$

where

$$N(t) = \sup\{n \in \mathbb{N}, T_1 + \dots + T_n \leq t\}.$$

The continuous-time process $(S_t)_{t \in \mathbb{R}}$ is the *standard continuous-time simple random walk* on \mathbb{Z} .

Remark 3.7. We can easily compute the expectation and variance of S_t which are respectively 0 and t . It also has a good scaling property and one can show that $(\delta S_{t/\delta^2})$ converges to (B_t) in law when δ goes to 0, where (B_t) is a standard one-dimensional Brownian motion. Here, the process $(\delta S_{t/\delta^2})$ can be seen as the continuous-time random walk of parameter $\frac{1}{\delta^2}$ with symmetric jumps $\pm\delta$.

We can now define the *semi-discrete standard Brownian motion* on \mathbb{L}_{δ} .

Definition 3.8. A *semi-discrete standard Brownian motion* on \mathbb{L}_{δ} is given by

$$(B_t^{(\delta)} = (X_t, Y_t) = (\delta S_{t/\delta^2}, B_t))_{t \geq 0}$$

where (S_t) is a standard one-dimensional continuous-time simple random walk and (B_t) is a standard one-dimensional Brownian motion, both of them being independent of each other. The starting point $B_0^{(\delta)}$ is arbitrary, which is given by the starting points of (S_t) and (B_t) .

As in the discrete and continuous cases, we can define the notion of *harmonic measure* via the standard Brownian motion.

Definition 3.9. Given a primal domain Ω_δ and $(B_t^{(\delta)})$ a Brownian motion on Ω_δ starting at some point $(x, y) \in \Omega_\delta$, we define

$$T_{\Omega_\delta} = \inf\{t \geq 0, B_t^{(\delta)} \notin \text{Int}\Omega_\delta\} \quad (3.13)$$

The *harmonic measure* of Ω_δ with respect to (x, y) , denoted by $d\omega_{\Omega_\delta}((x, y), \cdot)$, is the law of $B_{T_{\Omega_\delta}}^{(\delta)}$.

Here, we are interested in the harmonic measure on centered elementary rectangular domains $R_\varepsilon = \{-\delta, 0, \delta\} \times [-\varepsilon, \varepsilon]$. On such domains, the harmonic measure with respect to 0, denoted by ρ_ε , is the sum of two Dirac masses at $\pm i\varepsilon$ and two density measures which are symmetric in both discrete and continuous directions on $\{\pm\delta\} \times [-\varepsilon, \varepsilon]$.

We will write $g_\delta(\varepsilon)$ for the probability that the Brownian motion $B_t^{(\delta)}$ leaves R_ε (the first time) from its left or right sides. This can be expressed by using the harmonic measure on R_ε as follows,

$$g_\delta(\varepsilon) = \int_{-\varepsilon}^{\varepsilon} \rho_\varepsilon(-\delta, y) dy + \int_{-\varepsilon}^{\varepsilon} \rho_\varepsilon(\delta, y) dy. \quad (3.14)$$

Thus, we can write the Dirac masses at $\pm i\varepsilon$ in this way:

$$\rho_\varepsilon(\pm i\varepsilon) = \rho_\varepsilon(0, \pm\varepsilon) = \frac{1 - g_\delta(\varepsilon)}{2} \cdot \delta(\cdot).$$

Definition 3.10. Given a primal domain Ω_δ , a function $f : \Omega_\delta \rightarrow \mathbb{R}$ is said to satisfy the *mean-value property* on rectangles if for all $(x, y) \in \Omega_\delta$ and $\varepsilon > 0$ such that $(x, y) + R_\varepsilon \subset \Omega_\delta$, we have

$$f(x, y) = \mathbb{E}_{(x, y)} \left[f \left(B_{T_{\Omega_\delta}}^{(\delta)} \right) \right]. \quad (3.15)$$

Here, $B_t^{(\delta)}$ is the standard Brownian motion starting at (x, y) and T_{Ω_δ} the stopping time defined in Equation (3.13).

Remark 3.11. In terms of harmonic measure, Equation (3.15) can be reformulated as (without loss of generality, we take $(x, y) = (0, 0)$)

$$\begin{aligned} f(0, 0) &= \int_{\partial R_\varepsilon} f(z) \rho_\varepsilon(z) |dz| \\ &= \int_{-\varepsilon}^{\varepsilon} f(-\delta, y) \rho_\varepsilon(-\delta, y) dy + \int_{-\varepsilon}^{\varepsilon} f(\delta, y) \rho_\varepsilon(\delta, y) dy \\ &\quad + \frac{1 - g_\delta(\varepsilon)}{2} \cdot (f(-i\varepsilon) + f(i\varepsilon)). \end{aligned}$$

Proposition 3.12. *The probability that the Brownian motion $B_t^{(\delta)}$ leaves R_ε (the first time) from the left or right boundary is*

$$g_\delta(\varepsilon) = \frac{\cosh(\sqrt{2\varepsilon}/\delta) - 1}{\cosh(\sqrt{2\varepsilon}/\delta)} = \left(\frac{\varepsilon}{\delta}\right)^2 + \mathcal{O}_\delta(\varepsilon^4)$$

where the asymptotics is given for $\varepsilon \rightarrow 0$.

Proof. Fix $(B_t^{(\delta)} = (\delta S_{t/\delta}, B_t))_{t \geq 0}$ as in Definition 3.8. This probability is exactly $\mathbb{P}[\delta^2 T_1 < \tau]$ where T_1 is an exponential law of parameter 1, which is independent of the stopping time $\tau = \tau_\varepsilon \wedge \tau_{-\varepsilon}$ for the standard 1D Brownian motion. Here

$$\tau_x := \begin{cases} \inf\{t, B_t \geq x\}, & \text{if } x > 0, \\ \inf\{t, B_t \leq x\}, & \text{if } x < 0. \end{cases}$$

By Fubini, we have

$$1 - g_\delta(\varepsilon) = \mathbb{P}[\delta^2 T_1 > \tau] = \mathbb{E}[\mathbb{P}[T_1 > \tau/\delta^2 \mid \tau]] = \mathbb{E}[\exp(-\tau/\delta^2)],$$

which is the Laplace transform of τ .

To calculate this, we notice that the continuous-time process

$$M_t = \exp\left(\sqrt{2}B_t/\delta - t/\delta^2\right)$$

is a martingale with respect to the canonical filtration. Moreover, for the stopping time τ , the process $(M_{t \wedge \tau})_t$ is a martingale bounded by $e^{\sqrt{2\varepsilon}/\delta}$. The stopping time being finite almost surely, we can apply Doob's optional stopping theorem, giving us:

$$\begin{aligned} 1 &= \mathbb{E}[M_0] = \mathbb{E}[M_\tau] \\ &= \frac{1}{2}\mathbb{E}[M_\tau \mid \tau = \tau_\varepsilon] + \frac{1}{2}\mathbb{E}[M_\tau \mid \tau = \tau_{-\varepsilon}] \\ &= \frac{1}{2}\exp\left(\sqrt{2\varepsilon}/\delta\right)\mathbb{E}\left[\exp(-\tau/\delta^2) \mid \tau = \tau_\varepsilon\right] \\ &\quad + \frac{1}{2}\exp\left(-\sqrt{2\varepsilon}/\delta\right)\mathbb{E}\left[\exp(-\tau/\delta^2) \mid \tau = \tau_{-\varepsilon}\right]. \end{aligned} \tag{3.16}$$

Since $(B_t)_t$ and $(-B_t)_t$ are equal in law, we have

$$\mathbb{E}\left[\exp(-\tau/\delta^2) \mid \tau = \tau_\varepsilon\right] = \mathbb{E}\left[\exp(-\tau/\delta^2) \mid \tau = \tau_{-\varepsilon}\right].$$

Moreover,

$$\mathbb{E}\left[\exp(-\tau/\delta^2)\right] = \frac{1}{2}\mathbb{E}\left[\exp(-\tau/\delta^2) \mid \tau = \tau_\varepsilon\right] + \frac{1}{2}\mathbb{E}\left[\exp(-\tau/\delta^2) \mid \tau = \tau_{-\varepsilon}\right],$$

giving

$$\mathbb{E}\left[\exp(-\tau/\delta^2)\right] = \mathbb{E}\left[\exp(-\tau/\delta^2) \mid \tau = \tau_\varepsilon\right] = \mathbb{E}\left[\exp(-\tau/\delta^2) \mid \tau = \tau_{-\varepsilon}\right].$$

Thus, Equation (3.16) becomes

$$1 = \cosh\left(\sqrt{2\varepsilon}/\delta\right) \cdot \mathbb{E}\left[\exp(-\tau/\delta^2)\right],$$

which implies

$$\mathbb{E} \left[\exp(-\tau/\delta^2) \right] = \frac{1}{\cosh(\sqrt{2}\varepsilon/\delta)}$$

and

$$g_\delta(\varepsilon) = 1 - \mathbb{E} \left[\exp(-\tau/\delta^2) \right] = \frac{\cosh(\sqrt{2}\varepsilon/\delta) - 1}{\cosh(\sqrt{2}\varepsilon/\delta)}.$$

□

Proposition 3.13. *Let Ω_δ be a primal domain and $h : \Omega_\delta \rightarrow \mathbb{R}$ be a \mathcal{C}^2 function defined on it. Then the following two statements are equivalent :*

1. h satisfies the mean-value property on elementary rectangles,
2. $\Delta^{(\delta)}h \equiv 0$ on Ω_δ .

Proof. Here, we will show that the point 1 implies the point 2. The converse will be discussed later in Section 3.3.

Consider a function f as in the statement. We will apply the mean-value property at a point of Ω_δ and consider smaller and smaller elementary rectangles to prove the desired property. Let $\varepsilon > 0$ and consider an elementary rectangle R_ε . Let us first approximate the contribution of $\mathbb{E}_0 \left[f \left(B_T^{(\delta)} \right) \right]$ on the left boundary by $h(-\delta, 0)$:

$$\begin{aligned} & \int_{-\varepsilon}^{\varepsilon} h(-\delta, y) \rho_\varepsilon(-\delta, y) dy - \frac{g_\delta(\varepsilon)}{2} \cdot h(-\delta, 0) \\ &= \int_{-\varepsilon}^{\varepsilon} [h(-\delta, y) - h(-\delta, 0)] \rho_\varepsilon(-\delta, y) dy \\ &= \int_{-\varepsilon}^{\varepsilon} [y \partial_y h(-\delta, 0) + E_\varepsilon(-\delta, y)] \rho_\varepsilon(-\delta, y) dy. \end{aligned}$$

The harmonic measure ρ_ε is symmetric in y , thus the integral of $y \partial_y h$ gives zero. The error term can be expressed as follows

$$E_\varepsilon(-\delta, y) = \int_0^y \partial_{yy} h(-\delta, t) (y - t) dt$$

giving the upper bound

$$|E_\varepsilon(-\delta, y)| \leq C \cdot \frac{y^2}{2}, \quad \forall y \in [-\varepsilon, \varepsilon],$$

where $C = \sup \{ \partial_{yy} h(-\delta, y), y \in [-\varepsilon, \varepsilon] \}$. In consequence, we have

$$\begin{aligned} & \left| \int_{-\varepsilon}^{\varepsilon} h(-\delta, y) \rho_\varepsilon(-\delta, y) dy - \frac{g_\delta(\varepsilon)}{2} \cdot h(-\delta, 0) \right| \\ & \leq C \int_{-\varepsilon}^{\varepsilon} \frac{\varepsilon^2}{2} \rho_\varepsilon(-\delta, y) dy = \frac{C\varepsilon^2}{2} \cdot \frac{g_\delta(\varepsilon)}{2}, \end{aligned}$$

allowing us to write

$$\int_{-\varepsilon}^{\varepsilon} h(-\delta, y) \rho_{\varepsilon}(-\delta, y) dy = \frac{g_{\delta}(\varepsilon)}{2} \cdot [h(-\delta, 0) + \mathcal{O}(\varepsilon^2)]. \quad (3.17)$$

Similarly, we also have

$$\int_{-\varepsilon}^{\varepsilon} h(\delta, y) \rho_{\varepsilon}(\delta, y) dy = \frac{g_{\delta}(\varepsilon)}{2} \cdot [h(\delta, 0) + \mathcal{O}(\varepsilon^2)]. \quad (3.18)$$

Combining Equations (3.17) and (3.18) and inserting in (3.15), we get

$$\begin{aligned} 0 &= \frac{g_{\delta}(\varepsilon)}{2} \cdot [h(-\delta, 0) + h(\delta, 0) - 2h(0, 0) + \mathcal{O}(\varepsilon^2)] \\ &\quad + \frac{1 - g_{\delta}(\varepsilon)}{2} \cdot [h(0, \varepsilon) + h(0, -\varepsilon) - 2h(0, 0)] \\ &= \frac{g_{\delta}(\varepsilon)}{2} \cdot [\delta^2 \Delta_{xx}^{(\delta)} h(0, 0) + \mathcal{O}(\varepsilon^2)] + \frac{1 - g_{\delta}(\varepsilon)}{2} \cdot [\varepsilon^2 h_{yy}(0, 0) + \mathcal{O}(\varepsilon^2)]. \end{aligned}$$

We divide everything by ε^2 to get

$$0 = \frac{g_{\delta}(\varepsilon)}{2\varepsilon^2} \cdot [\delta^2 \Delta_{xx}^{(\delta)} h(0, 0) + \mathcal{O}(\varepsilon^2)] + \frac{1 - g_{\delta}(\varepsilon)}{2} \cdot [h_{yy}(0, 0) + \mathcal{O}(1)].$$

When ε goes to 0, we obtain

$$\frac{1}{2} \Delta^{(\delta)} h(0, 0) = \frac{1}{2} \Delta_{xx}^{(\delta)} h(0, 0) + \frac{1}{2} \partial_{yy} h(0, 0) = 0.$$

□

The semi-discrete Laplacian can also be interpreted with the notion of generator. The *generator* of a continuous-time Markov process (X_t, Y_t) is the linear application P such that

$$Pf(x, y) = \lim_{t \rightarrow 0} \frac{\mathbb{E}_{(x,y)}[f(X_t, Y_t)] - f(x, y)}{t}$$

for \mathcal{C}^2 functions $f : \mathbb{R}^2 \rightarrow \mathbb{R}$.

Proposition 3.14. *The generator of $B^{(\delta)}$ is $\frac{1}{2} \Delta_{xx}^{(\delta)} + \frac{1}{2} \partial_{yy}$.*

Proof. We omit the proof here. □

In \mathbb{R}^2 , the generator of the standard 2D Brownian motion is one half of the planar Laplacian, we may also expect the same property between the semi-discrete Brownian motion and Laplacian. It is actually satisfied by the above proposition and Equation (3.5).

3.3 Dirichlet boundary problem

Dirichlet boundary problems are of great importance in discrete and continuous harmonic analysis, which is closely related to the complex analysis. In this section, we establish the Maximum principle and study such problems.

Proposition 3.15 (Maximum principle). *Consider a primal semi-discrete domain Ω_δ . Let u be a subharmonic function defined on Ω_δ , i.e. $\Delta^{(\delta)}u(z) \geq 0$ for all $z \in \text{Int}\Omega_\delta$. Then we have*

$$\sup_{z \in \Omega_\delta} u(z) = \sup_{z \in \partial\Omega_\delta} u(z),$$

meaning that the maximum of u is reached on the boundary.

Proof. First of all, let us assume that u is strictly subharmonic, meaning that $\Delta^{(\delta)}u > 0$ on $\text{Int}\Omega_\delta$. Take $z \in \text{Int}\Omega_\delta$ a point at which u reaches its maximum. Since it is a maximum on vertical axes, we have $\partial_{yy}u(z) \leq 0$. And we also have $\Delta_{xx}^{(\delta)}u(z) = u(z + \delta) + u(z - \delta) - 2u(z) \leq 0$. Thus, the semi-discrete Laplacian $\Delta^{(\delta)}u(z) = \Delta_{xx}^{(\delta)}u(z) + \partial_{yy}u(z) \leq 0$. This is a contradiction.

In a more general case with $\Delta^{(\delta)}u \geq 0$ on $\text{Int}\Omega_\delta$, let us consider the family of functions $(u_\varepsilon)_{\varepsilon > 0}$ defined by Let $\varepsilon > 0$ and consider

$$u_\varepsilon(z) = u(z) + \varepsilon y^2$$

where y is the second coordinate of z . We have $\Delta^{(\delta)}u_\varepsilon = \Delta^{(\delta)}u + 2\varepsilon$, meaning that u_ε is subharmonic. From the first part of the proof, we deduce that

$$\sup_{z \in \Omega_\delta} u_\varepsilon(z) = \sup_{z \in \partial\Omega_\delta} u_\varepsilon(z).$$

Since both terms are finite and decreasing while ε decreases to 0, taking the limit implies the desired result. \square

Given a primal semi-discrete domain Ω_δ and a function $g : \partial\Omega_\delta \rightarrow \mathbb{R}$, the associated *Dirichlet problem* consists of determining a function $h : \Omega_\delta \rightarrow \mathbb{R}$ which

1. coincides with g on the boundary, i.e. $g = h|_{\partial\Omega_\delta}$,
2. satisfies $\Delta^{(\delta)}h \equiv 0$.

In such case, we say that h is a *solution* to Dirichlet problem.

Proposition 3.16 (Existence of solution). *A solution to the Dirichlet problem is given by*

$$h(z) = \mathbb{E} \left[g(B_T^{(\delta)}) \right], \quad \forall z \in \Omega_\delta, \quad (3.19)$$

where

$$T = \inf \{ t \geq 0, B_t^{(\delta)} \notin \Omega_\delta \}.$$

Proof. We notice that Equation (3.19) is well defined because the trajectory of $B_T^{(\delta)}$ is almost surely continuous (in the semi-discrete sense), thus $B_T^{(\delta)} \in \partial\Omega_\delta$.

If h is given by Equation (3.19), then it satisfies the mean-value property on elementary rectangles as well. Indeed, take $z \in \Omega_\delta$ and $\varepsilon > 0$ small enough such that $z + R_\varepsilon \subset \Omega_\delta$. Consider the stopping time

$$T' = \inf\{t \geq 0, B_t^{(\delta)} \notin z + R_\varepsilon\}$$

and write

$$h(z) = \mathbb{E}_z [g(B_{T'}^{(\delta)})] = \mathbb{E}_z [\mathbb{E}_{B_{T'}} [g(B_{T'}^{(\delta)}) | T']] = \mathbb{E}_z [h(B_{T'}^{(\delta)})]$$

which is exactly the mean-value property. Moreover, one can also show that h is \mathcal{C}^2 using classical arguments (convolution for example), Proposition 3.13 gives $\Delta^{(\delta)}h \equiv 0$ on Ω_δ . \square

Proposition 3.17 (Uniqueness). *The solution to the Dirichlet problem is unique.*

Proof. By linearity, it is enough to show uniqueness when the boundary condition is 0. Consider a semi-discrete domain Ω_δ and $h : \overline{\Omega_\delta} \rightarrow \mathbb{R}$ which is zero on the boundary $\partial\Omega_\delta$ and harmonic in Ω_δ . Applying the maximum principle to h and $-h$, the function h should reach its maximum and minimum on the boundary. Therefore, it is zero everywhere. \square

Proof of Proposition 3.13. Here, we finish the proof of the proposition by using the uniqueness of the solution to the Dirichlet problem. Consider a semi-discrete domain Ω_δ and a function $f : \Omega_\delta \rightarrow \mathbb{R}$ satisfying $\Delta^{(\delta)}f \equiv 0$. We want to show that it satisfies the mean-value property on rectangles.

Take $z \in \Omega_\delta$ and $\varepsilon > 0$ such that $z + R_\varepsilon \subset \Omega_\delta$. Consider $g : \partial(z + R_\varepsilon) \rightarrow \mathbb{R}$ which coincides with f . There exists a unique function $h : z + R_\varepsilon \rightarrow \mathbb{R}$ such that $h_{z+\partial R_\varepsilon} \equiv g$ and $\Delta^{(\delta)}h \equiv 0$ over $z + R_\varepsilon$. Since f satisfies exactly the same conditions, we have $f \equiv h$ on $z + R_\varepsilon$.

By the construction of the solution to the Dirichlet problem (Proposition 3.16), f satisfies the mean-value property on rectangles. \square

3.4 Green's function

A Green's function is a function which is harmonic everywhere except at one point, where it has a singularity given by the Dirac mass. It is closely related to random walks in the discrete setting and to Brownian motions in the continuous setting. We will explain its construction in the semi-discrete setting, show that it is unique up to an additive constant and derive some of its properties and asymptotics.

3.4.1 Construction and properties

A Green's function is a function $G_\delta(z, \zeta)$ defined on the semi-discrete (primal) lattice satisfying the following three properties.

1. The function G_δ is translational invariant, *i.e.* there exists a function G_δ such that $G_\delta(\zeta - z) = G_\delta(z, \zeta)$.

2. The function $\zeta \mapsto G_\delta(\zeta)$ is \mathcal{C}^∞ and semi-discrete harmonic except at $\zeta = 0$, where it is only continuous.
3. When $\varepsilon > 0$ is small, the quantities $G_\delta(i\varepsilon)$ and $G_\delta(-i\varepsilon)$ coincide at zero and second order,

$$\begin{aligned}\lim_{\varepsilon \rightarrow 0^+} G_\delta(i\varepsilon) &= \lim_{\varepsilon \rightarrow 0^+} G_\delta(-i\varepsilon), \\ \lim_{\varepsilon \rightarrow 0^+} \partial_{yy} G_\delta(i\varepsilon) &= \lim_{\varepsilon \rightarrow 0^+} \partial_{yy} G_\delta(-i\varepsilon),\end{aligned}$$

whereas at the first order, we have

$$\partial_y G_\delta(i0^+) - \partial_y G_\delta(i0^-) = \lim_{\varepsilon \rightarrow 0} [\partial_y G_\delta(i\varepsilon) - \partial_y G_\delta(-i\varepsilon)] = \frac{1}{\delta}.$$

This is the *normalization* of the Green's function.

If G_δ is a Green's function, we can apply Green's formula (Proposition 3.3) or the Divergence Theorem (Proposition 3.4) to get the usual property that, for a dual domain Ω_δ^* such that $0 \in \text{Int}\Omega_\delta^*$,

$$\int_{\Omega_\delta^*} \Delta^{(\delta)} G_\delta(y) dy = 1$$

and

$$\int_{\Omega_\delta^*} f(y) \Delta^{(\delta)} G_\delta(y) dy = f(0)$$

where f is a semi-discrete function on Ω_δ^* .

We will show that there exists a unique function (up to an additive constant) having these properties. To prove the existence and uniqueness of G_δ and compute it, we generalize the method of discrete exponentials from [Ken02]. First of all, let us define G_δ for $\delta = 1$. Consider a family of meromorphic functions on \mathbb{C} indexed by vertices in \mathbb{L}_δ° in the following way:

- at the origin: $f_0(z) = \frac{1}{z}$;
- if $t \in \mathbb{R}$, then $f_{it}(z) = f_0(z) \cdot \exp\left[2it\left(\frac{1}{z+1} + \frac{1}{z-1}\right)\right]$;
- if $p \in \mathbb{L}_\delta^\circ$, then $f_{p^+}(z) = f_p(z) \cdot \frac{z+1}{z-1}$.

In other words, if $\zeta = m + it$ with $m \in \frac{1}{2}\mathbb{Z}$ and $t \in \mathbb{R}$, we can write

$$f_\zeta(z) = \frac{1}{z} \cdot \exp\left[2it\left(\frac{1}{z+1} + \frac{1}{z-1}\right)\right] \cdot \left(\frac{z+1}{z-1}\right)^{2m}.$$

Proposition 3.18 (Green's function). *The following function is a Green's function on \mathbb{L}_1*

$$G(\zeta) := \frac{1}{8\pi^2 i} \int_C f_\zeta(z) \ln(z) dz \tag{3.20}$$

where C is a path in \mathbb{C} depending on ζ , surrounding $\{e^{i\theta}, 0 \leq \theta \leq \pi\}$ and leaving the origin outside the contour. For the complex logarithm, we define it in $(\theta - \pi, \theta + \pi)$ where θ is an argument of ζ .

Remark 3.19. We can estimate the Green's function of Proposition 3.18 with the help of the residue theorem. The possible poles of the function $f_t(z) \ln(z)$ are 1 and -1 and the choice of the branch creates a possible discontinuity only when $\operatorname{Re}(t) = 0$ since elsewhere, we have $\ln(-1) - \ln(1) = \pm i\pi$ with a $+$ sign in the upper half-plane and a $-$ sign in the lower half-plane.

Proof. We start by checking that G is well-defined. If we change the lift of the logarithm, (equivalent to adding $2k\pi$ to \log), we need to show that this does not change the value of G , that is to say

$$\int_C f_\zeta(z) dz = 0$$

for all $\zeta \in \mathbb{L}_\delta$. This is shown in the Appendix, see Proposition A.5.

In each of the half-planes, the function G is \mathcal{C}^∞ because we integrate a smooth function along a path and the branch of the logarithm does not cross 1 or -1 where we take residues to estimate the integral.

On the \mathbb{Z} axis (except from the origin), we can develop the exponential and see that the residues at 1 and at -1 coincide at all orders. It is explained in Proposition A.6. This tells us that G is \mathcal{C}^∞ on \mathbb{L}_1 except at 0.

Let us now check that G is harmonic everywhere apart from the origin. Actually, it is sufficient to check that f_ζ is harmonic (with respect to ζ) except at the origin. Writing $\zeta = x + iy$ with $x \in \mathbb{Z}$ and $y \in \mathbb{R}$, we find

$$\begin{aligned} \Delta_{xx}^{(\delta)} f_t &= \Delta_{xx}^{(\delta)} f_t + \partial_{yy} f_t \\ &= \left[(2i)^2 \left(\frac{1}{z+1} + \frac{1}{z-1} \right)^2 + \left(\frac{z+1}{z-1} \right)^2 + \left(\frac{z-1}{z+1} \right)^2 - 2 \right] f_t \\ &= 0. \end{aligned}$$

Here, it is allowed to add all the terms together since we consider always the same branch of logarithm.

To conclude the proof, we need to check the third property. This follows from a direct computation:

$$\begin{aligned} \lim_{\varepsilon \rightarrow 0^+} \partial_y G(i\varepsilon) &= \frac{1}{4\pi^2} \int_C \left(\frac{1}{z+1} + \frac{1}{z-1} \right) \frac{\ln(z)}{z} dz \\ &= \frac{i}{2\pi} [\ln(1) - \ln(-1)] = \frac{1}{2} \end{aligned}$$

where we use the residue theorem in the second equality. Similarly, we have

$$\lim_{\varepsilon \rightarrow 0^-} \partial_y G(i\varepsilon) = -\frac{1}{2}.$$

Then, to see that the zero and second orders of G around zero coincide in the upper and lower half-planes, we use Lemma A.4.

As such, we get all the properties we were looking for. \square

Proposition 3.20 (Asymptotics of Green's function). *Let $\zeta \in \mathbb{L}_1$. When $|\zeta|$ goes to infinity, we have the following asymptotic behavior,*

$$G(\zeta) = \frac{1}{2\pi} \ln(4|\zeta|) + \frac{\gamma_{\text{Euler}}}{2\pi} + \mathcal{O}\left(\frac{1}{|\zeta|^2}\right). \quad (3.21)$$

Proof. The proof is similar to the one given in [Ken02] for the discrete Green's function on isoradial graphs. We need to be careful when dealing with the exponential term in f_ζ . Let us write $d = |\zeta|$. To get the improved error term $\mathcal{O}(1/d^2)$, we use the method from [Büc08].

Consider $\zeta = m + it \in \mathbb{L}_\delta$ and write $d = |\zeta|$, $\arg \zeta = \theta_0$. Take $r = \mathcal{O}(1/d^4)$ and $R = \mathcal{O}(d^4)$. We will consider the path C going as follows:

1. counterclockwise around the ball of radius R around the origin from the angles $\theta_0 - \pi$ to $\theta_0 + \pi$,
2. along the direction $e^{i\theta_0}$ from $-R$ to $-r$,
3. around the ball of radius r around the origin from angle $\theta_0 + \pi$ back to $\theta_0 - \pi$,
4. along the direction $e^{i\theta_0}$ from $-r$ to $-R$, back to the starting point.

This path is illustrated in Figure 3.3.

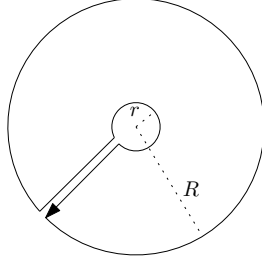

Figure 3.3: The path along which we integrate in the proof of Proposition 3.20.

We estimate these integrals separately, combining the two integrals along the direction $e^{i\theta_0}$. First of all, to study the integral around the ball of radius r , we start by developing f_ζ for $z = re^{i\theta}$ when r is small:

$$\frac{1}{1+z} - \frac{1}{1-z} = \mathcal{O}(r) \quad \text{and} \quad \left(\frac{1+z}{1-z}\right) = \exp(\mathcal{O}(r))$$

Thus,

$$f_\zeta(z) = \frac{1}{z} \exp(\mathcal{O}(dr)) = \frac{1}{z}(1 + \mathcal{O}(dr)).$$

The integral around the ball of radius r is

$$\frac{1}{8\pi^2 i} \int_{\theta_0+\pi}^{\theta_0-\pi} (1 + \mathcal{O}(dr)) (\ln r + i\theta) i d\theta = -\frac{\ln r}{4\pi} (1 + \mathcal{O}(dr)) = -\frac{\ln r}{4\pi} + \mathcal{O}\left(\frac{1}{d^2}\right).$$

Similarly, the integral around the ball of radius R is

$$\frac{\ln R}{4\pi} + \mathcal{O}\left(\frac{1}{d^2}\right).$$

On the direction $e^{i\theta_0}$ from $-R$ to $-r$, we add up the two integrals. Since the logarithm differs by $2\pi i$ on the both sides, by combining we get

$$\frac{e^{i\theta_0}}{4\pi} \int_{-R}^{-r} f_\zeta(se^{i\theta_0}) ds.$$

We should split this integral into 3 parts, I_1 for the integral from $-R$ to \sqrt{d} , I_2 from $-\sqrt{d}$ to $-1/\sqrt{d}$ and I_3 from $-1/\sqrt{d}$ to $-r$. For $|z|$ small, we develop f_ζ to two orders further:

$$f_\zeta(z) = \frac{e^{4\bar{\zeta}z + \mathcal{O}(dz^3)}}{z}.$$

Thus, I_1 can be rewritten (let $\alpha = 4\bar{\zeta}e^{i\theta_0} = 4|\zeta| = 4d$)

$$\begin{aligned} I_1 &= \frac{1}{4\pi} \int_{-1/\sqrt{d}}^{-r} \frac{e^{\alpha s + \mathcal{O}(ds^3)}}{s} ds = \frac{1}{4\pi} \left(\int_{-\alpha/\sqrt{d}}^{-\alpha r} \frac{e^s}{s} ds + \int_{-1/\sqrt{d}}^{-r} \mathcal{O}(ds^3) \frac{e^{\alpha s}}{s} ds \right) \\ &= \frac{1}{4\pi} \left(\int_{-\alpha/\sqrt{d}}^{-1} \frac{e^s}{s} ds + \int_{-1}^{-\alpha r} \frac{e^s - 1}{s} ds + \int_{-1}^{-\alpha r} \frac{ds}{s} \right) + \mathcal{O}\left(\frac{1}{d^2}\right) \\ &= \frac{1}{4\pi} (\ln(\alpha r) + \gamma_{\text{Euler}}) + \mathcal{O}\left(\frac{1}{d^2}\right), \end{aligned}$$

where in the first equality, we develop the exponential and the integral with \mathcal{O} term gives $\mathcal{O}(1/d^2)$; and in the last line, $\ln(\alpha r)$ comes from the third term and Euler's constant comes from the first two integrals by taking $\alpha r \rightarrow 0$ and $\alpha/\sqrt{d} \rightarrow \infty$.

In a similar way (or by making the change of variable $s \rightarrow 1/s$), we get

$$I_3 = \frac{1}{4\pi} (-\ln(R/\alpha) + \gamma_{\text{Euler}}) + \mathcal{O}\left(\frac{1}{d^2}\right).$$

When it comes to the intermediate term, we can show that it is negligible. Let $z = se^{i\theta_0}$ for $s \in [-\sqrt{d}, -1/\sqrt{d}]$. For the exponential term in f_ζ , we have

$$\begin{aligned} \exp\left[2it\left(\frac{1}{z+1} + \frac{1}{z-1}\right)\right] &= \exp\left[-2t \operatorname{Im}\left(\frac{1}{z+1} + \frac{1}{z-1}\right)\right] \\ &= \exp\left[2ts \sin\theta_0 \left(\frac{1}{|z+1|^2} + \frac{1}{|z-1|^2}\right)\right] \\ &\leq \exp\left(-\mathcal{O}\left(\frac{t^2}{d^{3/2}}\right)\right). \end{aligned}$$

Then, for the other one, assume $m \geq 0$ (so $\cos\theta_0 \geq 0$),

$$\begin{aligned} \left|\frac{z+1}{z-1}\right|^{2m} &= \left(\frac{s^2+1+2s\cos\theta_0}{s^2+1-2s\cos\theta_0}\right)^m \leq \left(1 + \frac{4s\cos\theta_0}{(s-1)^2}\right)^m \\ &\leq \exp\left(\frac{4ms\cos\theta_0}{(s-1)^2}\right) \leq \exp\left(-\mathcal{O}\left(\frac{m^2}{d^{3/2}}\right)\right) \end{aligned}$$

and we have the same bound for $m \leq 0$. After all, the intermediate term can be bounded by

$$I_2 \leq \sqrt{d}e^{-\mathcal{O}(\sqrt{d})} \leq \mathcal{O}\left(\frac{1}{d^2}\right).$$

Finally, we sum up all the terms and take the limits $r \rightarrow 0$ and $R \rightarrow \infty$ to have

$$G(\zeta) = \frac{1}{2\pi} [\ln(4|\zeta|) + \gamma_{\text{Euler}}] + \mathcal{O}\left(\frac{1}{d^2}\right). \quad \square$$

Proposition 3.21. *On \mathbb{L}_δ , there exists a unique Green's function with the following normalization at 0*

$$G_\delta(0) = \frac{1}{2\pi}(\ln \delta - \ln 4 - \gamma_{\text{Euler}}).$$

Moreover, its asymptotic behavior when $\frac{|\zeta|}{\delta}$ goes to ∞ is

$$G_\delta(\zeta) = \frac{1}{2\pi} \ln |\zeta| + \mathcal{O}\left(\frac{\delta^2}{|\zeta|^2}\right).$$

We call G_δ the free Green's function on \mathbb{L}_δ .

Proof. To construct a Green's function with such normalization, we can consider

$$G_\delta(\zeta) = G\left(\frac{\zeta}{\delta}\right) + \frac{1}{2\pi}(\ln \delta - \ln 4 - \gamma_{\text{Euler}}).$$

To show the uniqueness, assume that G_δ and \tilde{G}_δ are two such functions. Let $G = G_\delta - \tilde{G}_\delta$. The first order singularities at zero cancel out due to the same normalization, so the function G is \mathcal{C}^1 around 0. Since the second order terms of $G_\delta(i\varepsilon)$ and $G_\delta(-i\varepsilon)$ coincide (same for \tilde{G}_δ), G is \mathcal{C}^2 around 0. Finally, G is harmonic in \mathbb{L}_δ and is bounded (due to the asymptotic behaviour), it should be zero everywhere by Harnack principle (see below, Proposition 3.25). \square

Given a primal semi-discrete domain Ω_δ , we can define the *Green's function on Ω_δ* by

$$G_{\Omega_\delta} = G_\delta - H_{\Omega_\delta}$$

where G_δ is the free Green's function on \mathbb{L}_δ and H_{Ω_δ} the unique solution to the Dirichlet problem on the primal semi-discrete domain Ω_δ whose boundary condition is given by $G_{\delta|\partial\Omega_\delta}$. Here, we notice that G_{Ω_δ} is non-positive.

3.4.2 Link with Brownian motion

In the discrete setting, the Green's function measures how much time a standard Brownian motion spends on each site in average; in the continuous setting, it also gives an analogous of this. We establish an equivalent of such a property in the semi-discrete case.

Proposition 3.22. *Let $B^{(\delta)}$ be a Brownian motion started at $x \in Q_\delta$ as defined in Section 3.2, stopped at τ , the exiting time of the domain Q_δ . Then, we have the asymptotic behaviour which is independent of δ*

$$\mathbb{E}[\tau] \asymp \int_{Q_\delta} |G_{\Omega_\delta}(x, y)| dy$$

where the left-hand side is the average time spent by the semi-discrete Brownian motion $B^{(\delta)}$ in Q_δ ; and the right-hand side is the integral of the Green's function on the same domain.

On a discrete graph, the expectation of the number of visits of a random walk (stopped after an exponential time if it is recurrent) is given by the opposite of its associated Green's function. Similarly, the average time spent by a Brownian motion in a continuous space (\mathbb{R}^d for example) is also given by the opposite of its associated Green's function (again stopped after an exponential time if it is recurrent). Here in the semi-discrete setting, we should interpret the Green's function in the continuous direction as the average time spent by the Brownian motion; whereas in the discrete direction, the expectation of the number of « visits », which explains the factor δ in \int_{Q_δ} .

Proof. The semi-discrete Brownian motion $B^{(\delta)}$ converges in law to its continuous 2D counterpart, so does the semi-discrete Green's function, which converges uniformly on every compact not containing 0 to the 2D Green's function. As such, the integral of semi-discrete Green's function converges to the integral of 2D Green's function on every compact not containing 0. Moreover, $\ln y$ is integrable on $[0, \varepsilon]$, so the integral of the semi-discrete Green's function on a small rectangular domain around 0 can be well controlled, and this quantity goes to 0 when $\varepsilon \rightarrow 0$. \square

Proposition 3.23 (Link with harmonic measure). *Consider a semi-discrete primal domain Ω_δ with $u_0 \in \text{Int}\Omega_\delta$. Let $a \in \partial\Omega_\delta := \mathcal{C}_h \cup \mathcal{C}_v$ be a point on the boundary, where \mathcal{C}_h and \mathcal{C}_v denote respectively the horizontal and vertical parts. Write $\omega_{\Omega_\delta}(u_0, \{a\})$ for the harmonic measure with respect to u_0 . We notice that it should be seen as a density when $a \in \mathcal{C}_v$ and Dirac masses when $a \in \mathcal{C}_h$. Then,*

- if $a \in \mathcal{C}_v$, we have $\omega(u_0, \{a\}) = -\frac{1}{\delta}G_{\Omega_\delta}(u_0, a_{int})$,
- if $a \in \mathcal{C}_h$, we have $\omega(u_0, \{a\}) = \pm\partial_y G_{\Omega_\delta}(u_0, a)$,

where a_{int} is the unique vertex in $\{a \pm \delta\} \cap \text{Int}\Omega_\delta$, ∂_y is the vertical derivative with respect to the second coordinate and we take the + sign if the boundary is oriented to the left at a and the - sign otherwise.

Proof. It is immediate from Green's Theorem (Proposition 3.5) by taking $f = \omega_{\Omega_\delta}(\cdot, \{a\})$ and $g = G_{\Omega_\delta}(u_0, \cdot)$ and the fact that $\int_{\Omega_\delta} f \Delta^{(\delta)} g = 1$. \square

Lemma 3.24. *We keep the same notation as above and take $\Omega_\delta = B_\delta(u_0, R)$. There exist two positive constants c_1 and c_2 , independent of δ , such that*

- if $a \in \mathcal{C}_v$, we have $c_1 \leq \omega(u_0, \{a\}) \leq c_2$;
- if $a \in \mathcal{C}_h$, we have $c_1\delta \leq \omega(u_0, \{a\}) \leq c_2\delta$.

Proof. We link the harmonic measure to Green's function via Proposition 3.23, which can be estimated more easily by its asymptotic behavior given in Proposition 3.21. We can write

$$G_{\Omega_\delta}(u_0, u) - \frac{1}{2\pi} \ln \frac{|u - u_0|}{R} = \left[G_\delta(u_0, u) - \frac{1}{2\pi} \ln |u - u_0| \right] - \left[G_{\Omega_\delta}^*(u, u_0) - \frac{1}{2\pi} \ln R \right].$$

The first term is $\mathcal{O}\left(\frac{\delta^2}{|u-u_0|^2}\right)$. The second term is harmonic in $B_\delta(u_0, R)$, thus by maximum principle, we get

$$\begin{aligned} \left|G_{\Omega_\delta}^*(u, u_0) - \frac{1}{2\pi} \ln R\right| &\leq \sup_{v \in \partial B_\delta(u_0, R)} \left|G_\delta(v, u_0) - \frac{1}{2\pi} \ln R\right| \\ &\leq \frac{\delta}{\pi R} + \mathcal{O}\left(\frac{\delta^2}{R^2}\right), \end{aligned}$$

where we use the fact that $R - 2\delta \leq |v - u_0| \leq R$ since $v \in \partial B_\delta(u_0, R)$. In summary, for all $u \in B_\delta(u_0, R)$,

$$\left|G_{\Omega_\delta}(u_0, u) - \frac{1}{2\pi} \ln \frac{|u - u_0|}{R}\right| = \frac{\delta}{\pi R} + \mathcal{O}\left(\frac{\delta^2}{|u - u_0|^2} + \frac{\delta^2}{R^2}\right).$$

By taking $u = a_{int}$ with $a \in \mathcal{C}_v$, we get the first part of the proposition. By taking $u \in B_\delta(u_0, R)$ closer and closer to $a \in \mathcal{C}_h$, we get the second part. \square

3.5 Harnack Principle and convergence theorems

This part deals mostly with harmonic analysis. We give the semi-discrete version of Harnack Lemma, Riesz representation and a convergence theorem of harmonic functions.

Proposition 3.25 (Semi-discrete Harnack Lemma). *Let $u_0 \in \Omega_\delta$ and $0 < r < R$ such that $B_\delta(u_0, R) \subset \Omega_\delta$. Consider a non-negative semi-discrete harmonic function $H : B_\delta(u_0, R) \rightarrow \mathbb{R}$. Let $M = \max H$ on Ω_δ . If $u, u^+ \in B_\delta(u_0, r)$, then*

$$\begin{aligned} |H(u^+) - H(u)| &\leq \text{const} \cdot \frac{\delta M}{R - r}, \\ \partial_y H(u) &\leq \text{const} \cdot \frac{M}{R - r}. \end{aligned}$$

Proof. The proof is classical. We use coupled semi-discrete Brownian motions issued from two neighboring sites on semi-discrete lattice by reflection. For the derivative in y , we use the same method. The difference between $H(u + i\varepsilon)$ and $H(u - i\varepsilon)$ can be bounded by $\text{const} \cdot \frac{\varepsilon M}{R - r}$ and by dividing everything by ε and taking the limit, we obtain the inequality. \square

Proposition 3.26 (Riesz representation). *Let f be a function on Ω_δ vanishing on the boundary $\partial\Omega_\delta$. Then, for all $y \in \Omega_\delta$,*

$$f(y) = \int_{\Omega_\delta} \Delta^{(\delta)} f(x) G_{\Omega_\delta}(x, y) dx.$$

Here, if f is not differentiable, we can define the integral in the sense of distributions.

Proof. The function $f - \int_{\Omega_\delta} \Delta^{(\delta)} f(x) G_{\Omega_\delta}(x, \cdot) dx$ is harmonic and zero on the boundary, thus zero everywhere. \square

Theorem 3.27 (Convergence theorem for harmonic functions). *Let $(h_\delta)_{\delta>0}$ be a family of semi-discrete harmonic functions on Ω_δ . It forms a precompact family for the uniform topology on compact subsets of Ω if one of the following conditions is satisfied.*

1. *The family (h_δ) is uniformly bounded on any compact subset of Ω .*
2. *For any compact $K \subset \Omega$, there exists $M = M(K) > 0$ such that for all $\delta > 0$, we have*

$$\int_{K_\delta} |h_\delta(x)|^2 dx \leq M.$$

Proof. The first point comes from Arzelà-Ascoli since (h_δ) is uniformly Lipschitz (Proposition 3.25).

We will show that the second point implies the first one to conclude. Start by choosing a compact subset $K \subset \Omega$. Denote by $d = d(D, \partial\Omega)$ the distance between K and the boundary of Ω . Let K' be the $d/2$ -neighborhood of K .

Let $0 < \delta < d/2$ and $x \in \text{Int}K_\delta$. Choose Q to be a rectangular domain in K' which is centered at x . Write $Q_\delta = (x + [-r\delta, r\delta] \times [-s, s]) \cap \mathbb{L}_\delta$, $r \in \mathbb{N}$, for its semi-discrete counterpart. It is possible to have $r\delta > d/4$ and $s > d/4$ due to the assumption on the distance, and we assume so in the following.

If we write $H_k = \{k\delta\} \times [-s, s]$, the hypothesis implies

$$\sum_{k=\frac{r}{2}}^r \delta \left(\int_{H_{-k}} + \int_{H_k} \right) |h_\delta(y)|^2 dy \leq M(K') =: M$$

for a certain constant M which is uniform in δ . Take $p \in \llbracket r/2, r \rrbracket$ such that the summand is minimum, we get

$$\left(\int_{H_{-p}} + \int_{H_p} \right) |h_\delta(y)|^2 dy \leq \frac{1}{\delta} \frac{M}{r/2} \leq c_1,$$

where c_1 is a uniform constant in δ .

For $t \in [0, s]$, denote $H_p^t = \{p\delta\} \times [-t, t]$. We can write, by linearity, h_δ as linear combination of harmonic measures,

$$h_\delta(x) = \left(\int_{H_{-p}^t} + \int_{H_p^t} \right) h_\delta(y) \omega_t(x, y) dy + \sum_{\substack{k=-p+1 \\ y=k\delta \pm it}}^{p-1} h_\delta(y) \omega_t(x, y), \quad (3.22)$$

where ω_t is the harmonic measure in $[-p\delta, p\delta] \times [-t, t]$.

We integrate Equation (3.22) from $t = s/2$ to $t = s$ and get

$$\begin{aligned} h_\delta(x) &= \frac{2}{s} \int_{s/2}^s \left(\int_{H_{-p}^t} + \int_{H_p^t} \right) h_\delta(y) \omega_t(x, y) dy dt \\ &\quad + \frac{2}{s} \int_{s/2}^s \sum_{\substack{k=-p+1 \\ y=k\delta \pm it}}^{p-1} h_\delta(y) \omega_t(x, y) dt. \end{aligned}$$

We want to show that $h_\delta(x)$ is uniformly bounded in x and in δ . We will take its square and apply Cauchy-Schwarz.

Below, denote respectively the first and second integrals A and B . First of all, notice that $h_\delta(x)^2 \leq 2(A^2 + B^2)$, so we just need to show that A and B are bounded. We have,

$$\begin{aligned} A^2 &\leq \left(\frac{2}{s}\right)^2 \int_{s/2}^s \left(\int_{H_{-p}^t} + \int_{H_p^t} \right) h_\delta(y)^2 dy dt \int_{s/2}^s \left(\int_{H_{-p}^t} + \int_{H_p^t} \right) \omega_t(x, y)^2 dy dt \\ &\leq \left(\int_{H_{-p}^s} + \int_{H_p^s} \right) h_\delta(y)^2 dy \left(\int_{H_{-p}^t} + \int_{H_p^t} \right) \omega_s(x, y)^2 dy \end{aligned}$$

where $(2/s)^2$ is distributed once in the first term and once in the second, normalizing the integrals. (The length of the segment along which we integrate is $s/2$.) Then, for x and y fixed, $\omega_t(x, y) \leq \omega_s(x, y)$ for $t \leq s$. Here, the first term is bounded by c_1 by hypothesis, and the second by another constant c_2 from Lemma 3.24.

For the second term, Cauchy-Schwarz gives

$$B^2 \leq \left(\frac{2}{s}\right)^2 \int_{s/2}^s \sum_{\substack{k=-p+1 \\ y=k\delta+it}}^{p-1} \delta h_\delta(y)^2 dt \int_{s/2}^s \sum_{\substack{k=-p+1 \\ y=k\delta+it}}^{p-1} \frac{\omega_t(x, y)^2}{\delta} dt.$$

On the right-hand side, the first term is bounded by M by assumption and the second term bounded by a uniform constant c_3 because $\omega_t(x, y)$ can be bounded by $c_4\delta$ uniformly (in a similar manner as before) in δ and in $y - x$, and there are $\mathcal{O}(1/\delta)$ terms in the sum. \square

Proposition 3.28 (Estimation on the derivative of the Green's function). *Let $Q \subset \Omega_\delta$ such that $9Q \subset \Omega_\delta$. There exists $C > 0$ such that for all $\delta > 0$ and $y \in 9Q_\delta$, we have*

$$\int_{Q_\delta} |\Delta_x^{(\delta)} G_{9Q_\delta}(x, y)| dx \leq C \int_{Q_\delta} |G_{9Q_\delta}(x, y)| dx.$$

Proof. For $y \in 9Q_\delta \setminus 3Q_\delta$, we estimate the Green's function in terms of the Brownian motion, or more precisely, the harmonic measure. We recall that $G_{9Q_\delta}(\cdot, y)$ is non positive, so that we can write for $x \in 2Q_\delta$,

$$|G_{9Q_\delta}(x, y)| = \int_{\mathcal{C}_v} |G_{9Q_\delta}(z, y)| \omega_{2Q_\delta}(z, y) |dz| + \frac{1}{\delta} \int_{\mathcal{C}_h} |G_{9Q_\delta}(z, y)| \omega_{2Q_\delta}(z, y) |dz|$$

where we denote the vertical and horizontal parts of the boundary $\partial(2Q_\delta)$ by \mathcal{C}_v and \mathcal{C}_h . We can assume that

$$H := \int_{\mathcal{C}_h} |G_{9Q_\delta}(z, y)| |dz| \geq V := \int_{\mathcal{C}_v} |G_{9Q_\delta}(z, y)| |dz|.$$

The estimations of ω_{9Q_δ} in Lemma 3.24 gives us the lower and upper bounds easily

$$|G_{9Q_\delta}(x, y)| \leq c_2 \oint_{\partial(2Q_\delta)} |G_{9Q_\delta}(z, y)| |dz| = c_2(H + V) \leq 2c_2H$$

and

$$\begin{aligned} |G_{9Q_\delta}(x, y)| &\geq c_1 \oint_{\partial(2Q_\delta)} |G_{9Q_\delta}(z, y)| |dz| \\ &\geq c_1 \int_{\mathcal{C}_h} |G_{9Q_\delta}(z, y)| |dz| = c_1 H. \end{aligned}$$

Thus, for $x, x' \in 2Q_\delta$,

$$\frac{1}{c_3} |G_{9Q_\delta}(x, y)| \leq |G_{9Q_\delta}(x', y)| \leq c_3 |G_{9Q_\delta}(x, y)|$$

with $c_3 = 2c_2/c_1$. Knowing that $G_{9Q_\delta}(\cdot, y)$ is harmonic in Q_δ , we apply Proposition 3.25 and the above inequality to get

$$|\Delta_x^{(\delta)} G_{9Q_\delta}(x, y)| \leq c_4 \max_{x' \in Q_\delta} |G_{9Q_\delta}(x', y)| \leq c_3 c_4 |G_{9Q_\delta}(x, y)|.$$

For $y \in 3Q_\delta$, from Proposition 3.22, the average time spent by the Brownian motion, stopped when touching $\partial 9Q_\delta$, in Q_δ is proportional to

$$\int_{Q_\delta} |G_{9Q_\delta}(x, y)| dx.$$

This quantity can be bounded from below by a constant c_5 because the semi-discrete Brownian motion converges to its continuous counterpart in \mathbb{R}^2 .

Now it remains to show that the left-hand side can be bounded from above by a constant.

We write

$$G_{9Q_\delta}(x, y) = [G_{9Q_\delta}(x, y) - G_\delta(x, y)] + G_\delta(x, y),$$

where G_δ is the Green's function on \mathbb{L}_δ defined in Proposition 3.21. The first part $G_{9Q_\delta}(\cdot, y) - G_\delta(\cdot, y)$ is harmonic in $9Q_\delta$ (the singularities cancel out); moreover, on the boundary $\partial 9Q_\delta$, G_{9Q_δ} is zero and G_δ is bounded by a constant depending only on the domain Q by using the asymptotic behavior of the free Green's function in Proposition 3.21. The Harnack principle (Proposition 3.25) gives

$$|\Delta_x^{(\delta)} [G_{9Q_\delta}(x, y) - G_\delta(x, y)]| \leq c_6.$$

Thus,

$$\int_{Q_\delta} |\Delta_x^{(\delta)} [G_{9Q_\delta}(x, y) - G_\delta(x, y)]| dx \leq \delta \cdot \frac{c_7}{\delta} \cdot c_6 = c_6 c_7.$$

Concerning $|\Delta_x^{(\delta)} G_\delta(x, y)|$, we can look at its asymptotic behaviour and show that, for $\zeta = m + it \in Q_\delta$ with $|\zeta| \gg \delta$,

$$\begin{aligned} \Delta_x^{(\delta)} G_\delta(\zeta, y) &= \frac{1}{\delta} \left[G_\delta\left(\zeta + \frac{\delta}{2}, y\right) - G_\delta\left(\zeta - \frac{\delta}{2}, y\right) \right] \\ &= \frac{1}{2\pi\delta} \left[\ln \left(\frac{(m + \frac{\delta}{2})^2 + t^2}{m^2 + t^2} \right) - \ln \left(\frac{(m - \frac{\delta}{2})^2 + t^2}{m^2 + t^2} \right) \right] \\ &= \frac{1}{2\pi\delta} \left[\frac{2\delta m}{m^2 + t^2} + \mathcal{O}(\delta^2) \right] = \frac{1}{\pi} \frac{m}{m^2 + t^2} + \mathcal{O}(\delta). \end{aligned}$$

Thus, by integrating along vertical axes in Ω_δ , we get some quantity with the same asymptotic behaviour (independent of δ but on Q_δ),

$$\int_{Q_\delta} |\Delta_x^{(\delta)} G_\delta(x, y)| dx \leq c_8.$$

The proof follows readily. \square

3.6 Convergence to the continuum Dirichlet problem

In this subsection, we study the convergence of semi-discrete harmonic functions when the mesh size of the lattice goes to 0.

Lemma 3.29. *Let Ω be a domain and (Ω_δ) its semi-discretized approximations converging to Ω in the Carathéodory sense. For each $\delta > 0$, consider a semi-discrete harmonic function h_δ on Ω_δ . Assume that h_δ converges uniformly on any compact subset of Ω to a function h , then h is also harmonic.*

Proof. From Proposition 3.25 and Theorem 3.27, we know that the family $(\Delta_x^{(\delta)} h_\delta)$ is precompact thus we can extract from it a converging subsequence. Since $\partial_x h$ is the only possible sub-sequential limit, $(\Delta_x^{(\delta)} h_\delta)$ converges. Similarly, one can also prove that $\Delta^{(\delta)} h_\delta = 0$ converges to Δh , which is also zero. \square

Proposition 3.30. *Let Ω be a domain with two marked points on the boundary $a, b \in \partial\Omega$. Consider f a bounded continuous function on $\partial\Omega \setminus \{a, b\}$ and h the solution associated to the Dirichlet boundary value problem with boundary condition f . For each $\delta > 0$, let Ω_δ be the semi-discretized counterpart of the domain Ω , a_δ and b_δ approximating a and b . Let $f_\delta : \partial\Omega_\delta \rightarrow \mathbb{R}$ be a sequence of uniformly bounded functions converging uniformly away from a and b to f and h_δ be the solution of the semi-discrete Dirichlet boundary problem with f_δ as boundary condition. Then,*

$$h_\delta \rightarrow h$$

uniformly on compact subsets of Ω .

Proof. We first notice that the semi-discretized domains converge in the Carathéodory sense to (Ω, a, b) . Since (f_δ) is uniformly bounded, it is the same for the family (h_δ) . Theorem 3.27 says that (h_δ) is a precompact family. Let \tilde{h} be a subsequential limit, which should also be harmonic inside Ω by Lemma 3.29. To show that $h = \tilde{h}$, we need to prove that \tilde{h} can be extended to the boundary by f in a continuous way. This can be done by using the weak Beurling's estimate, obtained by analyzing the Brownian motion on semi-discrete lattice. This result is classical and can be adapted easily to our semi-discrete setting. \square

3.7 S-holomorphicity

The notion of *s-holomorphicity* will turn out to be important when it comes to the convergence Theorem 5.4. Actually, the semi-discrete holomorphicity provides us only with half of Cauchy-Riemann equations and the rest of the information

can be “recovered” by s-holomorphicity. More precisely, it allows us to define a primitive of $\text{Im } f^2$ where f is s-holomorphic in Section 4.3 and the convergence of this primitive will tell us more about the convergence of f . We will discuss this in more details in Sections 4 and 5.

Definition 3.31. Let $f : \Omega_\delta^b \rightarrow \mathbb{C}$ be a function defined on the mid-edge semi-discrete lattice. It is said to be *s-holomorphic* if it satisfies the two following properties.

1. Parallelism: for $e \in \Omega_\delta^b$, we have $f(e) \parallel \tau(e)$ where $\tau(e) = [i(w_e - u_e)]^{-1/2}$, u_e and w_e denote respectively the primal and the dual extremities of the mid-edge e . In other words,
 - $f(e) \in \nu\mathbb{R}$ if p_e^+ is a dual vertex, and
 - $f(e) \in i\nu\mathbb{R}$ if p_e^+ is a primal vertex,

where $\nu = \exp(-i\pi/4)$.

2. Holomorphicity: for all vertex e on the mid-edge lattice Ω_δ^b , we have $\overline{D}^{(\delta)} f(e) = 0$.

Definition 3.32. Let $g : \Omega_\delta^\circ \rightarrow \mathbb{C}$ be a function defined on the medial semi-discrete domain. It is said to be *s-holomorphic* if it satisfies the two following properties.

1. Projection: for every $e = [p_e^- p_e^+] \in \Omega_\delta^b$, we have

$$\text{Proj}[g(p_e^-), \tau(e)] = \text{Proj}[g(p_e^+), \tau(e)] \quad (3.23)$$

where $\text{Proj}(X, \tau)$ denotes the projection of X in the direction of τ :

$$\text{Proj}[X, \tau] = \frac{1}{2} \left[X + \frac{\tau}{\overline{\tau}} \cdot \overline{X} \right].$$

2. Holomorphicity: for all vertex e on medial lattice Ω_δ° , we have $\overline{D}^{(\delta)} f(e) = 0$.

We have a correspondance between s-holomorphic functions on Ω_δ° and on Ω_δ^b .

Proposition 3.33. *Given a s-holomorphic function $f : \Omega_\delta^b \rightarrow \mathbb{C}$, one can define $g : \Omega_\delta^\circ \rightarrow \mathbb{C}$ by:*

$$g(p) = f(e_p^-) + f(e_p^+), \quad p \in \Omega_\delta^\circ.$$

Then, the new function g is still s-holomorphic.

Conversely, given a s-holomorphic function $g : \Omega_\delta^\circ \rightarrow \mathbb{C}$, one can define $f : \Omega_\delta^b \rightarrow \mathbb{C}$ by:

$$f(e) = \text{Proj}[g(p_e^-), \tau(e)] = \text{Proj}[g(p_e^+), \tau(e)], \quad e \in \Omega_\delta^b.$$

Then, the new function f is still s-holomorphic.

Proof. Assume that $f : \Omega_\delta^b \rightarrow \mathbb{C}$ is s-holomorphic. Let us show that g as defined above is s-holomorphic on Ω_δ° . The projection property is satisfied from the parallelism of f and so is the holomorphicity.

Assume that $g : \Omega_\delta^\circ \rightarrow \mathbb{C}$ is s-holomorphic. Let us show that f as defined above is s-holomorphic on Ω_δ^b . The parallelism is clearly satisfied by the definition. We just need to check the holomorphicity of f . Let $e \in \Omega_\delta^b$. We can assume that p_e^+ is primal and p_e^- dual such that $\tau(e) // e^{i\pi/4}$. We want to calculate $\partial_y f(e)$.

$$\begin{aligned} \partial_y f(e) &= \partial_y \text{Proj}[g(p), \tau(e)] \\ &= \frac{1}{2} \partial_y [g(p) + i \overline{g(p)}] \\ &= \frac{1}{2} \left[\frac{i}{\delta} (g(p^+) - g(p^-)) + i \left(-\frac{i}{\delta} \right) (\overline{g(p^+) - g(p^-)}) \right] \\ &= \frac{i}{\delta} [f(e^+) - f(e^-)] \end{aligned}$$

where we use $\tau(e)/\overline{\tau(e)} = i$ and $\tau(e^+)/\overline{\tau(e^+)} = \tau(e^-)/\overline{\tau(e^-)} = -i$. □

4 Observable on semi-discrete lattice

4.1 Definition and illustration

Let us take a Dobrushin domain (Ω, a, b) in \mathbb{R}^2 . Consider $\delta > 0$ and the semi-discretized domain $(\Omega_\delta^\circ, a_\delta, b_\delta)$ with mesh size δ , on which we put the loop representation of the critical quantum Ising model (Equation (2.1)) with parameter ρ , which is the density of Poisson point processes on both primal and dual vertical lines. Here, we choose ρ to be proportional to $1/\delta$ so that the model is not degenerated when we take the limit $\delta \rightarrow 0$. Actually, we take $\rho = \frac{1}{\sqrt{2}\delta}$, the constant $\frac{1}{\sqrt{2}}$ being chosen to make the model isotropic, in the sense that we get the correct multiplicative constant in the relation of (s-)holomorphicity.

The loop representation of the quantum Ising model gives an interface going from a_δ to b_δ . If $e \in \Omega_\delta^b$ is a mid-edge vertex of the Dobrushin domain $(\Omega_\delta^\circ, a_\delta, b_\delta)$, we can define our observable at this point by

$$F_\delta(e) := F_{(\Omega_\delta^\circ, a_\delta, b_\delta)}(e) = \frac{\nu}{\sqrt{\delta}} \cdot \mathbb{E} \left[\exp \left(\frac{i}{2} W(e, b_\delta) \right) \mathbb{1}_{e \in \gamma_\delta} \right] \quad (4.1)$$

where γ_δ denotes the (random) interface going from a_δ to b_δ and $W(e, b_\delta)$ its winding from e to b_δ and $\nu = \exp(-i\pi/4)$.

Remark 4.1. For the readers who might have read [CS12], since here the graph is oriented differently, the multiplicative factor ν is chosen so that we can keep the same notations for properties that follow later.

Remark 4.2. Since the domain we consider here is simply connected, the winding $W(e, e_b^\delta)$ for a mid-edge vertex e on the boundary does not depend on the random configuration. We have two cases:

- If $p_e^- \in \Omega_\delta$ and $p_e^+ \in \Omega_\delta^*$, then the winding $W(e, b_\delta)$ is a multiple of 2π and $F_\delta(e)$ is parallel to ν .
- If $p_e^- \in \Omega_\delta^*$ and $p_e^+ \in \Omega_\delta$, then the winding $W(e, b_\delta)$ is a multiple of 2π plus π and $F_\delta(e)$ is parallel to $i\nu$.

This says that F_δ satisfies the property of parallelism.



Figure 4.1: Local relative position of primal / dual vertices with the direction of F_δ in blue.

We can notice that the winding at e_b is $W(e_b, e_b) = 0$, thus $F_\delta(e_b) = \frac{\nu}{\sqrt{\delta}}$, which is called the *normalizing constant*.

We then define the observable on Ω_δ° for all $p \in \Omega_\delta^\circ$ by

$$\mathcal{F}_\delta(p) = F_\delta(p^+) + F_\delta(p^-). \quad (4.2)$$

If $p \in \partial\Omega_\delta^\circ$, one of p^+ and p^- is not defined. We then take the undefined term to be 0. As such, we define \mathcal{F}_δ everywhere on Ω_δ° . We notice that \mathcal{F}_δ satisfies the projection property (3.23).

Let p be a primal or dual point on the arcs $(a_\delta b_\delta)$ and $(b_\delta a_\delta)$. We denote by $\tau(p)$ the tangent vector to $\partial\Omega_\delta$ oriented from b_δ^b to a_δ^b if p is on $(a_\delta b_\delta)$, and oriented from b_δ^w to a_δ^w if p is on $(b_\delta a_\delta)$.

Proposition 4.3. *For $p \in (a_\delta b_\delta) \cup (b_\delta a_\delta)$, we have $\mathcal{F}_\delta(p) \parallel \tau(p)^{-1/2}$.*

Proof. We can assume that $p \in (a_\delta b_\delta)$ since the proof is similar for $p \in (b_\delta a_\delta)$. In this case, we get two types of tangent vector: $\tau(p)$ is horizontal when p is a dual vertex and vertical when p is a primal vertex.

1. Assume that the tangent vector $\tau(p)$ is vertical. We may assume that $\tau(p)$ is oriented from right to left, then the paths counted in $F_\delta(e_p^+)$ are exactly those counted in $F_\delta(e_p^-)$, because the interface going through e_p^+ is forced to turn left and go through e_p^- . Thus, the observable $\mathcal{F}_\delta(p)$ at p can be written as

$$\mathcal{F}_\delta(p) = (1 - i)F_\delta(e_p^+).$$

The quantity $F_\delta(e_p^+)$ being parallel to $i\nu$, we have $\mathcal{F}_\delta(p) \in \mathbb{R}$. Also, we know that $\tau(p)^{-1/2}$ is parallel to 1. The case where $\tau(p)$ is oriented from left to right can be treated in the same way.

2. Assume that the tangent vector $\tau(p)$ is horizontal which can be oriented either upwards or downwards. If $\tau(p)$ is oriented downwards, $\mathcal{F}_\delta(p)$ takes the same value as $F_\delta(e_p^-)$, which belongs to $i\nu\mathbb{R}$ due to Remark 4.2. Moreover, $\tau(p)^{-1/2}$ is parallel to $i\nu$. It is similar if $\tau(p)$ is oriented upwards.

□

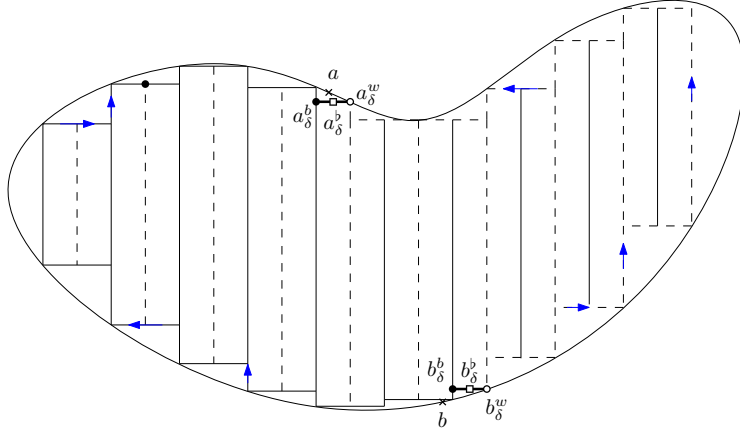

Figure 4.2: The Dobrushin domain shown in Figure 2.4 with tangent vectors τ drawn in blue with arrows on the boundary.

4.2 Relations and holomorphicity

To study the observables F_δ and \mathcal{F}_δ , we need to establish local bijections between configurations which will give us local relations for F_δ and \mathcal{F}_δ . Our goal is to get a relation between the observable F_δ and its derivative $\partial_y F_\delta$.

To do so, we will fix a *local window* with height equal to ε and width covering three columns, as shown in Figure 4.3. We notice that, in the loop representation, if we reverse primal and dual axes, the loops and interfaces will also reverse their paths. By studying the difference between the contribution of the term in the expectation in Equation (4.1), and by making ε go to 0, we will get the derivative. Since the number of points given by point Poisson processes is proportional to the length of the interval, thus to ε here, in the limit, only the first order term in ε counts. In consequence, we only need to constraint ourselves to configurations with at most one Poisson point in the local window.

Some abbreviations will be introduced to lighten our notations. We denote the north-/south- west/middle/east mid-edge vertices by taking their initials: nw , nm , ne , sw , sm and se . We denote the primal extremity shared by nw and nm by b_n and the one shared by sw and sm by b_s . Similarly for w_n and w_s . See again Figure 4.3.

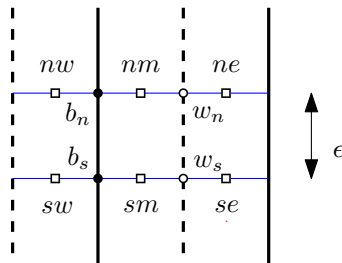

Figure 4.3: A local window with height ε . The same notations are used in the following figures and tables of this section.

To understand the bijections between configurations, the reader is invited to have a look at Figure 4.4 while reading the following explanation. The bijections are obtained by starting with an interface going through the middle column, which is not a loss of generality. In our case, it goes down due to the choice of the local window. We assume that there is not any Poisson points in this local window.

We will then analyze different possibilities. Once the interface goes out of the local window, it may never come back to the neighboring mid-edge axes (*i.e.* west and east), which is the case of (1a). Otherwise, the interface may come back to one of the neighboring mid-edge axes. In (2a), it comes back through the East column and in (3a), through the West column.

Now we can consider Poisson points in our configurations. As we mentioned earlier, we are only interested in configurations with at most one such point. In (1b), (2b) and (3b), we add one Poisson point between b_s and b_n whereas in (1c), (2c) and (3c), we add one between w_s and w_n . The configurations (1a), (1b) and (1c) are in bijection, same for (2a), (2b) and (2c) or (3a), (3b) and (3c). Notice that these configurations do not have the same weight, but we know the ratio between their weights, which will allow us to get linear relations between the contribution of $\exp(\frac{i}{2}W(e, b_\delta))\mathbb{1}_{e \in \gamma_\delta}$ to f at nw, sw, nm, sm, ne and se .

We first establish Table 4.1 containing different contributions. The last columns contain the weight of each configuration up to a multiplicative constant depending on the original configuration in (1a), (2a) and (3a). However, the fact that this multiplicative constant is unknown does not raise any difficulty since we only need linear relations between values of F_δ at different mid-edge vertices.

	nw	sw	nm	sm	ne	se	weights
1a	0	0	1	1	0	0	$\sqrt{2}$
1b	$e^{i\frac{\pi}{2}}$	$e^{-i\frac{\pi}{2}}$	1	1	0	0	$\varepsilon\rho$
1c	0	0	1	1	$e^{-i\frac{\pi}{2}}$	$e^{i\frac{\pi}{2}}$	$\varepsilon\rho$
2a	0	0	1	1	$e^{-i\frac{\pi}{2}}$	$e^{-i\frac{\pi}{2}}$	$\sqrt{2}$
2b	$e^{i\frac{\pi}{2}}$	$e^{-i\frac{\pi}{2}}$	1	1	$e^{-i\frac{\pi}{2}}$	$e^{-i\frac{\pi}{2}}$	$\varepsilon\rho$
2c	0	0	1	0	$e^{-i\frac{\pi}{2}}$	0	$2\varepsilon\rho$
3a	$e^{i\frac{\pi}{2}}$	$e^{i\frac{\pi}{2}}$	1	1	0	0	$\sqrt{2}$
3b	$e^{i\frac{\pi}{2}}$	0	1	0	0	0	$2\varepsilon\rho$
3c	$e^{i\frac{\pi}{2}}$	$e^{i\frac{\pi}{2}}$	1	1	$e^{-i\frac{\pi}{2}}$	$e^{i\frac{\pi}{2}}$	$\varepsilon\rho$

Table 4.1: Contributions of the exponential term in each configuration at different positions.

We take the difference of contributions between the north mid-edge and the south mid-edge in each of the three columns to get Table 4.2. After this, we get $F_\delta(w)$, $F_\delta(m)$ and $F_\delta(e)$ from Table 4.1 by ignoring terms of order higher than ε ; and $\partial_y F_\delta(w)$, $\partial_y F_\delta(m)$ and $\partial_y F_\delta(e)$ by dividing the quantities in Table 4.2 by ε and then making it go to 0.

The quantities in the first and the second lines of Table 4.3 satisfy

$$(F_\delta(e) - F_\delta(w)) \cdot i\sqrt{2}\rho = \partial_y F_\delta(m). \quad (4.3)$$

	$nw - sw$	$nm - sm$	$ne - se$
1	$2i\varepsilon\rho$	0	$-2i\varepsilon\rho$
2	$2i\varepsilon\rho$	$2\varepsilon\rho$	$-2i\varepsilon\rho$
3	$2i\varepsilon\rho$	$2\varepsilon\rho$	$-2i\varepsilon\rho$

Table 4.2: Computation of the difference between the contributions of North and South.

	$F_\delta(w)$ $\partial_y F_\delta(w)$	$F_\delta(m)$ $\partial_y F_\delta(m)$	$F_\delta(e)$ $\partial_y F_\delta(e)$
1	0 $2i\rho$	$\sqrt{2}$ 0	0 $-2i\rho$
2	0 $2i\rho$	$\sqrt{2}$ 2ρ	$-i\sqrt{2}$ $-2i\rho$
3	$i\sqrt{2}$ $2i\rho$	$\sqrt{2}$ 2ρ	0 $-2i\rho$

Table 4.3: By considering order 0 and order 1 terms in ε , we get F_δ and $\partial_y F_\delta$.

4.3 Primitive of \mathcal{F}_δ^2

We will be interested in Riemann-Hilbert boundary value problem in Section 5.2. To solve this problem in continuum, we make use of the fact that the function $h = \text{Im } f^2$, where f is a solution, is harmonic. Therefore, in the semi-discrete setting, we try to make sense of a primitive of \mathcal{F}_δ^2 then show that it is not far from being harmonic. This will be illustrated in Section 5.

Given v a site on the lattice, we denote by e_v^+ and e_v^- the mid-edges having v as extremity on the right side and the left side of v , as illustrated in Figure 4.5. In a similar way, we denote by e_v^{++} and e_v^{--} the second on the right or left.

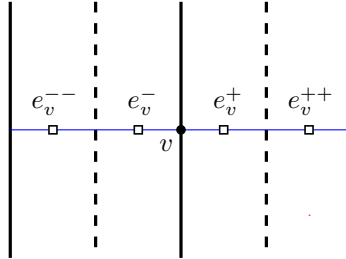

Figure 4.5: Notations for neighboring mid-edges.

Let us define H_δ , a “primitive” of \mathcal{F}_δ^2 in the following way. Since \mathcal{F}_δ and F_δ can be related, in the definitions below we only work with F_δ first.

1. If b and b' are primal vertices such that $\text{Re } b = \text{Re } b'$ and $[bb'] \subset \Omega_\delta^\circ$, define

$$H_\delta(b') - H_\delta(b) = 2 \cdot \text{Im} \int_b^{b'} F_\delta(e_v^-) \overline{F_\delta(e_v^+)} dv \quad (4.5)$$

2. If w and w' are dual vertices such that $\text{Re } w = \text{Re } w'$ and $[ww'] \subset \Omega_\delta^\circ$, define

$$H_\delta(w') - H_\delta(w) = -2 \cdot \text{Im} \int_w^{w'} F_\delta(e_v^-) \overline{F_\delta(e_v^+)} dv. \quad (4.6)$$

3. If b and w are neighboring primal and dual vertices in Ω_δ° , define

$$H_\delta(b) - H_\delta(w) = \delta |F_\delta(bw)|^2. \quad (4.7)$$

Proposition 4.5. *The primitive H_δ is well-defined up to an additive constant.*

Proof. It is sufficient to check that the difference of H_δ along cycles is always 0, or equivalently, the difference along elementary rectangles is always 0. Let u_1, u_2, v_2, v_1 be a rectangle as shown in Figure 4.6. We denote by e_{m_i} the mid-edge between u_i and v_i for $i = 1, 2$.

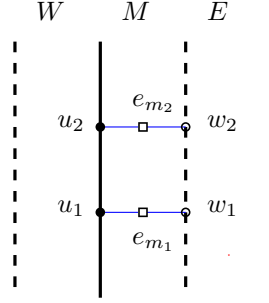

Figure 4.6: An elementary rectangle $u_1u_2w_2w_1$.

We need to show that the difference of H_δ along u_1u_2 , u_2w_2 , w_2w_1 and w_1u_1 gives 0. We apply directly the definitions from Equations (4.5), (4.6) and (4.7).

$$\begin{aligned} & H_\delta(u_2) - H_\delta(u_1) + H_\delta(w_2) - H_\delta(u_2) + H_\delta(w_1) - H_\delta(w_2) + H_\delta(u_1) - H_\delta(w_1) \\ &= 2 \operatorname{Im} \int_{u_1}^{u_2} F_\delta(e_v^-) \overline{F_\delta(e_v^+)} dv - \delta |F_\delta(u_2w_2)|^2 + 2 \operatorname{Im} \int_{w_1}^{w_2} F_\delta(e_v^-) \overline{F_\delta(e_v^+)} dv + \delta |F_\delta(u_1w_1)|^2 \\ &= 2 \operatorname{Im} \int_{m_1}^{m_2} [F_\delta(e_m^-) \overline{F_\delta(e_m)} + F_\delta(e_m) \overline{F_\delta(e_m^+)}] dm - \delta (|F_\delta(u_2w_2)|^2 - |F_\delta(u_1w_1)|^2). \end{aligned}$$

The first term can be rewritten as:

$$2 \operatorname{Im} \int_{m_1}^{m_2} [F_\delta(e_m^-) \overline{F_\delta(e_m)} + F_\delta(e_m) \overline{F_\delta(e_m^+)}] dm = 2 \operatorname{Im} \int_{m_1}^{m_2} [F_\delta(e_m^-) - F_\delta(e_m^+)] \overline{F_\delta(e_m)} dm,$$

and the second term as:

$$\begin{aligned} -\delta (|F_\delta(u_2w_2)|^2 - |F_\delta(u_1w_1)|^2) &= -\delta \operatorname{Re} \int_{m_1}^{m_2} 2 \partial_y F_\delta(e_m) \overline{F_\delta(e_m)} dm \\ &= -\operatorname{Re} \int_{m_1}^{m_2} 2i (F_\delta(e_m^+) - F_\delta(e_m^-)) \overline{F_\delta(e_m)} dm \\ &= 2 \operatorname{Im} \int_{m_1}^{m_2} [F_\delta(e_m^+) - F_\delta(e_m^-)] \overline{F_\delta(e_m)} dm \end{aligned}$$

where we use the holomorphic relation (4.4) in the second line. Thus, the quantity we were looking for is indeed 0. \square

From the previous proposition, we can fix $H_\delta(b_\delta^w)$ to be zero, thus fixing the additive constant. Now, we can really talk about *the* primitive H_δ .

Starting from the definitions above, we will reformulate to get relations for H_δ between different points on the same axis (Proposition 4.6) and neighboring points on medial lattice (Proposition 4.7). This will give us a simpler expression in terms of \mathcal{F}_δ : $H_\delta = \text{Im} \int^\delta (F_\delta(z))^2 d^\delta z$.

Proposition 4.6. *Let $p, p' \in \Omega_\delta^\circ$ such that $\text{Re } p = \text{Re } p'$ and $[pp'] \subset \Omega_\delta^\circ$. Then we have*

$$H_\delta(p') - H_\delta(p) = \text{Im} \int_p^{p'} i \cdot (\mathcal{F}_\delta(v))^2 dv. \quad (4.8)$$

Proof. We first assume that $p, p' \in \Omega_\delta$. Given $v \in [pp']$, since $F_\delta(e_v^-) \in i\nu\mathbb{R}$ and $F_\delta(e_v^+) \in \nu\mathbb{R}$, we have

$$\begin{aligned} \text{Im} [i \cdot \mathcal{F}_\delta(v)^2] &= \text{Re} [F_\delta(e_v^-)^2 + F_\delta(e_v^+)^2 + 2F_\delta(e_v^-)F_\delta(e_v^+)] \\ &= 2 \text{Re} [F_\delta(e_v^-)F_\delta(e_v^+)] \\ &= 2 \text{Im} [F_\delta(e_v^-)\overline{F_\delta(e_v^+)}]. \end{aligned}$$

The same computation for $p, p' \in \Omega_\delta^*$ and $v \in [pp']$ leads to

$$\text{Im} [i \cdot \mathcal{F}_\delta(v)^2] = -2 \text{Im} [F_\delta(e_v^-)\overline{F_\delta(e_v^+)}].$$

Using Equations (4.5) and (4.5), we get the result. \square

Proposition 4.7. *Let $p \in \Omega_\delta^\circ$ such that $p^-, p^+ \in \Omega_\delta^\circ$. Then,*

$$H_\delta(p^+) - H_\delta(p^-) = \text{Im}[\mathcal{F}_\delta(p)^2(p^+ - p^-)]. \quad (4.9)$$

Proof. We can assume that $p \in \Omega_\delta^*$ and $p^-, p^+ \in \Omega_\delta$. The other case when $p \in \Omega_\delta$ can be treated in the same way.

From the parallelism property, we know that $F_\delta(e_p^-) \in \nu\mathbb{R}$ and $F_\delta(e_p^+) \in i\nu\mathbb{R}$. A simple computation gives

$$\begin{aligned} \text{Im} [\mathcal{F}_\delta(p)^2] &= \text{Im} [F_\delta(e_p^-)^2 + F_\delta(e_p^+)^2 + 2F_\delta(e_p^-)F_\delta(e_p^+)] \\ &= |F_\delta(e_p^+)|^2 - |F_\delta(e_p^-)|^2. \end{aligned}$$

Since $p^+ - p^- = \delta$, this completes the proof. \square

Corollary 4.8. *The primitive H_δ is constant on both arcs $(a_\delta b_\delta) = (a_\delta^b b_\delta^b)$ and $(b_\delta a_\delta) = (b_\delta^w a_\delta^w)$. Moreover,*

$$H_{\delta|(a_\delta b_\delta)} = 1 \quad \text{and} \quad H_{\delta|(b_\delta a_\delta)} = 0. \quad (4.10)$$

Proof. Proposition 4.3 gives the direction of \mathcal{F}_δ and Equations (4.8) and (4.9) give the relation of H_δ on each part of the two arcs. We conclude easily that $\mathcal{F}_\delta(p)$ is constant on both arcs. The difference of these constants can be obtained by estimating H_δ at, for example, $b_\delta = [b_\delta^b b_\delta^w]$:

$$H_\delta(b_\delta^b) = H_\delta(b_\delta^b) - H_\delta(b_\delta^w) = \delta |F_\delta(b_\delta)|^2 = 1.$$

\square

Proposition 4.9. *The primitive H_δ is subharmonic on primal axes and superharmonic on dual axes, i.e.*

$$\Delta^{(\delta)}H(u) \geq 0 \quad \text{and} \quad \Delta^{(\delta)}H(w) \leq 0$$

for all $u \in \Omega_\delta$ and $w \in \Omega_\delta^*$.

Proof. We remind that in a semi-discrete lattice, the Laplacian is defined as follows:

$$\Delta_{xx}^{(\delta)}H_\delta(u) = \Delta_{xx}^{(\delta)}H_\delta(u) + \partial_{yy}H_\delta(u)$$

for u a vertex in primal or dual axis.

First, we assume that u is a primal vertex. By using the definition of H_δ , the second derivative along x can be reformulated,

$$\Delta_{xx}^{(\delta)}H_\delta(u) = \frac{1}{\delta} \left[|F_\delta(e_u^{++})|^2 - |F_\delta(e_u^+)|^2 - |F_\delta(e_u^-)|^2 + |F_\delta(e_u^{--})|^2 \right].$$

Similarly, the second derivative along y can be rewritten as:

$$\begin{aligned} \partial_{yy}H_\delta(u) &= 2 \operatorname{Im}[\partial_y(F_\delta(e_u^-)\overline{F_\delta(e_u^+)})] \\ &= 2 \operatorname{Im}[\partial_y F_\delta(e_u^-)\overline{F_\delta(e_u^+)} + F_\delta(e_u^-)\partial_y \overline{F_\delta(e_u^+)}] \\ &= 2 \operatorname{Im}[\partial_y F_\delta(e_u^-)\overline{F_\delta(e_u^+)} - \overline{F_\delta(e_u^-)}\partial_y F_\delta(e_u^+)] \\ &= 2 \operatorname{Im} \left[\frac{i}{\delta} [F_\delta(e_u^+) - F_\delta(e_u^{--})] \cdot \overline{F_\delta(e_u^+)} - \overline{F_\delta(e_u^-)} \cdot \frac{i}{\delta} [F_\delta(e_u^{++}) - F_\delta(e_u^-)] \right] \\ &= \frac{2}{\delta} \operatorname{Re}[(F_\delta(e_u^+) - F_\delta(e_u^{--}))\overline{F_\delta(e_u^+)} - \overline{F_\delta(e_u^-)}(F_\delta(e_u^{++}) - F_\delta(e_u^-))] \\ &= \frac{2}{\delta} \left[|F_\delta(e_u^+)|^2 + |F_\delta(e_u^-)|^2 - \operatorname{Re}[F_\delta(e_u^{--})\overline{F_\delta(e_u^+)} + \overline{F_\delta(e_u^-)}F_\delta(e_u^{++})] \right]. \end{aligned}$$

We also notice that

$$\begin{aligned} &|F_\delta(e_u^{++}) - F_\delta(e_u^-)|^2 + |F_\delta(e_u^+) - F_\delta(e_u^{--})|^2 \\ &= |F_\delta(e_u^{++})|^2 + |F_\delta(e_u^+)|^2 + |F_\delta(e_u^-)|^2 + |F_\delta(e_u^{--})|^2 \\ &\quad - 2 \operatorname{Re} \left[\overline{F_\delta(e_u^-)}F_\delta(e_u^{++}) + F_\delta(e_u^{--})\overline{F_\delta(e_u^+)} \right] \\ &= \delta \Delta_{xx}^{(\delta)}H_\delta(u) + \delta \partial_{yy}H_\delta(u) \\ &= \delta \Delta^{(\delta)}H_\delta(u). \end{aligned}$$

In consequence, the primitive H is subharmonic on primal axes.

The proof for the superharmonicity on dual axes is similar. We do the same calculation and obtain the above equation with a minus sign. \square

5 Uniform convergence theorem

5.1 Boundary modification trick

A semi-discrete Dobrushin domain can be extended to a (semi-discrete) primal (*resp.* dual) domain. This technique, called *boundary modification trick*, is presented below. We can also extend our (semi-discrete) functions on these larger domains, making them easier to study.

The primal (*resp.* dual) domain extended from a Dobrushin domain is given by keeping the primal boundary ∂_{ab} and by adding an extra layer ∂_{ba}^* to the dual boundary ∂_{ba} . More precisely, on the arc ∂_{ba} we change the horizontal parts from dual to primal and add one more primal layer *outside* (defined below) the original domain. The same procedure applies similarly if we want to get an extended dual domain: we get ∂_{ab}^* from ∂_{ab} and keep ∂_{ba}^* . We will denote by $\tilde{\Omega}_\delta$ and $\tilde{\Omega}_\delta^*$ these two modified domains. See Figure 5.1 and Figure 5.2 for examples.

Each dual point $p \in (b_\delta a_\delta)$ possesses two primal neighbors p^- and p^+ . One of them is in $\text{Int}\Omega_\delta^*$ and the other is not (although it may lie on the boundary ∂_{ab}). We include the one which is not in $\text{Int}\Omega_\delta^*$, thus providing us with the new boundary.

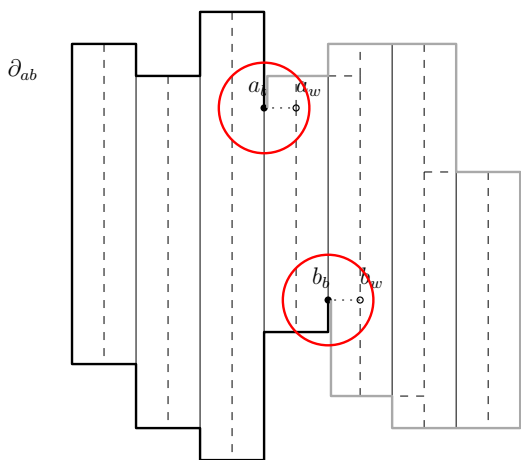

Figure 5.1: The primal domain extended from the Dobrushin domain given in Figure 2.3. The red part indicates the overlapping part of the extended boundary with the arc $(a_\delta b_\delta)$.

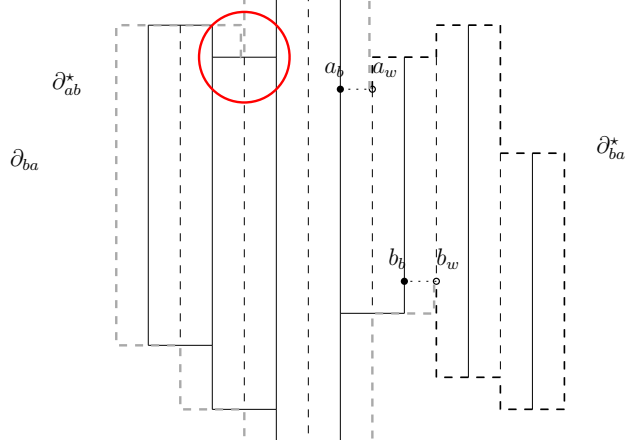

Figure 5.2: The dual domain extended from a Dobrushin domain given in Figure 2.3. The red part represents the extended boundary overlapping itself.

We notice that some points may be added twice (red part in Figure 5.2) and some points may overlap the other boundary (red part in Figure 5.1). Thus, the boundary of the extended domain is not described by a Jordan curve anymore. However, this is not a problem: we just keep these double points and consider that they are situated on the two different sides of the same boundary and all the theorems concerning boundary value problem will still be valid. We can also see this as a domain minus a slit.

The following lemma tells us how to extend the primitive H_δ to the extended domain after boundary modification trick.

Lemma 5.1. *Let $w \in \mathbb{L}_\delta^* \cap (b_\delta a_\delta)$ be a dual vertex on the arc $(b_\delta a_\delta)$. Assume u_{int} to be the neighboring primal vertex of w which is in the domain Ω_δ^* and u_{ext} the primal one to be added via boundary modification trick. Then, if we set $H_\delta(u_{ext}) = H(w)$, the function H_δ remains subharmonic at u_{int} . We can also extend H on $\tilde{\Omega}_\delta^*$ in a similar way, keeping a similar result.*

Proof. By abusing the notation, we continue writing F_δ , \mathcal{F}_δ and H_δ on the extended domain $\tilde{\Omega}_\delta$. We notice that if we let $F_\delta(u_{ext}w) = 0$ and $\mathcal{F}_\delta(w) = F_\delta(wu_{int})$, the properties in Proposition 4.4 are still satisfied. This can be computed by establishing a similar table as Table 4.3 on the boundary. Then, by setting $H_\delta(u_{ext}) = H(w)$, we get a primitive H_δ which always satisfies Equations (4.6) and (4.7). In such a way, the Proposition 4.9 still holds. \square

5.2 Riemann-Hilbert boundary value problem

We have studied Dirichlet problem in Section 3.3. The Riemann-Hilbert boundary value problem we are going to introduce is similar to this but its resolution is a bit more complicated. We will study it by making some links to the Dirichlet problem.

In a semi-discrete Dobrushin domain $(\Omega_\delta^\diamond, a_\delta, b_\delta)$, we say that a function F_δ defined on Ω_δ^\diamond is a solution to the *(semi-discrete) boundary value problem* with respect to the Dobrushin domain $(\Omega_\delta^\diamond, a_\delta, b_\delta)$ if the following three conditions are satisfied:

- (A) s-holomorphicity: \mathcal{F}_δ is s-holomorphic in Ω_δ^\diamond ;
- (B) boundary conditions: for $p \in (a_\delta b_\delta) \cup (b_\delta a_\delta)$, $\mathcal{F}_\delta(p)$ is parallel to $\tau(p)^{-1/2}$;
- (C) normalization: $F_\delta(e_b^\delta) = \text{Proj}[\mathcal{F}_\delta(b_\delta^w), \nu] = \frac{\nu}{\sqrt{\delta}}$.

Existence of such a solution has been shown already. In effect, the observable we introduced earlier satisfies these three conditions, as shown in Section 4.2. When it comes to uniqueness, we will use the primitive H we constructed in Section 4.3 along with the boundary modification trick.

Proposition 5.2 (Existence of solution). *The observable \mathcal{F}_δ given by (4.1) is a solution to the above boundary value problem.*

Proof. It is direct from the properties of the observable as shown in Propositions 4.4 and 4.3. \square

Proposition 5.3 (Uniqueness of solution). *For each semi-discrete Dobrushin domain $(\Omega_\delta^\diamond, a_\delta, b_\delta)$, the semi-discrete boundary value problem has a unique solution.*

Proof. Assume that there are two solutions $\mathcal{F}_{\delta,1}$ and $\mathcal{F}_{\delta,2}$ to the boundary value problem mentioned above. Let $\mathcal{F}_\delta := \mathcal{F}_{\delta,1} - \mathcal{F}_{\delta,2}$. Notice that \mathcal{F}_δ is still s-holomorphic being difference of two such functions. Consider $H_\delta := \text{Im} \int (\mathcal{F}_\delta(z))^2 dz$ the primitive defined in Section 4.3. The function H_δ is constant on the arcs $(a_\delta b_\delta)$ and $(b_\delta a_\delta)$ respectively. Moreover, the identity $\mathcal{F}_\delta(b_\delta) = 0$ says that these two constants should be the same. Apply the boundary modification trick to extend Ω_δ^\diamond into the primal domain $\tilde{\Omega}_\delta^\diamond$.

Extend the primitive H_δ to the new boundary of $\tilde{\Omega}_\delta^\diamond$ as in Lemma 5.1. The Lemma also says that H_δ stays subharmonic in $\mathbb{L}_\delta \cap \tilde{\Omega}_\delta^\diamond$ and subharmonic in $\mathbb{L}_\delta^* \cap \tilde{\Omega}_\delta^\diamond$. Then, we have $0 \geq (H_\delta)|_{\tilde{\Omega}_\delta^\diamond} \geq (H_\delta)|_{\tilde{\Omega}_\delta^*} \geq 0$ by uniqueness of Dirichlet problem (Proposition 3.17), H_δ is constant everywhere.

The fact that H_δ is constant everywhere on $\tilde{\Omega}_\delta^\diamond$ tells us that \mathcal{F}_δ is zero everywhere on Ω_δ^\diamond . Thus, these two solutions must be equal. \square

5.3 Convergence theorem

Theorem 5.4 (Convergence theorem for s -holomorphic functions). *Let $Q \subset \Omega$ be a rectangular domain such that $9Q \subset \Omega$. Let $(\mathcal{F}_\delta)_{\delta>0}$ be a family of s -holomorphic functions on Ω_δ° and $H_\delta = \text{Im} \int \mathcal{F}_\delta^2$. If $(H_\delta)_{\delta>0}$ is uniformly bounded on $9Q$, then (\mathcal{F}_δ) is precompact on Q .*

Remark 5.5. For each $z \in \text{Int}\Omega$, we can find a neighborhood Q of z small enough such that $9Q \subset \Omega$ to have precompactness of (\mathcal{F}_δ) near z . Then we can use a diagonal argument to extract a subsequence of (\mathcal{F}_δ) converging uniformly on all compacts of Ω .

Proof. It is sufficient to show the second point in Theorem 3.27. We write

$$\delta \int_{Q_\delta^\circ} |\mathcal{F}_\delta(v)|^2 dv = \delta \int_{Q_\delta} |\Delta_x^{(\delta)} H_\delta(x)| dx + \delta \int_{Q_\delta^*} |\Delta_x^{(\delta)} H_\delta(x)| dx$$

which is exactly the definition of H_δ in Proposition 4.7. These two terms can be treated in a similar way. We will thus just look at the first one and show that it is bounded by a constant uniformly in δ . On the primal semi-discretized domain $9Q_\delta$, write $H_\delta = S_\delta + R_\delta$ where S_δ is semi-discrete harmonic with boundary values $H_\delta|_{\partial 9Q_\delta}$ on $\partial 9Q_\delta$.

$$\begin{aligned} \int_{Q_\delta} |\Delta_x^{(\delta)} S_\delta(x)| dx &\leq \int_{Q_\delta} c_1 \cdot \sup_{9Q_\delta} |S_\delta| \leq \frac{c_2}{\delta} \cdot c_1 \cdot \sup_{9Q_\delta} |S_\delta| \\ &= \frac{c_1 c_2}{\delta} \sup_{\partial 9Q_\delta} |S_\delta| = \frac{c_3}{\delta} \sup_{\partial 9Q_\delta} |H_\delta| \leq \frac{c_4}{\delta}. \end{aligned}$$

Here, we use Proposition 3.25 in the first inequality; the total length of axes in Q_δ is proportional to δ^{-1} in the second; the maximum principle (Proposition 3.15) in the third; H_δ and S_δ coincide on the boundary $\partial 9Q_\delta$ in the fourth; and finally, H_δ is bounded by hypotheses. Moreover, the constants c_i may depend on the domain Ω but are uniform in δ .

We will now do something similar to R_δ . First, we write (Proposition 3.26)

$$R_\delta(x) = \int_{9Q_\delta} \Delta^{(\delta)} R_\delta(y) G_{9Q_\delta}(x, y) dy.$$

Since H is subharmonic, it is the same for R_δ . Thus, $\Delta^{(\delta)} R_\delta \geq 0$ in $9Q_\delta$. Then, we have

$$\begin{aligned} \int_{Q_\delta} |\Delta_x^{(\delta)} R_\delta(x)| dx &\leq \int_{Q_\delta} \int_{9Q_\delta} \Delta^{(\delta)} R_\delta(y) |\Delta_x^{(\delta)} G_{9Q_\delta}(x, y)| dy dx \\ &= \int_{9Q_\delta} \Delta^{(\delta)} R_\delta(y) \int_{Q_\delta} |\Delta_x^{(\delta)} G_{9Q_\delta}(x, y)| dx dy \\ &\leq \int_{9Q_\delta} c_5 \cdot \Delta^{(\delta)} R_\delta(y) \int_{Q_\delta} G_{9Q_\delta}(x, y) dx dy \\ &= c_5 \int_{Q_\delta} \int_{9Q_\delta} \Delta^{(\delta)} R_\delta(y) G_{9Q_\delta}(x, y) dy dx \\ &= c_5 \int_{Q_\delta} R_\delta(x) dx \\ &\leq c_5 \cdot \frac{c_6}{\delta} = \frac{c_5 c_6}{\delta} \end{aligned}$$

where we use the triangular inequality in the first line; Fubini in the second line (all the terms are non-negative); Proposition 3.28 in the third; Fubini again in the fourth, Riesz representation (Proposition 3.26) again in the fifth; and finally R_δ is bounded in the last one (because H_δ and S_δ are bounded). \square

With all what we have done so far, we can determine the uniform limit of H_δ and \mathcal{F}_δ when δ goes to 0. First of all, we need to describe the continuous version of the boundary-valued problem. Given a continuous Dobrushin domain (Ω, a, b) , we say that a function f defined on Ω is a solution to the *boundary-valued problem* if

- (a) holomorphicity: f is holomorphic in Ω with singularities at a and b ;
- (b) boundary conditions: $f(\zeta)$ is parallel to $\tau(\zeta)^{-1/2}$ for $\zeta \in \partial\Omega \setminus \{a, b\}$, where $\tau(\zeta)$ denotes the tangent vector to Ω oriented from a to b (on both arcs);
- (c) normalization: the function $h := \text{Im} \int (f(\zeta))^2 d\zeta$ is uniformly bounded in Ω and

$$h|_{(a_\delta b_\delta)} = 0, \quad h|_{(b_\delta a_\delta)} = 1.$$

Note that (a) and (b) guarantee that h is harmonic in Ω and constant on both boundary arcs (ab) and (ba) . Thus, if we write Φ the conformal mapping from Ω onto the infinite strip $\mathbb{R} \times (0, 1)$ sending a and b to $\mp\infty$, the function $h \circ \Phi^{-1}$ is still harmonic. Moreover, the harmonic function on the strip $\mathbb{R} \times (0, 1)$ with boundary condition 1 on $\mathbb{R} \times \{1\}$ and 0 on $\mathbb{R} \times \{0\}$ is $\text{Im}(z)$, we obtain that $h(z) = \text{Im} \Phi(z)$. And from the definition of h in (c), we get

$$h(v) - h(u) = \text{Im}(\Phi(v) - \Phi(u)) = \text{Im} \int_u^v (f(\zeta))^2 d\zeta$$

for $u, v \in \Omega$. At u fixed, since $\Phi(v) - \Phi(u)$ and $\int_u^v (f(\zeta))^2 d\zeta$ are both holomorphic in v and have the same imaginary part, they differ only by a real constant. By taking the derivative, we can deduce that

$$\Phi'(v) = f(v)^2$$

or equivalently,

$$f = \sqrt{\Phi'}.$$

Since Φ is a conformal map, its derivative is never 0 on Ω , we can define the square root in a continuous manner (with respect to Ω), and the solution f is well-defined up to the sign. Moreover, this tells us that $f(\zeta) = c(\zeta)\tau(\zeta)^{-1/2}$ for all $\zeta \in \partial\Omega \setminus \{a, b\}$ where c keeps the same sign all along the boundary. Therefore, we can choose the branch of the logarithm such that $\sqrt{\Phi'}$ corresponds to c positive and $-\sqrt{\Phi'}$ corresponds to c negative. Actually, if we look around b , this branch is given by $\sqrt{1} = 1$.

Theorem 5.6. *The solutions F_δ of the semi-discrete boundary value problems are uniformly close in any compact subset of Ω to their continuous counterpart f defined by (a), (b) and (c). In other words, F_δ converges uniformly on all compact sets of Ω to $\sqrt{\Phi'}$ where Φ is any conformal map from Ω to $\mathbb{R} \times (0, 1)$ mapping a and b to $\mp\infty$ respectively.*

Proof. We start by showing the convergence of the discrete primitive $H_\delta := \text{Im} \int_\delta (\mathcal{F}_\delta(\zeta))^2 d\zeta$, using the boundary modification trick introduced in Section 5.1. We extend H_δ on $\tilde{\Omega}_\delta$ and denote its restriction on the primal axes \tilde{H}_δ^\bullet . By Lemma 5.1, \tilde{H}_δ^\bullet is still subharmonic, thus it is smaller than the harmonic function h_δ^\bullet with boundary condition 0 on $(a_\delta b_\delta)$ and 1 on $(b_\delta a_\delta)$. Proposition 3.30 tells that h_δ^\bullet converges to the solution H of the continuous Dirichlet boundary problem with boundary conditions 0 on ∂_{ab} and 1 on ∂_{ba} . We can deduce that

$$\limsup_{\delta \rightarrow 0} \tilde{H}_\delta^\bullet \leq h$$

on any compact subset of Ω . In a similar manner, denote \tilde{H}_δ° the function H_δ extended on $\tilde{\Omega}_\delta^*$ which is restricted on dual axes. As before, this time by superharmonicity, we deduce that

$$\liminf_{\delta \rightarrow 0} \tilde{H}_\delta^\circ \geq h$$

on any compact subset of Ω . By definition (Equation (4.7)), for a sequence of w_δ and b_δ neighbors in Ω_δ , both approximating $u \in \Omega$ (i.e. $w_\delta \rightarrow u$, $b_\delta \rightarrow u$), we have

$$h(u) \leq \liminf_{\delta \rightarrow 0} \tilde{H}_\delta^\circ(w_\delta) \leq \limsup_{\delta \rightarrow 0} \tilde{H}_\delta^\circ(b_\delta) \leq h(u).$$

Since the convergence to h on $\tilde{\Omega}_\delta$ and $\tilde{\Omega}_\delta^*$ is uniform on compact subsets, it is the same for the convergence of both \tilde{H}_δ^\bullet and \tilde{H}_δ° .

Consider $Q \subset \Omega$ such that $9Q \subset \Omega$. By the uniform convergence of H_δ , the family (H_δ) is bounded uniformly in $\delta > 0$ on $9Q$. Theorem 5.4 implies that \mathcal{F}_δ is a precompact family of semi-discrete s-holomorphic functions on Q .

Consider δ_n a subsequence such that \mathcal{F}_{δ_n} converges uniformly on all compact subsets of Ω_δ to \mathcal{F} . For $u, v \in \Omega_\delta$ and converging subsequences $u_n \rightarrow u$ and $v_n \rightarrow v$, we have

$$\begin{aligned} h(v) - h(u) &= \lim_{n \rightarrow \infty} (H_{\delta_n}(v_n) - H_{\delta_n}(u_n)) \\ &= \lim_{n \rightarrow \infty} \text{Im} \int_{v_n}^{u_n} \mathcal{F}_{\delta_n}(z)^2 dz \\ &= \text{Im} \int_v^u \mathcal{F}(z)^2 dz. \end{aligned}$$

Same as the discussion just above, the limit \mathcal{F} is given by $\sqrt{\Phi'}$ where Φ is any conformal map from Ω to $\mathbb{R} \times (0, 1)$ mapping a and b to $\mp\infty$. \square

5.4 RSW property: random-current representation

In the previous section, we established the conformal invariance of the limit of our semi-discrete observables. To show that the interface is given by an SLE curve in the limit and to determine its parameter, we need the so-called RSW property. This provides the hypothesis needed in [KS12] which, along with Theorem 5.6, shows the main Theorem 2.1.

The goal of this section is to show the following property.

Proposition 5.7 (RSW property). *Let $\alpha > 0$. Consider $R_{n,\alpha} = [-n, n] \times [-\alpha n, \alpha n]$ a rectangular domain and write $R_{n,\alpha}^\delta$ for its semi-discretized counterpart (primal domain). Let ξ a boundary condition on $R_{n,\alpha}^\delta$. Then, there exists $c(\alpha) > 0$ independent of n and δ such that*

$$\begin{aligned} c &\leq \mathbb{P}^\xi(\mathcal{C}_h(R_{n,\alpha}^\delta)) \leq 1 - c, \\ c &\leq \mathbb{P}^\xi(\mathcal{C}_v(R_{n,\alpha}^\delta)) \leq 1 - c \end{aligned}$$

where \mathcal{C}_h and \mathcal{C}_v denote the events “having a horizontal / vertical crossing”.

The proof of Proposition 5.7 is based on the use of the same fermionic observable introduced in Section 4 and the second moment method to estimate the crossing probabilities. This idea comes from [DCHN11] where the classical Ising case is treated and here we adapt the proof to the case of quantum Ising.

To show the RSW property in Proposition 5.7, we only need to show the lower bound for free boundary condition by duality [DCHN11]. In this section, we will just show the property for the horizontal crossing, since the proof to estimate the probability of the vertical crossing is similar.

We recall that $(\Omega_\delta^\circ, a_\delta, b_\delta)$ is a Dobrushin domain, meaning that the arc $(a_\delta b_\delta)$ is wired and the arc $(b_\delta a_\delta)$ is free. In Section 5.1, we introduced the notion of modified primal and dual domains of a Dobrushin domain, which are denoted by $\tilde{\Omega}_\delta$ and $\tilde{\Omega}_\delta^*$ respectively. Let us write HM_\bullet and HM_\circ the harmonic functions on modified domains $\tilde{\Omega}_\delta$ and $\tilde{\Omega}_\delta^*$ having boundary conditions 1 on the (extended) wired arc (∂_{ab} for $\tilde{\Omega}_\delta$ and ∂_{ab}^* for $\tilde{\Omega}_\delta^*$) and 0 on the (extended) free arc (∂_{ba} for $\tilde{\Omega}_\delta$ and ∂_{ba}^* for $\tilde{\Omega}_\delta^*$).

We start by noticing that the connection probability of a vertex next to the free arc $(b_\delta a_\delta)$ to the wired arc $(a_\delta b_\delta)$ can be written in a simple way by using the parafermionic observable.

Proposition 5.8. *Let $u \in \Omega_\delta$ such that $\{u^+, u^-\} \cap (b_\delta a_\delta) \neq \emptyset$ (equivalently, u is next to the free arc). Write e for the mid-edge between u and the free arc $(b_\delta a_\delta)$. Then, we have*

$$\mathbb{P}_{(\Omega_\delta^\circ, a_\delta, b_\delta)}(u \leftrightarrow (a_\delta b_\delta))^2 = \delta |F(e)|^2.$$

Proof. We take the definition of F ,

$$\begin{aligned} \delta |F(e)|^2 &= \left| \mathbb{E}_{(\Omega_\delta^\circ, a_\delta, b_\delta)} \left[\exp \left(\frac{i}{2} W(e, b_\delta) \right) \mathbb{1}_{e \in \gamma_\delta} \right] \right|^2 \\ &= \left| \mathbb{E}_{(\Omega_\delta^\circ, a_\delta, b_\delta)} [\mathbb{1}_{e \in \gamma_\delta}] \right|^2 = \mathbb{P}_{(\Omega_\delta^\circ, a_\delta, b_\delta)}(e \in \gamma_\delta)^2 \end{aligned}$$

where the winding $W(e, b_\delta)$ is always a constant if e is adjacent to the boundary. We also notice that $e \in \gamma_\delta$ is equivalent to u connected to the wired arc $(a_\delta b_\delta)$. \square

By using harmonic functions HM_\bullet and HM_\circ , we can get easily the following proposition.

Proposition 5.9. *Let $u \in \Omega_\delta$ next to the free arc. Write $w \in \{u^+, u^-\}$ which is not on the free arc. We have*

$$\sqrt{\text{HM}_\circ(w)} \leq \mathbb{P}_{(\Omega_\delta^\circ, a_\delta, b_\delta)}(u \leftrightarrow (a_\delta b_\delta)) \leq \sqrt{\text{HM}_\bullet(u)}$$

Proof. Write w_∂ the neighbor of u which is on the free arc. We have

$$H(u) = H(u) - H(w_\partial) = \delta|F(e)|^2 = \mathbb{P}_{(\Omega_\delta^\circ, a_\delta, b_\delta)}(u \leftrightarrow (a_\delta b_\delta))^2.$$

Moreover, by Lemma 5.1, H is subharmonic on $\tilde{\Omega}_\delta$, we get $H(u) \leq \text{HM}_\bullet(u)$. Similarly, writing $e = (uw)$,

$$H(w) = \delta|F(e)|^2 - \delta|F(e')|^2 \leq \delta|F(e)|^2 = \mathbb{P}_{(\Omega_\delta^\circ, a_\delta, b_\delta)}(u \leftrightarrow (a_\delta b_\delta))^2$$

and we conclude by superharmonicity of H on $\tilde{\Omega}_\delta^*$. \square

Now, we are ready to show the RSW property. We keep the same notation as in the statement of Proposition 5.7. We write ∂_- and ∂_+ for the left and right (primal) borders of $R_{n,\alpha}^\delta$. We define the random variable N given by the 2D Lebesgue measure of the subset of $\partial_- \times \partial_+ \subset \mathbb{R}^2$ consisting of points which are connected in $R_{n,\alpha}^\delta$. More precisely,

$$N = \iint_{\substack{x \in \partial_- \\ y \in \partial_+}} \mathbb{1}_{x \leftrightarrow y} dx dy.$$

To show Proposition 5.7, we use the second moment method. In other words, by using Cauchy-Schwarz, we need to show that the lower bound of

$$\mathbb{P}^0(N > 0) = \mathbb{E}^0[\mathbb{1}_{N>0}^2] \geq \frac{\mathbb{E}^0[N]^2}{\mathbb{E}^0[N^2]} \quad (5.1)$$

is uniform in n and δ . First, we get a lower bound for $\mathbb{E}^0[N]$.

Lemma 5.10. *There exists a uniform constant c independent of n and δ such that*

$$\mathbb{E}^0[N] \geq cn.$$

Proof. We decompose the right boundary into $m = \lfloor n/\delta \rfloor$ parts,

$$\partial_+ = \bigcup_{i=0}^{m-1} \partial_+^i \text{ where } \partial_+^i = \left(\{\alpha n\} \times \left(-n + i \cdot \frac{2n}{m}, -n + (i+1) \cdot \frac{2n}{m} \right) \right).$$

We expand the expectation,

$$\begin{aligned} \mathbb{E}^0[N] &= \iint_{\substack{x \in \partial_- \\ y \in \partial_+}} \mathbb{P}^0(x \leftrightarrow y) dx dy \\ &= \int_{x \in \partial_-} \sum_{i=0}^{m-1} \mathbb{P}^0(x \leftrightarrow \partial_+^i) dx. \end{aligned}$$

By Proposition 5.9, each $\mathbb{P}^0(x \leftrightarrow \partial_+^i)$ can be bounded from below by $\text{HM}_\circ(w)$ where w is a neighbor of x which is not on the free arc, and the harmonic measure is with respect to the modified domain $\tilde{\Omega}_\delta^*$ where the Dobrushin domain $(\Omega_\delta^\circ, a_\delta, b_\delta)$ is given by $\Omega_\delta^\circ = R_{n,\alpha}^\delta$, a_δ and b_δ such that $\partial_+^i = (a_\delta b_\delta)$. Moreover, from the local central limit and gambler's ruin-type estimate, we have that $\text{HM}_\circ(w) \geq c(\delta/n)^2$ for a $c > 0$ uniform in n , δ and i .

Finally, we get

$$\mathbb{E}^0[N] \geq \int_{x \in \partial_-} m \cdot \sqrt{c} \frac{\delta}{n} dx \geq c'n$$

where c' is a uniform constant. \square

To estimate $\mathbb{E}^0[N^2]$, we need Proposition 5.11, a consequence of Lemma 5.12. Both of them make use of the so-called *exploration path*, which is the interface between the primal wired cluster and the dual free cluster. The proof in the discrete case [DCHN11] can be easily adapted to the semi-discrete case, since the interface is well-defined and we have similar estimates on harmonic functions, by means of semi-discrete Brownian motion, local central limit and gambler's ruin-type estimates. Therefore, we will just give the proof of Lemma 5.12.

For any given α, n and δ , let us consider $R_{n,\alpha}$ as before and $(R_{n,\alpha}^\delta, a_\delta, b_\delta)$ the semi-discretized Dobrushin domain obtained from $R_{n,\alpha}$ with the right boundary $\partial_+ = (a_\delta b_\delta)$ which is wired.

Proposition 5.11 ([DCHN11, Proposition 14]). *There exists a constant $c > 0$ which is uniform in α and n such that for any rectangle $R_{n,\alpha}^\delta$ and any two points $x, z \in \partial_-$, we have*

$$\mathbb{P}_{(R_{n,\alpha}^\delta, a_\delta, b_\delta)}(x, z \leftrightarrow \partial_+) = \mathbb{P}_{R_{n,\alpha}^\delta}^0(x, z \leftrightarrow \partial_+) \leq \frac{c}{\sqrt{|x - z|n}}$$

Lemma 5.12 ([DCHN11, Lemma 15]). *There exists a constant $c > 0$ which is uniform in α, n, δ and $x \in \partial_-$ such that for any rectangle $R_{n,\alpha}^\delta$ and all $k \geq 0$,*

$$\mathbb{P}_{(R_{n,\alpha}^\delta, a_\delta, b_\delta)}(B_\delta(x, k) \leftrightarrow (a_\delta b_\delta)) \leq c\sqrt{\frac{k}{n}}.$$

Proof. Let $n, k, \delta, \alpha > 0$, the rectangular domain $R_{n,\alpha}^\delta$ and its semi-discrete counterpart, the Dobrushin domain $(R_{n,\alpha}^\delta, a_\delta, b_\delta)$ where $\partial_+ = (a_\delta b_\delta)$ is the wired arc. Consider $x \in \partial_-$. For $k \geq n$, the inequality is trivial, so we can assume $k < n$.

Since the probability $\mathbb{P}_{(R_{n,\alpha}^\delta, a_\delta, b_\delta)}(B_\delta(x, k) \leftrightarrow (a_\delta b_\delta))$ is non-decreasing in α , we can bound it by above by replacing α by $\alpha + 1$, which we bound by above by a longer wired arc $(c_\delta d_\delta)$, where c_δ and d_δ are respectively the left-bottom and the left-top points of the rectangular domain $R_{n,\alpha}^\delta$. See Figure 5.3 for notations.

$$\begin{aligned} \mathbb{P}_{(R_{n,\alpha}^\delta, a_\delta, b_\delta)}(B_\delta(x, k) \leftrightarrow (a_\delta b_\delta)) &\leq \mathbb{P}_{(R_{n,\alpha+1}^\delta, a_\delta, b_\delta)}(B_\delta(x, k) \leftrightarrow (a_\delta b_\delta)) \\ &\leq \mathbb{P}_{(R_{n,\alpha+1}^\delta, c_\delta, d_\delta)}(B_\delta(x, k) \leftrightarrow (c_\delta d_\delta)) \end{aligned}$$

Let γ_δ be the interface as defined in Section 2.3 and used in Section 4 to define the fermionic observable. The definition of γ_δ tells us that the ball $B_\delta(x, k)$ is connected to the wired arc if and only if γ_δ goes through a mid-edge which is adjacent to the ball. We parametrize γ_δ by its length and denotes T the hitting time of the set of the mid-edges adjacent to the ball $B_\delta(x, k)$. Therefore, $B_\delta(x, k)$ is connected to the wired arc if and only if $T < \infty$.

Write p for the top-most point of $B_\delta(x, k)$. We can rewrite the probability of $\{p \leftrightarrow (c_\delta d_\delta)\}$ by conditioning on $\gamma_\delta[0, T]$ and using Markov domain property to obtain

$$\begin{aligned} \mathbb{P}_{(R_{n,\alpha+1}^\delta, c_\delta, d_\delta)}(p \leftrightarrow (c_\delta d_\delta)) &= \mathbb{E}_{(R_{n,\alpha+1}^\delta, c_\delta, d_\delta)}[\mathbb{1}_{T < \infty} \mathbb{P}_{(R_{n,\alpha+1}^\delta, c_\delta, d_\delta)}(p \leftrightarrow (c_\delta d_\delta) \mid \gamma_\delta[0, T])] \\ &= \mathbb{E}_{(R_{n,\alpha+1}^\delta, c_\delta, d_\delta)}[\mathbb{1}_{T < \infty} \mathbb{P}_{(R_{n,\alpha+1}^\delta \setminus \gamma_\delta[0, T], \gamma_\delta(T), d_\delta)}(p \leftrightarrow (c_\delta d_\delta))]. \end{aligned}$$

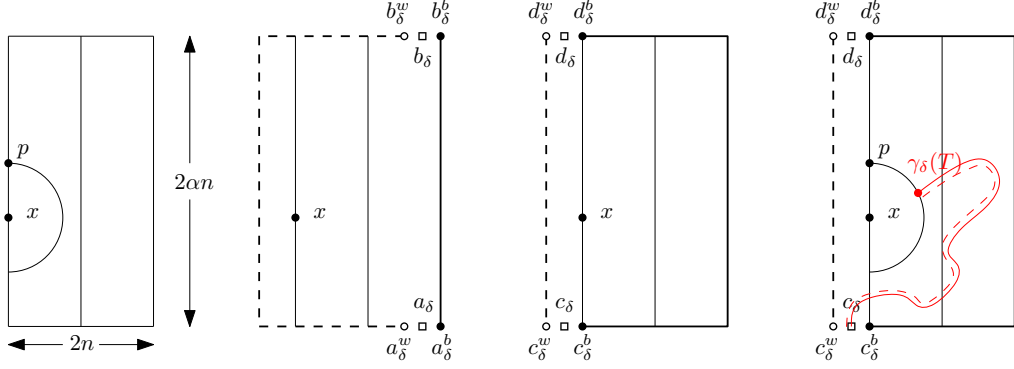

Figure 5.3: *First:* The primal domain $R_{n,\alpha}^\delta$. *Second:* The Dobrushin domain $(R_{n,\alpha}^\delta, a_\delta, b_\delta)$. *Third:* The Dobrushin domain $(R_{n,\alpha}^\delta, c_\delta, d_\delta)$. *Fourth:* The exploration path starting at c_δ and touching $B_\delta(x, k)$ at time T .

We estimate this quantity in two different ways to get the desired inequality. Firstly, since p is at distance at least n from the wired arc, we have

$$\mathbb{P}_{(R_{n,\alpha+1}^\delta, c_\delta, d_\delta)}(p \leftrightarrow (c_\delta d_\delta)) \leq \frac{c_1}{\sqrt{n}},$$

which follows from Proposition 5.9 and the fact that $\text{HM}_\bullet \leq \frac{c}{n}$. Secondly, we can write $\gamma_\delta(T)$ as $z + (s, -r, s)$ where $0 \leq s \leq k$ and $0 \leq r \leq 2k$. Thus, the line $z + \mathbb{Z} \times \{-r\}$ disconnects a from the free arc, we estimate the harmonic function and we obtain a.s.

$$\mathbb{P}_{(R_{n,\alpha+1}^\delta \setminus \gamma_\delta[0,T], \gamma_\delta(T), d_\delta)}(p \leftrightarrow (c_\delta d_\delta)) \geq \frac{c_2}{\sqrt{r}} \geq \frac{c_2}{\sqrt{2k}}$$

which again comes from Proposition 5.9 and the estimate $\text{HM}_\circ \geq \frac{c}{r}$. This final estimate being uniform in $\gamma_\delta[0, T]$, we get

$$\frac{c_2}{\sqrt{2k}} \mathbb{P}_{(R_{n,\alpha+1}^\delta, c_\delta, d_\delta)}(T < \infty) \leq \mathbb{P}_{(R_{n,\alpha+1}^\delta, c_\delta, d_\delta)}(p \leftrightarrow (c_\delta d_\delta)) \leq \frac{c_1}{\sqrt{n}}.$$

which implies the statement. \square

Now, we can complete the proof of the RSW property.

Proof of Proposition 5.7. From Equation (5.1) and Lemma 5.10, we just need to show that

$$\mathbb{E}^0[N^2] = \iiint \mathbb{P}^0(x \leftrightarrow y, z \leftrightarrow t) dx dy dz dt \quad (5.2)$$

is $\mathcal{O}(n^2)$.

Consider $x, z \in \partial_-$, $y, t \in \partial_+$ and l the middle vertical line separating them, we get

$$\mathbb{P}^0(x \leftrightarrow y, z \leftrightarrow t) \leq \mathbb{P}^0(x, z \leftrightarrow l) \mathbb{P}^0(y, t \leftrightarrow l)$$

because the left-hand side of l and the right-hand side of l are independent. Therefore, the integral in Equation (5.2) can be cut into two independent parts, each of whom gives the same contribution,

$$\begin{aligned}
& \iiint\limits_{\substack{x,z \in \partial_- \\ y,t \in \partial_+}} \mathbb{P}^0(x \leftrightarrow y, z \leftrightarrow t) dx dy dz dt \\
&= \left(\iint_{x,z \in \partial_-} \mathbb{P}^0(x, z \leftrightarrow l) dx dz \right) \left(\iint_{y,t \in \partial_+} \mathbb{P}^0(y, t \leftrightarrow l) dy dt \right) \\
&= \left(\iint_{x,z \in \partial_-} \mathbb{P}^0(x, z \leftrightarrow l) dx dz \right)^2 \\
&\leq \left(\iint_{x,z \in \partial_-} \frac{c}{\sqrt{|x-z|n}} dx dz \right)^2 \leq (4cn)^2
\end{aligned}$$

where in the last line we use Proposition 5.11.

The proof is thus complete. \square

Here we give a brief idea to the proof for the vertical crossing. To start with, we need to establish propositions similar to Propositions 5.8 and 5.9. We will get $\sqrt{\partial_y \text{HM}_\bullet}$ and $\sqrt{\partial_y \text{HM}_\circ}$ in the statement. And to estimate these harmonic functions, we can use Harnack Principle (Proposition 3.25) to get the correct orders. Then, the end of the story is the same, since we can always define the exploration path and get the same estimates (Lemmas 5.10 and 5.11).

5.5 Conclusion: proof of the main Theorem

We have all the necessary ingredients to conclude the proof of the main Theorem:

1. The RSW property shown in the previous section gives the G2 condition mentioned in [KS12], giving as conclusion that the family of interfaces (γ_δ) is tight for the weak convergence.
2. The fact that the fermionic observable (seen as an exploration process) is a martingale and is conformally invariant allows us to identify the limit via Itô's formula. More precisely, if γ is a subsequential limit of the interface parametrized by a Löwner chain W , from property of martingales and Itô's formula, we prove that (W_t) and $(W_t^2 - \kappa t)$ are both martingales ($\kappa = 16/3$ for quantum FK-Ising). The computation is exactly the same as in the limit of the classical FK-Ising since we have the same Riemann-Hilbert Boundary value problem in continuum and same martingales. Readers who are interested in more details, see [DCS12, DC13].

A Computation of residues

For a non-negative integer k and $m \in \mathbb{Z}$, define

$$g_{k,m}(z) := \frac{1}{z} \left(\frac{1}{z+1} + \frac{1}{z-1} \right)^k \left(\frac{z+1}{z-1} \right)^{2m} = \frac{2^k z^{k-1}}{(z-1)^{k+2m} (z+1)^{k-2m}}.$$

Lemma A.1. When $k = 0$, we have $\text{Res}(g_{k,m}, 1) = \text{Res}(g_{k,m}, -1) = 0$ for all m .

Proof. When $m = 0$, the result is trivial. Assume $m \in \mathbb{N}^*$, the function $g_{k,m}$ does not have any pole at -1 , so it is clear that $\text{Res}(g_{k,m}, -1) = 0$. The residue of $g_{k,m}(z)$ at $z = 1$ is the residue of $g_{k,m}(y + 1)$ at $y = 0$. We have

$$\begin{aligned} g_{k,m}(y + 1) &= \frac{1}{y + 1} \left(1 + \frac{2}{y}\right)^{2m} \\ &= \left[\sum_{k \geq 0} (-y)^k \right] \left[\sum_{l=0}^{2m} \binom{2m}{l} \left(\frac{2}{y}\right)^l \right], \end{aligned}$$

thus the coefficient of $\frac{1}{y}$ is given by

$$\sum_{l=1}^{2m} \binom{2m}{l} 2^l (-1)^{l-1} = -[(1 - 2)^{2m} - 1] = 0.$$

When m is negative, the proof is similar. □

Lemma A.2. For $k \geq 1$, we have $\text{Res}(g_{k,m}, 1) + \text{Res}(g_{k,m}, -1) = 0$.

Proof. When $k \geq 1$, the singularity at 0 is removable. We observe that $|g_{k,m}(z)|$ behaves like $|z|^{-k-1} \leq |z|^{-2}$ when $|z|$ is large, giving

$$\lim_{R \rightarrow \infty} \frac{1}{2\pi i} \int_{\partial B(0,R)} g_{k,m}(z) dz = 0.$$

Moreover, when $R > 1$,

$$\frac{1}{2\pi i} \int_{\partial B(0,R)} g_{k,m}(z) dz = \text{Res}(g_{k,m}, -1) + \text{Res}(g_{k,m}, 1),$$

giving us the wanted result. □

Lemma A.3. For $k \geq 1$ and $k \leq 2|m|$, $\text{Res}(g_{k,m}, 1) = \text{Res}(g_{k,m}, -1) = 0$.

Proof. We use the previous lemma. It is enough to show that the residue is zero at either 1 or -1 . If m is positive, we notice that $g_{k,m}(z)$ does not have any pole at -1 , thus the residue at -1 is zero. If m is negative, the residue at 1 is zero. □

Lemma A.4. More generally, for all k even integer,

$$\text{Res}(g_{k,m}, 1) = \text{Res}(g_{k,m}, -1) = 0.$$

Proof. Assume that $k = 2l > m \geq 0$ for a positive integer l . Look at the residue of $g_{k,m}(z)$ around $z = 1$ is equivalent to looking at the residue of $g_{k,m}(y + 1)$ around $y = 0$,

$$\text{Res}(g_{k,m}(z), z = 1) = \text{Res}(g_{k,m}(y + 1), y = 0).$$

We have the following equivalent relations

$$\begin{aligned}
& \text{Res}(g_{2l,m}(y+1), y=0) = 0 \\
\Leftrightarrow & \text{Res}\left(\frac{(y+1)^{2l-1}}{y^{2l+2m}(y+2)^{2l-2m}}, y=0\right) = 0 \\
\Leftrightarrow & \frac{(1+y)^{2l-1}}{\left(1+\frac{y}{2}\right)^{2l-2m}} [y^{2l+2m-1}] = 0
\end{aligned}$$

We develop the rational fraction to evaluate this coefficient where the following three identities are useful,

$$\binom{2m-2l}{2m+p} = (-1)^{2m+p} \binom{2l+p-1}{2m+p} \quad (\text{A.1})$$

$$\binom{2l+p-1}{2m+p} = \sum_{q=0}^{2l-1} \binom{p}{q} \binom{2l-1}{2m+p-q}, \quad (\text{A.2})$$

$$\sum_{k=0}^n \binom{n}{k} \binom{k}{r} (-x)^k = (-x)^r (1-x)^{n-r} \binom{n}{r}. \quad (\text{A.3})$$

Equation (A.1) comes from the general definition of binomial coefficients, here $2m-2l < 0$. Equation (A.2) is an easy combinatorial identity and Equation (A.3) a simple development. Then,

$$\begin{aligned}
& \sum_{p=0}^{2l-1} \binom{2l-1}{p} \left(\frac{1}{2}\right)^{2l+2m-1-p} \binom{2m-2l}{2l+2m-1-p} \\
(p \rightsquigarrow 2l-1-p) &= \sum_{p=0}^{2l-1} \binom{2l-1}{p} \left(\frac{1}{2}\right)^{2m+p} \binom{2m-2l}{2m+p} \\
&= \sum_{p=0}^{2l-1} \binom{2l-1}{p} \left(-\frac{1}{2}\right)^{2m+p} \binom{2l+p-1}{2m+p} \\
(\text{Equation (A.2)}) &= \sum_{p=0}^{2l-1} \binom{2l-1}{p} \left(-\frac{1}{2}\right)^{2m+p} \sum_{q=0}^{2l-1} \binom{p}{q} \binom{2l-1}{2m+p-q} \\
(q \rightsquigarrow p-q) &= \sum_{p=0}^{2l-1} \binom{2l-1}{p} \left(-\frac{1}{2}\right)^{2m+p} \sum_{q=0}^{2l-1} \binom{p}{q} \binom{2l-1}{2m+q} \\
&= \left(\frac{1}{2}\right)^{2m} \sum_{q=0}^{2l-1} \binom{2l-1}{2m+q} \sum_{p=0}^{2l-1} \binom{2l-1}{p} \binom{p}{q} \left(-\frac{1}{2}\right)^p \\
(\text{Equation (A.3)}) &= \left(\frac{1}{2}\right)^{2m} \sum_{q=0}^{2l-1} \binom{2l-1}{2m+q} \left(-\frac{1}{2}\right)^q \left(\frac{1}{2}\right)^{2l-1-q} \binom{2l-1}{q} \\
&= \left(\frac{1}{2}\right)^{2m+2l-1} \sum_{q=0}^{2l-1} (-1)^q \binom{2l-1}{2m+q} \binom{2l-1}{2l-1-q} = 0
\end{aligned}$$

where the last sum in the final quantity is the coefficient in front of $x^{2m+2l-1}$ in $(1-x)^{2l-1}(1+x)^{2l-1} = (1-x^2)^{2l-1}$, which is zero because the polynomial only contains monomials of even degree. \square

Proposition A.5. For $\zeta \in \mathbb{L}_\delta$, let f_ζ as defined in 3.4. Consider C a path as defined in Proposition 3.18. Then,

$$\int_C f_\zeta(z) dz = 0.$$

Proof. We will develop the exponential into series and show that this integral is zero for all terms. We can do this because exponential converges uniformly on all compacts, it makes sense to exchange integral and series. After developping, we get

$$f_\zeta(z) = \sum_{k \geq 0} (2it)^k g_{k,m}(z)$$

and Lemma A.2 allows us to conclude. \square

Proposition A.6. Around $\zeta = m \in \mathbb{Z} \setminus \{0\}$, the function G_δ is \mathcal{C}^∞ .

Proof. To show this, we need to check that for all $k \in \mathbb{N}$, we have

$$\int_C g_{k,m}(z) \ln_1(z) dz = \int_C g_{k,m}(z) \ln_2(z) dz$$

where \ln_i is chosen such that $\ln_i(1) - \ln_i(-1) = (-1)^i i \pi$. Here, \ln_1 corresponds the logarithm we chose in the upper half-plane and \ln_2 in the lower half-plane. From Proposition A.5, we can fix a lift of logarithm, for example $\ln_1(1) = \ln_2(1) = 0$ and $\ln_1(-1) = i\pi$ and $\ln_2(-1) = -i\pi$.

Let I_1 the integral on the left-hand side and I_2 the one on the right-hand side. Since $\ln_1 - \ln_2$ is constant in a small neighborhood of 1 and -1 , we can write

$$\begin{aligned} I_1 - I_2 &= \text{Res}(g_{k,m}(z)[\ln_1(z) - \ln_2(z)], z = -1) \\ &= 2i\pi \text{Res}(g_{k,m}(z), z = -1), \end{aligned}$$

whose value is zero according to Lemmas A.3 and A.4. \square

References

- [AKN93] Michael Aizenman, A Klein, and C Newman. Percolation methods for disordered quantum Ising models. Technical report, PRE-33973, 1993.
- [BG09] J. E. Björnberg and G. R. Grimmett. The phase transition of the quantum Ising model is sharp. *J. Stat. Phys.*, 136(2):231–273, 2009.
- [BG15] Alexander I Bobenko and Felix Günther. Discrete complex analysis on planar quad-graphs. *arXiv preprint arXiv:1505.05673*, 2015.
- [BH16] Stéphane Benoist and Clément Hongler. The scaling limit of critical Ising interfaces is cle (3). *arXiv preprint arXiv:1604.06975*, 2016.
- [Bjö13] Jakob E. Björnberg. Infrared bound and mean-field behaviour in the quantum Ising model. *Comm. Math. Phys.*, 323(1):329–366, 2013.

- [Bjö16] Jakob E Björnberg. Fermionic observables in the transverse Ising chain. *arXiv preprint arXiv:1607.06484*, 2016.
- [BMS05] Alexander I. Bobenko, Christian Mercat, and Yuri B. Suris. Linear and nonlinear theories of discrete analytic functions. Integrable structure and isomonodromic Green’s function. *J. Reine Angew. Math.*, 583:117–161, 2005.
- [Büc08] Ulrike Bücking. Approximation of conformal mappings by circle patterns. *Geom. Dedicata*, 137:163–197, 2008.
- [CDCH⁺14] Dmitry Chelkak, Hugo Duminil-Copin, Clément Hongler, Antti Kemppainen, and Stanislav Smirnov. Convergence of Ising interfaces to Schramm’s SLE curves. *C. R. Math. Acad. Sci. Paris*, 352(2):157–161, 2014.
- [CHI15] Dmitry Chelkak, Clément Hongler, and Konstantin Izyurov. Conformal invariance of spin correlations in the planar Ising model. *Ann. of Math. (2)*, 181(3):1087–1138, 2015.
- [CS11] Dmitry Chelkak and Stanislav Smirnov. Discrete complex analysis on isoradial graphs. *Adv. Math.*, 228(3):1590–1630, 2011.
- [CS12] Dmitry Chelkak and Stanislav Smirnov. Universality in the 2D Ising model and conformal invariance of fermionic observables. *Invent. Math.*, 189(3):515–580, 2012.
- [DC13] Hugo Duminil-Copin. *Parafermionic observables and their applications to planar statistical physics models*, volume 25 of *Ensaaios Matemáticos [Mathematical Surveys]*. Sociedade Brasileira de Matemática, Rio de Janeiro, 2013.
- [DCHN11] Hugo Duminil-Copin, Clément Hongler, and Pierre Nolin. Connection probabilities and RSW-type bounds for the two-dimensional FK Ising model. *Comm. Pure Appl. Math.*, 64(9):1165–1198, 2011.
- [DCS12] Hugo Duminil-Copin and Stanislav Smirnov. Conformal invariance of lattice models. In *Probability and statistical physics in two and more dimensions*, volume 15 of *Clay Math. Proc.*, pages 213–276. Amer. Math. Soc., Providence, RI, 2012.
- [GOS08] Geoffrey R. Grimmett, Tobias J. Osborne, and Petra F. Scudo. Entanglement in the quantum Ising model. *J. Stat. Phys.*, 131(2):305–339, 2008.
- [HS13] Clément Hongler and Stanislav Smirnov. The energy density in the planar Ising model. *Acta Math.*, 211(2):191–225, 2013.
- [Iof09] Dmitry Ioffe. Stochastic geometry of classical and quantum Ising models. In *Methods of contemporary mathematical statistical physics*,

volume 1970 of *Lecture Notes in Math.*, pages 87–127. Springer, Berlin, 2009.

- [Ken02] R. Kenyon. The Laplacian and Dirac operators on critical planar graphs. *Invent. Math.*, 150(2):409–439, 2002.
- [KS12] Antti Kemppainen and Stanislav Smirnov. Random curves, scaling limits and loewner evolutions. *arXiv preprint arXiv:1212.6215*, 2012.
- [Pfe70] Pierre Pfeuty. The one-dimensional ising model with a transverse field. *Annals of Physics*, 57(1):79–90, 1970.
- [Smi06] Stanislav Smirnov. Towards conformal invariance of 2D lattice models. In *International Congress of Mathematicians. Vol. II*, pages 1421–1451. Eur. Math. Soc., Zürich, 2006.
- [Smi10] Stanislav Smirnov. Conformal invariance in random cluster models. I. Holomorphic fermions in the Ising model. *Ann. of Math. (2)*, 172(2):1435–1467, 2010.

SECTION DE MATHÉMATIQUES, UNIVERSITÉ DE GENÈVE
2-4 RUE DU LIÈVRE, 1211 GENÈVE, SUISSE (SWITZERLAND).
E-mail address: Jhjh-Huang.Li@unige.ch