

# The KISS principle in Software-Defined Networking: An architecture for Keeping It Simple and Secure

Diego Kreutz, Jiangshan Yu, Paulo Esteves-Verissimo,  
SnT, University of Luxembourg, Luxembourg  
{Diego.Kreutz,Jiangshan.Yu,Paulo.Verissimo}@uni.lu

Cátia Magalhães, Fernando M. V. Ramos  
LaSIGE/FCUL, University of Lisboa, Portugal  
catiamagalhaes27@gmail.com, fvramos@ciencias.ulisboa.pt

*Abstract*—Security is an increasingly fundamental requirement in Software-Defined Networking (SDN). However, the pace of adoption of secure mechanisms has been slow, which we estimate to be a consequence of the performance overhead of traditional solutions and of the complexity of the support infrastructure required. As a first step to addressing these problems, we propose a modular secure SDN control plane communications architecture, KISS, with innovative solutions in the context of key distribution and secure channel support. A comparative analysis of the performance impact of essential security primitives guided our selection of basic primitives for KISS. We further propose iDVV, the integrated device verification value, a deterministic but indistinguishable-from-random secret code generation protocol, allowing the local but synchronized generation/verification of keys at both ends of the channel, even on a per-message basis. iDVV is expected to give an important contribution both to the robustness and simplification of the authentication and secure communication problems in SDN.

We show that our solution, while offering the same security properties, outperforms reference alternatives, with performance improvements up to 30% over OpenSSL, and improvement in robustness based on a code footprint one order of magnitude smaller. Finally, we also prove and test randomness of the proposed algorithms.

*Keywords*—software-defined networking, SDN, security, system architecture, control plane communications, performance of cryptographic primitives, integrated device verification value (iDVV), perfect forward secrecy.

## I. INTRODUCTION

In Software-Defined Networking (SDN), network control is separated from the forwarding devices and logically centralised in a controller. This separation is achieved by means of a protocol (typically, OpenFlow) that enables the SDN controller to remotely populate the forwarding tables of network switches. The OpenFlow standard includes Transport Layer Security (TLS) [1] as an *optional* security feature for authenticating forwarding devices and controllers and for encrypting the communication channel. However, to date most reported deployments still use TCP for control traffic, and SDN controllers and switching hardware with TLS support are still rare [2]. Moreover, most deployments communicate control plane traffic in-band with data traffic to reduce the infrastructure required, making control plane communication vulnerable to different attacks [2]. For instance, a single malicious forwarding device can intercept control traffic and become a dangerous threat to the SDN infrastructure [3].

Four fundamental issues can slow down the rate of adoption of secure mechanisms in SDN. First, securing communications

has a non-negligible cost in terms of increased communications latency and reduced performance. Several recent studies have analysed this overhead in various contexts [4], [5], [6]. Second, the computing capabilities of commodity switches are typically weak. The typical SDN switch (e.g. [7], [8], [9]) is equipped with a single or dual-core CPU running at approximately 1GHz, which compares unfavourably with the multi-core CPUs found in typical commodity servers. Imposing the additional cost of TLS to these computing-constrained networking devices is a problem. Third, poor choice of cryptographic primitive implementations can also have a significant impact on the performance of the control plane communications handled by the controller. Finally, the Public Key Infrastructure (PKI) on which TLS relies is complex and thus vulnerability prone [10], [11], opening a large surface for successful attacks [12].

In order to meet these challenges, we propose a modular secure SDN control plane communications architecture KISS (Section II), which aims to increase the robustness of control communications whilst enhancing their performance, by decreasing the complexity of the support infrastructure, as an alternative to current approaches based on classic configurations of TLS and PKI.

A core novel component of our architecture is the integrated device verification value (iDVV), a deterministic but indistinguishable-from-random secret code generation protocol (Section III). The concept was inspired by the iCVVs (integrated card verification values) used in credit cards to authenticate and authorize transactions in a secure and inexpensive way. We develop and extend the idea for SDN, proposing a flexible method of generating iDVs by adapting proven one-time password-like techniques. iDVV codes allow the safe decentralized generation/verification of keys at both ends of the channel, at will, even on a per-message basis.

To understand and minimize the cost of security, we quantify (Section IV) the impact of secure primitives on the performance and scalability of control plane communications, through a compared study of different implementations of TCP vs. TLS, complemented by a deeper study of underlying hashing and message authentication code (MAC) primitives. Those experiments confirm our intuition that the choice of protocols and primitives used in secure communication may well be one strong reason behind the slow adoption of these mechanisms in SDN. This in-depth study lead to the selection of the NaCl cryptographic library [13], and the best performing MAC and hash primitives — Poly1305 and SHA512 OpenSSL — as the baseline secure channel technologies for KISS.

arXiv:1702.04294v4 [cs.NI] 2 Nov 2017

iDVVs team-up with NaCl, in order to safely replace the cryptographic primitives and key-exchange protocols and key derivation functions commonly used in TLS. As a result, the NaCl-iDVV compound, while achieving the same functional level of security, is simpler, potentially leading to a higher level of implementation robustness by vulnerability reduction. In fact, we estimate the proposed security architecture footprint to be smaller than TLS-PKI alternatives with traditional protocols, by an order of magnitude, in terms of the number of lines of code (LOC). Such a differential also points to reducing the cyclomatic complexity. These metrics are typically used to assess the robustness and estimate verifiability of software systems.

Furthermore, in Section V we evaluate the iDVV design in terms of performance, security and randomness. Key generation latency of iDVV compares very favourably with common implementations of key derivation functions. On the security side, we prove the indistinguishability-from-random and determinism of the iDVV generator. Finally, the iDVV successfully passed several empirical randomness tests, further confirming its indistinguishability-from-random, and showing its suitability for highly-robust key generation. We end the paper with a discussion and some pointers to further work.

## II. KISS ARCHITECTURE

In this section we present our proposal of KISS, a modular secure control plane communications architecture for SDN offering alternatives to classic configurations of secure channel and authentication protocols and subsystems followed in TLS and PKI. We assume a typical SDN architecture, as illustrated in Figure 1, composed of controllers and forwarding devices. We further assume that device registration and association services are in place. For lack of space, we do not discuss them in detail, but for self-containment, we discuss some properties and their interface below.

The two components encapsulated by the KISS boxes are the crucial components of the architecture, and the main subject of our study: a secure channel protocol suite, composed of a judicious choice of state-of-the-art mechanisms and protocols, which we dub SC for convenience of description, and a novel deterministic but indistinguishable-from-random secret code generation protocol, which we call iDVV (integrated device verification value).

We have considered using TLS implementations (e.g. OpenSSL) as the baseline protocol for SC. However, the experiments in Section IV have alerted us to: the sheer performance cost of cryptographic communication; and the further impact of sub-optimal choices of cryptographic primitives. This motivated us to adopt NaCl [13], a high performance yet secure cryptographic library, as the substrate of SC, complemented by the MAC and strong hash primitives with best performance according to our experiments – Poly1305 and SHA512 OpenSSL. SHA-512 is used by the iDVV generator while Poly1305 is a fast MAC algorithm.

The iDVV, a novel component we propose, helps to further enhance the security of SC, through strong crypto material generated at a low cost (e.g. one-time keys, per-message authentication and authorization codes) to be used by NaCl

ciphers. The indistinguishability-from-random allied to the determinism allow the safe decentralized generation/verification of per-message keys at both ends of the channel.

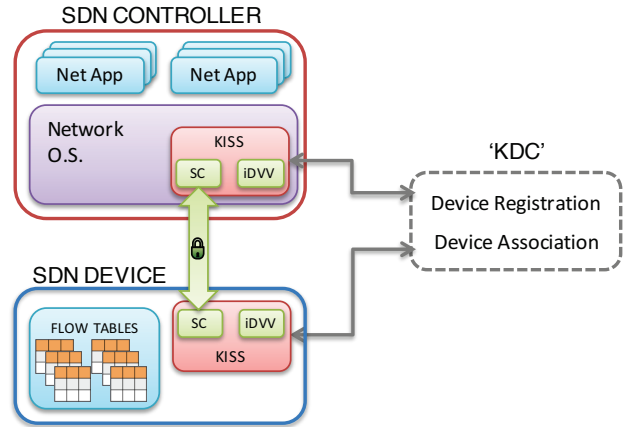

Fig. 1. General architecture

### A. System and threat model

For simplicity and without loss of generality, we assume that the controllers and forwarding devices are registered and associated through a secure and robust key distribution service provided by a key distribution center (KDC), which for space reasons is out of the scope of this paper, but can be readily secured by state-of-the-art KDCs like Kerberos Key Distribution Center [14].

The device registration process is by default invoked by network administrators to the KDC, to register new devices. In result of device registration, the device and the KDC securely share a symmetric key. We denote  $K_{kc}$  the shared key between the KDC authority and a registered controller, and  $K_{kf}$  the shared key between the KDC authority and a registered forwarding device.

Registered controllers and forwarding devices must be securely associated, also through the KDC authority, as a precondition to communicate securely. The most common case is a forwarding device  $f_i$  requesting an association to a controller  $c_j$ , through the KDC. After associating, a controller and a forwarding device share two symmetric secrets (of size 256 bits), namely a  $seed_{ij}$  and a  $key_{ij}$ . The key is generated by the KDC and the seed is generated by the KDC in cooperation with the controller. These secrets will be used to bootstrap the iDVV module, as we discuss ahead.

As threat model, we consider a Dolev-Yao style attacker, who has a complete control of the network, namely the attacker logs all messages, and can arbitrarily delay, drop, re-order, insert, or modify messages. In addition, this strong attacker is able to compromise any network device (e.g. a controller or a forwarding device) at any time. We assume the security of the used cryptographic primitives, including MAC (i.e. Poly1305), hash function (i.e. SHA-512), and symmetric encryption algorithm (e.g. AES). We will prove the security of the iDVV codes in Section V. We also assume that the device registration and association services can rely on robust pseudo-random number generators.

## B. Security goals

The main goal of KISS is to provide security properties including authenticity, integrity, and confidentiality for control plane communications, while minimizing cost and complexity.

The secure communication between participants can be easily guaranteed when a secure encryption algorithm is used, as long as the shared secret key is kept secure. To provide a robust SDN system, we focus on advanced security guarantees for the situation when the shared key is exposed to an attacker, as this might happen in practice. In particular, if an attacker has compromised a device and learnt its shared keys, then we are aiming at providing “perfect forward secrecy” (PFS) of communications. That is, the secrecy of a device’s past communications should be protected when the device is compromised and its shared keys are exposed to an attacker. It is important to emphasize that PFS is an essential requirement for SDN. The lack of it can lead to information disclosure, i.e., reveal different aspects of the network’s state and the controller’s strategy (e.g., proactive or reactive flow setup).

Established KDC technologies like Kerberos have robust implementations and are intensely used by industry, which makes us consider the logical single-point-of-failure they present as moderate, and an acceptable option for the current state of the art. However, and though, as we said, the KDC is out of the scope of the paper, we present mitigation measures to achieve PFS in case of compromise of the KDC. We also plan, as future work, to investigate towards the development of SDN KDCs resilient to accidental and malicious faults, drawing from fault and intrusion tolerance techniques [15].

On the devices side, we make no claim about their sheer resilience, since this is largely dependent on vendors. More precisely, when a controller and/or a forwarding device is compromised, we consider that the attacker is able to obtain all knowledge of the victim device(s), including all stored secrets and the session status. However, it is our goal to guarantee the confidentiality of all past communications through measures that allow us to achieve perfect forward secrecy.

## III. IDVV: KEEP IT SIMPLE AND SECURE

Integrated device verification values (iDVVs) are sequentially generated to protect and authenticate requests between two networking devices. The generator is conceived so that its output sequence has the indistinguishability-from-random and determinism properties. In consequence, the same sequence of random-looking secret values is generated on both ends of the channel, allowing the safe decentralized generation/verification of per-message keys at both ends. However, if the seed and key initial values and the state of the generator are kept secret, there is no way an adversary can know, predict or generate an iDVV.

In other words, an iDVV is a unique secret value generated by a device A (e.g. a forwarding device), which can be locally verified by another device B (e.g. a controller). The iDVV generation is made flexible to serve the needs of SDN. iDVVs can therefore be generated: (a) on a per message basis; (b) for a sequence of messages; (c) for a specific interval of time; and (d) for one communication session. The main advantages of iDVVs are their low cost and the fact that they can be

generated locally, i.e., without having to establish any previous agreement.

Different from standard KDF algorithms such as HKDF, which assumes that keying material is not uniformly random or pseudorandom, our keying material (i.e. seed and key) are random symmetric secrets (each of size 256 bits), generated by the KDC, with high entropy. In such cases, a strong hash function can be safely used to derive a key (RFC 4880). As shown by the results in Section V, the iDVV generation is simpler and faster than standard KDF algorithm such as HKDF (RFC 5869) and similar solutions.

### A. iDVV bootstrap

As discussed before, the association between two SDN devices, e.g., forwarding device  $f_i$  and controller  $c_j$ , happens through the help of KDC, under the protection of the long-term secret keys obtained from registration ( $K_{kf}$ , resp.  $K_{kc}$ ). The outcome of the association protocol is the distribution of two random secrets to both devices: a seed  $seed_{ij}$ , and an association key  $key_{ij}$ . The iDVV mechanism is bootstrapped by installing these two secret values in both the controller and the switch, to animate the iDVV generation algorithms, which we describe next.

Note that the set-up and generation of the iDVV values are performed in a deterministic way, so that they can be done locally at both ends. However, as iDVVs will be used as keys by cryptographic primitives such as MAC or encryption functions, they have to be indistinguishable from random. Hashing primitives are natural choices for our algorithms, since they provide indistinguishable-from-random values if one or more of the input values are known only by the sender and the receiver. This explains why it is crucial that seed and association key are sent encrypted and therefore known only to the communicating devices. Moreover, in order to prevent information leakage, all variables  $seed$ ,  $key$ , and  $idvv$  in the algorithms below should have the same length, which we chose to be 256 bits in our design. This length is commonly considered robust, and the evaluation in Section V-D confirms that. From our experiments reported ahead in Section IV, the hashing primitive to be used is SHA512, which yields 512 bits, of which we will use the most-significant  $q$  bits if we need to reduce the output length to  $q$  (as recommended by [16]). For example, we use the most-significant 256 bits of the SHA512 output as the key for symmetric ciphers.

The initial iDVV value is deterministically created at both ends of the association between two devices<sup>1</sup>, by calling function `idvv_init()`, which performs hashing on the concatenation of the initial  $seed$  and  $key$ , as illustrated by algorithm 1. After set-up, the generator is ready for first use, as described in the following section.

---

**Algorithm 1:** iDVV set-up

---

```
1: idvv_init()  
2: idvv  $\leftarrow$  H(seed || key)
```

---

<sup>1</sup>For readability, we omit the device-identifying subscripts in the variables.

## B. iDVV generation

After the bootstrap with the initial  $idvv$  value, the  $idvv\_next$  function is invoked on-demand (again, synchronously at both ends of the channel) to autonomously generate authentication or encryption keys that will be used for securing the communications, as illustrated by algorithm 2.

The  $key$  remains the only constant shared secret between the devices. The  $seed$  evolves to a new indistinguishable-from-random value each time  $idvv\_next$  is invoked to generate a new iDVV. The new seed is the outcome of a hashing primitive  $H$  over the current  $seed$  and current  $idvv$  (line 2). The new  $idvv$ , output of function  $idvv\_next$ , is the outcome of a hashing primitive  $H$  over the concatenation of the new seed and association key  $key$ .

---

**Algorithm 2:** iDVV generation

---

```
1:  $idvv\_next()$ 
2:    $seed \leftarrow H(seed \parallel idvv)$ 
3:    $idvv \leftarrow H(seed \parallel key)$ 
```

---

## C. iDVV synchronization

The iDVV mechanism is agnostic w.r.t. secure communication protocols, and can be used in a number of ways, in a number of protocols, as a key-per-message or key-per-session, etc. The only key issue about iDVV generation, is to keep it synchronized in both extremes of the channel. So, we discuss recommendations in this regard.

As a generic baseline robustness technique, communication should be authenticated (encrypt-then-MAC recommended), such that any messages failing crypto (decryption or MAC verification), can be simply discarded and that fact handled by whatever existing error recovery mechanisms. This brings in robustness against de-synchronization, or malicious attacks, as we show below.

iDVs can get out of sync for a number of reasons, like speed differences, omission errors, or even DOS attacks. When de-synchronization happens, a baseline technique consists of advancing the iDVV of the “slower” end, to catch up. This lets us introduce another baseline robustness technique: when say,  $idvv^k$  is advanced to  $idvv^l$  ( $k < l$ ) to re-synchronize, and the operation is not successful (crypto fails), the old  $idvv^k$  is restored, and the message motivating the recovery, is discarded. This restoration does not affect the PFS of communications because the  $idvv^k$  (or newer) has not yet been used to secure the traffic between the two communicating devices.

Suppose an attacker can forge a re-synchronization request to claim that it is in a future state (i.e. with a more advanced iDVV), and fool the recipient to advance its iDVV to catch up: then the attacker is able to play DoS attacks by keeping on asking all devices to synchronize to an advanced iDVV. This is foiled by the first robustness technique, since the attacker cannot mimic valid crypto, so the message is discarded, and the second robustness technique ensures that the node gets back to the original iDVV state.

Now we discuss some styles of using iDVs, and possible protocol classes they serve:

*Simple iDVV* - used as is, works for lock-step, or producer-consumer communication, where the advance is, respectively, either round based, alternatively dictated by each end, or dictated by the producer.

If the channel is unreliable, packet losses may occur, and then the receiver (R) gets out of sync and is not able to verify the next received message from sender S. If the network has a bounded omission degree (maximum number of consecutive omissions), say  $Od$ , R can perform a simple recovery process: its iDVV is successively advanced up to  $Od + 1$  times, until it is able to verify the incoming message. If the process fails, the message is discarded and the iDVV goes back to the original value (as per the techniques discussed above).

If packet losses can be unexpectedly high, or both ends send competitively and/or in a non-synchronized way, this algorithm is not suitable.

*Indexed iDVV* - iDVs are indexed by the generation number. Also, they are operated in “one key per direction” mode, i.e., at each end, one iDVV is generated for each communication direction. This way, they support competitive, non-synchronized correspondents. This mode also supports unreliable, connectionless protocols like UDP.

Each iDVV generated is indexed by a sequence number (the initial iDVV being  $idvv^0$ ) and the sequence number is included in the message where the respective  $idvv$  is used. This way, each receiving end (this works in either direction, as we have two pairs of iDVs) can know the exact  $idvv$  number that should be used and, for example, detect and recover from omissions, by generating  $idvv$ 's necessary number of times to resynchronize. Again, the process is robust: if it fails, the message is discarded and the iDVV goes back to the original value.

*Session iDVV* - iDVs now mark sessions, inside which sets of messages are sent that use crypto related to the current session iDVV. It is quite suitable for example, for connection-oriented protocols.

Each  $idvv^j$  is valid for the entire session  $j$ . A session may be a standard, long-duration session a la SSL, or artificially short, rolling session, for higher security, e.g. in a timed (e.g. 1-minute) way. Anyway, at the end of the session and start of the next one, the  $idvv^j$  is updated to  $idvv^{j+1}$ .

Messages pertaining to a session  $j$ , labelled ( $j$ ), may all use the same  $idvv^j$  key. However, better can be done: inside a session, rolling per-message keys may be created, based on  $idvv^j$ , for example,  $k_N = H(idvv^j \parallel N)$ , used for message labelled ( $j, N$ ), the  $N$ -th message in the  $j$ -th session. Whenever a message with label ( $j, N$ ) is received, if  $j$  is the current session, then the device calculates the key  $H(idvv^j \parallel N)$  and decrypts or verifies this message. Again, if the process fails, or  $j$  does not match, the message is discarded and the iDVV goes back to the original value.

## D. iDVV implementation and application

iDVs require minimal resources, which means that they can be implemented on any device, from a simple and very limited smart card to most existing devices. In other words, they are a simple and viable solution that can be embedded

in any networking device. Just three values per association have to be securely stored — the seed, the association key and the iDVV itself — in order to use iDVV continuously. Furthermore, only hash functions, simple to implement and with a very small code base, are required to generate iDVVs. Such kind of resource is already available on all networking devices that support traditional network protocols and basic security mechanisms.

We advocate (and demonstrate in Section V) that iDVVs are inexpensive and, as a result, can be used on a per-message basis to secure communication. It is worth emphasizing that, from a security perspective, one fresh iDVV per message makes it much harder for attacks such as key recovery [17], advanced side channel attacks [18], among other general HMAC attacks [19], to succeed. In fact, the one-time key approach was initially used for generating MACs. Yet, it was let aside (i.e. replaced by keys with a longer lifetime) due to performance reasons. However, as the iDVV generation has a low cost (see Section V-A), we incur in a lower penalty.

Finally, iDVVs can have further practical applications. For instance, the TLS handshake can be used to bootstrap the iDVV. After that, iDVVs can be used as session keys, i.e., in security mechanisms such as encrypt-then-MAC.

#### IV. ON THE COST OF SECURITY

In this section we provide a quantitative analysis of the impact of cryptographic primitives on control plane communication. Although the number of use cases is expanding, SDN has been mainly targeting data centers. As such, SDN controllers have to be capable of dealing with the challenging workloads of these large-scale infrastructures. In these environments new flows<sup>2</sup> can arrive at a given forwarding device every 10  $\mu$ s, with a great majority of mice traffic lasting less than 100ms [20]. This means that current data centers need to handle peak loads of tens of millions of new flows/s. The control plane has to meet both the network latencies and throughputs required to sustain these high rates. Current controllers are capable of achieving a throughput of up to 20M flows/s using TCP [2].

So any effort to systematically secure control plane communications has to meet these challenges. In the following we try to put the problem in perspective, by analysing the effect of including even the most basic security primitives to ensure authenticity, confidentiality and integrity when considering peak loads of this magnitude.

We start by analyzing the latency impact of TLS, relative to TCP, and then we focus on hashes and MACs as they are the essential primitives for authenticity and integrity of communication. To measure the latency of control plane communication<sup>3</sup> we used Linux’s resource usage system call (`getrusage()`) to get the user CPU execution time. This function is commonly used to measure the performance of cryptographic primitives. Then, we compare the performance of 50+ hashing and MAC primitives, including different implementations such as those provided by OpenSSL (version 1.0.0)

<sup>2</sup>In spite of the fact that there are several definitions of flow in SDN [2], we equate SDN flow with TCP flow for the sake of simplicity.

<sup>3</sup>Time required to send a `PACKET_IN` message and receive a `FLOW_MOD` message without taking into account any further processing time of the controller.

and PolarSSL (version 1.3.9), two of the most widely used SSL libraries. We evaluate these primitives using a hardware platform that includes two quad-core Intel Xeon E5620 2.4GHz, with 2x4x256KB L2 / 2x12MB L3 cache, 32GB SDIMM at 1066MHz, with hyper-threading enabled and overclocking and dynamic CPU frequency scaling disabled. These machines ran Ubuntu Server 14.04 LTS and were connected via Gigabit Ethernet.

##### A. The cost of secure channels

Our first experiments assess the compared average latency of TCP and TLS on control plane communication. We analyse the latency of connection setup and of OpenFlow `PACKET_IN/FLOW_MOD` messages. The OpenFlow `PACKET_IN` message is used by switches to send packets to the controller (e.g. when there is no rule matching the packet received in the switch). `FLOW_MOD` messages allow the controller to modify the state of an OpenFlow switch. One of the two nodes of the evaluation platform emulates the controller, whereas the other assumes the role of the forwarding devices. The emulation removes the overhead specific to the controller’s implementation, for instance. In practice, there is a huge performance gap among different controllers, most of which due to the chosen technologies and implementation details. Similarly, the performance of switching devices varies also a lot due to implementation details. To eliminate the implementation-specific performance penalty, we wrote a multi-threaded controller and forwarding devices that just send and receive `PACKET_IN` and `FLOW_MOD` messages. This also means that the controller sends `FLOW_MOD` messages in parallel to the forwarding devices.

The emulated controllers and forwarding devices are implemented in C, using the OpenSSL and PolarSSL (a library used in systems from companies such as Gemalto, ARM, and Linksys) TLS implementations in their standard configuration (i.e. no library-specific optimizations were applied). Figures 2 and 3 show the median of the measured latency over 40k executions. The standard deviation is below 3% so we do not include it in the figures.

Figure 2 shows the connection setup time (per forwarding device). The higher costs of the two TLS implementations are due to the execution of a more elaborate handshake protocol between the devices. While TCP uses a simple three-way handshake, TLS requires a nine message handshake for mutual authentication of the communicating entities. As expected, the overhead increases with the number of forwarding devices. Interestingly, our results also suggest that the choice of implementation has a non-negligible performance impact. For connection setup, PolarSSL induces nearly twice the overhead of OpenSSL.

Although important, a high connection cost can be amortized by maintaining persistent connections. As such, the communications cost is usually considered more relevant. Figure 3 shows the latency of `FLOW_MOD` messages (56 bytes, as specified in OpenFlow 1.4 [21]), averaged over 10k messages. The results with `PACKET_IN` messages (32 bytes) were similar so we omit them for clarity. The costs of TCP, OpenSSL and PolarSSL grow nearly linearly with the number of forwarding devices. OpenSSL latency is approximately 3x

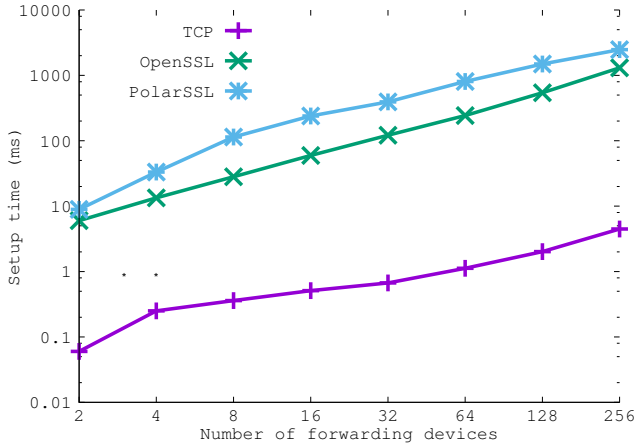

Fig. 2. TCP and TLS connection setup times (in log scale)

higher than TCP. This is explained by the high overhead of cryptographic primitives, as we further analyse in the next section. PolarSSL is significantly worse, increasing the latency by up to 7x when compared with TCP.

**Conclusions:** The main findings of this analysis can be summarised in two points. First, different implementations of TLS present very different performance penalties. Second, the additional computation required by the cryptographic primitives used in TLS leads anyway to a non-negligible performance penalty in the control plane. In consequence, we turn to lightweight cryptographic libraries, such as NaCl [13] and TweetNaCl [22], which are starting to be used in different applications. NaCl has been designed to be secure and to be embedded in any system [23], taking a clean slate approach and avoiding most of the pitfalls of other libraries (e.g. OpenSSL – misuse issues). First, it exposes a simple and high-level API, with a reduced set of functions for each operation. Second, it uses high-speed and highly-secure primitives, carefully implemented to avoid side-channel attacks. Third, NaCl is less error-prone because low-security options are eliminated and it also provides a limited number of cryptographic primitives. In other words, users do not need deep knowledge regarding security to use it correctly. This is one of the major differences between it and other libraries such as OpenSSL. For instance, it has been recurrently shown that developers have been using OpenSSL in incorrect ways, leading to several security issues. Fourth, it has already been shown that secure and high-performance network protocols, outperforming OpenSSL, can be designed and implemented using NaCl [24].

### B. A closer look at the cost of cryptography

To understand in more detail the cause of the previous findings we now perform a fine-grained analysis of two main classes of security primitives used in secure channel protocols: hashing and MAC.

To measure the overhead of these primitives we disabled hyper-threading, in order to remove noise and randomness due to the implied resource sharing. As commodity switching devices do not implement direct cache access, we have ensured that the data to be hashed resides in main memory. This avoids

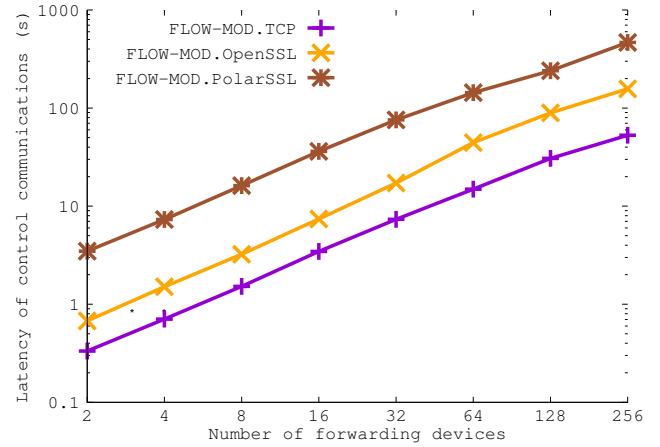

Fig. 3. FLOW\_MOD latency (in log scale)

artificial performance boosts when operating on cached data<sup>4</sup>. To mimic the behaviour of a switch, we circulated over an input buffer that is twice as large as the last-level cache (L3) to ensure that every read resulted in a cache miss. The numbers in the following graphs represent the median of 1M executions, with a standard deviation below 3%.

We analyse the performance of nine hashing primitives. The results are presented in Figure 4. The red bars represent primitives that are provided by OpenSSL, while white bars (BLAKE and KECCAK) indicate the original implementation of primitives that are not part of OpenSSL. From Figure 4, we observe that the primitives with smaller digest sizes (SHA-1 and MD5) achieve better performance, as expected. The stronger versions of the SHA and BLAKE families achieve comparable performance (slightly slower), with higher security guarantees. Interestingly, SHA-512 outperforms SHA-256. This behavior is explained by the fact that on a 64-bit processor each round can process twice as much data (64-bit words instead of 32-bit words). However, SHA-256 is faster on a 32-bit processor. In the case of KECCAK the difference in performance is due to the additional computational complexity of the mechanisms employed. For instance, this solution requires 24 rounds of permutation on each compression step, while BLAKE requires up to 16 rounds.

To understand the variance between different implementations, we present in Figure 5 the costs of the five hashing primitives for which different implementations were available. The OpenSSL implementation shows the best performance for hashing primitives. With the exception of RIPEMD160, the PolarSSL implementation always presented higher message latencies. In addition to OpenSSL and PolarSSL, we included EVP, a library that provides a high-level interface to cryptographic functions. Its main purpose is the ability to replace cryptographic algorithms without having to modify applications. The added flexibility comes at a cost, as we can observe in the results. The same OpenSSL primitives used through an EVP interface experience a penalty between 3% and 15%.

Finally, Figure 6 shows the results of the latency analysis

<sup>4</sup>With cached data, we observed artificial gains of up to 20% for hashing and of 12% for MAC primitives.

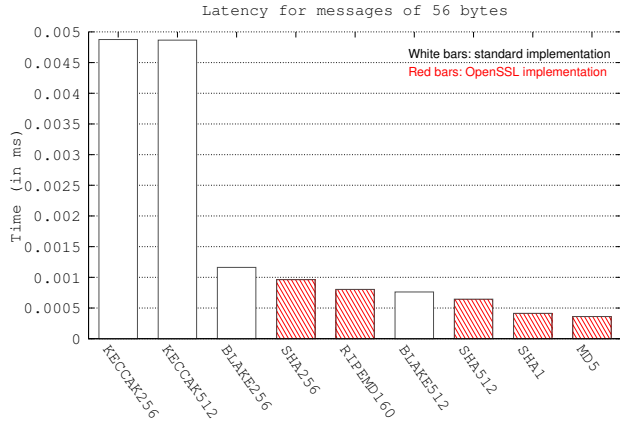

Fig. 4. Hashing primitives

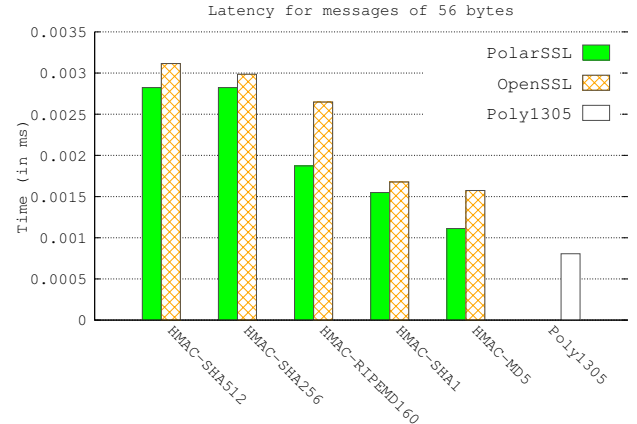

Fig. 6. MAC primitives

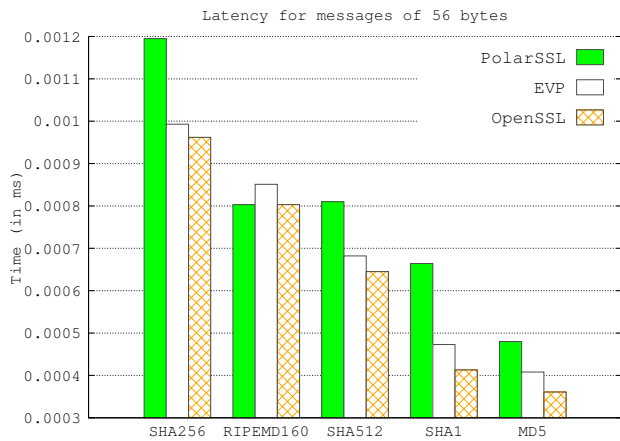

Fig. 5. Implementations of hashing primitives

of six MAC primitives. It is clear that Poly1305 outperformed all other primitives, being approximately two times faster than OpenSSL’s HMAC-SHA1, and close to four times faster than HMAC-SHA512, for instance. For MAC primitives, the choice of specific implementations remains relevant. Curiously, in this case the PolarSSL implementation always outperformed the equivalent OpenSSL implementation. The reason may lie on the fact that OpenSSL does not provide native HMAC implementations, but rather highly configurable HMACs through EVP interfaces. These primitives thus carry the overhead of EVP and the extra costs of configurability.

**Conclusions:** From the results of Figure 6, considering the MAC primitive with best performance in the analysis (Poly1305 with 0.001ms per message), around 20 dedicated cores are needed to compute a MAC in order to maintain a rate of 20M flows/s. To understand the importance of judiciously selecting the security primitives implementation, the HMAC-SHA512 OpenSSL (worst case performance in the analysis) would require over three times more cores (up to 65) to compute MACs at these rates. From the hashing primitives analysis, we conclude that SHA-512 performs best among the strong primitives (i.e. all except SHA1 and MD5), even better than SHA-256. Concerning MAC primitives, the performance of HMAC-SHA512 disappoints, and it is clear that Poly1305

outperformed all other primitives, providing security with high speed and low per-message overhead.

In summary, our findings in this section indicate that (i) the inclusion of cryptographic primitives results in a non-negligible performance impact on the latency and throughput of the control plane; and that (ii) a careful choice of the primitives used and their respective implementations can significantly contribute to reduce this performance penalty and enable feasible solutions in certain scenarios. Taking the outcome of our analysis into consideration, and given the benefits of NaCl described in Section IV, we have selected the NaCl lightweight cryptographic library, and the MAC and hash primitives with best performance – Poly1305 and SHA512 OpenSSL – as the baseline SC secure channel component technologies. NaCl is complemented in our architecture with the iDVV mechanism to generate crypto material (e.g. keys) used by NaCl ciphers. Taken together they provide, as per our evaluation, the best trade-off between security and performance for control plane communications in SDN. We evaluate the overall result in the next section.

## V. IDVV EVALUATION

### A. Performance

Figure 7 shows the performance of different primitives for generating cryptographic material. We compare the iDVV generator using SHA512 (iDVV-S5), with an implementation of a common key derivation function (KDFx) with different values for the exponent  $c$  (128, 64, 32, and 16, respectively), the Diffie-Hellman implementation used by OpenSSL (DH-OSSL), and the `randombytes()` function (NaCl-R) provided by NaCl. The latency of a KDF is very high, increasing linearly with the number of iterations. Our results for DH are compatible with other publicly available performance measurements done on service providers such as Amazon [25], showing a latency several times higher than the iDVV generator. The `randombytes()` primitive of NaCl, used to generate random keys, is the second faster after iDVV, but still results a latency at least 2.6x higher. NaCl-R’s main latency lies on I/O operations required to read the special random number generator device of the Linux kernel, the `/dev/urandom`. Last, but not least, it is worth emphasizing that NaCl-R

cannot be used for the same purposes of iDVs, since it only generates non-sequential random values, i.e., the values would be different on both ends of the communication channel, defeating our initial purpose.

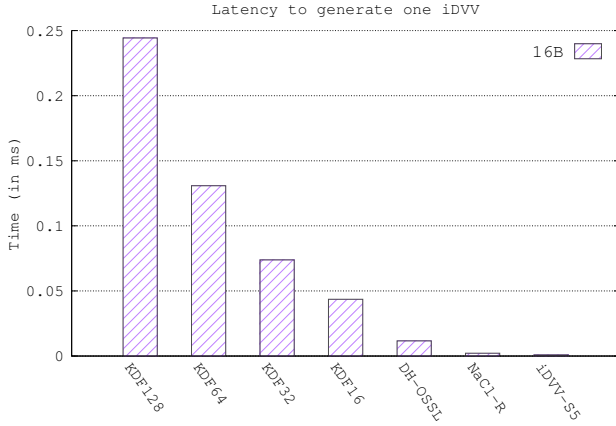

Fig. 7. Latency to generate keys

## B. Security

Now, we provide a security analysis for the iDv Algorithms 1 and 2, proving that they provide indistinguishable-from-random and deterministic outputs.

### Algorithm 1

*Theorem 1:* If the initial values of *seed* and *key* are indistinguishable from random, then the resulting initial *idv* (line 2) is indistinguishable from random.

*Proof:* The *seed* and *key* are, by assumption (Section II) of the availability of robust sources of pseudo-random number generators in the central services (which generate the former), indistinguishable from random. In consequence, and assuming that  $H$  is a strong hash function, the output of  $H(\text{seed} \parallel \text{key})$  will thus be indistinguishable from random.  $\square$

*Theorem 2:* Any execution of the function  $H(\text{seed} \parallel \text{key})$  with the same input values *seed* and *key*, produces the same output value (*idv* in line 2).

*Proof:* Proof that Algorithm 1 is deterministic follows trivially from the deterministic nature of hash functions.  $\square$

### Algorithm 2

*Lemma 1:* If the *seed* and *idv* are indistinguishable from random, then the resulting new *seed* (line 2) is indistinguishable from random.

*Proof:* We start by proving the result of the run with the initial values of *seed* and *idv*. The initial *seed* is, by assumption (Section II) of the availability of robust sources of pseudo-random number generators in the central services (which generate the former), indistinguishable from random. Theorem 1 states that the initial *idv* is indistinguishable from random. In consequence, with a similar argumentation of the proof of Theorem 1, and assuming that  $H$  is a strong hash function, the output of  $H(\text{seed} \parallel \text{idv})$  will be indistinguishable from random.

Now we recurse the argumentation, to show that the proof is valid for any input values of *seed* and *idv*. A *new seed* was just proven to be indistinguishable from random. A *new idv* is proven below in Theorem 3 to be indistinguishable from random. Feeding these into the argumentation above, we generalise the proof  $\forall$  *seed* and *idv*.  $\square$

*Theorem 3:* If the *seed* and *key* are indistinguishable from random, then the resulting new *idv* (line 3) is indistinguishable from random.

*Proof:* Lemma 1 establishes that *seed*, output by line 2 and thus used as input in line 3, is indistinguishable from random. The *key* is, by assumption of the availability of robust sources of pseudo-random number generators in the central services (which generate the former), indistinguishable from random.

We start by proving the result of the run with the initial value *idv*. Theorem 1 states that the initial *idv* is indistinguishable from random. In consequence, with a similar argumentation of the proof of Theorem 1, and assuming that  $H$  is a strong hash function, the output of  $H(\text{seed} \parallel \text{key})$  will be indistinguishable from random.

Now we recurse the argumentation, to show that the proof is valid for any values of *idv*. Any *new idv* was just proven to be indistinguishable from random. In some next run, it will pair with *key*, by nature indistinguishable from random, and with any new *seed*, proven by Lemma 1 to be indistinguishable from random. Feeding these into the argumentation above, we generalise the proof  $\forall$  *key*, *seed* and *idv*.

In other words, the newly generated iDv is an indistinguishable from random value that can be safely used as an authentication or authorization code, secret key, random nonce, and so forth.  $\square$

*Lemma 2:* Any execution of the function  $H(\text{seed} \parallel \text{idv})$  with the same input values *seed* and *idv*, produces the same output value (*seed* in line 2).

*Proof:* Proof that the function is deterministic follows trivially from the deterministic nature of hash functions.  $\square$

*Lemma 3:* Any execution of the function  $H(\text{seed} \parallel \text{key})$  with the same input values *seed* and *key* produces the same output value (*idv* in line 3).

*Proof:* Proof that the function is deterministic follows trivially from the deterministic nature of hash functions.  $\square$

*Theorem 4:* Any execution of Algorithm 2 with the same input values *seed*, *idv* and *key* produces the same output value (*idv* in line 3).

*Proof:* Proof that Algorithm 2 is deterministic follows trivially from Lemma 2 and 3: since the two functions are executed in a row, and the *seed* output of line 2 used as input in line 3 is deterministic (Lemma 2), it satisfies the conditions of Lemma 3 for determinism.  $\square$

## C. Perfect forward secrecy

In this section, we provide a discussion about the perfect forward secrecy properties of our protocols, in face of compromise of any of KDC, controller, forwarding device. We re-state our goal in that case: safeguard secrecy of past



communications from the time the key became active, to the time it became known to the attacker.

Note that when the assumed key distribution authority (e.g. the Kerberos KDC) is compromised, then the attacker is able to obtain all the shared secrets  $K_{kc}$  (resp.  $K_{kf}$ ) between the authority and every controller (resp. every forwarding device). In this case, the attacker would be able to decrypt the past communication that delivered the initial *seed* and *key* to the associated devices, and in consequence, decrypt past conversations, since the generation of iDVs is deterministic from the initial state (see `idvv_init` in Section III-A).

Although providing secure and robust key distribution services is an open challenge and orthogonal to this paper, we provide a simple mechanism for providing PFS even when the authority is compromised. We achieve it by updating the shared key (between the authority and registered devices) each time a forwarding device is associated with a controller. The key is updated as follows:  $K_{kc} \leftarrow H(K_{kc})$  and  $K_{kf} \leftarrow H(K_{kf})$ . This way, a shared key captured cannot decrypt any past messages, since they have been encrypted with previous generations of that key, which have been “forgotten” in the system, given the irreversible nature of hashes.

As far as devices are concerned, when they are compromised, the current values of *seed*, *key* and *idvv* are captured. Note that *seed* is rolled forward every time a new iDVs is generated. Only *key* stays as the original secret, but short of having as well the initial *seed* as sent at the end of the association procedure, the attacker will also not be able to synthesize any past iDVs since day one and so, cannot also decrypt past conversations, achieving PFS, as we sought.

As far as devices are concerned, when they are compromised, the current values of *seed*, *key* and *idvv* are captured. Note that *key* stays as the original secret, but *seed* is rolled forward every time a new iDVs is generated. So, the attacker will be unable to synthesize any past iDVs since day one and so, cannot decrypt past conversations, achieving PFS, as we desired.

#### D. Randomness

We empirically assessed the quality and confidence of the iDVs generator using two techniques. First, we generated more than 200 billion iDVs to verify if there was any repetition, i.e., the same iDVs generated more than once. There was no a single repeated iDVs. This indicates that our solution is (indeed) suitable for short term iDVs (e.g. one per message).

Second, pseudorandom generators should be always empirically tested [26]. Again, we used NIST’s test suite [27] to statistically assess the confidence of the iDVs generator. For the sake of our tests, we generated 1M iDVs of 64 bytes. The file, containing 1M iDVs, was used as input for the test suite. The streams of bits corresponding to the iDVs passed all tests, i.e., there was no single failure. This gives us a good level of confidence on the robustness of the iDVs generator.

We also used `ent` [28], which is a pseudorandom number sequence test program, to evaluate the serial correlation coefficient of our implementation. While non-random and predictable sequences of bytes have a serial correlation coefficient

of approximately 0.5 and 1.0, respectively, a random byte stream should have a coefficient near to zero. Our implementation, featuring SHA512, had a serial correlation coefficient of 0.0004. Alternative implementations, using MD5 and SHA1, presented the worst case coefficients, as high as 0.035. Typical pseudo-random functions or methods provided by a programming language, such as `rand()` from C and `SecureRandom` from Java, have a serial correlation of approximately 0.0148 and 0.0127, respectively. This shows us that SHA512 is indeed a strong candidate to securely generate iDVs.

## VI. DISCUSSION

### A. On the cost of the infrastructure

Our proposal compares well with traditional solutions such as EJBCA (<http://www.ejbca.org/>) and OpenSSL, two popular implementations of PKI and TLS, respectively.

The first interesting take away is that our solution has nearly one order of magnitude less LOC (85k) and uses four times less external libraries and only four programming languages. This makes a huge difference from a security and dependability perspective. For instance, to formally prove more than 717k LOC (OpenSSL + EJBCA) is by itself a tremendous challenge. And it gets considerably worse if we take into account eighty external libraries and eleven development languages. Moreover, it is worth emphasizing that libraries such as OpenSSL suffer from different fundamental issues such as too many legacy features accumulated over time, too many alternative modes as result of tradeoffs made in the standardization, and too much focus on the web and DNS names.

Second, OpenSSL is complex and highly configurable. This has been also the source of many security incidents, i.e., developers and users frequently use the library in an inappropriate way [29], [30]. It has also been shown that the majority of the security incidents are still caused by errors and misconfiguration of systems [31], [32]. Lastly, recent research has uncovered new vulnerabilities on TLS implementations [33].

In contrast, our proposed architecture exhibits gains in both performance and robustness, contributing to solving the dilemma we enunciated in the introduction. By having less LOC, we significantly reduce the threat surface – by one order of magnitude – and by combining NaCl and the iDVs mechanism, we provide a potentially equivalent level of security, but quite increased performance/robustness product, as keys can be rolled even on a per message basis.

### B. Size and complexity matter

The more complex the system, the higher the probability of having vulnerabilities and hence a broader attack surface. Nowadays, this is still one of the major problems faced by the technology industry. Specialized security reports have recurrently highlighted the complexity and size of systems as one of the most important security challenges [34]. The time for re-thinking the security of communication channels may have come, and that is also the position we take in this paper.

Renowned cryptographers and security experts have been claiming that simplicity is one of the keys in securing computer

systems [13], [35], [36]. In fact, the trusted computing community has been advocating simple interfaces and concerned with the size and complexity of components for a long time [37], [38].

These positions have in essence been echoed in our KISS work (starting with the name metaphor, *keep it simple, stupid*). We methodically selected high performance MAC and hashing primitives for KISS – Poly1305 and SHA512 OpenSSL – and actually showed the penalty to be paid by less attentive choices. We also turned to lightweight but comparatively secure cryptographic libraries for secure channel support, like NaCl. NaCl was complemented in our architecture with the iDVV mechanism, to generate secrets to be used for example by NaCl ciphers, again in a fast, very simple and decentralized way.

### C. On the cost of iDVV

Similarly to iCVVs, iDVs are a low overhead solution that requires minimal resources. This solution is thus feasible to be integrated into compute-constrained devices as commodity switches. Our preliminary evaluation has revealed that the iDVV mechanism is faster than traditional solutions, namely, the key-exchange algorithms embedded in the OpenSSL implementation. Considering a setup with 128 switching devices, sending `PACKET_IN` messages to and receiving `FLOW_MOD` messages from the controller our results shows our proposed solution (iDVV + NaCl's ciphers) to be more than 30% faster than an OpenSSL-based implementation using AES256-SHA (the most common high performance cipher suite, used by IT companies such as Google, Facebook, Microsoft, and Amazon). Importantly, we were able to outperform OpenSSL-based deployments while still providing the same security properties: authenticity, integrity, and confidentiality. In addition, we achieved this result not only while offering the same properties, but also with stronger security guarantees: the tests were made by generating one iDVV *per packet*, while the OpenSSL-based implementation uses a single key (for symmetric ciphering) for the entire communication session.

## VII. RELATED WORK

There are several feasible attacks against the SDN control plane [39], [40]. Most of them explore vulnerabilities such as the lack of authentication, authorization and other essential security properties. However, almost no attention has been paid to the security requirements of control plane associations and communication between devices. For instance, only recently, the use of secrecy through obscurity has been proposed to protect SDN controllers from DoS attacks [41]. In this case, the switch authentication ID is hidden in a specific field in the IP protocol. It is assumed that the devices share a look-up table and unique IDs. However, in spite of being capable of mitigating DoS attacks, this technique does not address the security issues of control plane communications.

## VIII. CONCLUDING REMARKS

In this paper, we set out to explore and confirm our intuition for the possible reasons behind a slower than expected adoption of security mechanisms in SDN, and based on those findings,

we proposed KISS, a modular secure SDN control plane communications architecture.

We started by investigating the impact of essential cryptographic primitives and TLS implementations on the control plane performance. We showed that whilst even the most basic security primitives add a non-negligible degradation of performance, a judicious choice of these primitives and their specific implementations can mitigate the penalty significantly. This is particularly important for the typical SDN scenario that resorts to commodity hardware, sometimes with modest computing capabilities.

The second problem we explored in this paper was the complexity of the centralized support infrastructure for authentication and key distribution. We proposed iDVV, a simple and robust decentralized mechanism for generating and verifying the secrets necessary for secure communications between network devices. As future work, we are also investigating the reduction of single-point-of-failure syndromes: architectures for SDN KDCs resilient to accidental and malicious faults, drawing from fault and intrusion tolerance techniques.

Our results are encouraging in terms of an increase of performance — 30% improvement over OpenSSL — and robustness — an order of magnitude reduction in the number of LOC, and implied cyclomatic complexity. This also means that formal verification is more tractable, which is one of our future goals for iDVV, for instance.

We believe that this is one first step towards lightweight but effective security for control plane communication, and potentially for SDN in general. We make a “call to arms” to foster developments on securing SDN communications without impairing performance, a fundamental pre-condition for widespread adoption by future SDN deployments.

## ACKNOWLEDGMENT

We would like to thank the anonymous reviewers of IEEE Security & Privacy and Christian Esteve Rothenberg and Marcus Völp for the insightful comments. It is worth mentioning that a short version of this report has been accepted for publication in IEEE Security & Privacy.

This work is partially supported by the Fonds National de la Recherche Luxembourg (FNR) through PEARL grant FNR/P14/8149128, by European Commission funds through the H2020 programme, namely by funding of the SUPER-CLOUD project, ref. H2020-643964, and by Portuguese national funds through Fundação para a Ciência e a Tecnologia (FCT), namely by funding of LaSIGE Research Unit, ref. UID/CEC/00408/2013.

## REFERENCES

- [1] T. Dierks and E. Rescorla, “The Transport Layer Security (TLS) Protocol Version 1.2,” RFC 5246 (Proposed Standard), IETF, Aug. 2008, updated by RFCs 5746, 5878, 6176.
- [2] D. Kreutz, F. Ramos, P. Esteves Verissimo, C. Esteve Rothenberg, S. Azodolmolky, and S. Uhlig, “Software-defined networking: A comprehensive survey,” *Proceedings of the IEEE*, vol. 103, no. 1, Jan 2015.

- [3] M. Antikainen, T. Aura, and M. Särelä, “Spook in your network: Attacking an SDN with a compromised openflow switch,” in *Secure IT Systems*, ser. Lecture Notes in Computer Science, K. Bernsmed and S. Fischer-Hübner, Eds. Springer International Publishing, 2014, pp. 229–244. [Online]. Available: [http://dx.doi.org/10.1007/978-3-319-11599-3\\_14](http://dx.doi.org/10.1007/978-3-319-11599-3_14)
- [4] D. Naylor, A. Finamore, I. Leontiadis, Y. Grunenberger, M. Mellia, M. Munafo, K. Papagiannaki, , and P. Steenkiste, “The cost of the “S” in HTTPS,” in *Proceedings of the Tenth ACM Conference on Emerging Networking Experiments and Technologies*, ser. CoNEXT ’14. New York, NY, USA: ACM, 2014, p. 7. [Online]. Available: <http://doi.acm.org/10.1145/2535372.2535416>
- [5] C. Shen, E. Nahum, H. Schulzrinne, and C. P. Wright, “The impact of TLS on SIP server performance: Measurement and modeling,” *IEEE/ACM Trans. on Networking*, vol. 20, no. 4, Aug 2012.
- [6] J. Schonwalder and V. Marinov, “On the impact of security protocols on the performance of SNMP,” *IEEE Trans. on Net. and Service Management*, vol. 8, no. 1, 2011.
- [7] Hewlett-Packard Development Company, L.P., “HP 3800 switch series,” 2015. [Online]. Available: <http://h17007.www1.hp.com/docs/products/4aa3-7115enw.pdf>
- [8] Advantech Co., Ltd., “Freescale introduces a new breed of intelligent switching for the SDN era,” 2015. [Online]. Available: <http://www.advantech.com>
- [9] NEXCOM International Co., Ltd., “NSA 5640,” 2015. [Online]. Available: <http://www.nexcom.com/>
- [10] A. Wazan, R. Laborde, F. Barrere, A. Benzekri, and D. Chadwick, “PKI interoperability: Still an issue? a solution in the x.509 realm,” in *Info. Assurance and Sec. Education and Training*. Springer, 2013, vol. 406.
- [11] J. Yu and M. Ryan, “Evaluating web PKIs,” in *Software Architecture for Big Data and the Cloud*, 1st ed., I. Mistrik, R. Bahsoon, N. Ali, M. Heisel, and B. Maxim, Eds. Elsevier, June 2017, ch. 7.
- [12] N. van der Meulen, “DigiNotar: Dissecting the first dutch digital disaster,” *Journal of Strategic Security*, vol. 6, no. 2, 2013.
- [13] D. Bernstein, T. Lange, and P. Schwabe, “The security impact of a new cryptographic library,” in *Progress in Cryptology - LATINCRYPT*, ser. L. N. in CS. Springer, 2012, vol. 7533.
- [14] B. C. Neuman and T. Ts’o, “Kerberos: An authentication service for computer networks,” *IEEE Communications magazine*, vol. 32, no. 9, pp. 33–38, 1994.
- [15] P. Verissimo, M. Correia, N. F. Neves, and P. Sousa, “Intrusion-resilient middleware design and validation,” in *Information Assurance, Security and Privacy Services*, ser. Handbooks in Information Systems. Emerald Group Publishing Limited, May 2009, vol. 4, pp. 615–678. [Online]. Available: <http://www.navigators.di.fc.ul.pt/archive/papers/annals-IntTol-compacto.pdf>
- [16] J. Callas, L. Donnerhacke, H. Finney, D. Shaw, and R. Thayer, “OpenPGP Message Format,” RFC 4880 (Proposed Standard), RFC Editor, Fremont, CA, USA, pp. 1–90, Nov. 2007.
- [17] H. Handschuh and B. Preneel, “Key-recovery attacks on universal hash function based mac algorithms,” in *Advances in Cryptology - CRYPTO*, ser. L. N. in CS, D. Wagner, Ed. Springer, 2008, vol. 5157.
- [18] O. Benoit and T. Peyrin, “Side-channel analysis of six sha-3 candidates,” in *Cryptographic Hardware and Embedded Systems, CHES 2010*, ser. L. N. in CS. Springer, 2010, vol. 6225, pp. 140–157.
- [19] J. Kim, A. Biryukov, B. Preneel, and S. Hong, “On the security of HMAC and NMAC based on HAVAL, MD4, MD5, SHA-0 and SHA-1 (extended abstract),” in *Security and Cryptography for Networks*, ser. L. N. in CS. Springer, 2006, vol. 4116.
- [20] T. Benson, A. Akella, and D. A. Maltz, “Network traffic characteristics of data centers in the wild,” in *Proceedings of the 10th ACM SIGCOMM Conference on Internet Measurement*, ser. IMC ’10. New York, NY, USA: ACM, 2010, pp. 267–280. [Online]. Available: <http://doi.acm.org/10.1145/1879141.1879175>
- [21] ONF, “Openflow switch specification (version 1.4.0),” October 2013. [Online]. Available: <http://goo.gl/1DYxw6>
- [22] D. Bernstein, B. van Gastel, W. Janssen, T. Lange, P. Schwabe, and S. Smetsers, “TweetNaCl: A crypto library in 100 tweets,” in *Progress in Cryptology - LATINCRYPT 2014*, ser. Lecture Notes in Computer Science, D. F. Aranha and A. Menezes, Eds. Springer International Publishing, 2015, vol. 8895, pp. 64–83. [Online]. Available: [http://dx.doi.org/10.1007/978-3-319-16295-9\\_4](http://dx.doi.org/10.1007/978-3-319-16295-9_4)
- [23] J. B. Almeida, M. Barbosa, J. S. Pinto, and B. Vieira, “Formal verification of side-channel countermeasures using self-composition,” *Science of Computer Programming*, vol. 78, no. 7, pp. 796 – 812, 2013, special section on Formal Methods for Industrial Critical Systems (FMICS 2009 + FMICS 2010) & Special section on Object-Oriented Programming and Systems (OOPS 2009), a special track at the 24th ACM Symposium on Applied Computing. [Online]. Available: <http://www.sciencedirect.com/science/article/pii/S0167642311001857>
- [24] W. M. Petullo, X. Zhang, J. A. Solworth, D. J. Bernstein, and T. Lange, “MinimalT: Minimal-latency networking through better security,” in *Proceedings of the 2013 ACM SIGSAC Conference on Computer & Communications Security*, ser. CCS ’13. New York, NY, USA: ACM, 2013, pp. 425–438. [Online]. Available: <http://doi.acm.org/10.1145/2508859.2516737>
- [25] N. Mavrogiannopoulos, “The price to pay for perfect-forward secrecy,” Dec. 2011. [Online]. Available: <http://nmav.gnutls.org/2011/12/price-to-pay-for-perfect-forward.html>
- [26] L. E. Bassham, III, A. L. Rukhin, J. Soto, J. R. Nechvatal, M. E. Smid, E. B. Barker, S. D. Leigh, M. Levenson, M. Vangel, D. L. Banks, N. A. Heckert, J. F. Dray, and S. Vo, “Sp 800-22 rev. 1a. a statistical test suite for random and pseudorandom number generators for cryptographic applications,” Gaithersburg, MD, United States, Tech. Rep., 2010.
- [27] NIST, “NIST statistical test suite,” 2017. [Online]. Available: [http://csrc.nist.gov/groups/ST/toolkit/rng/documentation\\_software.html](http://csrc.nist.gov/groups/ST/toolkit/rng/documentation_software.html)
- [28] J. Walker, “ent - a pseudorandom number sequence test program,” 2008. [Online]. Available: <http://www.fourmilab.ch/random/>
- [29] M. Egele, D. Brumley, Y. Fratantonio, and C. Kruegel, “An empirical study of cryptographic misuse in Android applications,” in *Proceedings of the 2013 ACM SIGSAC Conference on Computer & Communications Security*, ser. CCS ’13. New York, NY, USA: ACM, 2013, pp. 73–84. [Online]. Available: <http://doi.acm.org/10.1145/2508859.2516693>
- [30] S. Fahl, M. Harbach, T. Muders, L. Baumgärtner, B. Freisleben, and M. Smith, “Why eve and mallory love Android: an analysis of Android SSL (in)security,” in *Proceedings of the 2012 ACM conference on Computer and communications security*, ser. CCS ’12. New York, NY, USA: ACM, 2012, pp. 50–61. [Online]. Available: <http://doi.acm.org/10.1145/2382196.2382205>
- [31] Verizon, “2015 data breach investigations report,” Verizon, Tech. Rep., 2015. [Online]. Available: <http://www.verizonenterprise.com/DBIR/2015/>
- [32] J. Zhang, Z. Durumeric, M. Bailey, M. Liu, and M. Karir, “On the mismanagement and maliciousness of networks,” in *Symposium on Network and Distributed System Security (NDSS)*, 2014.
- [33] B. Beurdouche, K. Bhargavan, A. Delignat-Lavaud, C. Fournet, M. Kohlweiss, A. Pironti, P.-Y. Strub, and J. K. Zinzindohoue, “A messy state of the union: Taming the composite state machines of TLS,” in *2015 IEEE Symposium on Security and Privacy*. IEEE, 2015, pp. 535–552.
- [34] Cisco, “Annual security report,” 2014. [Online]. Available: [https://www.cisco.com/web/offer/gist\\_ty2\\_asset/Cisco\\_2014\\_ASR.pdf](https://www.cisco.com/web/offer/gist_ty2_asset/Cisco_2014_ASR.pdf)
- [35] Stanford University, “Stanford cybersecurity expert: Dan Boneh,” 2015. [Online]. Available: <https://www.youtube.com/watch?v=H-YGdeNFBjk>
- [36] B. Preneel, “System security after Snowden,” 2015. [Online]. Available: <http://2015.dsn.org/keynote-speakers/>
- [37] G. Heiser, T. Murray, and G. Klein, “It’s time for trustworthy systems,” *IEEE Security & Privacy*, vol. 10, no. 2, pp. 67–70, 2012.
- [38] H. Raj, D. Robinson, T. B. Tariq, P. England, S. Saroiu, and A. Wolman, “Credo: Trusted computing for guest vms with a commodity hypervisor,” Microsoft Research, Tech. Rep. MSR-TR-2011-130, December 2011. [Online]. Available: <http://research.microsoft.com/apps/pubs/default.aspx?id=157213>
- [39] S. Scott-Hayward, S. Natarajan, and S. Sezer, “A survey of security in software defined networks,” *IEEE Communications Surveys Tutorials*, vol. 18, no. 1, pp. 623–654, Firstquarter 2016.
- [40] D. Kreutz, F. M. Ramos, and P. Verissimo, “Towards secure and dependable software-defined networks,” in *Proceedings of the Second ACM SIGCOMM Workshop on Hot Topics in Software Defined*

*Networking*, ser. HotSDN '13. New York, NY, USA: ACM, 2013, pp. 55–60. [Online]. Available: <http://doi.acm.org/10.1145/2491185.2491199>

- [41] O. I. Abdullaziz, Y. J. Chen, and L. C. Wang, "Lightweight authentication mechanism for software defined network using information hiding," in *2016 IEEE Global Communications Conference (GLOBECOM)*, Dec 2016, pp. 1–6.